



**TC710/22**

**AUTOMATIC TYRE CHANGERS**



# TC710/22

Pneumatic rear tilting post granting the maximum rigidity



41 mm hexagonal vertical arm to reduce flexures in case of Run-flat tyres



50x50 mm horizontal arm

Jaws with external grip













Turntable with locking capacity up to 25"

Bead breaker with ergonomic arm to operate on wheels of 12" in width

Four pedals aligned in the front.  
Removable pedal unit

Single speed (7 rpm)

## TECHNICAL DATA

											
								Standard			
								400V/3/50-60 Hz	7 rpm	0,55	
								On request			
								400V/3/50-60 Hz	7 / 14 rpm	0,8 - 1,1	8 - 12 bar
								230V/3/50-60 Hz	7 / 14 rpm	0,8 - 1,1	
								230V/3/50-60 Hz	7 rpm	0,55	
								230V/1/50-60 Hz	7 rpm	1,1	
								110V/1/60 Hz	7 rpm	0,75	
250	12" - 25"	10" ÷ 22"	12"	39" 1000 mm	All tyres	1.500 kg					

# VERSIONS ON REQUEST



## PG Version

Pedal-operated inflating version with manometer and CE-certified inflation pressure limiter (standard on IT version).



## IT Version

With inflation device for bead seating integrated in clamping jaws.

- UK** **41 mm hexagonal vertical arm** with device to minimize tolerances and **50x50 mm horizontal arm** to reduce flexures in case of Run-flat tyres. Simultaneous vertical and horizontal arm locking system, vertical arm with spring return.  
**Pneumatic rear tilting post** granting the maximum rigidity.  
**Square turntable** with locking capacity up to 25". It is equipped with a **system with opposing jaws** and with two cylinders of  $\varnothing$  80 mm, guarantees an optimal clamping force on all types of rims.  
**Professional tyre inflating gun** with manometer. For a tyre pressure up to max 10 bar.  
**Bead breaker** with ergonomic arm to operate on wheels of 12" in width.  
**Removable pedal unit** for easy maintenance. Four pedals aligned in the front.
- IT** **Braccio verticale esagonale** di 41 mm con sistema recupero giochi e braccio orizzontale 50x50 mm riducono le flessioni in caso di ruote Run-flat. Sistema di bloccaggio simultaneo di braccio verticale e orizzontale con ritorno a molla dell'asta.  
**Palo ribaltabile pneumaticamente** che garantisce la massima rigidità.  
**Piatto autocentrante** quadrato con capacità di bloccaggio fino a 25". Dotato di piatto con **sistema a griffe contrapposte** e due cilindri da 80 mm di diametro che garantisce una forza di serraggio ottimale su tutti i tipi di cerchi.  
**Pistola professionale di gonfiaggio** con manometro. Per una pressione di gonfiaggio fino a max 10 bar.  
**Stallonatore** ergonomico che permette di operare su ruote fino a 12" di larghezza.  
**Pedaliera estraibile** per facilitare le operazioni di manutenzione. Quattro pedali in linea.
- FR** **Bras vertical hexagonal** de 41 mm avec système de récupération de jeu et bras horizontal 50x50 mm réduisent les flexions dans le cas de roues Run-flat. Système de verrouillage simultané du bras vertical et horizontal avec rappel par ressort de la tige.  
**Piquet escamotable en arrière** qui garantit une rigidité maximale.  
**Plateau auto-centrant carré** avec capacité de serrage jusqu'à 25". Le modèle est équipé d'un plateau avec **système de mors opposés** et de deux cylindres de 80 mm de diamètre qui garantissent une force de serrage optimale sur tous les types de jantes.  
**Pistolet de gonflage** professionnel avec manomètre. Pression de travail jusqu'à 10 bar.  
**Détalonneur** ergonomique qui permet de travailler sur des roues jusqu'à 12" de large.  
**Pédalier extractible** pour faciliter les opérations d'entretien. Quatre pédales en ligne.
- DE** 41-mm-**Sechskant-Vertikalarm** mit Spielwiederherstellungssystem und 50x50-mm-Horizontalarm zur Gewährleistung der Steifigkeit mit Run-flat Reifen. Gleichzeitiges Verriegelungssystem des vertikalen und horizontalen Arms mit Federrückstellung.  
**Pneumatisch kippbar**, maximale Steifigkeit zu garantieren.  
**Selbstzentrierend viereckig Spannteller** mit Spannbereich bis zu 25 Zoll. Das Modell ist mit einer Spannteller mit **Gegenbackensystem** und zwei Zylindern mit 80 mm Durchmesser ausgestattet, die eine optimale Spannkraft bei allen Felgentypen garantieren.  
**Professionelle Reifenfüllpistole** mit Druckmesser Für Reifenfülldrücke bis max. 10 bar.  
Ergonomischer **Reifenabdrücker** für die Bearbeitung von Rädern mit einer Reifenbreite von bis zu 12".  
**Abnehmbare Pedaleinheit** zur Erleichterung von Wartungsarbeiten. Vier Pedale vorne.
- ES** **Brazo vertical hexagonal** de 41 mm con sistema de recuperación de juegos y brazo horizontal 50x50 mm reduce las flexiones en el caso de ruedas Run-flat. Sistema de bloqueo simultáneo de barra vertical y brazo horizontal con retorno de resorte de la barra.  
**Palo provisto de abatimiento trasero** que garantiza la máxima rigidez.  
**Plato autocentrante** cuadrado con capacidad de amarre hasta 25". El modelo está equipado con un plato con **sistema de mordazas opuestas** y dos cilindros de 80 mm de diámetro que garantizan una fuerza de sujeción óptima en todo tipo de llantas.  
**Pistola de inflado profesional** con manómetro. Para una presión de inflado hasta máx. 10 bar.  
**Destalonador** ergonómico que permite actuar en ruedas cuya anchura sea de máx. 12".  
**Pedalera extraíble** para facilitar las operaciones de mantenimiento. Cuatro pedales en línea.

# STANDARD CONFIGURATION



Front head protection



Lever



Inflating gun  
(only for base version)

## OPTIONAL ACCESSORIES

Tecnofit	Kit IT Tubeless	Mounting clamp RFT/UHP	Rear head protection	Front head protection	Slide guard kit (4 pcs)
Rim breaker blade protection	Lever plastic protection	Plastic M/D tool	Quick change M/D tool	Motorcycles Kit (4 pcs)	Scooter Kit (4 pcs)



Roller board

## OVERALL DIMENSIONS

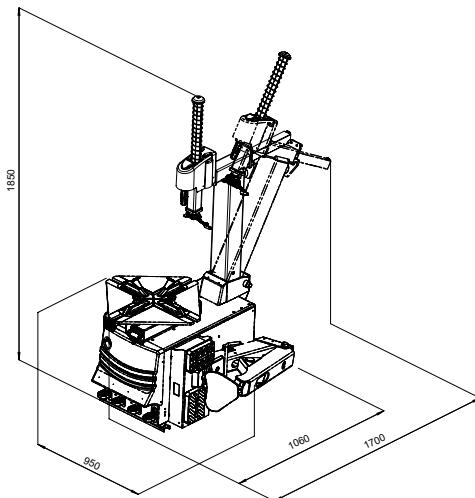

**TC710/22**  
equipped with **Tecnofit**



M&B ENGINEERING SRL  
Via Nobel, 21 - 42124 Reggio Emilia (RE)  
info@mb-re.it - www.mbenengineering.info