

**SUPEROFFERTA**  
2023



**Nuova chiave 285 X**

**Il dado  
è tratto.**



**Anche spanato.**

**€ Senza IVA 63/2023**  
Valida fino al 31/01/2024

<b>0</b>			280 LTS/S9	Pag. 37	451 N/S4	Pag. 56	519/276	Pag. 22	519 RS6/4MM	Pag. 7	889 TS	Pag. 67		
001 RV	Pag. 29	280 LTSTX/S8	Pag. 37	454	Pag. 56	519/280HG	Pag. 22	519 RS6/4NMM	Pag. 7	889 UB	Pag. 67			
001 TRV	Pag. 29	280 TK/SE6	Pag. 34	458 E/B9	Pag. 56	519/280HGTS	Pag. 22	519 RS6/4NV	Pag. 5	890 K	Pag. 69			
002 JMA	Pag. 24	<b>280 TQ</b>	<b>Pag. 33</b>	458 S20	Pag. 56	519/280T	Pag. 22	519 RS6/4V	Pag. 5	<b>900</b>				
002 JTMA	Pag. 24	280 T/SE7	Pag. 34	468 M	Pag. 73	519/285A1	Pag. 22	519 RS7/3V	Pag. 4	910 E1 1"	Pag. 79			
002 UDE	Pag. 25	280 TTS/SE6	Pag. 34	495 MAA	Pag. 20	519/285B2	Pag. 22	519 RS7/5V	Pag. 5	913 PC2 1/2"	Pag. 80			
002 UDM	Pag. 25	280 TTX/SE8	Pag. 34	495 MB	Pag. 20	519/285KA1	Pag. 22	519 RS8/3V	Pag. 4	920 AN1	Pag. 80			
007/1V	Pag. 26	280 XLTS/S9	Pag. 37	495 MC	Pag. 20	519/294	Pag. 22	<b>519 RSANV</b>	<b>Pag. 5</b>	921 A4	Pag. 80			
<b>007 FLV</b>	<b>Pag. 27</b>	282 S10	Pag. 62	495 PA	Pag. 21	519/322H	Pag. 22	<b>519 RSAV</b>	<b>Pag. 5</b>	921 B1	Pag. 81			
<b>007 MCV</b>	<b>Pag. 27</b>	285 DS8	Pag. 43	495 PM	Pag. 21	519/322STX	Pag. 22	<b>600</b>		922 B1	Pag. 81			
007 MLV	Pag. 59	285 DS12	Pag. 43	<b>500</b>			519/324H	Pag. 22	601 1/2" J22	Pag. 50	922 B2	Pag. 81		
007 MV	Pag. 59	<b>285 J/DS7</b>	<b>Pag. 46</b>	516 AC1	Pag. 14	519/324TX	Pag. 22	601 1/4-1/2" J82	Pag. 51	601 1/4-1/2" J100	Pag. 51	922 BL1	Pag. 81	
007 PLV	Pag. 27	<b>285 J/DS12</b>	<b>Pag. 46</b>	516 AC2	Pag. 14	519/366	Pag. 22	601 1/4-1/2" JTX16	Pag. 50	601 1/4" J34	Pag. 50	922 BP1	Pag. 81	
007 RV	Pag. 28	285 KA/DS8	Pag. 44	516 AC3	Pag. 14	519/382F	Pag. 22	606 1/2" EA	Pag. 48	606 1/4" EA	Pag. 48	928 AC1 1/2"	Pag. 78	
007 SV	Pag. 28	285 KA/DS12	Pag. 44	516 AC4	Pag. 14	519/613AEA	Pag. 22	606 1/4" SK	Pag. 47	608 1/4" EAK	Pag. 49	928 D1 3/4"	Pag. 78	
007 TV	Pag. 28	<b>285 KB/DS7</b>	<b>Pag. 45</b>	516 AC5	Pag. 14	519/613BEA	Pag. 22	609 1/4" EB	Pag. 47	610 1/4" EFK	Pag. 47	929 PC1 1/2"	Pag. 76	
007 TVX	Pag. 26	<b>285 KB/DS12</b>	<b>Pag. 45</b>	516 AC6	Pag. 14	519/613CEA	Pag. 22	612 3/4" B	Pag. 49	612 3/4" EB	Pag. 49	929 PC1/C12	Pag. 77	
007 V	Pag. 26	285 KF/DS8	Pag. 45	516 AC7	Pag. 14	519/990A1	Pag. 22	640 A	Pag. 29	641 T	Pag. 29	939 C1	Pag. 80	
074 A	Pag. 59	285 KF/SE5	Pag. 45	516 AC8	Pag. 14	519 ACT1	Pag. 15	646/5LV	Pag. 29	664 B/S7	Pag. 36	942 PC3 1/2"	Pag. 76	
085 EX/SE3	Pag. 38	285 P/SE5	Pag. 43	516 AC9	Pag. 14	519 ACT2	Pag. 15	664 S25	Pag. 36	687 1/2" C16	Pag. 82	942 PC3/C7	Pag. 77	
091 D/SH5	Pag. 32	285 SE26	Pag. 43	516 AC10	Pag. 14	519 ACT3	Pag. 15	688 3/4" MD6	Pag. 82	692 J32	Pag. 36	942 PD1 3/4"	Pag. 78	
091 SH5	Pag. 32	<b>285 X/B8</b>	<b>Pag. 42</b>	516 SA/C1	Pag. 16	519 ACT4	Pag. 15	692 J49	Pag. 36	692 J100	Pag. 37	942 PE1 1"	Pag. 79	
091 SH8	Pag. 32	<b>285 X/SE12</b>	<b>Pag. 42</b>	516 SA/C2	Pag. 16	519 ACT5	Pag. 15	<b>800</b>		810 N	Pag. 54	942 PEL2 1"	Pag. 79	
<b>100</b>			294 AC	Pag. 41	516 SA/C3	Pag. 17	519 ACT6	Pag. 15	810 SA	Pag. 53	943 PC1 1/2"	Pag. 76		
115 CL/SE2	Pag. 74	294 AD	Pag. 41	516 SA/C4	Pag. 17	519 ACT7	Pag. 15	<b>811 LB</b>	<b>Pag. 52</b>	811 NE	Pag. 54	943 PC1/C12	Pag. 77	
127 C/SE4	Pag. 39	294 AG	Pag. 41	516 SA/CA1	Pag. 16	519 ACT8	Pag. 15	<b>811 LBE</b>	<b>Pag. 52</b>	519 ACT9	Pag. 15	943 PC2 1/2"	Pag. 78	
127 C/SE4S	Pag. 39	<b>300</b>			516 SA/CA2	Pag. 16	519 ACT10	Pag. 15	519 ACT11	Pag. 15	943 PC2/S3	Pag. 63		
127 N/SE4	Pag. 39	322 SH7	Pag. 32	516 SA/CA3	Pag. 17	519 ACT12	Pag. 15	519 ACT12	Pag. 15	519 ACT13	Pag. 15	988 D/S10	Pag. 63	
127 N/SE4S	Pag. 39	322 SH10	Pag. 32	516 SA/CA4	Pag. 17	519 ACT14	Pag. 15	519 ACT14	Pag. 15	519 M 091A	Pag. 23	988 G/S12	Pag. 63	
135 B	Pag. 40	324 SH5	Pag. 31	516 SPC1	Pag. 18	519 M 127N	Pag. 23	519 M 150AX	Pag. 23	519 M 276	Pag. 23	988 LA/S14	Pag. 63	
150 AX/SE3	Pag. 38	324 SH8	Pag. 31	516 SPC2	Pag. 18	519 M 280HG	Pag. 23	519 M 280HGTS	Pag. 23	519 M 280N1	Pag. 23	988 MA/S19	Pag. 63	
155 AX	Pag. 38	324 SH12	Pag. 31	516 SPCN1	Pag. 18	519 M 285A1	Pag. 23	519 M 280N1	Pag. 23	<b>519 M 280T</b>	<b>Pag. 23</b>	988 MA/S25	Pag. 63	
163	Pag. 59	324 STX/S7	Pag. 31	516 SPCN2	Pag. 18	519 M 285A2	Pag. 23	<b>519 M 280T</b>	<b>Pag. 23</b>	519 M 285A1	Pag. 23	995 A	Pag. 62	
174 CX	Pag. 40	324 XP/B16	Pag. 30	516 ST5V	Pag. 8	519 M 285KA	Pag. 23	519 M 280N1	Pag. 23	519 M 285A2	Pag. 23	995 AF	Pag. 57	
186 C	Pag. 40	333 K/SB10	Pag. 33	516 ST6MA	Pag. 11	<b>519 M 285KB</b>	<b>Pag. 23</b>	519 M 280N1	Pag. 23	519 M 294B	Pag. 23	995 CA	Pag. 57	
<b>200</b>			333 K/SH8	Pag. 33	516 ST6MM	Pag. 11	519 M 294B	Pag. 23	519 M 324H	Pag. 23	519 M 324STX	Pag. 23	995 LA	Pag. 57
200 S	Pag. 60	367 SE6	Pag. 61	516 ST6NMA	Pag. 11	519 M 324H	Pag. 23	519 M 382F	Pag. 23	519 M 382F	Pag. 23	997 A	Pag. 62	
207 D	Pag. 58	376	Pag. 61	516 ST6NMM	Pag. 11	519 M 613AEA	Pag. 23	519 M 613BEA	Pag. 23	519 M 613CEA	Pag. 23	997 B	Pag. 62	
207 E	Pag. 58	382	Pag. 61	516 ST6NPA	Pag. 10	519 M 990A5MD	Pag. 23	519 M 990A5MD	Pag. 23	519 RBO7/3V	Pag. 5	<b>1000</b>		
210 C	Pag. 60	382 F	Pag. 61	516 ST6NPM	Pag. 10	519 RBU6/3V	Pag. 5	519 RBU6/3V	Pag. 5	519 RS6/3MA	Pag. 6	1613 AGM12-24	Pag. 68	
211 A	Pag. 60	382 F	Pag. 61	516 ST6NPP	Pag. 10	519 RS6/3MM	Pag. 6	519 RS6/3MM	Pag. 6	519 RS6/3NMA	Pag. 6	1613 RA12	Pag. 68	
211 B	Pag. 60	391	Pag. 74	516 ST6NUD-796	Pag. 13	519 RS6/3NMM	Pag. 6	519 RS6/3NMM	Pag. 6	519 RS6/3NV	Pag. 4	1651	Pag. 69	
218 N	Pag. 60	<b>400</b>			516 ST6NUD-894	Pag. 13	<b>889 GR</b>	<b>Pag. 65</b>	<b>889 IL</b>	<b>Pag. 64</b>	889 LTE	Pag. 66	1785 B	Pag. 69
235 1/2" MB/C10	Pag. 83	400 P	Pag. 74	516 ST6NV	Pag. 8	519 RBO7/3V	Pag. 5	<b>889 RL</b>	<b>Pag. 64</b>	<b>889 RL</b>	<b>Pag. 64</b>	1881 S22	Pag. 71	
235 1/2" M/C16	Pag. 82	<b>421 M</b>	<b>Pag. 69</b>	516 ST6PA	Pag. 10	519 RBU6/3V	Pag. 5	889 RP	Pag. 66	889 RT	Pag. 65	1950 C	Pag. 70	
235 3/4" M/C8	Pag. 82	<b>421 P</b>	<b>Pag. 69</b>	516 ST6PM	Pag. 10	519 RS6/3MA	Pag. 6	889 RT	Pag. 65	889 TL	Pag. 67	<b>2000</b>		
236 K	Pag. 83	426 B/S5	Pag. 74	516 ST6PMM	Pag. 12	519 RS6/3MMA	Pag. 6	889 TL	Pag. 67	889 TM	Pag. 67	2000 A	Pag. 71	
236 KE	Pag. 83	426 C/S4	Pag. 74	516 ST6UD-796	Pag. 13	519 RS6/3NMA	Pag. 6	889 TR	Pag. 67	<b>2000 G</b>	<b>Pag. 71</b>	2550 A	Pag. 70	
236 KE/C22	Pag. 83	426 D/S4	Pag. 74	516 ST6UD-894	Pag. 13	519 RS6/3NV	Pag. 4	<b>889 TRE</b>	<b>Pag. 66</b>	2550 B	Pag. 70	2847/3	Pag. 68	
237 1/2" AK	Pag. 49	426 N	Pag. 72	516 ST6V	Pag. 8	<b>516 ST8V</b>		<b>Pag. 9</b>	2847 A	<b>Pag. 69</b>	<b>5000</b>			
237 1/4" AK	Pag. 49	426 D/S4	Pag. 74	516 ST7NV	Pag. 8	516 STC4V	Pag. 9	5006 EF2	Pag. 19	5006 EF6	Pag. 19			
252 N/SR8	Pag. 46	443 N	Pag. 72	516 ST7V	Pag. 8	516 STS6NV	Pag. 9							
263/S16	Pag. 73	443 NC	Pag. 72	516 STX L6MM	Pag. 12	516 STX L6NM	Pag. 12							
270 C/C3	Pag. 71	445 B	Pag. 75	516 STX L6NMM	Pag. 12	516 STX L6NV	Pag. 9							
272 DS	Pag. 70	446 DA/SE6	Pag. 72	516 STX L6V	Pag. 9	516 SU2V	Pag. 9							
276 CE/SE8	Pag. 46	446 DT/S2	Pag. 73	516 SU2V	Pag. 9	516 SUXLV	Pag. 9							
280 HAP/SE6	Pag. 35	446 RT	Pag. 75	519/127N	Pag. 22	519/150AX	Pag. 22							
280 HATX/SE6	Pag. 35	446 S28	Pag. 72											
280 HG/SE6	Pag. 35	447 T	Pag. 68											
280 HGTS/SE6	Pag. 35	449 IDA	Pag. 75											
		449 TA	Pag. 75											
		449 TB	Pag. 75											
		449 TC	Pag. 75											

# SCOPRI LE NOVITÀ 2023



Inserti e chiavi maschio  
Pagina 33



Chiavi di manovra  
Pagina 41



Serraggio controllato  
Pagina 52



Illuminazione  
Pagina 64



Carrelli portautensili  
Pagina 4



Arredamento da officina  
Pagina 16



Allestimenti per furgoni  
Pagina 19



Assortimenti  
Pagina 20



Valigie manutenzione  
Pagina 24



Contenitori trasportabili  
Pagina 26



Giraviti  
Pagina 30



Pinze  
Pagina 38



Cricchetti e bussole  
Pagina 47



Estrattori  
Pagina 56



Rivettatrici  
Pagina 57



Forbici per elettricisti  
Pagina 58



Elettrotecnica  
Pagina 59



Manutenzione  
Pagina 60



Autoriparazione  
Pagina 68



Pneumatica e accessori  
Pagina 76



CERCA GLI  
**ICONIC PRODUCT:**  
i prodotti che fanno la differenza!





## CARRELLO 519 RACING LA TUA POSTAZIONE DI LAVORO AL TOP.



**DUE RUOTE  
CON FRENO**

Piano di lavoro ampio  
con doppia maniglia

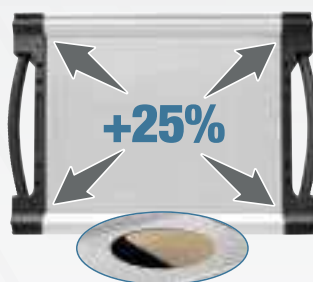

Doppio strato  
Sopra: lastra in alluminio da 2 mm.  
Sotto: piano in legno da 15 mm.



Paraurti in gomma su  
telaio e cassetti.



Maniglie ergonomiche  
basculanti in alluminio



### Risparmia il tuo tempo

Tutti i carrelli a cassetta USAG sono subito pronti all'uso, perchè forniti con le ruote già montate alla struttura.



900 kg

**8**  
CASSETTI  
**3**  
MODULI

79 kg | 814 mm | 1005 mm | 575 mm



900 kg

**7**  
CASSETTI  
**3**  
MODULI

77 kg | 814 mm | 1005 mm | 575 mm



900 kg

**6**  
CASSETTI

**3**  
MODULI

75 kg | 814 mm | 1005 mm | 575 mm

### 519 RS6/3V

U05190506

RAL 3020

**Carrello RACING (vuoto)**

### 519 RS8/3V

U05190508

RAL 3020

**Carrello RACING (vuoto)**

- Dimensioni interne:
  - 6 cassetti 570x420x60 mm.
  - 2 cassetti 570x420x130 mm.

€ 1.366,00

**€ 956,00**

### 519 RS7/3V

U05190507

RAL 3020

**Carrello RACING (vuoto)**

- Dimensioni interne:
  - 5 cassetti 570x420x60 mm.
  - 1 cassetto 570x420x130 mm.
  - 1 cassetto 570x420x200 mm.

€ 1.257,00

**€ 880,00**

### 519 RS6/3NV

U05190516

RAL 9005

**Carrello RACING (vuoto)**

- Dimensioni interne:
  - 4 cassetti 570x420x60 mm.
  - 1 cassetto 570x420x130 mm.
  - 1 cassetto 570x420x270 mm.

€ 1.145,00

**€ 802,00**





89 kg | 1004 mm | 1005 mm | 575 mm

**519 RS6/4V**

U05190546

RAL 3020

**Carrello RACING (vuoto)**

**519 RS6/4NV**

U05190566

RAL 9005

**Carrello RACING (vuoto)**

- Dimensioni interne:
  - 4 cassetti 760x420x60 mm.
  - 1 cassetto 760x420x130 mm.
  - 1 cassetto 760x420x270 mm.

~~€ 1.334,00~~

**€ 934,00**



106 kg | 1194 mm | 1035 mm | 575 mm

**519 RS7/5V**

U05190556

RAL 3020

**Carrello RACING (vuoto)**

- Dimensioni interne:
  - 5 cassetti 950x420x60 mm.
  - 1 cassetto 950x420x130 mm.
  - 1 cassetto 950x420x200 mm.

~~€ 1.747,00~~

**€ 1.223,00**



106 kg | 1194 mm | 1035 mm | 575 mm

**519 RB07/3V**

U05190097

RAL 3020

**Carrello RACING con anta laterale (vuoto)**

- Dimensioni interne:
  - 5 cassetti 570x420x60 mm.
  - 1 cassetto 570x420x130 mm.
  - 1 cassetto 570x420x200 mm.
- Vano laterale: 380x400x720 mm.

~~€ 1.747,00~~

**€ 1.223,00**



128 kg | 1.212 mm | 1000 mm | 670 mm

6 CASSETTI

3 MODULI

**519 RBU6/3V**

U05190098

RAL 3020

RAL 9005

**Banco da lavoro mobile RACING (vuoto)**

- Dimensioni interne:
  - 3 cassetti 570x420x60 mm.
  - 2 cassetti 570x420x130 mm.
  - 1 cassetto 570x420x200 mm.
- Vano laterale: 380x524x704 mm.



~~€ 2.186,00~~

**€ 1.530,00**



2 CASSETTI

45 kg | 720 mm | 1.000 mm | 280 mm



**519 RSAV**

U05190400

RAL 3020

RAL 9005

**Armadio vuoto - 2 cassetti**

**519 RSANV**

U05190401

RAL 9005

**Armadio vuoto - 2 cassetti**

- Pannelli forati interni.
- Apertura a 180° delle ante.
- Cassetti ad estrazione totale.
- Guide telescopiche a sfera.
- Maniglia dei cassetti in alluminio anodizzato.

~~€ 878,00~~

**€ 615,00**





## NON TROVI IL TUO Configuralo su



**6**  
CASSETTI

**3**  
MODULI

**RISPARMI**  
**€ 300**

Rispetto all'acquisto di carrello ed assortimento separati.



**6**  
CASSETTI

**3**  
MODULI

**RISPARMI**  
**€ 300**

Rispetto all'acquisto di carrello ed assortimento separati.

**156**  
PEZZI

**519 RS6/3MM**  
U05190628

RAL  
3020



**519 RS6/3NMM**  
U05191628

RAL  
9005

**Carrello RACING con assortimento  
MANUTENZIONE - 4 cassetti**

€ 2.617,00 **€ 1.310,00**

**155**  
PEZZI

**519 RS6/3MA**  
U05190627

RAL  
3020



**519 RS6/3NMA**  
U05191627

RAL  
9005

**Carrello RACING con assortimento  
AUTORIPARAZIONE - 3 cassetti**

€ 2.601,00 **€ 1.310,00**

## ASSORTIMENTO MANUTENZIONE



519 M 613AEA 519 M 613CEA 519 M 285A1



519 M 127C 519 M 150AX 519 MSK6



519 M 324H 519 M 324STX 519 MSK6+  
692 J32



519 M 990A5B 519 M 382 519 MSK6



519 M 285A1 519 M 324H 519 M 324STX



519 M 613AEA 519 M 612CLA



519 M 276C



**CHIAVI A T SNODATE**  
8-10-13-17 mm

### DESCRIZIONE

DESCRIZIONE	ART	PZ
Bussole esagonali, cricchetto (237 A), accessori 1/4 ed inserti	519 M 613AEA	46
Bussole esagonali, cricchetto (237 A) ed accessori 1/2	519 M 613CEA	23
Chiavi combinate (6-7-8-9-10-11-12-13-14-15-16-17-18-19-22-24 mm)	519 M 285A1	17
Pinze per anelli elastici interni ed esterni 15÷25 e 19÷60	519 M 127C	6
Pinza universale, pinza regolabile, tronchese, pinza becchi lunghi e pinza grip	519 M 150AX	5
Giraviti per viti ad intaglio ed a croce PHILLIPS	519 M 324H	7
Giraviti per viti TORX	519 M 324STX	8
Lime a taglio mezzodolce	519 M 990A5B	5
Martello per meccanici, mazzuola, cacciaspine, scalpello e bulino	519 M 382F	7
Assortimento di inserti con cricchetto reversibile	692 J32	32

### DESCRIZIONE

DESCRIZIONE	ART	PZ
Bussole esagonali, cricchetto (237 A), accessori 1/4 ed inserti	519 M 613AEA	46
Bussole esagonali lunghe e corte, cricchetto (237 A) ed accessori 1/2	519 M 612CLA	35
Chiavi combinate (6-7-8-9-10-11-12-13-14-15-16-17-18-19-22-24 mm)	519 M 285A1	17
Giraviti per viti ad intaglio ed a croce PHILLIPS	519 M 324H	7
Giraviti per viti TORX	519 M 324STX	8
Pinze per anelli elastici, pinza universale, pinza becchi lunghi, chiavi snodate con bussola esagonale (8-10-13-17 mm), assortimento di inserti con cricchetto	519 M 276C	42

**Vuoi solo l'assortimento? Vai a pagina 20**



## ASSORTIMENTO IDEALE?

kitplanner.usag.it



**6**  
CASSETTI

**4**  
MODULI

**RISPARMI**  
**€ 400**

Rispetto all'acquisto di carrello ed assortimento separati.



**6**  
CASSETTI

**4**  
MODULI

**RISPARMI**  
**€ 400**

Rispetto all'acquisto di carrello ed assortimento separati.

**301**  
PEZZI

**519 RS6/4MM**  
**U05190632**

**RAL 3020**

**Carrello RACING con assortimento MANUTENZIONE - 4 cassette**

~~€ 3.918,00~~

**€ 1.953,00**



**301**  
PEZZI

**519 RS6/4NMM**  
**U05191632**

**RAL 9005**

**Carrello RACING con assortimento MANUTENZIONE - 4 cassette**

~~€ 3.918,00~~

**€ 1.953,00**



## ASSORTIMENTO MANUTENZIONE



519 M 612CLA

519 M 613BEA

519 M 613AEA

519 M 285KA

519 M 285A1

519 M 285A2

519 M 294B

519 M 324H

519 M 324STX

519 M 280HG

519 M 280N1

519 M 127C

519 M 150AX

519 M 382F

519 M 990A5MD

DESCRIZIONE	ART	PZ
Bussole esagonali, cricchetto (237 A), accessori 1/4 ed inserti	519 M 613AEA	46
Bussole esagonali, cricchetto (237 A) ed accessori 3/8	519 M 613BEA	20
Bussole esagonali lunghe e corte, cricchetto (237 A) ed accessori 1/2	519 M 612CLA	35
Chiavi combinate a cricchetto reversibili (8-9-10-12-13-14-15-16-17-18-19 mm)	519 M 285 KA	12
Chiavi combinate (6-7-8-9-10-12-13-14-15-16-17-18-19-22-24 mm)	519 M 285A1	17
Chiavi combinate (27-29-30-32-34 mm)	519 M 285A2	5
Chiave a rullino rapida e corta, pinza autobloccante e forbice	519 M 294B	4
Giraviti per viti ad intaglio ed a croce PHILLIPS	519 M 324H	7

DESCRIZIONE	ART	PZ
Giraviti per viti TORX	519 M 324STX	8
Chiavi maschio esagonali con impugnatura (3-4-5-6-7-8-10 mm)	519 M 280HG	7
Cassetta inserti assortita e chiavi maschio esagonali / TORX	519 M 280N1	117
Pinze per anelli elastici interni ed esterni 15÷25 e 19÷60	519 M 127C	6
Pinza universale, pinza regolabile, tronchese, pinza becchi lunghi e pinza grip	519 M 150AX	5
Lime a taglio mezzodolce	519 M 990A5B	5
Martello per meccanici, mazzuola, cacciaspine, scalpello e bulino	519 M 382F	7

**Vuoi solo l'assortimento? Vai a pagina 20**





## CARRELLO 516 START ANCORA PIÙ RESISTENTE ED AFFIDABILE.

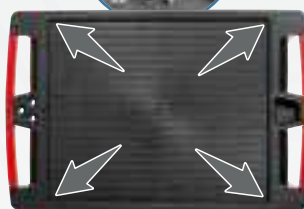
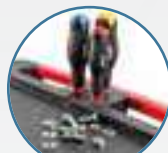

Piano di lavoro da 460 x 560 mm  
con bordi anticaduta da 15 mm



Guide resistenti da 35 mm  
con portata fino a 40 kg



Maniglie in ABS rinforzate  
con apertura basculante



### Risparmia il tuo tempo

Tutti i carrelli a cassetteria USAG sono subito pronti all'uso, perchè forniti con le ruote già montate alla struttura.



800 kg

5  
CASSETTI

3  
MODULI

54 kg | 779 mm | 972 mm | 515 mm



800 kg

6  
CASSETTI

3  
MODULI

55 kg | 779 mm | 972 mm | 515 mm



800 kg

7  
CASSETTI

3  
MODULI

56 kg | 779 mm | 972 mm | 515 mm

### 516 ST5V

U05160105

RAL 3020

#### Carrello START (vuoto)

- Dimensioni interne:
  - 2 cassetti 570x420x60 mm.
  - 2 cassetti 570x420x130 mm.
  - 1 cassetto 570x420x270 mm.

€ 649,00

€ 459,00

### 516 ST6V

U05160106

RAL 3020

#### Carrello START (vuoto)

### 516 ST6NV

U05160116

RAL 9005

#### Carrello START (vuoto)

- Dimensioni interne:
  - 3 cassetti 570x420x60 mm.
  - 2 cassetti 570x420x130 mm.
  - 1 cassetto 570x420x200 mm.

€ 715,00

€ 509,00

### 516 ST7V

U05160107

RAL 3020

#### Carrello START (vuoto)

### 516 ST7NV

U05160117

RAL 9005

#### Carrello START (vuoto)

- Dimensioni interne:
  - 5 cassetti 570x420x60 mm.
  - 1 cassetto 570x420x130 mm.
  - 1 cassetto 570x420x200 mm.

€ 781,00

€ 549,00



800 kg

8 CASSETTI

3 MODULI

58 kg | mm | 779  
972  
515

**516 ST8V**  
U05160108

RAL 3020

### Carrello START (vuoto)

- Dimensioni interne:
  - 6 cassetti 570x420x60 mm.
  - 2 cassetti 570x420x130 mm.

~~€ 847,00~~

**€ 599,00**



800 kg

6 CASSETTI

4 MODULI

68 kg | mm | 969  
972  
515

**516 STXL6V**  
U05160146

RAL 3020

### Carrello START (vuoto)

**516 STXL6NV**  
U05160156

RAL 9005

### Carrello START (vuoto)

- Dimensioni interne:
  - 3 cassetti 760x420x60 mm.
  - 2 cassetti 760x420x130 mm.
  - 1 cassetto 760x420x200 mm.

~~€ 865,00~~

**€ 599,00**

## Antiribaltamento



800 kg



6 CASSETTI

3 MODULI

56 kg | mm | 779  
972  
515

**516 STS6NV**  
U05160136

RAL 9005

### Carrello START (vuoto)

- Dimensioni interne:
  - 3 cassetti 570x420x60 mm.
  - 2 cassetti 570x420x130 mm.
  - 1 cassetto 570x420x200 mm.

~~€ 849,00~~

**€ 599,00**

## Doppio cassetto

4 CASSETTI | 3 MODULI



34 kg | mm | 779  
467  
515

**516 STC4V**  
U05160104

RAL 3020

### Cassettiera START (vuota)

- Dimensioni interne:
  - 3 cassetti: 570x420x60 mm.
  - 1 cassetto: 570x420x130 mm.

~~€ 500,00~~

**€ 349,00**

30 kg | mm | 779  
972  
515



200 kg

2 CASSETTI

3 MODULI

3 RIPIANI

779 mm

**516 SU2V**  
U05160002

RAL 3020

### Carrello START multiuso con cassetti

- Piano di lavoro in ABS ad alta resistenza con doppia maniglia.
- Ripiani con bordo anticaduta e copertura in plastica antiolio.
- Fornito smontato.
- Dimensioni cassetti:
  - 2 cassetti 570x420x60 mm.

~~€ 449,00~~

**€ 314,00**

## Versione extralarge

22 kg | mm | 969  
972  
515



300 kg

3 RIPIANI

969 mm

**516 SUXLV**  
U05160003

RAL 3020

### Carrello START multiuso XL

- Piano di lavoro in ABS ad alta resistenza con doppia maniglia.
- Ripiani con bordo anticaduta e copertura in plastica antiolio.
- Fornito smontato.

~~€ 332,00~~

**€ 232,00**

COMPATIBILI CON ACCESSORI 516



## NON TROVI IL TUO Configuralo su



**6**  
CASSETTI

**3**  
MODULI

**RISPARMI**  
**€ 150**

Rispetto all'acquisto di carrello ed assortimento separati.



**6**  
CASSETTI

**3**  
MODULI

**RISPARMI**  
**€ 150**

Rispetto all'acquisto di carrello ed assortimento separati.

**157**  
PEZZI

**516 ST6PM**  
U05160630

RAL 3020



**516 ST6NPM**  
U05161630

RAL 9005

**Carrello START con assortimento MANUTENZIONE - 4 cassette**

~~€ 1.949,00~~

**€ 988,00**

**142**  
PEZZI

**516 ST6PA**  
U05160629

RAL 3020



**516 ST6NPA**  
U05161629

RAL 9005

**Carrello START con assortimento AUTORIPARAZIONE - 2 cassette**

~~€ 1.863,00~~

**€ 988,00**

### ASSORTIMENTO MANUTENZIONE



519/613AEA 519/613CEA 519 SK692V 519/285A1 519/150AX 519 SK692V

519/324H 519/324TX 519 SK692V + 692 J32 519 SK692V 519/990A1 519/382F

### ASSORTIMENTO AUTORIPARAZIONE

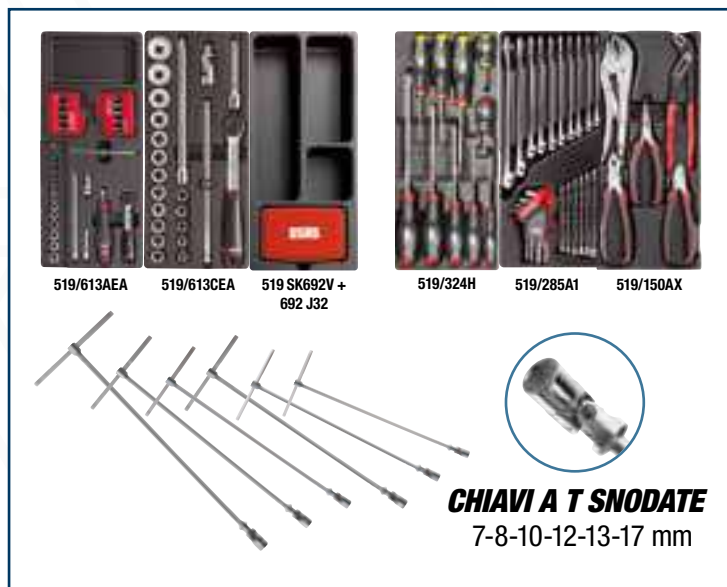

519/613AEA 519/613CEA 519 SK692V + 692 J32 519/324H 519/285A1 519/150AX

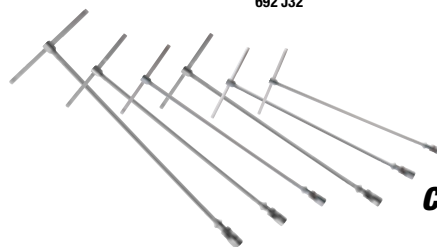

**CHIAVI A T SNODATE**  
7-8-10-12-13-17 mm

DESCRIZIONE	ART	PZ
Bussole esagonali, cricchetto (237 A), accessori 1/4 ed inserti	519/613AEA	42
Bussole esagonali, cricchetto (237 A) ed accessori 1/2	519/613CEA	22
Chiavi combinate (6÷24 mm) + chiavi maschio esagonali (1,5÷10 mm)	519/285A1	25
Pinza universale, pinza regolabile, tronchese, pinza becchi lunghi e pinza grip	519/150AX	5
Giraviti per viti ad intaglio ed a croce PHILLIPS	519/324H	10
Giraviti per viti TORX	519/324TX	9
Lime a taglio mezzodolce	519/990A1	4
Martello per meccanici, mazzuola, cacciaspine, scalpello e bulino	519/382F	8
Assortimento di inserti con cricchetto reversibile	692 J32	32

DESCRIZIONE	ART	PZ
Bussole esagonali, cricchetto (237 A), accessori 1/4 ed inserti	519/613AEA	42
Bussole esagonali, cricchetto (237 A) ed accessori 1/2	519/613CEA	22
Giraviti per viti ad intaglio ed a croce PHILLIPS	519/324H	10
Chiavi combinate (6÷24 mm) + chiavi maschio esagonali (1,5÷10 mm)	519/285A1	25
Pinza universale, pinza regolabile, tronchese, pinza becchi lunghi e pinza grip	519/150AX	5
Chiavi a T snodate con bocca esagonale (7-8-10-12-13-17 mm)	276 CE	6
Assortimento di inserti con cricchetto reversibile	692 J32	32

**Vuoi solo l'assortimento? Vai a pagina 21**



## ASSORTIMENTO IDEALE?

kitplanner.usag.it



6 CASSETTI 3 MODULI

RISPARMI  
€ 220

Rispetto all'acquisto di carrello ed assortimento separati.



6 CASSETTI 3 MODULI

RISPARMI  
€ 220

Rispetto all'acquisto di carrello ed assortimento separati.

156 PEZZI

516 ST6MM  
U05160628

RAL 3020



516 ST6NMM  
U05161628

RAL 9005

Carrello START con assortimento MANUTENZIONE - 4 cassetti

€ 2.187,00

€ 1.098,00

155 PEZZI

516 ST6MA  
U05160627

RAL 3020



516 ST6NMA  
U05161627

RAL 9005

Carrello START con assortimento AUTORIPARAZIONE - 3 cassetti

€ 2.171,00

€ 1.098,00

### ASSORTIMENTO MANUTENZIONE



519 M 613AEA 519 M 613CEA 519 M 285A1



519 M 127C 519 M 150AX 519 MSK6



519 M 324H 519 M 324STX 519 MSK6+ 692 J32



519 M 990A5B 519 M 382 519 MSK6

DESCRIZIONE	ART	PZ
Bussole esagonali, cricchetto (237 A), accessori 1/4 ed inserti	519 M 613AEA	46
Bussole esagonali, cricchetto (237 A) ed accessori 1/2	519 M 613CEA	23
Chiavi combinate (6-7-8-9-10-11-12-13-14-15-16-17-18-19-22-24 mm)	519 M 285A1	17
Pinze per anelli elastici interni ed esterni 15÷25 e 19÷60	519 M 127C	6
Pinza universale, pinza regolabile, tronchese, pinza becchi lunghi e pinza grip	519 M 150AX	5
Giraviti per viti ad intaglio ed a croce PHILLIPS	519 M 324H	7
Giraviti per viti TORX	519 M 324STX	8
Lime a taglio mezzodolce	519 M 990A5B	5
Martello per meccanici, mazzuola, cacciaspine, scalpello e bulino	519 M 382F	7
Assortimento di inserti con cricchetto reversibile	692 J32	32

### ASSORTIMENTO AUTORIPARAZIONE



519 M 285A1 519 M 324H 519 M 324STX



519 M 613AEA 519 M 612CLA

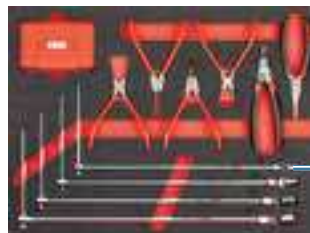

519 M 276C



CHIAVI A T SNODATE  
8-10-13-17 mm

DESCRIZIONE	ART	PZ
Bussole esagonali, cricchetto (237 A), accessori 1/4 ed inserti	519 M 613AEA	46
Bussole esagonali lunghe e corte, cricchetto (237 A) ed accessori 1/2	519 M 612CLA	35
Chiavi combinate (6-7-8-9-10-11-12-13-14-15-16-17-18-19-22-24 mm)	519 M 285A1	17
Giraviti per viti ad intaglio ed a croce PHILLIPS	519 M 324H	7
Giraviti per viti TORX	519 M 324STX	8
Pinze per anelli elastici, pinza universale, pinza becchi lunghi, chiavi snodate con bussola esagonale (8-10-13-17 mm), assortimento di inserti con cricchetto	519 M 276C	42

Vuoi solo l'assortimento? Vai a pagina 20



## NON TROVI IL TUO

Configuralo su



**6**  
CASSETTI

**4**  
MODULI

**RISPARMI**  
**€ 260**

Rispetto all'acquisto di carrello ed assortimento separati.



**6**  
CASSETTI

**4**  
MODULI

**RISPARMI**  
**€ 260**

Rispetto all'acquisto di carrello ed assortimento separati.

**301**  
PEZZI

**516 STXL6MM**  
U05160632

RAL 3020

Carrello START con assortimento MANUTENZIONE - 4 cassette

~~€ 3.449,00~~

**€ 1.758,00**

**301**  
PEZZI

**516 STXL6NMM**  
U05161632

RAL 9005

Carrello START con assortimento MANUTENZIONE - 4 cassette

~~€ 3.449,00~~

**€ 1.758,00**

## ASSORTIMENTO MANUTENZIONE



519 M 612CLA

519 M 613BEA

519 M 613AEA

519 M 285KA

519 M 285A1

519 M 285A2

519 M 294B

519 M 324H

519 M 324STX

519 M 280HG

519 M 280N1

519 M 127C

519 M 150AX

519 M 382F

519 M 990A5MD

### DESCRIZIONE

DESCRIZIONE	ART	PZ
Bussole esagonali, cricchetto (237 A), accessori 1/4 ed inserti	519 M 613AEA	46
Bussole esagonali, cricchetto (237 A) ed accessori 3/8	519 M 613BEA	20
Bussole esagonali lunghe e corte, cricchetto (237 A) ed accessori 1/2	519 M 612CLA	35
Chiavi combinate a cricchetto reversibili (8-9-10-11-12-13-14-15-16-17-18-19 mm)	519 M 285 KA	12
Chiavi combinate (6-7-8-9-10-11-12-13-14-15-16-17-18-19-22-24 mm)	519 M 285A1	17
Chiavi combinate (27-29-30-32-34 mm)	519 M 285A2	5
Chiave a rullino rapida e corta, pinza autobloccante e forbice	519 M 294B	4
Giraviti per viti ad intaglio ed a croce PHILLIPS	519 M 324H	7

### DESCRIZIONE

DESCRIZIONE	ART	PZ
Giraviti per viti TORX	519 M 324STX	8
Chiavi maschio esagonali con impugnatura (3-4-5-6-7-8-10 mm)	519 M 280HG	7
Cassetta inserti assortita e chiavi maschio esagonali / TORX	519 M 280N1	117
Pinze per anelli elastici interni ed esterni 15÷25 e 19÷60	519 M 127C	6
Pinza universale, pinza regolabile, tronchese, pinza becchi lunghi e pinza grip	519 M 150AX	5
Lime a taglio mezzodolce	519 M 990A5B	5
Martello per meccanici, mazzuola, cacciaspine, scalpello e bulino	519 M 382F	7



## ASSORTIMENTO IDEALE?

kitplanner.usag.it



6 CASSETTI  
3 MODULI

18V XR  
DCD796

Incluso  
trapano  
avvitatore



6 CASSETTI  
3 MODULI

18V XR  
DCF894

Incluso  
avvitatore  
ad impulsi



113  
PEZZI

516 ST6UD-796  
U05162796W

RAL  
3020

INS EME  
UN CI

516 ST6NUD-796  
U05163796W

RAL  
9005

Carrello START con assortimento  
MANUTENZIONE - 4 cassette

~~€ 2.612,00~~

€ 1.319,00

121  
PEZZI

516 ST6UD-894  
U05162894W

RAL  
3020

INS EME  
UN CI

516 ST6NUD-894  
U05163894W

RAL  
9005

Carrello START con assortimento  
AUTORIPARAZIONE - 4 cassette

~~€ 2.849,00~~

€ 1.319,00

### ASSORTIMENTO MANUTENZIONE

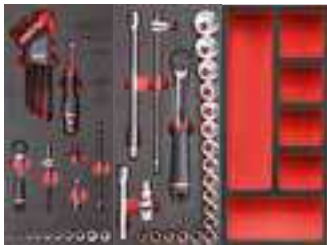

519 M 613AEA 519 M 613CEA 519 MSK6



519 M 324H 519 M 324STX 519 MSK6



519 M 285A1 519 M 150AX 519 MSK6



519 M 990A5MD

Alloggiamento libero  
per 3ª batteria



2 batterie  
incluse

### ASSORTIMENTO AUTORIPARAZIONE



519 M 613AEA 519 M 613CEA 519 MSK6

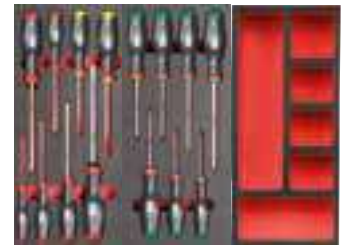

519 M 324H 519 M 324STX 519 MSK6



519 M 285A1 519 M 150AX 519 MSK6

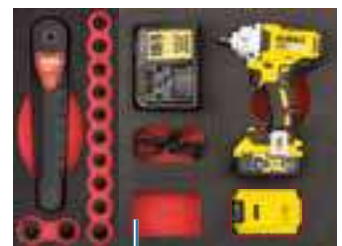

519 M 236K

Alloggiamento libero  
per 3ª batteria



2 batterie  
incluse

DESCRIZIONE	ART	PZ
Bussole esagonali, cricchetto (237 A 1/4"), accessori 1/4" ed inserti	519 M 613AEA	46
Bussole esagonali, cricchetto (237 A 1/2") e accessori 1/2"	519 M 613CEA	23
Chiavi combinate (6-7-8-9-10-11-12-13-14-15-16-17-18-19-22-24 mm)	519 M 285A1	17
Pinza universale, pinza regolabile, tronchese, pinza becchi lunghissimi, pinza grip	519 M 150AX	5
Giraviti a taglio e croce PH	519 M 324H	7
Giraviti TORX® Tamper Resistant (T10-T15-T20-T25-T30-T40)	519 M 324STX	8
Lime a taglio mezzodolce	519 M 990A5B	5
Caricabatterie universale XR Litio	DCB115	1
Trapano avvitatore con percussione	DCD796	1

DESCRIZIONE	ART	PZ
Bussole esagonali, cricchetto (237 A 1/4"), accessori 1/4" ed inserti	519 M 613AEA	46
Bussole esagonali, cricchetto (237 A 1/2") e accessori 1/2"	519 M 613CEA	23
Chiavi combinate (6-7-8-9-10-11-12-13-14-15-16-17-18-19-22-24 mm)	519 M 285A1	17
Pinza universale, pinza regolabile, tronchese, pinza becchi lunghissimi, pinza grip	519 M 150AX	5
Giraviti a taglio e croce PH	519 M 324H	7
Giraviti TORX® Tamper Resistant (T10-T15-T20-T25-T30-T40)	519 M 324STX	8
Cassetta inserti assortita e chiavi maschio esagonali - TORX®	519 M 236K	13
Caricabatterie universale XR Litio	DCB115	1
Avvitatore ad impulsi 1/2" con batteria	DCF894	1





**516 AC1**  
U05160301

**Porta rotolo**

€ 46,70 **€ 39,70**



**516 AC2**  
U05160302

**Porta flaconi**

€ 78,00 **€ 54,50**



**516 AC3**  
U05160303

**Porta documenti**

€ 55,50 **€ 38,80**



**516 AC4**  
U05160304

**Porta rifiuti**

€ 87,00 **€ 61,00**



**516 AC5**  
U05160305

**Armadio con serratura**

€ 253,00 **€ 177,00**



**516 AC6**  
U05160306

**Ripiano pieghevole**

€ 157,00 **€ 110,00**



**516 AC7**  
U05160307

**Supporto per avvitatori**

€ 104,00 **€ 73,00**



**516 AC8**  
U05160308

**Porta flaconi con presa schuko e USB**

- Lunghezza cavo 1,8 m.

€ 111,00 **€ 77,50**



**516 AC9**  
U05160309

**Piano in legno da 15 mm**

- Adatto ai soli carrelli 516 START a 3 moduli.

€ 78,00 **€ 54,50**



## COMPLETA IL TUO CARRELLO E RENDILO PERFETTO

Tutti i carrelli della gamma 516 START possono essere completati con i nuovi accessori laterali. Si agganciano facilmente, aggiungendo funzioni utili alle diverse destinazioni d'uso. La gamma di accessori 516 START è compatibile anche con tutti i modelli della gamma 519 RACING e con i moduli base della linea arredamento 516 START.

## ACCESSORI

### START E 519 RACING



**519 ACT1**

U05190301

Supporto laptop

€ 156,00 **€ 109,00**



**519 ACT2**

U05190302

Porta flaconi  
e porta rotolo

€ 167,00 **€ 117,00**



YouTube



**519 ACT3**

U05190303

Barra blocca  
cassetti

€ 174,00 **€ 122,00**



**519 ACT4**

U05190304

Pannello per  
moduli in spugna

€ 55,50 **€ 38,80**



**519 ACT5**

U05190305

Porta documenti

€ 55,50 **€ 38,80**



**519 ACT6**

U05190306

Piano in legno M3  
(775 mm)

€ 200,00 **€ 140,00**



**519 ACT7**

U05190307

Piano in legno M4  
(965 mm)

€ 245,00 **€ 172,00**



**519 ACT8**

U05190308

Piano in legno M5  
(1155 mm)

€ 267,00 **€ 187,00**



**519 ACT9**

U05190309

Piano in legno  
porta morsa

€ 111,00 **€ 77,50**



**519 ACT10**

U05190310

Ganci posteriori  
porta oggetti

€ 24,50 **€ 17,10**

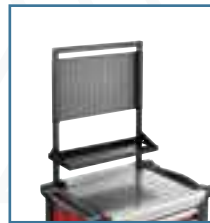

**519 ACT11**

U05190311

Pannello forato con  
mensola

€ 253,00 **€ 177,00**



**519 ACT12**

U05190312

Pannello forato  
doppio

€ 253,00 **€ 177,00**



**519 ACT13**

U05190313

Pannello forato/  
liscio con mensola

€ 278,00 **€ 195,00**

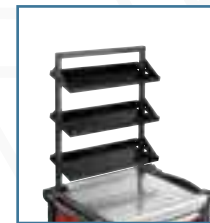

**519 ACT14**

U05190314

Tripla mensola

€ 301,00 **€ 211,00**



## CREA IL CARRELLO ADATTO AL TUO LAVORO.

Il nuovo piano di lavoro integra un'innovativo sistema di binari che permettono di montare una nuova gamma di accessori specifici. Insieme all'utilizzo dei classici accessori laterali (pagina 16) puoi rendere il tuo carrello RACING una vera postazione di lavoro.



## VUOI CREARE LA TUA Configurala su



YouTube



**Include: ganci e lampade LED**

**POSSIBILITÀ DI INVERTIRE IL SENSO  
DI APERTURA DELL'ANTA**



**Include: ganci, lampade LED  
e presa multipla**

**ACCIAIO**

Pianale in acciaio  
1.450 mm  
516 AC/1

**516 SA/CA1**  
U05160235

135 kg | 1.450 mm | 2.000 mm | 650

**Arredamento per officina - pianale in acciaio**

- Fornita con kit base di 30 ganci 516 SA/K1.

~~€ 2.161,00~~

**€ 1.513,00**

**LEGNO**

Pianale in legno  
1.450 mm  
516 SAL/1

**516 SA/C1**  
U05160231

127 kg | 1.450 mm | 2.000 mm | 650

**Arredamento per officina - pianale in legno**

- Fornita con kit base di 30 ganci 516 SA/K1.

~~€ 2.161,00~~

**€ 1.513,00**



DESCRIZIONE	ART	PZ
Mobile fisso con 6 cassetti	516 SA/1	1
Mobile fisso con 2 ante	516 SA/2	1
Pannello forato portautensili	516 SA/5	6
Rialzo per mobili	516 SA/11	2
Lampada a LED	516 SA/12	2
Ripiano metallico	516 SA/13	2
Kit di montaggio	516 SA/14	2
Kit di 30 ganci per pannelli	516 SA/K1	1

**ACCIAIO**

Pianale in acciaio  
1.450 mm  
516 AC/1

**516 SA/CA2**  
U05160236

198 kg | 1.950 mm | 2.000 mm | 650

**Arredamento per officina - pianale in acciaio**

- Fornita con kit base di 30 ganci 516 SA/K1.

~~€ 3.413,00~~

**€ 2.389,00**

**LEGNO**

Pianale in legno  
1.450 mm  
516 SAL/1

**516 SA/C2**  
U05160232

190 kg | 1.950 mm | 2.000 mm | 650

**Arredamento per officina - pianale in legno**

- Fornita con kit base di 30 ganci 516 SA/K1.

~~€ 3.413,00~~

**€ 2.389,00**

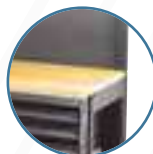

DESCRIZIONE	ART	PZ
Mobile fisso con 6 cassetti	516 SA/1	1
Mobile fisso con 2 ante	516 SA/2	1
Armadio a 1 anta	516 SA/3	1
Pensile con anta basculante	516 SA/4	2
Pannello forato portautensili	516 SA/5	3
Pannello forato portautensili con prese SCHUKO e USB	516 SA/6	1
Rialzo per mobili	516 SA/11	3
Lampada a LED	516 SA/12	2
Kit di montaggio	516 SA/14	2
Kit di 30 ganci per pannelli	516 SA/K1	1



## POSTAZIONE SU MISURA?

start516.usag.it

**POSSIBILITÀ DI INVERTIRE IL SENSO DI APERTURA DELL'ANTA**



**Include: ganci, lampade LED e presa multipla**



Pianale in acciaio  
2.175 mm  
516 AC/2

**516 SA/CA3**  
U05160237

289 kg | mm | → 2.675  
↓ 2.000  
↙ 650

**Arredamento per officina - pianale in acciaio**

- Fornita con kit base di 30 ganci 516 SA/K1.

€ 4.603,00

**€ 3.222,00**



Pianale in legno  
2.175 mm  
516 SAL/2

**516 SA/C3**  
U05160233

278 kg | mm | → 2.675  
↓ 2.000  
↙ 650

**Arredamento per officina - pianale in legno**

- Fornita con kit base di 30 ganci 516 SA/K1.

€ 4.603,00

**€ 3.222,00**



DESCRIZIONE	ART	PZ
Mobile fisso con 6 cassetti	516 SA/1	1
Mobile fisso con 2 ante	516 SA/2	1
Armadio a 1 anta	516 SA/3	1
Pensile con anta basculante	516 SA/4	3
Pannello forato portautensili	516 SA/5	5
Pannello forato portautensili con prese SCHUKO e USB	516 SA/6	1
Rialzo per mobili	516 SA/11	3
Lampada a LED	516 SA/12	2
Kit di montaggio	516 SA/14	3
Kit di 30 ganci per pannelli	516 SA/K1	1
Carrello - 6 cassetti	516 SA/16	1



Pianale in acciaio  
2.175 mm  
516 AC/2

**516 SA/CA4**  
U05160238

160 kg | mm | → 2.175  
↓ 2.000  
↙ 650

**Arredamento per officina - pianale in acciaio**

- Fornita con kit base di 30 ganci 516 SA/K1.

€ 2.509,00

**€ 1.756,00**



Pianale in legno  
2.175 mm  
516 SAL/2

**516 SA/C4**  
U05160234

147 kg | mm | → 2.175  
↓ 2.000  
↙ 650

**Arredamento per officina - pianale in legno**

- Fornita con kit base di 30 ganci 516 SA/K1.

€ 2.509,00

**€ 1.756,00**



DESCRIZIONE	ART	PZ
Mobile fisso con 6 cassetti	516 SA/1	1
Mobile fisso con 2 ante	516 SA/2	1
Pannello forato portautensili	516 SA/5	8
Pannello forato portautensili con prese SCHUKO e USB	516 SA/6	1
Rialzo per mobili	516 SA/11	2
Lampada a LED	516 SA/12	2
Ripiano metallico	516 SA/13	3
Kit di montaggio	516 SA/14	3
Kit di 30 ganci per pannelli	516 SA/K1	1



**Include: ganci, lampade LED e presa multipla**

1000 kg



ACCIAIO

6 CASSETTI 3 MODULI

102 kg | mm | 2.000 | 850 | 700

516 SPC2  
U05160021

RAL 3020

Banco da lavoro START con piano in acciaio

- Dimensioni interne cassetti:
  - 3 cassetti 570x420x60 mm.
  - 2 cassetti 570x420x130 mm.
  - 1 cassetto 570x420x200 mm.

€ 1.372,00

€ 960,00



2000 mm

516 SPCN2  
U05160023

RAL 9004

Banco da lavoro START con piano in acciaio

€ 1.372,00

€ 960,00

## Piano in acciaio zincato

Trattato anticorrosione e con bordi anticaduta da 37 mm.

1000 kg



LEGNO

6 CASSETTI 3 MODULI

115 kg | mm | 2.000 | 850 | 700

516 SPC1  
U05160020

RAL 3020

Banco da lavoro START con piano in legno

- Dimensioni interne cassetti:
  - 3 cassetti 570x420x60 mm.
  - 2 cassetti 570x420x130 mm.
  - 1 cassetto 570x420x200 mm.

€ 1.372,00

€ 960,00



2000 mm

516 SPCN1  
U05160022

RAL 9004

Banco da lavoro START con piano in legno

€ 1.372,00

€ 960,00

## Piano in faggio multistrato

Lo spessore di 40 mm garantisce il top della resistenza.

## SISTEMA MODULARE PER ALLESTIMENTO FURGONI

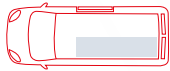

**LATO SINISTRO**



96 kg | mm | 1.238  
1.146  
375



**5006 EF2**  
U50060035

**Composizione:**

DESCRIZIONE	CODICE	PZ.
Cassettiera 5000 E5	U50000105	1
Cassettiera 5000 CE3	U50000052	1
Base passaruota 5002 B3	U50020010	1
Porta-flaconi 5002 SA5	U50020067	1
Coppia montanti 5003 MF1	U50030052	1
Ripiano porta vaschette 5003 A2/7	U50030074	1
Sistema di fissaggio 5002 S5	U50020048	2

~~€ 1.743,00~~

**€ 1.225,00**

Inquadra il QR code per verificare i modelli di furgoni compatibili.

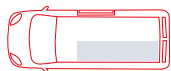

**LATO SINISTRO**



43 kg | mm | 990  
1.014  
375



**5006 EF6**  
U50060040

**Composizione:**

DESCRIZIONE	CODICE	PZ.
Cassettiera per valigette 5000 AD2	U50000004	1
Cassettiera 5000 C3	U50000042	1
Base passaruota 5002 B2N	U50020009	1
Ripiano 5002 R2	U50020031	1
Porta flaconi 5002 SA5	U50020067	1
Sistema di fissaggio 5002 S5	U50020048	1

~~€ 1.186,00~~

**€ 830,00**

Inquadra il QR code per verificare i modelli di furgoni compatibili.



### NUOVO MODULO PER VALIGETTE TSTAK

Permette di alloggiare fino a due valigette portautensili, organizer o elettroutensili. La barre di chiusura centrale garantisce sicurezza durante il trasporto.

**TSTAK™**





## MODULI IN SPUGNA BICOLORE



519 M 613AEA 519 M 613CEA 519 M 285A1



519 M 127C 519 M 150AX 519 MSK6



519 M 324H 519 M 324STX 519 MSK6+692 J32



519 M 990A5B 519 M 382 519 MSK6



519 M 285A1 519 M 324H 519 M 324STX



519 M 613AEA 519 M 612CLA



519 M 276C



**CHIAVI A T SNODATE**  
8-10-13-17 mm

**495 MB**  
U04950628

**156**  
PEZZI



**Assortimento MANUTENZIONE - 4 cassette**

DESCRIZIONE	ART	PZ
Bussole esagonali, cricchetto (237 A), accessori 1/4 ed inserti	519 M 613AEA	46
Bussole esagonali, cricchetto (237 A) ed accessori 1/2	519 M 613CEA	23
Chiavi combinate (6-7-8-9-10-11-12-13-14-15-16-17-18-19-22-24 mm)	519 M 285A1	17
Pinze per anelli elastici interni ed esterni 15÷25 e 19÷60	519 M 127C	6
Pinza universale, pinza regolabile, tronchese, pinza becchi lunghi e pinza grip	519 M 150AX	5
Giraviti per viti ad intaglio ed a croce PHILLIPS	519 M 324H	7
Giraviti per viti TORX	519 M 324STX	8
Lime a taglio mezzodolce	519 M 990A5B	5
Martello per meccanici, mazzuola, cacciaspine, scalpello e bulino	519 M 382F	7
Assortimento di inserti con cricchetto reversibile	692 J32	32

~~€ 1.472,00~~

**€ 809,00**

**495 MAA**  
U04950627

**155**  
PEZZI



**Assortimento AUTORIPARAZIONE - 3 cassette**

DESCRIZIONE	ART	PZ
Bussole esagonali, cricchetto (237 A), accessori 1/4 ed inserti	519 M 613AEA	46
Bussole esagonali lunghe e corte, cricchetto (237 A) ed accessori 1/2	519 M 612CLA	35
Chiavi combinate (6-7-8-9-10-11-12-13-14-15-16-17-18-19-22-24 mm)	519 M 285A1	17
Giraviti per viti ad intaglio ed a croce PHILLIPS	519 M 324H	7
Giraviti per viti TORX	519 M 324STX	8
Pinze per anelli elastici, pinza universale, pinza becchi lunghi, chiavi snodate con bussola esagonale (8-10-13-17 mm), assortimento di inserti con cricchetto	519 M 276C	42

~~€ 1.456,00~~

**€ 809,00**



519 M 612CLA 519 M 613BEA 519 M 613AEA



519 M 285KA 519 M 285A1 519 M 285A2 519 M 294B

**301**  
PEZZI



**495 MC**  
U04950632

**Assortimento MANUTENZIONE**  
**4 cassette**

~~€ 2.584,00~~

**€ 1.419,00**



519 M 324H 519 M 324STX 519 M 280HG 519 M 280N1



519 M 127C 519 M 150AX 519 M 382F 519 M 990A5MD

## MODULI IN PLASTICA



519/613AEA 519/613CEA 519 SK692V



519/285A1 519/150AX 519 SK692V



519/324H 519/324TX 519 SK692V + 692 J32



519 SK692V 519/990A1 519/382F



519/613AEA 519/613CEA 519 SK692V + 692 J32



519/324H 519/285A1 519/150AX



**CHIAVI A T SNODATE**  
7-8-10-12-13-17 mm

**495 PM**  
U04950630

**157**  
PEZZI



### Assortimento MANUTENZIONE - 4 cassette

DESCRIZIONE	ART	PZ
Bussole esagonali, cricchetto (237 A), accessori 1/4 ed inserti	519/613AEA	42
Bussole esagonali, cricchetto (237 A) ed accessori 1/2	519/613CEA	22
Chiavi combinate (6÷24 mm) + chiavi maschio esagonali (1,5÷10 mm)	519/285A1	25
Pinza universale, pinza regolabile, tronchese, pinza becchi lunghi e pinza grip	519/150AX	5
Giraviti per viti ad intaglio ed a croce PHILLIPS	519/324H	10
Giraviti per viti TORX	519/324TX	9
Lime a taglio mezzodolce	519/990A1	4
Martello per meccanici, mazzuola, cacciaspine, scalpello e bulino	519/382F	8
Assortimento di inserti con cricchetto reversibile	692 J32	32

€ 1.234,00

**€ 629,00**

**495 PA**  
U04950629

**142**  
PEZZI



### Assortimento AUTORIPARAZIONE - 2 cassette

DESCRIZIONE	ART	PZ
Bussole esagonali, cricchetto (237 A), accessori 1/4 ed inserti	519/613AEA	42
Bussole esagonali, cricchetto (237 A) ed accessori 1/2	519/613CEA	22
Giraviti per viti ad intaglio ed a croce PHILLIPS	519/324H	10
Chiavi combinate (6÷24 mm) + chiavi maschio esagonali (1,5÷10 mm)	519/285A1	25
Pinza universale, pinza regolabile, tronchese, pinza becchi lunghi e pinza grip	519/150AX	5
Chiavi a T snodate con bocca esagonale (7-8-10-12-13-17 mm)	276 CE	6
Assortimento di inserti con cricchetto reversibile	692 J32	32

€ 1.148,00

**€ 629,00**

DESCRIZIONE	ART	PZ
Bussole esagonali, cricchetto (237 A), accessori 1/4 ed inserti	519 M 613AEA	46
Bussole esagonali, cricchetto (237 A) ed accessori 3/8	519 M 613BEA	20
Bussole esagonali lunghe e corte, cricchetto (237 A) ed accessori 1/2	519 M 612CLA	35
Chiavi combinate a cricchetto reversibili (8-9-10-1-12-13-14-15-16-17-18-19 mm)	519 M 285 KA	12
Chiavi combinate (6-7-8-9-10-1-12-13-14-15-16-17-18-19-22-24 mm)	519 M 285A1	17
Chiavi combinate (27-29-30-32-34 mm)	519 M 285A2	5
Chiave a rullino rapida e corta, pinza autobloccante e forbice	519 M 294B	4
Giraviti per viti ad intaglio ed a croce PHILLIPS	519 M 324H	7
Giraviti per viti TORX	519 M 324STX	8
Chiavi maschio esagonali con impugnatura (3-4-5-6-7-8-10 mm)	519 M 280HG	7
Cassetta inserti assortita e chiavi maschio esagonali / TORX	519 M 280N1	117
Pinze per anelli elastici interni ed esterni 15÷25 e 19÷60	519 M 127C	6
Pinza universale, pinza regolabile, tronchese, pinza becchi lunghi e pinza grip	519 M 150AX	5
Lime a taglio mezzodolce	519 M 990A5B	5
Martello per meccanici, mazzuola, cacciaspine, scalpello e bulino	519 M 382F	7



**NON TROVI IL TUO  
ASSORTIMENTO IDEALE?**  
Configuralo su [kitplanner.usag.it](http://kitplanner.usag.it)



# Moduli in plastica



**519/127N**  
**U05190716** **4 PEZZI**  
127 N 19÷60 · 127 PN 19÷60 ·  
128 N 19÷60 · 128 PN 19÷60.  
€ 111,00 **€ 77,50**



**519/150AX**  
**U05190850** **5 PEZZI**  
133 AX 160 · 134 250 · 150 AX 180 ·  
180 C 250 · 188 AX 160.  
€ 163,00 **€ 114,00**



**519/280HG**  
**U05191860** **7 PEZZI**  
280 HG 3-4-5-6-7-8-10.  
€ 109,00 **€ 76,50**



**519/280HGTS**  
**U05191861** **7 PEZZI**  
280 HGTS 3-4-5-6-7-8-10.  
€ 119,00 **€ 83,50**



**519/285A1**  
**U05190785** **25 PEZZI**  
285 6-7-8-9-10-11-12-13-14-15-16-17-  
18-19-22-24 280 S9 1,5÷10.  
€ 184,00 **€ 129,00**



**519/285B2**  
**U05190823** **4 PEZZI**  
285 27-29-30-32.  
€ 100,00 **€ 70,00**



**519/285KA1**  
**U05190788** **12 PEZZI**  
285 KA 8-9-10-11-12-13-14-15-  
16-17-18-19.  
€ 236,00 **€ 165,00**



**519/294**  
**U05190732** **9 PEZZI**  
204 250 · 294 A 250 · 367 2x110-3x130-  
4x145-5x165-6x180-8x200 · 981 A3.  
€ 120,00 **€ 84,00**



**519/322H**  
**U05190772** **10 PEZZI**  
322 0,5x3x75-0,8x4x100-1x5,5x125-  
1,2x6,5x150-1,6x8x175 · 322 PH 0x75-1x100-  
2x125 · 322 N 0,8x4x30 · 322 NPH 2x30.  
€ 62,00 **€ 43,40**



**519/322STX**  
**U05190831** **6 PEZZI**  
322 STX T10-T15-T20-T25-T30-T40.  
€ 55,50 **€ 38,80**



**519/324H**  
**U05190763** **10 PEZZI**  
324 0,5x3x75-0,8x4x100-1x5,5x125-  
1,2x6,5x150-1,2x8x200 · 324 PH 0x75-1x75-  
2x100 · 324 N 0,8x4x35 · 324 NPH 2x35.  
€ 80,50 **€ 56,50**



**519/324TX**  
**U05190764** **9 PEZZI**  
324 TX T6x50-T7x50-T8x50-T9x75 · 324 STX  
T10x75-T15x75-T20x100-T25x100-T30x125.  
€ 106,00 **€ 74,00**



**519/366**  
**U05190740** **7 PEZZI**  
351 200 · 362 125-150 · 364 125 ·  
366 3x125 · 4x150 · 368 4x125.  
€ 80,00 **€ 56,00**



**519/382F**  
**U05190742** **8 PEZZI**  
362 150 · 367 2x100-3x130-4x145-  
5x165 · 368 4x125 · 376 35 · 382F 500.  
€ 99,50 **€ 69,50**



**519/613AEA** **42 PEZZI**  
**U05190784** 237 A  
235 1/4" EN 4-4,5-5-5,5-6-7-8-9-10-11-12-13-  
14 · 236 1/4" 50-150 · 237 A 1/4" · 240 1/4" ·  
241 1/4" · 243 1/4" · 692 S11 · 692 STX/S11 ·  
684 1/4"-1/4".  
€ 209,00 **€ 146,00**



**519/613BEA** **21 PEZZI**  
**U05190747** 237 A  
235 3/8" E 6-7-8-9-10-11-12-13-14-15-  
16-17-18-19-21-22 · 236 3/8" 125-250 ·  
237 A 3/8" · 240 3/8" N · 241 3/8".  
€ 213,00 **€ 149,00**



**519/613CEA** **22 PEZZI**  
**U05190750** 237 A  
235 1/2" EN 10-11-12-13-14-15-16-  
17-18-19-20-21-22-24-27-30-32 · 236  
1/2" 125-250 · 237 A 1/2" · 240 1/2" N ·  
241 1/2".  
€ 257,00 **€ 180,00**



**519/990A1**  
**U05190825** **4 PEZZI**  
990 M PA/200 · 990 M PB/200  
990 M PC/200 · 990 M PE/200.  
€ 57,50 **€ 40,30**

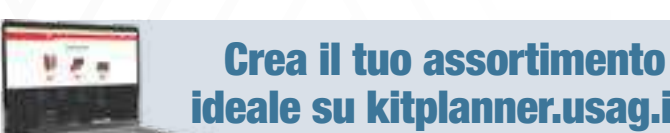

**Crea il tuo assortimento ideale su kitplanner.usag.it!**

**Scopri tutta la gamma di moduli in plastica su usag.it o inquadra il QR code**



**8 PEZZI XL**  
**519/280T**  
**U05190727**  
280 T 2-2,5-3-4-5-6-8-10.  
€ 155,00 **€ 109,00**



**8 PEZZI XXL**  
**519/276**  
**U05190725**  
276 CE 7-8-10-11-13-14-17-19.  
€ 318,00 **€ 239,00**



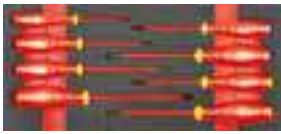

**519 M 091A**  
U05191016 **8 PEZZI**  
091 0,5x3x75-0,8x4x100-1x5,5x125  
1,2x6,5x150 · 091 PH 1x100-2x125  
· 091 PZ 1x100-2x125.  
€ 94,50 **€ 66,00**



**519 M 127N**  
U05190937 **4 PEZZI**  
127 N 19÷60 · 127 PN 19÷60 ·  
128 N 19÷60 · 128 PN 19÷60.  
€ 117,00 **€ 82,00**



**519 M 150AX**  
U05190965 **5 PEZZI**  
133 AX 160 · 134 250 · 150 AX 180 ·  
180 C 250 · 188 AX 160.  
€ 169,00 **€ 118,00**

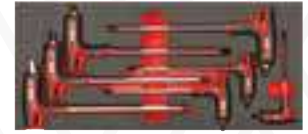

**519 M 280HG**  
U05191945 **7 PEZZI**  
280 HG 3-4-5-6-7-8-10.  
€ 115,00 **€ 80,50**

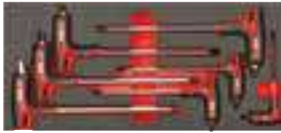

**519 M 280HGTS**  
U05191946 **7 PEZZI**  
280 HGTS 3-4-5-6-7-8-10.  
€ 125,00 **€ 87,50**



**519 M 280N1**  
U05191013 **117 PEZZI**  
280 S9 1,5-2-2,5-3-4-5-6-8-10 · 280 TX/  
S8C T10-T15-T20-T25-T27-T30-T40-T45  
· 692 J100.  
€ 133,00 **€ 93,00**



**519 M 280TK**  
U05190935 **6 PEZZI**  
280 TK 2,5-3-4-5-6-8.  
€ 120,00 **€ 90,00**



**519 M 285A1**  
U05190921 **17 PEZZI**  
285 6-7-8-9-10-11-12-13-14-15-16-  
17-18-19-21-22-24.  
€ 177,00 **€ 124,00**



**519 M 285A2**  
U05190943 **5 PEZZI**  
285 27-29-30-32-34.  
€ 144,00 **€ 101,00**



**519 M 285KA**  
U05190944 **12 PEZZI**  
285 KA 8-9-10-11-12-13-14-15-  
16-17-18-19.  
€ 241,00 **€ 169,00**



**519 M 285KB**  
U05191060 **12 PEZZI**  
285 KB 8-9-10-11-12-13-14-15-  
16-17-18-19.  
€ 184,00 **€ 129,00**



**519 M 294B**  
U05191015 **4 PEZZI**  
135 A 250 · 207 E · 294 AC · 294 AD 250.  
€ 176,00 **€ 123,00**



**519 M 324H**  
U05190910 **8 PEZZI**  
324 0,5x3x75-0,8x4x100-1x5,5x125-  
1,2x6,5x150 · 324 PH 1x100-2x125  
324 D 0,6x3,5x100 324 E 1,6x8x175.  
€ 76,50 **€ 53,50**



**519 M 324STX**  
U05190911 **7 PEZZI**  
324 STX T10x75-T15x75-T20x100-  
T25x100-T27x100-T30x125-T40x150.  
€ 107,00 **€ 75,00**



**519 M 382F**  
U05190926 **7 PEZZI**  
362 175 · 367 2x100-3x130-6x180  
368 3x100 · 376 28 · 382F 500.  
€ 122,00 **€ 85,50**



**519 M 613AEA** **46 PEZZI**  
U05190940 237 A  
235 1/4" EN 5,5-6-7-8-9-10-11-12-13-14 · 236  
1/4" 50-100 · 237 A 1/4" · 240 1/4" · 241 1/4" ·  
243 1/4" · 280 LTS/S9 · 684 1/4" · 1/4" · 660 0,6-  
1-1,6 · 660 E 3-4-5-6-8 · 660 PH 1-2-3 · 660 PZ  
1-2-3 · 660 STX T15-T20-T25-T27-T30-T40.  
€ 248,00 **€ 174,00**



**519 M 613BEA** **20 PEZZI**  
U05190928 237 A  
235 3/8" E 7-8-9-10-11-12-13-14-15-16-  
17-18-19-21-22 · 236 3/8" 125-250 ·  
237 A 3/8" · 240 3/8" N · 241 3/8".  
€ 213,00 **€ 149,00**



**519 M 613CEA** **23 PEZZI**  
U05190942 237 A  
235 1/2" EN 8-10-11-12-13-14-15-16-  
17-18-19-21-22-23-24-27-30-32 · 236  
1/2" 125-250 · 237 A 1/2" · 240 1/2" N  
· 241 1/2".  
€ 269,00 **€ 188,00**



**519 M 990A5MD**  
U05191011 **5 PEZZI**  
990 M PA/200 · 990 M PB/200 · 990 M  
PC/200 · 990 M PD/200 · 990 M PE/200.  
€ 76,00 **€ 53,00**



**Scopri tutta la gamma di  
moduli in spugna su usag.it  
o inquadra il QR code**



**8 PEZZI XL** **Novità**  
**519 M 280T**  
U05191059  
280 T 2-2,5-3-4-5-6-8-10.  
€ 164,00 **€ 115,00**



**7 PEZZI XXL**  
**519 M 276**  
U05190936  
276 CE 7-8-10-11-13-17-19.  
€ 292,00 **€ 248,00**

13 kg | 460 mm | 158 mm | 385 mm



## 002 JMA

U00020011

### Valigia con assortimento per manutenzione

- Valigia con struttura in profilato di Alluminio.
- Doppia cerniera di chiusura in metallo con serratura.
- 3 pannelli portautensili interni con elastici di tenuta.
- Base con interno in spugna bicolore sagomata.

€ 728,00

**€ 419,00**



## PINZE SERIE AX, GIRAVITI 324 E CHIAVE A RULLINO 294 AD!

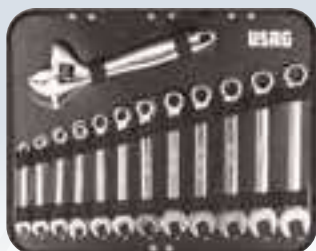

**181**  
PEZZI



## 002 JTMA

U00020015

### Valigia trolley con assortimento per manutenzione

- Valigia con struttura in profilato di Alluminio.
- Doppia cerniera di chiusura in metallo con serratura.
- 3 pannelli portautensili interni con elastici di tenuta.
- Base con interno in spugna bicolore sagomata.

€ 728,00

**€ 439,00**



### RUOTE INTEGRATE NELLA STRUTTURA



14 kg | 485 mm | 200 mm | 377 mm





## 002 UDM

U00021706W

### Valigia con assortimento per manutenzione

- Valigia con struttura in profilato di Alluminio.
- Doppia cerniera di chiusura in metallo con serratura.
- 3 pannelli portautensili interni con elastici di tenuta.
- Base con interno in mousse bicolore sagomata.

10 kg | 460 mm | 158 mm | 385 mm

74  
UTENSILI

€ 929,00

€ 459,00

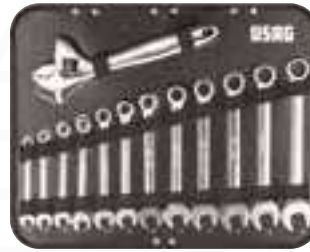

INSIEME  
UNICI



## 002 UDE

U00022706W

### Valigia con assortimento per elettricisti

€ 760,00

€ 459,00

74  
UTENSILI

10 kg | 460 mm | 158 mm | 385 mm

1000 V

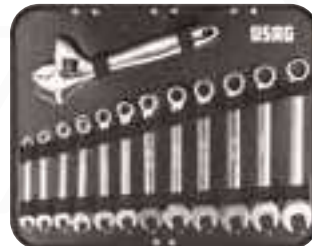

Modello con  
percussione



Batterie  
da 3.0 AH

## DCD706

### Trapano avvitatore a percussione

- Coppia 57Nm.
- 0-425/1500 giri/minuto.
- Mandrino in metallo autoserrante 1-10mm.
- Caricabatterie rapido.

12V XR

2 BATTERIE 12V  
3.0 AH INCLUSE







420 mm

MAX  
11 kg

CAPACITÀ  
34 L



Tutta l'attrezzatura a portata di mano

007/1V  
U00070001

2,5 kg | mm | 420  
340  
240

### Borsa portautensili (vuota)

- Nylon ad altissima resistenza.
- Base rigida e resistente all'acqua.
- Pratici e comodi vani interni portautensili.
- Due tasche frontali portaminuteria.
- Pratico maniglione in alluminio.
- Ganci interni porta flessometro ed elastici portautensili.
- Mantella di chiusura tramite velcro.

~~€ 80,00~~

**€ 56,00**



490 mm

MAX  
15 kg

CAPACITÀ  
47 L



Tasca frontale porta seghetto

007 V  
U00070002

4 kg | mm | 490  
350  
220

### Borsa portautensili (vuota)

- Nylon ad altissima resistenza.
- Base rigida resistente all'acqua.
- Vani interni portautensili e tasca frontale porta seghetto.
- Maniglione in alluminio con impugnatura rivestita.
- Cinghia di trasporto a tracolla.
- Mantella di chiusura con velcro.

~~€ 104,00~~

**€ 73,00**



550 mm

MAX  
18 kg

CAPACITÀ  
33 L



Maniglia telescopica

007 TXV  
U00070065

5,4 kg | mm | 550  
440  
360

### Borsa trolley portautensili (vuota)

- Tessuto ad altissima resistenza
- Maniglia telescopica.
- Ruote con diametro 90 mm.
- 6 tasche esterne e 1 tasca frontale porta seghetto.
- Vani interni portautesili.
- Maniglione in alluminio con impugnatura rivestita.
- Mantella di chiusura con velcro.

~~€ 165,00~~

**€ 115,00**



Tasca frontale porta seghetto



Ruote con diametro 90 mm



MAX  
10 kg

CAPACITÀ  
15 L

**007 MCV**  
U00070008

1 kg | mm | → 360  
↑ 280  
↙ 190

### Borsa portautensili (vuota)

- Tessuto ad altissima resistenza.
- Base rigida resistente all'acqua.
- Vani interni portautensili.
- 3 tasche frontali con mantella di protezione.
- 3 tasche posteriori.
- Maniglie con rivestimento in PVC.
- Cinghia di trasporto a tracolla.

€ 57,00

**€ 40,00**



MAX  
9 kg

CAPACITÀ  
8 L

**007 FLV**  
U00070007

470 g | mm | → 310  
↑ 220  
↙ 140

### Borsa portautensili (vuota)

- Tessuto ad altissima resistenza.
- Tasca frontale con chiusura a cerniera.
- Tasca posteriore con chiusura a velcro.
- Base rigida rinforzata.
- Vani interni portautensili.
- Maniglie con rivestimento in PVC.

€ 29,00

**€ 20,00**



MAX  
25 kg

CAPACITÀ  
9 L

**007 PLV**  
U00070034

1,7 kg | mm | → 450  
↑ 170  
↙ 180

### Borsa termoidraulico (vuota)

- Tessuto ad altissima resistenza.
- Base rigida rivettata per aumentare la resistenza al carico.
- Tasca portadocumenti interna.
- Può contenere un giratubi fino a 1 1/2".
- Gancio esterno ferma flessometro.
- Tracolla amovibile per un comfort extra nel trasporto.
- Due maniglie superiori per una migliore presa.
- Chiusura tramite velcro e fibbie a scatto con sgancio rapido.

€ 60,50

**€ 42,00**







MAX  
15 kg

CAPACITÀ  
8 L



L'apertura frontale consente un rapido accesso al contenuto.



**007 RV**  
U00070033

1,8 kg | mm → 460  
↓ 160  
↙ 350

### Borsa per utensili e PC (vuota)

- Tessuto ad altissima resistenza.
- Base rigida rinforzata.
- Può contenere Notebook di dimensioni L:340 mm - H:240 mm.
- 14 tasche, 2 cinghie portautensili e 1 gancio ferma flessometro.
- Tracolla amovibile per un comfort extra nel trasporto.
- Chiusura tramite fibbie a scatto con sgancio rapido.

~~€ 68,50~~

**€ 48,00**

MAX  
12 kg

CAPACITÀ  
30 L



Tasca porta Notebook o documenti



**007 SV**  
U00070004

3,1 kg | mm → 355  
↓ 225  
↙ 460

### Zaino portautensili (vuoto)

- Nylon ad altissima resistenza.
- Cinturino pettorale regolabile.
- Cinghie in vita imbottite.
- Base rigida resistente all'acqua.
- Vano interno portautensili.
- Portadocumenti interno.
- La tasca posteriore può contenere Notebook di dimensioni: L 340 mm - H 240 mm.

~~€ 97,50~~

**€ 69,00**

**007 TV**  
U00070006

3,5 kg | mm → 350  
↓ 500  
↙ 200

### Trolley portautensili (vuoto)

- Dimensioni bagaglio a mano (cabin size).
- Tessuto ad altissima resistenza.
- Pratici e comodi vani interni portautensili.
- Tasca frontale portadocumenti.
- Tasche laterali con cinghie per il trasporto di oggetti lunghi.
- Asta telescopica in alluminio.
- Ruote integrate nella struttura.
- Bretelle posteriori per il trasporto a spalla.
- La tasca posteriore può contenere Notebook di dimensioni L:340 mm - H:240 mm.

~~€ 121,00~~

**€ 85,00**

MAX  
14 kg

CAPACITÀ  
30 L



Tasca porta Notebook o documenti





MAX  
20 kg

4,7 kg | mm | 465  
352  
215



**001 RV**  
U00010004

### Valigia porta utensili in polipropilene ad alto spessore (vuota)

- Due pannelli interni amovibili con elastici portautensili.
- Vano inferiore con divisori amovibili e regolabili.
- Doppia serratura con chiave.

~~€ 293,00~~

**€ 205,00**

MAX  
20 kg

6 kg | mm | 465  
352  
255



**001 TRV**  
U00010005

### Valigia trolley porta utensili in polipropilene ad alto spessore (vuota)

- Maniglia telescopica in alluminio.
- Ruote con cuscinetto a sfera integrato.

~~€ 431,00~~

**€ 302,00**



5  
SCOMPARTI

6,6 kg | mm | 560  
320  
220



**646/5LV**  
U06460301

### Cassetta estensibile LUNGA (vuota)

- Predisposizione per lucchetto.
- Struttura in lamiera d'acciaio con verniciatura anaforetica.

~~€ 75,00~~

**€ 55,50**

8  
VASCHETTE

1,5 kg | mm | 422  
106  
335



**640 A**  
U06400001

### Organizer (vuoto)

- Coperchio trasparente: visibilità istantanea del contenuto.
- 8 vaschette interne amovibili di cui 1 suddivisibile tramite 2 divisori in dotazione.

~~€ 32,00~~

**€ 22,40**



**641 T**

### Cassetta portautensili (vuota)

- In materiale plastico ad alta resistenza.
- 2 scomparti portaminuteria sul coperchio.
- Possibilità di chiusura con lucchetto (non fornito).
- Vassoio interno amovibile.

	CODICE	L (mm)	P (mm)	H (mm)	kg	<del>€</del>	€
A	U06410004	16"	394	220	1,2 kg	<del>23,60</del>	<b>16,50</b>
B	U06410005	19"	486	266	2,1 kg	<del>35,40</del>	<b>24,80</b>
C	U06410006	24"	595	281	2,8 kg	<del>47,20</del>	<b>33,00</b>



## GIRAVITE ELETTRICO 324 XP

LA VELOCITÀ DELLA BATTERIA, LA SENSIBILITÀ DEL TUO POLSO.



**PORTAINSERTI  
MAGNETICO**  
con ghiera a  
sgancio rapido.



**IMPUGNATURA**  
ergonomica in gomma  
resistente ad olii e  
prodotti chimici.

**IEC 60529**



**ILLUMINAZIONE**  
a 5 LED frontali con  
autospegnimento a 10 secondi.



**SISTEMA DI BLOCCAGGIO**  
automatico del mandrino per  
applicare la coppia a mano.

**CE**  
**EN 60529**

**CARATTERISTICHE TECNICHE**

Vibrazioni (mm/s <sup>2</sup> )	1,4
Potenza sonora dB(A)	54
Dimensioni (mm)	170x39
Peso (gr)	245



**LITHIUM**

Batteria 3.6V al litio  
da 2 Ah.

<15%

15÷74%

75÷100%



**RICARICABILE**

LED di indicazione  
dello stato di carica.  
Carica completa in 70  
minuti (IN: 5V = 3A).

## AVVITA LUI. STRINGI TU.

**LA SUA VELOCITÀ**

Avvita e svita velocemente con i  
300 giri/min del motore elettrico.

**LA TUA SENSIBILITÀ**

Finisci il serraggio con la sensibilità  
di un giravite manuale.

**300**  
Giri/min

**0,9 Nm**

**10 Nm**



Nylon ad alta  
resistenza



Elastici portainseriti



1/4

**324 XP/B16**  
U03240801

**16**  
PEZZI

**Giravite elettrico in astuccio con inserti**

- Astuccio in nylon ad alta resistenza.
- Elastici portainseriti.
- Tasca interna per il cavo USB-C.
- Gancio per cintura.

€ 242,00

**€ 99,00**



## GIRAVITI 324 IL TOP DEL MERCATO.



### IMPUGNATURA TRIMATERIALE

- 1 Esterno in poliuretano resistente ad oli ed agenti chimici.
- 2 Corpo in poliammide resistente agli sforzi.
- 3 Interno in poliammide ad alta densità per un perfetto accoppiamento alla lama.

### LAMA RINFORZATA

Acciaio al cromo silicio vanadio per la massima resistenza meccanica.

### PUNTA AL TOP

Finitura zincata. Geometria perfetta. Trattamento anti corrosione.

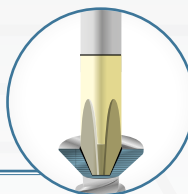

### RIVESTIMENTO SOFT GRIP

Miglior comfort durante l'uso. Maggior trasmissione della coppia.

### GEOMETRIA ANTI-ROTOLOAMENTO



YouTube



### 324 SH5 U03240645

Serie di 5 giraviti per viti con intaglio e impronta a croce PHILLIPS®

- 324/0,8x4x100-1x5,5x125.
- 324 PH/0x75-1x75-2x100.

€ 34,80

**€ 24,40**

5 PEZZI



### 324 SH8 U03240650

Serie di 8 giraviti per viti con intaglio e impronta a croce PHILLIPS®

- 324 D/0,4x2,5x50.
- 324/0,5x3x75-0,8x4x100-1x5,5x125-1,2x6,5x150.
- 324 PH/0x75-1x75-2x100.

€ 52,00

**€ 33,00**

8 PEZZI



### 324 SH12 U03240651

Serie di 12 giraviti per viti con intaglio, impronta a croce PHILLIPS® e impronta a croce POZIDRIV® - SUPADRIV®

- 324 D/0,4x2,5x50.
- 324/0,5x3x75-0,8x4x100-1x5,5x125-1,2x6,5x150.
- 324 N/1x5,5x35.
- 324 PH/0x75-1x75-2x100.
- 324 NPH/2x35.
- 324 PZ/1x75-2x100.

€ 88,00

**€ 58,00**

12 PEZZI



### 324 STX/S7 U03240662

Serie di 7 giraviti con impronta TORX® Tamper Resistant

- 324 STX T10x75-T15x75-T20x100-T25x100-T27x100-T30x125-T40x150.

€ 95,00

**€ 61,00**

7 PEZZI





## GIRAVITI 322

### QUALITÀ E CONVENIENZA.



7  
PEZZI



### 322 SH7

U03220254

Serie di 7 giraviti per viti con intaglio e impronta a croce PHILLIPS®

- 322//0,4x2x50-0,5x3x75-0,8x4x100-1,5,5x100-1,2x6,5x150.
- 322 PH/1x100-2x125.

€ 36,40

**€ 25,50**



10  
PEZZI



### 322 SH10

U03220255

Serie di 10 giraviti per viti con intaglio, impronta a croce PHILLIPS® e impronta a croce POZIDRIV®

- 322//0,4x2x50-0,5x3x75-0,8x4x100-1x5,5x100-1,2x6,5x150.
- 322 PH/0x75-1x100-2x125.
- 322 PZ/1x100-2x125

€ 54,00

**€ 37,80**

## GIRAVITI 091

### ISOLATI 1000 V - EN 60900.

**USAG SLIM**



5  
PEZZI

### 091 D/SH5

U00910119

Serie di 5 giraviti SLIM per viti con intaglio e per viti con impronta a croce PHILLIPS®

- 091 D/0,6x3,5x100-0,8x4x100-1x5,5x125.
- 091 DPH/1x100-2x125.

€ 58,00

**€ 40,60**



5  
PEZZI

### 091 SH5

U00910100

Serie di 5 giraviti per viti con intaglio e per viti con impronta a croce PHILLIPS®

- 091//0,5x3x75-0,8x4x100-1x5,5x125.
- 091 PH/1x100-2x125.

€ 47,60

**€ 33,30**



8  
PEZZI

### 091 SH8

U00910106

Serie di 8 giraviti per viti con intaglio, per viti con impronta a croce PHILLIPS® e impronta a croce POZIDRIV® - SUPADRIV®

- 091//0,5x3x75-0,8x4x100-1x5,5x125-1,2x6,5x150.
- 091 PH/1x100-2x125.
- 091 PZ/1x100-2x125.

€ 82,00

**€ 57,00**



YouTube

8  
PEZZI

1/4

**CRICCHETTO INTEGRATO**



**333 K/SH8**  
U03330142



**Assortimento COMBIDRIVE con inserti**

- Fornito con una selezione di 6 inserti da 1/4".

DESCRIZIONE	ARTICOLO/MISURA	PZ
Impugnatura Combidrive	333 K	1
Lama portainseriti magnetica	333 1/4 MG	1
Inserti ad intaglio	660/0,6x4,5-1x5,5	2
Inserti a croce PH	660 PH 1-2	2
Inserti esagonali	660 E 3-4	2

~~€ 61,00~~

**€ 41,30**



**CRICCHETTO INTEGRATO**



Fornito senza  
inserti USAG 660

10  
PEZZI

1/4

**333 K/SB10**  
U03330143



**Assortimento COMBIDRIVE in astuccio di nylon**

- Fornito con una selezione di lame.
- Include un astuccio da cintura in nylon.

DESCRIZIONE	ARTICOLO/MISURA	PZ
Impugnatura Combidrive	333 K	1
Lama portainseriti magnetica	333 1/4 MG	1
Lame reversibili ad intaglio	333 I 0,6x3,5-0,8x4/1x5,5-1,2x6,5	2
Lame reversibili a croce PH	333 PH 0-1/2-3	2
Lame reversibili TORX®	333 TX T8-T9 333 STX T10-T15/T20-T25/T30-T40	4

~~€ 108,00~~

**€ 73,00**

## CHIAVE 280 TQ CON PORTAINSERITI E PORTABUSSOLE.



YouTube



**210 mm  
di lunghezza**



**280 TQ**  
U02800800

**Chiave a T portainseriti**

- Doppio portainseriti esagonale magnetico da 1/4".
- Capacità massima del portainseriti: inserto per viti.
- esagonali incassate misura 6 mm oppure viti Torx misura T40.
- Estremità con quadro portabussole da 1/4".
- Acciaio speciale altamente legato al cromo vanadio.
- Esecuzione cromata.

~~€ 37,00~~

**€ 25,90**



**PORTAINSERITI  
MAGNETICO DA 1/4"**



**ATTACCO QUADRO DA  
1/4" PER BUSSOLE**



YouTube

## CHIAVI MASCHIO 280 T SICUREZZA GARANTITA.



**ACCIAIO SPECIALE**  
al cromo vanadio.



**CHIAVI USAG** **ALTRE CHIAVI**

### SICUREZZA GARANTITA

- +30% resistenza alla torsione rispetto alla norma ISO 2936.
- Raggiunta la coppia di rottura, la chiave si deforma senza spezzarsi.



**TRAVERSINO FISSO**  
Massima resistenza.

7  
PEZZI



**280 T/SE7**  
U02800903

Serie di 7 chiavi a T con maschio esagonale

- 280 T/2,5-3-4-5-6-8 mm.

~~€ 119,00~~

**€ 83,50**

8  
PEZZI



**280 TTX/SE8**  
U02800686

Serie di 8 chiavi a T per viti con impronta TORX®

- 280 TTX/T6-T7-T8-T9-T10-T15-T20-T25.

~~€ 169,00~~

**€ 119,00**

6  
PEZZI



**280 TTS/SE6**  
U02800760

Serie di 6 chiavi a T maschio esagonali con testa sferica

- 280 TTS/2,5-3-4-5-6-8 mm.

~~€ 105,00~~

**€ 73,00**



**Testa sferica**

6  
PEZZI



**280 TK/SE6**  
U02800020

Serie di 6 chiavi a T maschio esagonale con traversino scorrevole

- 280 TK/2,5-3-4-5-6-8 mm.

~~€ 108,00~~

**€ 76,00**

**Traversino scorrevole**



## CHIAVI MASCHIO 280 HG CON IMPUGNATURA ERGONOMICA.



### SICUREZZA GARANTITA

- +30% resistenza alla torsione rispetto alla norma ISO 2936.
- Raggiunta la coppia di rottura, la chiave si deforma senza spezzarsi.

**Stessa lama  
delle chiavi 280 T**



**IMPUGNATURA BIMATERIALE  
ERGONOMICA.**

**ACCIAIO SPECIALE  
AL CROMO VANADIO.**

**6  
PEZZI**



**280 HG/SE6**

**U02801460**

Serie di 6 chiavi maschio esagonale con impugnatura

- 280 HG/2,5-3-4-5-6-8 mm.

~~€ 79,00~~

**€ 55,00**

**6  
PEZZI**



**280 HGTS/SE6**

**U02801463**

Serie di 6 chiavi maschio esagonale a testa sferica con impugnatura

- 280 HGTS/2,5-3-4-5-6-8 mm.

~~€ 87,00~~

**€ 61,00**

**6  
PEZZI**



**280 HAP/SE6**

**U02800462**

Serie di 6 chiavi maschio esagonale in pollici con impugnatura

- 280 HAP/1/4-7/32-5/32-5/16-3/8-3/16".

~~€ 78,00~~

**€ 54,50**

**6  
PEZZI**



**280 HATX/SE6**

**U02800464**

Serie di 6 chiavi maschio con impugnatura per viti con impronta TORX®

- 280 HATX/T8-T10-T15-T20-T25-T30.

~~€ 61,00~~

**€ 42,70**



**32**  
PEZZI



280 g | mm | 138  
30  
98



**692 J32**

**U06920042**

### Assortimento di inserti con cricchetto

DESCRIZIONE	MISURA	PZ.
Inserti ad intaglio	4-5,5-6,5-8	4
Inserti a croce PHILLIPS®	PH 1-2-3	3
Inserti a croce POZIDRIV®	PZ 1-2-3	3
Inserti esagono maschio	3-4-5-6	4
Inserti TORX®	T8-10-15-20-20-25-25-30-40	9
Inserti TORX® Tamper Resistant	STX 10-15-20-25-27-30-40	7
Portainseri magnetico		1
Cricchetto		1

~~€ 55,00~~

**€ 38,50**



**49**  
PEZZI



280 g | mm | 138  
30  
98



**692 J49**

**U06920041**

### Assortimento di inserti

DESCRIZIONE	MISURA	PZ.
Inserti ad intaglio	4-4,5-5,5-6,5-6,5-8	6
Inserti a croce PHILLIPS®	PH 1-1-2-2-2-3	6
Inserti a croce POZIDRIV®	PZ 1-1-2-2-2-3-3	7
Inserti esagono maschio	2-3-3-4-4-5-5-6-6	9
Inserti TORX®	TX 10-10-15-15-20-20-25-25-30-30	10
Inserti TORX® Tamper Resistant	STX 10-15-15-20-20-25-25-30-30-40	10
Portainseri magnetico		1

~~€ 42,60~~

**€ 29,80**



Riconoscimento dell'inserto con codice colore per una scelta rapida



-----50 mm-----



**664 S25**

**U06640111**

### Assortimento di inserti per avvitatura

• Fornito in cassetta di plastica

DESCRIZIONE	MISURA	PZ.
Inserti lunghi ad intaglio	3-4-5-6	4
Inserti lunghi a croce PH	1-2(x2)-3(x1)	5
Inserti lunghi a croce PZ	1-2(x2)-3(x1)	5
Inserti lunghi TORX®	T15-T20-T25-T30-T40	5
Inserti lunghi esagonali	2-3-4-5-5,5	5
Portainseri magnetico		1

~~€ 68,50~~

**€ 47,90**

**25**  
PEZZI



800 g | mm | 215  
45  
150

**664 B/S7**

**U06640015**

### Assortimento di inserti a bussola

• Fornito in cassetta di plastica

~~€ 36,70~~

**€ 25,70**



**7**  
PEZZI



**5,5-6-7-8**  
**10-12-13 mm**

300 g | mm | 138  
30  
98





900 g | 215 mm  
45 mm | 150

DESCRIZIONE	MISURA	PZ.
Inserti a intaglio	3-4-4,5-5-5,5-6-6,5-7-8	9
Inserti a croce	PH 00-0-1-1-2-2-3-4 PZ 1-2-2-3-4	13
Inserti esagono maschio	1,5-2-2,5-3-4-5-5,5-6-7-8 mm 1/16-5/64-3/32-7/64-1/8-9/64-5/32-3/16-7/32-1/4"	20
Inserti TORX®	T 8-9-10-15-20-25-27-30-40-45	10
Inserti TORX® Tamper Resistant	STX 8-10-15-20-25-27-30-35-40	9
Inserti Tri-Wing	1-2-3-4	4
Inserti Spanner	4-6-8-10-12	5
Inserti Torq-set	6-8-10	3
Inserti quadrati	0-1-2-2-3	5
Inserti Clutch	1/8-5/32-3/16-1/4-5/16	5
Inserti XZN	M5-M6-M8	3
Inserti esagono maschio con foro	2-2,5-3-4-5-6 mm - 5/64-3/32-7/64-1/8-9/64-5/32"	12
Portainseri magnetici	1/4x60mm	2

**692 J100**  
U06920043

**Assortimento di inserti con impronte speciali**

~~€ 65,50~~

**€ 45,80**

**100**  
PEZZI

1/4



**SUPPORTI COMPATTI CON SISTEMA DI ESTRAZIONE RAPIDA**



**Guarda il video dimostrativo**



YouTube



**9**  
PEZZI



**280 LTS/S9**  
U02800084

**Serie di 9 chiavi maschio esagonale lunghe testa sferica**

- 280 LTS/1,5-2-2,5-3-4-5-6-8-10 mm.

~~€ 33,90~~

**€ 21,50**



**8**  
PEZZI



**280 LTSTX/S8**  
U02800078

**Serie di 8 chiavi maschio lunghe testa sferica TORX®**

- 280 LTSTX/T10-T15-T20-T25-T27-T30-T40-T45.

~~€ 61,50~~

**€ 43,00**



**9**  
PEZZI



**280 XLTS/S9**  
U02800184

**Serie di 9 chiavi maschio esagonale extra-lunghe a testa sferica**

- 280 XLTS/1,5-2-2,5-3-4-5-6-8-10 mm.

~~€ 37,60~~

**€ 26,40**



## GAMMA PINZE "AX" FINITURA CROMATA ED IMPUGNATURE BIMATERIALE.



Taglia fino a Ø 2 mm di filo armonico con il 30% in meno di forza rispetto al valore massimo indicato dalle normative europee ISO5749 (tronchesi) - ISO5746 (pinze).

YouTube



**TAGLIENTI TEMPRATI AD INDUZIONE**  
per la massima efficacia nel taglio del filo armonico.



**FULCRO PIÙ VICINO AI TAGLIENTI**  
per il minimo sforzo durante il taglio.

**IMPUGNATURE ERGONOMICHE BIMATERIALE**

IMPUGNATURA USAG



- SFORZO

PRODOTTI SUL MERCATO



+ SFORZO

Minimo sforzo risultante dagli studi sugli sforzi muscolari effettuati dal prestigioso istituto americano US Ergonomics.

3 PEZZI



**150 AX/SE3**  
U01500201

**Assortimento pinze e tronchesi**

- Pinza universale 150 AX 180.
- Pinza a becchi mezzotondi lunghissimi diritti 133 AX 160.
- Tronchese a grande effetto a tagliente diagonale 188 AX 160.

~~€ 96,50~~

**€ 68,00**

3 PEZZI



**1000 V**

**085 EX/SE3**  
U00850121

**Assortimento pinze e tronchesi isolati 1000 V**

- Pinza universale 085 EX 180.
- Pinza a becchi mezzotondi lunghissimi diritti 081 EX 160.
- Tronchese a grande effetto a tagliente diagonale 087 EX 160.

~~€ 130,00~~

**€ 91,00**

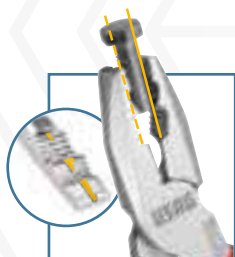

**PROFILI TONDI**

Intaglio ricavato nella dentatura per una presa sicura di barre tonde, anche filettate.

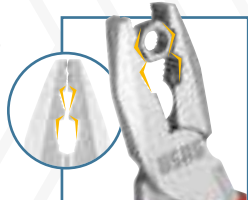

**PROFILI ESAGONALI**

Geometria delle ganasce studiata per la presa di un esagono.

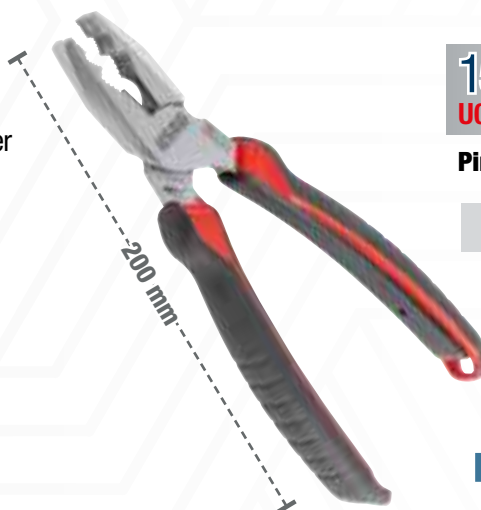

**155 AX**  
U01550001

**Pinza universale multifunzione**

~~€ 59,50~~

**€ 35,00**

**Pinza multifunzione**

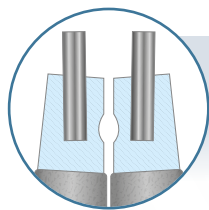

## MASSIMA RESISTENZA

Punte in acciaio armonico inserite nei becchi.

4

PEZZI



4

PEZZI



127 N/SE4S

U01270046

Misure  
piccole

Serie 4 pinze per anelli elastici

- Pinze per anelli elastici interni 127 N 12÷25-127 PN 12÷25.
- Pinze per anelli elastici esterni 128 N 10÷25-128 PN 10÷25.

€ 97,50

€ 68,50

127 N/SE4

U01279000P

Misure  
grandi

Serie 4 pinze per anelli elastici

- Pinze per anelli elastici interni 127 N 19÷60-127 PN 19÷60.
- Pinze per anelli elastici esterni 128 N 19÷60-128 PN 19÷60.

€ 106,00

€ 74,00

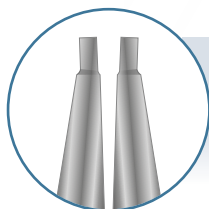

## MASSIMA ACCESSIBILITÀ

Punte e becchi in corpo unico.

4

PEZZI



4

PEZZI



127 C/SE4S

U01270045

Misure  
piccole

Serie 4 pinze per anelli elastici

- Pinze per anelli elastici interni 127 C 12÷25-127 CP 12÷25.
- Pinze per anelli elastici esterni 128 C 10÷25-128 CP 10÷25.

€ 81,00

€ 56,50

127 C/SE4

U01270040

Misure  
grandi

Serie 4 pinze per anelli elastici

- Pinze per anelli elastici interni 127 C 19÷60-127 CP 19÷60.
- Pinze per anelli elastici esterni 128 C 19÷60-128 CP 19÷60.

€ 88,50

€ 62,00



## PINZA CHIAVE 174 CX PINZA E CHIAVE IN UN UNICO UTENSILE.

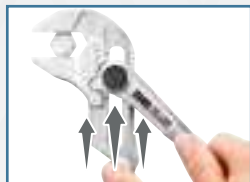

**SISTEMA  
DI CHIUSURA RAPIDA**  
senza premere il pulsante.

**CAPACITÀ MAX.  
58 mm**

**SCALA MILLIMETRATA**

**CREMAGLIERA CON  
20 POSIZIONI**

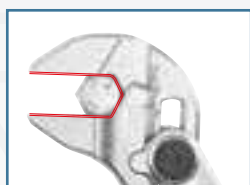

**BECCHI PIATTI E PARALLELI**  
Battuta sagomata  
per far presa su 4 lati dell'esagono.



**GANASCE SOTTILI**

**174 CX**  
U01740001

**Pinza chiave regolabile**  
• Lunghezza 250 mm.

€ 74,00

**€ 52,00**



YouTube



**CAPACITÀ MAX.  
80 mm**

**135 B**  
U01350510

**Pinza regolabile autobloccante a cremagliera con ganasce lunghe**

- Ganasce forgiate.
- Dentatura studiata per una presa perfetta anche su tondo.
- Sistema di apertura brevettato ed integrato nei manici.
- Rullino di regolazione della presa integrato sul manico superiore.
- Cremagliera a 5 posizioni.

€ 75,50

**€ 53,00**



**MANICI RIVESTITI  
IN PVC**



**TAGLIO RASO**



**PER MATERIALE  
PLASTICO**

**186 C**

**Tronchesi a tagliente raso diagonale per materiali plastici**

- Becchi arrotondati ribassati.
- Molla di richiamo.
- Manici rivestiti con guaina in PVC.

CODICE	L	TAGLIENTI
--------	---	-----------

U01860060	150 mm	22 mm
-----------	--------	-------

€ 38,50

**€ 23,90**

U01860061	180 mm	27 mm
-----------	--------	-------

€ 43,30

**€ 27,30**

**APERTURA  
MAGGIORATA +20%**



YouTube

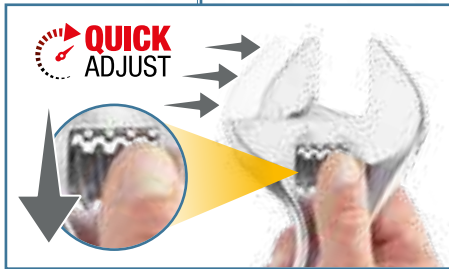

**ARRETRI IL RULLINO,  
REGOLI RAPIDAMENTE.**

**RUOTI IL RULLINO,  
REGOLI CON PRECISIONE.**

## 294 AD

### Chiavi a rullino con regolazione rapida

- Si regola rapidamente arretrando il rullino.
- Grande capacità: apertura +20% rispetto allo standard.
- Doppia scala graduata: millimetri e pollici.
- Testa inclinata di 22°.
- Rullino in acciaio.
- Asola di aggancio.
- Finitura cromata.

CODICE	L	APERTURA	<del>€</del>	€
U02940011	110 mm - 4"	17 mm	€ 19,30	€ 13,50
U02940012	150 mm - 6"	23 mm	€ 20,30	€ 14,20
U02940013	200 mm - 8"	33 mm	€ 24,20	€ 17,00
U02940014	250 mm - 10"	38 mm	€ 30,70	€ 21,50
U02940015	300 mm - 12"	41 mm	€ 40,40	€ 28,30
U02940016	380 mm - 15"	50 mm	€ 74,00	€ 52,00
U02940017	460 mm - 18"	63 mm	€ 122,00	€ 85,50

**APERTURA  
MAGGIORATA +20%**



YouTube



### INVERTI

**LA GANASCIA MOBILE**  
per passare dalla presa su esagono a quella su tondo.

**POSIZIONE  
STANDARD**

**GANASCIA  
INVERTITA**

## 294 AG

### Chiavi a rullino reversibili con impugnatura

- Nella posizione standard può manovrare un profilo esagonale.
- Invertendo il dente mobile, può manovrare un profilo tondo.
- Grande capacità: apertura +20% rispetto allo standard.
- Doppia scala graduata: millimetri e pollici.
- Impugnatura ergonomica bimatériauale.
- Testa inclinata di 22°.
- Rullino in acciaio.
- Asola di aggancio.
- Finitura cromata.

CODICE	L	APERTURA	<del>€</del>	€
U02940023	200 mm - 8"	33 mm	€ 26,50	€ 18,60
U02940024	250 mm - 10"	38 mm	€ 33,80	€ 23,60
U02940025	300 mm - 12"	41 mm	€ 44,40	€ 31,10

**APERTURA  
MAX 34 mm**



## 294 AC

U02940010

### Chiave regolabile a rullino corta

- Lunghezza ridotta del 46% rispetto ad una chiave standard.
- Apertura ganasce pari ad una chiave a rullino da 12".
- Leggera e compatta per un'ottima accessibilità.
- Regolazione tramite rullino in acciaio.
- Scala millimetrata sulla testa della chiave.
- Finitura cromata.

~~€ 24,10~~

**€ 16,90**

**-46%**

**LUNGHEZZA RIDOTTA  
DEL 46% RISPETTO AD  
UNA CHIAVE STANDARD**







## CHIAVE COMBINATA 285 X PERFETTA SU ESAGONI NUOVI, EFFICACE SU ESAGONI DANNEGGIATI.

### FORCHETTA INCLINATA

Angolo di 15° rispetto all'asse della chiave.



### SEZIONE A DOPPIA T

Massima resistenza alla flessione.

### OCCHIO DISASSATO

Per dadi e bulloni incassati in posizioni di difficile accesso.

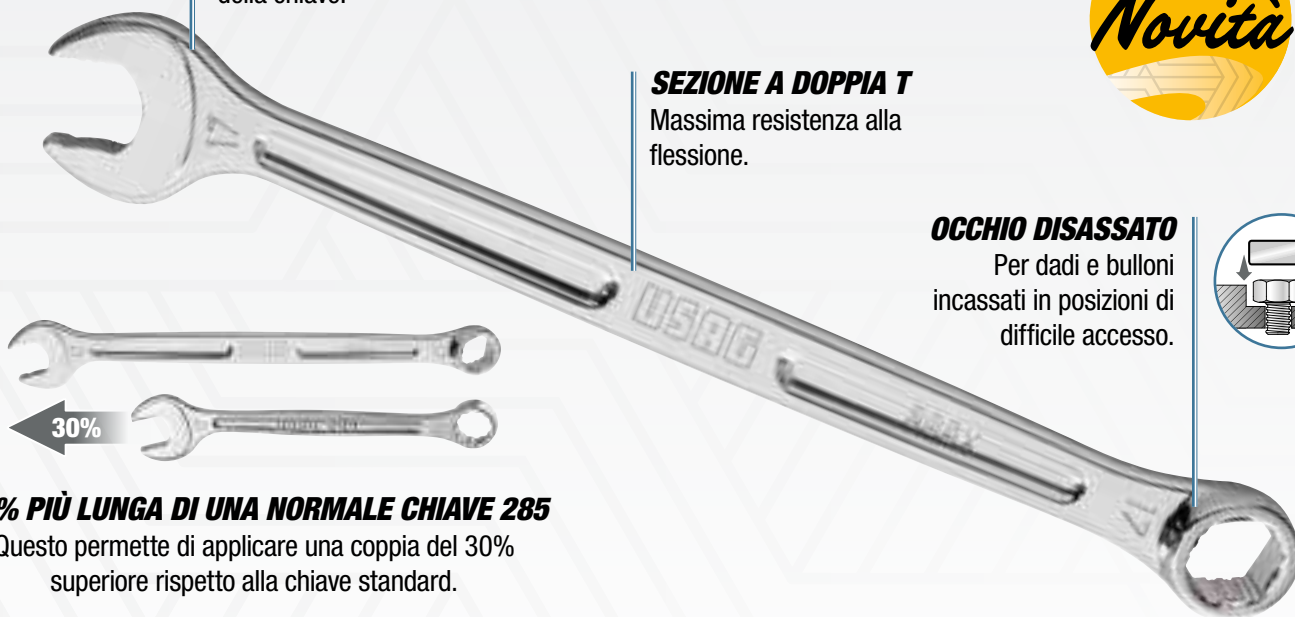
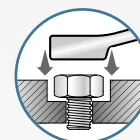

### 30% PIÙ LUNGA DI UNA NORMALE CHIAVE 285

Questo permette di applicare una coppia del 30% superiore rispetto alla chiave standard.

### PROFILI SPECIALI

Il profilo interno di forchetta ed anello, è studiato per manovrare esagoni nuovi e lavorare con efficacia anche su esagoni molto danneggiati.



8  
PEZZI

**285 X/B8**  
U02850950

- Serie di 8 chiavi combinate**
- 285 X/8-10-11-12-13-14-17-19 mm.
  - Fornita in busta in tessuto in alta resistenza.

8÷19 mm

€ 115,00

**€ 79,00**

12  
PEZZI

**285 X/SE12**  
U02850951

- Serie di 12 chiavi combinate**
- 285 X/8-9-10-11-12-13-14-15-16-17-18-19 mm.

8÷19 mm

€ 161,00

**€ 113,00**



## CHIAVE COMBINATA 285 RESISTENTE ED ERGONOMICA.



YouTube

### FORCHETTA INCLINATA

Angolo di 15° rispetto all'asse della chiave.

### SEZIONE A DOPPIA T

Massima resistenza alla flessione.

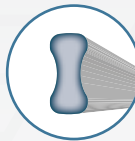

### OCCHIO DISASSATO

Per dadi e bulloni incassati in posizioni di difficile accesso.

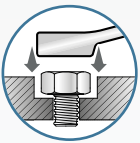

### TOP PERFORMANCE

Resistenza alla torsione statica di anello e forchetta: **+50%** rispetto alla norma ISO 1711-1.

**ISO 1711-1**  
**SAE AS 954E**



8  
PEZZI

8÷19 mm

**285 DS8**

U02850863

Serie di 8 chiavi combinate

- 285/8-10-11-12-13-14-17-19 mm.
- Fornita con supporto in plastica.

€ 78,50

**€ 51,00**

12  
PEZZI

7÷19 mm

**285 DS12**

U02850864

Serie di 12 chiavi combinate

- 285/7-8-10-11-12-13-14-15-16-17-18-19 mm.
- Fornita con supporto in plastica.

€ 116,00

**€ 79,00**

### MISURE IN POLLICI

1/4÷9/16"

**285 P/SE5**

U02850856

Serie di 26 chiavi combinate in pollici

- 285 P/ 1/4-3/8-7/16-1/2-9/16".

€ 45,40

**€ 31,00**

5  
PEZZI



6÷32 mm

**285 SE26**

U02850861

Serie di 26 chiavi combinate

- 285/6-7-8-9-10-11-12-13-14-15-16-17-18-19-20-21-22-23-24-25-26-27-28-29-30-32 mm.

€ 347,00

**€ 236,00**

26  
PEZZI



## CHIAVE A CRICCHETTO 285 KA CON ANELLO DI TENUTA INTEGRATO.

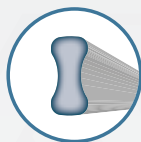

### SEZIONE A DOPPIA T

Massima resistenza alla flessione.

### POSIZIONE OTTIMALE



### ANELLO IN ACCIAIO ARMONICO INTEGRATO NELL'OCCHIO POLIGONALE

Mantiene la posizione sul dado durante la manovra.



### FORCHETTA CON SISTEMA ANTISLITTAMENTO DEL DADO

Maggiore tenuta durante la manovra.

### CRICCHETTO RESISTENTE

Resistenza alla torsione statica del cricchetto: +50% rispetto alla norma ISO 1711-1.



YouTube

8

PEZZI



8÷19 mm



### 285 KA/DS8

U02856058

Serie di 8 chiavi combinate a cricchetto con anello di tenuta

- 285 KA/8-10-11-12-13-14-17-19 mm.
- Fornita con supporto in plastica.

€ 157,00

**€ 105,00**

12

PEZZI



7÷19 mm



### 285 KA/DS12

U02856062

Serie di 12 chiavi combinate a cricchetto con anello di tenuta

- 285 KA/7-8-10-11-12-13-14-15-16-17-18-19 mm.
- Fornita con supporto in plastica.

€ 238,00

**€ 167,00**



## CHIAVE A CRICCHETTO SNODATA 285 KF



**5** PEZZI **8÷19 mm**

**285 KF/SE5**  
U02856160

Serie di 5 chiavi combinate a cricchetto snodate

- 285 KF/8-10-13-17-19 mm.

~~€ 111,00~~ **€ 77,50**



**8** PEZZI **8÷19 mm**

**285 KF/DS8**  
U02856158

Serie di 8 chiavi combinate a cricchetto snodate

- 285 KF/8-10-11-12-13-14-17-19 mm.
- Fornita con supporto in plastica.

~~€ 184,00~~ **€ 129,00**

## CHIAVE A CRICCHETTO PIATTA 285 KB



**7** PEZZI **8÷19 mm**

**285 KB/DS7**  
U02856341

Serie di 7 chiavi combinate a cricchetto piatte

- 285 KB/8-10-12-13-14-17-19 mm.
- Fornita con supporto in plastica.

~~€ 108,00~~ **€ 75,00**



**12** PEZZI **8÷19 mm**

**285 KB/DS12**  
U02856342

Serie di 12 chiavi combinate a cricchetto piatte

- 285 KB/8-9-10-11-12-13-14-15-16-17-19 mm.
- Fornita con supporto in plastica.

~~€ 185,00~~ **€ 127,00**

Just **USAG**

## CHIAVE COMBINATA 285 J



**FORCHETTA  
INCLINATA DI 15°**



**TESTA POLIGONALE  
PIEGATA DI 15°**

**Novità**

**7  
PEZZI**

**8÷19 mm**

**285 J/DS7**  
U02851745

- Serie di 7 chiavi combinate**
- 285 J/8-10-12-13-14-17-19 mm.
  - Fornita con supporto in plastica.

~~€ 56,00~~

**€ 39,00**

**Novità**

**12  
PEZZI**

**8÷19 mm**

**285 J/DS12**  
U02851746

- Serie di 12 chiavi combinate**
- 285 J/8-9-10-11-12-13-14-15-16-17-19 mm.
  - Fornita con supporto in plastica.

~~€ 93,00~~

**€ 59,00**

**8  
PEZZI**

**6÷22 mm**



**252 N/SR8**  
U02520862

- Serie di 8 chiavi a forchetta doppia**
- 252 N/6x7-8x9-10x11-12x13-14x15-16x17-18x19-20x22 mm.

~~€ 60,00~~

**€ 42,20**

**8  
PEZZI**

**7÷19 mm**

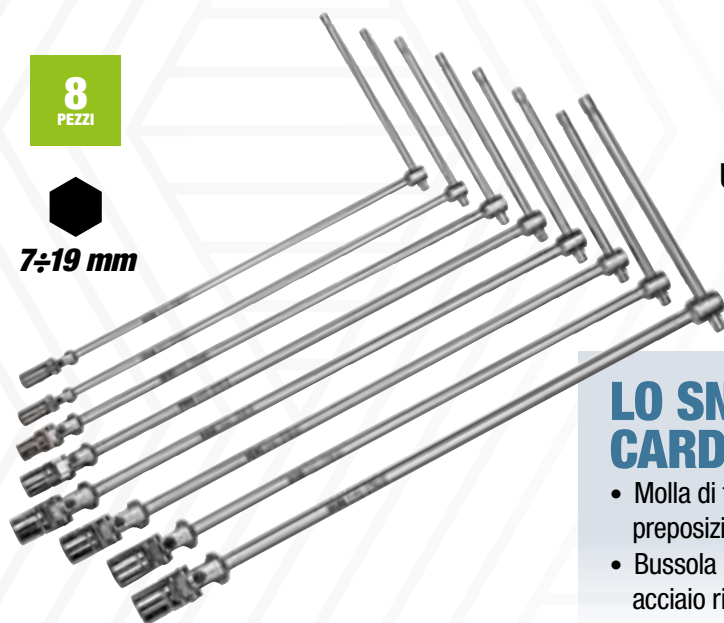

**UNI 6743**

**276 CE/SE8**  
U02760484

- Serie di 8 chiavi a T snodate**
- 276 CE/7-8-10-12-13-14-17-19 mm.

~~€ 306,00~~

**€ 245,00**

### LO SNODO CARDANICO USAG

- Molla di frizione interna per il perfetto preposizionamento della bussola.
- Bussola e cardano fissati con un perno in acciaio ribadito per la massima affidabilità.





38  
PEZZI

1/4''



900 g | 155 mm | 50 mm | 95 mm

## 609 1/4'' EB

U06090002

### Assortimento con bussole esagonali ed inserti per avvitatura

• Cassetta compatta in bimatériale con rivestimento soft-touch.

DESCRIZIONE	ART./MISURA	PZ.
Bussole esagonali	235 1/4" EN 5,5-6-7-8-9-10-11-12-13-14 mm	10
Prolunghe	236 1/4" 50-100	2
Cricchetto reversibile	237 B 1/4"	1
Snodo cardanico	241 1/4"	1
Impugnatura porta-bussole	243 1/4"	1
Inserti ad intaglio	660 0,6x4,5-1x5,5-1,2x6,5	3
Inserti PH	660 PH 1-2-3	3
Inserti PZ	660 PZ 1-2-3	3
Inserti esagonali	660 E 2-3-4-5-6	5
Inserti Torx® Tamper Resistant	660 STX T10-T15-T20-T25-T27-T30-T40	7
Inserto porta-bussole	660 Q 1/4"	1
Bussola porta-inserti	684 1/4"-1/4"	1



YouTube

€ 212,00

**€ 148,00**



YouTube

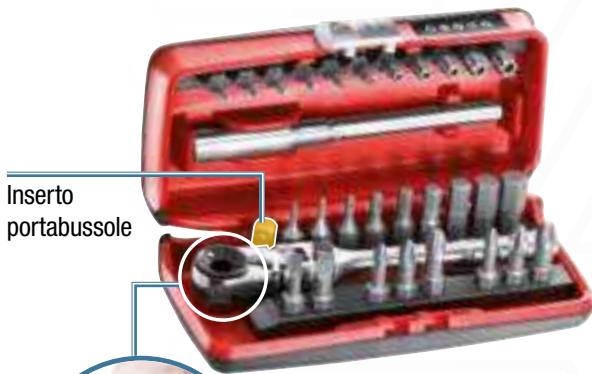

Inserto portabussole



31  
PEZZI

1/4''



350 g | 120 mm | 35 mm | 65 mm

## 606 1/4'' SK

U06060012

### Assortimento inserti con cricchetto reversibile

DESCRIZIONE	ART./MISURA	PZ.
Cricchetto reversibile	237 1/4" SFK	1
Inserti ad intaglio	660 0,5x4-1x5,5	2
Inserti esagonali	660 E 1,5-2-2,5-3-4-5-6-7-8	9
Inserti a croce Phillips®	660 PH 1-2-3	3
Inserti a croce Pozidriv®- SUPadriv®	660 PZ 1-2-3	3
Raccordo portainseriti	660 Q 1/4"	1
Inserti TORX® Tamper Resistant	660 STX T10-T15-T20-T25-T27-T30-T40	7
Inserti TORX®	660 TX T6-T7-T8-T9	4
Prolunga magnetica	672 1/4" MG 100	1

€ 73,50

**€ 51,50**



YouTube



11 mm



11  
PEZZI

1/4''

265 g | 120 mm | 35 mm | 65 mm

5,5-6-7-8-9-10-11-12-13-14 mm

## 610 1/4'' EFK

U06100001

### Assortimento bussole ribassate con cricchetto reversibile

€ 88,50

**€ 62,00**

#### BUSSOLE ESAGONALI RIBASSATE

Garantiscono il doppio dell'accessibilità rispetto all'utilizzo di un cricchetto standard.

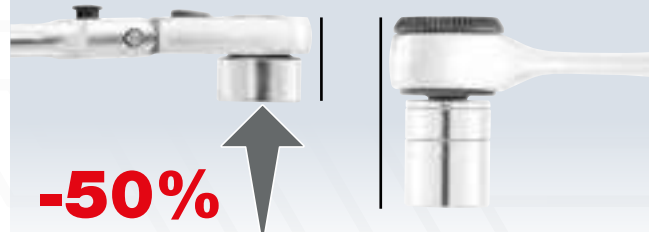

**-50%**



## CRICCHETTO 237 A CON MECCANISMO SIGILLATO IP51.



Sistema di inversione integrato nel coperchio



Spessore della testa ridotto rispetto ai modelli standard -10%



YouTube



**IMPUGNATURA CONICA**  
in bimateriale e antiscivolo.

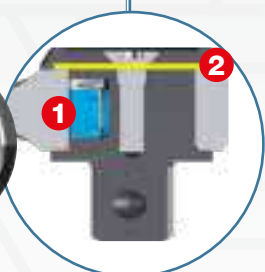

1. Nottolino brevettato.
2. Diaframma protettivo.

### TOP PERFORMANCE

1. Resistenza alla torsione statica: +30% di coppia rispetto alla norma ISO 3315 grazie al nottolino brevettato.
2. Resistenza a fatica: dura il doppio dei normali cricchetti del mercato grazie alla protezione IP51.



23 PEZZI

1 1/2"



3 kg | mm | 330  
60  
215

606 1/2" EA  
U06060302

#### Assortimento in cassetta di ABS con bussole esagonali

- Cassetta in ABS ad alta resistenza con sistema di chiusura rapida.

DESCRIZIONE	ART./MISURA	PZ.
Chiavi a bussola con bocca esagonale	235 1/2 EN 8-9-10-11-12-13-14-15-16-17-18-19-21-22-23-24-27-30-32	19
Prolunghe	236 1/2 125-250	2
Snodo cardanico	241 1/2	1
Cricchetto reversibile certificato IP51	237 A 1/2	1

~~€ 254,00~~

**€ 153,00**



19 PEZZI

1 1/4"



1 kg | mm | 210  
60  
130

606 1/4" EA  
U06060101

#### Assortimento in cassetta di ABS con bussole esagonali

- Cassetta in ABS ad alta resistenza con sistema di chiusura rapida.

DESCRIZIONE	ART./MISURA	PZ.
Chiavi a bussola con bocca esagonale	235 1/4 EN 4-4,5-5-5,5-6-7-8-9-10-11-12-13-14	13
Prolunghe	236 1/4 50-100	2
Snodo cardanico	241 1/4	1
Leva a T con attacco quadro scorrevole	240 1/4	1
Portabussole con impugnatura	243 1/4	1
Cricchetto reversibile certificato IP51	237 A 1/4	1

~~€ 134,00~~

**€ 80,00**

## IL TOP PER GLI SPAZI RISTRETTI



**608 1/4" EAK**  
U06080305

↔ 435  
↑ 70  
↙ 270  
mm

**50**  
PEZZI

**1/4"**



**Assortimento in cassetta di ABS con prolunghe, cricchetto e bussole esagonali**

- Cassetta in ABS ad alta resistenza con sistema di chiusura rapida.

DESCRIZIONE	ART./MISURA	PZ.
Chiavi a bussola con bocca esagonale	235 1/4 EN 4-4,5-5-5,5-6-7-8-9-10-11-12-13-14	13
Cricchetto con impugnatura rotante	237 1/4 AK	1
Portabussole con impugnatura	243 1/4	1
Portabussole flessibile con impugnatura	243 1/4 SN	1
Chiave a T con attacco quadro snodato	273 1/4 Q	1
Assortimento inserti con cricchetto reversibile - mini kit	606 1/4 SK	31
Raccordo aumentatore	247 1/4	1
Bussole portainserti	684/1	1

~~€ 278,00~~

**€ 183,00**



1/4



Chiave a T snodata



Impugnatura con lama flessibile



Cricchetto con Impugnatura rotante



Cricchetto porta inserti snodato

## CRICCHETTI CON IMPUGNATURA ROTANTE

**1/4"**

**237 1/4" AK**  
U02370003

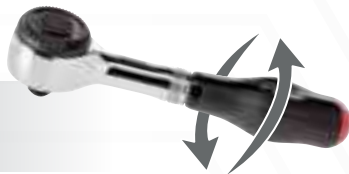

**Cricchetto reversibile 1/4" con impugnatura rotante**

~~€ 53,50~~

**€ 37,40**

**1/2"**

**237 1/2" AK**  
U02370009

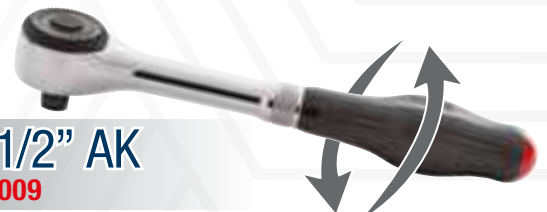

**Cricchetto reversibile 1/2" con impugnatura rotante**

~~€ 87,50~~

**€ 61,00**



**17**  
PEZZI

**3/4"**



**612 3/4" EB**  
U06120017



↔ 425  
↑ 83  
↙ 395  
13 kg mm

**Assortimento in cassetta di lamiera con bussole esagonali**

DESCRIZIONE	ART./MISURA	PZ.
Chiavi a bussola con bocca esagonale	235 3/4 N 22-23-24-26-27-28-30-32-36-38-41-46-50	13
Prolunghe	236 3/4 200-400	2
Leva a T scorrevole	240 3/4 N	1
Cricchetto reversibile con meccanismo sigillato 120 denti	237 B 3/4	1

~~€ 583,00~~

**€ 407,00**

**612 3/4" B**  
U06120016



**BUSSOLE POLIGONALI**

**Assortimento in cassetta di lamiera con bussole poligonali**

~~€ 586,00~~

**€ 407,00**



**16**  
PEZZI

1/2"

1/4"



1 kg | mm | 190  
58  
144

## 601 1/4-1/2" JTX16

U06010009

**Assortimento in cassetta modulare con bussole TORX®**

DESCRIZIONE	MISURA	PZ.
Chiavi a bussola 1/4 TORX®	E6-E7-E8-E10	4
Chiavi a bussola 1/2 TORX®	E12-E14-E16-E18	4
Chiavi a bussola 1/4 con inserto TORX®	T10-T15-T20-T25	4
Chiavi a bussola 1/2 con inserto TORX®	T30-T40-T45-T50	4

~~€ 41,00~~

**€ 28,80**



**34**  
PEZZI

1/4"



1 kg | mm | 190  
58  
144

## 601 1/4" J34

U06010001

**Assortimento in cassetta modulare con bussole esagonali ed inserti per avvitatura**

DESCRIZIONE	MISURA	PZ.
Chiavi a bussola 1/4"	4-4,5-5-5,5-6-7-8-9-10-11-12-13-14	13
Cricchetto reversibile 1/4"		1
Snodo cardanico 1/4"		1
Prolunghe 1/4"	55-100	2
Inserti a intaglio	4-5,5-6	3
Inserti a croce POZIDRIV®	1-2-3	3
Inserti esagono maschio	4-5-6	3
Inserti TORX®	T10-T15-T20-T25-T30-T40	6
Impugnatura maschio/femmina		1
Raccordo portainseri 1/4"		1

~~€ 66,50~~

**€ 46,00**



**22**  
PEZZI

1/2"



4 kg | mm | 375  
80  
186

## 601 1/2" J22

U06010003

**Assortimento in cassetta modulare con bussole esagonali**

DESCRIZIONE	MISURA	PZ.
Bussole esagonali 1/2"	8-10-11-12-13-14-15-16-17-18-19-21-22-24-27-30-32	17
Cricchetto 1/2"		1
Prolunghe 1/2"	130-250	2
Snodo cardanico 1/2"		1
Leva a T 1/2"		1

~~€ 116,00~~

**€ 75,00**



LA QUALITÀ **USAG** A UN PREZZO *Just*



1/4"

1/2"

8 kg | 415 mm | 92 | 283

100 PEZZI



601 1/4-1/2" J100

U06010011

Assortimento in cassetta modulare con bussole esagonali ed inserti per avvitatura

~~€ 192,00~~

**€ 129,00**

Modulare con i cassettei dei carrelli USAG!

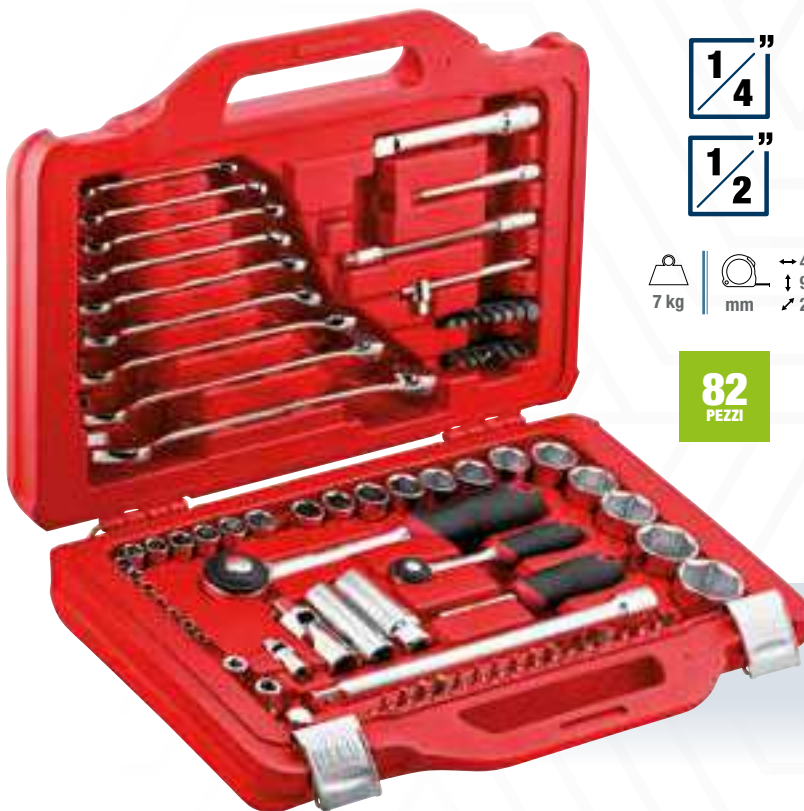

1/4"

1/2"

7 kg | 415 mm | 92 | 283

82 PEZZI



601 1/4-1/2" J82

U06010010

Assortimento in cassetta modulare con bussole esagonali e chiavi combinate

~~€ 291,00~~

**€ 149,00**

Modulare con i cassettei dei carrelli USAG!



## BARRE DINAMOMETRICHE 811 LB

### L'EQUILIBRIO PERFETTO TRA PRECISIONE E RESISTENZA.



#### ATTACCO RAPIDO

9X12 o 14X18 per accessori e teste a cricchetto.

#### ISO 6789

#### SCALA GRADUATA

incisa sul tubo in acciaio.

#### NONIO

in acciaio.

#### GHIERA DI REGOLAZIONE

con ritorno automatico.

#### MECCANISMO A SCATTO

con molla di compressione.



#### IMPUGNATURA

in bimatereale antiscivolo.

Precisa  
**± 2%**

**PRECISIONE TESTATA  
IN FABBRICA.**

Resistente  
**50.000 scatti**

**TEST DI RESISTENZA  
DEL MECCANISMO.**

Come da Normativa ISO 6789, le barre dinamometriche USAG 811 LB sono testate una ad una in produzione, prima di essere confezionate.

Queste barre riescono a mantenere una soglia di precisione tra il ±2% ed il ±4% anche dopo 5.000 serraggi.



YouTube



PRECISIONE  
**±2%**

### 811 LB

#### Barre dinamometriche a scatto

ARTICOLO	CODICE	CAPACITÀ	□	L	RISOL.		
811 LB 50	<b>U08115021</b>	10÷50 Nm	9x12 mm	357 mm	1 Nm	€ 285,00	<b>€ 199,00</b>
811 LB 100	<b>U08115023</b>	20÷100 Nm	9x12 mm	437 mm	1 Nm	€ 328,00	<b>€ 229,00</b>
811 LB 200	<b>U08115024</b>	40÷200 Nm	14x18 mm	515 mm	1 Nm	€ 342,00	<b>€ 239,00</b>
811 LB 350	<b>U08115025</b>	70÷350 Nm	14x18 mm	725 mm	2 Nm	€ 399,00	<b>€ 279,00</b>



**SERRAGGI  
DESTROSI  
E SINISTRORSI**

Cricchetto  
amovibile



PRECISIONE  
**±2%**

### 811 LBE

#### Chiavi dinamometriche a scatto con cricchetto reversibile amovibile

ARTICOLO	CODICE	CAPACITÀ	□	□	L	RISOL.		
811 LBE 50	<b>U08115026</b>	10÷50 Nm	3/8"	9x12 mm	407 mm	1 Nm	€ 364,50	<b>€ 255,00</b>
811 LBE 100B	<b>U08115027</b>	20÷100 Nm	3/8"	9x12 mm	487 mm	1 Nm	€ 407,50	<b>€ 285,00</b>
811 LBE 100C	<b>U08115028</b>	20÷100 Nm	1/2"	9x12 mm	487 mm	1 Nm	€ 410,00	<b>€ 287,00</b>
811 LBE 200	<b>U08115029</b>	40÷200 Nm	1/2"	14x18 mm	565 mm	1 Nm	€ 429,00	<b>€ 300,00</b>
811 LBE 350	<b>U08115032</b>	70÷350 Nm	1/2"	14x18 mm	775 mm	2 Nm	€ 486,00	<b>€ 340,00</b>



**SERRAGGI  
DESTROSI  
E SINISTRORSI**

## CHIAVI DINAMOMETRICHE 810 SA - 811 SA CON LETTURA DIRETTA DELLA COPPIA DI SERRAGGIO.

**CRICCHETTO REVERSIBILE**  
con meccanismo a 72 denti.

**ISO 6789**



YouTube

**MECCANISMO A SCATTO**  
con molla di compressione.

**IMPUGNATURA CONICA**  
in bimatereale e antiscivolo.

### LETTURA DIRETTA

Il valore della coppia impostato è subito visibile.

### REGOLAZIONE RAPIDA

Imposti il valore di coppia necessario ancora più velocemente.



### 810 SA

**Chiave dinamometrica a lettura diretta con cricchetto reversibile**

- Include certificato di taratura e dichiarazione REACH (SVHC).

ARTICOLO	CODICE	CAPACITÀ	☑	L (mm)	RISOL.		
810 SA 50	<b>U08105002</b>	10÷50 Nm	3/8"	350	0,25	€ 211,00	<b>€ 147,00</b>
810 SA 100	<b>U08105003</b>	20÷100 Nm	1/2"	410	0,5	€ 211,00	<b>€ 147,00</b>
810 SA 200	<b>U08105005</b>	40÷200 Nm	1/2"	475	1,0	€ 211,00	<b>€ 147,00</b>
810 SA 340	<b>U08105006</b>	60÷340 Nm	1/2"	630	1,0	€ 242,00	<b>€ 170,00</b>

**SERRAGGI  
DESTRORSI**

PRECISIONE  
**±4%**

**3/8"**

**1/2"**

Cricchetto  
amovibile

### 811 SE

**Chiave dinamometrica a lettura diretta con cricchetto amovibile**

- Include certificato di taratura e dichiarazione REACH (SVHC).

ARTICOLO	CODICE	CAPACITÀ	☑	☐	L (mm)	RISOL.		
811 SE 50	<b>U08115012</b>	10÷50 Nm	3/8"	9x12	370	0,25	€ 271,00	<b>€ 190,00</b>
811 SE 100B	<b>U08115013</b>	20÷100 Nm	3/8"	9x12	430	0,5	€ 271,00	<b>€ 190,00</b>
811 SE 100C	<b>U08115015</b>	20÷100 Nm	1/2"	9x12	430	0,5	€ 273,00	<b>€ 191,00</b>
811 SE 200	<b>U08115017</b>	40÷200 Nm	1/2"	14x18	510	1,0	€ 278,00	<b>€ 194,00</b>
811 SE 340	<b>U08115018</b>	60÷340 Nm	1/2"	14x18	665	1,0	€ 310,00	<b>€ 216,00</b>

**SERRAGGI  
DESTRORSI  
E SINISTRORSI**

PRECISIONE  
**±4%**

**3/8"**

**1/2"**



**SERRAGGI  
DESTROSI**



PRECISIONE  
**±4%**

**1/4"**

**SERRAGGI  
DESTROSI  
E SINISTRORSI**



Cricchetto  
amovibile

PRECISIONE  
**±4%**

**1/4"**

**SERRAGGI  
DESTROSI  
E SINISTRORSI**



PRECISIONE  
**±4%**

**3/4"**

  
**1/4"**

PRECISIONE  
**±6%**



## 810 N

### ISO 6789

#### Chiave dinamometrica con cricchetto reversibile

- Meccanismo a scatto con molla di compressione.
- Riarmo automatico: dopo lo scatto è subito pronta all'uso.
- Fornita con certificato di collaudo.

ARTICOLO	CODICE	CAPACITÀ	□	L	RISOL.
----------	--------	----------	---	---	--------

810 N 5	<b>U08104000</b>	1÷5 Nm	1/4"	197 mm	0,05
---------	------------------	--------	------	--------	------

~~€ 231,00~~

**€ 147,00**

810 N 25	<b>U08104001</b>	5 ÷ 25 Nm	1/4"	290 mm	0,05
----------	------------------	-----------	------	--------	------

~~€ 231,00~~

**€ 147,00**

## 811 NE

### ISO 6789

#### Chiave dinamometrica con cricchetto reversibile amovibile

- Cricchetto amovibile e sostituibile con gli inserti della gamma 811.
- Meccanismo a scatto con molla di compressione.
- Riarmo automatico: dopo lo scatto è subito pronta all'uso.
- Fornita con certificato di collaudo.

ART.	CODICE	CAPACITÀ	□	○	L	RISOL.
------	--------	----------	---	---	---	--------

811 NE 5	<b>U08114009</b>	1÷5 Nm	1/4"	9x12 mm	185 mm	0,05
----------	------------------	--------	------	---------	--------	------

~~€ 269,00~~

**€ 189,00**

811 NE 25	<b>U08114010</b>	5÷25 Nm	1/4"	9x12 mm	300 mm	0,05
-----------	------------------	---------	------	---------	--------	------

~~€ 274,00~~

**€ 192,00**

## 812 N

### ISO 6789

#### Chiavi dinamometriche con cricchetto reversibile

- Modelli a coppia regolabile per serraggi destrorsi e sinistrorsi con rotazione del cricchetto di 180°.
- Precisione ±4% del valore di coppia impostato.
- Scala di lettura in Nm.
- Meccanismo a scatto con molla di compressione.
- Riarmo automatico: dopo lo scatto è subito pronta all'uso.
- Blocco di sicurezza dopo la regolazione della coppia.
- Fornita in cassetta completa di certificato di collaudo.

ARTICOLO	CODICE	CAPACITÀ	□	○
----------	--------	----------	---	---

812 N 600	<b>U08120006</b>	120 ÷ 600 Nm	3/4"	14x18 mm
-----------	------------------	--------------	------	----------

~~€ 1.065,00~~

**€ 746,00**

812 N 1000	<b>U08120010</b>	200 ÷ 1000 Nm	3/4"	-
------------	------------------	---------------	------	---

~~€ 1.332,00~~

**€ 933,00**

## 824 A

### ISO 6789

#### Giraviti dinamometrici

- Modello a coppia regolabile per serraggi destrorsi da utilizzare in abbinamento agli inserti della serie 660 o, tramite raccordo, alle chiavi a bussola della serie mano da 1/4".
- Scala di lettura in Nm.
- Disinnesto automatico al raggiungimento della coppia impostata.
- Riarmo automatico dopo 120°.
- Fornito con chiave di regolazione e certificato di collaudo.

CODICE	CAPACITÀ	L	RISOL.
--------	----------	---	--------

<b>U08240004</b>	0,5÷2,5 Nm	145 mm	0,1
------------------	------------	--------	-----

~~€ 255,00~~

**€ 179,00**

<b>U08240006</b>	2÷10 Nm	167 mm	0,5
------------------	---------	--------	-----

~~€ 261,00~~

**€ 182,00**

Serraggi controllati utilizzando cricchetti o chiavi a T

1/2"



YouTube

## 814 A

### Dispositivo digitale coppia-angolo

- Permette serraggi coppia ed angolo di precisione digitale anche con utensili tradizionali.
- Per serraggi destrorsi e sinistrorsi.
- Scala di lettura in Nm/ft.lb/in-lb/kg.cm/gradi.
- Doppia indicazione: luminosa (LED) e sonora (buzzer) al raggiungimento del valore impostato.
- 9 valori di coppia o angolo preimpostabili.
- 50 misurazioni memorizzabili.
- In custodia di ABS con certificato di taratura.
- Alimentazione: 2 batterie AAA (include).

CODICE	CAPACITÀ	█	RISOL.	<del>€ 266,00</del>	€ 187,00
U08140003	27 - 135	1/2"	0,1	<del>€ 266,00</del>	€ 187,00
U08140004	40 - 200	1/2"	0,1	<del>€ 306,00</del>	€ 214,00
U08140005	68 - 340	1/2"	0,1	<del>€ 372,00</del>	€ 261,00

Misurazione corretta dell'angolo in qualsiasi posizione

PRECISIONE  
±2%



YouTube

## 831 A

U08310001

### Goniometro digitale

- Permette serraggi angolari di precisione digitale in totale semplicità.
- Per serraggi destrorsi e sinistrorsi.
- Precisione angolo: +/- 2%.
- Scala: 0÷360°.
- Risoluzione: 0,1°.
- Doppia indicazione: luminosa (LED) e sonora (buzzer) al raggiungimento del valore impostato.
- 9 valori di angolo preimpostabili.
- 50 misurazioni memorizzabili.
- Fornito in custodia di ABS con certificato di taratura.
- Alimentazione: 2 batterie AAA (include nella confezione).

~~€ 193,00~~

€ 126,00

Rapporto di moltiplicazione

1:3,4



Ingresso

Uscita

CAPACITÀ  
1400  
Nm

1/2"

3/4"

## 828 X4

U08280401

### Moltiplicatore di coppia

- Modello compatto e leggero per interventi di manutenzione su veicoli industriali e macchine agricole.
- Fornito con leva di contrasto in custodia di nylon.
- Rapporto di trasmissione 4:1.
- Coppia max in ingresso: 400 Nm.

~~€ 879,00~~

€ 615,00

COMPRESSE NEL PREZZO



454

Estrattori a due bracci per esterni

CODICE	A	B	POTENZA			
U04540000	65 mm	70 mm	1,5 t	13 mm	<del>€ 83,00</del>	<b>€ 58,00</b>
U04540010	90 mm	110 mm	3 t	17 mm	<del>€ 93,50</del>	<b>€ 65,50</b>
U04540020	130 mm	110 mm	3 t	17 mm	<del>€ 101,00</del>	<b>€ 70,50</b>
U04540030	175 mm	165 mm	4 t	17 mm	<del>€ 163,00</del>	<b>€ 114,00</b>
U04540040	220 mm	165 mm	4 t	17 mm	<del>€ 180,00</del>	<b>€ 126,00</b>
U04540050	270 mm	220 mm	5 t	21 mm	<del>€ 252,00</del>	<b>€ 176,00</b>
U04540060	340 mm	220 mm	5 t	21 mm	<del>€ 282,00</del>	<b>€ 197,00</b>



4  
PEZZI

451 N/S4

U04510100

Estrattore a tre bracci per esterni

- Modello a bracci autoserranti.
- Capacità: 7÷140 mm.
- Potenza: 3 ton.
- Spina di sicurezza.
- Vite di manovra con esagono da 18 mm.
- Possibilità di utilizzo a due bracci.
- Viti di manovra M16x2.

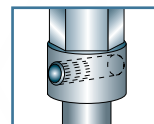

Spina di sicurezza: utilizzo sicuro e qualità dell'attrezzo preservata

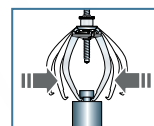

Autoserrante Autocentrante

~~€ 345,00~~

**€ 175,00**



2-2,5-3-4-5-6-7-8 mm



YouTube

9  
PEZZI

Bussola portainseri 1/4

110 mm  
20 mm  
105 mm

KIT COMPLETO PER VITI E DADI DANNEGGIATI

20  
PEZZI

210 mm  
60 mm  
130 mm



458 S20

U04580312

Assortimento di estrattori per viti e dadi esagonali danneggiati

DESCRIZIONE	ART./MISURA	PZ.
Estrattori per viti e dadi esagonali danneggiati	458 B 8-10-11-12-13-14-15-16-17-18-19	11
Estrattori per viti esagonali danneggiati	458 E 2-2,5-3-4-5-6-7-8	8
Bussola portainseri	684 1/4	1

~~€ 210,00~~

**€ 147,00**

458 E/B9

U04580313

Set di estrattori per viti esagonali danneggiate

DESCRIZIONE	ART./MISURA	PZ.
Estrattori per viti esagonali danneggiate	458 E 2-2,5-3-4-5-6-7-8	8
Bussola portainseri	684 1/4	1

~~€ 50,50~~

**€ 35,30**



PROFILO ESCLUSIVO PER ESAGONI INCASSATI

Lo speciale design degli inserti permette di fare presa su esagoni incassati intatti o completamente danneggiati.

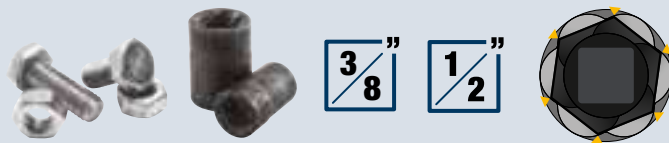

PROFILO ELICOIDALE PER DADI E VITI ESAGONALI

Le bussole elicoidali coniche garantiscono una presa esterna efficace su esagoni danneggiati.



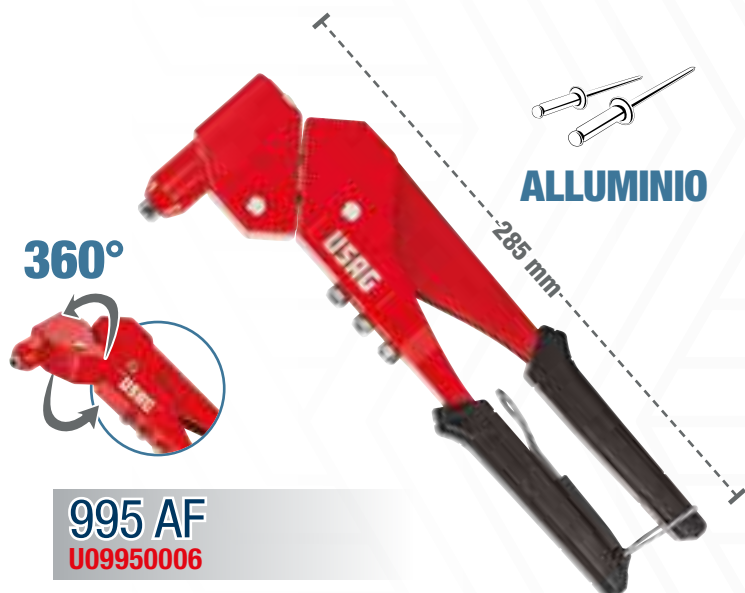

360°

ALLUMINIO

**995 AF**  
U09950006

**Rivettatrice con testa orientabile**

- Capacità: Ø 2,4 - 3,2 - 4 - 4,8 mm (3/32 - 1/8 - 5/32 - 3,16").
- Testa orientabile liberamente a 360°.
- Adatta a rivetti in alluminio.
- 4 testine intercambiabili.
- Corpo in lega leggera.
- Clip in metallo per blocco apertura.
- Chiave smontaggio testine in dotazione.

~~€ 35,40~~

**€ 24,80**



ALLUMINIO  
E ACCIAIO

**995 A**  
U09950001

**Rivettatrice**

- Capacità acciaio: Ø 2,4 - 3,2 - 4 (3/32 - 1/8 - 5/32).
- Capacità alluminio: Ø 2,4 - 3,2 - 4 - 4,8 mm (3/32 - 1/8 - 5/32 - 3,16").
- Corpo in lega leggera.
- Leva di pressione in lamiera d'acciaio imbutita.
- Molla di richiamo per l'apertura dei manici.
- Fornita con 3 testine intercambiabili e chiave di servizio.

~~€ 33,00~~

**€ 23,10**



**-20%  
DI SFORZO**

**COMPATTA E POTENTE**

Solo 330 mm di lunghezza 20% di sforzo in meno rispetto al modello standard.



ALLUMINIO  
E ACCIAIO

**995 LA**  
U09950004

**Rivettatrice dritta compatta**

- Capacità: Ø 2,4 - 3,2 - 4 - 4,8 - 6,4 mm (3/32 - 1/8 - 5/32 - 3,16 - 1/4").
- Modello compatto con la stessa capacità di una rivettatrice lunga standard.
- Il sistema di leve interno riduce lo sforzo dell'operatore.
- Adatta a rivetti in alluminio ed acciaio.
- 5 testine intercambiabili.
- Serbatoio amovibile per recupero steli.
- Corpo in lega leggera.

~~€ 62,50~~

**€ 43,80**



Ø  
M4 - M5  
M6 - M8

**FORNITA  
IN CASSETTA**

**PER RIVETTI  
FILETTATI**  
(non inclusi)

**995 CA**  
U09950008

**Rivettatrice per inserti filettati**

- Modello compatto con sistema di leve interno che garantisce meno sforzo all'operatore durante l'utilizzo.
- Fornita con 4 tiranti intercambiabili (M4-M5-M6-M8).
- Utilizzabile con rivetti in alluminio e acciaio (M4-M5-M6-M8) e acciaio inox (M4-M5).
- Corpo in lega leggera.
- Manici in materiale plastico.
- Fornita in valigetta di plastica (LxPxH: 320x175x50 mm) con vani portainseriti filettati (non inclusi).

~~€ 90,00~~

**€ 63,00**

## FORBICE 207 E

CON STRUTTURA INTEGRALE IN ACCIAIO INOX.



YouTube



**L'UNICA CON STRUTTURA INTEGRALE IN ACCIAIO INOX** resiste alla flessione fino a 180 kg.

**SPELLAFILI INTEGRATO**



1. Spellatura.  
2. Crimpatura.

**TAGLIACAVI SU ENTRAMBE LE LAME**

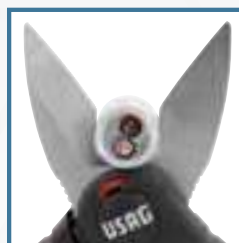

Adatto per cavi multipolari.

**LAMA MICRODENTATA ANTISCIVOLO**



**207 E**  
U02070006

Forbice professionale per elettricisti

€ 40,40

**€ 28,30**

## FORBICE 207 D

IL RIFERIMENTO PER GLI ELETTRICISTI.



**IMPUGNATURA RESISTENTE ALLA FLESSIONE FINO A 80 kg** in tecnopolimero caricato vetro.

**ASOLE MAGGIORATE**

**207 D**  
U02070008

Forbice professionale per elettricisti

€ 26,50

**€ 18,60**



50 mm<sup>2</sup>



**LAME FLUIDE E ROBUSTE**

In acciaio inox con microdentatura e tagliacavi.



YouTube

## SMART FUNCTION

Selezione automatica della  
tensione AC/DC, resistenza  
e frequenza

MAX  
600 V

RMS



**074 A**  
U00740001

### Multimetro digitale compatto SMART

- Misurazione di AC/DC.
- Misurazioni di resistenza e continuità (suono acustico se resistenza circuito è inferiore 40 a Ω).
- Misurazioni frequenza.
- Misurazione corrente AC/DC con pinza amperometrica 076 P.



CAT III 600V

#### CARATTERISTICHE TECNICHE

Tensione continua DC	1÷600 mV±V
Tensione alternata AC	1÷600 mV±V
Resistenza	0÷10 Ω±MQ
Frequenza	3÷40 kHz
Tipo batterie (fornite)	2xAAA 1,5V

€ 150,00

**€ 105,00**



Ø 4÷28 mm<sup>2</sup>



YouTube

**163**

U01630001

### Sguainacavi multifunzione

- Per il taglio circolare e longitudinale di cavi con rivestimento esterno in PVC.
- Sistema a grilletto (-30% di sforzo): forza necessaria 75 N.
- Rotella di avanzamento della lama.
- Lama di spellatura auto rotante.
- Blocco grilletto con lama estraibile.
- Blocco di sicurezza della lama.
- Corpo ergonomico in materiale plastico.
- Lama di ricambio inclusa.
- Kit lame di ricambio codice 872272.

€ 41,80

**€ 29,30**



**007 MV**  
U00070035

### Marsupio portautensili (vuoto)

- Tessuto ad altissima resistenza.
- Sistema di fissaggio alla cintura con chiusura in velcro.
- 4 tasche portautensili elasticizzate.
- Gancio porta nastro.

€ 21,50

**€ 15,00**



**007 MLV**  
U00070030

### Marsupio portautensili con cintura (vuoto)

- Tessuto ad altissima resistenza.
- 6 tasche portautensili elasticizzate.
- Gancio porta nastro.
- Cintura regolabile da 80 a 120 cm.

€ 42,90

**€ 30,00**





**LAME IN ACCIAIO INOX**

210 mm

**211 A**  
U02110001

**Forbice multiuso**

- Lama con microdentatura antiscivolo.
- Leva per la selezione di mani piccole/grandi.
- Leva di sicurezza per il bloccaggio delle lame.
- Impugnature ergonomiche bimalteriali antiscivolo.

€ 23,40

**€ 16,40**



**LAME IN ACCIAIO INOX**

200 mm

**211 B**  
U02110002

**Forbice multiuso lame inclinate**

- Lama con microdentatura antiscivolo.
- Leva per la selezione di mani piccole/grandi.
- Leva di sicurezza per il bloccaggio delle lame.
- Impugnature ergonomiche bimalteriali antiscivolo.

€ 25,30

**€ 17,70**



**LAME IN ACCIAIO INOX**

280 mm

**210 C**  
U02100003

**Forbice multiuso**

- Lama microdentata antiscivolo in acciaio inox.
- Grandi impugnature ergonomiche in bimalteriale.
- Perfetta per il taglio di alluminio, cartone, gomma, cuoio, moquette, ecc.

€ 20,60

**€ 14,40**

**ADATTA PER DESTRIMANI**



**LAME IN ACCIAIO INOX**

190 mm

**218 N**  
U02180002

**Forbice multiuso lame inclinate**

- Lama in acciaio inox.
- Blocco lama di sicurezza.
- Perno per apertura facilitata.
- Corpo in alluminio con inserti in poliammide.
- Manico con foro di aggancio e frangivetro.
- In dotazione: custodia in nylon con clip di chiusura e passante per cintura.

€ 35,10

**€ 24,60**



300 mm

**LAMA ORIENTABILE A 45° E 90°**

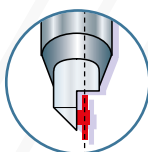

**200 S**  
U02000002

**Seghetto**

- Anima in acciaio rivestita in materiale plastico antiscivolo ed antiurto.
- Fornito con lama al cobalto mod. 200 C24.

€ 35,90

**€ 25,10**

**SISTEMA DI TENSIONAMENTO DELLA LAMA**

integrato nell'impugnatura

2-3-4-5-6-8 mm

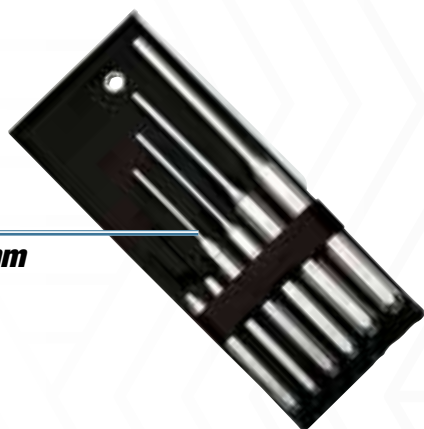

6  
PEZZI

## 367 SE6

U03670081

### Serie di 6 cacciaspine

- 367/2x100-3x130-4x145-5x165-6x180-8x200 mm.
- Fornita in busta di plastica.
- Acciaio al cromo vanadio.
- Punte riportate e fosfatate per le misure da 2 e 3 mm.

€ 56,50

**€ 39,60**

## UNI 7784

376

### Mazzuole

- Modello a tasselli intercambiabili in materiale plastico.
- Corpo in acciaio al carbonio.
- Manico in frassino.



### MATERIALI COMBINATI PER UN RISULTATO OTTIMALE.

- 1 Anima in grafite: massima resistenza alla flessione.
- 2 Elevata qualità: corpo in polipropilene che assorbe le vibrazioni.
- 3 Rivestimento in gomma resistente agli idrocarburi.

## DIN 1041



382 F

### Martelli per meccanici manico in graphite

- Modello tedesco a testa quadra piana e penna simmetrica.
- Manico in graphite.

CODICE	PESO TESTA	LUNGHEZZA		
U03820102	200 g	285 mm	€ 19,30	<b>€ 13,50</b>
U03820103	300 g	300 mm	€ 20,80	<b>€ 14,60</b>
U03820105	500 g	310 mm	€ 23,50	<b>€ 16,40</b>
U03820107	800 g	350 mm	€ 29,00	<b>€ 20,30</b>
U03820108	1000 g	355 mm	€ 31,50	<b>€ 22,00</b>

CODICE	PESO TESTA	LUNGHEZZA		
U03820002	100 g	260 mm	€ 11,10	<b>€ 8,15</b>
U03820004	200 g	280 mm	€ 12,20	<b>€ 8,55</b>
U03820006	300 g	300 mm	€ 13,50	<b>€ 9,45</b>
U03820007	400 g	310 mm	€ 16,00	<b>€ 11,20</b>
U03820008	500 g	320 mm	€ 18,00	<b>€ 12,60</b>
U03820009	600 g	330 mm	€ 20,80	<b>€ 14,50</b>
U03820010	800 g	350 mm	€ 24,10	<b>€ 16,90</b>
U03820011	1000 g	360 mm	€ 27,10	<b>€ 19,00</b>
U03820013	1500 g	380 mm	€ 36,30	<b>€ 25,30</b>
U03820014	2000 g	400 mm	€ 47,00	<b>€ 32,90</b>

Testa in acciaio al carbonio forgiata e sottoposta a trattamento termico differenziato per garantire una maggiore durata ed evitare scheggiature o ricalcature della superficie battente.

## UNI 7777 DIN 6475



382

### Martelli per meccanici

- Modello tedesco a testa quadra piana e penna simmetrica.
- Manico in frassino.

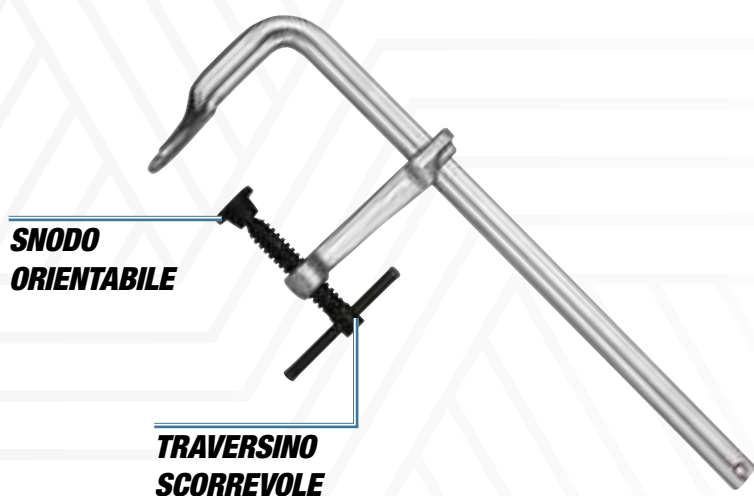

## 997 A

### Strettoio a vite

- Corpo e asta scorrevole in acciaio forgiato.

CODICE	APERTURA	SEZIONE	PESO		
<b>U09970002</b>	160 mm	16x7,5 mm	0,5 kg	<del>€ 28,20</del>	<b>€ 19,70</b>
<b>U09970003</b>	200 mm	19,5x9,5 mm	0,9 kg	<del>€ 35,10</del>	<b>€ 24,60</b>
<b>U09970004</b>	250 mm	22x10,5 mm	1,2 kg	<del>€ 42,10</del>	<b>€ 29,50</b>
<b>U09970005</b>	300 mm	25x12 mm	1,8 kg	<del>€ 53,50</del>	<b>€ 37,40</b>
<b>U09970006</b>	400 mm	25x12 mm	1,9 kg	<del>€ 56,00</del>	<b>€ 39,20</b>
<b>U09970007</b>	500 mm	25x12 mm	2,1 kg	<del>€ 61,00</del>	<b>€ 42,70</b>
<b>U09970008</b>	600 mm	25x12 mm	2,3 kg	<del>€ 66,00</del>	<b>€ 46,20</b>
<b>U09970009</b>	800 mm	27x13 mm	3,3 kg	<del>€ 86,50</del>	<b>€ 60,50</b>
<b>U09970010</b>	1000 mm	27x13 mm	3,7 kg	<del>€ 98,00</del>	<b>€ 68,50</b>

## 997 B

### Strettoio rapido a leva

- Regolazione e sgancio rapidi tramite leva e pulsante integrato.
- Corpo e asta scorrevole in acciaio forgiato.

CODICE	APERTURA	SEZIONE	PESO		
<b>U09970013</b>	120 mm	13,5x6,5 mm	0,7 kg	<del>€ 53,50</del>	<b>€ 37,40</b>
<b>U09970014</b>	160 mm	16x7,5 mm	1 kg	<del>€ 59,00</del>	<b>€ 41,30</b>
<b>U09970015</b>	200 mm	19,5x9,5 mm	1,3 kg	<del>€ 71,50</del>	<b>€ 50,00</b>
<b>U09970016</b>	250 mm	22x10,5 mm	1,9 kg	<del>€ 83,00</del>	<b>€ 58,00</b>
<b>U09970017</b>	300 mm	25x12 mm	2,7 kg	<del>€ 102,00</del>	<b>€ 71,50</b>
<b>U09970018</b>	400 mm	25x12 mm	2,8 kg	<del>€ 107,00</del>	<b>€ 75,00</b>
<b>U09970019</b>	500 mm	25x12 mm	3 kg	<del>€ 112,00</del>	<b>€ 78,50</b>

**PIANO REGOLABILE**

**LEVA CON PULSANTE DI SGANCIO INTEGRATO**

**10 PEZZI**



## 282 S10

**U02820200**

2 kg | 330 mm | 60 mm | 215

### Assortimento in cassetta di ABS con chiavi a compasso per ghiera a nasello tondo e quadro

- Chiavi a compasso per ghiera con fori e con intagli.
- Le chiavi si regolano agendo sulla vite centrale.
- Naselli amovibili.
- Diametri ghiera: da 20 a 100mm.
- Finitura cromata satinata.
- Cassetta in ABS ad alta resistenza con sistema di chiusura a clip.

### PER GHIERE CON DIAMETRI DA 20 A 100 mm

Ghiere con fori sulla parte superiore

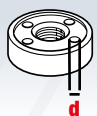

Ghiere con intagli sulla parte superiore



DESCRIZIONE	MISURA	PZ.
Naselli tondi	<b>(d)</b> 2,5 - 3 - 4 - 5 - 6 - 7 - 8 - 9 mm	4
Naselli quadri	<b>(a)</b> 4 - 5 - 6 - 8 mm	4

~~€ 161,00~~

**€ 112,00**



## DIN 338

HSS-G

14  
PEZZI



### 988 LA/S14

U09880070

#### Assortimento di punte e maschi

- Ø punte: 2,5-3,3-4,2-5,0-6,8-8,5-10,2 mm.
- M maschi: 3x0,5-4x0,7-5x0,8-6x1-8x1,25-10x1,5-12x1,75 mm.

~~€ 88,00~~

**€ 61,50**

## DIN 338

HSS-G

19  
PEZZI



### 988 MA/S19

U09880073

#### Assortimento di punte

- Ø punte: 1,0-1,5-2,0-2,5-3,0-3,5-4,0-4,5-5,0-5,5-6,0-6,5-7,0-7,5-8,0-8,5-9,0-9,5-10,0 mm.

~~€ 53,50~~

**€ 37,40**

## DIN 338

HSS-G

25  
PEZZI



### 988 MA/S25

U09880074

#### Assortimento di punte

- Ø punte: 1,0-1,5-2,0-2,5-3,0-3,5-4,0-4,5-5,0-5,5-6,0-6,5-7,0-7,5-8,0-8,5-9,0-9,5-10,0-10,5-11,0-11,5-12,0-12,5-13,0 mm.

~~€ 106,00~~

**€ 74,00**



HSS

3  
PEZZI



### 988 D/S3

U09880020

#### Serie di 3 frese a scalino

ART.	Ø SCALINI	Ø CODOLO	LUNG.
988 D1	4-5-6-7-8-9-10-11-12 mm	6 mm	65 mm
988 D2	4-6-8-10-12-14-16-18-20 mm	8 mm	75 mm
988 D3	4-6-8-10-12-14-16-18-20-22-24-26-28-30 mm	10 mm	100 mm

~~€ 196,00~~

**€ 138,00**

HSS

12  
PEZZI



### 988 G/S12

U09880100

#### Serie di 10 seghe a tazza bimetalliche

- Ø 19-22-25-29-35-38-44-51-57-64 mm.
- Profondità di taglio max: 38 mm.

~~€ 202,00~~

**€ 141,00**

HSS

10  
PEZZI



### 988 E/S10

U09880062

#### Frese rotative in metallo duro

- N°8 pezzi (Ø 10 e 12 forme EA-EC-EF-EG).
- N°2 pezzi (Ø 12 forme ED-EM).

~~€ 496,00~~

**€ 230,00**





YouTube

Ganci orientabili

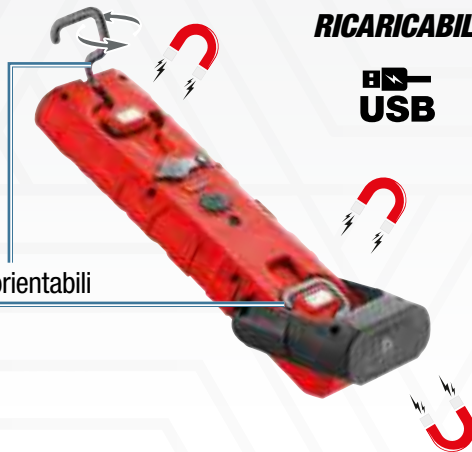

SMD LED



COB LED



1 = 18 h  
2 = 3,6 h  
3 = 1,8 h



Li-ion

**RICARICABILE**



**889 RL**  
U08890036

Lampada di ispezione a LED

~~€ 84,00~~

**€ 59,00**

**DOPPIA FUNZIONE**



**45 LUMEN**

**LAMPADA**



**MAX 420 LUMEN**

**TORCIA**

2 livelli di luminosità  
(120 e 420 lumen)

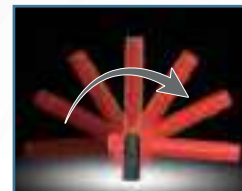

Base magnetica  
regolabile  
fino a 180°



Indicatore  
livello di carica  
luminoso



YouTube



SMD LED



COB LED



1 = 3 h  
2 = 10 h  
3 = 35 h



Li-ion

**RICARICABILE**

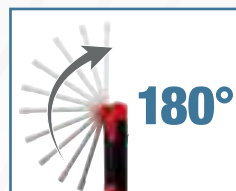

Snodata  
orientabile a 180°

**889 IL**  
U08890046

Lampada di ispezione articolata a LED

~~€ 84,00~~

**€ 59,00**

**TRIPLA FUNZIONE**



**50 LUMEN**

**TESTA**



**400 LUMEN**

**TORCIA**



**150 LUMEN**

**FRONTALE**



Indicatore livello di  
carica luminoso



Base magnetica con  
morsetto e gancio



YouTube

**SENSORE DI MOVIMENTO**



**Solo 91 mm di lunghezza**



SMD LED



IP54



1 = 18 h  
2 = 3,6 h  
3 = 1,8 h



Li-ion

**RICARICABILE**



**889 GR**

U08890044

Faretto compatto a LED

~~€ 113,00~~

**€ 79,00**

**3 LIVELLI DI LUMINOSITÀ**



50, 250 e 500 lumen con un semplice tocco.



Base magnetica regolabile fino a 90°



Gancio regolabile a 360°



Riflettore fluorescente



COB LED



IP67



2,5 h



1 = 8 h  
2 = 4 h  
3 = 2,5 h



IK07



Li-ion

**889 RT**

U08890038

Faretto a LED

~~€ 295,00~~

**€ 207,00**

**3 LIVELLI DI LUMINOSITÀ**



500, 1000 e 1500 lumen con un semplice tocco.



YouTube

Base magnetica



**180°**



**FUNZIONA CON O SENZA CAVO!**

Cavo da 5 metri incluso.



360°



180°



Lampada  
COB LED



Torcia  
SMD LED



IP20



Li-ion



USB

**889 RP**  
U08890045

Lampada a LED ricaricabile compatta

~~€ 68,50~~

**€ 48,00**



YouTube

**DOPPIA FUNZIONE**



Lampada



Torcia



180 mm

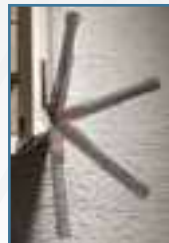

Clip di aggancio  
orientabile e magnetica



Lampada  
COB LED



Torcia  
SMD LED



IP67



Li-ion



USB

**889 TRE**  
U08890018

Torcia a LED ricaricabile

~~€ 86,00~~

**€ 60,00**

**DOPPIA FUNZIONE**



Lampada



Torcia



COB  
LED



IP54



3xAAA

**889 LTE**  
U08890014

Lampada frontale a LED

~~€ 65,00~~

**€ 35,00**



Cinturino  
antiscivolo



- SMD LED
- IP54
- 2xAAA

**889 TS**  
U08890070

Torcia LED stilo in alluminio

~~€ 29,60~~

**€ 20,70**



- SMD LED
- IP54
- 2xAAA

**889 TM**  
U08890071

Torcia LED stilo in alluminio

~~€ 35,40~~

**€ 24,80**



- SMD LED
- IP54
- 3xC

**889 TL**  
U08890072

Torcia LED in alluminio

~~€ 59,00~~

**€ 41,30**



- SMD LED
- IP54
- Li-ion

**889 TR**  
U08890073

Torcia LED in alluminio ricaricabile

~~€ 76,50~~

**€ 53,50**



- SMD LED
- IP44
- Li-ion

**889 UB**  
U08890034

Lampada a LED sottocofano ricaricabile

~~€ 207,00~~

**€ 145,00**



## TRASFORMATORE INTEGRATO

Nessun alimentatore esterno.



YouTube

12 V 1200 A

10 kg 400 mm 320 115



## CONNETTORE POSTERIORE PER SELEZIONE VOLTAGGIO



12 V 1400 A  
24 V 700 A

20,8 kg 560 mm 200 590



12V - 3700A

## 1613 RA12

U16130019

### Avviatore portatile 12V

- Scocca antiurto in ABS.
- Idoneo anche per batterie sigillate.

3500A

Lunghezza cavi  
155 cm

€ 583,00

€ 408,00

## 1613 AGM12-24

U16130013

### Avviatore professionale portatile 12V-24V

- Scocca antiurto in ABS.
- Protezione da sovratensione.

24V - 1860A

Lunghezza cavi  
155 cm

€ 1.322,00

€ 925,00



YouTube

## POTENZA DI COMPRESSIONE

735 kg (6 bar), 1226 kg (10 bar).



## 447 T

U04470101

### Smonta ammortizzatori pneumatico

- Ideale per autovetture.
- Fornito con due staffe inferiori 447 TC1 (78÷130 mm) e 447 TC2 (105÷182 mm), morsa 447 TA e morsetti superiori universali 447 TB1.

#### CARATTERISTICHE TECNICHE

Potenza compressione 735 kg (6 bar) - 1226 kg (10 bar)

Pressione di esercizio 6÷10 bar

Corsa del pistone 420 mm

Cilindro Doppio in lega d'alluminio e resina al nylon

60 kg 470 mm 1.390 450

€ 1.974,00

€ 1.381,00

## Pressione regolabile FINO A 4 BAR

12 V

10 Litri

## 2847/3

U28470084

### Spurgatore per circuito freni

- Permette di cambiare, riempire, spurgare i circuiti dei freni di autovetture e vecchi industriali.
- Apparecchio progettato esclusivamente per liquidi freno tipo DOT 3, DOT 4, DOT 5.1. No LHM.

#### CARATTERISTICHE TECNICHE

Sistema di manovra del liquido Pompa peristaltica (nessun contatto diretto pompa liquido, nessuna pressione aria sul liquido)

Alimentazione 12 V (morsetti batteria)

Capacità serbatoio 10 litri

Limitatore di pressione 4 bar

Tubo a spirale 4 m (elastico)

Cavo di alimentazione 4 m



#### Fornito con:

- guarnizioni di ricambio,
- 1 tappo multidiametro 44-45-46 mm (2847 N11).
- 1 contenitore di recupero olio.

€ 1.558,00

€ 1.091,00



## PER BATTERIE 6÷12 V

Anche per sistema  
Start & Stop



YouTube



Compatibile  
con termocoppia K.



**890 K**  
U08901000

Tester digitale per batterie con stampante

~~€ 697,00~~

**€ 489,00**

**1651**  
U16510001

Termometro digitale ad infrarossi

~~€ 189,00~~

**€ 132,00**



**IDEALE PER IMMETTERE  
OLIO NEL DIFFERENZIALE**

Non adatta per carburanti  
e olii minerali

**1,5**  
Litri



*Novità*

**421 P**  
U04210020

Siringa per olio

~~€ 70,00~~

**€ 49,00**

**IDEALE PER ASPIRAZIONE ED  
EROGAZIONE DI OLIO, LIQUIDO  
ANTIGELO E OLIO SERVOSTERZO**



*Novità*

**421 M**  
U04210021

Siringa in metallo

~~€ 28,00~~

**€ 19,60**

**3**  
Litri

**IDEALE PER SPURGO  
DEL LIQUIDO DEI  
FRENI O FRIZIONE**

Pressione  
di utilizzo  
6÷10 bar



*Novità*

**2847 A**  
U28470086

Spurgatore a depressione

~~€ 100,00~~

**€ 70,00**

**9,5**  
Litri



4,1 kg | 627 mm | 302



**1785 B**  
U17850005

Aspiratore liquidi  
manuale e pneumatico

~~€ 231,00~~

**€ 162,00**



**3**  
TON

**30,5**  
kg



**3t**



## 2550 A

U25500001

### Sollevatore idraulico 3T per auto e veicoli commerciali

- Struttura in acciaio.
- Portata elevata per utilizzo su auto, fuoristrada e furgoni.
- Sistema a doppia pompa per sollevare più velocemente la vettura.
- Dotato di comando di discesa manuale.
- Valvola di spurgo dell'aria, per evitare il pericolo di over-carico.

~~€ 347,00~~

**€ 234,00**



**2**  
TON

**32,5**  
kg



**2t**



## 2550 B

U25500002

### Sollevatore idraulico 2T

- Struttura in acciaio.
- Per utilizzo in spazi ridotti.
- Sistema a doppia pompa per sollevare più velocemente la vettura.
- Dotato di pedale di avvicinamento.
- Dotato di comando di discesa manuale.
- Valvola di spurgo dell'aria, per evitare il pericolo di over-carico.

~~€ 490,00~~

**€ 343,00**

## KIT UNIVERSALE PER LA RIMOZIONE DI DADI E VITI ANTIFURTO

YouTube  
**VIDEO TUTORIAL**



**10**  
PEZZI

## 272 DS

U02720001

### Kit estrazione dadi e viti antifurto

- Non danneggia il cerchio in lega.
- Punta speciali al carburo di tungsteno in grado di forare qualsiasi tipo di materiale (lubrificare con olio da taglio ad ogni utilizzo).
- Bussole coniche per centraggio/estrazione super sottili per accedere su ogni tipo di cerchio in lega.

~~€ 292,00~~

**€ 204,00**

## 1950 C

### Coppia colonnette

- Altezza regolabile tramite meccanismo dentato con rilascio a leva.
- Perno di bloccaggio con catena.
- 1950 C/3: modello regolabile a 10 posizioni.
- 1950 C/6: modello regolabile a 13 posizioni.



**2**  
PEZZI

CODICE	PORT.	H MAX	H MIN	DIMENSIONI	PESO
U19501001	3 t	427 mm	300 mm	207x188 mm	7 kg
U19501002	6 t	620 mm	400 mm	285x250 mm	14 kg

~~€ 96,50~~ **€ 67,50**

~~€ 139,00~~ **€ 97,50**



3  
PEZZI

1 1/2"

**270 C/C3**  
U02700106

Assortimento in cassetta modulare con bussole macchina per cerchi in lega con protezione in téflon

~~€ 60,00~~

**€ 42,00**

↔ 190  
↑ 58  
mm ↘ 144



22  
PEZZI

**1881 S22**  
U18810082

Kit universale per lo smontaggio e il montaggio delle ghiera pulegge alternatori

- Fornito in cassetta di plastica

~~€ 139,00~~

**€ 97,00**

9  
PEZZI

Due spazzole metalliche  
Ø 20mm e 25mm



**885 F**  
U08850004

Kit pulizia iniettori

- Ideale per la pulizia del condotto degli iniettori montati su motori common rail.

~~€ 173,00~~

**€ 121,00**

6  
PEZZI

1 1/2"

**884 C/S6**  
U08841000

Serie di 6 chiavi per raccordi tubi iniettori

- Per montaggio/smontaggio dei raccordi tubi iniettori.
- Lunghezza: 98 mm.
- Misure: 12-14-16-17-18-19 mm.

~~€ 129,00~~

**€ 90,50**

**È POSSIBILE RIPORLO  
NEI CASSETTI DEI  
NOSTRI CARRELLI**

Maniglia per il trasporto

230 g | 475 mm | 50 mm | 290 mm

**2000 G**  
U20000110

Tappeto per protezione ginocchia

~~€ 29,00~~

**€ 20,30**



4,6 kg | 1.030 mm | 480 mm | 115 mm

**2000 A**  
U20000100

Lettino sottoscocca 6 ruote

- Cuscino poggiatesta in vinile resistente agli idrocarburi.
- Struttura in materiale plastico resistente agli idrocarburi, lavabile.

~~€ 124,00~~

**€ 87,00**





## CHIAVE FILTRI OLIO 443 N CON REGOLAZIONE AUTOMATICA DEL NASTRO.



YouTube

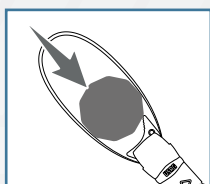

**SERRAGGIO AUTOMATICO  
DEL NASTRO**

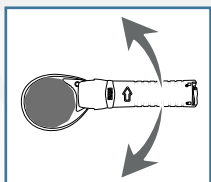

**EFFETTO CRICCHETTO**

Rapidità d'uso anche in spazi ridotti.

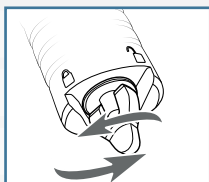

**LEVA DI INCREMENTO  
POTENZA SERRAGGIO**



**443 N**  
U04430005

**Chiave automatica a  
ripresa rapida per filtri  
olio (autovetture)**



**66÷105  
mm**

~~€ 105,00~~

**€ 73,50**

**443 NC**  
U04430007

**Chiave automatica a  
ripresa rapida per filtri  
olio (veicoli industriali)**



**106÷150  
mm**

~~€ 122,00~~

**€ 85,50**

**6  
PEZZI**

**3  
8"**

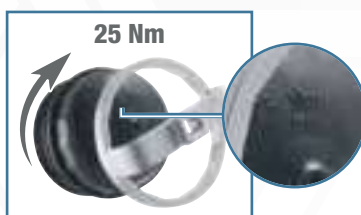

Permettono il riserraggio alla coppia originale di smontaggio (valore indicato sulla campana di plastica)

**446 DA/SE6**  
U04461104

**Serie di 6 chiavi per coperchio filtro olio**

- 1 chiave 14 tacche Ø 76 mm.
- 1 chiave 14 tacche Ø 102 mm.
- 1 chiave 16 tacche Ø 76 mm.
- 1 chiave 16 tacche Ø 88 mm.
- 1 chiave 18 tacche Ø 66 mm.
- 1 chiave 18 tacche Ø 96 mm.
- Quadro di manovra 3/8".

~~€ 215,00~~

**€ 151,00**



Inquadra il QR code per scaricare la tabella delle applicazioni o vai su usag.it

**3  
8"**

**1  
2"**

**30  
PEZZI**

7 kg | 620 mm | 70 mm | 500

**446 S28**  
U04461204

**Assortimento di 30 chiavi per filtri olio**

- Misure delle 28 chiavi a tazza Ø x N°lati:  
66/6 - 65/14 - 65/67 - 68/14 - 73/14 - 74/15 - 74/76 - 75/77 - 76/12 - 76/14 - 76/30 - 76/8 - 78/15 - 80/15 - 80/82 - 86/16 - 86/18 - 90/15 - 92/10 - 93/15 - 93/36 - 93/45 - 95/15 - 96/18 - 100/15 - 106/15 - 108/15 - 108/18.

~~€ 204,00~~

**€ 143,00**

Inquadra il QR code per scaricare la tabella delle applicazioni o vai su usag.it



**IN ALLUMINIO**

**446 DT/S2**

**U04461203**

**Serie di 2 chiavi per coperchi filtro olio modelli giapponesi**

- Riduce i rischi di danneggiamento dei coperchi filtri.
- Utilizzabili anche in serraggio con chiave dinamometrica.



3/8"

27 mm

3/8"

27 mm

**2**  
PEZZI

~~€ 60,50~~

**€ 42,30**

Inquadra il QR code per scaricare la tabella delle applicazioni o vai su usag.it



Attacco per il recuperatore d'olio

**16**  
PEZZI

3/8"

**263/S16**

**U02631400**

**Kit per tappi olio**

- Bussole magnetiche.
- 1 chiave snodata con coppetta.
- 2 inserti ○ 8-10 mm.
- 6 inserti ○ 8-10-12-13-14-17 mm.
- 6 bussole ● 13-14-17-18-19-21 mm.
- 1 inserto ○ T45.

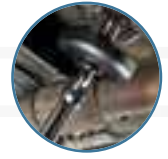

~~€ 190,00~~

**€ 133,00**

Vaschetta raccogli olio integrata

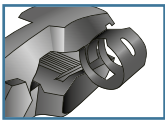

**2 in 1**

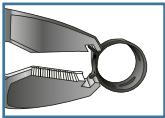

**871 D**

**U08710001**



**Pinza per anelli stringitubo a presa frontale/laterale**

- Possibilità di aggancio frontale o laterale.
- Ganasce con superficie di presa zigrinata.

~~€ 54,50~~

**€ 38,20**

3 posizioni di lavoro



**871 C**

**U08719005P**

**Pinza per fascette automatiche CLIC**

- Testa triassiale per lavorare in tutte le posizioni.
- Permette di aprire o chiudere le fascette automatiche presenti sui circuiti del carburante, dei collettori d'aspirazione e dei circuiti idraulici.

~~€ 77,50~~

**€ 54,00**



**870 C**

**U08700006**

**Pinza per raccordi rapidi carburante**

- Per veicoli a benzina e diesel.
- Impugnature ergonomiche bimalteriali.

~~€ 65,50~~

**€ 46,00**



**468 M**

**Utensile a percussione per anelli di tenuta e guarnizioni**

- Semplifica l'inserimento di anelli di supporto esterni per cuscinetti obliqui.
- Asse, sede dei cuscinetti e anelli di tenuta non vengono danneggiati.
- Ghiera regolabile in 3 posizioni.
- Impugnatura in acciaio.

CODICE	CAPACITÀ	LUNGHEZZA
U04680150	9,5÷50 mm	176 mm
U04680151	18÷90 mm	210 mm

~~€ 108,00~~

**€ 76,00**

~~€ 136,00~~

**€ 95,00**



## 2 MODALITÀ:

- 1 250 l/min - 50°÷400°C
- 2 500 l/min - 50°÷600°C

MAX  
600  
GRADI

2000  
WATT

**391**  
U03910001

### Pistola termica digitale

- Modello elettronico con controllo della temperatura e del volume d'aria mediante display digitale.
- Possibilità di impostazione dei programmi.
- Dotata di sistema di raffreddamento.

~~€ 214,00~~

**€ 93,00**

Accessori inclusi

5  
PEZZI

Per la rimozione di modanature, pioli, parti di cruscotto, rivestimenti portiere, etc.



**426 B/S5**  
U04260006

### Kit di 5 utensili per componenti in plastica

~~€ 32,10~~

**€ 22,50**

4  
PEZZI

Per separare i carter della cinghia di distribuzione, testata motore, cinghia di trasmissione etc.



**426 D/S4**  
U04260005

### Kit di 4 scalpelli separatori in plastica

~~€ 27,50~~

**€ 19,20**



### CARATTERISTICHE TECNICHE

Attacco filettatura	M18
Livello sonoro	78 Db
Lunghezza totale	610 mm
Peso	4 Kg
Pressione di esercizio	6,2 bar
Attacco filettato	1/4"

**400 P**  
U04000010

### Aspiratore pneumatico ammaccature

- Ideale per eliminare ammaccature da parti scatolate senza la necessità di rivernicare.
- Fornito con 3 ventose (Ø 75-100-125 mm), in valigetta in materiale plastico dotata di maniglia per il trasporto e clip di chiusura.

~~€ 206,00~~

**€ 144,00**

4  
PEZZI

Per la rimozione di contrappesi, silicone, modanature etc



**426 C/S4**  
U04260007

### Kit di 4 raschietti multiuso in plastica

~~€ 34,20~~

**€ 24,00**

2  
PEZZI

**115 CL/SE2**  
U01150022

### Serie di 2 pinze lunghe becchi diritti e piegati a 45°

- Ideale per la presa di pezzi e parti in posizioni di difficile accesso.

~~€ 81,50~~

**€ 57,00**





## SELEZIONE PRODOTTI TRUCK



by **FACOM**

### 445 B

U04450015

**Chiave per filtri olio - grandi dimensioni**

- Modello regolabile a 8 posizioni.
- Ganasce con dentatura triangolare per una maggiore presa sul filtro.
- Corpo in acciaio forgiato.
- Impugnature in PVC.
- Esecuzione brunita.

~~€ 89,00~~

**€ 62,50**

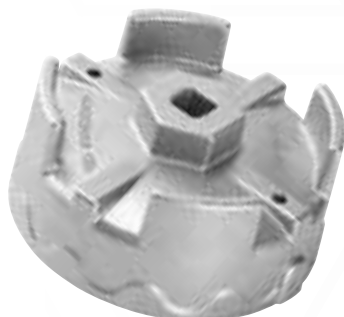

**1 1/2"**

**32 mm**

by **FACOM**

**Ø MAX  
36 mm**

by **FACOM**



**36 mm**

### 446 RT

U04461206

**Chiave a tazza per filtri olio TRUCK**

- Specifiche per montare e smontare filtri olio RENAULT e VOLVO TRUCKS.
- Corpo in alluminio.

~~€ 41,30~~

**€ 28,90**



Dimensioni profilo  
Ø106 mm x 15 lati

### 449 IDA

U04490019

**Estrattore per snodi sferici**

- Azionamento meccanico.
- Per l'estrazione degli snodi sferici e delle sospensioni di mezzi pesanti.

~~€ 151,00~~

**€ 106,00**

**22 mm**

**Ø MAX  
23 mm**



**22 mm**

**Ø MAX  
25 mm**



**3 4"**

**Ø MAX  
42 mm**



### 449 TA

U04490010

**Estrattore per snodi sferici mezzi pesanti**

- Per l'estrazione dei perni a snodo sferico sui tiranti trasversali dello sterzo.

~~€ 122,00~~

**€ 85,50**

### 449 TB

U04490015

**Estrattore per snodi sferici mezzi pesanti**

- Per l'estrazione dei perni a snodo sferico sui tiranti trasversali dello sterzo.

~~€ 122,00~~

**€ 85,50**

### 449 TC

U04490021

**Estrattore per snodi sferici mezzi pesanti**

- Per l'estrazione dei perni a snodo sferico sui tiranti trasversali dello sterzo.

~~€ 271,00~~

**€ 190,00**

## ILLUMINAZIONE A LED

1/2"

1.898 Nm 2,2 kg



YouTube

## CARTER IN LEGA DI MAGNESIO



## TOP DI GAMMA

943 PC1 1/2"

U09430001

### Avvitatore ad impulsi in magnesio

#### CARATTERISTICHE TECNICHE

Attacco quadro	1/2"	Pressione aria raccomandata	6,2 bar
Capacità bullone	M20	Pressione sonora	94 ±3 dB(A)
Coppia massima	1.898 Nm	Potenza sonora	105 ±3 dB(A)
Coppia di lavoro	320÷460 Nm	Vibrazioni	6,4 m/s <sup>2</sup>
Impulsi al minuto	1200	Attacco aria	1/4"
Velocità a vuoto	6.500 giri/min	Diametro interno tubo aria	10 mm
Consumo medio aria	172 l/min	Peso	2,2 kg

€ 513,00

**€ 352,00**

## IL RIFERIMENTO

## CARTER IN LEGA DI MAGNESIO

1/2"

1.600 Nm 2 kg



YouTube



929 PC1 1/2"

U09290001

### Avvitatore ad impulsi in magnesio

#### CARATTERISTICHE TECNICHE

Attacco quadro	1/2"	Pressione aria raccomandata	6,2 bar
Capacità bullone	M16	Pressione sonora	93 ±3 dB(A)
Coppia massima	1.600 Nm	Potenza sonora	104 ±3 dB(A)
Coppia di lavoro	280÷440 Nm	Vibrazioni	6,2 m/s <sup>2</sup>
Impulsi al minuto	1.300	Attacco aria	1/4"
Velocità a vuoto	7.000 giri/min	Diametro interno tubo aria	10 mm
Consumo medio aria	172 l/min	Peso	2,0 kg

€ 395,00

**€ 267,00**

## EXTRA COMPATTO

1/2"

861 Nm 1,3 kg



YouTube



942 PC3 1/2"

U09420012

### Avvitatore ad impulsi - extra compatto

#### CARATTERISTICHE TECNICHE

Attacco quadro	1/2"	Pressione aria raccomandata	6,2 bar
Capacità bullone	M16	Pressione sonora	91,1±3 dB(A)
Coppia massima	861 Nm	Potenza sonora	108,1±3 dB(A)
Coppia di lavoro	150÷220 Nm	Vibrazioni	9,57 m/s <sup>2</sup>
Impulsi al minuto	1650	Attacco aria	1/4"
Velocità a vuoto	10.000 giri/min	Diametro interno tubo aria	10 mm
Consumo medio aria	127 l/min	Peso	1,3 kg

€ 255,00

**€ 181,00**

YouTube



**Modulare con i cassetti dei carrelli USAG**

## 943 PC1/C12

U09430005

→ 415  
↑ 92  
mm ↘ 283

1/2"

**Assortimento in cassetta modulare con avvitatore ad impulsi e bussole macchina**

12 PEZZI

DESCRIZIONE	ART./MISURA	PZ.
Avvitatore ad impulsi in magnesio	943 PC1 1/2	1
Chiavi a bussola macchina con bocca esagonale	235 1/2 M/ 10-13-17-18-19-22-24-27-30-32 mm	10
Spina di tenuta	235 MCA/4-6	2
Anello di sicurezza	235 MDA/4-6	2
Prolunghe macchina	236 1/2 M/125	1

~~€ 688,00~~

**€ 427,00**



**Modulare con i cassetti dei carrelli USAG**

## 929 PC1/C12

U09290005

→ 415  
↑ 92  
mm ↘ 283

1/2"

**Assortimento in cassetta modulare con avvitatore ad impulsi e bussole macchina**

12 PEZZI

DESCRIZIONE	ART./MISURA	PZ.
Avvitatore ad impulsi in magnesio	929 PC1 1/2	1
Chiavi a bussola macchina con bocca esagonale	235 1/2 M/ 10-13-17-18-19-22-24-27-30-32 mm	10
Spina di tenuta	235 MCA/4-6	2
Anello di sicurezza	235 MDA/4-6	2
Prolunghe macchina	236 1/2 M/125	1

~~€ 570,00~~

**€ 348,00**



**Modulare con i cassetti dei carrelli USAG**

## 942 PC3/C7

U09420015

→ 375  
↑ 80  
mm ↘ 186

1/2"

**Assortimento in cassetta modulare con avvitatore ad impulsi e bussole macchina**

7 PEZZI

DESCRIZIONE	ART./MISURA	PZ.
Avvitatore ad impulsi - extra compatto	942 PC3 1/2	1
Chiavi a bussola macchina con bocca esagonale	235 1/2 M/ 13-17-19-21-22-24 mm	6
Spina di tenuta	235 MCA/4	1
Anello di sicurezza	235 MDA/4	1

~~€ 341,00~~

**€ 232,00**



## ILLUMINAZIONE A LED

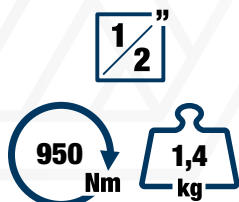

## CARTER IN LEGA DI MAGNESIO

## CORPO IN ALLUMINIO

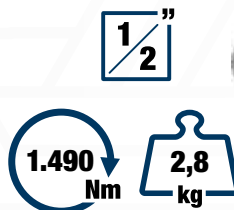

### 943 PC2 1/2"

U09430002

Avvitatore ad impulsi in magnesio con LED - Extra compatto

#### CARATTERISTICHE TECNICHE

Attacco quadro	1/2"	Pressione aria raccomandata	6,2 bar
Capacità bullone	M16	Pressione sonora	95±3 dB(A)
Coppia massima	950 Nm	Potenza sonora	107±3 dB(A)
Coppia di lavoro	200÷270 Nm	Vibrazioni	3,9 m/s <sup>2</sup>
Impulsi al minuto	1400	Attacco aria	1/4"
Velocità a vuoto	10.000 giri/min	Diametro interno tubo aria	10 mm
Consumo medio aria	167 l/min	Peso	1,4 kg

€ 437,00

**€ 306,00**

### 928 AC1 1/2"

U09280014

Avvitatore ad impulsi in alluminio

#### CARATTERISTICHE TECNICHE

Attacco quadro	1/2"	Pressione aria raccomandata	6,2 bar
Capacità bullone	M16	Pressione sonora	90 ±3 dB(A)
Coppia massima	1.490 Nm	Potenza sonora	101 ±3 dB(A)
Coppia di lavoro	135÷380 Nm	Vibrazioni	5,2 m/s <sup>2</sup>
Impulsi al minuto	1.120	Attacco aria	1/4"
Velocità a vuoto	6.500 giri/min	Diametro interno tubo aria	10 mm
Consumo medio aria	147 l/min	Peso	2,8 kg

€ 313,00

**€ 213,00**

## CARTER IN LEGA DI TITANIO

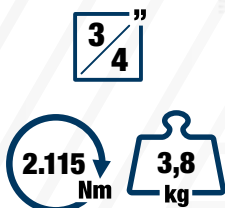

## CORPO IN ALLUMINIO

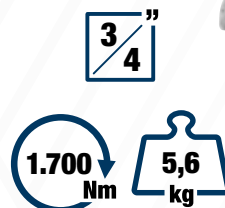

### 942 PD1 3/4"

U09420004

Avvitatore ad impulsi in titanio

#### CARATTERISTICHE TECNICHE

Attacco quadro	3/4"	Pressione aria raccomandata	6,2 bar
Capacità bullone	M27	Pressione sonora	97,8±3 dB(A)
Coppia massima	2.115 Nm	Potenza sonora	108,8±3 dB(A)
Coppia di lavoro	500÷800 Nm	Vibrazioni	5,06 m/s <sup>2</sup>
Impulsi al minuto	950	Attacco aria	3/8"
Velocità a vuoto	5.300 giri/min	Diametro interno tubo aria	10 mm
Consumo medio aria	200 l/min	Peso	3,8 kg

€ 916,00

**€ 641,00**

### 928 D1 3/4"

U09280015

Avvitatore ad impulsi in alluminio

#### CARATTERISTICHE TECNICHE

Attacco quadro	3/4"	Pressione aria raccomandata	6,2 bar
Capacità bullone	M24	Pressione sonora	98,4±3 dB(A)
Coppia massima	1.700 Nm	Potenza sonora	109,4±3 dB(A)
Coppia di lavoro	500÷1.050 Nm	Vibrazioni	9,1 m/s <sup>2</sup>
Impulsi al minuto	790	Attacco aria	3/8"
Velocità a vuoto	5.700 giri/min	Diametro interno tubo aria	13 mm
Consumo medio aria	193 l/min	Peso	5,6 kg

€ 834,00

**€ 584,00**

## CORPO IN COMPOSITO

### MANIGLIA ERGONOMICA BIMATERIALE

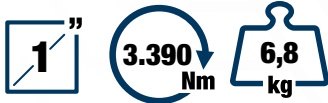

## 942 PE1 1"

U09420005

Avvitatore ad impulsi in materiale composito

#### CARATTERISTICHE TECNICHE

Attacco quadro	1"	Pressione aria raccomandata	6,2 bar
Capacità bullone	M38	Pressione sonora	100,9 ±3 dB(A)
Coppia massima	3.390 Nm	Potenza sonora	111,9 ±3 dB(A)
Coppia di lavoro	203÷1.627 Nm	Vibrazioni	10,6 m/s <sup>2</sup>
Impulsi al minuto	900	Attacco aria	1/2"
Velocità a vuoto	5.000 giri/min	Diametro interno tubo aria	19 mm
Consumo medio aria	400 l/min	Peso	6,8 kg

~~€ 1.118,00~~

**€ 783,00**

## CORPO IN COMPOSITO

### MANIGLIA ERGONOMICA BIMATERIALE



## 942 PEL2 1"

U09420007

Avvitatore reversibile in linea in materiale composito

#### CARATTERISTICHE TECNICHE

Attacco quadro	1"	Pressione aria raccomandata	6,2 bar
Capacità bullone	M38	Pressione sonora	105 ±3 dB(A)
Coppia massima	3.390 Nm	Potenza sonora	116 ±3 dB(A)
Coppia di lavoro	203÷1.627 Nm	Vibrazioni	15,6 m/s <sup>2</sup>
Impulsi al minuto	1000	Attacco aria	1/2"
Velocità a vuoto	5.000 giri/min	Diametro interno tubo aria	19 mm
Consumo medio aria	480 l/min	Peso	9 kg

~~€ 1.118,00~~

**€ 783,00**

## CORPO IN ALLUMINIO

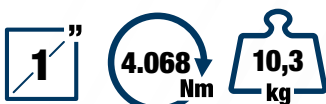

## 910 E1 1"

U09100020

Avvitatore ad impulsi in alluminio

#### CARATTERISTICHE TECNICHE

Attacco quadro	1"	Pressione aria raccomandata	6,2 bar
Capacità bullone	M33	Pressione sonora	102 ±3 dB(A)
Coppia massima	4.068 Nm	Potenza sonora	113 ±3 dB(A)
Coppia di lavoro	850÷1.300 Nm	Vibrazioni	15,2 m/s <sup>2</sup>
Impulsi al minuto	720	Attacco aria	1/2"
Velocità a vuoto	4.500 giri/min	Diametro interno tubo aria	13 mm
Consumo medio aria	243 l/min	Peso	10,3 kg

~~€ 1.502,00~~

**€ 999,00**

**COMPATTA**  
-221 mm-

**152**  
mm

**5**  
mm

**105**  
l/min



**920 AN1**  
U09200011

### Levigatrice roto-orbitale

#### CARATTERISTICHE TECNICHE

Potenza	0,19 Kw
Capacità disco	Ø 152 mm
Orbita	5 mm
Orbite al minuto	10.000 giri/min
Consumo medio aria	105 l/min
Pressione aria raccomandata	6,2 bar
Pressione sonora	78,9±3 dB(A)
Potenza sonora	79,9±3 dB(A)
Vibrazioni	11,8 m/s <sup>2</sup>
Attacco aria	1/4"
Diametro interno tubo aria	10 mm
Peso	0,8 kg



~~€ 332,00~~

**€ 232,00**



**125**  
mm

**750 W**

**12.000**  
Giri/min

**921 A4**  
U09210012

### Smerigliatrice angolare

#### CARATTERISTICHE TECNICHE

Diametro disco	Ø 125 mm
Diametro attacco disco	Ø 24 mm
Potenza	0,75 Kw
Velocità a vuoto	12.000 giri/min
Consumo medio aria	120 l/min
Pressione aria raccomandata	6,2 bar
Pressione sonora	86±3 dB(A)
Potenza sonora	94±3 dB(A)
Vibrazioni	2,5 m/s <sup>2</sup>
Attacco aria	1/4"
Peso	1,9 Kg



~~€ 332,00~~

**€ 232,00**

**1/2"**

**136**  
Nm

**1,2**  
kg

-260 mm-



**913 PC2 1/2"**  
U09130017

### Cricchetto in materiale composito

#### CARATTERISTICHE TECNICHE

Attacco quadro	1/2"	Pressione sonora	99±3 dB(A)
Capacità bullone	M10	Potenza sonora	110±3 dB(A)
Coppia massima	136 Nm	Vibrazioni	9,1 m/s <sup>2</sup>
Velocità a vuoto	280 giri/min	Attacco aria	1/4"
Consumo medio aria	113 l/min	Diametro interno tubo aria	10 mm
Pressione aria raccomandata	6,2 bar	Peso	1,2 kg

~~€ 249,00~~

**€ 175,00**

**CAVO 16 m**  
**Ø 10 mm**

**939 C1**  
U09390004

### Avvolgitubo aria

#### CARATTERISTICHE TECNICHE

Lunghezza tubo	16 m
Diametro interno tubo	10 mm
Pressione max di utilizzo	15 bar
Raccordo in uscita	3/8"
Dimensioni (inclusa staffa)	450x400x230 mm
Peso	8 kg



~~€ 331,00~~

**€ 232,00**



**20.000 Giri/min**



**921 B1**  
U09210015

**Smerigliatrice diritta**

**CARATTERISTICHE TECNICHE**

Consumo medio aria	113 l/min	Vibrazioni	2,5 m/s <sup>2</sup>
Pressione aria raccomandata	6,2 bar	Attacco aria	1/4"
Pressione sonora	93,3±3 dB(A)	Diametro interno tubo aria	10 mm
Potenza sonora	104,3±3 dB(A)	Peso	660 g

~~€ 116,00~~

**€ 63,00**

**30.000 Giri/min**



**922 B1**  
U09220001

**Smerigliatrice diritta**

**CARATTERISTICHE TECNICHE**

Consumo medio aria	76 l/min	Vibrazioni	2,42 m/s <sup>2</sup>
Pressione aria raccomandata	6,2 bar	Attacco aria	1/4"
Pressione sonora	84,8±3 dB(A)	Diametro interno tubo aria	10 mm
Potenza sonora	99,5±3 dB(A)	Peso	440 g

~~€ 116,00~~

**€ 81,00**

**25.000 Giri/min**



**922 B2**  
U09220002

**Smerigliatrice diritta alta potenza**

**CARATTERISTICHE TECNICHE**

Consumo medio aria	113 l/min	Vibrazioni	1,86 m/s <sup>2</sup>
Pressione aria raccomandata	6,2 bar	Attacco aria	1/4"
Pressione sonora	85,4±3 dB(A)	Diametro interno tubo aria	10 mm
Potenza sonora	99,8±3 dB(A)	Peso	675 g

~~€ 132,00~~

**€ 92,00**

**23.000 Giri/min**



**90°**



**922 BP1**  
U09220004

**Smerigliatrice angolare 90°**

**CARATTERISTICHE TECNICHE**

Consumo medio aria	76 l/min	Vibrazioni	4,54 m/s <sup>2</sup>
Pressione aria raccomandata	6,2 bar	Attacco aria	1/4"
Pressione sonora	85,9±3 dB(A)	Diametro interno tubo aria	10 mm
Potenza sonora	96,9±3 dB(A)	Peso	555 g

~~€ 165,00~~

**€ 115,00**

**28.000 Giri/min**



**922 BL1**  
U09220003

**Smerigliatrice mandrino lungo**

**CARATTERISTICHE TECNICHE**

Consumo medio aria	76 l/min	Vibrazioni	2,86 m/s <sup>2</sup>
Pressione aria raccomandata	6,2 bar	Attacco aria	1/4"
Pressione sonora	83,3±3 dB(A)	Diametro interno tubo aria	10 mm
Potenza sonora	94,3±3 dB(A)	Peso	664 g

~~€ 165,00~~

**€ 115,00**



**16**  
PEZZI

**1 1/2"**

**1 2"**

**5 16"**

↔ 210  
↑ 60  
mm ↘ 130

## 687 1/2" C16

U06870100



**Assortimento in cassetta di ABS con inserti macchina**

DESCRIZIONE	ART./MISURA	PZ.
Portainseri	685 6 1/2	1
Portainseri	685 8 5/16	1
Inseri esagono maschio 1/2	687 E 6-7-8-10-12-14	6
Inseri TORX 1/2	687 TX T30-T40-T45-T50-T55	5
Inseri PHILLIPS 5/16	686 PH 2-3-4	3

~~€ 197,00~~

**€ 106,00**



**16**  
PEZZI

**1 2"**

↔ 375  
↑ 80  
mm ↘ 186

## 235 1/2" M/C16

U02359285



**Assortimento in cassetta modulare con bussole macchina esagonali**

DESCRIZIONE	ART./MISURA	PZ.
Chiavi a bussola macchina con bocca esagonale	235 1/2 M 10-12-13-14-15-16-17-18-19-21-22-24-27-30-32 mm	15
Spina di tenuta	235 MCA/4-6	2
Anello di sicurezza	235 MDA/4-6	2
Prolunghe macchina	236 1/2 M/125	1

~~€ 234,00~~

**€ 117,00**



**6**  
PEZZI

**3 4"**

**7 8"**

↔ 210  
↑ 60  
mm ↘ 130

## 688 3/4" MD6

U06880010



**Assortimento in cassetta di ABS con inserti macchina**

DESCRIZIONE	ART./MISURA	PZ.
Portainseri	685 B 1 7/8	1
Inseri esagono maschio 7/8	688 E 12-17-19-22-24	5

~~€ 232,00~~

**€ 159,00**



**8**  
PEZZI

**3 4"**

↔ 375  
↑ 80  
mm ↘ 186

## 235 3/4" M/C8

U02359286



**Assortimento in cassetta modulare con bussole macchina esagonali**

DESCRIZIONE	ART./MISURA	PZ.
Chiavi a bussola macchina con bocca esagonale	235 3/4" M 21-22-24-27-30-32-36-41 mm	8

~~€ 240,00~~

**€ 127,00**

## BUSSOLE MACCHINA RIBASSATE 235 MB



1/2"

10 PEZZI

→ 190  
↓ 58  
mm ↗ 144



1/2"

1/2"

22 PEZZI

→ 415  
↓ 92  
mm ↗ 283

### 235 1/2" MB/C10 U02350530



Assortimento in cassetta modulare con bussole macchina esagonali ribassate

DESCRIZIONE	ART./MISURA	PZ.
Chiavi a bussola macchina ribassate esagonali	235 1/2" M 10-11-12-13-14-15-16-17-18-19	10

€ 91,50

**€ 59,00**

### 236 KE/C22 U02360900



Assortimento in cassetta modulare con bussole macchina esagonali ribassate, prolunga a catena, inserti e accessori

DESCRIZIONE	ART./MISURA	PZ.
Chiavi a bussola macchina ribassate esagonali	235 1/2" MB 13-14-15-16-17-18-19	7
Prolunga a catena	236 KE 1/2"	1
Inserti macchina esagonali	687 E 5-6-8-10-12-14	6
Inserti macchina TORX	687 TX T25-T27-T30-T40-T45-T50-T55	7
Adattatore per bussole	236 KEADP	1

€ 387,00

**€ 199,00**

UTILIZZABILI CON  
AVVITATORE AD IMPULSI

## 236 K per bussole



YouTube

## 236 KE per inserti



YouTube

MASSIMA ACCESSIBILITÀ  
DIMENSIONI TESTA COME UN  
CRICCHETTO\*.



39 mm

\*Confronto con cricchetto da 1/2".

MINIMO INGOMBRO  
INNESTO DIRETTO PER  
INSERTI MACCHINA.



Anello di tenuta in acciaio integrato.

### 236 K

1/2" 1/4"

Prolunga a catena in alluminio per bussole

CODICE	□	L	H	🛒	
U02360700	1/2"	340 mm	39 mm	1,1 kg	€ 118,00 <b>€ 59,00</b>
U02360698	1/4"	260 mm	27 mm	300 g	€ 89,00 <b>€ 49,00</b>

### 236 KE

1/2" 1/2" 1/4" 1/4"

Prolunga a catena in alluminio per inserti

CODICE	□	◊	L	H	🛒	
U02360705	1/2"	1/2"	340 mm	24 mm	1,1 kg	€ 118,00 <b>€ 59,00</b>
U02360710	1/4"	1/4"	260 mm	19 mm	300 g	€ 89,00 <b>€ 49,00</b>



# IL CATALOGO COMPLETO A PORTATA DI MANO E SEMPRE AGGIORNATO!



## Scarica l'App!

- Funziona offline.
- Notifiche push.
- Leggera.



## SU SMARTPHONE E TABLET.

**Sei un utilizzatore finale e vuoi contattarci?**

Vai sul nostro sito:



**[usag.it/it/contacts/support](https://usag.it/it/contacts/support)**



Oppure chiamaci: tel. 02.8295.3731 da Lunedì a Venerdì dalle 08:30 alle 19:30.



**Stanley Black & Decker Italia S.r.l.**

Sede operativa:

Via Volta, 3 - 21020 - Monvalle (VA)

Tel. +39 0332 790 111 - [info.mv@usag.it](mailto:info.mv@usag.it)

**usag.it**

