

ARROW
EXHAUST

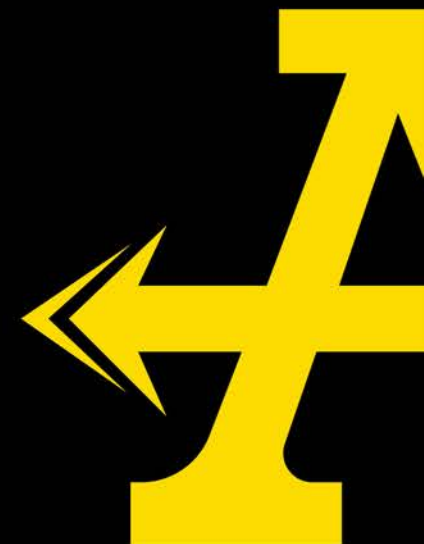

PRODUCT CATALOGUE N° 040

JANUARY 2022

KEY

SYMBOLS RELATING TO THE HOMOLOGATION OF THE EXHAUST SYSTEMS

 **Dir. 97/24/EC ch. 5 (EU)**
(measures to be taken against air pollution)

 **Dir. 97/24/EC ch. 9 (EU)**
(permissible sound level)

 Meets present standards referred to air pollution and permissible sound level #.

 **Reg. 134/2014 ann. 10 (EC-UE) - EURO4 / EURO5 ***
(measures to be taken against air pollution)

 **Reg. R92.01 (ECE-ONU) - EURO4 / EURO5 ***
(permissible sound level)

 Meets present standards referred to air pollution and permissible sound level #.

 *** NOTE** Homologation certificates are valid only for vehicle types specified on this catalogue and updates

 **# NOTE** Meeting the standards above is guaranteed only if:
- the original catalytic converter is not removed
- when fitting an Arrow silencer and catalytic converter approved following the standards referred above.

 Meets **CARB** directive
(**California Air Resources Board** - www.arb.ca.gov)
This product is considered "replacement part" as per CARB requirements only when the original catalytic converter(s) are not been modified or replaced and when no modifications are made on ECU settings and to exhaust sensors.
No Executive Order has been granted to or has been required by Arrow Special Parts S.p.A. nor to its subsidiaries or authorized representatives.

 Not street legal
(for closed circuit use only)

Fitment - The continuous line means that it is necessary to fit all the components



Option for fitment - The dotted line means that it is not needed to fit all the components

1

Round-Sil

2

Round-Sil
Pro-Race
GP2

3

Thunder
Mini X-Kone

4

Indy Race
Works

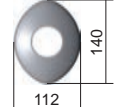
5

Mini Thunder

7

Maxi Race-Tech

8

Race-Tech
X-Kone

9

Sonora

10

Pro-Racing
Rebel

SYMBOLS RELATING TO THE HOMOLOGATION OF VEHICLES

EURO3

Vehicle approved according to European directives
92 / 61 CE
2002 / 24 CE
and subsequent changes

EURO4

Vehicle approved according to European regulation
UE 168 / 2013
EURO4
and subsequent changes

EURO5

Vehicle approved according to European regulation
UE 168 / 2013
EURO5
and subsequent changes

Unless expressly specified, the vehicle is to be considered EURO3 approved or earlier

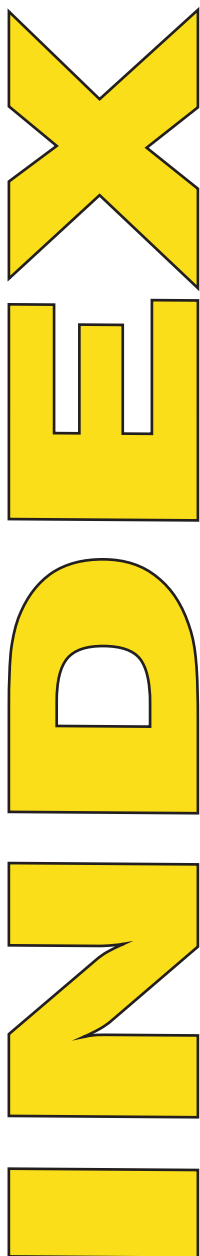

LISTINO FIGURATO PER MARCA / CATALOGUE WITH PICTURES (LISTED BY BRAND)	Page	2 ..199
APRILIA	Page	2
BENELLI	Page	14
BETA	Page	17
BMW	Page	18
BRIXTON	Page	33
DUCATI	Page	35
GILERA	Page	48
HONDA	Page	49
HUSQVARNA	Page	87
KAWASAKI	Page	91
KTM	Page	113
KSR Moto	Page	130
KYMCO	Page	130
MALAGUTI	Page	136
MOTO GUZZI	Page	137
MV AGUSTA	Page	138
PEUGEOT	Page	139
PIAGGIO	Page	140
SUZUKI	Page	148
SYM	Page	162
TRIUMPH	Page	163
UM Moto	Page	164
YAMAHA	Page	165
ENDURO 4T	Page	200
SILENZIATORI UNIVERSALI / UNIVERSAL SILENCERS	Page	201
DB-KILLER	Page	201
ACCESSORI VARI / ACCESSORIES	Page	202
MATERIALE PROMOZIONALE / CLOTHING LINE & DISPLAYS	Page	203

APRILIA**RX / SX 125 '18/20** EURO4 VEHICLE TYPE: **KX - KX1****THUNDER CARBON CAP**

	 HOMOL.
TITANIUM	52509PK *
ALUMINIUM	52509AK *
ALUMINIUM "DARK"	52509AKN *

THUNDER STEEL CAP

	 HOMOL.
ALUMINIUM	52509AO *
ALUMINIUM "DARK"	52509AON *

3



3

COLLETORE CATALITICO OMOLOGATO
CATALYTIC HOMOLOGATED COLLECTOR
52001PZ *COLLETORE RACING
RACING COLLECTOR
52001PD *

* **TUTTI I COMPONENTI SONO INTERCambiABILI CON QUELLI ORIGINALI**
ALL THE COMPONENTS ARE INTERCHANGEABLE WITH THE ORIGINAL ONES

APRILIA**RS4 125 '11/16** VEHICLE TYPE: **KS**
 THUNDER ALLUMINIO OMOLOGATO
THUNDER ALUMINIUM HOMOLOGATED
51509AO

 CATALIZZATORE OMOLOGATO
HOMOLOGATED CATALYST
11013KZ

ATTENZIONE · L'OMOLOGAZIONE È VALIDA SOLO CON LA PRESENZA DEL CATALIZZATORE
ATTENTION · THE HOMOLOGATION IS VALID ONLY WITH THE CATALYST INCLUDED IN THE SYSTEM



← **Fitment** - The continuous line means that it is necessary to fit all the components

← - - - - **Option for fitment** - The dotted line means that it is not needed to fit all the components

**2**

VEHICLE TYPE: **KC - KC1**

 **THUNDER ALLUMINIO OMOLOGATO**
THUNDER ALUMINIUM HOMOLOGATED
51515AO





RACC. CATALITICO OMOLOGATO
PER COLLETTORI ORIGINALI - VERSIONE BASSA
HOMOLOGATED CATALYZED LINK PIPE
FOR ORIGINAL COLLECTORS - LOW VERSION
51013KZ



RACCORDO RACING PER
COLLETTORI ORIGINALI - VERSIONE BASSA
RACING LINK PIPE FOR
ORIGINAL COLLECTORS - LOW VERSION
51013MI





RACC. CATALITICO OMOLOGATO
PER COLLETTORI ORIGINALI - VERSIONE ALTA
HOMOLOGATED CATALYZED LINK PIPE
FOR ORIGINAL COLLECTORS - HIGH VERSION
51014KZ



RACCORDO RACING PER
COLLETTORI ORIGINALI - VERSIONE ALTA
RACING LINK PIPE FOR
ORIGINAL COLLECTORS - HIGH VERSION
51014MI



8



X-KONE
CARBON END CAP

		HOMOL.
<i>NICHROM</i>		51515XKI



Fitment - The continuous line means that it is necessary to fit all the components



Option for fitment - The dotted line means that it is not needed to fit all the components



APRILIA

SX-V 4.5 '07/14

RACING TERMINALE FULL TITANIUM
FULL TITANIUM SILENCER
75078TT *



COLLETTORI IN TITANIO
TITANIUM COLLECTORS
72086PD



COLLETTORI IN ACCIAIO INOX
STAINLESS STEEL COLLECTORS
72125PD



RACING

KIT COMPLETO
FULL SYSTEM
MX COMPETITION
"FULL TITANIUM"
75110TK

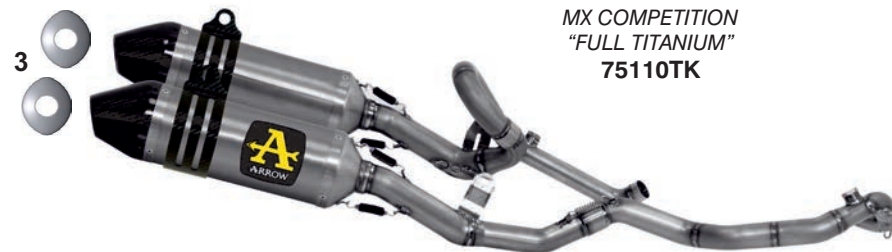

* IL TERMINALE PUÒ MONTARE ANCHE SU COLLETTORI DEL KIT «VAN DEN BOSCH REPLICA»
SILENCER ALSO FITS TO «VAN DEN BOSCH REPLICA» COLLECTORS

APRILIA

SX-V 5.5 '07/14

RACING TERMINALE FULL TITANIUM
FULL TITANIUM SILENCER
75079TT *



COLLETTORI IN TITANIO
TITANIUM COLLECTORS
72086PD



COLLETTORI IN ACCIAIO INOX
STAINLESS STEEL COLLECTORS
72125PD



RACING

KIT COMPLETO
FULL SYSTEM
MX COMPETITION
"FULL TITANIUM"
75110TK



* IL TERMINALE PUÒ MONTARE ANCHE SU COLLETTORI DEL KIT «VAN DEN BOSCH REPLICA»
SILENCER ALSO FITS TO «VAN DEN BOSCH REPLICA» COLLECTORS



← **Fitment** - The continuous line means that it is necessary to fit all the components

← - - - - **Option for fitment** - The dotted line means that it is not needed to fit all the components



VEHICLE TYPE: **VR**

**URBAN
BLACK STEEL CAP**
 **HOMOL.**
ALUMINIUM "DARK" **73501ANN**



COLLETTORE
CATALITICO OMOLOGATO
CATALYTIC HOMOLOGATED
COLLECTOR
73001KZ



COLLETTORE RACING
RACING COLLECTORS
73001MI



Fitment - The continuous line means that it is necessary to fit all the components



Option for fitment - The dotted line means that it is not needed to fit all the components



VEHICLE TYPE: **KS**

INDY RACE CARBON END CAP

	ECE	HOMOL.
TITANIUM		71929PK
CARBON FIBRE		71929MK
ALUMINIUM		71929AK
ALUMINIUM "DARK"		71929AKN



EC
COLLETTORI CATALITICI OMOLOGATI
CATALYTIC HOMOLOGATED COLLECTORS
71755KZ



COLLETTORI RACING
RACING COLLECTORS
71755MI



N.B. INSTALLANDO IL KIT COLLETTORI RACING ARROW E' NECESSARIO CARICARE LA MAPPATURA RACING RIVOLGENDOSI AD UN CONCESSIONARIO APRILIA
WHEN INSTALLING ARROW RACING COLLECTORS KIT IT IS RECOMMENDED TO UPLOAD THE RACE MAP THROUGH AN APRILIA DEALER



KIT COMPLETO / FULL SYSTEM
COMPETITION "EVO"
PRO-RACE TITANIUM SILENCER
WITH TITANIUM END CAP
CLASSIC END CAP (with dB-Killer) or
END CAP WITH MESH (no dB-Killer)
TITANIUM COLLECTORS



FONDELLO CON RETE
END CAP WITH MESH



COMPETITION "EVO"

	CLASSIC CAP		CAP with MESH
FULL TITANIUM	71215CP	FULL TITANIUM	71215CPF

KIT COMPLETO / FULL SYSTEM
COMPETITION
INDY RACE TITANIUM SILENCER
WITH CARBON END CAP AND dB-KILLER
TITANIUM CENTRAL LINK PIPE
TITANIUM COLLECTORS



COMPETITION

	CARBON CAP
FULL TITANIUM	71215CKZ



← **Fitment** - The continuous line means that it is necessary to fit all the components

← - - - **Option for fitment** - The dotted line means that it is not needed to fit all the components



APRILIA

Dorsoduro 750 '09/17  

VEHICLE TYPE: **SM**

**THUNDER
CARBON END CAP**

	 HOMOL.
ALUMINIUM	71907AK
ALUMINIUM "DARK"	71907AKN



**TERMINALI PER COLLETTORI ORIGINALI
SILENCERS FOR ORIGINAL COLLECTORS**

APRILIA

Dorsoduro 900 '17/19   

VEHICLE TYPE: **KB - KB1**



**THUNDER
CARBON END CAP**

	 HOMOL.
ALUMINIUM	71907AK *
ALUMINIUM "DARK"	71907AKN *

**RACCORDO CENTRALE
NON CATALITICO
NON CATALYZED
CENTRAL LINK PIPE
71724MI ***



*** TUTTI I COMPONENTI SONO INTERCambiabili CON QUELLI ORIGINALI
ALL THE COMPONENTS ARE INTERCHANGEABLE WITH THE ORIGINAL ONES**



Fitment - The continuous line means that it is necessary to fit all the components



Option for fitment - The dotted line means that it is not needed to fit all the components



7



APRILIA**Tuono 1000 R - Tuono 1000 R Factory '06/10**VEHICLE TYPE: **RR****RSV 1000 R - RSV 1000 R Factory '04/08**VEHICLE TYPE: **RR****RACE-TECH
STEEL END CAP**

	 HOMOL.
ALUMINIUM	71677AO
ALUMINIUM "DARK"	71677AON



TERMINALI PER COLLETTORI ORIGINALI
SILENCERS FOR ORIGINAL COLLECTORS

**APRILIA****Tuono V4 R '11/15**VEHICLE TYPE: **TY****RACE-TECH CARBON CAP**

	 HOMOL.
TITANIUM	71744PK
CARBON FIBRE	71744MK
ALUMINIUM	71744AK
ALUMINIUM "DARK"	71744AKN

GP2 SILENCERS

	RACING
FULL TITANIUM	71009GP *
STEEL "DARK"	71009GPI *

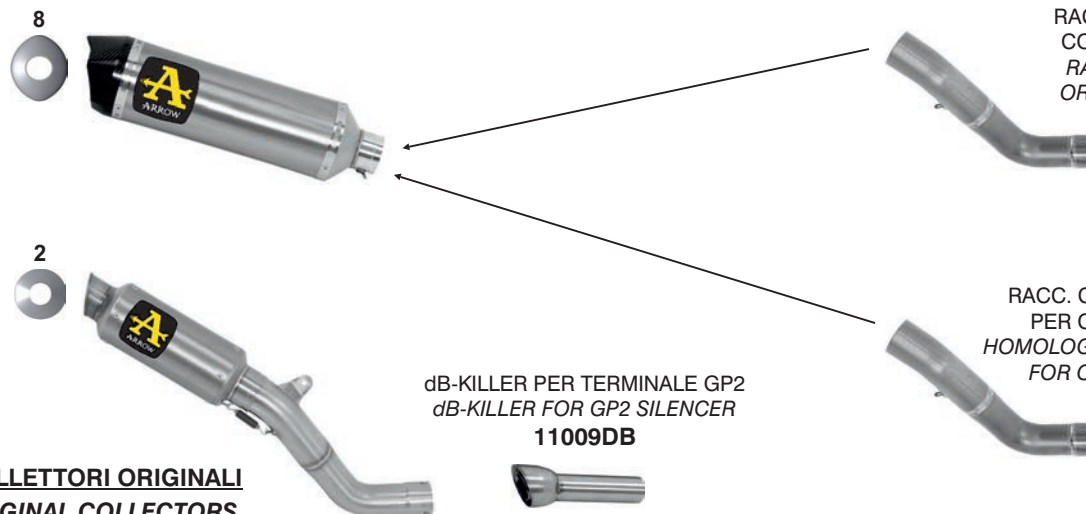

RACCORDO RACING PER
COLLETTORI ORIGINALI
RACING LINK PIPE FOR
ORIGINAL COLLECTORS
71406MI

RACC. CATALITICO OMOLOGATO
PER COLLETTORI ORIGINALI
HOMOLOGATED CATALYZED LINK PIPE
FOR ORIGINAL COLLECTORS
71406KZ

dB-KILLER PER TERMINALE GP2
dB-KILLER FOR GP2 SILENCER
11009DB



* **TERMINALI PER COLLETTORI ORIGINALI**
SILENCERS FOR ORIGINAL COLLECTORS



Fitment - The continuous line means that
it is necessary to fit all the components



Option for fitment - The dotted line means that
it is not needed to fit all the components

**8**

VEHICLE TYPE: **TY**



RACE-TECH CARBON CAP

	HOMOL.
TITANIUM	71744PK
CARBON FIBRE	71744MK
ALUMINIUM	71744AK
ALUMINIUM "DARK"	71744AKN



5
 RACCORDO CATALITICO OMOLOGATO
 PER COLLETTORI ORIGINALI INNESTO ø60mm
 CATALYTIC HOMOLOGATED LINK PIPE
 FOR ORIGINAL COLLECTORS INLET DIAMETER ø60mm
71627KZ



RACCORDO RACING PER COLLETTORI ORIGINALI
 INNESTO ø60mm
 RACING LINK PIPE FOR ORIGINAL COLLECTORS
 INLET DIAMETER ø60mm
71627MI



5
 RACCORDO CATALITICO OMOLOGATO
 PER COLLETTORI ORIGINALI INNESTO ø 56mm
 CATALYTIC HOMOLOGATED LINK PIPE
 FOR ORIGINAL COLLECTORS INLET DIAMETER ø56mm
71652KZ



RACCORDO RACING PER COLLETTORI ORIGINALI
 INNESTO ø 56mm
 RACING LINK PIPE FOR ORIGINAL COLLECTORS
 INLET DIAMETER ø56mm
71652MI



← **Fitment** - The continuous line means that it is necessary to fit all the components

← - - - **Option for fitment** - The dotted line means that it is not needed to fit all the components



VEHICLE TYPE: **KG**



RACE-TECH CARBON CAP

	EC ECE	HOMOL.
TITANIUM		71744PK
CARBON FIBRE		71744MK
ALUMINIUM		71744AK
ALUMINIUM "DARK"		71744AKN

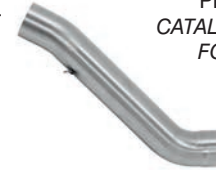

EC
RACCORDO CATALITICO OMOLOGATO
PER COLLETTORI ORIGINALI
CATALYTIC HOMOLOGATED LINK PIPE
FOR ORIGINAL COLLECTORS
71674KZ



RACCORDO RACING
PER COLLETTORI ORIGINALI
RACING LINK PIPE
FOR ORIGINAL COLLECTORS
71674MI

N.B. INSTALLANDO UNO DEI KIT ARROW È NECESSARIO DISATTIVARE IL CONTROLLO VALVOLA ALLO SCARICO.
PER SAPERE COME FARE LEGGERE LA NOTA INFORMATIVA SUL NOSTRO SITO.
! WHEN INSTALLING ANY OF THE ARROW LINK PIPES IT IS NEEDED TO DE-ACTIVATE THE VALVE FUNCTION.
ALL INFORMATION ARE AVAILABLE IN THE TECHNICAL NOTE IN ARROW WEBSITE



GP2 SILENCERS

	EC ECE	HOMOL.
TITANIUM		71535GP *
NICHROM "DARK"		71535GPI *



PRO-RACE SILENCERS

	RACING
NICHROM	71210PRI *
NICHROM "DARK"	71210PRN *

! * TERMINALI PER COLLETTORI ORIGINALI
SILENCERS FOR ORIGINAL COLLECTORS



← **Fitment** - The continuous line means that it is necessary to fit all the components



← **Option for fitment** - The dotted line means that it is not needed to fit all the components



VEHICLE TYPE: **KG1**



**RACE-TECH
CARBON END CAP**

	ECE HOMOL.
TITANIUM	71906PK
CARBON FIBRE	71906MKK
ALUMINIUM	71906AK
ALUMINIUM "DARK"	71906AKN



PRO-RACE STEEL CAP

	RACING
NICHROM	71214PRI *
NICHROM "DARK"	71214PRN *



EC

RACCORDO CATALITICO OMOLOGATO
IN TITANIO PER COLLETTORI ORIGINALI
TITANIUM LINK PIPE
CATALYTIC HOMOLOGATED
FOR ORIGINAL COLLECTORS
71746KZ



RACCORDO RACING IN TITANIO
PER COLLETTORI ORIGINALI
TITANIUM RACING LINK PIPE
FOR ORIGINAL COLLECTORS
71746MI



EC

RACCORDO CATALITICO OMOLOGATO
IN ACCIAIO INOX PER COLLETTORI ORIGINALI
STAINLESS STEEL LINK PIPE
CATALYTIC HOMOLOGATED
FOR ORIGINAL COLLECTORS
71674KZ



RACCORDO RACING IN ACCIAIO INOX
PER COLLETTORI ORIGINALI
STAINLESS STEEL RACING LINK PIPE
FOR ORIGINAL COLLECTORS
71674MI

**⚠ * TERMINALI PER COLLETTORI ORIGINALI
SILENCERS FOR ORIGINAL COLLECTORS**

N.B. INSTALLANDO UNO DEI KIT ARROW È NECESSARIO DISATTIVARE IL CONTROLLO VALVOLA ALLO SCARICO.
PER SAPERE COME FARE LEGGERE LA NOTA INFORMATIVA SUL NOSTRO SITO.
⚠ WHEN INSTALLING ANY OF THE ARROW LINK PIPES IT IS NEEDED TO DE-ACTIVATE THE VALVE FUNCTION.
ALL INFORMATION ARE AVAILABLE IN THE TECHNICAL NOTE IN ARROW WEBSITE



← **Fitment** - The continuous line means that it is necessary to fit all the components

← - - - **Option for fitment** - The dotted line means that it is not needed to fit all the components



APRILIA

RSV 4 - RSV 4 Factory '09/15



VEHICLE TYPE: **RK**

RACE-TECH CARBON CAP

	HOMOL.
TITANIUM	71744PK
CARBON FIBRE	71744MK
ALUMINIUM	71744AK
ALUMINIUM "DARK"	71744AKN

GP2 SILENCERS

	RACING
FULL TITANIUM	71009GP *
STEEL "DARK"	71009GPI *

* **TERMINALI PER COLLETTORI ORIGINALI**
SILENCERS FOR ORIGINAL COLLECTORS



dB-KILLER PER TERMINALE GP2
dB-KILLER FOR GP2 SILENCER
11009DB



RACCORDO RACING PER COLLETTORI ORIGINALI
RACING LINK PIPE FOR ORIGINAL COLLECTORS
71406MI



RACC. CATALITICO OMOLOGATO PER COLLETTORI ORIGINALI
HOMOLOGATED CATALYZED LINK PIPE FOR ORIGINAL COLLECTORS
71406KZ



APRILIA

RSV 4 RR - RSV 4 RF '15/16



VEHICLE TYPE: **RK**

RACE-TECH CARBON CAP

	HOMOL.
TITANIUM	71744PK
CARBON FIBRE	71744MK
ALUMINIUM	71744AK
ALUMINIUM "DARK"	71744AKN

GP2 SILENCERS

	HOMOL.
FULL TITANIUM	71520GP *
STEEL "DARK"	71520GPI *

* **TERMINALI PER COLLETTORI ORIGINALI**
SILENCERS FOR ORIGINAL COLLECTORS



RACCORDO CATALITICO OMOLOGATO PER COLLETTORI ORIGINALI
CATALYTIC HOMOLOGATED LINK PIPE FOR ORIGINAL COLLECTORS
71627KZ



RACCORDO RACING PER COLLETTORI ORIGINALI
RACING LINK PIPE FOR ORIGINAL COLLECTORS
71627MI

TERMINALE PRO-RACE IN TITANIO + RACCORDO INOX PER COLLETTORI ORIGINALI
PRO-RACE TITANIUM SILENCER + STEEL LINK PIPE FOR ORIGINAL COLLECTORS
71201PR



Fitment - The continuous line means that it is necessary to fit all the components



Option for fitment - The dotted line means that it is not needed to fit all the components



VEHICLE TYPE: KE



RACE-TECH CARBON CAP

	ECE	HOMOL.
TITANIUM	71744PK	
CARBON FIBRE	71744MK	
ALUMINIUM	71744AK	
ALUMINIUM "DARK"	71744AKN	

EC

RACCORDO CATALITICO OMOLOGATO PER COLLETTORI ORIGINALI
CATALYTIC HOMOLOGATED LINK PIPE FOR ORIGINAL COLLECTORS
71674KZ



RACCORDO RACING PER COLLETTORI ORIGINALI
RACING LINK PIPE FOR ORIGINAL COLLECTORS
71674MI



N.B. INSTALLANDO UNO DEI KIT ARROW È NECESSARIO DISATTIVARE IL CONTROLLO VALVOLA ALLO SCARICO.
PER SAPERE COME FARE LEGGERE LA NOTA INFORMATIVA SUL NOSTRO SITO.
WHEN INSTALLING ANY OF THE ARROW LINK PIPES IT IS NEEDED TO DE-ACTIVATE THE VALVE FUNCTION.
ALL INFORMATION ARE AVAILABLE IN THE TECHNICAL NOTE IN ARROW WEBSITE



GP2 SILENCERS

	ECE	HOMOL.
TITANIUM	71542GP *	
NICHROM "DARK"	71542GPI *	



PRO-RACE STEEL CAP

	RACING
NICHROM	71214PRI *
NICHROM "DARK"	71214PRN *



* TERMINALI PER COLLETTORI ORIGINALI
SILENCERS FOR ORIGINAL COLLECTORS



← **Fitment** - The continuous line means that it is necessary to fit all the components



← - - - **Option for fitment** - The dotted line means that it is not needed to fit all the components



VEHICLE TYPE: **KE**

RACE-TECH CARBON CAP

	ECE	HOMOL.
TITANIUM	71906PK	
CARBON FIBRE	71906MK	
ALUMINIUM	71906AK	
ALUMINIUM "DARK"	71906AKN	



EC

RACCORDO CATALITICO OMOLOGATO
PER COLLETTORI ORIGINALI
CATALYTIC HOMOLOGATED LINK PIPE
FOR ORIGINAL COLLECTORS
71674KZ



RACCORDO RACING
PER COLLETTORI ORIGINALI
RACING LINK PIPE
FOR ORIGINAL COLLECTORS
71674MI



N.B. INSTALLANDO UNO DEI KIT ARROW È NECESSARIO DISATTIVARE IL CONTROLLO VALVOLA ALLO SCARICO. PER SAPERE COME FARE LEGGERE LA NOTA INFORMATIVA SUL NOSTRO SITO.
WHEN INSTALLING ANY OF THE ARROW LINK PIPES IT IS NEEDED TO DE-ACTIVATE THE VALVE FUNCTION. ALL INFORMATION ARE AVAILABLE IN THE TECHNICAL NOTE IN ARROW WEBSITE



VEHICLE TYPE: **P10**

THUNDER CARBON CAP

	ECE	HOMOL.
TITANIUM	71827PK	
CARBON FIBRE	71827MK	
ALUMINIUM	71827AK	
ALUMINIUM "DARK"	71827AKN	



RACCORDO PER COLLETTORI ORIGINALI
LINK PIPE FOR ORIGINAL COLLECTORS
71721MI



THUNDER STEEL CAP

	ECE	HOMOL.
ALUMINIUM	71827AO	
ALUMINIUM "DARK"	71827AON	



Fitment - The continuous line means that it is necessary to fit all the components



Option for fitment - The dotted line means that it is not needed to fit all the components



BENELLI**TRK 502 '17/20**

EURO4

VEHICLE TYPE: **P16**RACE-TECH
CARBON END CAP

	ECE	HOMOL.
ALUMINIUM	71878AK	
ALUMINIUM "DARK"	71878AKN	

8



EC

RACCORDO CATALITICO OMOLOGATO
CATALYTIC HOMOLOGATED LINK PIPE
71689KZRACCORDO RACING
RACING LINK PIPE
71689MI**BENELLI****TRK 502 X '18/20**

EURO4

VEHICLE TYPE: **P16**

8

RACE-TECH
CARBON END CAP

	ECE	HOMOL.
TITANIUM	71889PK *	
ALUMINIUM	71889AK *	
ALUMINIUM "DARK"	71889AKN *	

COLLETTORI RACING
RACING COLLECTORS
71700MI ** **TUTTI I COMPONENTI SONO INTERCAMBIABILI CON QUELLI ORIGINALI**
ALL THE COMPONENTS ARE INTERCHANGEABLE WITH THE ORIGINAL ONES← **Fitment** - The continuous line means that it is necessary to fit all the components← **Option for fitment** - The dotted line means that it is not needed to fit all the components**15**

VEHICLE TYPE: P18



PRO-RACE
STEEL END CAP

	ECE	HOMOL.
NICHROM	71879PRI *	
NICHROM "DARK"	71879PRN *	



COLLETTORI RACING
RACING COLLECTORS
71691MI *



* TUTTI I COMPONENTI SONO INTERCAMBIABILI CON QUELLI ORIGINALI
ALL THE COMPONENTS ARE INTERCHANGEABLE WITH THE ORIGINAL ONES

VEHICLE TYPE: P36



WORKS
CARBON END CAP

	ECE	HOMOL.
TITANIUM	71909PK *	
NICHROM "DARK"	71909PKN *	

RACCORDO RACING
RACING LINK PIPE
71725MI *



* TUTTI I COMPONENTI SONO INTERCAMBIABILI CON QUELLI ORIGINALI
ALL THE COMPONENTS ARE INTERCHANGEABLE WITH THE ORIGINAL ONES



← **Fitment** - The continuous line means that it is necessary to fit all the components

← - - - - **Option for fitment** - The dotted line means that it is not needed to fit all the components



BENELLI

752 S '19/20

EURO4 **EC ECE** **CARB**

VEHICLE TYPE: **P29**

**PRO-RACE
STEEL END CAP**

	ECE	HOMOL.
NICHROM	71908PRI	
NICHROM "DARK"	71908PRN	



TERMINALI PER COLLETTORI ORIGINALI
SILENCERS FOR ORIGINAL COLLECTORS



BETA

RR 350 - 390 - 430 - 480 '20



TERMINALI PER COLLETTORE ORIGINALE
SILENCERS FOR ORIGINAL COLLECTOR



Fitment - The continuous line means that it is necessary to fit all the components

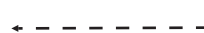

Option for fitment - The dotted line means that it is not needed to fit all the components



BMW**C 650 Sport '16/20** EURO4 EC
ECEVEHICLE TYPE: **3C65**ECRACCORDO CATALITICO OMOLOGATO
CATALYTIC HOMOLOGATED LINK PIPE
73009KZ #RACCORDO RACING
RACING LINK PIPE
73009MI #COLLETTORI RACING
RACING COLLECTORS
73010MI *RACE-TECH
CARBON END CAP

	ECE	HOMOL.
TITANIUM		73512PK
ALUMINIUM		73512AK
ALUMINIUM "DARK"		73512AKN

* I COLLETTORI 73010MI MONTANO ANCHE CON TERMINALE ORIGINALE
73010MI COLLECTORS ALSO FIT TO ORIGINAL SILENCER# I RACCORDI 73009MI e 73009KZ MONTANO ANCHE SU COLLETTORI ORIGINALI
73009MI AND 73009KZ LINK PIPES ALSO FIT TO ORIGINAL COLLECTORS**BMW****G 650 GS - G 650 GS Sertao '11/16** ECE
2006/120/CEVEHICLE TYPE: **E650G**5RACCORDO CATALITICO OMOLOGATO
PER COLLETTORI ORIGINALI
CATALYTIC HOMOLOGATED LINK PIPE
FOR ORIGINAL COLLECTORS
71453KZRACCORDO RACING PER
COLLETTORI ORIGINALI
RACING LINK PIPE FOR
ORIGINAL COLLECTORS
71453MIRACE-TECH
CARBON END CAP

	9	HOMOL.
ALUMINIUM		72615AK
ALUMINIUM "DARK"		72615AKN

Fitment - The continuous line means that
it is necessary to fit all the componentsOption for fitment - The dotted line means that
it is not needed to fit all the components**18**

BMW**F 650 GS '08/12**VEHICLE TYPE: **E8GS****MAXI RACE-TECH
CARBON END CAP**

	HOMOL.
TITANIUM	72612PK
ALUMINIUM	72612AK
ALUMINIUM "DARK"	72612AKN

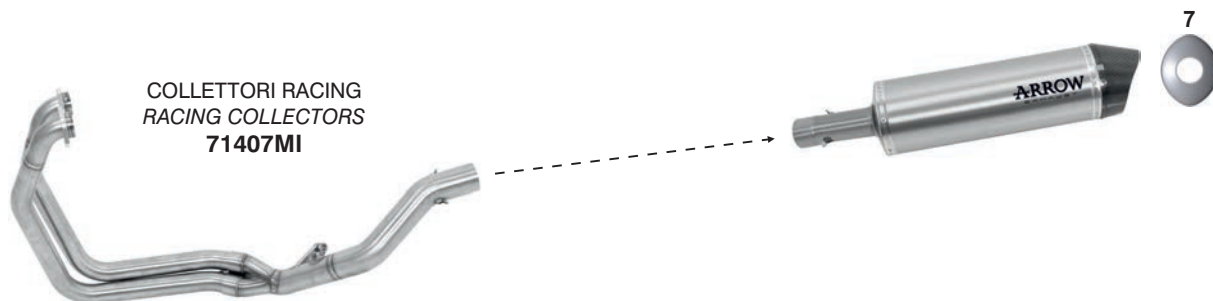
**TERMINALI PER COLLETTORI ORIGINALI
SILENCERS FOR ORIGINAL COLLECTORS****BMW****F 800 GS '08/16 - F 800 GS Adventure '13/16**VEHICLE TYPE: **E8GS****MAXI RACE-TECH
CARBON END CAP**COLLETTORI RACING
RACING COLLECTORS
71407MI

	HOMOL.
TITANIUM	72612PK *
ALUMINIUM	72612AK *
ALUMINIUM "DARK"	72612AKN *

*** I TERMINALI MONTANO ANCHE SU COLLETTORI ORIGINALI
SILENCERS ALSO FIT TO ORIGINAL COLLECTORS**← **Fitment** - The continuous line means that it is necessary to fit all the components← **Option for fitment** - The dotted line means that it is not needed to fit all the components**19**

VEHICLE TYPE: **4G80**

**MAXI RACE-TECH
CARBON END CAP**



	ECE	HOMOL.
TITANIUM		72612PK
ALUMINIUM		72612AK
ALUMINIUM "DARK"		72612AKN

**TERMINALI PER COLLETTORI ORIGINALI
SILENCERS FOR ORIGINAL COLLECTORS**



VEHICLE TYPE: **E8ST**

**MAXI RACE-TECH
CARBON END CAP**



COLLETTORI RACING
RACING COLLECTORS
71408MI



	EU	HOMOL.
TITANIUM		71746PK *#
ALUMINIUM		71746AK *#
ALUMINIUM "DARK"		71746AKN *#



*** I TERMINALI MONTANO ANCHE SU COLLETTORI ORIGINALI
SILENCERS ALSO FIT TO ORIGINAL COLLECTORS**



**# I TERMINALI NON MONTANO CON LE VALIGIE ORIGINALI BMW
SILENCERS NOT TO BE FITTED TO ORIGINAL BMW SIDE-BAGS**



← **Fitment** - The continuous line means that it is necessary to fit all the components

← - - - - **Option for fitment** - The dotted line means that it is not needed to fit all the components



BMW**F 850 GS '18/20** EURO4 EC ECE CARB

VEHICLE TYPE: 4G85

**MAXI RACE-TECH
CARBON END CAP**

	ECE	HOMOL.
TITANIUM	72629PK *	
ALUMINIUM	72629AK *	
ALUMINIUM "DARK"	72629AKN *	

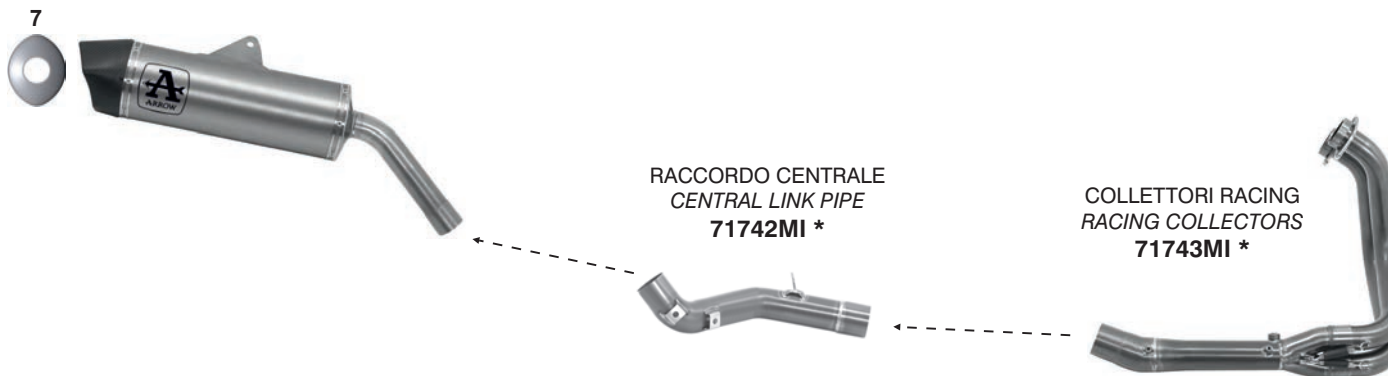

* **TUTTI I COMPONENTI SONO INTERCAMBIABILI CON QUELLI ORIGINALI**
ALL THE COMPONENTS ARE INTERCHANGEABLE WITH THE ORIGINAL ONES

BMW**F 900 R - F 900 XR '20/21** EURO5 EC ECE CARB

VEHICLE TYPE: 4R90

INDY RACE CARBON CAP

	ECE	HOMOL.
TITANIUM	71915PK	
ALUMINIUM	71915AK	
ALUMINIUM "DARK"	71915AKN	

PRO-RACE TITANIUM CAP

	ECE	HOMOL.
TITANIUM	71915PR	

PRO-RACE STEEL CAP

	ECE	HOMOL.
NICHROM	71915PRI	
NICHROM "DARK"	71915PRN	

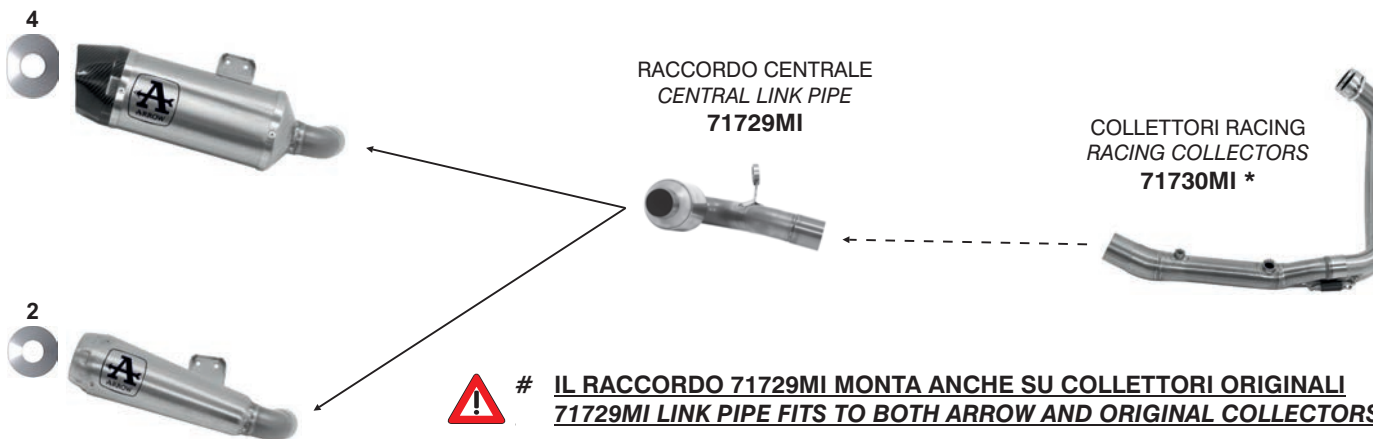

IL RACCORDO 71729MI MONTA ANCHE SU COLLETTORI ORIGINALI
71729MI LINK PIPE FITS TO BOTH ARROW AND ORIGINAL COLLECTORS



* **I COLLETTORI 71730MI MONTANO ANCHE CON TERMINALE ORIGINALE**
71730MI COLLECTORS ALSO FIT TO ORIGINAL SILENCER



← **Fitment** - The continuous line means that it is necessary to fit all the components



← **Option for fitment** - The dotted line means that it is not needed to fit all the components

**21**

VEHICLE TYPE: **K10**

VEHICLE TYPE: **2X10**



**RACE-TECH
CARBON END CAP**

	9 ECE	HOMOL.
TITANIUM	71837PK *	
ALUMINIUM	71837AK *	
ALUMINIUM "DARK"	71837AKN *	



COLLETTORI RACING
RACING COLLECTORS
71631MI *



* **TUTTI I COMPONENTI SONO INTERCAMBIABILI CON QUELLI ORIGINALI**
ALL THE COMPONENTS ARE INTERCHANGEABLE WITH THE ORIGINAL ONES

VEHICLE TYPE: **2X99**



**WORKS
CARBON END CAP**

	4 ECE	HOMOL.
TITANIUM	71927PK *	



COLLETTORI RACING
RACING COLLECTORS
71751MI *

**RACE-TECH
CARBON END CAP**

	8 ECE	HOMOL.
TITANIUM	71926PK *	
ALUMINIUM	71926AK *	
ALUMINIUM "DARK"	71926AKN *	



* **TUTTI I COMPONENTI SONO INTERCAMBIABILI CON QUELLI ORIGINALI**
ALL THE COMPONENTS ARE INTERCHANGEABLE WITH THE ORIGINAL ONES



← **Fitment** - The continuous line means that it is necessary to fit all the components

← - - - **Option for fitment** - The dotted line means that it is not needed to fit all the components



BMW**S 1000 R '14/16**VEHICLE TYPE: **K10**

WORKS CARBON END CAP

		HOMOL.
TITANIUM		71750PK *

* TERMINALE PER COLLETTORI ORIGINALI SENZA DB-KILLER
SILENCER FOR ORIGINAL COLLECTORS WITHOUT DB-KILLER

COMPETITION

	CARBON CAP
FULL TITANIUM	71140CKZ
STEEL COLLECT.	71139CKZ

COMPETITION "EVO"

	CARBON CAP
FULL TITANIUM	71145CKZ
STEEL COLLECT.	71144CKZ

KIT COMPLETO / FULL SYSTEM
COMPETITIONRACE-TECH TITANIUM SILENCER
WITH CARBON END CAP
AND dB-KILLER
TITANIUM LINK PIPE
STEEL OR TITANIUM
COLLECTORSKIT COMPLETO / FULL SYSTEM
COMPETITION "EVO"
WORKS TITANIUM SILENCER
WITH CARBON END CAP AND dB-KILLER
TITANIUM LINK PIPE
STEEL OR TITANIUM COLLECTORS**BMW****S 1000 R '17/20**

EURO4

VEHICLE TYPE: **2R10**

PRO-RACE TITANIUM CAP

		HOMOL.
TITANIUM		71872PR *



PRO-RACE STEEL CAP

		HOMOL.
NICHROM		71872PRI *
NICHROM "DARK"		71872PRN *



GP2 SILENCERS

		HOMOL.
FULL TITANIUM		71539GP *
NICHROM "DARK"		71539GP1 *



RACE-TECH CARBON CAP

		HOMOL.
TITANIUM		71872PK *
ALUMINIUM		71872AK *
ALUMINIUM "DARK"		71872AKN *

* TERMINALI PER COLLETTORI ORIGINALI
SILENCERS FOR ORIGINAL COLLECTORS

COMPETITION

	CARBON CAP
FULL TITANIUM	71185CKZ
STEEL COLLECT.	71184CKZ

KIT COMPLETO / FULL SYSTEM
COMPETITION
WORKS TITANIUM SILENCER
WITH CARBON END CAP AND dB-KILLER
TITANIUM LINK PIPE
STEEL OR TITANIUM COLLECTORS← **Fitment** - The continuous line means that
it is necessary to fit all the components← **Option for fitment** - The dotted line means that
it is not needed to fit all the components**23**

BMW**S 1000 RR '09/14**VEHICLE TYPE: **K10****WORKS CARBON END CAP**

	HOMOL.
TITANIUM	71750PK *



* **TERMINALE PER COLLETTORI ORIGINALI SENZA DB-KILLER**
SILENCER FOR ORIGINAL COLLECTORS WITHOUT DB-KILLER

COMPETITION

	CARBON CAP
FULL TITANIUM	71117CKZ
STEEL COLLECT.	71116CKZ

COMPETITION "EVO"

	CARBON CAP
STEEL COLLECT.	71118CKZ



KIT COMPLETO / FULL SYSTEM
COMPETITION
 RACE-TECH TITANIUM SILENCER
 WITH CARBON END CAP
 AND dB-KILLER
 TITANIUM LINK PIPE
 STEEL OR TITANIUM
 COLLECTORS



KIT COMPLETO / FULL SYSTEM
COMPETITION "EVO"
 WORKS TITANIUM SILENCER
 WITH CARBON END CAP AND dB-KILLER
 TITANIUM LINK PIPE
 STEEL OR TITANIUM COLLECTORS

**BMW****S 1000 RR '15/16**VEHICLE TYPE: **K10****X-KONE
CARBON END CAP**

	HOMOL.
NICHROM	71824XKI

**RACE-TECH
CARBON END CAP**

	HOMOL.
TITANIUM	71824PK
CARBON FIBRE	71824MK
ALUMINIUM	71824AK
ALUMINIUM "DARK"	71824AKN



RACCORDO PER COLLETTORI ORIGINALI
 LINK PIPE FOR ORIGINAL COLLECTORS
71617MI



Fitment - The continuous line means that it is necessary to fit all the components

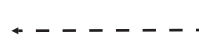

Option for fitment - The dotted line means that it is not needed to fit all the components

**24**

BMW

S 1000 RR '17/18

EURO4



PRO-RACE STEEL END CAP

	ECE	HOMOL.
NICHROM	71868PRI *	
NICHROM "DARK"	71868PRN *	

GP2 SILENCERS

	ECE	HOMOL.
FULL TITANIUM	71538GP *	
NICHROM "DARK"	71538GPI *	

RACE-TECH CARBON CAP

	ECE	HOMOL.
TITANIUM	71868PK *	
ALUMINIUM	71868AK *	
ALUMINIUM "DARK"	71868AKN *	

VEHICLE TYPE: 2R10

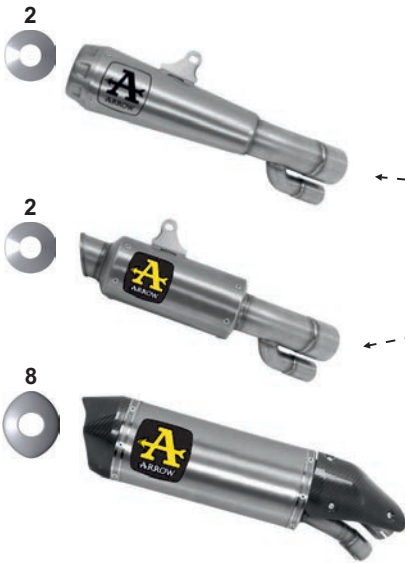

COLLETTORI RACING RACING COLLECTORS 71678MI *



* **TUTTI I COMPONENTI SONO INTERCambiabili CON QUELLI ORIGINALI**
ALL THE COMPONENTS ARE INTERCHANGEABLE WITH THE ORIGINAL ONES



BMW

S 1000 RR '15/16



S 1000 RR '17/18

EURO4



VEHICLE TYPE: K10

VEHICLE TYPE: 2R10



COMPETITION	
	CARBON CAP
FULL TITANIUM	71140CKZ
STEEL COLLECT.	71139CKZ

COMPETITION "EVO"

	CARBON CAP
FULL TITANIUM	71142CKZ
STEEL COLLECT.	71141CKZ



WORKS TITANIUM SILENCER WITH CARBON END CAP AND dB-KILLER TITANIUM LINK PIPE STEEL OR TITANIUM COLLECTORS



Fitment - The continuous line means that it is necessary to fit all the components



Option for fitment - The dotted line means that it is not needed to fit all the components



VEHICLE TYPE: 2R99

RACE-TECH CARBON CAP

	ECE	HOMOL.
TITANIUM	71903PK *	
ALUMINIUM	71903AK *	
ALUMINIUM "DARK"	71903AKN *	

PRO-RACE TITANIUM CAP

	ECE	HOMOL.
TITANIUM	71903PR *	

PRO-RACE STEEL END CAP

	ECE	HOMOL.
NICHROM	71903PRI *	
NICHROM "DARK"	71903PRN *	

GP2 SILENCERS

	ECE	HOMOL.
FULL TITANIUM	71554GP *	
NICHROM "DARK"	71554GPI *	



* **TUTTI I COMPONENTI SONO INTERCAMBIABILI CON QUELLI ORIGINALI**
ALL THE COMPONENTS ARE INTERCHANGEABLE WITH THE ORIGINAL ONES

COLLETTORI RACING
 RACING COLLECTORS
 71718MI *

KIT COMPLETO / FULL SYSTEM
COMPETITION
 RACE-TECH TITANIUM SILENCER
 WITH CARBON END CAP AND dB-KILLER
 TITANIUM LINK PIPE Ø50-65
 TITANIUM OR STEEL
 COLLECTORS

KIT COMPLETO / FULL SYSTEM
COMPETITION
 RACE-TECH CARBON FIBRE SILENCER
 WITH CARBON END CAP AND dB-KILLER
 TITANIUM LINK PIPE Ø50-65
 TITANIUM OR STEEL
 COLLECTORS

COMPETITION

	CARBON CAP
FULL TITANIUM	71205CKZ §
STEEL COLLECT.	71204CKZ §



§ **NON MONTANO CON TELAIETTO POSTERIORE ALPHA RACING**
NOT FITTING WITH ALPHA RACING REAR FRAME



← **Fitment** - The continuous line means that it is necessary to fit all the components

← **Option for fitment** - The dotted line means that it is not needed to fit all the components



BMW**S 1000 RR '19/20** EURO4 EC ECE CARBVEHICLE TYPE: **2R99**

KIT COMPLETO / FULL SYSTEM
COMPETITION "EVO"
 PRO-RACE TITANIUM SILENCER
 TITANIUM END CAP WITH dB-KILLER
 TITANIUM LINK PIPE ø50-65
 STEEL or TITANIUM
 COLLECTORS

**COMPETITION EVO**

	TITANIUM CAP
FULL TITANIUM	71207CP #
STEEL COLLECT.	71206CP #

KIT COMPLETO / FULL SYSTEM
COMPETITION LOW
 PRO-RACE TITANIUM SILENCER
 TITANIUM END CAP WITH dB-KILLER
 STEEL or TITANIUM
 COLLECTORS ø50

**COMPETITION LOW**

	TITANIUM CAP
FULL TITANIUM	71205CP #
STEEL COLLECT.	71204CP #



MONTA SU ATTACCO PEDANA ORIGINALE
FIT TO ORIGINAL FOOTREST

BMW**R 1200 GS - R 1200 GS Adventure '06/09** 9e5 2006/120CE CARBVEHICLE TYPE: **R12****MAXI RACE-TECH
CARBON END CAP**

	9e5 2006/120CE	HOMOL.
TITANIUM		71689PK
ALUMINIUM		71689AK
ALUMINIUM "DARK"		71689AKN

RACCORDO PER COLLETTORI ORIGINALI
 LINK PIPE FOR ORIGINAL COLLECTORS
71388MI #

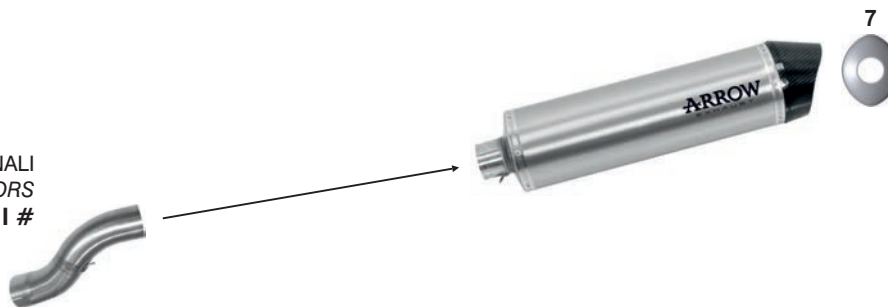

← **Fitment** - The continuous line means that it is necessary to fit all the components



← **Option for fitment** - The dotted line means that it is not needed to fit all the components

**27**

BMW**R 1200 GS - R 1200 GS Adventure '10/12**VEHICLE TYPE: **R12****MAXI RACE-TECH
CARBON END CAP**

	HOMOL.
TITANIUM	71689PK
ALUMINIUM	71689AK
ALUMINIUM "DARK"	71689AKN

ADATTATORE PER
RIMOZIONE VALVOLA
VALVE
REPLACING UNIT
11001MI

RACCORDO PER COLL. ORIGINALI
LINK PIPE FOR ORIGINAL COLLECTORS
71466MI *



* **IL RACCORDO MONTA ANCHE CON VALVOLA ORIGINALE**
LINK PIPE ALSO FITS TO ORIGINAL VALVE

**BMW****R 1200 GS - R 1200 GS Adventure '13/18**VEHICLE TYPE: **R12W - 1G12****MAXI RACE-TECH
CARBON END CAP**

	ECE HOMOL.
TITANIUM	71805PK *
ALUMINIUM	71805AK *
ALUMINIUM "DARK"	71805AKN *

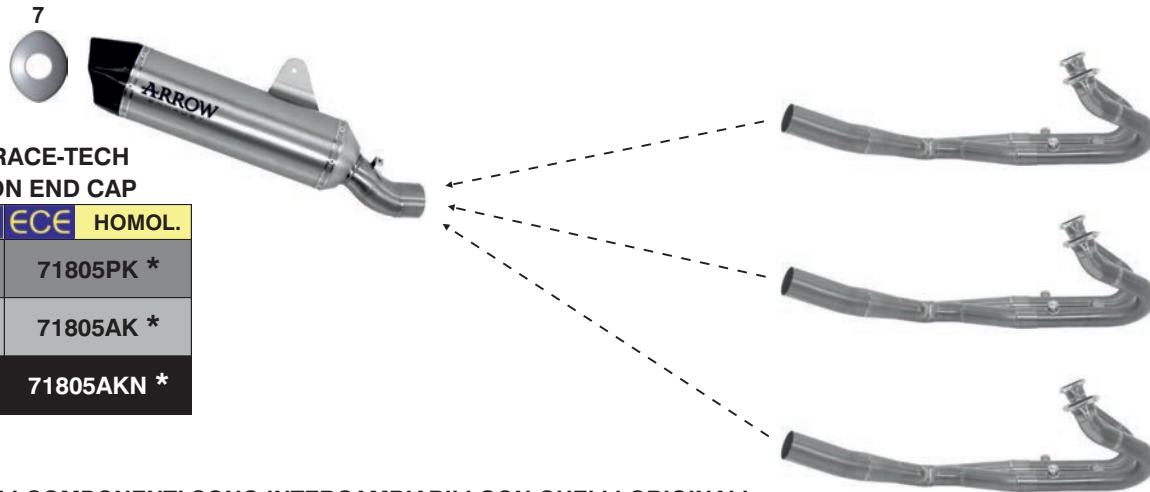

COLLETTORI CATALITICI OMOLOGATI
CATALYTIC HOMOLOGATED COLLECTORS
71632KZ *

COLLETTORI RACING IN ACCIAIO INOX
STAINLESS STEEL RACING COLLECTORS
71632MI *

COLLETTORI RACING IN TITANIO
TITANIUM RACING COLLECTORS
71731MI *



* **TUTTI I COMPONENTI SONO INTERCAMBIABILI CON QUELLI ORIGINALI**
ALL THE COMPONENTS ARE INTERCHANGEABLE WITH THE ORIGINAL ONES



← **Fitment** - The continuous line means that it is necessary to fit all the components

← - - - **Option for fitment** - The dotted line means that it is not needed to fit all the components



BMW**R 1250 GS - R 1250 GS Adventure '19/21**EURO4 EURO5  VEHICLE TYPE: **1G13****MAXI RACE-TECH
CARBON END CAP**

		HOMOL.
TITANIUM	71805PK *	
ALUMINIUM	71805AK *	
ALUMINIUM "DARK"	71805AKN *	

COLLETTORI RACING IN TITANIO
TITANIUM RACING COLLECTORS
71723MI *COLLETTORI RACING IN ACCIAIO INOX
STAINLESS STEEL RACING COLLECTORS
71722MI *

 * **TUTTI I COMPONENTI SONO INTERCAMBIABILI CON QUELLI ORIGINALI**
ALL THE COMPONENTS ARE INTERCHANGEABLE WITH THE ORIGINAL ONES

BMW**R Nine T '14/16** VEHICLE TYPE: **R1ST**COLLETTORI RACING
INTERCAMBIABILI CON
QUELLI ORIGINALI
RACING COLLECTORS
INTERCHANGEABLE WITH
ORIGINAL ONES
71654MI *ADATTATORE PER
RIMOZIONE VALVOLA
VALVE
REPLACING UNIT
11001MIRACCORDO PER
COLLETTORI ORIGINALI
LINK PIPE FOR
ORIGINAL COLLECTORS
71635MI ***R Nine T '17/19**EURO4  VEHICLE TYPE: **1N12****PRO-RACE TITANIUM CAP**

		HOMOL.
FULL TITANIUM	71503PR	

PRO-RACE STEEL CAP

		HOMOL.
NICHROM	71503PRI	
NICHROM "DARK"	71503PRN	

X-KONE CARBON CAP

		HOMOL.
NICHROM	71502XKI	
NICHROM "DARK"	71502XKN	



 * **COLLETTORI E RACCORDO MONTANO ANCHE CON VALVOLA ORIGINALE**
71654MI and 71635MI LINK PIPES ALSO FIT TO ORIGINAL VALVE



← **Fitment** - The continuous line means that it is necessary to fit all the components

← **Option for fitment** - The dotted line means that it is not needed to fit all the components



BMW**R Nine T Scrambler '16/19** EURO4  

VEHICLE TYPE: 1N12

COLLETTORI RACING
INTERCambiabili CON
QUELLI ORIGINALI
RACING COLLECTORS
INTERCHANGEABLE WITH
ORIGINAL ONES
71654MI *

ADATTATORE PER
RIMOZIONE VALVOLA
VALVE
REPLACING UNIT
11001MI

RACCORDO PER
COLLETTORI ORIGINALI
LINK PIPE FOR
ORIGINAL COLLECTORS
71657MI *



2

PRO-RACE TITANIUM CAP	
	ECE HOMOL.
FULL TITANIUM	71503PR



2

PRO-RACE STEEL CAP	
	ECE HOMOL.
NICHROM	71503PRI
NICHROM "DARK"	71503PRN



8

X-KONE CARBON CAP	
	ECE HOMOL.
NICHROM	71502XKI
NICHROM "DARK"	71502XKN

 * COLLETTORI E RACCORDO MONTANO ANCHE CON VALVOLA ORIGINALE
71654MI and 71657MI LINK PIPES ALSO FIT TO ORIGINAL VALVE

BMW**R Nine T Urban GS '17/20** EURO4  

VEHICLE TYPE: 1N12

COLLETTORI RACING
INTERCambiabili CON
QUELLI ORIGINALI
RACING COLLECTORS
INTERCHANGEABLE WITH
ORIGINAL ONES
71654MI *

ADATTATORE PER
RIMOZIONE VALVOLA
VALVE
REPLACING UNIT
11001MI *

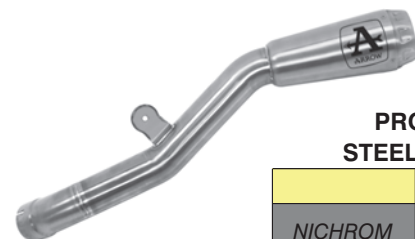

2

PRO-RACE
STEEL END CAP

	ECE HOMOL.
NICHROM	72634PRI *
NICHROM "DARK"	72634PRN *



 * **TUTTI I COMPONENTI SONO INTERCambiabili CON QUELLI ORIGINALI**
ALL THE COMPONENTS ARE INTERCHANGEABLE WITH THE ORIGINAL ONES



← **Fitment** - The continuous line means that it is necessary to fit all the components

← - - - **Option for fitment** - The dotted line means that it is not needed to fit all the components

**30**

BMW**R 1200 RT '14/16**VEHICLE TYPE: **R12WT****MAXI RACE-TECH
CARBON END CAP**

	HOMOL.
TITANIUM	71838PK *
ALUMINIUM	71838AK *
ALUMINIUM "DARK"	71838AKN *



* **TUTTI I COMPONENTI SONO INTERCAMBIABILI CON QUELLI ORIGINALI**
ALL THE COMPONENTS ARE INTERCHANGEABLE WITH THE ORIGINAL ONES



COLLETTORI CATALITICI OMOLOGATI
 CATALYTIC HOMOLOGATED COLLECTORS
71632KZ *

COLLETTORI RACING IN ACCIAIO INOX
 STAINLESS STEEL RACING COLLECTORS
71632MI *

COLLETTORI RACING IN TITANIO
 TITANIUM RACING COLLECTORS
71731MI *

**BMW****R 1200 R - R 1200 RS '15/16**VEHICLE TYPE: **R12WR****MAXI RACE-TECH
CARBON END CAP**

	HOMOL.
TITANIUM	71842PK *
ALUMINIUM	71842AK *
ALUMINIUM "DARK"	71842AKN *



* **TUTTI I COMPONENTI SONO INTERCAMBIABILI CON QUELLI ORIGINALI**
ALL THE COMPONENTS ARE INTERCHANGEABLE WITH THE ORIGINAL ONES



COLLETTORI CATALITICI OMOLOGATI
 CATALYTIC HOMOLOGATED COLLECTORS
71632KZ *

COLLETTORI RACING IN ACCIAIO INOX
 STAINLESS STEEL RACING COLLECTORS
71632MI *

COLLETTORI RACING IN TITANIO
 TITANIUM RACING COLLECTORS
71731MI *



Fitment - The continuous line means that
 it is necessary to fit all the components



Option for fitment - The dotted line means that
 it is not needed to fit all the components

**31**

BMW**R 1250 R - R 1250 RS '19/20**

EURO4

VEHICLE TYPE: **1R13**MAXI RACE-TECH
CARBON END CAP

		HOMOL.
TITANIUM	71925PK *	
ALUMINIUM	71925AK *	
ALUMINIUM "DARK"	71925AKN *	

COLLETTORI RACING IN TITANIO
TITANIUM RACING COLLECTORS
71748MI *COLLETTORI RACING IN ACCIAIO INOX
STAINLESS STEEL RACING COLLECTORS
71747MI ** **TUTTI I COMPONENTI SONO INTERCambiabili CON QUELLI ORIGINALI**
ALL THE COMPONENTS ARE INTERCHANGEABLE WITH THE ORIGINAL ONES**BMW****K 1300 S '12/16 - K 1300 R '09/16**VEHICLE TYPE: **K12S**MAXI RACE-TECH
CARBON END CAP

		HOMOL.
TITANIUM	71790PK	
ALUMINIUM	71790AK	
ALUMINIUM "DARK"	71790AKN	

 RACCORDO CATALITICO OMOLOGATO
PER COLLETTORI ORIGINALI
CATALYTIC HOMOLOGATED LINK PIPE
FOR ORIGINAL COLLECTORS
71455KZ
RACCORDO RACING PER
COLLETTORI ORIGINALI
RACING LINK PIPE FOR
ORIGINAL COLLECTORS
71455MI← **Fitment** - The continuous line means that it is necessary to fit all the components← - - - **Option for fitment** - The dotted line means that it is not needed to fit all the components**32**

BRIXTON

BX 125 X - Felsberg 125 X '19/20 EURO4

VEHICLE TYPE: **BX125**

PRO-RACE
STEEL END CAP

	ECE	HOMOL.
NICHROM	71899PRI *	
NICHROM "DARK"	71899PRN *	



COLLETORE RACING
RACING COLLECTOR
71715MI *



* TUTTI I COMPONENTI SONO INTERCAMBIABILI CON QUELLI ORIGINALI
ALL THE COMPONENTS ARE INTERCHANGEABLE WITH THE ORIGINAL ONES

BRIXTON

Glanville 250 X '18/19 - Felsberg 250 '20 EURO4

VEHICLE TYPE: **BX250**

PRO-RACE
STEEL END CAP

	ECE	HOMOL.
NICHROM	71919PRI	
NICHROM "DARK"	71919PRN	



TERMINALI PER COLLETTORI ORIGINALI
SILENCERS FOR ORIGINAL COLLECTORS



← **Fitment** - The continuous line means that it is necessary to fit all the components

← - - - **Option for fitment** - The dotted line means that it is not needed to fit all the components



VEHICLE TYPE: **BX250****PRO-RACE
STEEL END CAP**

	ECE	HOMOL.
NICHROM		71922PRI
NICHROM "DARK"		71922PRN



**TERMINALI PER COLLETTORI ORIGINALI
SILENCERS FOR ORIGINAL COLLECTORS**

VEHICLE TYPE: **BX500 -A****REBEL SILENCER**

	ECE	HOMOL.
CARBON END CAP		74508RB *
ALUMINIUM END CAP		74508RBA *
ALUM.DARK END CAP		74508RBN *



COLLETTORI RACING
RACING COLLECTORS
74005MI *

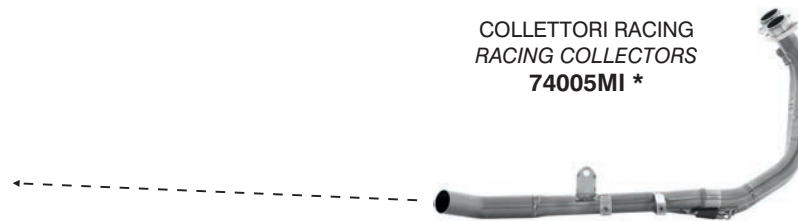

* **TUTTI I COMPONENTI SONO INTERCambiABILI CON QUELLI ORIGINALI
ALL THE COMPONENTS ARE INTERCHANGEABLE WITH THE ORIGINAL ONES**



← **Fitment** - The continuous line means that it is necessary to fit all the components



← - - - **Option for fitment** - The dotted line means that it is not needed to fit all the components



DUCATI

Monster 696 '08/14



VEHICLE TYPE: **M5**

THUNDER STEEL END CAP

		HOMOL.
ALUMINIUM		71731AO
ALUMINIUM "DARK"		71731AON



TERMINALI PER COLLETTORI ORIGINALI
SILENCERS FOR ORIGINAL COLLECTORS

Monster 796 '10/14



VEHICLE TYPE: **M5**



CATALIZZATORI
OMOLOGATI
HOMOLOGATED
CATALYSTS
11005KZ



ATTENZIONE · L'OMOLOGAZIONE È VALIDA SOLO CON LA PRESENZA DEL CATALIZZATORE
ATTENTION · THE HOMOLOGATION IS VALID ONLY WITH THE CATALYST INCLUDED IN THE SYSTEM

DUCATI

Monster 797 '17/18



VEHICLE TYPE: **MD**



RACCORDO CATALITICO OMOLOGATO
PER COLLETTORI ORIGINALI
CATALYTIC HOMOLOGATED LINK PIPE
FOR ORIGINAL COLLECTORS
71673KZ

RACING

TERMINALE PRO-RACE IN TITANIO +
RACCORDO IN TITANIO
PER COLLETTORI ORIGINALI
PRO-RACE TITANIUM SILENCER +
TITANIUM LINK PIPE
FOR ORIGINAL COLLECTORS
71212PR



PRO-RACE STEEL END CAP

		HOMOL.
NICHROM		71876PRI
NICHROM "DARK"		71876PRN



RACCORDO RACING PER
COLLETTORI ORIGINALI
RACING LINK PIPE FOR
ORIGINAL COLLECTORS
71673MI



← **Fitment** - The continuous line means that it is necessary to fit all the components

← - - - **Option for fitment** - The dotted line means that it is not needed to fit all the components



DUCATI**Scrambler 800 (no Desert Sled) '17/20**

EURO4

VEHICLE TYPE: **KC****EC**

RACCORDO CATALITICO OMOLOGATO
PER COLLETTORI ORIGINALI
CATALYTIC HOMOLOGATED LINK PIPE
FOR ORIGINAL COLLECTORS
71673KZ

RACCORDO RACING PER
COLLETTORI ORIGINALI
RACING LINK PIPE FOR
ORIGINAL COLLECTORS
71673MI

RACING

TERMINALE PRO-RACE IN TITANIO +
RACCORDO IN TITANIO
PER COLLETTORI ORIGINALI
PRO-RACE TITANIUM SILENCER +
TITANIUM LINK PIPE
FOR ORIGINAL COLLECTORS
71212PR



PRO-RACE
STEEL END CAP

	ECE	HOMOL.
NICHROM	71876PRI	
NICHROM "DARK"	71876PRN	

**DUCATI****Scrambler 800 Desert Sled '17/20**

EURO4

VEHICLE TYPE: **KB****EC**

RACCORDO CATALITICO OMOLOGATO
PER COLLETTORI ORIGINALI
CATALYTIC HOMOLOGATED LINK PIPE
FOR ORIGINAL COLLECTORS
71673KZ

RACCORDO RACING PER
COLLETTORI ORIGINALI
RACING LINK PIPE FOR
ORIGINAL COLLECTORS
71673MI

RACING

TERMINALE PRO-RACE IN TITANIO +
RACCORDO IN TITANIO
PER COLLETTORI ORIGINALI
PRO-RACE TITANIUM SILENCER +
TITANIUM LINK PIPE
FOR ORIGINAL COLLECTORS
71209PR



PRO-RACE
STEEL END CAP

	ECE	HOMOL.
NICHROM	71865PRI	
NICHROM "DARK"	71865PRN	



← **Fitment** - The continuous line means that it is necessary to fit all the components

← - - - - **Option for fitment** - The dotted line means that it is not needed to fit all the components

**36**

DUCATI

Hypermotard - Hyperstrada 821 '13/15



VEHICLE TYPE: **B2**

X-KONE CARBON END CAP

		HOMOL.
NICHROM		71806XKI

RACE-TECH CARBON END CAP

		HOMOL.
TITANIUM		71806PK
CARBON FIBRE		71806MK
ALUMINIUM		71806AK
ALUMINIUM "DARK"		71806AKN

8



8



RACCORDO CATALITICO OMOLOGATO
PER COLLETTORI ORIGINALI
CATALYTIC HOMOLOGATED LINK PIPE
FOR ORIGINAL COLLECTORS
71490KZ

RACCORDO RACING PER
COLLETTORI ORIGINALI
RACING LINK PIPE FOR
ORIGINAL COLLECTORS
71490MI



DUCATI

Monster 821 '14/16



VEHICLE TYPE: **B2**

RACE-TECH CARBON END CAP

		HOMOL.
TITANIUM		71768PK
CARBON FIBRE		71768MK
ALUMINIUM		71768AK
ALUMINIUM "DARK"		71768AKN

8



RACCORDO CATALITICO OMOLOGATO
PER COLLETTORI ORIGINALI
CATALYTIC HOMOLOGATED LINK PIPE
FOR ORIGINAL COLLECTORS
71451KZ

RACCORDO RACING PER
COLLETTORI ORIGINALI
RACING LINK PIPE FOR
ORIGINAL COLLECTORS
71451MI



Fitment - The continuous line means that it is necessary to fit all the components



Option for fitment - The dotted line means that it is not needed to fit all the components



37



VEHICLE TYPE: **MH**

EC

RACCORDO CATALITICO OMOLOGATO
PER COLLETTORI ORIGINALI
CATALYTIC HOMOLOGATED LINK PIPE
FOR ORIGINAL COLLECTORS
71687KZ



RACE-TECH CARBON CAP

	ECE HOMOL.
TITANIUM	71877PK
CARBON FIBRE	71877MK
ALUMINIUM	71877AK
ALUMINIUM "DARK"	71877AKN



RACCORDO RACING PER
COLLETTORI ORIGINALI
RACING LINK PIPE FOR
ORIGINAL COLLECTORS
71687MI



RACING

TERMINALE PRO-RACE IN TITANIO +
RACCORDO IN TITANIO
PER COLLETTORI ORIGINALI
PRO-RACE TITANIUM SILENCER +
TITANIUM LINK PIPE
FOR ORIGINAL COLLECTORS
71213PR



VEHICLE TYPE: **H8**

WORKS
CARBON END CAP

	ECE HOMOL.
TITANIUM	71836PK



TERMINALI PER COLLETTORI ORIGINALI
SILENCERS FOR ORIGINAL COLLECTORS



← **Fitment** - The continuous line means that it is necessary to fit all the components

← - - - - **Option for fitment** - The dotted line means that it is not needed to fit all the components



DUCATI

Hypermotard - Hyperstrada 939 '16/18

EURO4



VEHICLE TYPE: BA

X-KONE CARBON END CAP

	ECE	HOMOL.
NICHROM	71806XKI	

RACE-TECH CARBON END CAP

	ECE	HOMOL.
TITANIUM	71806PK	
CARBON FIBRE	71806MK	
ALUMINIUM	71806AK	
ALUMINIUM "DARK"	71806AKN	



RACCORDO CATALITICO OMOLOGATO
PER COLLETTORI ORIGINALI
CATALYTIC HOMOLOGATED LINK PIPE
FOR ORIGINAL COLLECTORS
71490KZ

RACCORDO RACING PER
COLLETTORI ORIGINALI
RACING LINK PIPE FOR
ORIGINAL COLLECTORS
71490MI



DUCATI

Hypermotard 950 '19/20

EURO4



VEHICLE TYPE: BB

PRO-RACE TITANIUM CAP

	ECE	HOMOL.
TITANIUM	71895PR *	

PRO-RACE STEEL CAP

	ECE	HOMOL.
NICHROM	71895PRI *	
NICHROM "DARK"	71895PRN *	

GP2 SILENCERS

	ECE	HOMOL.
FULL TITANIUM	71552GP *	
NICHROM "DARK"	71552GPI *	



RACCORDO CENTRALE
NON CATALITICO
NON CATALYZED
CENTRAL LINK PIPE
71707MI *



* **TUTTI I COMPONENTI SONO INTERCAMBIABILI
CON QUELLI ORIGINALI
ALL THE COMPONENTS ARE INTERCHANGEABLE
WITH THE ORIGINAL ONES**



← **Fitment** - The continuous line means that it is necessary to fit all the components



← **Option for fitment** - The dotted line means that it is not needed to fit all the components



DUCATI**Multistrada 950 '19/20**

EURO4



VEHICLE TYPE: AA - AD

**REBEL TITANIUM
SILENCER**

	ECE	HOMOL.
ALUM.DARK END CAP		71923RP *

**REBEL NICHROM "DARK"
SILENCERS**

	ECE	HOMOL.
ALUMINIUM END CAP		71923RBA *
ALUM.DARK END CAP		71923RBN *



RACCORDO CENTRALE
NON CATALITICO
NON CATALYZED
CENTRAL LINK PIPE
71738MI *



* **TUTTI I COMPONENTI SONO INTERCAMBIABILI CON QUELLI ORIGINALI**
ALL THE COMPONENTS ARE INTERCHANGEABLE WITH THE ORIGINAL ONES

DUCATI**Panigale 959 '16/19**

EURO4



VEHICLE TYPE: HA

**WORKS CARBON CAP**

	RACING
TITANIUM	71144PK *

**GP2 SILENCER**

	ECE	HOMOL.
TITANIUM		71543GP
NICHROM "DARK"		71543GPI

**PRO-RACE TITANIUM CAP**

	ECE	HOMOL.
TITANIUM		71880PR

PRO-RACE STEEL CAP

	ECE	HOMOL.
NICHROM		71880PRI
NICHROM "DARK"		71880PRN



* **ELIMINA IL CATALIZZATORE ORIGINALE**
REMOVES ORIGINAL CATALYTIC CONVERTER

TERMINALI PER COLLETTORI ORIGINALI
SILENCERS FOR ORIGINAL COLLECTORS



Fitment - The continuous line means that it is necessary to fit all the components



Option for fitment - The dotted line means that it is not needed to fit all the components

**40**

DUCATI

Panigale V2 '20

VEHICLE TYPE: 1H

WORKS
CARBON END CAP

	RACING
TITANIUM	71160PK



TERMINALI PER COLLETTORI ORIGINALI
SILENCERS FOR ORIGINAL COLLECTORS



DUCATI

Scrambler 1100 '18/20

EURO4

EC
ECE

CARB

VEHICLE TYPE: KF

PRO-RACE
STEEL END CAP

	ECE	HOMOL.
NICHROM	71884PRI *	
NICHROM "DARK"	71884PRN *	



RACCORDO CENTRALE
NON CATALITICO IN
NON CATALYZED
CENTRAL LINK PIPE
71696MI *



* TUTTI I COMPONENTI SONO INTERCAMBIABILI CON QUELLI ORIGINALI
ALL THE COMPONENTS ARE INTERCHANGEABLE WITH THE ORIGINAL ONES



← **Fitment** - The continuous line means that it is necessary to fit all the components



← - - - **Option for fitment** - The dotted line means that it is not needed to fit all the components



VEHICLE TYPE: **M5**

THUNDER STEEL END CAP

	HOMOL.
ALUMINIUM	71731AO
ALUMINIUM "DARK"	71731AON



TERMINALI PER COLLETTORI ORIGINALI
SILENCERS FOR ORIGINAL COLLECTORS



CATALIZZATORI
OMOLOGATI
HOMOLOGATED
CATALYSTS
11005KZ



ATTENZIONE · L'OMOLOGAZIONE è VALIDA SOLO CON LA PRESENZA DEL CATALIZZATORE
ATTENTION · THE HOMOLOGATION IS VALID ONLY WITH THE CATALYST INCLUDED IN THE SYSTEM



VEHICLE TYPE: **M5**

RACE-TECH CARBON END CAP

	HOMOL.
TITANIUM	71768PK
CARBON FIBRE	71768MK
ALUMINIUM	71768AK
ALUMINIUM "DARK"	71768AKN



RACCORDO CATALITICO OMOLOGATO
PER COLLETTORI ORIGINALI
CATALYTIC HOMOLOGATED LINK PIPE
FOR ORIGINAL COLLECTORS
71451KZ

RACCORDO RACING PER
COLLETTORI ORIGINALI
RACING LINK PIPE FOR
ORIGINAL COLLECTORS
71451MI



← **Fitment** - The continuous line means that it is necessary to fit all the components

← - - - **Option for fitment** - The dotted line means that it is not needed to fit all the components



DUCATI

Monster 1200 - 1200 R - 1200 S '16/20

EURO4 

VEHICLE TYPE: MA - MB

RACE-TECH
CARBON END CAP

 HOMOL.	
ALUMINIUM "DARK"	71850AKN



PRO-RACE TITANIUM CAP
HIGH VERSION

 RACING	
TITANIUM	71221PR *
TITANIUM "DARK"	71221PRB *



PROTEZIONE PARATACCO
IN CARBONIO PER TERMINALI PRO-RACE
CARBON HEEL GUARD
FOR PRO-RACE SILENCERS
11007MI



 EC

RACCORDO CATALITICO OMOLOGATO
PER COLLETTORI ORIGINALI
CATALYTIC HOMOLOGATED LINK PIPE
FOR ORIGINAL COLLECTORS
71739KZ



RACCORDO RACING PER
COLLETTORI ORIGINALI
RACING LINK PIPE FOR
ORIGINAL COLLECTORS
71739MI



 * TERMINALI PER COLLETTORI ORIGINALI
SILENCERS FOR ORIGINAL COLLECTORS

DUCATI

Multistrada 1200 - 1200 S '10/14

 2006/120/CE

VEHICLE TYPE: A2 - A3

WORKS CARBON END CAP

 HOMOL.	
TITANIUM	71769PK



RACE-TECH
FONDELLO CARBY

 HOMOL.	
TITANIUM	71768PK
CARBON FIBRE	71768MK
ALUMINIUM	71768AK
ALUMINIUM "DARK"	71768AKN



 5

COLLETTORI CATALITICI OMOLOGATI
CATALYTIC HOMOLOGATED COLLECTORS
71429KZ *



COLLETTORI RACING
RACING COLLECTORS
71429MI *



 * I COLLETTORI MONTANO ANCHE CON CAVALLETTO CENTRALE
COLLECTORS ALSO FIT WITH CENTRAL STAND



← **Fitment** - The continuous line means that it is necessary to fit all the components

← - - - **Option for fitment** - The dotted line means that it is not needed to fit all the components



VEHICLE TYPE: **AA**

INDY RACE
CARBON CAP

	ECE	HOMOL.
TITANIUM		71832PK
ALUMINIUM		71832AK
ALUMINIUM "DARK"		71832AKN

4



TERMINALI PER RACCORDO CATALITICO ORIGINALE
SILENCERS FOR ORIGINAL CATALYTIC LINK PIPE



VEHICLE TYPE: **AC**

INDY RACE
CARBON END CAP

	ECE	HOMOL.
TITANIUM		71832PK *
ALUMINIUM		71832AK *
ALUMINIUM "DARK"		71832AKN *

4



RACCORDO CENTRALE
NON CATALITICO
NON CATALYZED
CENTRAL LINK PIPE
71705MI *



* TUTTI I COMPONENTI SONO INTERCAMBIABILI CON QUELLI ORIGINALI
ALL THE COMPONENTS ARE INTERCHANGEABLE WITH THE ORIGINAL ONES



← **Fitment** - The continuous line means that it is necessary to fit all the components

← - - - - **Option for fitment** - The dotted line means that it is not needed to fit all the components



DUCATI

Diavel '11/16



VEHICLE TYPE: **G1**

RACE-TECH
FONDELLO CARBY

	 HOMOL.
TITANIUM	71768PK
CARBON FIBRE	71768MK
ALUMINIUM	71768AK
ALUMINIUM "DARK"	71768AKN



RACCORDO CATALITICO OMOLOGATO
PER COLLETTORI ORIGINALI
CATALYTIC HOMOLOGATED LINK PIPE
FOR ORIGINAL COLLECTORS
71451KZ



RACCORDO RACING PER
COLLETTORI ORIGINALI
RACING LINK PIPE FOR
ORIGINAL COLLECTORS
71451MI



DUCATI

Xdiavel '16/20

VEHICLE TYPE: **GA**

RACING



KIT TERMINALI PRO-RACE TITANIO CON
RACCORDO CENTRALE NON CATALITICO IN ACCIAIO INOX
PRO-RACE TITANIUM SILENCERS KIT WITH
STAINLESS STEEL NON CATALYZED CENTRAL LINK PIPE
71204PR



Fitment - The continuous line means that it is necessary to fit all the components



Option for fitment - The dotted line means that it is not needed to fit all the components



45



VEHICLE TYPE: **GE**

INDY RACE CARBON END CAP

	EC	HOMOL.
TITANIUM	71924PK	
ALUMINIUM	71924AK	
ALUMINIUM "DARK"	71924AKN	



PRO-RACE END CAP WITH MESH

	RACING
FULL TITANIUM	71222PR
NICHROM	71222PRI
NICHROM "DARK"	71222PRN



EC
RACCORDO CENTRALE
CATALITICO OMOLOGATO
PER TERMINALI INDY RACE
RACING CENTRAL LINK PIPE
CATALYTIC HOMOLOGATED
FOR INDY RACE SILENCERS
71741KZ



RACCORDO CENTRALE RACING
PER TERMINALI INDY RACE
RACING CENTRAL LINK PIPE
FOR INDY RACE SILENCERS
71741MI



RACCORDO CENTRALE RACING
PER TERMINALI PRO-RACE
RACING CENTRAL LINK PIPE
FOR PRO-RACE SILENCERS
71740MI



← **Fitment** - The continuous line means that it is necessary to fit all the components

← - - - - **Option for fitment** - The dotted line means that it is not needed to fit all the components



DUCATI

1199 Panigale '12/15

VEHICLE TYPE: **H8**

WORKS
CARBON END CAP

	 HOMOL.
TITANIUM	71836PK

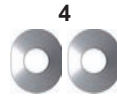

TERMINALI PER COLLETTORI ORIGINALI
SILENCERS FOR ORIGINAL COLLECTORS



DUCATI

1299 Panigale '15/16

VEHICLE TYPE: **H9**

WORKS
CARBON END CAP

	 HOMOL.
TITANIUM	71839PK

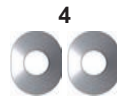

TERMINALI PER COLLETTORI ORIGINALI
SILENCERS FOR ORIGINAL COLLECTORS



Fitment - The continuous line means that it is necessary to fit all the components



Option for fitment - The dotted line means that it is not needed to fit all the components



Panigale V4 '18/20

VEHICLE TYPE: **DA**

RACING

KIT TERMINALI WORKS TITANIO
RACCORDI IN ACCIAIO INOX
PER COLLETTORI ORIGINALI
WORKS TITANIUM SILENCERS KIT
STAINLESS STEEL LINK PIPES
FOR ORIGINAL COLLECTORS
71146PK



Streetfighter V4 '20

VEHICLE TYPE: **FA**

RACING

KIT TERMINALI WORKS FULL TITANIO
RACCORDI IN TITANIO
PER COLLETTORI ORIGINALI
WORKS FULL TITANIUM SILENCERS KIT
TITANIUM LINK PIPES
FOR ORIGINAL COLLECTORS
71154PK



Fuoco 500 i.e. '07/13



VEHICLE TYPE: **M61**

URBAN
FONDELLO INOX NERO

ECE HOMOL.
ALUMINIUM
"DARK" **73503ANN**



COLLETORE
CATALITICO OMOLOGATO
CATALYTIC HOMOLOGATED
COLLECTOR
73003KZ



COLLETORE RACING
RACING COLLECTORS
73003MI



← **Fitment** - The continuous line means that it is necessary to fit all the components

← - - - **Option for fitment** - The dotted line means that it is not needed to fit all the components



HONDA

XR 125 L '04/05



VEHICLE TYPE: **JD19**

XR 125 R/SM '04/05



VEHICLE TYPE: **125**



**THUNDER
STEEL END CAP**

		HOMOL.
TITANIUM		52501PO
ALUMINIUM		52501AO



COLLETTORE RACING
RACING COLLECTOR
52001MI



HONDA

XL 125 V Varadero '01/12



VEHICLE TYPE: **JC32**



**THUNDER
STEEL END CAP**

		HOMOL.
TITANIUM		52503PO
ALUMINIUM		52503AO



TERMINALI PER COLLETTORI ORIGINALI
SILENCERS FOR ORIGINAL COLLECTORS



Fitment - The continuous line means that it is necessary to fit all the components



Option for fitment - The dotted line means that it is not needed to fit all the components



49



HONDA

Forza 125 '15/16



VEHICLE TYPE: **JF60**

Forza 125 '17/20



VEHICLE TYPE: **JF69**

URBAN
BLACK STEEL CAP

	ECE	HOMOL.
ALUMINIUM "DARK" 53508ANN		



COLLETTORE CATALITICO OMOLOGATO
CATALYTIC HOMOLOGATED COLLECTOR
53056KZ



COLLETTORE RACING
RACING COLLECTOR
53056MI



HONDA

Forza 125 '21



VEHICLE TYPE: **JK02**

URBAN
BLACK STEEL CAP

	ECE	HOMOL.
ALUMINIUM "DARK" 53541ANN		



CATALIZZATORE OMOLOGATO
HOMOLOGATED CATALYST
11031KZ



ATTENZIONE · L'OMOLOGAZIONE È VALIDA SOLO CON LA PRESENZA DEL CATALIZZATORE
ATTENTION · THE HOMOLOGATION IS VALID ONLY WITH THE CATALYST INCLUDED IN THE SYSTEM



Fitment - The continuous line means that it is necessary to fit all the components



Option for fitment - The dotted line means that it is not needed to fit all the components



50

HONDA

PCX 125 '12/16



VEHICLE TYPE: **JF28 - JF57**

PCX 150 '12/16



VEHICLE TYPE: **KF12 - KF19**

URBAN
BLACK STEEL CAP

		HOMOL.
ALUMINIUM	"DARK"	53519ANN



COLLETTORE CATALITICO OMOLOGATO
CATALYTIC HOMOLOGATED COLLECTOR
53066KZ



COLLETTORE RACING
RACING COLLECTORS
53066MI



HONDA

PCX 125 '17

EURO4



VEHICLE TYPE: **JF64**

URBAN
BLACK STEEL CAP

		HOMOL.
ALUMINIUM	"DARK"	53519ANN



COLLETTORE CATALITICO OMOLOGATO
CATALYTIC HOMOLOGATED COLLECTOR
53066KZ



COLLETTORE RACING
RACING COLLECTORS
53066MI



Fitment - The continuous line means that it is necessary to fit all the components



Option for fitment - The dotted line means that it is not needed to fit all the components



HONDA

PCX 125 '18/20

EURO4



VEHICLE TYPE: **JF83**

URBAN
BLACK STEEL CAP

ECE HOMOL.
ALUMINIUM "DARK" 53529ANN

8



EC

COLLETTORE CATALITICO OMOLOGATO
CATALYTIC HOMOLOGATED COLLECTOR
53076KZ



COLLETTORE RACING
RACING COLLECTOR
53076MI



HONDA

PCX 125 '21

EURO5



VEHICLE TYPE: **JK05**

URBAN
CARBON END CAP

ECE HOMOL.
ALUMINIUM "DARK" 53540AKN

8



EC

COLLETTORE CATALITICO OMOLOGATO
CATALYTIC HOMOLOGATED COLLECTOR
53089KZ



COLLETTORE RACING
RACING COLLECTOR
53089MI



Fitment - The continuous line means that it is necessary to fit all the components



Option for fitment - The dotted line means that it is not needed to fit all the components



52



HONDA

SH 125i ABS '12/16



VEHICLE TYPE: **JF41**

SH 150i ABS '12/16



VEHICLE TYPE: **KF13**

URBAN
BLACK STEEL CAP
ECE HOMOL.
ALUMINIUM "DARK" 53514ANN



COLLETTORE CATALITICO OMOLOGATO
CATALYTIC HOMOLOGATED COLLECTOR
53061KZ



COLLETTORE RACING
RACING COLLECTORS
53061MI



HONDA

SH 125 '17/19

EURO4



VEHICLE TYPE: **JF68**

SH 150 '17/19

EURO4



VEHICLE TYPE: **KF23**

URBAN
BLACK STEEL CAP
ECE HOMOL.
ALUMINIUM "DARK" 53514ANN



COLLETTORE CATALITICO OMOLOGATO
CATALYTIC HOMOLOGATED COLLECTOR
53066KZ



COLLETTORE RACING
RACING COLLECTORS
53066MI



Fitment - The continuous line means that it is necessary to fit all the components



Option for fitment - The dotted line means that it is not needed to fit all the components



HONDA

SH 125 '20/21

EURO5



SH 150 '20/21

EURO5



VEHICLE TYPE: JF90

VEHICLE TYPE: KF40

URBAN
BLACK STEEL CAP

	HOMOL.
ALUMINIUM "DARK"	53534ANN



COLLETTORE CATALITICO OMOLOGATO
CATALYTIC HOMOLOGATED COLLECTOR
53081KZ



COLLETTORE RACING
RACING COLLECTOR
53081MI



HONDA

MSX 125 '16/17



MSX 125 '18/20

EURO4



VEHICLE TYPE: JC61

VEHICLE TYPE: JC75

X-KONE
FONDELLO CARBY

	HOMOL.
TITANIUM	52507XK
NICHROM	52507XKI
NICHROM "DARK"	52507XKN



COLLETTORE CATALITICO OMOLOGATO
CATALYTIC HOMOLOGATED COLLECTOR
52005KZ



COLLETTORE RACING
RACING COLLECTOR
52005MI



← **Fitment** - The continuous line means that it is necessary to fit all the components

← - - - **Option for fitment** - The dotted line means that it is not needed to fit all the components



HONDA

CB 125 F '15/16



VEHICLE TYPE: **JC64**

**X-KONE
CARBON END CAP**

ECE		HOMOL.
NICHROM	51514XKN	
"DARK"		

**THUNDER
STEEL END CAP**

ECE		HOMOL.
ALUMINIUM	51514AO	
ALUMINIUM	51514AON	
"DARK"		

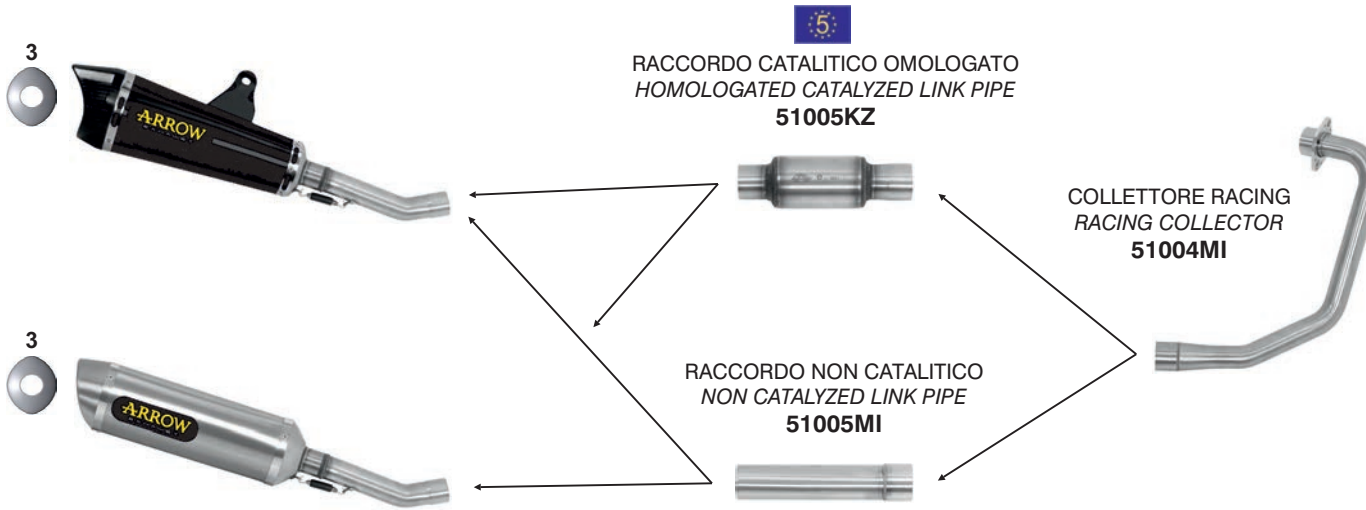

HONDA

CB 125 F '17/20



VEHICLE TYPE: **JC74**

**X-KONE
CARBON END CAP**

ECE		HOMOL.
NICHROM	51517XKI	
NICHROM	51517XKN	
"DARK"		

**THUNDER
STEEL END CAP**

ECE		HOMOL.
ALUMINIUM	51517AO	
ALUMINIUM	51517AON	
"DARK"		

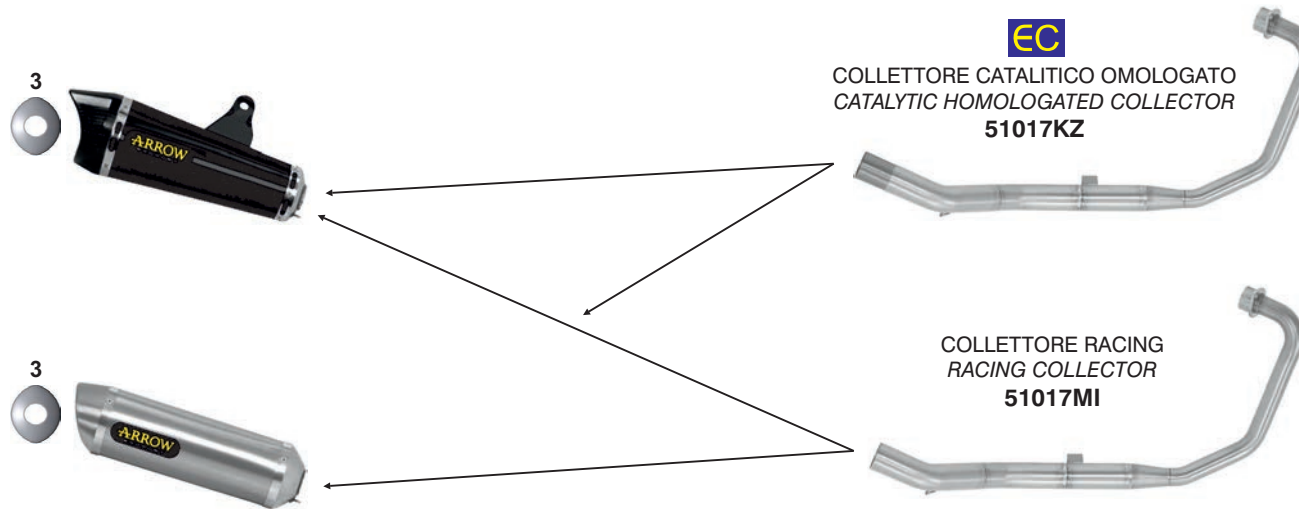

Fitment - The continuous line means that it is necessary to fit all the components



Option for fitment - The dotted line means that it is not needed to fit all the components



55



HONDA

CB 125 R '18/20

EURO4



VEHICLE TYPE: **JC79**

X-KONE CARBON END CAP

	ECE	HOMOL.
NICHROM	51516XKI	
NICHROM "DARK"	51516XKN	

THUNDER CARBON END CAP

	ECE	HOMOL.
TITANIUM	51516PK	
CARBON FIBRE	51516MK	
ALUMINIUM	51516AK	
ALUMINIUM "DARK"	51516AKN	



HONDA

CB 125 R '21

EURO5



VEHICLE TYPE: **JC91**

X-KONE CARBON CAP

	ECE	HOMOL.
NICHROM	51519XKIW	
NICHROM "DARK"	51519XKNW	

THUNDER CARBON CAP

	ECE	HOMOL.
TITANIUM	51519PKW	
CARBON FIBRE	51519MKW	
ALUMINIUM	51519AKW	
ALUMINIUM "DARK"	51519AKNW	



EC
CATALIZZATORE OMOLOGATO
HOMOLOGATED CATALYST
11030KZ



ATTENZIONE · L'OMOLOGAZIONE È VALIDA SOLO CON LA PRESENZA DEL CATALIZZATORE
ATTENTION · THE HOMOLOGATION IS VALID ONLY WITH THE CATALYST INCLUDED IN THE SYSTEM



← **Fitment** - The continuous line means that it is necessary to fit all the components

← - - - **Option for fitment** - The dotted line means that it is not needed to fit all the components



HONDA

CBR 125 R '04/10



VEHICLE TYPE: **JC34 - JC39**

**THUNDER
STEEL END CAP**

	HOMOL.
ALUMINIUM	51501AO
ALUMINIUM "DARK"	51501AON



COLLETORE RACING
RACING COLLECTOR
51002MI



HONDA

CBR 125 R '11/16



VEHICLE TYPE: **JC50**



**THUNDER
STEEL END CAP**

	HOMOL.
ALUMINIUM	51506AO
ALUMINIUM "DARK"	51506AON



RACCORDO CATALITICO OMOLOGATO
HOMOLOGATED CATALYZED LINK PIPE
51005KZ



RACCORDO NON CATALITICO
NON CATALYZED LINK PIPE
51005MI



COLLETORE RACING
RACING COLLECTOR
51007MI



Fitment - The continuous line means that it is necessary to fit all the components



Option for fitment - The dotted line means that it is not needed to fit all the components



VEHICLE TYPE: MD44

X-KONE CARBON END CAP

ECE HOMOL.	
NICHROM	72528XKI



THUNDER CARBON END CAP

ECE HOMOL.	
TITANIUM	72528PK
ALUMINIUM	72528AK
ALUMINIUM "DARK"	72528AKN



THUNDER STEEL END CAP

ECE HOMOL.	
TITANIUM	72528PO
ALUMINIUM	72528AO
ALUMINIUM "DARK"	72528AON



EC
RACCORDO CATALITICO OMOLOGATO
PER TERMINALE X-KONE
CATALYTIC HOMOLOGATED LINK PIPE
FOR X-KONE SILENCER
72135KZ



RACCORDO RACING
PER TERMINALE X-KONE
RACING LINK PIPE
FOR X-KONE SILENCER
72135PD



EC
RACCORDO CATALITICO OMOLOGATO
PER TERMINALI THUNDER
CATALYTIC HOMOLOGATED LINK PIPE
FOR THUNDER SILENCERS
72133KZ



RACCORDO RACING
PER TERMINALE THUNDER
RACING LINK PIPE
FOR THUNDER SILENCER
72133PD



COLLETORE RACING
RACING COLLECTOR
72134PD



← **Fitment** - The continuous line means that it is necessary to fit all the components

← - - - **Option for fitment** - The dotted line means that it is not needed to fit all the components



HONDA

CRF 300 L '21

EURO5



VEHICLE TYPE: **ND16**

X-KONE CARBON END CAP

	ECE	HOMOL.
NICHROM		72528XKI



8

THUNDER CARBON END CAP

	ECE	HOMOL.
TITANIUM		72528PK
ALUMINIUM		72528AK
ALUMINIUM "DARK"		72528AKN



3

THUNDER STEEL END CAP

	ECE	HOMOL.
TITANIUM		72528PO
ALUMINIUM		72528AO
ALUMINIUM "DARK"		72528AON



3

EC
RACCORDO CATALITICO OMOLOGATO
PER TERMINALE X-KONE
CATALYTIC HOMOLOGATED LINK PIPE
FOR X-KONE SILENCER
72177PZ



RACCORDO RACING
PER TERMINALE X-KONE
RACING LINK PIPE
FOR X-KONE SILENCER
72177PD



EC
RACCORDO CATALITICO OMOLOGATO
PER TERMINALI THUNDER
CATALYTIC HOMOLOGATED LINK PIPE
FOR THUNDER SILENCERS
72178PZ



RACCORDO RACING
PER TERMINALE THUNDER
RACING LINK PIPE
FOR THUNDER SILENCER
72178PD



COLLETTORE RACING
RACING COLLECTOR
72179PD



← **Fitment** - The continuous line means that it is necessary to fit all the components

← **Option for fitment** - The dotted line means that it is not needed to fit all the components



HONDA

FORZA 300 '18/20 EURO4 

VEHICLE TYPE: **NF08**

URBAN
BLACK STEEL CAP
 HOMOL.
ALUMINIUM "DARK" 53530ANN





RACCORDO CATALITICO OMOLOGATO
CATALYTIC HOMOLOGATED LINK PIPE
53077KZ



RACCORDO RACING
RACING LINK PIPE
53077MI



HONDA

SH 300i '16/20 EURO4 

VEHICLE TYPE: **NF05**

URBAN
BLACK STEEL CAP
 HOMOL.
ALUMINIUM "DARK" 53510ANN





CATALIZZATORE OMOLOGATO
HOMOLOGATED CATALYST
11023KZ



TERMINALE PER COLLETTORE ORIGINALE
SILENCER FOR ORIGINAL COLLECTOR



ATTENZIONE · L'OMOLOGAZIONE È VALIDA SOLO CON LA PRESENZA DEL CATALIZZATORE
ATTENTION · THE HOMOLOGATION IS VALID ONLY WITH THE CATALYST INCLUDED IN THE SYSTEM



← **Fitment** - The continuous line means that it is necessary to fit all the components

← - - - - **Option for fitment** - The dotted line means that it is not needed to fit all the components



60



HONDA

FORZA 350 '21

VEHICLE TYPE: **NF10**

URBAN
CARBON END CAP

 **HOMOL.**
ALUMINIUM "DARK" **53538AKN**



URBAN
BLACK STEEL CAP

 **HOMOL.**
ALUMINIUM "DARK" **53538ANN**





RACCORDO CATALITICO OMOLOGATO
PER COLLETTORE ORIGINALE
CATALYTIC HOMOLOGATED LINK PIPE
FOR ORIGINAL COLLECTOR
53085KZ



RACCORDO RACING
PER COLLETTORE ORIGINALE
RACING LINK PIPE
FOR ORIGINAL COLLECTOR
53085MI



HONDA

SH 350 '21

VEHICLE TYPE: **NF11**

URBAN
CARBON END CAP

 **HOMOL.**
ALUMINIUM "DARK" **53538AKN**



URBAN
BLACK STEEL CAP

 **HOMOL.**
ALUMINIUM "DARK" **53538ANN**





RACCORDO CATALITICO OMOLOGATO
PER COLLETTORE ORIGINALE
CATALYTIC HOMOLOGATED LINK PIPE
FOR ORIGINAL COLLECTOR
53086KZ



RACCORDO RACING
PER COLLETTORE ORIGINALE
RACING LINK PIPE
FOR ORIGINAL COLLECTOR
53086MI



Fitment - The continuous line means that it is necessary to fit all the components



Option for fitment - The dotted line means that it is not needed to fit all the components



61



HONDA

CB 300 R '18/20

EURO4



VEHICLE TYPE: **NC55**

**X-KONE
CARBON END CAP**

	ECE	HOMOL.
NICHROM		71883XKI

**RACE-TECH
CARBON END CAP**

	ECE	HOMOL.
ALUMINIUM "DARK"		71883AKN

GP2 SILENCERS

	ECE	HOMOL.
TITANIUM		71548GP
NICHROM "DARK"		71548GPI



RACCORDO CATALITICO OMOLOGATO
PER COLLETTORE ORIGINALE
CATALYTIC HOMOLOGATED LINK PIPE
FOR ORIGINAL COLLECTOR
71695KZ

RACCORDO RACING
PER COLLETTORE ORIGINALE
RACING LINK PIPE
FOR ORIGINAL COLLECTOR
71695MI



HONDA

CRF 450 L '19/20

EURO4



VEHICLE TYPE: **PD11**

**RACE-TECH
CARBON END CAP**

	ECE	HOMOL.
TITANIUM		72530PK
ALUMINIUM		72530AK



CRF 450 XR '19/20

EURO4



VEHICLE TYPE: **RMH**

**RACE-TECH
CARBON END CAP**

	ECE	HOMOL.
TITANIUM		72530PKZ
ALUMINIUM		72530AKZ



**TERMINALI PER COLLETTORE ORIGINALE
SILENCERS FOR ORIGINAL COLLECTOR**



← **Fitment** - The continuous line means that it is necessary to fit all the components

← - - - **Option for fitment** - The dotted line means that it is not needed to fit all the components



HONDA

CRF 450 R '21

8



RACING RACE-TECH TITANIUM
FONDELLO CARBY
CARBON END CAP
75171TK *

RACING
COLLETTORE IN TITANIO
TITANIUM COLLECTOR
72174PD *



* **TUTTI I COMPONENTI SONO INTERCAMBIABILI CON QUELLI ORIGINALI**
ALL THE COMPONENTS ARE INTERCHANGEABLE WITH THE ORIGINAL ONES

HONDA

CMX 500 Rebel '17/20

EURO4 EURO5 EC ECE CARB

VEHICLE TYPE: **PC56**

REBEL
CARBON END CAP

	HOMOL.
NICHROM "DARK"	74504RB *

10



REBEL
ALUMINIUM END CAP

	HOMOL.
NICHROM "DARK"	74504RBA *

10



REBEL
ALUM. "DARK" END CAP

	HOMOL.
NICHROM "DARK"	74504RBN *

10



COLLETTORI RACING
RACING COLLECTORS
74002MI *



* **TUTTI I COMPONENTI SONO INTERCAMBIABILI CON QUELLI ORIGINALI**
ALL THE COMPONENTS ARE INTERCHANGEABLE WITH THE ORIGINAL ONES



← **Fitment** - The continuous line means that it is necessary to fit all the components

← **Option for fitment** - The dotted line means that it is not needed to fit all the components



HONDA

CB 500 X '17/18

EURO4

EC ECE

CARB

X-KONE CARBON CAP

	ECE HOMOL.
NICHROM	71859XKI

RACE-TECH CARBON CAP

	ECE HOMOL.
TITANIUM	71859PK
CARBON FIBRE	71859MK
ALUMINIUM	71859AK
ALUMINIUM "DARK"	71859AKN

PRO-RACE STEEL CAP

	ECE HOMOL.
NICHROM	71859PRI *
NICHROM "DARK"	71859PRN *

VEHICLE TYPE: **PC59**



COLLETTORI ORIGINALI
LINK PIPE FOR
ORIGINAL COLLECTORS
71665MI #

! # NON MONTANO CON CAVALLETTO CENTRALE
DOES NOT FIT TO CENTRAL STAND

! * TERMINALI PER COLLETTORI ORIGINALI
SILENCERS FOR ORIGINAL COLLECTORS



HONDA

CB 500 X '19/20

EURO4

EC ECE

CARB

X-KONE CARBON CAP

	ECE HOMOL.
NICHROM	71859XKI

RACE-TECH CARBON CAP

	ECE HOMOL.
TITANIUM	71859PK
CARBON FIBRE	71859MK
ALUMINIUM	71859AK
ALUMINIUM "DARK"	71859AKN

PRO-RACE STEEL CAP

	ECE HOMOL.
NICHROM	71896PRI *
NICHROM "DARK"	71896PRN *

VEHICLE TYPE: **PC64**



RACCORDO PER
COLLETTORI ORIGINALI
LINK PIPE FOR
ORIGINAL COLLECTORS
71665MI

! * TERMINALI PER COLLETTORI ORIGINALI
SILENCERS FOR ORIGINAL COLLECTORS



← **Fitment** - The continuous line means that it is necessary to fit all the components

← - - - - **Option for fitment** - The dotted line means that it is not needed to fit all the components



VEHICLE TYPE: **PC45**

X-KONE CARBON CAP

	HOMOL.
NICHROM	71804XKI

8



RACE-TECH CARBON CAP

	HOMOL.
TITANIUM	71804PK
CARBON FIBRE	71804MK
ALUMINIUM	71804AK
ALUMINIUM "DARK"	71804AKN

8



RACE-TECH STEEL CAP

	HOMOL.
ALUMINIUM	71804AO
ALUMINIUM "DARK"	71804AON

8



RACCORDO PER COLLETTORI ORIGINALI
LINK PIPE FOR ORIGINAL COLLECTORS
71480MI



Fitment - The continuous line means that it is necessary to fit all the components



Option for fitment - The dotted line means that it is not needed to fit all the components



VEHICLE TYPE: PC45 - PC57 - PC58

X-KONE CARBON CAP

	ECE	HOMOL.
NICHROM	71804XKI	



RACE-TECH CARBON CAP

	ECE	HOMOL.
TITANIUM	71804PK	
CARBON FIBRE	71804MK	
ALUMINIUM	71804AK	
ALUMINIUM "DARK"	71804AKN	



RACE-TECH STEEL CAP

	ECE	HOMOL.
ALUMINIUM	71804AO	
ALUMINIUM "DARK"	71804AON	



PRO-RACE STEEL CAP

	RACING
NICHROM	71029PRI #
NICHROM "DARK"	71029PRN #



PRO-RACE TITANIUM CAP

	RACING
TITANIUM	71029PR #



RACCORDO LINK PIPE
71640MI *

COLLETTORI RACING
RACING COLLECTORS
71641MI

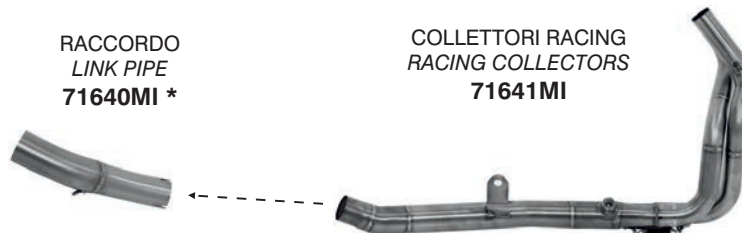

* **IL RACCORDO 71640MI MONTA ANCHE SU COLLETTORI ORIGINALI**
71640MI LINK PIPE FITS TO BOTH ARROW AND ORIGINAL COLLECTORS



TERMINALI PER COLLETTORI ORIGINALI
SILENCERS FOR ORIGINAL COLLECTORS



dB-KILLER PER TERMINALI PRO-RACE
dB-KILLER FOR PRO-RACE SILENCERS
11012DB



← **Fitment** - The continuous line means that it is necessary to fit all the components



← - - - **Option for fitment** - The dotted line means that it is not needed to fit all the components



HONDA

CB 500 F '19/20

EURO4

EC ECE

CARB

VEHICLE TYPE: **PC63**

X-KONE CARBON END CAP

	ECE	HOMOL.
NICHROM	71901XKI	



RACE-TECH CARBON END CAP

	ECE	HOMOL.
TITANIUM	71901PK	
CARBON FIBRE	71901MK	
ALUMINIUM	71901AK	
ALUMINIUM "DARK"	71901AKN	



RACE-TECH STEEL END CAP

	ECE	HOMOL.
ALUMINIUM	71901AO	
ALUMINIUM "DARK"	71901AON	



PRO-RACE STEEL END CAP

	ECE	HOMOL.
NICHROM	71901PRI *	
NICHROM "DARK"	71901PRN *	



RACCORDO
LINK PIPE
71717MI *



COLLETTORI RACING
RACING COLLECTORS
71714MI



* **MONTANO ANCHE SU COLLETTORI ORIGINALI**
ALSO FIT TO ORIGINAL COLLECTORS



← **Fitment** - The continuous line means that it is necessary to fit all the components

← - - - **Option for fitment** - The dotted line means that it is not needed to fit all the components



VEHICLE TYPE: PC62

**X-KONE
CARBON END CAP**

	ECE	HOMOL.
NICHROM	71901XKI	



**RACE-TECH
CARBON END CAP**

	ECE	HOMOL.
TITANIUM	71901PK	
CARBON FIBRE	71901MK	
ALUMINIUM	71901AK	
ALUMINIUM "DARK"	71901AKN	



**RACE-TECH
STEEL END CAP**

	ECE	HOMOL.
ALUMINIUM	71901AO	
ALUMINIUM "DARK"	71901AON	



**PRO-RACE
STEEL END CAP**

	ECE	HOMOL.
NICHROM	71901PRI *	
NICHROM "DARK"	71901PRN *	



RACCORDO
LINK PIPE
71717MI *



COLLETTORI RACING
RACING COLLECTORS
71732MI



* **MONTANO ANCHE SU COLLETTORI ORIGINALI!**
ALSO FIT TO ORIGINAL COLLECTORS



← **Fitment** - The continuous line means that it is necessary to fit all the components

← - - - - **Option for fitment** - The dotted line means that it is not needed to fit all the components



HONDA

CB 600 F Hornet '07/13



CBR 600 F '11/13



VEHICLE TYPE: **PC41**

VEHICLE TYPE: **PC41**

X-KONE CARBON END CAP

HOMOL.	
NICHROM	71722XKI *

THUNDER CARBON CAP

HOMOL.	
ALUMINIUM	71722AK *
ALUMINIUM "DARK"	71722AKN *

THUNDER STEEL CAP

HOMOL.	
ALUMINIUM	71722AO *
ALUMINIUM "DARK"	71722AON *



COLLETTORI RACING
RACING COLLECTORS
71446MI

dB-KILLER OPZIONALI / OPTIONAL

	dB-KILLER	SEEGER
THUNDER	5930062	3640052
X-KONE	5930129	3640035



* **I TERMINALI MONTANO ANCHE SU COLLETTORI ORIGINALI E SONO OMOLOGATI SENZA DBKILLER**
ALL SILENCERS ALSO FIT TO ORIGINAL COLLECTORS
THEY ARE HOMOLOGATED WITHOUT DB-KILLER



HONDA

CBR 600 RR '07/08



VEHICLE TYPE: **PC40**

INDY-RACE CARBON END CAP

HOMOL.	
TITANIUM	71712PK
CARBON FIBRE	71712MK
ALUMINIUM	71712AK
ALUMINIUM "DARK"	71712AKN



RACCORDO
LINK PIPE
71354MI *

COLLETTORI RACING
RACING COLLECTORS
71355MI



* **II RACCORDO 71354MI MONTA SIA SU COLL. ORIGINALI CHE SU COLL. ARROW**
71354MI LINK PIPE FITS TO BOTH ARROW AND ORIGINAL COLLECTORS



← **Fitment** - The continuous line means that it is necessary to fit all the components



← **Option for fitment** - The dotted line means that it is not needed to fit all the components



HONDA

CBR 600 RR '09/12



VEHICLE TYPE: **PC40**

INDY-RACE CARBON END CAP

	HOMOL.
TITANIUM	71712PK
CARBON FIBRE	71712MK
ALUMINIUM	71712AK
ALUMINIUM "DARK"	71712AKN



RACCORDO
LINK PIPE
71391MI *



COLLETTORI RACING
RACING COLLECTORS
71392MI



* **II RACCORDO 71391MI MONTA SIA SU COLL. ORIGINALI CHE SU COLL. ARROW**
71354MI LINK PIPE FITS TO BOTH ARROW AND ORIGINAL COLLECTORS

HONDA

CBR 600 RR '13/16



VEHICLE TYPE: **PC40**

INDY-RACE CARBON END CAP

	HOMOL.
TITANIUM	71807PK
CARBON FIBRE	71807MK
ALUMINIUM	71807AK
ALUMINIUM "DARK"	71807AKN



RACCORDO
LINK PIPE
71491MI *



COLLETTORI RACING
RACING COLLECTORS
71492MI



* **II RACCORDO 71491MI MONTA SIA SU COLL. ORIGINALI CHE SU COLL. ARROW**
71354MI LINK PIPE FITS TO BOTH ARROW AND ORIGINAL COLLECTORS



← **Fitment** - The continuous line means that it is necessary to fit all the components

← - - - - **Option for fitment** - The dotted line means that it is not needed to fit all the components



70



HONDA

FMX 650 '05/08

VEHICLE TYPE: RD12

3



**THUNDER
STEEL END CAP**

		HOMOL.
TITANIUM		72607PO *
ALUMINIUM		72607AO *



COLLETTORI RACING
RACING COLLECTORS
72069PD



* **I TERMINALI MONTANO ANCHE SU COLLETTORI ORIGINALI**
SILENCERS ALSO FIT TO ORIGINAL COLLECTORS



HONDA

XL 650 V Transalp '00/07



VEHICLE TYPE: RD10 - RD11

8



**RACE-TECH
STEEL END CAP**

		HOMOL.
TITANIUM		72606PO *
ALUMINIUM		72606AO *
ALUMINIUM "DARK"		72606AON *



COLLETTORI RACING
RACING COLLECTORS
72068PD



* **I TERMINALI MONTANO ANCHE SU COLLETTORI ORIGINALI**
SILENCERS ALSO FIT TO ORIGINAL COLLECTORS



← **Fitment** - The continuous line means that it is necessary to fit all the components

← - - - **Option for fitment** - The dotted line means that it is not needed to fit all the components



HONDA

CB 650 F - CBR 650 F '14/18

EURO3

EURO4



VEHICLE TYPE: RC74 - RC75 - RC96 - RC97

X-KONE CARBON CAP

ECE HOMOL.	
NICHROM	71821XKI

THUNDER CARBON CAP

ECE HOMOL.	
TITANIUM	71821PK
CARBON FIBRE	71821MK
ALUMINIUM	71821AK
ALUMINIUM "DARK"	71821AKN

PRO-RACE TITANIUM CAP

RACING	
TITANIUM	71205PR

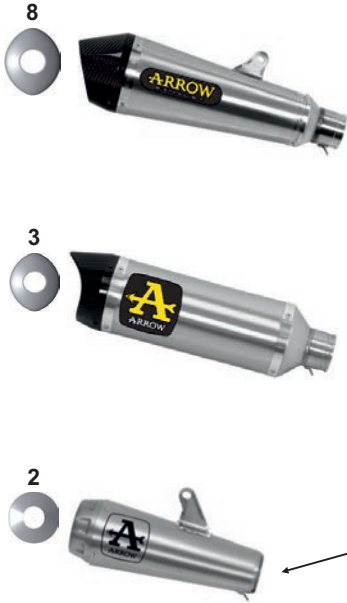

COLLETTORI CATALITICI OMOLOGATI
CATALYTIC HOMOLOGATED
COLLECTORS
71614KZ

COLLETTORI RACING
RACING COLLECTORS
71614MI

dB-KILLER PER TERMINALI PRO-RACE
dB-KILLER FOR PRO-RACE SILENCERS
11012DB - € 46,00



HONDA

CB 650 R - CBR 650 R '19/21

EURO4

EURO5



VEHICLE TYPE: RH01 - RH02

PRO-RACE TWIN TITANIUM END CAP

ECE HOMOL.	
TITANIUM	71902PR

PRO-RACE TWIN STEEL END CAP

ECE HOMOL.	
NICHROM	71902PRI
NICHROM "DARK"	71902PRN

KIT COMPLETO OMOLOGATO
HOMOLOGATED FULL SYSTEM
FULL TITANIUM or FULL STAINLESS STEEL
PRO-RACE TWIN SILENCERS
WITH WELDED LINK PIPE
STAINLESS STEEL COLLECTORS



← **Fitment** - The continuous line means that it is necessary to fit all the components

← - - - **Option for fitment** - The dotted line means that it is not needed to fit all the components



HONDA

CB 650 R - CBR 650 R '19/21

EURO4

EURO5



VEHICLE TYPE: RH01 - RH02

X-KONE CARBON CAP

	ECE	HOMOL.
NICHROM		71892XKI

THUNDER CARBON CAP

	ECE	HOMOL.
TITANIUM		71892PK
CARBON FIBRE		71892MK
ALUMINIUM		71892AK
ALUMINIUM "DARK"		71892AKN

THUNDER STEEL CAP

	ECE	HOMOL.
ALUMINIUM		71892AO
ALUMINIUM "DARK"		71892AON

PRO-RACE TITANIUM CAP

	RACING
TITANIUM	71217PR

PRO-RACE STEEL CAP

	RACING
NICHROM	71217PRI
NICHROM "DARK"	71217PRN

GP2 SILENCERS

	RACING
FULL TITANIUM	71034GP
NICHROM "DARK"	71034GPI



COLLETTORI CATALITICI OMOLOGATI
CATALYTIC HOMOLOGATED
COLLECTORS
71704KZ



COLLETTORI RACING
RACING COLLECTORS
71704MI



dB-KILLER PER TERMINALI PRO-RACE
dB-KILLER FOR PRO-RACE SILENCERS
11012DB



dB-KILLER PER TERMINALE GP2
dB-KILLER FOR GP2 SILENCER
11009DB



Fitment - The continuous line means that it is necessary to fit all the components



Option for fitment - The dotted line means that it is not needed to fit all the components



HONDA

Integra 700 - NC 700 S - NC 700 X '12/13



VEHICLE TYPE: RC61 - RC62 - RC63

RACE-TECH STEEL CAP

	9	HOMOL.
ALUMINIUM		71796AO
ALUMINIUM "DARK"		71796AON

RACE-TECH CARBON CAP

	9	HOMOL.
TITANIUM		71796PK
CARBON FIBRE		71796MK
ALUMINIUM		71796AK
ALUMINIUM "DARK"		71796AKN

8



8



RACCORDO LINK PIPE
71463MI *



COLLETTORE RACING
INTERCambiabile con
quello originale
RACING COLLECTOR
INTERCHANGEABLE WITH
ORIGINAL ONE
71464MI



* **Il RACCORDO MONTA SIA SU COLL. ORIGINALE CHE SU COLL. ARROW
71463MI LINK PIPE FITS TO BOTH ARROW AND ORIGINAL COLLECTORS**



HONDA

Integra 750 - NC 750 S - NC 750 X '14/20



VEHICLE TYPE: RC70 - RC71 - RC72 - RC88 - RC89 - RC90

X-KONE CARBON END CAP

	9	ECE	HOMOL.
NICHROM			71796XKI

RACE-TECH STEEL CAP

	9	ECE	HOMOL.
ALUMINIUM			71796AO
ALUMINIUM "DARK"			71796AON

RACE-TECH CARBON CAP

	9	ECE	HOMOL.
TITANIUM			71796PK
CARBON FIBRE			71796MK
ALUMINIUM			71796AK
ALUMINIUM "DARK"			71796AKN

8



8



8



RACCORDO LINK PIPE
71463MI *



COLLETTORE RACING
INTERCambiabile con
quello originale
RACING COLLECTOR
INTERCHANGEABLE WITH
ORIGINAL ONE
71464MI



* **Il RACCORDO MONTA SIA SU COLL. ORIGINALE CHE SU COLL. ARROW
71463MI LINK PIPE FITS TO BOTH ARROW AND ORIGINAL COLLECTORS**



Fitment - The continuous line means that it is necessary to fit all the components



Option for fitment - The dotted line means that it is not needed to fit all the components



74



HONDA

X-ADV 750 '17/21

EURO4

EURO5

EC ECE

CARB

VEHICLE TYPE: RC95 - RH10

PRO-RACE STEEL END CAP

	ECE	HOMOL.
NICHROM	71864PRI *	
NICHROM "DARK"	71864PRN *	



RACE-TECH CARBON CAP LONG VERSION

	ECE	HOMOL.
TITANIUM	71864PK *	
CARBON FIBRE	71864MK *	
ALUMINIUM	71864AK *	
ALUMINIUM "DARK"	71864AKN *	



RACE-TECH CARBON CAP SHORT VERSION

	ECE	HOMOL.
TITANIUM	71864PKC *	
CARBON FIBRE	71864MKC *	
ALUMINIUM	71864AKC *	
ALUMINIUM "DARK"	71864AKNC *	



COLLETORE RACING
RACING COLLECTOR
71671MI *



* **TUTTI I COMPONENTI SONO INTERCambiabili CON QUELLI ORIGINALI**
ALL THE COMPONENTS ARE INTERCHANGEABLE WITH THE ORIGINAL ONES



Fitment - The continuous line means that it is necessary to fit all the components



Option for fitment - The dotted line means that it is not needed to fit all the components



75



HONDA

FORZA 750 '21

EURO5 EC ECE CARB

PRO-RACE STEEL CAP

	ECE	HOMOL.
NICHROM	73518PRI *	
NICHROM "DARK"	73518PRN *	

INDY RACE LONG VERSION

	ECE	HOMOL.
TITANIUM	73518PK *	
ALUMINIUM	73518AK *	
ALUMINIUM "DARK"	73518AKN *	

INDY RACE SHORT VERSION

	ECE	HOMOL.
TITANIUM	73518PKC *	
ALUMINIUM	73518AKC *	
ALUMINIUM "DARK"	73518AKNC *	

VEHICLE TYPE: RH11

2



4



4



COLLETORE RACING
RACING COLLECTOR
73019MI *



* **TUTTI I COMPONENTI SONO INTERCAMBIABILI
CON QUELLI ORIGINALI**
**ALL THE COMPONENTS ARE INTERCHANGEABLE
WITH THE ORIGINAL ONES**



HONDA

NC 750 X '21

EURO5 EC ECE CARB

X-KONE CARBON END CAP

	ECE	HOMOL.
NICHROM	71933XKI	

RACE-TECH CARBON CAP

	ECE	HOMOL.
TITANIUM	71933PK	
CARBON FIBRE	71933MK	
ALUMINIUM	71933AK	
ALUMINIUM "DARK"	71933AKN	

VEHICLE TYPE: RH09

8



8



RACCORDO
LINK PIPE
71463MI *

COLLETORE RACING
INTERCAMBIABILE CON
QUELLO ORIGINALE
RACING COLLECTOR
INTERCHANGEABLE WITH
ORIGINAL ONE
71464MI



* **IL RACCORDO MONTA SIA SU COLL. ORIGINALE CHE SU COLL. ARROW**
71463MI LINK PIPE FITS TO BOTH ARROW AND ORIGINAL COLLECTORS



Fitment - The continuous line means that it is necessary to fit all the components

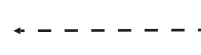

Option for fitment - The dotted line means that it is not needed to fit all the components



76



HONDA

CrossRunner 800 '15/20

EURO3

EURO4



VEHICLE TYPE: **RC80 - RC94**

X-KONE CARBON END CAP

ECE HOMOL.	
NICHROM	71825XKI



RACE-TECH CARBON END CAP

ECE HOMOL.	
TITANIUM	71825PK
CARBON FIBRE	71825MK
ALUMINIUM	71825AK
ALUMINIUM "DARK"	71825AKN



**TERMINALI PER COLLETTORI ORIGINALI
SILENCERS FOR ORIGINAL COLLECTORS**

HONDA

VFR 800 '17/20

EURO4



VEHICLE TYPE: **RC93**

RACE-TECH CARBON END CAP

ECE HOMOL.	
TITANIUM	71910PK
CARBON FIBRE	71910MK
ALUMINIUM	71910AK
ALUMINIUM "DARK"	71910AKN



**TERMINALI PER COLLETTORI ORIGINALI
SILENCERS FOR ORIGINAL COLLECTORS**



Fitment - The continuous line means that it is necessary to fit all the components



Option for fitment - The dotted line means that it is not needed to fit all the components



77



VEHICLE TYPE: SD04 - SD06

**SONORA
CARBON END CAP**

9 ECE HOMOL.	
TITANIUM	72503SK *
TITANIUM "DARK"	72503SKN *

**MAXI RACE-TECH
CARBON END CAP**

9 ECE HOMOL.	
TITANIUM	72621PK *
ALUMINIUM	72621AK *
ALUMINIUM "DARK"	72621AKN *

**MAXI RACE-TECH
STEEL END CAP**

9 ECE HOMOL.	
TITANIUM	72621PO *
ALUMINIUM	72621AO *
ALUMINIUM "DARK"	72621AON *

PROTEZIONE PARATACCO
IN CARBONIO PER KIT COMPLETO
CARBON HEEL GUARD
FOR FULL SYSTEM
11003MI



COLLETTORI RACING
RACING COLLECTORS
72129PD *



*** TUTTI I COMPONENTI SONO INTERCAMBIABILI
CON QUELLI ORIGINALI
ALL THE COMPONENTS ARE INTERCHANGEABLE
WITH THE ORIGINAL ONES**

9 ECE

KIT COMPLETO OMOLOGATO
HOMOLOGATED FULL SYSTEM
RACE-TECH TITANIUM SILENCER
RACING TITANIUM LINK PIPE
RACING TITANIUM COLLECTORS
72521PO



← **Fitment** - The continuous line means that it is necessary to fit all the components

← **Option for fitment** - The dotted line means that it is not needed to fit all the components



VEHICLE TYPE: **SD06**

SONORA CARBON END CAP

	ECE	HOMOL.
TITANIUM	72503SK *	
TITANIUM "DARK"	72503SKN *	

MAXI RACE-TECH CARBON END CAP

	ECE	HOMOL.
TITANIUM	72621PK *	
ALUMINIUM	72621AK *	
ALUMINIUM "DARK"	72621AKN *	

MAXI RACE-TECH STEEL END CAP

	ECE	HOMOL.
TITANIUM	72621PO *	
ALUMINIUM	72621AO *	
ALUMINIUM "DARK"	72621AON *	

PROTEZIONE PARATACCO
IN CARBONIO PER KIT COMPLETO
CARBON HEEL GUARD
FOR FULL SYSTEM
11003MI



COLLETTORI RACING
RACING COLLECTORS
72149PD *



*** TUTTI I COMPONENTI SONO INTERCambiabili
CON QUELLI ORIGINALI
ALL THE COMPONENTS ARE INTERCHANGEABLE
WITH THE ORIGINAL ONES**



KIT COMPLETO OMOLOGATO
HOMOLOGATED FULL SYSTEM
RACE-TECH TITANIUM SILENCER
RACING TITANIUM LINK PIPE
RACING TITANIUM COLLECTORS
72521PO



Fitment - The continuous line means that it is necessary to fit all the components



Option for fitment - The dotted line means that it is not needed to fit all the components



VEHICLE TYPE: SD08 - SD09

SONORA CARBON END CAP

	ECE	HOMOL.
TITANIUM	72504SK *	
TITANIUM "DARK"	72504SKN *	



MAXI RACE-TECH CARBON CAP

	ECE	HOMOL.
TITANIUM	72625PK *	
ALUMINIUM	72625AK *	
ALUMINIUM "DARK"	72625AKN *	



MAXI RACE-TECH STEEL CAP

	ECE	HOMOL.
TITANIUM	72625PO *	
ALUMINIUM	72625AO *	
ALUMINIUM "DARK"	72625AON *	



COLLETTORI RACING IN TITANIO
TITANIUM RACING COLLECTORS
72168PD *



COLLETTORI RACING IN ACCIAIO
STEEL RACING COLLECTORS
72166PD *



* **TUTTI I COMPONENTI SONO INTERCambiabili CON QUELLI ORIGINALI**
ALL THE COMPONENTS ARE INTERCHANGEABLE WITH THE ORIGINAL ONES



← **Fitment** - The continuous line means that it is necessary to fit all the components



← **Option for fitment** - The dotted line means that it is not needed to fit all the components



HONDA

CB 1000 R '08/17



VEHICLE TYPE: **SC60**

THUNDER CARBON END CAP

	HOMOL.
TITANIUM	71732PK *
ALUMINIUM	71732AK *
ALUMINIUM "DARK"	71732AKN *

THUNDER STEEL END CAP

	HOMOL.
TITANIUM	71732PO *
ALUMINIUM	71732AO *
ALUMINIUM "DARK"	71732AON *



COVER IN CARBONIO PER
RACCORDO CENTRALE
CARBON FIBRE COVER FOR
CENTRAL LINK PIPE
11002MI



RACCORDO NON CATALITICO
IN SOSTITUZIONE DI QUELLO
CATALITICO ORIGINALE
NON CATALYZED LINK PIPE
REPLACES CATALYZED
ORIGINAL LINK PIPE
71389MI #



* TUTTI I TERMINALI MONTANO ANCHE SU RACCORDO CATALITICO ORIGINALE
ALL SILENCERS ALSO FIT TO ORIGINAL CATALYZED LINK PIPE



IL RACCORDO 71389MI MONTA
ANCHE CON TERMINALI ORIGINALI
71389MI LINK PIPE ALSO FITS TO
ORIGINAL COLLECTORS



Fitment - The continuous line means that it is necessary to fit all the components

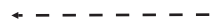

Option for fitment - The dotted line means that it is not needed to fit all the components



VEHICLE TYPE: **SC80**

**PRO-RACE
TITANIUM END CAP**

	ECE	HOMOL.
TITANIUM	71882PR *	

**PRO-RACE
STEEL END CAP**

	ECE	HOMOL.
NICHROM	71882PRI *	
NICHROM "DARK"	71882PRN *	

GP2 SILENCERS

	ECE	HOMOL.
TITANIUM	71546GP *	
NICHROM "DARK"	71546GPI *	

**PRO-RACE
TITANIUM END CAP**

	ECE	HOMOL.
TITANIUM	71885PR *	

**PRO-RACE
STEEL END CAP**

	ECE	HOMOL.
NICHROM	71885PRI *	
NICHROM "DARK"	71885PRN *	

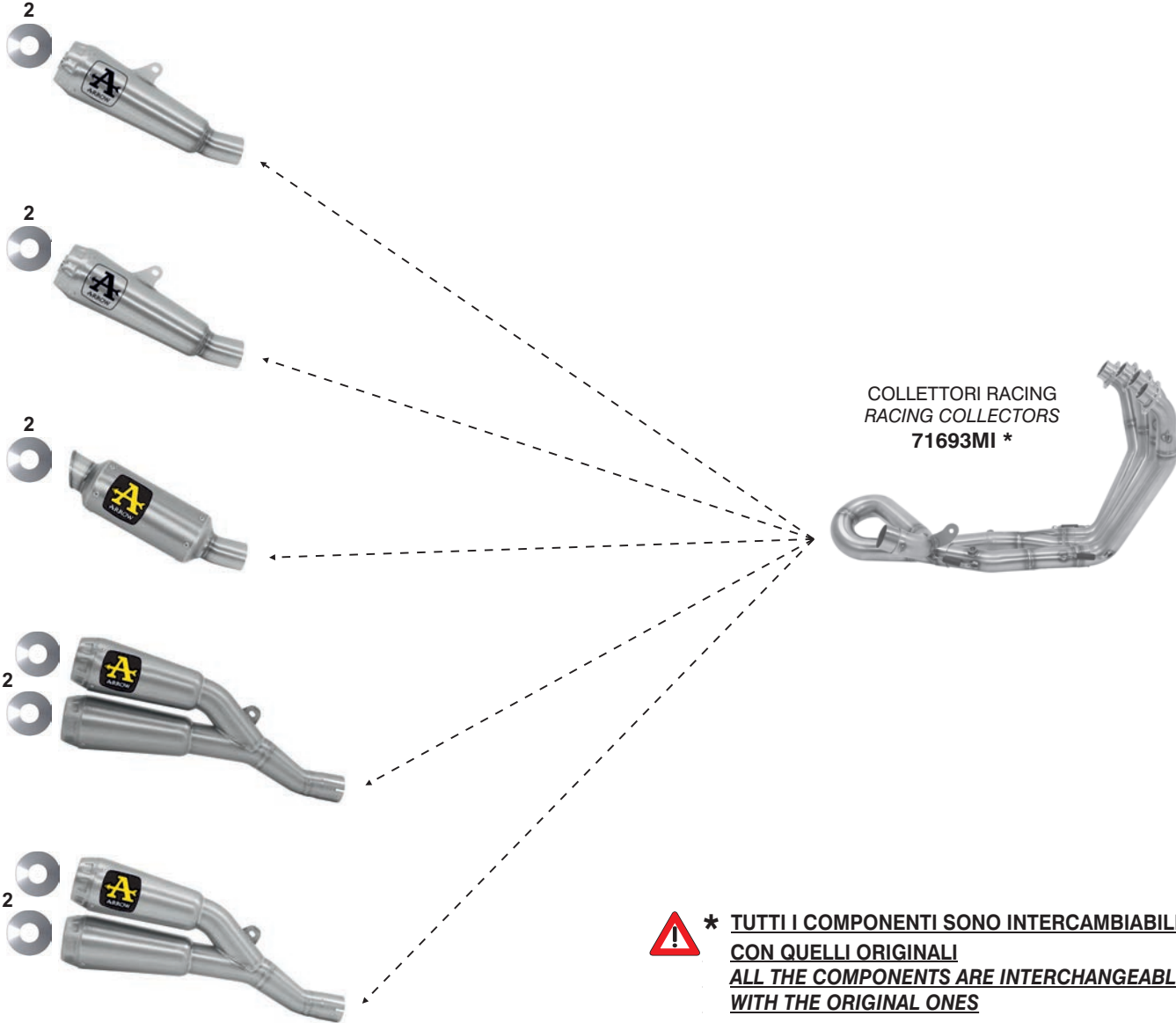

*** TUTTI I COMPONENTI SONO INTERCambiabili
CON QUELLI ORIGINALI
ALL THE COMPONENTS ARE INTERCHANGEABLE
WITH THE ORIGINAL ONES**



Fitment - The continuous line means that it is necessary to fit all the components

Option for fitment - The dotted line means that it is not needed to fit all the components



HONDA

CBR 1000 RR '04/07



VEHICLE TYPE: **SC57**



**MAXI RACE-TECH
CARBON END CAP**

9 HOMOL.	
TITANIUM	71684PK



**MAXI RACE-TECH
STEEL END CAP**

9 HOMOL.	
TITANIUM	71684PO
ALUMINIUM	71684AO



RACCORDO
LINK PIPE
71335MI *



COLLETTORI RACING
RACING COLLECTORS
71336MI



* **II RACCORDO 71335MI MONTA SIA SU COLL. ORIGINALI CHE SU COLL. ARROW**
71335MI LINK PIPE FITS TO BOTH ARROW AND ORIGINAL COLLECTORS



HONDA

CBR 1000 RR '08/13



VEHICLE TYPE: **SC59**

INDY-RACE CARBON CAP

9 HOMOL.	
TITANIUM	71727PK
CARBON FIBRE	71727MK
ALUMINIUM	71727AK
ALUMINIUM "DARK"	71727AKN

GP2 SILENCERS

RACING	
FULL TITANIUM	71003GP *
STEEL "DARK"	71003GPI *



RACCORDO CATALITICO OMOLOGATO
PER COLLETTORI ORIGINALI
CATALYTIC HOMOLOGATED LINK PIPE
FOR ORIGINAL COLLECTORS
71379KZ



RACCORDO RACING PER
COLLETTORI ORIGINALI
RACING LINK PIPE FOR
ORIGINAL COLLECTORS
71379MI



dB-KILLER PER TERMINALE GP2
dB-KILLER FOR GP2 SILENCER
11009DB



* **TERMINALE PER COLLETTORI ORIGINALI**
SILENCER FOR ORIGINAL COLLECTORS



← **Fitment** - The continuous line means that it is necessary to fit all the components



← **Option for fitment** - The dotted line means that it is not needed to fit all the components



HONDA

CBR 1000 RR '14/16



VEHICLE TYPE: **SC59**

X-KONE CARBON END CAP

		HOMOL.
NICHROM		71818XKI



RACCORDO PER COLLETTORI ORIGINALI
LINK PIPE FOR ORIGINAL COLLECTORS
71606MI

GP2 SILENCERS

	RACING
FULL TITANIUM	71010GP *
STEEL "DARK"	71010GPI *



dB-KILLER PER TERMINALE GP2
dB-KILLER FOR GP2 SILENCER
11009DB



* TERMINALE PER COLLETTORI ORIGINALI
SILENCER FOR ORIGINAL COLLECTORS



HONDA

CBR 1000 RR '17/19



VEHICLE TYPE: **SC77**



INDY-RACE CARBON END CAP

		HOMOL.
TITANIUM		71869PK
CARBON FIBRE		71869MK
ALUMINIUM		71869AK
ALUMINIUM "DARK"		71869AKN

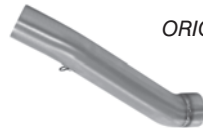

RACCORDO PER COLLETTORI ORIGINALI
LINK PIPE FOR ORIGINAL COLLECTORS
71679MI



PRO-RACE TITANIUM END CAP

	RACING
FULL TITANIUM	71175HCP *



* TERMINALE PER COLLETTORI ORIGINALI
SILENCER FOR ORIGINAL COLLECTORS



← **Fitment** - The continuous line means that it is necessary to fit all the components

← - - - **Option for fitment** - The dotted line means that it is not needed to fit all the components



HONDA

CBR 1000 RR '20/21



VEHICLE TYPE: **SC82**

**WORKS
CARBON END CAP**

	ECE	HOMOL.
TITANIUM	71921PK *	



**PRO-RACE
TITANIUM END CAP**

	RACING
FULL TITANIUM	71155PR *



* **TUTTI I COMPONENTI SONO INTERCambiABILI
CON QUELLI ORIGINALI
ALL THE COMPONENTS ARE INTERCHANGEABLE
WITH THE ORIGINAL ONES**



**KIT COMPLETO / FULL SYSTEM
"COMPETITION" «EVO»**
PRO-RACE TITANIUM SILENCER
TITANIUM ø54-60 LINK PIPE
TITANIUM COLLECTORS



**KIT COMPLETO / FULL SYSTEM
"COMPETITION"**

WORKS TITANIUM SILENCER
WITH CARBON END CAP
AND dB-KILLER
TITANIUM ø54-60 LINK PIPE
TITANIUM COLLECTORS



COMPETITION

	CARBON CAP
FULL TITANIUM	71212CKZ



COMPETITION "EVO"

	CLASSIC CAP
FULL TITANIUM	71212CP

	CAP with MESH
FULL TITANIUM	71212CPF



FONDELLO CON RETE
END CAP WITH MESH

**KIT COMPLETO / FULL SYSTEM
"COMPETITION" «SBK»**

WORKS TITANIUM SILENCER
WITH CARBON END CAP
AND dB-KILLER
TITANIUM ø54-60 LINK PIPE
TITANIUM COLLECTORS



COMPETITION "SBK"

	CARBON CAP
FULL TITANIUM	71212CKR #



**IL KIT COMPETITION «SBK» MONTA SOLO CON FORCELLONE SBK
COMPETITION «SBK» FULL SYSTEM FITS ONLY WITH SBK SWINGARM**



← **Fitment** - The continuous line means that it is necessary to fit all the components

← - - - **Option for fitment** - The dotted line means that it is not needed to fit all the components



VEHICLE TYPE: **SC65**

PRO-RACING
STEEL END CAP

		HOMOL.
NICHROM		71672PRI

10



TERMINALI PER COLLETTORI ORIGINALI
SILENCERS FOR ORIGINAL COLLECTORS



VEHICLE TYPE: **SC78**

PRO-RACING
STEEL END CAP

		HOMOL.
NICHROM		71862PRI *
NICHROM "DARK"		71862PRN *

10



COLLETTORI RACING
RACING COLLECTORS
71669MI *



* TUTTI I COMPONENTI SONO INTERCAMBIABILI CON QUELLI ORIGINALI
ALL THE COMPONENTS ARE INTERCHANGEABLE WITH THE ORIGINAL ONES



Fitment - The continuous line means that it is necessary to fit all the components



Option for fitment - The dotted line means that it is not needed to fit all the components



HONDA

CrossTourer 1200 '12/20

EURO3

EURO4

9 e 5
2009/120/CE

EC
ECE

CARB

VEHICLE TYPE: **SC70 - SC76**

RACE-TECH CARBON END CAP

	ECE	HOMOL.
ALUMINIUM		71798AK
ALUMINIUM "DARK"		71798AKN



RACORDO PER
COLLETTORI ORIGINALI
LINK PIPE FOR
ORIGINAL COLLECTORS
71468MI



HUSQVARNA

Svartpilen / Vitpilen 125 '21

EURO5

EC
ECE

CARB

PRO-RACE STEEL CAP

	ECE	HOMOL.
NICHROM		72636PRI *
NICHROM "DARK"		72636PRN *



GP2 SILENCERS

	ECE	HOMOL.
TITANIO		72636GP *
NICHROM "DARK"		72636GPI *



INDY RACE CARBON CAP

	ECE	HOMOL.
TITANIUM		72636PK *
ALUMINIUM		72636AK *
ALUMINIUM "DARK"		72636AKN *



COLLETTORE RACING
RACING COLLECTOR
71757MI *



* **TUTTI I COMPONENTI MONTANO CON
RACCORDO CENTRALE ORIGINALE
ALL THE COMPONENTS FIT TO
ORIGINAL CENTRAL LINK PIPE**



← **Fitment** - The continuous line means that it is necessary to fit all the components

← - - - **Option for fitment** - The dotted line means that it is not needed to fit all the components



VEHICLE TYPE: **HQV 401**

PRO-RACE STEEL CAP

	ECE	HOMOL.
NICHROM	71905PRI *	
NICHROM "DARK"	71905PRN *	



GP2 SILENCERS

	ECE	HOMOL.
TITANIUM	71555GP *	
NICHROM "DARK"	71555GPI *	



RACC. NON CATALITICO
IN SOSTITUZIONE DI QUELLO
CATALITICO ORIGINALE
NON CATALYZED LINK PIPE
REPLACES CATALYZED
ORIGINAL LINK PIPE
71668MI



* TERMINALI PER COLLETTORI ORIGINALI
SILENCERS FOR ORIGINAL COLLECTORS



VEHICLE TYPE: **HQV 401**

PRO-RACE STEEL CAP

	ECE	HOMOL.
NICHROM	72631PRI *	
NICHROM "DARK"	72631PRN *	



GP2 SILENCERS

	ECE	HOMOL.
TITANIO	72631GP *	
NICHROM "DARK"	72631GPI *	



INDY RACE CARBON CAP

	ECE	HOMOL.
TITANIUM	72631PK *	
ALUMINIUM	72631AK *	
ALUMINIUM "DARK"	72631AKN *	



COLLETTORE RACING
RACING COLLECTOR
71745MI *



* TUTTI I COMPONENTI MONTANO CON
RACCORDO CENTRALE ORIGINALE
ALL THE COMPONENTS FIT TO
ORIGINAL CENTRAL LINK PIPE



← ————— **Fitment** - The continuous line means that it is necessary to fit all the components

← - - - - - **Option for fitment** - The dotted line means that it is not needed to fit all the components



HUSQVARNA

Vitpilen 701 '18/19

EURO4



VEHICLE TYPE: **HQV 701 A**

WORKS CARBON END CAP

	ECE	HOMOL.
TITANIUM	71891PK *	

PRO-RACE TITANIUM CAP

	ECE	HOMOL.
TITANIUM	71891PR *	

PRO-RACE STEEL CAP

	ECE	HOMOL.
NICHROM	71891PRI *	
NICHROM "DARK"	71891PRN *	



RACCORDO CENTRALE
NON CATALITICO
NON CATALYZED
CENTRAL LINK PIPE
71703MI *



* **TUTTI I COMPONENTI MONTANO CON
RACCORDO CENTRALE ORIGINALE
ALL THE COMPONENTS FIT TO
ORIGINAL CENTRAL LINK PIPE**



HUSQVARNA

701 Enduro - Supermoto '17/20

EURO4



VEHICLE TYPE: **HUSQVARNA 701**

COLLETORE RACING
INTERCambiabile con quello originale
RACING COLLECTOR
INTERCHANGEABLE WITH ORIGINAL ONE
72144PD



EC
RACCORDO CATALITICO OMOLOGATO
CATALYTIC HOMOLOGATED LINK PIPE
72143KZ *



RACCORDO RACING
RACING LINK PIPE
72143PD *



RACE-TECH
CARBON END CAP

	ECE	HOMOL.
TITANIUM	72623PK	
ALUMINIUM	72623AK	
ALUMINIUM "DARK"	72623AKN	



* **I RACCORDI 72143KZ e 72143PD MONTANO ANCHE SU COLLETTORI ORIGINALI
72143KZ and 72143PD LINK PIPES ALSO FIT TO ORIGINAL COLLECTORS**



← **Fitment** - The continuous line means that it is necessary to fit all the components



← **Option for fitment** - The dotted line means that it is not needed to fit all the components



VEHICLE TYPE: HUSQVARNA 701

COLLETTORE RACING IN TITANIO
CON POWER BOMB
TIANIUM RACING COLLECTOR
WITH POWER BOMB
72183PD #



COLLETTORE RACING IN ACCIAIO INOX
CON POWER BOMB
STAINLESS STEEL RACING COLLECTOR
WITH POWER BOMB
72182PD #



COLLETTORE RACING IN ACCIAIO INOX
STAINLESS STEEL RACING COLLECTOR
72176PD #



RACCORDO
CATALITICO OMOLOGATO
CATALYTIC HOMOLOGATED
LINK PIPE
72175PZ *



RACCORDO RACING
RACING LINK PIPE
72175PD *



RACE-TECH
CARBON END CAP

	ECE	HOMOL.
TITANIUM		72623PK
ALUMINIUM		72623AK
ALUMINIUM "DARK"		72623AKN

DB-KILLER
SPARK ARRESTER
12005PD



*** I RACCORDI 72175PD e 72175PZ MONTANO ANCHE SU COLLETTORE ORIGINALE**
72175PD and 72175PZ LINK PIPES FIT ALSO TO ORIGINAL COLLECTOR



TUTTI I KIT COLLETTORI SONO INTERCAMBIABILI CON QUELLO ORIGINALE
ALL COLLECTORS ARE INTERCHANGEABLE WITH ORIGINAL COLLECTOR



Fitment - The continuous line means that it is necessary to fit all the components



Option for fitment - The dotted line means that it is not needed to fit all the components



HUSQVARNA

Nuda 900 - Nuda 900 R '12/13



VEHICLE TYPE: **A7**



COLLETTORI RACING
RACING COLLECTORS
71458MI *



4

WORKS
CARBON END CAP

		HOMOL.
TITANIUM		71793PK *



* **TUTTI I COMPONENTI SONO INTERCAMBIABILI CON QUELLI ORIGINALI**
ALL THE COMPONENTS ARE INTERCHANGEABLE WITH THE ORIGINAL ONES

KAWASAKI

J 125 '16



VEHICLE TYPE: **C6**

URBAN BLACK STEEL CAP	
	HOMOL.
ALUMINIUM "DARK"	53511ANN



8



COLLETORE CATALITICO OMOLOGATO
CATALYTIC HOMOLOGATED COLLECTOR
53058KZ



COLLETORE RACING
RACING COLLECTOR
53058MI





Fitment - The continuous line means that it is necessary to fit all the components



Option for fitment - The dotted line means that it is not needed to fit all the components



**PRO-RACE
STEEL END CAP**

		
NICHROM	71897PRI *	
NICHROM "DARK"	71897PRN *	

2



COLLETORE RACING
RACING COLLECTOR
71711MI *



* **TUTTI I COMPONENTI SONO INTERCAMBIABILI CON QUELLI ORIGINALI**
ALL THE COMPONENTS ARE INTERCHANGEABLE WITH THE ORIGINAL ONES

**URBAN
BLACK STEEL CAP**

		
ALUMINIUM "DARK"	53506ANN	

8



COLLETORE CATALITICO OMOLOGATO
CATALYTIC HOMOLOGATED COLLECTOR
53053KZ



COLLETORE RACING
RACING COLLECTOR
53053MI



← **Fitment** - The continuous line means that it is necessary to fit all the components

← - - - - **Option for fitment** - The dotted line means that it is not needed to fit all the components



KAWASAKI**J 300 '17/20**

EURO4

VEHICLE TYPE: **C4**URBAN
BLACK STEEL CAP

ECE HOMOL.

ALUMINIUM
"DARK" 53532ANN

8



EC

COLLETTORE CATALITICO OMOLOGATO
CATALYTIC HOMOLOGATED COLLECTOR
53079KZCOLLETTORE RACING
RACING COLLECTOR
53079MI**KAWASAKI****Ninja 250 '13/16**VEHICLE TYPE: **EX250L**

2



GP2 SILENCERS

	RACING
FULL TITANIUM	71018GP *
STEEL "DARK"	71018GPI *

dB-KILLER PER TERMINALE GP2
dB-KILLER FOR GP2 SILENCER
11009DB**TERMINALI PER COLLETTORI ORIGINALI**
SILENCERS FOR ORIGINAL COLLECTORS**Ninja 300 '13/16**VEHICLE TYPE: **EX300A**

8



X-KONE CARBON CAP

	HOMOL.
NICHROM	71801XKI *

**Z 300 '15/16**VEHICLE TYPE: **ER300A****Fitment** - The continuous line means that it is necessary to fit all the components**Option for fitment** - The dotted line means that it is not needed to fit all the components**93**

VEHICLE TYPE: ER400D

X-KONE CARBON END CAP

	ECE	HOMOL.
NICHROM		71874XKI *



RACE-TECH CARBON ENDCAP

	ECE	HOMOL.
TITANIUM		71874PK *
CARBON FIBRE		71874MK *
ALUMINIUM		71874AK *
ALUMINIUM "DARK"		71874AKN *



PRO-RACE STEEL END CAP

	ECE	HOMOL.
NICHROM		71874PRI *
NICHROM "DARK"		71874PRN *



GP2 SILENCERS

	ECE	HOMOL.
FULL TITANIUM		71541GP *
STEEL "DARK"		71541GPI *



* **TUTTI I COMPONENTI SONO INTERCAMBIABILI CON QUELLI ORIGINALI**
ALL THE COMPONENTS ARE INTERCHANGEABLE WITH THE ORIGINAL ONES



← **Fitment** - The continuous line means that it is necessary to fit all the components

← - - - **Option for fitment** - The dotted line means that it is not needed to fit all the components



VEHICLE TYPE: **EX400G**

X-KONE CARBON CAP

	ECE	HOMOL.
NICHROM	71874XKI *	

RACE-TECH CARBON CAP

	ECE	HOMOL.
TITANIUM	71874PK *	
CARBON FIBRE	71874MK *	
ALUMINIUM	71874AK *	
ALUMINIUM "DARK"	71874AKN *	

PRO-RACE STEEL CAP

	ECE	HOMOL.
NICHROM	71874PRI *	
NICHROM "DARK"	71874PRN *	

GP2 SILENCERS

	ECE	HOMOL.
FULL TITANIUM	71541GP *	
STEEL "DARK"	71541GPI *	

KIT COMPLETO / FULL SYSTEM

COMPETITION "EVO"

WORKS TITANIUM SILENCER WITH CARBON END CAP AND dB-KILLER
TITANIUM \varnothing 42-54 LINK PIPE
TITANIUM or STEEL COLLECTORS



	CARBON CAP
FULL TITANIUM	71214CKZ #
STEEL COLLECT.	71213CKZ #



* **TUTTI I COMPONENTI SONO INTERCAMBIABILI CON QUELLI ORIGINALI**
ALL THE COMPONENTS ARE INTERCHANGEABLE WITH THE ORIGINAL ONES

COLLETTORI RACING
RACING COLLECTORS
71686MI *

KIT COMPLETO / FULL SYSTEM

COMPETITION

WORKS TITANIUM SILENCER WITH CARBON END CAP AND dB-KILLER
TITANIUM \varnothing 42-60 LINK PIPE
TITANIUM or STEEL COLLECTORS



COMPETITION

	CARBON CAP
FULL TITANIUM	71193CKR #
STEEL COLLECT.	71192CKR #



I KIT COMPETITION MONTANO CON:
- RADIATORE MAGGIORATO RACING
- SOLO PEDANE RIALZATE
- CARENE DA GARA
- SOLO Sonda LAMBDA \varnothing 18mm

COMPETITION FULL SYSTEM FIT TO:
- RACING RADIATOR
- RACING REAR SETS ONLY
- RACING BODYWORK
- LAMBDA SENSOR \varnothing 18mm ONLY



← **Fitment** - The continuous line means that it is necessary to fit all the components

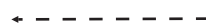

← **Option for fitment** - The dotted line means that it is not needed to fit all the components



VEHICLE TYPE: **ZX600R**

VEHICLE TYPE: **ZX636E**



**X-KONE
CARBON END CAP**

		HOMOL.
NICHROM	9	71734XK1 *

RACCORDO PER
TERMINALE X-KONE
LINK PIPE FOR
X-KONE SILENCERS
71395MI

COLLETTORI RACING
RACING COLLECTORS
71396MI



* **MONTA ANCHE SU COLLETTORI ORIGINALI**
SILENCER ALSO FITS TO ORIGINAL COLLECTORS



GP2 SILENCERS

	RACING
FULL TITANIUM	71005GP #
STEEL "DARK"	71005GPI #

dB-KILLER PER TERMINALE GP2
dB-KILLER FOR GP2 SILENCER
11009DB

KIT COMPLETO / FULL SYSTEM
COMPETITION
RACE-TECH TITANIUM OR
CARBON FIBRE SILENCER
WITH CARBON END CAP AND dB-KILLER
TITANIUM LINK PIPE ϕ 45-60
TITANIUM OR STEEL
COLLECTORS



TERMINALE PER COLLETTORI ORIGINALI
SILENCER FOR ORIGINAL COLLECTORS

COMPETITION

	TITANIUM SILENCER	CARBON SILENCER
FULL TITANIUM	71209CKZ	71209MKZ
STEEL COLLECT.	71208CKZ	71208MKZ



Fitment - The continuous line means that it is necessary to fit all the components



Option for fitment - The dotted line means that it is not needed to fit all the components



KAWASAKI

ZX-6R 636 '19/20

EURO4

EC
ECE

CARB

VEHICLE TYPE: ZX636G

X-KONE CARBON CAP

	ECE	HOMOL.
NICHROM	71898XKI *	

RACE-TECH CARBON CAP

	ECE	HOMOL.
TITANIUM	71898PK *	
CARBON FIBRE	71898MK *	
ALUMINIUM	71898AK *	
ALUMINIUM "DARK"	71898AKN *	

PRO-RACE TITANIUM CAP

	ECE	HOMOL.
TITANIUM	71898PR *	

PRO-RACE STEEL CAP

	ECE	HOMOL.
NICHROM	71898PRI *	
NICHROM "DARK"	71898PRN *	

GP2 SILENCERS

	ECE	HOMOL.
FULL TITANIUM	71553GP *	
NICHROM "DARK"	71553GPI *	



*** TUTTI I COMPONENTI SONO INTERCambiabili CON QUELLI ORIGINALI**
ALL THE COMPONENTS ARE INTERCHANGEABLE WITH THE ORIGINAL ONES

RACCORDO CENTRALE
CENTRAL LINK PIPE
71712MI *

COLLETTORI RACING
RACING COLLECTORS
71713MI *



KIT COMPLETO / FULL SYSTEM
COMPETITION
RACE-TECH TITANIUM OR
CARBON FIBRE SILENCER
WITH CARBON END CAP AND dB-KILLER
TITANIUM LINK PIPE ø45-60
TITANIUM OR STEEL
COLLECTORS

COMPETITION

	TITANIUM SILENCER	CARBON SILENCER
FULL TITANIUM	71209CKZ	71209MKZ
STEEL COLLECT.	71208CKZ	71208MKZ



← **Fitment** - The continuous line means that it is necessary to fit all the components



← **Option for fitment** - The dotted line means that it is not needed to fit all the components



VEHICLE TYPE: EN650A

FULL SYSTEM WITH REBEL SILENCER

	 HOMOL.
CARBON END CAP	74501RB
ALUMINIUM END CAP	74501RBA
ALUM.DARK END CAP	74501RBN

10 

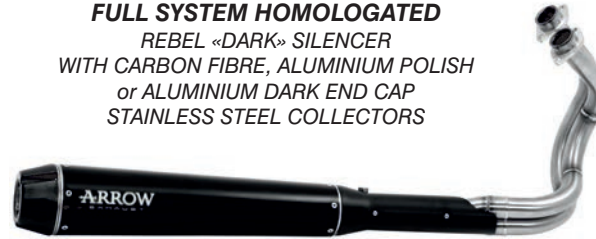

KIT COMPLETO OMOLOGATO FULL SYSTEM HOMOLOGATED

REBEL «DARK» SILENCER
WITH CARBON FIBRE, ALUMINIUM POLISH
or ALUMINIUM DARK END CAP
STAINLESS STEEL COLLECTORS



EURO4



VEHICLE TYPE: EN650D

REBEL SILENCER

	 HOMOL.
CARBON END CAP	74505RB
ALUMINIUM END CAP	74505RBA
ALUM.DARK END CAP	74505RBN

10 



COLLETTORI CATALITICI OMOLOGATI
CATALYTIC HOMOLOGATED COLLECTORS
74003KZ



COLLETTORI RACING
RACING COLLECTORS
74003MI



Fitment - The continuous line means that it is necessary to fit all the components



Option for fitment - The dotted line means that it is not needed to fit all the components



KAWASAKI**ER-6N '05/11**VEHICLE TYPE: **ER650A****ER-6F '05/11**VEHICLE TYPE: **ER650C****Versys 650 '07/14**VEHICLE TYPE: **LE650A****MAXI RACE-TECH
STEEL END CAP**

	 HOMOL.
ALUMINIUM	71698AO *
ALUMINIUM "DARK"	71698AON *

COLLETTORI RACING
RACING COLLECTORS
71357MI

* I TERMINALI MONTANO ANCHE SU COLLETTORI ORIGINALI
SILENCERS ALSO FIT TO ORIGINAL COLLECTORS

**KAWASAKI****ER-6N '12/16**VEHICLE TYPE: **ER650E****ER-6F '12/16**VEHICLE TYPE: **EX650E****Versys 650 '15/16**VEHICLE TYPE: **LE650E****X-KONE
CARBON END CAP**

	 HOMOL.
NICHROM	71794XKI

**RACE-TECH
CARBON END CAP**

	 HOMOL.
TITANIUM	71794PK
CARBON FIBRE	71794MK
ALUMINIUM	71794AK
ALUMINIUM "DARK"	71794AKN



 COLLETTORI
CATALITICI OMOLOGATI
CATALYTIC HOMOLOGATED
COLLECTORS
71459KZ

 COLLETTORI RACING
RACING COLLECTORS
71459MI

← **Fitment** - The continuous line means that it is necessary to fit all the components

← **Option for fitment** - The dotted line means that it is not needed to fit all the components

**99**

VEHICLE TYPE: **LE650E**

X-KONE CARBON CAP

	ECE	HOMOL.
NICHROM	71854XKI	
NICHROM "DARK"	71854XKN	

RACE-TECH CARBON CAP

	ECE	HOMOL.
TITANIUM	71854PK	
CARBON FIBRE	71854MK	
ALUMINIUM	71854AK	
ALUMINIUM "DARK"	71854AKN	

RACE-TECH STEEL CAP

	ECE	HOMOL.
ALUMINIUM	71854AO	
ALUMINIUM "DARK"	71854AON	



EC
COLLETTORI
CATALITICI OMOLOGATI
CATALYTIC HOMOLOGATED
COLLECTORS
71459KZ



COLLETTORI RACING
RACING COLLECTORS
71459MI



← **Fitment** - The continuous line means that it is necessary to fit all the components

← - - - - **Option for fitment** - The dotted line means that it is not needed to fit all the components



X-KONE CARBON CAP

	ECE HOMOL.
NICHROM	71854XKI
NICHROM "DARK"	71854XKN

RACE-TECH CARBON CAP

	ECE HOMOL.
TITANIUM	71854PK
CARBON FIBRE	71854MK
ALUMINIUM	71854AK
ALUMINIUM "DARK"	71854AKN

RACE-TECH STEEL CAP

	ECE HOMOL.
ALUMINIUM	71854AO
ALUMINIUM "DARK"	71854AON

PRO-RACE TITANIUM CAP

	RACING
TITANIUM	71206PR

PRO-RACE STEEL CAP

	RACING
NICHROM	71206PRI
NICHROM "DARK"	71206PRN

GP2 SILENCERS

	RACING
FULL TITANIUM	71032GP
NICHROM "DARK"	71032GPI

VEHICLE TYPE: **ER650H**
ER650K

VEHICLE TYPE: **EX650K**



EC
COLLETTORI CATALITICI OMOLOGATI
CATALYTIC HOMOLOGATED COLLECTORS
71659KZ



COLLETTORI RACING
RACING COLLECTORS
71659MI



dB-KILLER PER TERMINALI PRO-RACE
dB-KILLER FOR PRO-RACE SILENCERS
11012DB

dB-KILLER PER TERMINALE Gp2
dB-KILLER FOR GP2 SILENCERS
11009DB



← **Fitment** - The continuous line means that it is necessary to fit all the components

← - - - **Option for fitment** - The dotted line means that it is not needed to fit all the components



KAWASAKI

Z 750 '04/06

VEHICLE TYPE: **ZR750J J**

Z 750 S '05/06

VEHICLE TYPE: **ZR750J K**

RACE-TECH STEEL END CAP

	9	HOMOL.
ALUMINIUM		71706AK
ALUMINIUM "DARK"		71706AKN



PRO-RACE STEEL END CAP

	9	HOMOL.
TITANIUM		71637PR
NICHROM		71637PRI



RACCORDO PER COLLETTORI ORIGINALI PER TERMINALI RACE-TECH
LINK PIPE FOR ORIGINAL COLLECTORS FOR RACE-TECH SILENCERS
71279MI



RACCORDO PER COLLETTORI ORIGINALI PER TERMINALI PRO-RACE
LINK PIPE FOR ORIGINAL COLLECTORS FOR PRO-RACE SILENCERS
71347MI



KAWASAKI

Z 750 '07/14

VEHICLE TYPE: **ZR750L**

Z 750 R '11/14

VEHICLE TYPE: **ZR750N**

X-KONE CARBON END CAP

	9	HOMOL.
NICHROM		71723XKI



RACCORDO PER TERMINALE X-KONE
LINK PIPE FOR X-KONE SILENCER
71494MI *



COLLETTORI RACING
RACING COLLECTORS
71369MI



RACE-TECH CARBON END CAP

	9	HOMOL.
TITANIUM		71723PK
CARBON FIBRE		71723MK
ALUMINIUM		71723AK
ALUMINIUM "DARK"		71723AKN



RACCORDO PER TERMINALI RACE-TECH
LINK PIPE FOR RACE-TECH SILENCER
71368MI *



*** | RACCORDI MONTANO ANCHE SU COLLETTORI ORIGINALI |**
LINK PIPES FIT TO BOTH ARROW AND ORIGINAL COLLECTORS



Fitment - The continuous line means that it is necessary to fit all the components



Option for fitment - The dotted line means that it is not needed to fit all the components



KAWASAKI

Z 800 E '13/16 (72 kw)



VEHICLE TYPE: **ZR800C**

**X-KONE
CARBON END CAP**

	HOMOL.
NICHROM	71723XKI

**RACE-TECH
CARBON END CAP**

	HOMOL.
TITANIUM	71723PK
CARBON FIBRE	71723MK
ALUMINIUM	71723AK
ALUMINIUM "DARK"	71723AKN



*** IL RACCORDO MONTA ANCHE SU COLLETTORI ORIGINALI
LINK PIPE FITS TO BOTH ARROW
AND ORIGINAL COLLECTORS**

RACCORDO
LINK PIPE
71482MI *

COLLETTORI RACING
RACING COLLECTORS
71483MI



**N.B. - TUTTI I KIT MONTANO SOLO SU VERSIONE DEPOTENZIATA 72kW
NOTE - ALL PARTS FIT TO 72 kW VERSION ONLY**



KAWASAKI

Z 900 RS '17/20



VEHICLE TYPE: **ZR900C**

REBEL SILENCER

	ECE	HOMOL.
CARBON END CAP	74506RB *	
ALUMINIUM END CAP	74506RBA *	
ALUM.DARK END CAP	74506RBN *	



COLLETTORI RACING
RACING COLLECTORS
71685MI *



*** TUTTI I COMPONENTI SONO INTERCambiabili CON QUELLI ORIGINALI
ALL THE COMPONENTS ARE INTERCHANGEABLE WITH THE ORIGINAL ONES**



Fitment - The continuous line means that it is necessary to fit all the components



Option for fitment - The dotted line means that it is not needed to fit all the components



VEHICLE TYPE: **ZR900D**

VEHICLE TYPE: **ZR900H**

X-KONE CARBON CAP

	ECE	HOMOL.
NICHROM	71856XKI *	
NICHROM "DARK"	71856XKN *	

RACE-TECH CARBON CAP

	ECE	HOMOL.
TITANIUM	71856PK *	
CARBON FIBRE	71856MK *	
ALUMINIUM	71856AK *	
ALUMINIUM "DARK"	71856AKN *	

PRO-RACE TITANIUM CAP

	ECE	HOMOL.
TITANIUM	71856PR *	

PRO-RACE STEEL CAP

	ECE	HOMOL.
NICHROM	71856PRI *	
NICHROM "DARK"	71856PRN *	

GP2 SILENCERS

	ECE	HOMOL.
FULL TITANIUM	71531GP *	
NICHROM "DARK"	71531GPI *	



* **TUTTI I COMPONENTI SONO INTERCAMBIABILI CON QUELLI ORIGINALI**
ALL THE COMPONENTS ARE INTERCHANGEABLE WITH THE ORIGINAL ONES

COLLETTORI RACING
 RACING COLLECTORS
 71688MI *



COVER IN CARBONIO
 PER COLLETTORI ORIGINALI
 E TERMINALI ARROW
 CARBON FIBRE COVER
 FOR ORIGINAL COLLECTORS
 AND ARROW SILENCERS
 11004MI



← **Fitment** - The continuous line means that it is necessary to fit all the components

← - - - **Option for fitment** - The dotted line means that it is not needed to fit all the components



VEHICLE TYPE: ZR900B

X-KONE CARBON CAP

	ECE	HOMOL.
NICHROM	71856XKI *	
NICHROM "DARK"	71856XKN *	



RACE-TECH CARBON CAP

	ECE	HOMOL.
TITANIUM	71856PK *	
CARBON FIBRE	71856MK *	
ALUMINIUM	71856AK *	
ALUMINIUM "DARK"	71856AKN *	



PRO-RACE TITANIUM CAP

	ECE	HOMOL.
TITANIUM	71856PR *	



PRO-RACE STEEL CAP

	ECE	HOMOL.
NICHROM	71856PRI *	
NICHROM "DARK"	71856PRN *	



GP2 SILENCERS

	ECE	HOMOL.
FULL TITANIUM	71531GP *	
NICHROM "DARK"	71531GPI *	



* **TUTTI I COMPONENTI SONO INTERCAMBIABILI CON QUELLI ORIGINALI**
ALL THE COMPONENTS ARE INTERCHANGEABLE WITH THE ORIGINAL ONES

COLLETTORI RACING
 RACING COLLECTORS
 71661MI *



COVER IN CARBONIO
 PER COLLETTORI ORIGINALI
 E TERMINALI ARROW
 CARBON FIBRE COVER
 FOR ORIGINAL COLLECTORS
 AND ARROW SILENCERS
 11004MI



← **Fitment** - The continuous line means that it is necessary to fit all the components

← **Option for fitment** - The dotted line means that it is not needed to fit all the components



VEHICLE TYPE: **ZR900F**

X-KONE CARBON CAP

	ECE	HOMOL.
NICHROM	71912XKI *	
NICHROM "DARK"	71912XKN *	

THUNDER CARBON CAP

	ECE	HOMOL.
TITANIUM	71912PK *	
CARBON FIBRE	71912MK *	
ALUMINIUM	71912AK *	
ALUMINIUM "DARK"	71912AKN *	

PRO-RACE TITANIUM CAP

	ECE	HOMOL.
TITANIUM	71912PR *	

PRO-RACE STEEL CAP

	ECE	HOMOL.
NICHROM	71912PRI *	
NICHROM "DARK"	71912PRN *	

GP2 SILENCERS

	ECE	HOMOL.
FULL TITANIUM	71556GP *	
NICHROM "DARK"	71556GPI *	



*** TUTTI I COMPONENTI SONO INTERCAMBIABILI CON QUELLI ORIGINALI**
ALL THE COMPONENTS ARE INTERCHANGEABLE WITH THE ORIGINAL ONES

COLLETTORI RACING
 RACING COLLECTORS
 71727MI *

COVER IN CARBONIO
 PER COLLETTORI ORIGINALI
 E TERMINALI ARROW
 CARBON FIBRE COVER
 FOR ORIGINAL COLLECTORS
 AND ARROW SILENCERS
 11004MI



← **Fitment** - The continuous line means that it is necessary to fit all the components

← - - - **Option for fitment** - The dotted line means that it is not needed to fit all the components



KAWASAKI

Versys 1000 '12/16



VEHICLE TYPE: **LZT00A - LZT00B**

RACE-TECH CARBON END CAP

	HOMOL.
TITANIUM	71795PK
CARBON FIBRE	71795MK
ALUMINIUM	71795AK
ALUMINIUM "DARK"	71795AKN



RACCORDO PER COLLETTORI ORIGINALI
LINK PIPE FOR ORIGINAL COLLECTORS
71460MI



KAWASAKI

Versys 1000 '19/20



VEHICLE TYPE: **LZT00C**

X-KONE CARBON END CAP

	HOMOL.
NICHROM	71893XKI *



RACE-TECH CARBON END CAP

	HOMOL.
TITANIUM	71893PK *
ALUMINIUM	71893AK *
ALUMINIUM "DARK"	71893AKN *



COLLETTORI RACING
RACING COLLECTORS
71706MI *



* **TUTTI I COMPONENTI SONO INTERCambiabili CON QUELLI ORIGINALI**
ALL THE COMPONENTS ARE INTERCHANGEABLE WITH THE ORIGINAL ONES



Fitment - The continuous line means that it is necessary to fit all the components

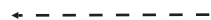

Option for fitment - The dotted line means that it is not needed to fit all the components



KAWASAKI**Ninja 1000 SX '20/22** EURO4 EURO5 EC ECE CARB

VEHICLE TYPE: ZXT02K

Ninja 1000 SX Tourer '21/22 EURO5 EC ECE CARB

VEHICLE TYPE: ZXT02K

INDY RACE
CARBON END CAP

	ECE	HOMOL.
TITANIUM		71914PK
ALUMINIUM		71914AK
ALUMINIUM "DARK"		71914AKN



* **TUTTI I COMPONENTI SONO INTERCAMBIABILI CON QUELLI ORIGINALI**
ALL THE COMPONENTS ARE INTERCHANGEABLE WITH THE ORIGINAL ONES

**KAWASAKI****Z 1000 '10/13** 9e5 2006/120CE CARB

VEHICLE TYPE: ZRT00B

THUNDER
STEEL END CAP

	9e5	HOMOL.
TITANIUM		71755PO
CARBON FIBRE		71755MO
ALUMINIUM		71755AO
ALUMINIUM "DARK"		71755AON



TERMINALI PER COLLETTORI ORIGINALI
SILENCERS FOR ORIGINAL COLLECTORS



← **Fitment** - The continuous line means that it is necessary to fit all the components

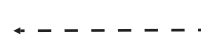

← **Option for fitment** - The dotted line means that it is not needed to fit all the components



KAWASAKI

Z 1000 '14/16



VEHICLE TYPE: **ZRT00F**

THUNDER STEEL END CAP

	HOMOL.
TITANIUM	71755PO *
CARBON FIBRE	71755MO *
ALUMINIUM	71755AO *
ALUMINIUM "DARK"	71755AON *

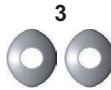

COLLETTORI RACING 4:2:2
RACING COLLECTORS 4:2:2
71662MI



* I TERMINALI MONTANO ANCHE SU COLLETTORI ORIGINALI
SILENCERS ALSO FIT TO ORIGINAL COLLECTORS

KAWASAKI

Z 1000 '17/20



VEHICLE TYPE: **ZRT00H**

PRO-RACE STEEL END CAP

	HOMOL.
NICHROM	71755PRI *#
NICHROM "DARK"	71755PRN *#

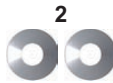

COLLETTORI RACING 4:2:2
RACING COLLECTORS 4:2:2
71662MI



THUNDER STEEL END CAP

	HOMOL.
TITANIUM	71755PO *
CARBON FIBRE	71755MO *
ALUMINIUM	71755AO *
ALUMINIUM "DARK"	71755AON *



TERMINALI OMOLOGATI SENZA DBKILLER
THESE SILENCERS ARE HOMOLOGATED
WITHOUT DB-KILLER



* I TERMINALI MONTANO ANCHE SU COLLETTORI ORIGINALI
SILENCERS ALSO FIT TO ORIGINAL COLLECTORS



← **Fitment** - The continuous line means that it is necessary to fit all the components

← **Option for fitment** - The dotted line means that it is not needed to fit all the components



109



VEHICLE TYPE: **ZXT00S**

**PRO-RACE
TITANIUM END CAP**

	ECE	HOMOL.
FULL TITANIUM	71841PR #	



§ TERMINALE OMOLOGATO CON dB-KILLER
SILENCER HOMOLOGATED WITH dB-KILLER

**RACE-TECH
CARBON END CAP**

	ECE	HOMOL.
TITANIUM	71841PK *	
ALUMINIUM	71841AK *	
ALUMINIUM "DARK"	71841AKN *	



***** TERMINALI OMOLOGATI SENZA dB-KILLER
SILENCERS HOMOLOGATED WITHOUT dB-KILLER

RACCORDO NON CATALITICO
NON CATALYZED LINK PIPE
71637MI



RACCORDO PER
CATALIZZATORE ORIGINALE
LINK PIPE FOR
ORIGINAL CATALYST
71636MI



RACCORDO CENTRALE
NON CATALITICO
IN SOSTITUZIONE DI QUELLO
CATALITICO ORIGINALE
NON CATALYZED
CENTRAL LINK PIPE
REPLACES CATALYZED
ORIGINAL LINK PIPE
71638MI



← **Fitment** - The continuous line means that it is necessary to fit all the components



← - - - - **Option for fitment** - The dotted line means that it is not needed to fit all the components



KIT INTERMEDIO / HALF SYSTEM *RACING*

PRO-RACE TITANIUM SILENCER
TITANIUM LINK PIPE $\varnothing 54/65$ mm.
71167HCP



KIT INTERMEDIO / HALF SYSTEM *RACING*

RACE-TECH TITANIUM SILENCER
WITH CARBON END CAP WITH dB-KILLER
TITANIUM LINK PIPE $\varnothing 54/60$ mm.
71155HK



KIT COMPLETO / FULL SYSTEM *COMPETITION "EVO"*

RACE-TECH TITANIUM SILENCER
WITH CARBON END CAP
TITANIUM LINK PIPE $\varnothing 45-70$
TITANIUM OR STEEL
COLLECTORS



COMPETITION "EVO"

	CARBON CAP
FULL TITANIUM	71199CKZ
STEEL COLLECT.	71198CKZ

KIT COMPLETO / FULL SYSTEM *COMPETITION*

RACE-TECH TITANIUM SILENCER
WITH CARBON END CAP AND dB-KILLER
TITANIUM LINK PIPE $\varnothing 45-65$
TITANIUM OR STEEL
COLLECTORS



COMPETITION

	CARBON CAP
FULL TITANIUM	71167CKZ
STEEL COLLECT.	71166CKZ



Fitment - The continuous line means that it is necessary to fit all the components



Option for fitment - The dotted line means that it is not needed to fit all the components



VEHICLE TYPE: **ZXT02L**

**PRO-RACE
TITANIUM END CAP**

	ECE	HOMOL.
FULL TITANIUM	71928PR *	

**PRO-RACE
STEEL END CAP**

	ECE	HOMOL.
NICHROM	71928PRI *	
NICHROM "DARK"	71928PRN *	

**INDY RACE
CARBON END CAP**

	ECE	HOMOL.
TITANIUM	71928PK *	
CARBON FIBRE	71928MK *	
ALUMINIUM	71928AK *	
ALUMINIUM "DARK"	71928AKN *	



RACCORDO CENTRALE
NON CATALITICO
IN SOSTITUZIONE DI QUELLO
CATALITICO ORIGINALE
NON CATALYZED
CENTRAL LINK PIPE
REPLACES CATALYZED
ORIGINAL LINK PIPE
71754MI *



* **TUTTI I COMPONENTI SONO INTERCAMBIABILI CON QUELLI ORIGINALI**
ALL THE COMPONENTS ARE INTERCHANGEABLE WITH THE ORIGINAL ONES

**KIT INTERMEDIO / HALF SYSTEM
RACING**

PRO-RACE TITANIUM SILENCER
WITH TITANIUM END CAP
CLASSIC END CAP (with dB-Killer) or
END CAP WITH MESH (no dB-Killer)
TITANIUM LINK PIPE



FONDELLO CON RETE
END CAP WITH MESH

**KIT INTERMEDIO / HALF SYSTEM
RACING**

INDY RACE TITANIUM SILENCER
WITH CARBON END CAP
WITH dB-KILLER
TITANIUM LINK PIPE



TERMINALE INDY RACE

	CARBON CAP
FULL TITANIUM	71215HK

TERMINALE PRO-RACE

	CLASSIC CAP
FULL TITANIUM	71215HCP

	CAP WITH MESH
FULL TITANIUM	71215HCPF



← **Fitment** - The continuous line means that it is necessary to fit all the components



← **Option for fitment** - The dotted line means that it is not needed to fit all the components



KTM

Duke 125 '11/16



VEHICLE TYPE: **KTM IS DUKE**

Duke 200 '11/14



VEHICLE TYPE: **KTM IS DUKE**

THUNDER CARBON END CAP

	HOMOL.
TITANIUM	51510PK
ALUMINIUM	51510AK
ALUMINIUM "DARK"	51510AKN

THUNDER STEEL END CAP

	HOMOL.
ALUMINIUM	51510AO
ALUMINIUM "DARK"	51510AON



RACCORDO CATALITICO OMOLOGATO
PER COLLETTORE ORIGINALE
CATALYTIC HOMOLOGATED LINK PIPE
FOR ORIGINAL COLLECTORS
51010KZ



RACCORDO RACING PER
COLLETTORE ORIGINALE
RACING LINK PIPE FOR
ORIGINAL COLLECTORS
51010MI



KTM

RC 125 '15/16



VEHICLE TYPE: **KTM IS RC**

THUNDER CARBON END CAP

	HOMOL.
TITANIUM	71813PK
ALUMINIUM	71813AK
ALUMINIUM "DARK"	71813AKN

THUNDER STEEL END CAP

	HOMOL.
ALUMINIUM	71813AO
ALUMINIUM "DARK"	71813AON



RACCORDO CATALITICO OMOLOGATO
PER COLLETTORE ORIGINALE
CATALYTIC HOMOLOGATED LINK PIPE
FOR ORIGINAL COLLECTORS
71619KZ



RACCORDO RACING PER
COLLETTORE ORIGINALE
RACING LINK PIPE FOR
ORIGINAL COLLECTORS
71619MI



← **Fitment** - The continuous line means that it is necessary to fit all the components



← **Option for fitment** - The dotted line means that it is not needed to fit all the components



VEHICLE TYPE: **KTM IS DUKE**

THUNDER CARBON END CAP

	ECE	HOMOL.
TITANIUM	71860PK	
ALUMINIUM	71860AK	
ALUMINIUM "DARK"	71860AKN	



THUNDER STEEL END CAP

	ECE	HOMOL.
ALUMINIUM	71860AO	
ALUMINIUM "DARK"	71860AON	



PRO-RACE STEEL END CAP

	ECE	HOMOL.
NICHROM	71866PRI *	
NICHROM "DARK"	71866PRN *	



GP2 SILENCERS

	ECE	HOMOL.
TITANIUM	71536GP *	
NICHROM "DARK"	71536GPI *	



RACCORDO PER
COLLETTORI ORIGINALI
LINK PIPE FOR
ORIGINAL COLLECTORS
71675MI



RACC. NON CATALITICO
IN SOSTITUZIONE DI QUELLO
CATALITICO ORIGINALE
NON CATALYZED LINK PIPE
REPLACES CATALYZED
ORIGINAL LINK PIPE
71668MI



* **TERMINALI PER COLLETTORI ORIGINALI
SILENCERS FOR ORIGINAL COLLECTORS**



← **Fitment** - The continuous line means that it is necessary to fit all the components

← - - - - **Option for fitment** - The dotted line means that it is not needed to fit all the components



VEHICLE TYPE: **KTM IS DUKE - KTM 125 DUKE**

PRO-RACE STEEL END CAP

	ECE	HOMOL.
NICHROM	71936PRI *	
NICHROM "DARK"	71936PRN *	



GP2 SILENCERS

	ECE	HOMOL.
TITANIUM	71936GP *	
NICHROM "DARK"	71936GPI *	



INDY RACE CARBON END CAP

	ECE	HOMOL.
TITANIUM	71936PK *	
ALUMINIUM	71936AK *	
ALUMINIUM "DARK"	71936AKN *	



! * I TERMINALI MONTANO ANCHE CON RACCORDO CENTRALE ORIGINALE
ALL SILENCERS ALSO FIT TO ORIGINAL CENTRAL LINK PIPE

! # IL COLLETTORE 71764MI MONTA ANCHE CON TERMINALE ORIGINALE
71764MI COLLECTOR ALSO FITS WITH ORIGINAL SILENCER



Fitment - The continuous line means that it is necessary to fit all the components



Option for fitment - The dotted line means that it is not needed to fit all the components



VEHICLE TYPE: **KTM IS RC**

THUNDER CARBON END CAP

	ECE	HOMOL.
TITANIUM	71860PK	
ALUMINIUM	71860AK	
ALUMINIUM "DARK"	71860AKN	



THUNDER STEEL END CAP

	ECE	HOMOL.
ALUMINIUM	71860AO	
ALUMINIUM "DARK"	71860AON	



PRO-RACE STEEL END CAP

	ECE	HOMOL.
NICHROM	71860PRI *	
NICHROM "DARK"	71860PRN *	



GP2 SILENCERS

	ECE	HOMOL.
TITANIUM	71534GP *	
NICHROM "DARK"	71534GPI *	



RACCORDO PER
COLLETTORI ORIGINALI
LINK PIPE FOR
ORIGINAL COLLECTORS
71667MI



RACC. NON CATALITICO
IN SOSTITUZIONE DI QUELLO
CATALITICO ORIGINALE
NON CATALYZED LINK PIPE
REPLACES CATALYZED
ORIGINAL LINK PIPE
71668MI



* **TERMINALI PER COLLETTORI ORIGINALI
SILENCERS FOR ORIGINAL COLLECTORS**



← **Fitment** - The continuous line means that it is necessary to fit all the components

← - - - - **Option for fitment** - The dotted line means that it is not needed to fit all the components



KTM**390 Adventure '20/21** EURO4 EURO5 EC ECE CARBVEHICLE TYPE: **KTM IS ADVENTURE var. A****INDY RACE
CARBON END CAP**

	ECE	HOMOL.
TITANIUM		72627PK
ALUMINIUM		72627AK
ALUMINIUM "DARK"		72627AKN

**GP2 SILENCERS**

	ECE	HOMOL.
TITANIUM		72627GP
NICHROM "DARK"		72627GPI

**PRO-RACE
STEEL END CAP**

	ECE	HOMOL.
NICHROM		712627PRI
NICHROM "DARK"		712627PRN

**TERMINALI PER COLLETTORI ORIGINALI
SILENCERS FOR ORIGINAL COLLECTORS****KTM****Duke 390 '13/16** 9e5 2009/120,CEVEHICLE TYPE: **KTM IS DUKE****THUNDER
CARBON END CAP**

	9	HOMOL.
TITANIUM		71813PK
ALUMINIUM		71813AK
ALUMINIUM "DARK"		71813AKN

**THUNDER
STEEL END CAP**

	9	HOMOL.
ALUMINIUM		71813AO
ALUMINIUM "DARK"		71813AON



5
RACCORDO CATALITICO OMOLOGATO
PER COLLETTORE ORIGINALE
CATALYTIC HOMOLOGATED LINK PIPE
FOR ORIGINAL COLLECTORS
71600KZ



RACCORDO RACING PER
COLLETTORE ORIGINALE
RACING LINK PIPE FOR
ORIGINAL COLLECTORS
71600MI



← **Fitment** - The continuous line means that it is necessary to fit all the components

← - - - **Option for fitment** - The dotted line means that it is not needed to fit all the components



VEHICLE TYPE: **KTM IS A**

THUNDER CARBON END CAP

	ECE	HOMOL.
TITANIUM	71860PK	
ALUMINIUM	71860AK	
ALUMINIUM "DARK"	71860AKN	



THUNDER STEEL END CAP

	ECE	HOMOL.
ALUMINIUM	71860AO	
ALUMINIUM "DARK"	71860AON	



PRO-RACE STEEL END CAP

	ECE	HOMOL.
NICHROM	71866PRI *	
NICHROM "DARK"	71866PRN *	



GP2 SILENCERS

	ECE	HOMOL.
TITANIUM	71536GP *	
NICHROM "DARK"	71536GPI *	



RACCORDO PER
COLLETTORI ORIGINALI
LINK PIPE FOR
ORIGINAL COLLECTORS
71675MI



RACC. NON CATALITICO
IN SOSTITUZIONE DI QUELLO
CATALITICO ORIGINALE
NON CATALYZED LINK PIPE
REPLACES CATALYZED
ORIGINAL LINK PIPE
71668MI



* **TERMINALI PER COLLETTORI ORIGINALI
SILENCERS FOR ORIGINAL COLLECTORS**



← **Fitment** - The continuous line means that it is necessary to fit all the components

← - - - - **Option for fitment** - The dotted line means that it is not needed to fit all the components



KTM

Duke 390 '21

EURO5

EC ECE

CARB

PRO-RACE STEEL END CAP

	ECE	HOMOL.
NICHROM	71936PRI *	
NICHROM "DARK"	71936PRN *	

GP2 SILENCERS

	ECE	HOMOL.
TITANIUM	71936GP *	
NICHROM "DARK"	71936GPI *	

INDY RACE CARBON CAP

	ECE	HOMOL.
TITANIUM	71936PK *	
ALUMINIUM	71936AK *	
ALUMINIUM "DARK"	71936AKN *	

VEHICLE TYPE: KTM IS DUKE

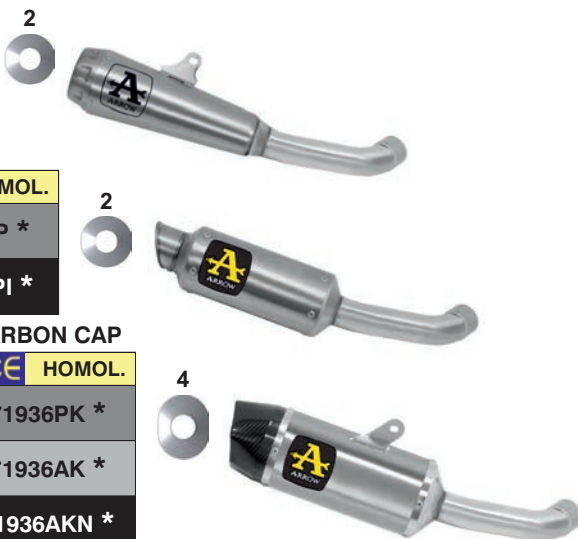

COLLETTORE RACING
RACING COLLECTOR
71765MI *



* **TUTTI I COMPONENTI MONTANO CON RACCORDO CENTRALE ORIGINALE**
ALL THE COMPONENTS FIT TO ORIGINAL CENTRAL LINK PIPE



KTM

RC 390 '15/16

9e5
2006/120/CE

THUNDER CARBON END CAP

	9	HOMOL.
TITANIUM	71813PK	
ALUMINIUM	71813AK	
ALUMINIUM "DARK"	71813AKN	

THUNDER STEEL END CAP

	9	HOMOL.
ALUMINIUM	71813AO	
ALUMINIUM "DARK"	71813AON	

VEHICLE TYPE: KTM IS RC

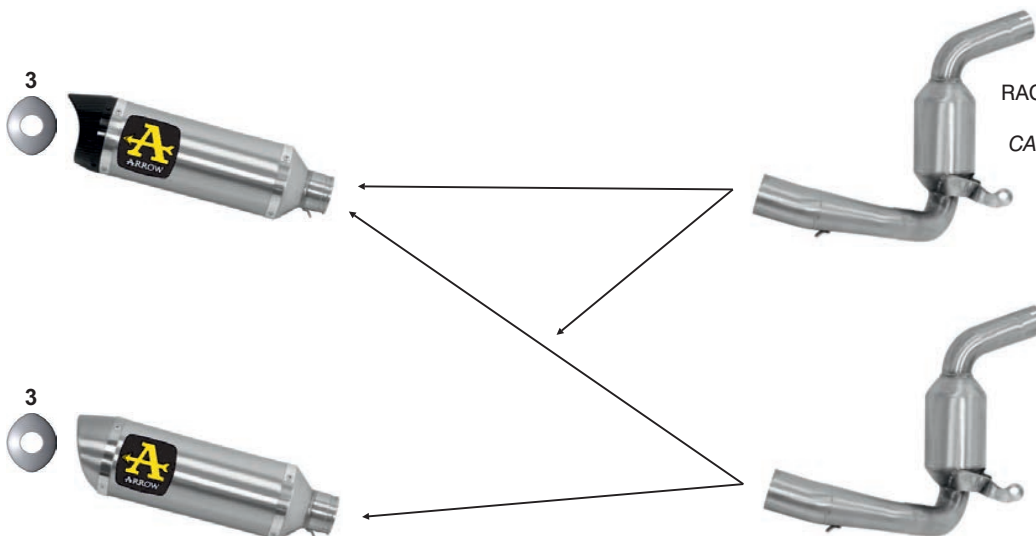

5

RACCORDO CATALITICO OMOLOGATO
PER COLLETTORE ORIGINALE
CATALYTIC HOMOLOGATED LINK PIPE
FOR ORIGINAL COLLECTORS
71619KZ

RACCORDO RACING PER
COLLETTORE ORIGINALE
RACING LINK PIPE FOR
ORIGINAL COLLECTORS
71619MI



Fitment - The continuous line means that it is necessary to fit all the components



Option for fitment - The dotted line means that it is not needed to fit all the components



119



VEHICLE TYPE: IS RC

THUNDER CARBON CAP

	ECE	HOMOL.
TITANIUM		71860PK
ALUMINIUM		71860AK
ALUMINIUM "DARK"		71860AKN

THUNDER STEEL CAP

	ECE	HOMOL.
ALUMINIUM		71860AO
ALUMINIUM "DARK"		71860AON

PRO-RACE STEEL CAP

	ECE	HOMOL.
NICHROM		71860PRI *
NICHROM "DARK"		71860PRN *

PRO-RACE TITANIUM CAP

	RACING
TITANIUM	71159PR *

PRO-RACE STEEL CAP

	RACING
NICHROM	71159PRI *
NICHROM "DARK"	71159PRN *



RACCORDO PER COLLETTORI ORIGINALI
LINK PIPE FOR ORIGINAL COLLECTORS
71667MI



RACC. NON CATALITICO
IN SOSTITUZIONE DI QUELLO
CATALITICO ORIGINALE
NON CATALYZED LINK PIPE
REPLACES CATALYZED
ORIGINAL LINK PIPE
71668MI



GP2 SILENCERS

	ECE	HOMOL.
FULL TITANIUM		71534GP *
NICHROM "DARK"		71534GPI *



* TERMINALI PER COLLETTORI ORIGINALI
SILENCERS FOR ORIGINAL COLLECTORS



RACCORDO CENTRALE
NON CATALITICO PER
COLLETTORE ORIGINALE
NON CATALYZED
CENTRAL LINK PIPE FOR
ORIGINAL COLLECTOR
71737MI



PREVEDE L'ELIMINAZIONE DELLA PEDANA PASSEGGERO
PROVIDES REMOVAL OF PASSENGERS FOOT-PEG



← **Fitment** - The continuous line means that it is necessary to fit all the components



← **Option for fitment** - The dotted line means that it is not needed to fit all the components



KTM**690 SM '06/12** VEHICLE TYPE: **LCA****RACE-TECH
CARBON END CAP**

	 HOMOL.
TITANIUM	72619PK *
ALUMINIUM	72619AK *
ALUMINIUM "DARK"	72619AKN *



* **TERMINALI PER COLLETTORI ORIGINALI**
SILENCERS FOR ORIGINAL COLLECTORS

KTM**690 Enduro - Motard - SMC - SMC R '09/16** VEHICLE TYPE: **KTM 690 LC4****RACE-TECH CARBON CAP**

	 HOMOL.
TITANIUM	72618PK
ALUMINIUM	72618AK
ALUMINIUM "DARK"	72618AKN

RACE-TECH STEEL CAP

	 HOMOL.
TITANIUM	72618PO
ALUMINIUM	72618AO

RACCORDO CATALITICO OMOLOGATO
CATALYTIC HOMOLOGATED LINK PIPE
72119KZ *

COLLETTORE RACING
RACING COLLECTOR
72120PD

RACCORDO RACING
RACING LINK PIPE
72119PD *

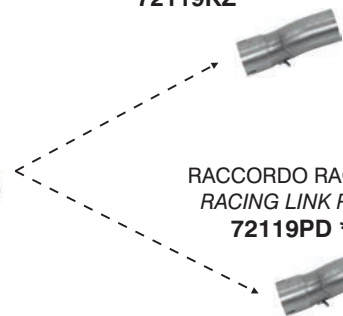

* **I RACCORDI 72119PD e 72119KZ MONTANO ANCHE SU COLLETTORE ORIGINALE**
72119PD and 72119KZ LINK PIPES FIT ALSO TO ORIGINAL COLLECTOR



Fitment - The continuous line means that it is necessary to fit all the components



Option for fitment - The dotted line means that it is not needed to fit all the components

**121**

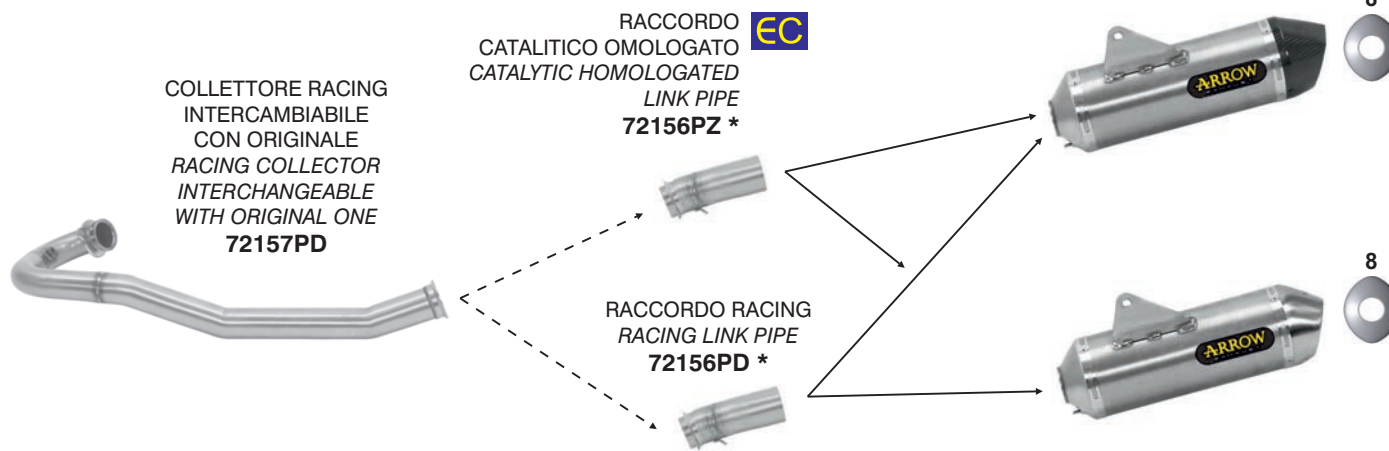
KTM**690 Enduro R - SMC R '19/21** EURO4 EURO5 EC ECEVEHICLE TYPE: **KTM 690 LC4****RACE-TECH CARBON CAP**

	ECE	HOMOL.
TITANIUM		72624PK
ALUMINIUM		72624AK
ALUMINIUM "DARK"		72624AKN

RACE-TECH STEEL CAP

	ECE	HOMOL.
TITANIUM		72624PO
ALUMINIUM		72624AO
ALUMINIUM "DARK"		72624AON

DB-KILLER SPARK ARRESTER 12005PD



* I RACCORDI 72156PD e 72156PZ MONTANO ANCHE SU COLLETTORE ORIGINALE
72156PD and 72156PZ LINK PIPES FIT ALSO TO ORIGINAL COLLECTOR

KTM**790 Adventure / Adventure R '19/20** EURO4 EC ECE CARBVEHICLE TYPE: **KTM 790 ADVENTURE****890 Adventure '21** EURO5 EC ECE CARBVEHICLE TYPE: **KTM 890 R2 ADVENTURE****RACE-TECH CARBON END CAP**

	ECE	HOMOL.
TITANIUM		71904PK *
ALUMINIUM		71904AK *
ALUMINIUM "DARK"		71904AKN *



RACCORDO CENTRALE NON CATALITICO NON CATALYTIC CENTRAL LINK PIPE 71719MI *



* TUTTI I COMPONENTI SONO INTERCAMBIABILI CON QUELLI ORIGINALI
ALL THE COMPONENTS ARE INTERCHANGEABLE WITH THE ORIGINAL ONES



← **Fitment** - The continuous line means that it is necessary to fit all the components

← - - - - **Option for fitment** - The dotted line means that it is not needed to fit all the components

**122**

KTM

790 Duke '18/20

EURO4

EC ECE

CARB

890 Duke R '20

EURO5

EC ECE

CARB

VEHICLE TYPE: **KTM 790 DUKE**

VEHICLE TYPE: **790 DUKES**

RACE-TECH CARBON CAP

	ECE	HOMOL.
TITANIUM	71890PK *	
ALUMINIUM	71890AK *	
ALUMINIUM "DARK"	71890AKN *	

PRO-RACE TITANIUM CAP

	ECE	HOMOL.
TITANIUM	71890PR *	

PRO-RACE STEEL CAP

	ECE	HOMOL.
NICHROM	71890PRI *	
NICHROM "DARK"	71890PRN *	

GP2 SILENCERS

	ECE	HOMOL.
TITANIUM	71549GP *	
NICHROM "DARK"	71549GPI *	

SILENCERS KIT PRO-RACE (Rh+Lh)

	RACING
TITANIUM	71216PR #
NICHROM	71216PRI #
NICHROM "DARK"	71216PRN #

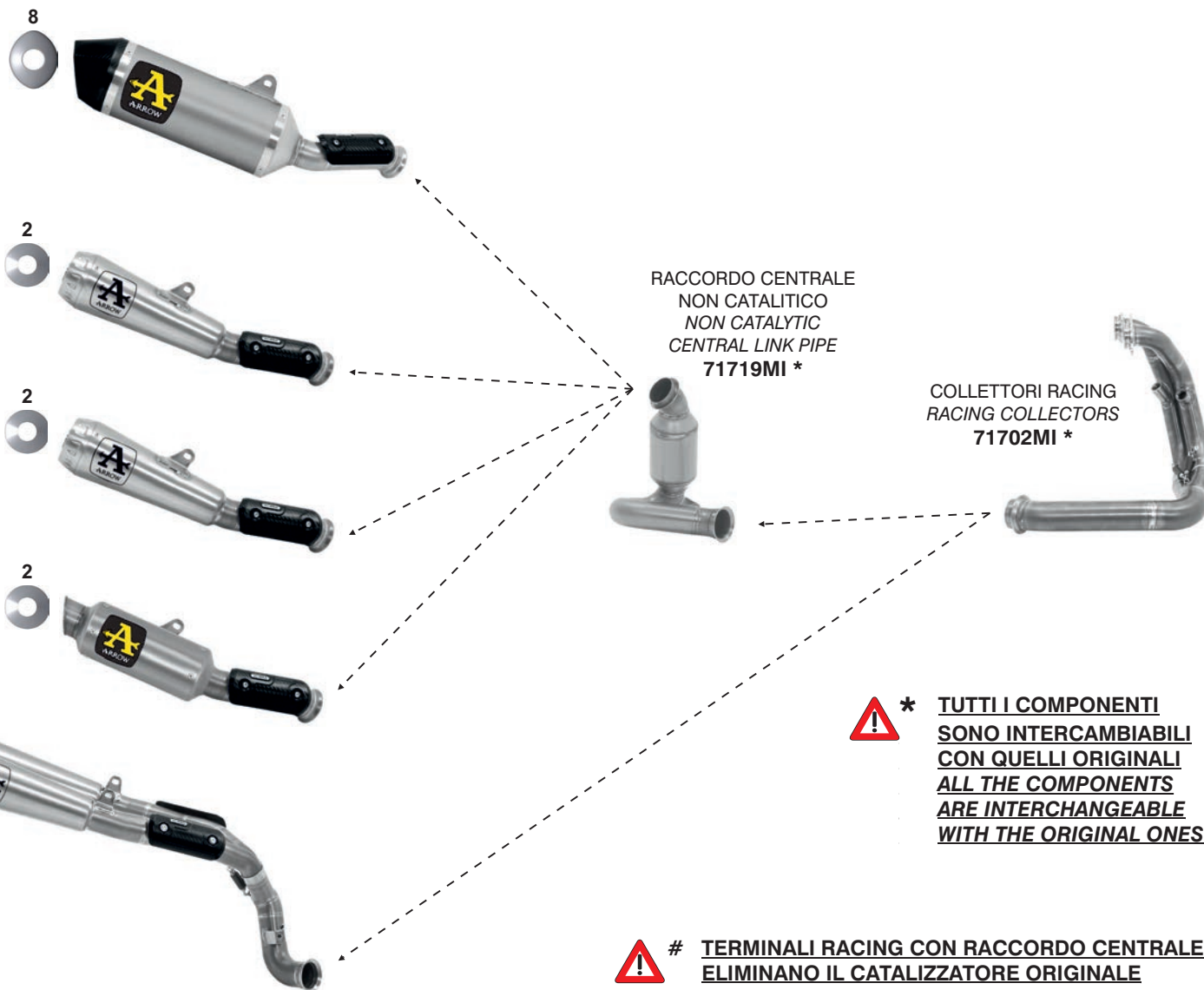

*** TUTTI I COMPONENTI SONO INTERCAMBIABILI CON QUELLI ORIGINALI**
ALL THE COMPONENTS ARE INTERCHANGEABLE WITH THE ORIGINAL ONES

TERMINALI RACING CON RACCORDO CENTRALE ELIMINANO IL CATALIZZATORE ORIGINALE
RACING SILENCERS WITH CENTRAL LINK PIPE REMOVE THE ORIGINAL CATALYTIC CONVERTER



← **Fitment** - The continuous line means that it is necessary to fit all the components

← - - - **Option for fitment** - The dotted line means that it is not needed to fit all the components



KTM**950 SM '06/09****990 SM - SMR '08/13**VEHICLE TYPE: **LC8 SM**VEHICLE TYPE: **LC8****RACE-TECH
CARBON END CAP**

	HOMOL.
TITANIUM	72613PK
ALUMINIUM	72613AK

RACCORDO CENTRALE
CENTRAL LINK PIPE
71414MI *COLLETTORI RACING
RACING COLLECTORS
71415MI # 71414KZ *
RACCORDO CENTRALE
CATALITICO OMOLOGATO
HOMOLOGATED CATALYZED
CENTRAL LINK PIPE* **MONTANO ANCHE SU COLLETTORI ORIGINALI**
71414KZ LINK PIPE FITS ALSO TO ORIGINAL COLLECTORS# **COLLETTORI INTERCAMBIABILI CON QUELLI ORIGINALI. MONTANO ANCHE SU MODELLO «SMT»**
COLLECTORS ARE INTERCHANGEABLE WITH ORIGINAL ONES. THEY ALSO FIT TO «SMT» MODEL**KTM****990 Adventure '06/14****990 SMT '09/13**VEHICLE TYPE: **LC8**VEHICLE TYPE: **LC8 SM****RACE-TECH
CARBON END CAP**

	HOMOL.
TITANIUM	71763PK
ALUMINIUM	71763AK
ALUMINIUM "DARK"	71763AKN

 CATALIZZATORI
OMOLOGATI
HOMOLOGATED
CATALYSTS
11006KZ**TERMINALI PER COLLETTORI ORIGINALI**
SILENCERS FOR ORIGINAL COLLECTORS**ATTENZIONE · L'OMOLOGAZIONE È VALIDA SOLO CON LA PRESENZA DEL CATALIZZATORE**
ATTENTION · THE HOMOLOGATION IS VALID ONLY WITH THE CATALYST INCLUDED IN THE SYSTEM← **Fitment** - The continuous line means that it is necessary to fit all the components← **Option for fitment** - The dotted line means that it is not needed to fit all the components**124**

KTM**1050 Adventure '15/16****1190 Adventure '13/16**VEHICLE TYPE: **KTM ADVENTURE**VEHICLE TYPE: **KTM ADVENTURE**MAXI RACE-TECH
CARBON END CAP

	HOMOL.
TITANIUM	71809PK *
ALUMINIUM	71809AK *
ALUMINIUM "DARK"	71809AKN *

**1290 Super Adventure '15/16**VEHICLE TYPE: **KTM ADVENTURE**COLLETTORI
CATALITICI OMOLOGATI
CATALYTIC HOMOLOGATED
COLLECTORS
71495KZCOLLETTORI RACING
RACING COLLECTORS
71495MI* I TERMINALI MONTANO ANCHE SU COLLETTORI ORIGINALI
SILENCERS ALSO FIT TO ORIGINAL COLLECTOR**KTM****1090 Adventure '17/20****1290 Super Adventure '17/20**VEHICLE TYPE: **KTM ADVENTURE A1**VEHICLE TYPE: **KTM ADVENTURE B1 - C1 - D1**MAXI RACE-TECH
CARBON END CAP

	HOMOL.
TITANIUM	71809PK *
ALUMINIUM	71809AK *
ALUMINIUM "DARK"	71809AKN *

COLLETTORI RACING
RACING COLLECTORS
71495MI ** TUTTI I COMPONENTI SONO INTERCambiabili CON QUELLI ORIGINALI
ALL THE COMPONENTS ARE INTERCHANGEABLE WITH THE ORIGINAL ONES← **Fitment** - The continuous line means that it is necessary to fit all the components← **Option for fitment** - The dotted line means that it is not needed to fit all the components**125**

KTM**1290 SuperAdventure S / R '21**

EURO5

ECE

CARB

VEHICLE TYPE: **KTM V2 ADVENTURE****SONORA
CARBON END CAP**

	HOMOL.
TITANIUM	72501SK *
TITANIUM "DARK"	72501SKN *

COLLETTORI RACING IN TITANIO
TITANIUM RACING COLLECTORS
72181PD *COLLETTORI RACING IN ACCIAIO
STEEL RACING COLLECTORS
72180PD *

* **TUTTI I COMPONENTI SONO INTERCAMBIABILI CON QUELLI ORIGINALI**
ALL THE COMPONENTS ARE INTERCHANGEABLE WITH THE ORIGINAL ONES

KTM**1290 SuperDuke R '14/16**

ECE

CARB

VEHICLE TYPE: **KTM SUPERDUKE****X-KONE
CARBON END CAP**

	HOMOL.
NICHROM	71820XK1 #

**RACE-TECH
CARBON END CAP**

	HOMOL.
TITANIUM	71820PK #
ALUMINIUM	71820AK #
ALUMINIUM "DARK"	71820AKN #

RACCORDO CATALITICO OMOLOGATO
CATALYTIC HOMOLOGATED LINK PIPE
71613KZ *RACCORDO NON CATALITICO
NON CATALYZED LINK PIPE
71613MI *

I TERMINALI MONTANO ANCHE SU RACCORDO CATALITICO ORIGINALE
SILENCERS ALSO FIT TO ORIGINAL CATALYZED LINK PIPE



* **I RACCORDI MONTANO ANCHE CON TERMINALI ORIGINALI**
LINK PIPES ALSO FIT TO ORIGINAL SILENCERS



← **Fitment** - The continuous line means that it is necessary to fit all the components



← **Option for fitment** - The dotted line means that it is not needed to fit all the components

**126**

KTM

1290 SuperDuke R '17/19

EURO4

EC
ECE

CARB

VEHICLE TYPE: **KTM A SUPERDUKE B1**

X-KONE CARBON END CAP

	ECE	HOMOL.
NICHROM	71820XKI #	

RACE-TECH CARBON END CAP

	ECE	HOMOL.
TITANIUM	71820PK #	
ALUMINIUM	71820AK #	
ALUMINIUM "DARK"	71820AKN #	

PRO-RACE TITANIUM END CAP

	ECE	HOMOL.
TITANIO	71820PR #	

PRO-RACE STEEL END CAP

	ECE	HOMOL.
NICHROM	71820PRI #	
NICHROM "DARK"	71820PRN #	

GP2 SILENCERS

	ECE	HOMOL.
FULL TITANIUM	71537GP #	
NICHROM "DARK"	71537GPI #	



EC
RACCORDO CATALITICO OMOLOGATO
CATALYTIC HOMOLOGATED LINK PIPE
71676KZ *

N.B.  INSTALLANDO UNO DEI RACCORDI ARROW È NECESSARIO DISATTIVARE IL CONTROLLO VALVOLA ALLO SCARICO. PER SAPERE COME FARE LEGGERE LA NOTA INFORMATIVA SUL NOSTRO SITO. WHEN INSTALLING ANY OF THE ARROW LINK PIPES IT IS NEEDED TO DE-ACTIVATE THE VALVE FUNCTION. ALL INFORMATION ARE AVAILABLE IN THE TECHNICAL NOTE IN ARROW WEBSITE

RACCORDO NON CATALITICO
NON CATALYZED LINK PIPE
71613MI *



 # I TERMINALI MONTANO ANCHE SU RACCORDO CATALITICO ORIGINALE
SILENCERS ALSO FIT TO ORIGINAL CATALYZED LINK PIPE

 * I RACCORDI MONTANO ANCHE CON TERMINALI ORIGINALI
LINK PIPES ALSO FIT TO ORIGINAL SILENCERS



Fitment - The continuous line means that it is necessary to fit all the components



Option for fitment - The dotted line means that it is not needed to fit all the components



127



VEHICLE TYPE: 1290 SUPERDUKE R - KTM SUPERDUKE A



X-KONE
CARBON END CAP

	ECE	HOMOL.
TITANIUM		71916XKR
NICHROM "DARK"		71916XKNR



PRO-RACE
STEEL END CAP

	ECE	HOMOL.
NICHROM		71916PRIR
NICHROM "DARK"		71916PRNR



PRO-RACE
TITANIUM END CAP

	ECE	HOMOL.
TITANIUM		71916PRR



TERMINALI PER COLLETTORI ORIGINALI
SILENCERS FOR ORIGINAL COLLECTORS



← **Fitment** - The continuous line means that it is necessary to fit all the components



← - - - - **Option for fitment** - The dotted line means that it is not needed to fit all the components



KTM

1290 SuperDuke GT '17/18

EURO4

EC
ECE

CARB

VEHICLE TYPE: **KTM A SUPERDUKE A1**

X-KONE CARBON END CAP

	ECE	HOMOL.
NICHROM	71820XKI #	

RACE-TECH CARBON END CAP

	ECE	HOMOL.
TITANIUM	71820PK #	
ALUMINIUM	71820AK #	
ALUMINIUM "DARK"	71820AKN #	

PRO-RACE TITANIUM END CAP

	ECE	HOMOL.
TITANIO	71820PR #	

PRO-RACE STEEL END CAP

	ECE	HOMOL.
NICHROM	71820PRI #	
NICHROM "DARK"	71820PRN #	

GP2 SILENCERS

	ECE	HOMOL.
FULL TITANIUM	71537GP #	
NICHROM "DARK"	71537GPI #	



EC
RACCORDO CATALITICO OMOLOGATO
CATALYTIC HOMOLOGATED LINK PIPE
71692KZ *



N.B. INSTALLANDO UNO DEI RACCORDI ARROW È NECESSARIO DISATTIVARE IL CONTROLLO VALVOLA ALLO SCARICO. PER SAPERE COME FARE LEGGERE LA NOTA INFORMATIVA SUL NOSTRO SITO. WHEN INSTALLING ANY OF THE ARROW LINK PIPES IT IS NEEDED TO DE-ACTIVATE THE VALVE FUNCTION. ALL INFORMATION ARE AVAILABLE IN THE TECHNICAL NOTE IN ARROW WEBSITE



RACCORDO NON CATALITICO
NON CATALYZED LINK PIPE
71692MI *



I TERMINALI MONTANO ANCHE SU RACCORDO CATALITICO ORIGINALE
SILENCERS ALSO FIT TO ORIGINAL CATALYZED LINK PIPE

* I RACCORDI MONTANO ANCHE CON TERMINALI ORIGINALI
LINK PIPES ALSO FIT TO ORIGINAL SILENCERS



← **Fitment** - The continuous line means that it is necessary to fit all the components

← **Option for fitment** - The dotted line means that it is not needed to fit all the components



129



VEHICLE TYPE: U03

3



ECE THUNDER ALUMINIUM «DARK»
OMOLOGATO / HOMOLOGATED
72529AON *

COLLETTORE RACING
RACING COLLECTOR
72138PD *



* **TUTTI I COMPONENTI SONO INTERCambiabili CON QUELLI ORIGINALI**
ALL THE COMPONENTS ARE INTERCHANGEABLE WITH THE ORIGINAL ONES

VEHICLE TYPE: V2

URBAN
BLACK STEEL CAP
ALUMINIUM "DARK"
HOMOL.
53511ANN

8



5
COLLETTORE CATALITICO OMOLOGATO
CATALYTIC HOMOLOGATED COLLECTOR
53058KZ



COLLETTORE RACING
RACING COLLECTOR
53058MI



← **Fitment** - The continuous line means that it is necessary to fit all the components

← - - - - **Option for fitment** - The dotted line means that it is not needed to fit all the components



KYMCO

K-XCT 125i '11/16



VEHICLE TYPE: **D8**

URBAN
BLACK STEEL CAP

	HOMOL.
ALUMINIUM "DARK"	53512ANN



COLLETTORE CATALITICO OMOLOGATO
CATALYTIC HOMOLOGATED COLLECTOR
53063KZ



COLLETTORE RACING
RACING COLLECTORS
53063MI



KYMCO

K-XCT 300i '13/17



VEHICLE TYPE: **D8**

URBAN
BLACK STEEL CAP

	HOMOL.
ALUMINIUM "DARK"	53516ANN



COLLETTORE CATALITICO OMOLOGATO
CATALYTIC HOMOLOGATED COLLECTOR
53063KZ



COLLETTORE RACING
RACING COLLECTORS
53063MI



Fitment - The continuous line means that it is necessary to fit all the components



Option for fitment - The dotted line means that it is not needed to fit all the components



VEHICLE TYPE: **KS60A**

**URBAN
BLACK STEEL CAP**

	HOMOL.
ALUMINIUM "DARK"	53531ANN





**RACCORDO CATALITICO OMOLOGATO
 PER COLLETTORE ORIGINALE
 CATALYTIC HOMOLOGATED LINK PIPE
 FOR ORIGINAL COLLECTOR**
53078KZ



**RACCORDO RACING
 PER COLLETTORE ORIGINALE
 RACING LINK PIPE
 FOR ORIGINAL COLLECTOR**
53078MI

VEHICLE TYPE: **V2**

**URBAN
BLACK STEEL CAP**

	HOMOL.
ALUMINIUM "DARK"	53506ANN



**COLLETTORE CATALITICO OMOLOGATO
 CATALYTIC HOMOLOGATED COLLECTOR**
53053KZ



**COLLETTORE RACING
 RACING COLLECTOR**
53053MI



← **Fitment** - The continuous line means that it is necessary to fit all the components

← - - - - **Option for fitment** - The dotted line means that it is not needed to fit all the components



KYMCO

Downtown 350 '15/16 

VEHICLE TYPE: **V2**

URBAN
BLACK STEEL CAP

	HOMOL.
ALUMINIUM "DARK"	53509ANN



 CATALIZZATORE OMOLOGATO
 HOMOLOGATED CATALYST
11008KZ



TERMINALE PER COLLETTORE ORIGINALE
SILENCER FOR ORIGINAL COLLECTOR

ATTENZIONE · L'OMOLOGAZIONE È VALIDA SOLO CON LA PRESENZA DEL CATALIZZATORE
ATTENTION · THE HOMOLOGATION IS VALID ONLY WITH THE CATALYST INCLUDED IN THE SYSTEM

KYMCO

Downtown 350i '16/19  

VEHICLE TYPE: **C7**

URBAN
BLACK STEEL CAP

	HOMOL.
ALUMINIUM "DARK"	53533ANN



 RACCORDO CATALITICO OMOLOGATO
 PER COLLETTORE ORIGINALE
 CATALYTIC HOMOLOGATED LINK PIPE
 FOR ORIGINAL COLLECTOR
53080KZ



RACCORDO RACING
 PER COLLETTORE ORIGINALE
 RACING LINK PIPE
 FOR ORIGINAL COLLECTOR
53080MI



← **Fitment** - The continuous line means that it is necessary to fit all the components

← - - - **Option for fitment** - The dotted line means that it is not needed to fit all the components



KYMCO**Xciting 400i '17/18** EURO4 VEHICLE TYPE: **D6**URBAN
BLACK STEEL CAP

	HOMOL.
ALUMINIUM "DARK"	73516ANN

RACE-TECH
CARBON END CAP

	HOMOL.
ALUMINIUM "DARK"	73516AKN



RACCORDO CATALITICO OMOLOGATO
PER COLLETTORE ORIGINALE
CATALYTIC HOMOLOGATED LINK PIPE
FOR ORIGINAL COLLECTOR
73017KZ



RACCORDO RACING
PER COLLETTORE ORIGINALE
RACING LINK PIPE
FOR ORIGINAL COLLECTOR
73017MI

**KYMCO****Xciting 400i S '19/20** EURO4 VEHICLE TYPE: **D6 20**URBAN
BLACK STEEL CAP

	HOMOL.
ALUMINIUM "DARK"	73517ANN

RACE-TECH
CARBON END CAP

	HOMOL.
TITANIUM	73517PK
ALUMINIUM	73517AK
ALUMINIUM "DARK"	73517AKN



COLLETTORE
CATALITICO OMOLOGATO
CATALYTIC HOMOLOGATED
COLLECTOR
73018KZ



COLLETTORE RACING
RACING COLLECTOR
73018MI



Fitment - The continuous line means that it is necessary to fit all the components



Option for fitment - The dotted line means that it is not needed to fit all the components

**134**

VEHICLE TYPE: **E1**

EC

RACCORDO CATALITICO OMOLOGATO
CATALYTIC HOMOLOGATED LINK PIPE
73014KZ *

RACCORDO RACING
RACING LINK PIPE
73014MI *

COLLETTORI RACING
INTERCAMBIABILI CON QUELLI ORIGINALI
RACING COLLECTORS
INTERCHANGEABLE WITH ORIGINAL ONES
73015MI



URBAN
BLACK STEEL CAP

ECE HOMOL.

ALUMINIUM "DARK" **73513ANN**



*** I RACCORDI 73014KZ e 73014MI MONTANO ANCHE SU COLLETTORI ORIGINALI
73014KZ and 73014MI LINK PIPES ALSO FIT TO ORIGINAL COLLECTORS**



RACE-TECH
CARBON END CAP

ECE HOMOL.

TITANIUM	73515PK
ALUMINIUM	73515AK
ALUMINIUM "DARK"	73515AKN

EC

COLLETTORI CATALITICI OMOLOGATI
CATALYTIC HOMOLOGATED COLLECTORS
73016KZ

COLLETTORI RACING
RACING COLLECTORS
73016MI



← **Fitment** - The continuous line means that it is necessary to fit all the components

← - - - **Option for fitment** - The dotted line means that it is not needed to fit all the components



KYMCO

AK 550 '21 EURO5 EC ECE

VEHICLE TYPE: **E1-A3**

URBAN
CARBON END CAP

	ECE	HOMOL.
ALUMINIUM "DARK"	73520AKN *	



URBAN
BLACK STEEL CAP

	ECE	HOMOL.
ALUMINIUM "DARK"	73520ANN *	



EC

CATALIZZATORE OMOLOGATO
HOMOLOGATED CATALYST
11053KZ



COLLETTORI RACING
INTERCambiabili CON QUELLI ORIGINALI
RACING COLLECTORS
INTERCHANGEABLE WITH ORIGINAL ONES
73021MI *



* **TUTTI I COMPONENTI SONO INTERCambiabili CON QUELLI ORIGINALI**
ALL THE COMPONENTS ARE INTERCHANGEABLE WITH THE ORIGINAL ONES



ATTENZIONE · L'OMOLOGAZIONE È VALIDA SOLO CON LA PRESENZA DEL CATALIZZATORE
ATTENTION · THE HOMOLOGATION IS VALID ONLY WITH THE CATALYST INCLUDED IN THE SYSTEM



MALAGUTI

XTM - XSM 125 '19/20 EURO4 EC ECE

VEHICLE TYPE: **ET1**

THUNDER CARBON CAP

	ECE	HOMOL.
TITANIUM	52509PK *	
ALUMINIUM	52509AK *	
ALUMINIUM "DARK"	52509AKN *	



THUNDER STEEL CAP

	ECE	HOMOL.
ALUMINIUM	52509AO *	
ALUMINIUM "DARK"	52509AON *	



EC

COLLETTORE CATALITICO OMOLOGATO
CATALYTIC HOMOLOGATED COLLECTOR
52001PZ *



COLLETTORE RACING
RACING COLLECTOR
52001PD *



* **TUTTI I COMPONENTI SONO INTERCambiabili CON QUELLI ORIGINALI**
ALL THE COMPONENTS ARE INTERCHANGEABLE WITH THE ORIGINAL ONES



← **Fitment** - The continuous line means that it is necessary to fit all the components

← - - - **Option for fitment** - The dotted line means that it is not needed to fit all the components



136



MOTO GUZZI**V7 III '17/20**

EURO4

VEHICLE TYPE: **LD****PRO-RACING
STEEL END CAP**

	ECE	HOMOL.
NICHROM	71858PRI	
NICHROM "DARK"	71858PRN	



**TERMINALI PER COLLETTORI ORIGINALI
SILENCERS FOR ORIGINAL COLLECTORS**

**MOTO GUZZI****V85 TT '19/20**

EURO4

VEHICLE TYPE: **KW**

RACCORDO CENTRALE
NON CATALITICO
NON CATALYZED
CENTRAL LINK PIPE
71749MI *

**INDY RACE
CARBON END CAP**

	ECE	HOMOL.
TITANIUM	72632PK *	
ALUMINIUM	72632AK *	
ALUMINIUM "DARK"	72632AKN *	



* **TUTTI I COMPONENTI SONO INTERCAMBIABILI CON QUELLI ORIGINALI
ALL THE COMPONENTS ARE INTERCHANGEABLE WITH THE ORIGINAL ONES**



Fitment - The continuous line means that it is necessary to fit all the components



Option for fitment - The dotted line means that it is not needed to fit all the components

**137**

VEHICLE TYPE: **KY**



COLLETTORI RACING
RACING COLLECTORS
71756MI *



INDY RACE
CARBON END CAP

	ECE	HOMOL.
TITANIUM	72632PK *	
ALUMINIUM	72632AK *	
ALUMINIUM "DARK"	72632AKN *	



* **TUTTI I COMPONENTI SONO INTERCAMBIABILI CON QUELLI ORIGINALI**
ALL THE COMPONENTS ARE INTERCHANGEABLE WITH THE ORIGINAL ONES

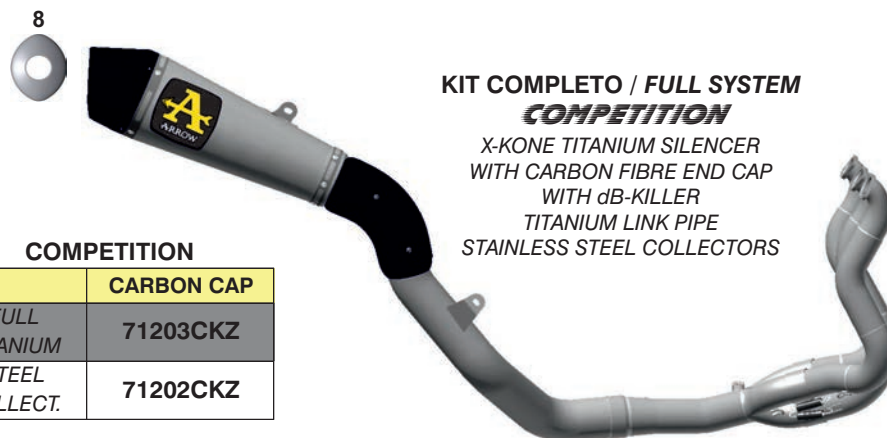

KIT COMPLETO / FULL SYSTEM
COMPETITION

X-KONE TITANIUM SILENCER
WITH CARBON FIBRE END CAP
WITH dB-KILLER
TITANIUM LINK PIPE
STAINLESS STEEL COLLECTORS

	COMPETITION
	CARBON CAP
FULL TITANIUM	71203CKZ
STEEL COLLECT.	71202CKZ



← **Fitment** - The continuous line means that it is necessary to fit all the components

← - - - - **Option for fitment** - The dotted line means that it is not needed to fit all the components



MV AGUSTA

Brutale 1090 RR '10/14

Brutale 990 R '09/12

Brutale 920 '11/12

THUNDER CARBON CAP

RACING	
TITANIUM	71110PK
CARBON FIBRE	71110MK
ALUMINIUM	71110AK
ALUMINIUM "DARK"	71110AKN



THUNDER STEEL CAP

RACING	
TITANIUM	71110PO
CARBON FIBRE	71110MO
ALUMINIUM	71110AO
ALUMINIUM "DARK"	71110AON

COLLETTORI RACING
RACING COLLECTORS
71428MI



COLLETTORI RACING
PER TERMINALI ORIGINALI
RACING COLLECTORS
FOR ORIGINAL SILENCERS
71450MI



PEUGEOT

Metropolis 400 '13/16

VEHICLE TYPE: X1

RACE-TECH CARBON END CAP

HOMOL. 	
ALUMINIUM	73510AK
ALUMINIUM "DARK"	73510AKN



TERMINALI PER COLLETTORE ORIGINALE
SILENCERS FOR ORIGINAL COLLECTOR



Fitment - The continuous line means that it is necessary to fit all the components



Option for fitment - The dotted line means that it is not needed to fit all the components



VEHICLE TYPE: X1

URBAN
CARBON END CAP

HOMOL.
ALUMINIUM "DARK" 73519AKN



RACCORDO CATALITICO OMOLOGATO
PER COLLETTORE ORIGINALE
CATALYTIC HOMOLOGATED LINK PIPE
FOR ORIGINAL COLLECTOR
73020KZ



URBAN
BLACK STEEL CAP

HOMOL.
ALUMINIUM "DARK" 73519ANN



RACCORDO RACING
PER COLLETTORE ORIGINALE
RACING LINK PIPE
FOR ORIGINAL COLLECTOR
73020MI



VEHICLE TYPE: M45

URBAN
BLACK STEEL CAP

HOMOL.
ALUMINIUM "DARK" 53505ANN



COLLETTORE CATALITICO OMOLOGATO
CATALYTIC HOMOLOGATED COLLECTOR
53051KZ



COLLETTORE RACING
RACING COLLECTOR
53051MI



← **Fitment** - The continuous line means that it is necessary to fit all the components

← - - - - **Option for fitment** - The dotted line means that it is not needed to fit all the components



PIAGGIO

Vespa GTS 125 ie '17/18  

VEHICLE TYPE: **MA3A**



COLLETTORE CATALITICO OMOLOGATO
CATALYTIC HOMOLOGATED COLLECTOR
53075KZ

COLLETTORE RACING
RACING COLLECTOR
53075MI



URBAN
BLACK STEEL CAP

 HOMOL.

ALUMINIUM
"DARK" **53528ANN**



PIAGGIO

Vespa Primavera 125 - 150 '14/16 

VEHICLE TYPE: **M81**



COLLETTORE CATALITICO OMOLOGATO
CATALYTIC HOMOLOGATED COLLECTOR
53050KZ

COLLETTORE RACING
RACING COLLECTOR
53050MI



URBAN
BLACK STEEL CAP

 HOMOL.

ALUMINIUM
"DARK" **53504ANN**



Fitment - The continuous line means that it is necessary to fit all the components



Option for fitment - The dotted line means that it is not needed to fit all the components



VEHICLE TYPE: **MA1A**

**URBAN
BLACK STEEL CAP**

ALUMINIUM "DARK"	53520ANN
-----------------------------	-----------------



8

EC
COLLETTORE CATALITICO OMOLOGATO
CATALYTIC HOMOLOGATED COLLECTOR
53067KZ



COLLETTORE RACING
RACING COLLECTOR
53067MI



VEHICLE TYPE: **MD1A**

**URBAN
CARBON END CAP**

ALUMINIUM "DARK"	53537AKN
-----------------------------	-----------------



8

**URBAN
BLACK STEEL CAP**

ALUMINIUM "DARK"	53537ANN
-----------------------------	-----------------



8

EC
COLLETTORE CATALITICO OMOLOGATO
CATALYTIC HOMOLOGATED COLLECTOR
53084KZ



COLLETTORE RACING
RACING COLLECTORS
53084MI



Fitment - The continuous line means that it is necessary to fit all the components



Option for fitment - The dotted line means that it is not needed to fit all the components



PIAGGIO

Medley 125 '16/19 EURO4 EC ECE

VEHICLE TYPE: MA0A

Medley 150 '16/19 EURO4 EC ECE

VEHICLE TYPE: MA0B

URBAN
BLACK STEEL CAP
ECE HOMOL.
ALUMINIUM "DARK" 53517ANN



EC

COLLETTORE CATALITICO OMOLOGATO
CATALYTIC HOMOLOGATED COLLECTOR
53064KZ



COLLETTORE RACING
RACING COLLECTORS
53064MI



PIAGGIO

Medley 125 S '21 EURO5 EC ECE

VEHICLE TYPE: MB0A

Medley 150 S '21 EURO5 EC ECE

VEHICLE TYPE: MB0B

URBAN
BLACK STEEL CAP
ECE HOMOL.
ALUMINIUM "DARK" 53535ANN



EC

COLLETTORE CATALITICO OMOLOGATO
CATALYTIC HOMOLOGATED COLLECTOR
53082KZ



COLLETTORE RACING
RACING COLLECTORS
53082MI



← **Fitment** - The continuous line means that it is necessary to fit all the components

← - - - **Option for fitment** - The dotted line means that it is not needed to fit all the components



VEHICLE TYPE: MD2

URBAN
CARBON END CAP

HOMOL.
ALUMINIUM "DARK" 53539AKN

8



URBAN
BLACK STEEL CAP

HOMOL.
ALUMINIUM "DARK" 53539ANN

8



RACCORDO CATALITICO OMOLOGATO
PER COLLETTORE ORIGINALE
CATALYTIC HOMOLOGATED LINK PIPE
FOR ORIGINAL COLLECTOR
53088KZ



RACCORDO RACING
PER COLLETTORE ORIGINALE
RACING LINK PIPE
FOR ORIGINAL COLLECTOR
53088MI



VEHICLE TYPE: M45

URBAN
BLACK STEEL CAP

HOMOL.
ALUMINIUM "DARK" 53505ANN

8



COLLETTORE CATALITICO OMOLOGATO
CATALYTIC HOMOLOGATED COLLECTOR
53051KZ



COLLETTORE RACING
RACING COLLECTOR
53051MI



← **Fitment** - The continuous line means that it is necessary to fit all the components

← - - - - **Option for fitment** - The dotted line means that it is not needed to fit all the components



PIAGGIO

Vespa GTS 300 '17/18 - GTS 300 HPE '19/20

EURO4



VEHICLE TYPE: **MA3C**

URBAN
BLACK STEEL CAP

	ECE	HOMOL.
ALUMINIUM "DARK"	53525ANN	



5
COLLETTORE CATALITICO OMOLOGATO
CATALYTIC HOMOLOGATED COLLECTOR
53072KZ



COLLETTORE RACING
RACING COLLECTOR
53072MI



PIAGGIO

Vespa GTS 300 '21

EURO5



VEHICLE TYPE: **MD3C**

URBAN
CARBON END CAP

	ECE	HOMOL.
ALUMINIUM "DARK"	53536AKN	



EC
COLLETTORE CATALITICO OMOLOGATO
CATALYTIC HOMOLOGATED COLLECTOR
53083KZ



COLLETTORE RACING
RACING COLLECTORS
53083MI



Fitment - The continuous line means that it is necessary to fit all the components



Option for fitment - The dotted line means that it is not needed to fit all the components



145



Beverly 400 '06/10 VEHICLE TYPE: **M34****Beverly 500 '03/08** VEHICLE TYPE: **M34****Beverly 400 Tourer '08/11** VEHICLE TYPE: **M34****Beverly 500 Cruiser '07/12** VEHICLE TYPE: **M34**

URBAN
BLACK STEEL CAP

	HOMOL.
ALUMINIUM "DARK"	73501ANN





COLLETORE
CATALITICO OMOLOGATO
CATALYTIC HOMOLOGATED
COLLECTOR
73001KZ



COLLETORE RACING
RACING COLLECTORS
73001MI

MP3 400 RST '07/11 VEHICLE TYPE: **M59****MP3 400 LT '07/11** VEHICLE TYPE: **M64**

URBAN
BLACK STEEL CAP

	HOMOL.
ALUMINIUM "DARK"	73502ANN



COLLETORE
CATALITICO OMOLOGATO
CATALYTIC HOMOLOGATED
COLLECTOR
73002KZ



COLLETORE RACING
RACING COLLECTORS
73002MI



Fitment - The continuous line means that it is necessary to fit all the components



Option for fitment - The dotted line means that it is not needed to fit all the components



PIAGGIO

MP3 500 LT '14/16



VEHICLE TYPE: **M86**

URBAN
BLACK STEEL CAP
ALUMINIUM "DARK" 73505ANN



HOMOL.



COLLETTORE RACING
RACING COLLECTORS
73002MI



PIAGGIO

MP3 500 LT '17/18



VEHICLE TYPE: **TA1**

URBAN
BLACK STEEL CAP
ALUMINIUM "DARK" 73512ANN



HOMOL.



RACCORDO CATALITICO OMOLOGATO
PER COLLETTORE ORIGINALE
CATALYTIC HOMOLOGATED LINK PIPE
FOR ORIGINAL COLLECTOR
73012KZ



RACCORDO RACING
PER COLLETTORE ORIGINALE
RACING LINK PIPE
FOR ORIGINAL COLLECTOR
73012MI



Fitment - The continuous line means that it is necessary to fit all the components



Option for fitment - The dotted line means that it is not needed to fit all the components



SUZUKI

GSX-S - GSX-R 125 '17/20

EURO4



VEHICLE TYPE: **WDL0**

PRO-RACE STEEL END CAP

	ECE	HOMOL.
NICHROM		71871PRI
NICHROM "DARK"		71871PRN

THUNDER CARBON END CAP

	ECE	HOMOL.
TITANIUM		71871PK
CARBON FIBRE		71871MK
ALUMINIUM		71871AK
ALUMINIUM "DARK"		71871AKN



PROTEZIONE PARATACCO
IN CARBONIO PER TERMINALI ARROW
CARBON HEEL GUARD
FOR ARROW SILENCERS

11005MI



COLLETORE CATALITICO OMOLOGATO
CATALYTIC HOMOLOGATED COLLECTOR
71681KZ



COLLETORE RACING
RACING COLLECTOR
71681MI



SUZUKI

GSX 250 R '17/20

EURO4



VEHICLE TYPE: **WDNO**

PRO-RACE STEEL END CAP

	ECE	HOMOL.
NICHROM		71870PRI *
NICHROM "DARK"		71870PRN *

2



TERMINALI PER COLLETTORI ORIGINALI
SILENCERS FOR ORIGINAL COLLECTORS



← **Fitment** - The continuous line means that it is necessary to fit all the components

← - - - - **Option for fitment** - The dotted line means that it is not needed to fit all the components



SUZUKI

DR 600 R '85/87

DR 600 S '85/90



VEHICLE TYPE: **SN 41 A**

2



PARIS DAKAR REPLICA
OMOLOGATO / HOMOLOGATED
72640PD *

COLLETTORI RACING
RACING COLLECTORS
72124PD *



DB-KILLER / SPARK ARRESTER
PER TERMINALI PARIS DAKAR REPLICA
FOR PARIS DAKAR REPLICA SILENCER
12004PD



*** TUTTI I COMPONENTI SONO INTERCambiABILI CON QUELLI ORIGINALI
ALL THE COMPONENTS ARE INTERCHANGEABLE WITH THE ORIGINAL ONES**



SUZUKI

GSX-R 600 i.e. '06/07

VEHICLE TYPE: **WVCE**

PRO-RACE
STEEL END CAP

		HOMOL.
TITANIUM		71632PR
NICHROM		71632PRI

2



COLLETTORI RACING
RACING COLLECTORS
71334MI



THUNDER
STEEL END CAP

		HOMOL.
ALUMINIUM		71702AO
ALUMINIUM "DARK"		71702AON

3



RACCORDO CENTRALE
PER COLL. ORIGINALI
CENTRAL LINK PIPE
FOR ORIGINAL COLLECTORS
71333MI



Fitment - The continuous line means that it is necessary to fit all the components



Option for fitment - The dotted line means that it is not needed to fit all the components



149



VEHICLE TYPE: **WVCV**

THUNDER CARBON CAP

		HOMOL.
TITANIUM		71729PK
CARBON FIBRE		71729MK
ALUMINIUM		71729AK
ALUMINIUM "DARK"		71729AKN

THUNDER STEEL CAP

		HOMOL.
ALUMINIUM		71729AO
ALUMINIUM "DARK"		71729AON

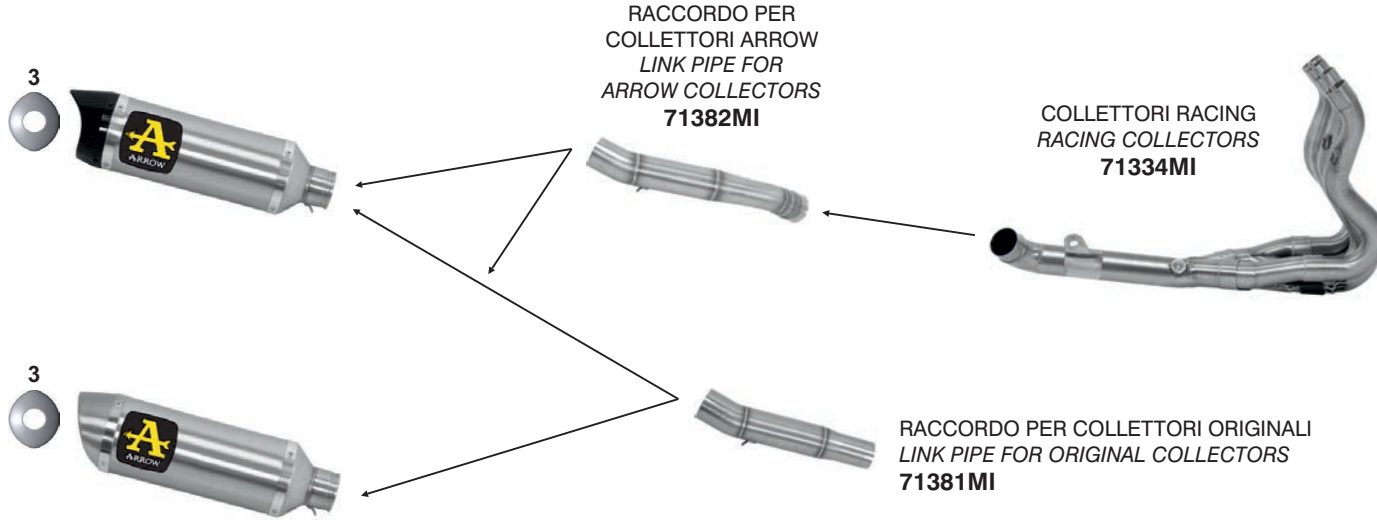

← **Fitment** - The continuous line means that it is necessary to fit all the components

← - - - - **Option for fitment** - The dotted line means that it is not needed to fit all the components



VEHICLE TYPE: **WVC3**

RACCORDO PER COLLETTORI ARROW
LINK PIPE FOR ARROW COLLECTORS
71440MI

COLLETTORI RACING
RACING COLLECTORS
71439MI

RACCORDO PER COLLETTORI ORIGINALI
LINK PIPE FOR ORIGINAL COLLECTORS
71438MI



3

**THUNDER
CARBON END CAP**

	HOMOL.
TITANIUM	71772PK
CARBON FIBRE	71772MK
ALUMINIUM	71772AK
ALUMINIUM "DARK"	71772AKN

dB-KILLER PER TERMINALE GP2
dB-KILLER FOR GP2 SILENCER
11009DB

2

GP2 SILENCERS

	RACING
FULL TITANIUM	71006GP *
STEEL "DARK"	71006GPI *

**KIT COMPLETO / FULL SYSTEM
COMPETITION**

THUNDER TITANIUM SILENCER
WITH CARBON END CAP AND dB-KILLER
TITANIUM LINK PIPE ø50/60mm.
STEEL OR TITANIUM COLLECTORS

COMPETITION

	CARBON CAP
FULL TITANIUM	71108CKZ
STEEL COLLECT.	71107CKZ



* **TERMINALI PER COLLETTORI ORIGINALI
SILENCERS FOR ORIGINAL COLLECTORS**



Fitment - The continuous line means that it is necessary to fit all the components



Option for fitment - The dotted line means that it is not needed to fit all the components



SUZUKI**V-Strom 650 '17/20** EURO4 VEHICLE TYPE: **WC70**RACE-TECH
CARBON END CAP

	 HOMOL.
TITANIUM	72622PK
ALUMINIUM	72622AK
ALUMINIUM "DARK"	72622AKN



COLLETTORI CATALITICI OMOLOGATI
CATALYTIC HOMOLOGATED COLLECTORS
71677KZ

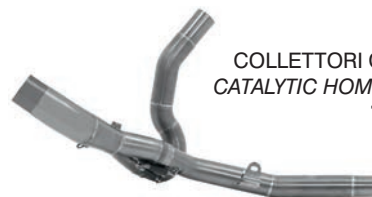

COLLETTORI RACING
RACING COLLECTORS
71677MI

**SUZUKI****Bandit 650 - 650 S '07/13**  VEHICLE TYPE: **WVCZ - WVCJ****GSX 650 F '07/15**  VEHICLE TYPE: **WVCJ**RACE-TECH
CARBON END CAP

	 HOMOL.
TITANIUM	71822PK
ALUMINIUM	71822AK
ALUMINIUM "DARK"	71822AKN

RACE-TECH
STEEL END CAP

	 HOMOL.
ALUMINIUM	71822AO
ALUMINIUM "DARK"	71822AON



RACCORDO
LINK PIPE
71372MI *



COLLETTORI RACING
RACING COLLECTORS
71374MI



* **IL RACCORDO 71372MI MONTA ANCHE SU COLLETTORI ORIGINALI**
71372MI LINK PIPE ALSO FITS TO ORIGINAL COLLECTORS



Fitment - The continuous line means that it is necessary to fit all the components



Option for fitment - The dotted line means that it is not needed to fit all the components

**152**

SUZUKI

SVF 650 Gladius '09/15



VEHICLE TYPE: **WCCX**

THUNDER STEEL END CAP

	HOMOL.
TITANIUM	71742PO
ALUMINIUM	71742AO
ALUMINIUM "DARK"	71742AON



**TERMINALI PER COLLETTORI ORIGINALI
SILENCERS FOR ORIGINAL COLLECTORS**

SUZUKI

SV 650 '16/20



VEHICLE TYPE: **WCX0**

X-KONE CARBON CAP

	HOMOL.
NICHROM	71846XKI

RACE-TECH CARBON CAP

	HOMOL.
TITANIUM	71846PK
ALUMINIUM	71846AK
ALUMINIUM "DARK"	71846AKN

RACE-TECH STEEL CAP

	HOMOL.
ALUMINIUM	71846AO
ALUMINIUM "DARK"	71846AON



RACCORDO RACING
RACING LINK PIPE
71645MI #

RACCORDO 2 IN 1
NON CATALITICO
2 INTO 1
NON CATALYZED
LINK PIPE
71646MI #



**IL RACCORDO 71646MI MONTA ANCHE CON TERMINALI ORIGINALI
71646MI LINK PIPE ALSO FITS TO ORIGINAL SILENCER**



* **IL RACCORDO 71645MI MONTA ANCHE SU RACCORDO CATALITICO ORIGINALE
71645MI LINK PIPE ALSO FITS TO ORIGINAL CATALYZED LINK PIPE**



Fitment - The continuous line means that it is necessary to fit all the components



Option for fitment - The dotted line means that it is not needed to fit all the components



153



VEHICLE TYPE: **C5**



**X-KONE
CARBON END CAP**

		HOMOL.
NICHROM		71776XKI *

RACCORDO PER TERMINALI X-KONE e ORIGINALI
LINK PIPE FOR X-KONE and ORIGINAL SILENCERS
71445MI #



COLLETTORI RACING
RACING COLLECTORS
71443MI



* **IL TERMINALE X-KONE MONTA ANCHE
SU COLLETTORI ORIGINALI
X-KONE SILENCER ALSO FITS
TO ORIGINAL COLLECTORS**



**IL RACCORDO 71445MI MONTA ANCHE
CON TERMINALI ORIGINALI
71445MI LINK PIPE ALSO FITS
TO ORIGINAL SILENCERS**



**RACE-TECH
CARBON END CAP**

		HOMOL.
TITANIUM		71776PKK
ALUMINIUM		71776AK
ALUMINIUM "DARK"		71776AKN



71444MI
RACCORDO PER TERMINALI RACE-TECH
LINK PIPE FOR RACE-TECH SILENCERS



71442MI
RACCORDO PER COLLETTORI ORIGINALI
PER TERMINALI RACE-TECH
LINK PIPE FOR ORIGINAL COLLECTORS
FOR RACE-TECH SILENCERS



← **Fitment** - The continuous line means that it is necessary to fit all the components



← **Option for fitment** - The dotted line means that it is not needed to fit all the components



SUZUKI

GSX-S 750 '17/20

EURO4

EC
ECE

CARB

VEHICLE TYPE: **WC50**



PRO-RACE STEEL CAP

	ECE	HOMOL.
NICHROM		71776PRI*
NICHROM "DARK"		71776PRN*



X-KONE CARBON CAP

	ECE	HOMOL.
NICHROM		71776XKI*

 * MONTANO ANCHE SU COLLETTORI ORIGINALI
SILENCERS ALSO FIT TO ORIGINAL COLLECTORS



RACE-TECH CARBON CAP

	ECE	HOMOL.
TITANIUM		71776PKK
ALUMINIUM		71776AK
ALUMINIUM "DARK"		71776AKN

RACCORDO PER TERMINALI X-KONE e ORIGINALI
LINK PIPE FOR X-KONE and ORIGINAL SILENCERS
71445MI #

 * IL RACCORDO 71445MI MONTA ANCHE
CON TERMINALI ORIGINALI
71445MI LINK PIPE ALSO FITS
TO ORIGINAL SILENCERS

COLLETTORI RACING
RACING COLLECTORS
71443MI

71444MI
RACCORDO PER TERMINALI RACE-TECH
LINK PIPE FOR RACE-TECH SILENCERS

71442MI
RACCORDO PER COLLETTORI ORIGINALI
PER TERMINALI RACE-TECH
LINK PIPE FOR ORIGINAL COLLECTORS
FOR RACE-TECH SILENCERS



← **Fitment** - The continuous line means that it is necessary to fit all the components



← **Option for fitment** - The dotted line means that it is not needed to fit all the components



155



SUZUKI

GSX-R 750 i.e. '06/07

VEHICLE TYPE: **WVCF**

PRO-RACE STEEL END CAP

	9	HOMOL.
TITANIUM	71632PR	
NICHROM	71632PRI	

THUNDER STEEL END CAP

	9	HOMOL.
ALUMINIUM	71702AO	
ALUMINIUM "DARK"	71702AON	

2



3



COLLETTORI RACING
RACING COLLECTORS
71334MI



RACCORDO CENTRALE
PER COLL. ORIGINALI
CENTRAL LINK PIPE
FOR ORIGINAL COLLECTORS
71333MI



SUZUKI

GSX-R 750 i.e. '08/10



VEHICLE TYPE: **WVCW**

THUNDER CARBON CAP

	9	HOMOL.
TITANIUM	71729PK	
CARBON FIBRE	71729MK	
ALUMINIUM	71729AK	
ALUMINIUM "DARK"	71729AKN	

THUNDER STEEL CAP

	9	HOMOL.
ALUMINIUM	71729AO	
ALUMINIUM "DARK"	71729AON	

3



3



RACCORDO PER
COLLETTORI ARROW
LINK PIPE FOR
ARROW COLLECTORS
71382MI



COLLETTORI RACING
RACING COLLECTORS
71334MI



RACCORDO PER COLLETTORI ORIGINALI
LINK PIPE FOR ORIGINAL COLLECTORS
71381MI



← **Fitment** - The continuous line means that it is necessary to fit all the components

← - - - **Option for fitment** - The dotted line means that it is not needed to fit all the components



VEHICLE TYPE: **WVC4**

RACCORDO PER COLLETTORI ARROW
LINK PIPE FOR ARROW COLLECTORS
71440MI

COLLETTORI RACING
RACING COLLECTORS
71439MI

RACCORDO PER COLLETTORI ORIGINALI
LINK PIPE FOR ORIGINAL COLLECTORS
71438MI



3

THUNDER
CARBON END CAP

	HOMOL.
TITANIUM	71772PK
CARBON FIBRE	71772MK
ALUMINIUM	71772AK
ALUMINIUM "DARK"	71772AKN

dB-KILLER PER TERMINALE GP2
dB-KILLER FOR GP2 SILENCER
11009DB

2

GP2 SILENCERS

	RACING
FULL TITANIUM	71006GP *
STEEL "DARK"	71006GPI *

KIT COMPLETO / FULL SYSTEM
COMPETITION

THUNDER TITANIUM SILENCER
WITH CARBON END CAP AND dB-KILLER
TITANIUM LINK PIPE ø50/60mm.
STEEL OR TITANIUM COLLECTORS

COMPETITION

	CARBON CAP
FULL TITANIUM	71108CKZ
STEEL COLLECT.	71107CKZ



* **TERMINALI PER COLLETTORI ORIGINALI**
SILENCERS FOR ORIGINAL COLLECTORS



← **Fitment** - The continuous line means that it is necessary to fit all the components



← **Option for fitment** - The dotted line means that it is not needed to fit all the components



VEHICLE TYPE: **DD**

MAXI RACE-TECH CARBON END CAP

	HOMOL.
TITANIUM	71816PK *
ALUMINIUM	71816AK *
ALUMINIUM "DARK"	71816AKN *



**TERMINALI PER COLLETTORI ORIGINALI
SILENCERS FOR ORIGINAL COLLECTORS**

VEHICLE TYPE: **WDDO**



SONORA CARBON END CAP

	HOMOL.
TITANIUM	72502SK
TITANIUM "DARK"	72502SKN



MAXI RACE-TECH CARBON END CAP

	HOMOL.
TITANIUM	71816PK
ALUMINIUM	71816AK
ALUMINIUM "DARK"	71816AKN



**TERMINALI PER COLLETTORI ORIGINALI
SILENCERS FOR ORIGINAL COLLECTORS**



Fitment - The continuous line means that it is necessary to fit all the components



Option for fitment - The dotted line means that it is not needed to fit all the components



SUZUKI

V-Strom 1050 '20/21

EURO5

EC ECE

CARB

VEHICLE TYPE: WEFO



COVER IN CARBONIO
PER TERMINALI SONORA
CARBON FIBRE COVER
FOR SONORA SILENCERS
11008MI



SONORA
CARBON END CAP

	ECE	HOMOL.
TITANIUM		72502SK
TITANIUM "DARK"		72502SKN



MAXI RACE-TECH
CARBON END CAP

	ECE	HOMOL.
TITANIUM		71816PK
ALUMINIUM		71816AK
ALUMINIUM "DARK"		71816AKN

TERMINALI PER COLLETTORI ORIGINALI
SILENCERS FOR ORIGINAL COLLECTORS

SUZUKI

Katana 1000 '19/20

EURO4

EC ECE

CARB

VEHICLE TYPE: WDG0



X-KONE CARBON CAP

	ECE	HOMOL.
TITANIUM		71917XK *
NICHROM "DARK"		71917XKN *

PRO-RACE TITANIUM CAP

	ECE	HOMOL.
TITANIUM		71828PR *

PRO-RACE STEEL CAP

	ECE	HOMOL.
NICHROM		71828PRI *
NICHROM "DARK"		71828PRN *



N.B. PER L'INSTALLAZIONE DEL KIT COLLETTORI ARROW SI CONSIGLIA DI LEGGERE LA NOTA
INFORMATIVA PUBBLICATA SUL NOSTRO SITO NELLA PAGINA DEDICATA A QUESTA MOTO.
**WHEN INSTALLING ARROW COLLECTORS KIT, PLEASE READ THE TECHNICAL NOTE
RELEASED IN ARROW WEBSITE PAGE DEDICATED TO THIS BIKE**

COLLETTORI RACING
RACING COLLECTORS
71628MI *

*** TUTTI I COMPONENTI SONO INTERCAMBIABILI CON QUELLI ORIGINALI**
ALL THE COMPONENTS ARE INTERCHANGEABLE WITH THE ORIGINAL ONES



Fitment - The continuous line means that it is necessary to fit all the components



Option for fitment - The dotted line means that it is not needed to fit all the components



159



VEHICLE TYPE: **DG**

VEHICLE TYPE: **WDG0**

**PRO-RACE
TITANIUM END CAP**

	ECE	HOMOL.
TITANIUM	71828PR *	



**PRO-RACE
STEEL END CAP**

	ECE	HOMOL.
NICHROM	71828PRI *	
NICHROM "DARK"	71828PRN *	



**X-KONE
CARBON END CAP**

	ECE	HOMOL.
TITANIUM	71828XKI *	



**RACE-TECH
CARBON END CAP**

	ECE	HOMOL.
TITANIUM	71828PK *	
CARBON FIBRE	71828MK *	
ALUMINIUM	71828AK *	
ALUMINIUM "DARK"	71828AKN *	



N.B. PER L'INSTALLAZIONE DEL KIT COLLETTORI ARROW SI CONSIGLIA DI LEGGERE LA NOTA INFORMATIVA PUBBLICATA SUL NOSTRO SITO NELLA PAGINA DEDICATA A QUESTA MOTO. WHEN INSTALLING ARROW COLLECTORS KIT, PLEASE READ THE TECHNICAL NOTE RELEASED IN ARROW WEBSITE PAGE DEDICATED TO THIS BIKE

COLLETTORI RACING
RACING COLLECTORS
71628MI *



* **TUTTI I COMPONENTI SONO INTERCAMBIABILI CON QUELLI ORIGINALI**
ALL THE COMPONENTS ARE INTERCHANGEABLE WITH THE ORIGINAL ONES



Fitment - The continuous line means that it is necessary to fit all the components

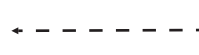

Option for fitment - The dotted line means that it is not needed to fit all the components



SUZUKI

GSX-R 1000 - 1000 R '17/20

EURO4

EC ECE

CARB

VEHICLE TYPE: **WDMO**

PRO-RACE TITANIUM CAP

	RACING
TITANIUM	71207PR *

PRO-RACE STEEL CAP

	RACING
NICHROM	71207PRI *
NICHROM "DARK"	71207PRN *

X-KONE CARBON CAP

	ECE	HOMOL.
NICHROM	71855XKI *	

RACE-TECH CARBON CAP

	ECE	HOMOL.
TITANIUM	71855PK *	
CARBON FIBRE	71855MK *	
ALUMINIUM	71855AK *	
ALUMINIUM "DARK"	71855AKN *	



dB-KILLER PER TERMINALI PRO-RACE
dB-KILLER FOR PRO-RACE SILENCERS
11012DB

COLLETTORI RACING
RACING COLLECTORS
71660MI



* **TUTTI I TERMINALI MONTANO ANCHE SU COLLETTORI ORIGINALI**
ALL SILENCERS ALSO FIT TO ORIGINAL COLLECTORS

KIT COMPLETO / FULL SYSTEM

COMPETITION «EVO»

RACE-TECH TITANIUM SILENCER WITH CARBON END CAP AND dB-KILLER
TITANIUM LINK PIPE ø50/65mm.
STEEL OR TITANIUM COLLECTORS



COMPETITION "EVO"

	CARBON CAP
FULL TITANIUM	71161CKR
STEEL COLLECT.	71160CKR

KIT COMPLETO / FULL SYSTEM

COMPETITION

RACE-TECH TITANIUM SILENCER WITH CARBON END CAP AND dB-KILLER
TITANIUM LINK PIPE ø50/60mm.
STEEL OR TITANIUM COLLECTORS



COMPETITION

	CARBON CAP
FULL TITANIUM	71161CKZ
STEEL COLLECT.	71160CKZ



← **Fitment** - The continuous line means that it is necessary to fit all the components



← **Option for fitment** - The dotted line means that it is not needed to fit all the components



161



SUZUKI

Bandit 1250 - 1250 S '07/16



GSX 1250 FA '10/16



VEHICLE TYPE: **WVCH**

VEHICLE TYPE: **WVCH**

RACE-TECH
CARBON END CAP

	EUROPEAN HOMOL.
TITANIUM	71822PK
ALUMINIUM	71822AK
ALUMINIUM "DARK"	71822AKN



RACE-TECH
STEEL END CAP

	EUROPEAN HOMOL.
ALUMINIUM	71822AO
ALUMINIUM "DARK"	71822AON



RACCORDO
LINK PIPE
71372MI *



COLLETTORI RACING
RACING COLLECTORS
71374MI



* IL RACCORDO 71372MI MONTA ANCHE SU COLLETTORI ORIGINALI
71372MI LINK PIPE ALSO FITS TO ORIGINAL COLLECTORS



SYM

Cruisym 125i '18/20

EURO4



VEHICLE TYPE: **LN_A1**

URBAN
BLACK STEEL CAP

	EUROPEAN HOMOL.
ALUMINIUM "DARK"	53527ANN



COLLETORE CATALITICO OMOLOGATO
CATALYTIC HOMOLOGATED COLLECTOR
53074KZ



COLLETORE RACING
RACING COLLECTOR
53074MI



← **Fitment** - The continuous line means that it is necessary to fit all the components

← - - - **Option for fitment** - The dotted line means that it is not needed to fit all the components



162



SYM**Cruisym 300 '17/20**  VEHICLE TYPE: **LN_A2****URBAN
BLACK STEEL CAP**

	HOMOL.
ALUMINIUM	53522ANN
"DARK"	

8



RACCORDO CATALITICO OMOLOGATO
PER COLLETTORE ORIGINALE
CATALYTIC HOMOLOGATED LINK PIPE
FOR ORIGINAL COLLECTOR
53069KZ



RACCORDO RACING
PER COLLETTORE ORIGINALE
RACING LINK PIPE
FOR ORIGINAL COLLECTOR
53069MI

**TRIUMPH****Bonneville T100 '17/20**   VEHICLE TYPE: **DB01A****PRO-RACING
STEEL END CAP**

	HOMOL.
NICHROM	71853PRI
NICHROM "DARK"	71853PRN

10



TERMINALI PER COLLETTORI ORIGINALI
SILENCERS FOR ORIGINAL COLLECTORS

Bonneville T120 '16/19   VEHICLE TYPE: **DU01A**

Fitment - The continuous line means that
it is necessary to fit all the components



Option for fitment - The dotted line means that
it is not needed to fit all the components

**163**

VEHICLE TYPE: DE01 - DE01A

Speed Twin 1200 '19/20

VEHICLE TYPE: DD01

PRO-RACING CARBON END CAP

	ECE	HOMOL.
NICHROM		71851RKI *

PRO-RACING STEEL END CAP

	ECE	HOMOL.
NICHROM		71851PRI *
NICHROM "DARK"		71851PRN *

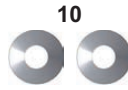
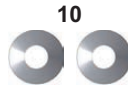

COLLETTORI RACING
NON CATALITICI
NON CATALYTIC
RACING COLLECTORS
71664MI *



* TUTTI I COMPONENTI SONO INTERCambiabili CON QUELLI ORIGINALI
ALL THE COMPONENTS ARE INTERCHANGEABLE WITH THE ORIGINAL ONES



VEHICLE TYPE: UM125-DSM

THUNDER CARBON CAP

	ECE	HOMOL.
TITANIUM		52509PK *
ALUMINIUM		52509AK *
ALUMINIUM "DARK"		52509AKN *

THUNDER STEEL CAP

	ECE	HOMOL.
ALUMINIUM		52509AO *
ALUMINIUM "DARK"		52509AON *



COLLETTORE CATALITICO OMOLOGATO
CATALYTIC HOMOLOGATED COLLECTOR
52001PZ *

COLLETTORE RACING
RACING COLLECTOR
52001PD *



* TUTTI I COMPONENTI SONO INTERCambiabili CON QUELLI ORIGINALI
ALL THE COMPONENTS ARE INTERCHANGEABLE WITH THE ORIGINAL ONES



Fitment - The continuous line means that it is necessary to fit all the components

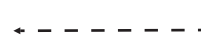

Option for fitment - The dotted line means that it is not needed to fit all the components



YAMAHA

NMAX 125 '17/20 EURO4 

VEHICLE TYPE: **SEC7**

URBAN
BLACK STEEL CAP
 HOMOL.
ALUMINIUM "DARK" 53521ANN



YAMAHA

Tricity 125 '17/20 EURO4 

VEHICLE TYPE: **SEC2**

URBAN
BLACK STEEL CAP
 HOMOL.
ALUMINIUM "DARK" 53521ANN



Fitment - The continuous line means that it is necessary to fit all the components



Option for fitment - The dotted line means that it is not needed to fit all the components



165



VEHICLE TYPE: **SEE6**

URBAN
BLACK STEEL CAP

		HOMOL.
ALUMINIUM "DARK"	53526ANN	

8



RACCORDO CATALITICO OMOLOGATO
PER COLLETTORE ORIGINALE
CATALYTIC HOMOLOGATED LINK PIPE
FOR ORIGINAL COLLECTOR
53073KZ



RACCORDO RACING
PER COLLETTORE ORIGINALE
RACING LINK PIPE
FOR ORIGINAL COLLECTOR
53073MI



VEHICLE TYPE: **DE07**

THUNDER
CARBON END CAP

		HOMOL.
ALUMINIUM	52505AK *	
ALUMINIUM "DARK"	52505AKN *	

THUNDER
STEEL END CAP

		HOMOL.
ALUMINIUM	52505AO *	
ALUMINIUM "DARK"	52505AON *	

COLLETTORE RACING
RACING COLLECTOR
52003MI #



3



3



IL COLLETTORE MONTA ANCHE CON TERMINALE ORIGINALE
52003MI COLLECTOR ALSO FITS TO ORIGINAL SILENCER



* I TERMINALI MONTANO ANCHE SU COLLETTORI ORIGINALI
SILENCERS ALSO FIT TO ORIGINAL COLLECTOR



← **Fitment** - The continuous line means that it is necessary to fit all the components



← **Option for fitment** - The dotted line means that it is not needed to fit all the components



YAMAHA

MT 125 '14/16



VEHICLE TYPE: **RE11**

THUNDER CARBON CAP

	ECE HOMOL.
TITANIUM	51513PK
ALUMINIUM	51513AK
ALUMINIUM "DARK"	51513AKN

THUNDER STEEL CAP

	ECE HOMOL.
ALUMINIUM	51513AO
ALUMINIUM "DARK"	51513AON



MT 125 '14/16



VEHICLE TYPE: **RE11**



COLETTORE CATALITICO OMOLOGATO
CATALYTIC HOMOLOGATED COLLECTOR
51012KZ



COLLETTORE RACING
RACING COLLECTOR
51012MI



YAMAHA

MT 125 '20



VEHICLE TYPE: **RE39**

PRO-RACE STEEL CAP

	RACING
NICHROM	51004PRI
NICHROM "DARK"	51004PRN

THUNDER CARBON CAP

	ECE HOMOL.
TITANIUM	51518PK
ALUMINIUM	51518AK
ALUMINIUM "DARK"	51518AKN

THUNDER STEEL CAP

	ECE HOMOL.
TITANIUM	51518PO
ALUMINIUM	51518AO
ALUMINIUM "DARK"	51518AON



COLLETTORE CATALITICO OMOLOGATO
HOMOLOGATED CATALYZED COLLECTOR
51018KZ



COLLETTORE RACING
RACING COLLECTOR
51018MI



← **Fitment** - The continuous line means that it is necessary to fit all the components



← **Option for fitment** - The dotted line means that it is not needed to fit all the components



YAMAHA

MT 125 '21

EURO5



PRO-RACE STEEL CAP

RACING	
NICHROM	51004PRI
NICHROM "DARK"	51004PRN

THUNDER CARBON CAP

ECE HOMOL.	
TITANIUM	51518PK
ALUMINIUM	51518AK
ALUMINIUM "DARK"	51518AKN

THUNDER STEEL CAP

ECE HOMOL.	
TITANIUM	51518PO
ALUMINIUM	51518AO
ALUMINIUM "DARK"	51518AON

VEHICLE TYPE: RE40



COLLETTORE CATALITICO OMOLOGATO
HOMOLOGATED CATALYZED
COLLECTOR
51019KZ

COLLETTORE RACING
RACING COLLECTOR
51019MI

YAMAHA

YZF-R 125 '08/13



THUNDER CARBON END CAP

ECE HOMOL.	
ALUMINIUM "DARK"	51503AKN

THUNDER STEEL END CAP

ECE HOMOL.	
ALUMINIUM	51503AO
ALUMINIUM "DARK"	51503AON

VEHICLE TYPE: RE06



COLLETTORE CATALITICO OMOLOGATO
HOMOLOGATED CATALYZED
COLLECTOR
51003KZ

COLLETTORE RACING
RACING COLLECTOR
51003MI



Fitment - The continuous line means that it is necessary to fit all the components



Option for fitment - The dotted line means that it is not needed to fit all the components



168



YAMAHA

YZF-R 125 '14/16



VEHICLE TYPE: **RE11**

**THUNDER
CARBON END CAP**

	HOMOL.
ALUMINIUM "DARK"	51503AKN

**THUNDER
STEEL END CAP**

	HOMOL.
ALUMINIUM	51503AO
ALUMINIUM "DARK"	51503AON



COLLETTORE
CATALITICO OMOLOGATO
HOMOLOGATED CATALYZED
COLLECTOR
51011KZ

COLLETTORE RACING
RACING COLLECTOR
51011MI



YAMAHA

YZF-R 125 '17/18



VEHICLE TYPE: **RE29**

THUNDER CARBON CAP

	HOMOL.
ALUMINIUM "DARK"	51503AKN

THUNDER STEEL CAP

	HOMOL.
ALUMINIUM	51503AO
ALUMINIUM "DARK"	51503AON

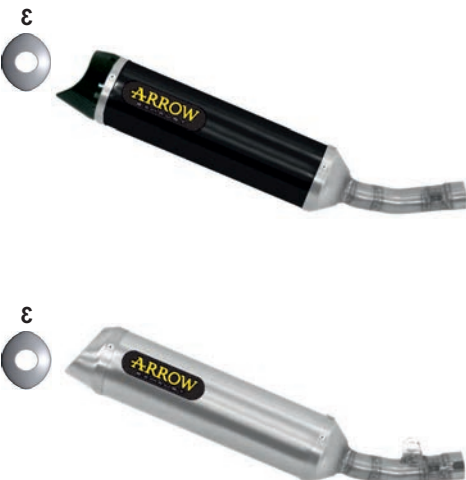

COLLETTORE
CATALITICO OMOLOGATO
HOMOLOGATED CATALYZED
COLLECTOR
51015KZ

COLLETTORE RACING
RACING COLLECTOR
51015MI



← **Fitment** - The continuous line means that it is necessary to fit all the components

← - - - **Option for fitment** - The dotted line means that it is not needed to fit all the components



VEHICLE TYPE: **RE39**

PRO-RACE STEEL END CAP

	RACING
NICHROM	51004PRI
NICHROM "DARK"	51004PRN



EC

COLLETTORE
CATALITICO OMOLOGATO
HOMOLOGATED CATALYZED
COLLECTOR
51018KZ



THUNDER CARBON END CAP

	ECE HOMOL.
TITANIUM	51518PK
ALUMINIUM	51518AK
ALUMINIUM "DARK"	51518AKN



COLLETTORE RACING
RACING COLLECTOR
51018MI



THUNDER STEEL END CAP

	ECE HOMOL.
TITANIUM	51518PO
ALUMINIUM	51518AO
ALUMINIUM "DARK"	51518AON



← **Fitment** - The continuous line means that it is necessary to fit all the components

← - - - - **Option for fitment** - The dotted line means that it is not needed to fit all the components



VEHICLE TYPE: RE40

PRO-RACE STEEL END CAP

	RACING
NICHROM	51004PRI
NICHROM "DARK"	51004PRN



THUNDER CARBON END CAP

	EC ECE	HOMOL.
TITANIUM		51518PK
ALUMINIUM		51518AK
ALUMINIUM "DARK"		51518AKN

THUNDER STEEL END CAP

	EC ECE	HOMOL.
TITANIUM		51518PO
ALUMINIUM		51518AO
ALUMINIUM "DARK"		51518AON

EC
COLLETTORE
CATALITICO OMOLOGATO
HOMOLOGATED CATALYZED
COLLECTOR
51019KZ

COLLETTORE RACING
RACING COLLECTOR
51019MI



Fitment - The continuous line means that it is necessary to fit all the components



Option for fitment - The dotted line means that it is not needed to fit all the components



VEHICLE TYPE: **SG43**

URBAN
BLACK STEEL CAP
ECE HOMOL.
ALUMINIUM "DARK" 53521ANN



COLETTORE
CATALITICO OMOLOGATO
CATALYTIC HOMOLOGATED
COLLECTOR
53068KZ



COLLETTORE RACING
RACING COLLECTORS
53068MI



VEHICLE TYPE: **SG22 - SG25 - SG26**

URBAN
BLACK STEEL CAP
EURO5 HOMOL.
ALUMINIUM "DARK" 53518ANN



RACCORDO CATALITICO OMOLOGATO
CATALYTIC HOMOLOGATED LINK PIPE
53065KZ



RACCORDO RACING
RACING LINK PIPE
53065MI



← **Fitment** - The continuous line means that it is necessary to fit all the components

← - - - - **Option for fitment** - The dotted line means that it is not needed to fit all the components



YAMAHA

XMAX 300 '17/20

EURO4



VEHICLE TYPE: SH08

URBAN
BLACK STEEL CAP

		HOMOL.
ALUMINIUM "DARK"	53523ANN	

8



RACCORDO CATALITICO OMOLOGATO
PER COLLETTORE ORIGINALE
CATALYTIC HOMOLOGATED LINK PIPE
FOR ORIGINAL COLLECTOR
53070KZ



RACCORDO RACING
PER COLLETTORE ORIGINALE
RACING LINK PIPE
FOR ORIGINAL COLLECTOR
53070MI



YAMAHA

MT-03 '16/17



MT-03 '18/19

EURO4



VEHICLE TYPE: RH07

VEHICLE TYPE: RH12

PRO-RACE
STEEL END CAP

		HOMOL.
NICHROM	71831PRI *	
NICHROM "DARK"	71831PRN *	

2



I COLLETTORI 71639MI NON SONO INTERCambiabili CON QUELLI ORIGINALI
71639MI COLLECTORS ARE NOT INTERCHANGEABLES WITH ORIGINAL ONES

COLLETTORI RACING
RACING COLLECTORS
71639MI #



THUNDER
CARBON END CAP

		HOMOL.
CARBON FIBRE	71831MK *	
ALUMINIUM	71831AK *	
ALUMINIUM "DARK"	71831AKN *	

3



* **TUTTI I TERMINALI MONTANO ANCHE SU COLLETTORI ORIGINALI E SONO OMOLOGATI SENZA DBKILLER**
ALL SILENCERS ALSO FIT TO ORIGINAL COLLECTORS. SILENCERS ARE HOMOLOGATED WITHOUT DB-KILLER



← **Fitment** - The continuous line means that it is necessary to fit all the components

← **Option for fitment** - The dotted line means that it is not needed to fit all the components



VEHICLE TYPE: **RH07**

VEHICLE TYPE: **RH12**



**THUNDER
CARBON END CAP**

	ECE	HOMOL.
CARBON FIBRE	71831MK *	
ALUMINIUM	71831AK *	
ALUMINIUM "DARK"	71831AKN *	



**PRO-RACE
STEEL END CAP**

	ECE	HOMOL.
NICHROM	71831PRI *	
NICHROM "DARK"	71831PRN *	



**TERMINALI PER COLLETTORI ORIGINALI
SILENCERS FOR ORIGINAL COLLECTORS**

VEHICLE TYPE: **RH12**

**PRO-RACE
STEEL END CAP**

	ECE	HOMOL.
NICHROM	71894PRI *	
NICHROM "DARK"	71894PRN *	

**THUNDER
CARBON END CAP**

	ECE	HOMOL.
TITANIUM	71894PK *	
CARBON FIBRE	71894MK *	
ALUMINIUM	71894AK *	
ALUMINIUM "DARK"	71894AKN *	



**# I COLLETTORI 71639MI NON SONO INTERCAMBIABILI CON QUELLI ORIGINALI
71639MI COLLECTORS ARE NOT INTERCHANGEABLES WITH ORIGINAL ONES**

COLLETTORI RACING
RACING COLLECTORS
71639MI #



*** TUTTI I TERMINALI MONTANO ANCHE SU COLLETTORI ORIGINALI E SONO OMOLOGATI SENZA DBKILLER
ALL SILENCERS ALSO FIT TO ORIGINAL COLLECTORS. SILENCERS ARE HOMOLOGATED WITHOUT DB-KILLER**



Fitment - The continuous line means that it is necessary to fit all the components



Option for fitment - The dotted line means that it is not needed to fit all the components



YAMAHA**YZF R3 '18/20**VEHICLE TYPE: **RH12**

KIT COMPLETO / FULL SYSTEM
 solo per moto elaborate / for tuning bikes only
COMPETITION

THUNDER TITANIUM SILENCERS
 WITH CARBON FIBRE END CAP and dB-KILLER
 TITANIUM LINK PIPE ø38-52mm.
 STAINLESS STEEL or TITANIUM COLLECTORS

**COMPETITION**

	CARBON CAP
FULL TITANIUM	71181CKZ
STEEL COLLECT.	71180CKZ

KIT COMPLETO / FULL SYSTEM
 solo per moto elaborate / for tuning bikes only

COMPETITION "EVO"

THUNDER TITANIUM SILENCERS
 WITH CARBON FIBRE END CAP and dB-KILLER
 TITANIUM LINK PIPE ø38-48mm.
 STAINLESS STEEL or TITANIUM COLLECTORS

**COMPETITION "EVO"**

	CARBON CAP
FULL TITANIUM	71181CKR
STEEL COLLECT.	71180CKR

YAMAHA**XMAX 400 '13/16**VEHICLE TYPE: **SH07**

RACE-TECH
CARBON END CAP

	HOMOL.
ALUMINIUM "DARK"	73509AKN



TERMINALI PER COLLETTORI ORIGINALI
SILENCER FOR ORIGINAL COLLECTORS



Fitment - The continuous line means that it is necessary to fit all the components



Option for fitment - The dotted line means that it is not needed to fit all the components

**175**

VEHICLE TYPE: SH12

URBAN
BLACK STEEL CAP

	HOMOL.
ALUMINIUM "DARK"	53524ANN



RACCORDO CATALITICO OMOLOGATO
PER COLLETTORE ORIGINALE
CATALYTIC HOMOLOGATED LINK PIPE
FOR ORIGINAL COLLECTOR

53071KZ



RACCORDO RACING
PER COLLETTORE ORIGINALE
RACING LINK PIPE
FOR ORIGINAL COLLECTOR

53071MI



VEHICLE TYPE: SJ06

THUNDER
CARBON END CAP

	HOMOL.
TITANIUM	71753PK



COLLETTORI CATALITICI OMOLOGATI
HOMOLOGATED CATALYZED COLLECTORS

71390KZ *



COLLETTORI RACING
RACING COLLECTORS

71390MI *



RACE-TECH
CARBON END CAP

	HOMOL.
TITANIUM	73507PK
ALUMINIUM	73507AK
ALUMINIUM "DARK"	73507AKN



* **COMPLETI DI SET RULLI VARIATORE**
VARIATOR ROLLS ARE INCLUDED



← **Fitment** - The continuous line means that it is necessary to fit all the components

← - - - **Option for fitment** - The dotted line means that it is not needed to fit all the components



VEHICLE TYPE: **SJ09**

THUNDER CARBON END CAP

	HOMOL.
TITANIUM	71753PK

RACE-TECH CARBON END CAP

	HOMOL.
TITANIUM	73507PK
ALUMINIUM	73507AK
ALUMINIUM "DARK"	73507AKN

3



8



COLLETTORI CATALITICI OMOLOGATI
HOMOLOGATED CATALYZED COLLECTORS
71457KZ



COLLETTORI RACING
RACING COLLECTORS
71457MI



Fitment - The continuous line means that it is necessary to fit all the components



Option for fitment - The dotted line means that it is not needed to fit all the components



VEHICLE TYPE: **SJ14**

VEHICLE TYPE: **SJ18**

INDY RACE CARBON END CAP

	ECE	HOMOL.
TITANIUM	73521PKW	
TITANIUM "DARK"	73521PKNW	



EC

CATALIZZATORE OMOLOGATO
HOMOLOGATED CATALYST
11053KZ



⚠ ATTENZIONE · L'OMOLOGAZIONE È VALIDA SOLO CON LA PRESENZA DEL CATALIZZATORE
⚠ ATTENTION · THE HOMOLOGATION IS VALID ONLY WITH THE CATALYST INCLUDED IN THE SYSTEM

RACE-TECH CARBON END CAP

	ECE	HOMOL.
TITANIUM	73514PK	
ALUMINIUM	73514AK	
ALUMINIUM "DARK"	73514AKN	

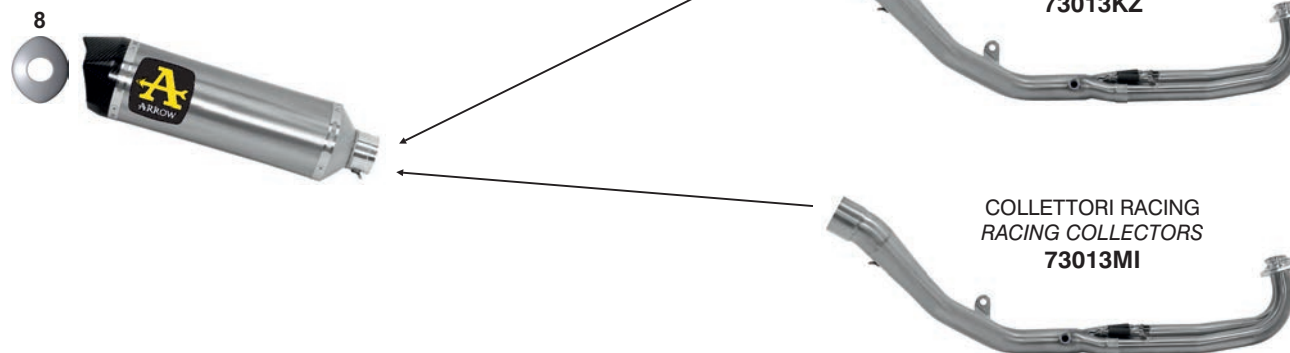

EC

COLLETTORI
CATALITICI OMOLOGATI
HOMOLOGATED CATALYZED
COLLECTORS
73013KZ

COLLETTORI RACING
RACING COLLECTORS
73013MI



← **Fitment** - The continuous line means that it is necessary to fit all the components

← - - - **Option for fitment** - The dotted line means that it is not needed to fit all the components



YAMAHA

XJ6 - XJ6 Diversion '09/15



VEHICLE TYPE: **RJ19 - RJ22**

THUNDER CARBON END CAP

	HOMOL.
TITANIUM	71761PK
ALUMINIUM	71761AK
ALUMINIUM "DARK"	71761AKN

THUNDER STEEL END CAP

	HOMOL.
ALUMINIUM	71761AO
ALUMINIUM "DARK"	71761AON



COLLETTORI CATALITICI OMOLOGATI
HOMOLOGATED CATALYZED COLLECTORS
71421KZ



COLLETTORI RACING
RACING COLLECTORS
71421MI



YAMAHA

YZF R6 '06/07



VEHICLE TYPE: **RJ11**

THUNDER CARBON CAP

	HOMOL.
TITANIUM	71701PK
ALUMINIUM	71701AK
ALUMINIUM "DARK"	71701AKN



COLLETTORI RACING
RACING COLLECTORS
71346MI



THUNDER CARBON CAP

	HOMOL.
TITANIUM	71699PK *
ALUMINIUM	71699AK *
ALUMINIUM "DARK"	71699AKN *



THUNDER STEEL CAP

	HOMOL.
ALUMINIUM	71699AO *
ALUMINIUM "DARK"	71699AON *



* **TERMINALI PER COLLETTORI ORIGINALI
SILENCERS FOR ORIGINAL COLLECTORS**



← **Fitment** - The continuous line means that it is necessary to fit all the components

← - - - **Option for fitment** - The dotted line means that it is not needed to fit all the components



VEHICLE TYPE: **RJ15**

THUNDER CARBON CAP

	HOMOL.
TITANIUM	71701PK
ALUMINIUM	71701AK
ALUMINIUM "DARK"	71701AKN



COLLETTORI RACING
RACING COLLECTORS
71378MI



THUNDER CARBON CAP

	HOMOL.
TITANIUM	71699PK *
ALUMINIUM	71699AK *
ALUMINIUM "DARK"	71699AKN *



THUNDER STEEL CAP

	HOMOL.
ALUMINIUM	71699AO *
ALUMINIUM "DARK"	71699AON *



* **TERMINALI PER COLLETTORI ORIGINALI
SILENCERS FOR ORIGINAL COLLECTORS**



VEHICLE TYPE: **RJ15**

THUNDER CARBON CAP

	HOMOL.
TITANIUM	71701PK
ALUMINIUM	71701AK
ALUMINIUM "DARK"	71701AKN



COLLETTORI RACING
RACING COLLECTORS
71473MI



THUNDER CARBON CAP

	HOMOL.
TITANIUM	71699PK *
ALUMINIUM	71699AK *
ALUMINIUM "DARK"	71699AKN *



THUNDER STEEL CAP

	HOMOL.
ALUMINIUM	71699AO *
ALUMINIUM "DARK"	71699AON *



* **TERMINALI PER COLLETTORI ORIGINALI
SILENCERS FOR ORIGINAL COLLECTORS**



Fitment - The continuous line means that it is necessary to fit all the components



Option for fitment - The dotted line means that it is not needed to fit all the components



VEHICLE TYPE: **RJ27**

PRO-RACE STEEL END CAP

	ECE	HOMOL.
NICHROM	71863PRI *	
NICHROM "DARK"	71863PRN *	

THUNDER CARBON END CAP

	ECE	HOMOL.
TITANIUM	71863PK *	
ALUMINIUM	71863AK *	
ALUMINIUM "DARK"	71863AKN *	



COLLETTORI RACING
RACING COLLECTORS
71670MI *



* **TUTTI I COMPONENTI SONO INTERCAMBIABILI
CON QUELLI ORIGINALI**
**ALL THE COMPONENTS ARE INTERCHANGEABLE
WITH THE ORIGINAL ONES**

KIT COMPLETO / FULL SYSTEM COMPETITION "EVO"

WORKS TITANIUM SILENCER
WITH CARBON END CAP AND dB-KILLER
ø48/54mm. TITANIUM LINK PIPE (EVO)
ø45/60mm. TITANIUM LINK PIPE (EVO-2)
TITANIUM OR STEEL COLLECTORS



KIT COMPLETO / FULL SYSTEM COMPETITION "WSS"

INDY RACE TITANIUM SILENCER
WITH CARBON END CAP AND dB-KILLER
ø45/60mm. TITANIUM LINK PIPE
TITANIUM OR STEEL COLLECTORS



COMPETITION "EVO"

	CARBON CAP
FULL TITANIUM	71197CKZ
STEEL COLLECT.	71196CKZ

COMPETITION "EVO-2"

	CARBON CAP
FULL TITANIUM	71197CKR
STEEL COLLECT.	71196CKR

COMPETITION "WSS"

	CARBON CAP
FULL TITANIUM	71218CKZ
STEEL COLLECT.	71217CKZ



Fitment - The continuous line means that it is necessary to fit all the components



Option for fitment - The dotted line means that it is not needed to fit all the components



VEHICLE TYPE: **DM01**

3

**THUNDER
STEEL END CAP**

	9	HOMOL.
TITANIUM		72603PO
ALUMINIUM		72603AO
ALUMINIUM "DARK"		72603AON



TERMINALI PER COLLETTORI ORIGINALI
SILENCERS FOR ORIGINAL COLLECTORS



← **Fitment** - The continuous line means that it is necessary to fit all the components

← - - - - - **Option for fitment** - The dotted line means that it is not needed to fit all the components



VEHICLE TYPE: **DM07**

INDY RACE CARBON END CAP

	ECE	HOMOL.
TITANIUM	72626PK *	
ALUMINIUM	72626AK *	
ALUMINIUM "DARK"	72626AKN *	

INDY RACE TITANIUM END CAP

	ECE	HOMOL.
TITANIUM	72626PO *	
ALUMINIUM	72626AO *	
ALUMINIUM "DARK"	72626AON *	

INDY RACE STEEL END CAP

	ECE	HOMOL.
TITANIUM	72628PO *	
ALUMINIUM	72628AO *	
ALUMINIUM "DARK"	72628AON *	



COLLETTORI RACING IN TITANIO
TITANIUM RACING COLLECTORS
72161PD *

COLLETTORI RACING
IN ACCIAIO INOX
STAINLESS STEEL
RACING COLLECTORS
72160PD *



* **TUTTI I COMPONENTI SONO INTERCAMBIABILI CON QUELLI ORIGINALI**
ALL THE COMPONENTS ARE INTERCHANGEABLE WITH THE ORIGINAL ONES

PROTEZIONE PARATACCO IN CARBONIO
CARBON FIBRE HEEL GUARD
11006MI *



DB-KILLER / SPARK ARRESTER
PER FONDELLO CARBY
FOR CARBON END CAP
12009PD



DB-KILLER / SPARK ARRESTER
PER FONDELLO TITANIO
FOR TITANIUM END CAP
12008PD



DB-KILLER / SPARK ARRESTER
PER FONDELLO INOX
FOR STEEL END CAP
12010PD



← **Fitment** - The continuous line means that it is necessary to fit all the components



← **Option for fitment** - The dotted line means that it is not needed to fit all the components



VEHICLE TYPE: **DM11**

INDY RACE CARBON END CAP

	ECE	HOMOL.
TITANIUM	72626PK *	
ALUMINIUM	72626AK *	
ALUMINIUM "DARK"	72626AKN *	

INDY RACE TITANIUM END CAP

	ECE	HOMOL.
TITANIUM	72626PO *	
ALUMINIUM	72626AO *	
ALUMINIUM "DARK"	72626AON *	

INDY RACE STEEL END CAP

	ECE	HOMOL.
TITANIUM	72628PO *	
ALUMINIUM	72628AO *	
ALUMINIUM "DARK"	72628AON *	



COLLETTORI RACING IN TITANIO
TITANIUM RACING COLLECTORS
72185PD *

COLLETTORI RACING
IN ACCIAIO INOX
STAINLESS STEEL
RACING COLLECTORS
72184PD *



*** TUTTI I COMPONENTI SONO INTERCAMBIABILI CON QUELLI ORIGINALI**
ALL THE COMPONENTS ARE INTERCHANGEABLE WITH THE ORIGINAL ONES

PROTEZIONE PARATACCO IN CARBONIO
CARBON FIBRE HEEL GUARD
11006MI *



DB-KILLER / SPARK ARRESTER
PER FONDELLO CARBY
FOR CARBON END CAP
12009PD



DB-KILLER / SPARK ARRESTER
PER FONDELLO TITANIO
FOR TITANIUM END CAP
12008PD



DB-KILLER / SPARK ARRESTER
PER FONDELLO INOX
FOR STEEL END CAP
12010PD



← **Fitment** - The continuous line means that it is necessary to fit all the components

← **Option for fitment** - The dotted line means that it is not needed to fit all the components



YAMAHA

XSR 700 '16/20

EURO4



VEHICLE TYPE: RM11 - RM12

REBEL
CARBON END CAP

	ECE	HOMOL.
TITANIUM		71843JR
NICHROM "DARK"		71843JRN

10



EC
COLLETTORI
CATALITICI OMOLOGATI
CATALYTIC HOMOLOGATED
COLLECTORS
71642KZ



COLLETTORI RACING
RACING COLLECTORS
71642MI



YAMAHA

XSR 700 '21

EURO5



VEHICLE TYPE: RM36

REBEL SILENCER

	ECE	HOMOL.
CARBON END CAP		74509RB
ALUMINIUM END CAP		74509RBA
ALUM.DARK END CAP		74509RBN

10



EC
COLLETTORI
CATALITICI OMOLOGATI
CATALYTIC HOMOLOGATED
COLLECTORS
71761KZ



COLLETTORI RACING
RACING COLLECTORS
71642MI



Fitment - The continuous line means that it is necessary to fit all the components



Option for fitment - The dotted line means that it is not needed to fit all the components



185



VEHICLE TYPE: **RM30**

X-KONE CARBON END CAP

ECE HOMOL.	
NICHROM	71817XKI
NICHROM "DARK"	71817XKN

THUNDER CARBON END CAP

ECE HOMOL.	
TITANIUM	71817PK
CARBON FIBRE	71817MK
ALUMINIUM	71817AK
ALUMINIUM "DARK"	71817AKN

THUNDER STEEL END CAP

ECE HOMOL.	
ALUMINIUM	71817AO
ALUMINIUM "DARK"	71817AON

PRO-RACE TITANIUM END CAP

RACING	
FULL TITANIUM	71156PR

PRO-RACE STEEL END CAP

RACING	
NICHROM	71156PRI
NICHROM "DARK"	71156PRN

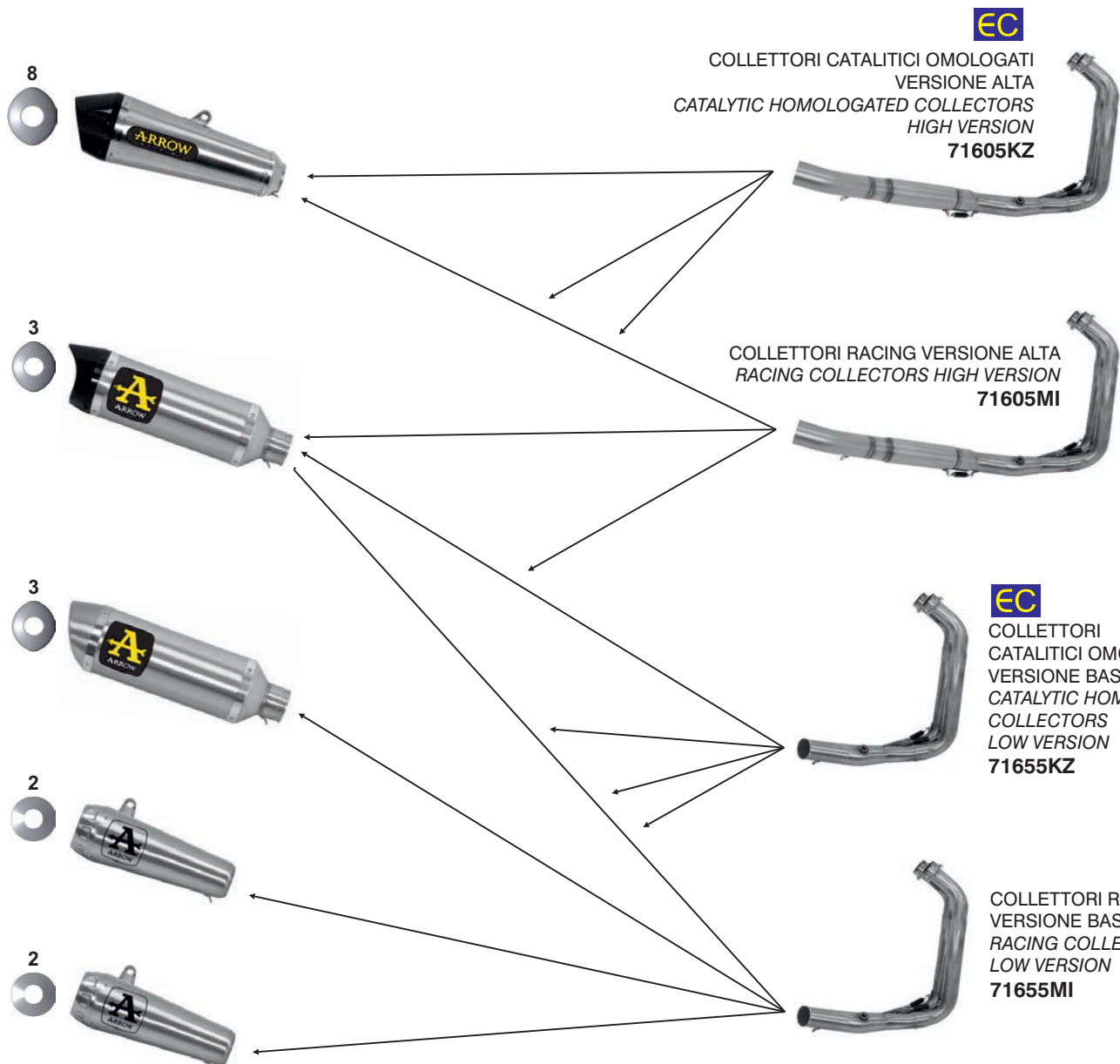

← **Fitment** - The continuous line means that it is necessary to fit all the components

← - - - **Option for fitment** - The dotted line means that it is not needed to fit all the components



VEHICLE TYPE: RM30

REBEL CARBON END CAP

	ECE	HOMOL.
TITANIUM	71843JR	
NICHROM "DARK"	71843JRN	



EC
COLLETTORI
CATALITICI OMOLOGATI
PER TERMINALI REBEL
CATALYTIC HOMOLOGATED
COLLECTORS
FOR REBEL SILENCERS
71642KZ



COLLETTORI RACING
PER TERMINALI REBEL
RACING COLLECTORS
FOR REBEL SILENCERS
71642MI



WORKS CARBON END CAP

	ECE	HOMOL.
TITANIUM	71920PK *	
NICHROM "DARK"	71920PKN *	



EC
COLLETTORI
CATALITICI OMOLOGATI
PER TERMINALI WORKS
CATALYTIC HOMOLOGATED
COLLECTORS
FOR WORKS SILENCERS
71735KZ *



COLLETTORI RACING
PER TERMINALI WORKS
RACING COLLECTORS
FOR WORKS SILENCERS
71735MI *



* **QUESTO KIT NON MONTA CON IL CAVALLETTO CENTRALE**
THIS SYSTEM DOES NOT FIT TO CENTRAL STAND



Fitment - The continuous line means that it is necessary to fit all the components



Option for fitment - The dotted line means that it is not needed to fit all the components



VEHICLE TYPE: **RM04 - RM17 - RM18**

VEHICLE TYPE: **RM14 - RM15**

X-KONE CARBON END CAP

ECE HOMOL.	
NICHROM	71817XKI
NICHROM "DARK"	71817XKN

THUNDER CARBON END CAP

ECE HOMOL.	
TITANIUM	71817PK
CARBON FIBRE	71817MK
ALUMINIUM	71817AK
ALUMINIUM "DARK"	71817AKN

THUNDER STEEL END CAP

ECE HOMOL.	
ALUMINIUM	71817AO
ALUMINIUM "DARK"	71817AON

REBEL CARBON END CAP

ECE HOMOL.	
TITANIUM	71843JR
NICHROM "DARK"	71843JRN



8



3



3



10

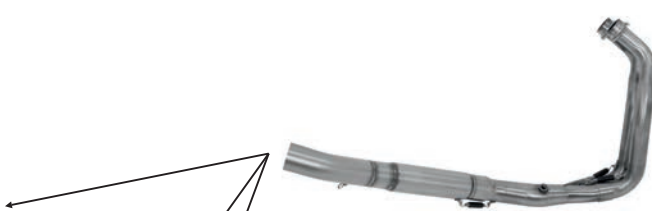

5 EC
COLLETTORI CATALITICI OMOLOGATI
VERSIONE ALTA
CATALYTIC HOMOLOGATED COLLECTORS
HIGH VERSION
71605KZ

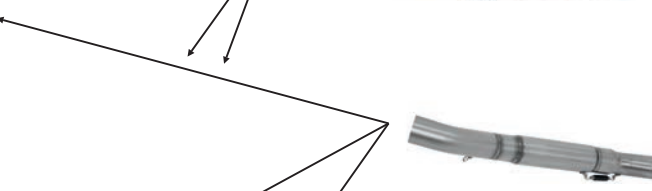

COLLETTORI RACING
VERSIONE ALTA
RACING COLLECTORS
HIGH VERSION
71605MI

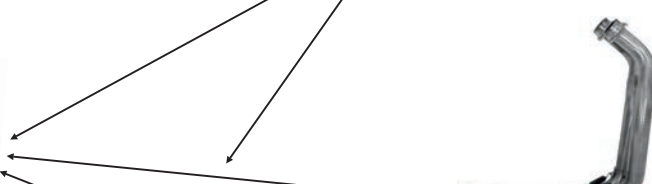

5 EC
COLLETTORI CATALITICI OMOLOGATI
VERSIONE BASSA
CATALYTIC HOMOLOGATED COLLECTORS
LOW VERSION
71655KZ

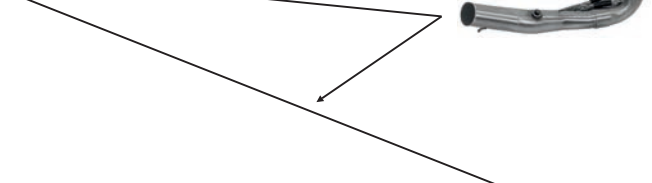

COLLETTORI RACING
VERSIONE BASSA
RACING COLLECTORS
LOW VERSION
71655MI

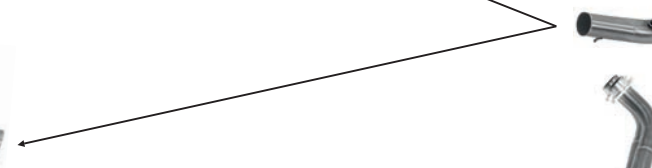

5 EC
COLLETTORI CATALITICI OMOLOGATI
PER TERMINALI REBEL
CATALYTIC HOMOLOGATED COLLECTORS
FOR REBEL SILENCERS
71642KZ



COLLETTORI RACING
PER TERMINALI REBEL
RACING COLLECTORS
FOR REBEL SILENCERS
71642MI



← **Fitment** - The continuous line means that it is necessary to fit all the components

← - - - **Option for fitment** - The dotted line means that it is not needed to fit all the components



VEHICLE TYPE: **RM33**

THUNDER CARBON END CAP

	 HOMOL.
TITANIUM	71930PK
CARBON FIBRE	71930MK
ALUMINIUM	71930AK
ALUMINIUM "DARK"	71930AKN



**KIT COMPLETO RACING
RACING FULL SYSTEM
PRO-RACE TITANIUM SILENCER
WITH TITANIUM END CAP
WITH dB-KILLER
STEEL COLLECTORS
71037GP ***

3

3

4

2



COLLETTORI
CATALITICI OMOLOGATI
PER TERMINALI THUNDER
CATALYTIC HOMOLOGATED
COLLECTORS
FOR THUNDER SILENCERS
71758KZ

COLLETTORI RACING
PER TERMINALI THUNDER
RACING COLLECTORS
FOR THUNDER SILENCERS
71758MI

COLLETTORI
CATALITICI OMOLOGATI
PER TERMINALI WORKS
CATALYTIC HOMOLOGATED
COLLECTORS
FOR WORKS SILENCERS
71735KZ *

COLLETTORI RACING
PER TERMINALI WORKS
RACING COLLECTORS
FOR WORKS SILENCERS
71735MI *



* **QUESTO KIT NON MONTA CON IL CAVALLETTO CENTRALE
THIS SYSTEM DOES NOT FIT TO CENTRAL STAND**



← **Fitment** - The continuous line means that it is necessary to fit all the components



← **Option for fitment** - The dotted line means that it is not needed to fit all the components



YAMAHA

MTX 850 Niken '18/20

EURO4



VEHICLE TYPE: RN58

THUNDER CARBON END CAP

	ECE	HOMOL.
ALUMINIUM	71900AK	
ALUMINIUM "DARK"	71900AKN	

THUNDER STEEL END CAP

	ECE	HOMOL.
ALUMINIUM	71900AO	
ALUMINIUM "DARK"	71900AON	



EC

COLLETTORI
CATALITICI OMOLOGATI
CATALYTIC HOMOLOGATED
COLLECTORS
71716KZ



YAMAHA

XSR 900 '16/20

EURO4



VEHICLE TYPE: RN43

REBEL CARBON END CAP

	ECE	HOMOL.
TITANIUM	71849JR	
STEEL "DARK"	71849JRN	



EC

COLLETTORI
CATALITICI OMOLOGATI
CATALYTIC HOMOLOGATED
COLLECTORS
71620KZ



← **Fitment** - The continuous line means that it is necessary to fit all the components

← - - - - **Option for fitment** - The dotted line means that it is not needed to fit all the components



190



VEHICLE TYPE: **RN29 - RN43**

VEHICLE TYPE: **RN57**

VEHICLE TYPE: **RN28 - RN43 - RN57**

PRO-RACE STEEL END CAP

RACING	
NICHROM	71215PRI
NICHROM "DARK"	71215PRN

X-KONE CARBON END CAP

ECE HOMOL.	
NICHROM	71812XKI

THUNDER CARBON END CAP

ECE HOMOL.	
TITANIUM	71812PK
CARBON FIBRE	71812MK
ALUMINIUM	71812AK
ALUMINIUM "DARK"	71812AKN

THUNDER STEEL END CAP

ECE HOMOL.	
ALUMINIUM	71812AO
ALUMINIUM "DARK"	71812AON



COLLETTORI
CATALITICI OMOLOGATI
CATALYTIC HOMOLOGATED
COLLECTORS
71620KZ

COLLETTORI RACING
RACING COLLECTORS
71620MI



Fitment - The continuous line means that it is necessary to fit all the components



Option for fitment - The dotted line means that it is not needed to fit all the components



VEHICLE TYPE: **RN69**



*** | COLLETTORI VERSIONE ALTA MONTANO SOLO CON TERMINALI WORKS
HIGH -MOUNT COLLECTORS FIT ONLY WITH WORKS SILENCERS**

**WORKS
CARBON END CAP**

	ECE	HOMOL.
TITANIUM		71932PK
NICHROM "DARK"		71932PKN



**THUNDER
CARBON END CAP**

	ECE	HOMOL.
TITANIUM		71931PK
CARBON FIBRE		71931MK
ALUMINIUM		71931AK
ALUMINIUM "DARK"		71931AKN



EC

COLLETTORI CATALITICI OMOLOGATI
VERSIONE ALTA
HIGH-MOUNT CATALYTIC
HOMOLOGATED COLLECTORS
71760KZ *



COLLETTORI RACING
VERSIONE ALTA
HIGH-MOUNT
RACING COLLECTORS
71760MI *



EC

COLLETTORI CATALITICI OMOLOGATI
VERSIONE BASSA
LOW-MOUNT CATALYTIC
HOMOLOGATED COLLECTORS
71759KZ



COLLETTORI RACING
VERSIONE BASSA
LOW-MOUNT
RACING COLLECTORS
71759MI



← **Fitment** - The continuous line means that it is necessary to fit all the components

← - - - - **Option for fitment** - The dotted line means that it is not needed to fit all the components



YAMAHA

Tracer 9 GT '21 EURO5 EC ECE

VEHICLE TYPE: **RN70**

**WORKS
CARBON END CAP**

	EC ECE HOMOL.
TITANIUM	71935PK
NICHROM "DARK"	71935PKN

**THUNDER
CARBON END CAP**

	EC ECE HOMOL.
TITANIUM	71934PK
CARBON FIBRE	71934MK
ALUMINIUM	71934AK
ALUMINIUM "DARK"	71934AKN



EC
COLLETTORI CATALITICI OMOLOGATI
VERSIONE BASSA
LOW-MOUNT CATALYTIC
HOMOLOGATED COLLECTORS
71762KZ



COLLETTORI RACING
VERSIONE BASSA
LOW-MOUNT
RACING COLLECTORS
71762MI



YAMAHA

XV 950 R '14/16

VEHICLE TYPE: **VN03**

REBEL SILENCER

	EC ECE HOMOL.
CARBON END CAP	74502RB
ALUMINIUM END CAP	74502RBA
ALUM.DARK END CAP	74502RBN



**KIT TERMINALE OMOLOGATO
REBEL «DARK»**
CON FONDELLO IN CARBONIO,
ALLUMINIO LUCIDO o ALLUMINIO «DARK»
**SILENCER KIT HOMOLOGATED
REBEL «DARK»**
WITH CARBON FIBRE, ALUMINIUM POLISH
or ALUMINIO «DARK» END CAP

**TERMINALI PER COLLETTORI ORIGINALI
SILENCERS FOR ORIGINAL COLLECTORS**



Fitment - The continuous line means that it is necessary to fit all the components



Option for fitment - The dotted line means that it is not needed to fit all the components



193



VEHICLE TYPE: **VN07**

10



REBEL SILENCER

		HOMOL.
CARBON END CAP		74503RB
ALUMINIUM END CAP		74503RBA
ALUM.DARK END CAP		74503RBN

RACCORDO CATALITICO OMOLOGATO
PER COLLETTORI ORIGINALI
CATALYTIC HOMOLOGATED LINK PIPE
FOR ORIGINAL COLLECTORS
74001KZ



RACCORDO RACING
PER COLLETTORI ORIGINALI
RACING LINK PIPE
FOR ORIGINAL COLLECTORS
74001MI



VEHICLE TYPE: **RN16**

7



**MAXI RACE-TECH
CARBON END CAP**

		HOMOL.
TITANIUM		71708PK
CARBON FIBRE		71708MK
ALUMINIUM		71708AK
ALUMINIUM "DARK"		71708AKN

RACCORDO
LINK PIPE
71343MI *



COLLETTORI RACING
RACING COLLECTORS
71344MI



* **IL RACCORDO 71343MI MONTA ANCHE SU COLLETTORI ORIGINALI**
71343MI LINK PIPE ALSO FITS TO ORIGINAL COLLECTORS



Fitment - The continuous line means that it is necessary to fit all the components



Option for fitment - The dotted line means that it is not needed to fit all the components



YAMAHA

MT-10 '16/20

EURO4

EC ECE

CARB

VEHICLE TYPE: **RN45**

INDY RACE
CARBON END CAP

	ECE	HOMOL.
TITANIUM	71852PK *#	
ALUMINIUM	71852AK *#	
ALUMINIUM "DARK"	71852AKN *#	



RACCORDO CENTRALE NON CATALITICO
NON CATALYTIC CENTRAL LINK PIPE
71656MI *



! # TERMINALI OMOLOGATI SENZA dB-KILLER
SILENCERS ARE HOMOLOGATED WITHOUT DB-KILLER

! * TUTTI I COMPONENTI SONO INTERCambiabili
CON QUELLI ORIGINALI
ALL THE COMPONENTS ARE INTERCHANGEABLE
WITH THE ORIGINAL ONES

YAMAHA

YZF R1 '04/06

9e5
2006/120/CE

CARB

VEHICLE TYPE: **RN12**



THUNDER
STEEL END CAP

	HOMOL.
ALUMINIUM	71687AO *

RACC. NON CATALITICO
IN SOSTITUZIONE DI QUELLO
CATALITICO ORIGINALE
NON CATALYZED LINK PIPE
REPLACES CATALYZED
ORIGINAL LINK PIPE
71287MI #



COLLETTORI RACING
RACING COLLECTORS
71288MI



! * I TERMINALI MONTANO ANCHE
SU RACC. CATALITICO ORIGINALE
SILENCERS ALSO FIT TO ORIGINAL
CATALYZED LINK PIPE

! # IL RACCORDO MONTA ANCHE
SU COLLETTORI ORIGINALI
71287MI LINK PIPE ALSO
FITS TO ORIGINAL COLLECTORS



Fitment - The continuous line means that
it is necessary to fit all the components



Option for fitment - The dotted line means that
it is not needed to fit all the components



195



VEHICLE TYPE: **RN19**

THUNDER CARBON END CAP

	HOMOL.
CARBON FIBRE	71719MK *
ALUMINIUM	71719AK *
ALUMINIUM "DARK"	71719AKN *



RACCORDO CENTRALE
CENTRAL LINK PIPE
71362MI #



COLLETTORI RACING
RACING COLLECTORS
71364MI



RACCORDO PER
COLLETTORI ORIGINALI
LINK PIPE FOR
ORIGINAL COLLECTORS
71363MI



* **MONTANO ANCHE SU RACCORDO CATALITICO ORIGINALE**
SILENCER ALSO FITS TO ORIGINAL CATALYZED LINK PIPE



IL RACCORDO 71362MI ABBINATO AL 71363MI ELIMINA IL CATALIZZATORE
ORIGINALE E MONTA ANCHE CON TERMINALI ORIGINALI
71362MI LINK PIPE COMBINATED WITH 71363MI LINK PIPE ELIMINATES
ORIGINAL CATALYST AND FITS ALSO TO ORIGINAL SILENCERS

VEHICLE TYPE: **RN32**

INDY RACE CARBON END CAP

	HOMOL.
TITANIUM	71829PK *#
ALUMINIUM	71829AK *#
ALUMINIUM "DARK"	71829AKN *#

4



RACCORDO CENTRALE NON CATALITICO
NON CATALYTIC CENTRAL LINK PIPE
71630MI



TERMINALI OMOLOGATI SENZA dB-KILLER
SILENCERS ARE HOMOLOGATED WITHOUT DB-KILLER



* **I TERMINALI MONTANO ANCHE SU RACCORDO CATALITICO ORIGINALE**
SILENCERS ALSO FIT TO ORIGINAL CATALYTIC LINK PIPE



← **Fitment** - The continuous line means that it is necessary to fit all the components

← - - - - **Option for fitment** - The dotted line means that it is not needed to fit all the components



VEHICLE TYPE: **RN49 - RN65**

INDY RACE CARBON CAP

	ECE	HOMOL.
TITANIUM	71829PK	*#
ALUMINIUM	71829AK	*#
ALUMINIUM "DARK"	71829AKN	*#



RACCORDO CENTRALE NON CATALITICO
NON CATALYTIC CENTRAL LINK PIPE
71672MI



⚠ * I TERMINALI MONTANO ANCHE SU RACCORDO CATALITICO ORIGINALE
SILENCERS ALSO FIT TO ORIGINAL CATALYTIC LINK PIPE

⚠ # TERMINALI OMOLOGATI SENZA dB-KILLER
SILENCERS ARE HOMOLOGATED WITHOUT DB-KILLER



KIT INTERMEDIO / HALF SYSTEM
RACING
RACE-TECH TITANIUM SILENCER
TITANIUM LINK PIPE ø48/60mm.
71179HK

COMPETITION

	CARBON CAP
FULL TITANIUM	71179CKZ
STEEL COLLECT.	71178CKZ



KIT COMPLETO / FULL SYSTEM
COMPETITION
RACE-TECH TITANIUM SILENCER
TITANIUM LINK PIPE ø48/60mm.
STAINLESS STEEL OR
TITANIUM COLLECTORS



KIT INTERMEDIO / HALF SYSTEM
RACING
INDY RACE TITANIUM SILENCER
TITANIUM LINK PIPE ø48/60mm.
71179HKR

COMPETITION "SBK"

	CARBON CAP
FULL TITANIUM	71179CKR
STEEL COLLECT.	71178CKR



KIT COMPLETO / FULL SYSTEM
COMPETITION "SBK"
RACE-TECH TITANIUM SILENCER
TITANIUM LINK PIPE ø48/60mm.
STAINLESS STEEL OR
TITANIUM COLLECTORS



KIT INTERMEDIO / HALF SYSTEM
RACING
PRO-RACE TITANIUM SILENCER
TITANIUM LINK PIPE ø48/60mm.
71179HCP

COMPETITION "EVO"

	TITANIUM CAP
FULL TITANIUM	71211CKZ
STEEL COLLECT.	71210CKZ



KIT COMPLETO / FULL SYSTEM
COMPETITION "EVO"
WORKS TITANIUM SILENCER
TITANIUM LINK PIPE ø52/60mm.
STAINLESS STEEL OR
TITANIUM COLLECTORS



← **Fitment** - The continuous line means that it is necessary to fit all the components



← - - - **Option for fitment** - The dotted line means that it is not needed to fit all the components



VEHICLE TYPE: **DP01 - DP04 - DP07**



**MAXI RACE-TECH
CARBON END CAP**

	ECE	HOMOL.
TITANIUM		72614PK *
ALUMINIUM		72614AK *
ALUMINIUM "DARK"		72614AKN *



**COLLETTORI RACING
RACING COLLECTORS
72095PD**



* **I TERMINALI MONTANO ANCHE SU COLLETTORI ORIGINALI**
SILENCERS ALSO FIT TO ORIGINAL COLLECTORS

VEHICLE TYPE: **RP23**

**RACE-TECH
CARBON END CAP**

	HOMOL.
TITANIUM	71845PK
CARBON FIBRE	71845MK
ALUMINIUM	71845AK
ALUMINIUM "DARK"	71845AKN



**RACCORDI PER COLLETTORI ORIGINALI
LINK PIPES FOR ORIGINAL COLLECTORS
71644MI**



Fitment - The continuous line means that it is necessary to fit all the components



Option for fitment - The dotted line means that it is not needed to fit all the components



VEHICLE TYPE: **RP19**

X-KONE CARBON END CAP

9		HOMOL.
NICHROM	71844XKI	



RACE-TECH CARBON END CAP

9		HOMOL.
TITANIUM	71844PK	
CARBON FIBRE	71844MK	
ALUMINIUM	71844AK	
ALUMINIUM "DARK"	71844AKN	



PRO-RACING STEEL END CAP

9		HOMOL.
NICHROM	71844PRI *	
NICHROM "DARK"	71844PRN *	



5
RACCORDO CATALITICO OMOLOGATO
PER COLLETTORI ORIGINALI
CATALYTIC HOMOLOGATED LINK PIPE
FOR ORIGINAL COLLECTORS
71643KZ



RACCORDO RACING PER
COLLETTORI ORIGINALI
LINK PIPE FOR
ORIGINAL COLLECTORS
71643MI



5
CATALIZZATORE OMOLOGATO
HOMOLOGATED CATALYST
11020KZ



*** I TERMINALI PRO-RACING MONTANO DIRETTAMENTE SU COLLETTORI ORIGINALI
PRO-RACING SILENCERS FIT TO ORIGINAL COLLECTORS WITHOUT LINK PIPE**



**ATTENZIONE · L'OMOLOGAZIONE È VALIDA SOLO CON LA PRESENZA DEL CATALIZZATORE
ATTENTION · THE HOMOLOGATION IS VALID ONLY WITH THE CATALYST INCLUDED IN THE SYSTEM**



Fitment - The continuous line means that it is necessary to fit all the components



Option for fitment - The dotted line means that it is not needed to fit all the components



ENDURO 4T

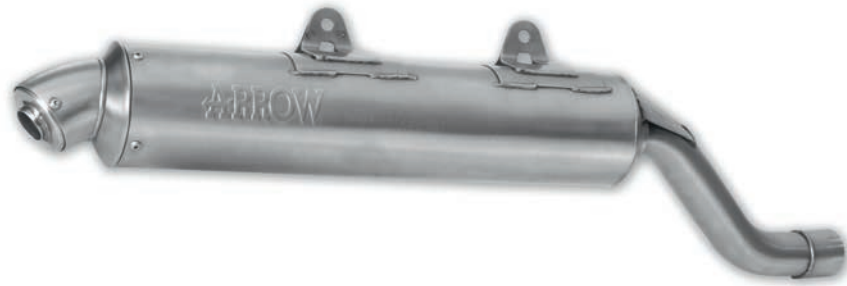

		HOM.	PARIS DAKAR REPLICA	COLLETTORI RACING RACING COLLECTORS
HONDA	Vehicle Type		Part #	Part #
<i>XR 600 R '91/98</i>			72006PD	---
<i>XL 600 V TRANSALP '87/97</i>			72024PD	---
<i>NX 650 DOMINATOR '87/93</i>	RD02 B		72602PD	---
<i>NX 650 DOMINATOR '94/95</i>	RD02		72633PD	---
<i>XRV 750 Africa Twin '90/92</i>	RD04		72604PD	---
<i>XRV 750 Africa Twin '93/95</i>	RD07		72605PD	72093PD
<i>XRV 750 Africa Twin '96/04</i>	RD07 A		72639PD	72093PD
SUZUKI	Vehicle Type		Part #	Part #
<i>DR 350 S '90/95</i>			72017PD	---
<i>DR 600 R / S '85/90</i>	SN 41 A		72640PD	72124PD
YAMAHA	Vehicle Type		Part #	Part #
<i>TT 600 - XT 600 Tenerè '86/92</i>	59X / 3TB / 34L / 2KF / 1VJ / 3AJ / 55W		72608PD	---
<i>XT 600 E '90/94</i>			72011PD	---
<i>XT 600 E '95/01</i>			72034PD	---
<i>TT 600 R '99/01 - TT 600 E '00</i>			72047PD	---
<i>XTZ 750 SuperTenerè '89/94</i>	3LD		72610PD	72091PD



SILENZIATORI UNIVERSALI

UNIVERSAL SILENCERS

SILENZIATORI UNIVERSALI GP2 - GP2 "Dark"
UNIVERSALI SILENCERS



	DIAMETRO INNESTO INNER DIAMETER	LUNGHEZZA LENGHT	DIAMETRO ESTERNO OUTER DIAMETER	CODICE PART #
GP2 (full titanium)	ø 54 mm.	200 mm.	98 mm.	71014GP
GP2 (full titanium)	ø 60 mm.	200 mm.	98 mm.	71015GP
GP2 "Dark" (inox / steel)	ø 54 mm.	200 mm.	98 mm.	71014GPI
GP2 "Dark" (inox / steel)	ø 60 mm.	200 mm.	98 mm.	71015GPI

DB-KILLER



USCITA DRITTA
STRAIGHT END PIPE



GP2
DB-KILLER



PRO-RACE
DB-KILLER



USCITA PIEGATA
BENDEED END PIPE

DIAMETRO INNESTO (A) INNER DIAMETER (A)	DIAMETRO TUBO (B) PIPE DIAMETER (B)	USCITA END PIPE	TIPO FISSAGGIO KIND OF FITTMENT	CODICE PART #
ø 45 mm.	ø 26 mm.	PIEGATA / BENDEED	SEEGER	11002DB
ø 45 mm.	ø 32 mm.	DRITTA / STRAIGHT	SEEGER	11003DB
ø 50 mm.	ø 38 mm.	PIEGATA / BENDEED	SEEGER	11004DB
ø 50 mm.	ø 35 mm.	DRITTA / STRAIGHT	SEEGER	11005DB
ø 56 mm.	ø 42,4 mm.	PIEGATA / BENDEED	SEEGER	11006DB
ø 58 mm.	ø 42,4 mm.	PIEGATA / BENDEED	SEEGER	11007DB
ø 58 mm.	ø 38 mm.	DRITTA / STRAIGHT	VITE / SCREW - GP2	11009DB
ø 68 mm.	ø 35 mm.	DRITTA / STRAIGHT	VITE / SCREW - PRO-RACE	11012DB



ACCESSORIE VARI / ACCESSORIES

PRODOTTO / PRODUCT	SPECIFICHE / SPECIFICATIONS	Part #
SILENZIATORE MECCANICO PER ENDURO 4T E PARIS DAKAR REPLICA <i>MECHANICAL SILENCER ENDURO 4 T - P.D. REPLICA</i>	Specificare il modello e l'anno di produzione della moto <i>Specify vehicle model and year of production</i>	12001PD
SILENZIATORE MECCANICO PER OFF-ROAD THUNDER <i>MECHANICAL SILENCER OFF-ROAD THUNDER</i>	Specificare il modello e l'anno di produzione della moto <i>Specify vehicle model and year of production</i>	12002PD
RICAMBIO MATERIALE FONOASSORBENTE <i>GLASS WOOL FOR SILENCER</i>	<i>Universale per silenziatori 2 Tempi e Scooter</i> <i>Universal for 2 Strokes and Scooter silencers</i>	19001UN
	Universale per terminali ENDURO 4T e Maximoto (L=450 mm.) <i>Universal for ENDURO 4T and STREET BIKES 4T silencers (L=450 mm.)</i>	19003UN
	Universale per terminali Maximoto (L=500 mm.) <i>Universal for STREET BIKES 4T silencers (L=500 mm.)</i>	19005UN
	Universale per terminali Maximoto ad alta temperatura (1200°) <i>Universal for silencers high temperatures (1200°)</i>	19006UN
	Universale per terminali RACING Maximoto <i>Universal for RACING silencers</i>	19007UN
	Universale per terminali OFF-ROAD V2 (L=450 mm.) <i>Universal for OFF-ROAD V2 silencers (L=450 mm.)</i>	19008UN
	Universale per terminali OFF-ROAD V2 (L=400 mm.) <i>Universal for OFF-ROAD V2 silencers (L=400 mm.)</i>	19009UN
	Universale per terminali OFF-ROAD V2 (L=350 mm.) <i>Universal for OFF-ROAD V2 silencers (L=350 mm.)</i>	19010UN
	Universale specifico per terminali in carbonio (L=350 mm.) <i>Universal specified for carbon fibre silencers (L=350 mm.)</i>	19011UN
	Universale specifico per terminali in carbonio (L=400 mm.) <i>Universal specified for carbon fibre silencers (L=400 mm.)</i>	19012UN
	Universale specifico per terminali in carbonio (L=450 mm.) <i>Universal specified for carbon fibre silencers (L=450 mm.)</i>	19013UN
	KIT GUARNIZIONI PER SCOOTER (5 pz.) <i>SEARING GASKETS FOR SCOOTER (5 pcs)</i>	Guarnizioni innesto cilindro per motori Minarelli <i>Cylinder gaskets for Minarelli engines</i>
Guarnizioni innesto Silenziatore per tutti i modelli <i>Universal silencer gaskets</i>		13003UN



MATERIALE PROMOZIONALE MERCHANDISING

PORTACHIAVI (10 pezzi)
KEY RING (10 pcs)
11006AR



NASTRO PORTA BADGE
PASS HOLDER
11001AR



CAPPELLO RACING ARROW
ARROW RACING CAP
CAP0040



ESPOSITORE ARROW
ARROW DISPLAY
75cm (L) x 180 cm (h)
ESP-ARR



ESPOSITORE DA BANCO PREMIUM
ARROW PREMIUM DISPLAY
41cm (L) x 20 cm (p) x 51 cm (h)
ESP-AR5



ESPOSITORE DA BANCO LIGHT
ARROW LIGHT DISPLAY
28cm (L) x 16 cm (p) x 41 cm (h)
ESP-AR4





ARROW SPECIAL PARTS S.p.A.
via Citernese 128/130 · 06016 San Giustino (PG) · ITALY
Tel +39 075 861811 · Fax +39 075 8318137
www.arrow.it · info@arrow.it