



Malaguti
IDEE IN MOTO

GRIZZLY 10" CE 2008 - 2009



TELAIO - INDICE TAVOLE

FRAME - INDEX OF THE TABLES

TAV. A	TAV. OO			

MOTORE - INDICE TAVOLE

ENGINE - INDEX OF THE TABLES

TAV. R(1)	TAV. S	TAV. T	TAV. U	

GRIZZLY 10" CE (2008 / 2009)

Gruppo termico - Albero motore

Thermal unit - Drive shaft

Nr.	Codice	Q.tà	Descrizione
-----	--------	------	-------------

1	670.001.00	1	Testa
2	670.021.00	1	Guarnizione testa
3	670.002.00	1	Cilindro nudo
4	607.208.00	1	Guarnizione scarico
5	670.022.00	1	Guarnizione base cilindro
6	670.162.00	2	Prigioniero cilindro
7	670.161.00	2	Prigioniero cilindro
8	601.184.00	2	Anello di tenuta 17 x 27 x 6
9	104.028.00	2	Cuscinetto 17 x 40 x 12
10	607.143.00	1	Gabbia a rulli 12 x 15 x 15
11	670.003.00	1	Pistone nudo
12	670.005.00	1	Segmento superiore
13	670.006.00	1	Segmento inferiore
14	670.004.00	1	Spinotto pistone
15	601.015.00	2	Seeger spinotto
16	670.163.00	2	Colonna cilindro
17	670.043.00	1	Candela ER8TC
18	670.008.00	1	Albero motore
19	604.099.00	4	Dado testa flangiato
20	616.025.00	2	Rondella
--	135.051.03	1	Motore completo Grizzly 10 CE

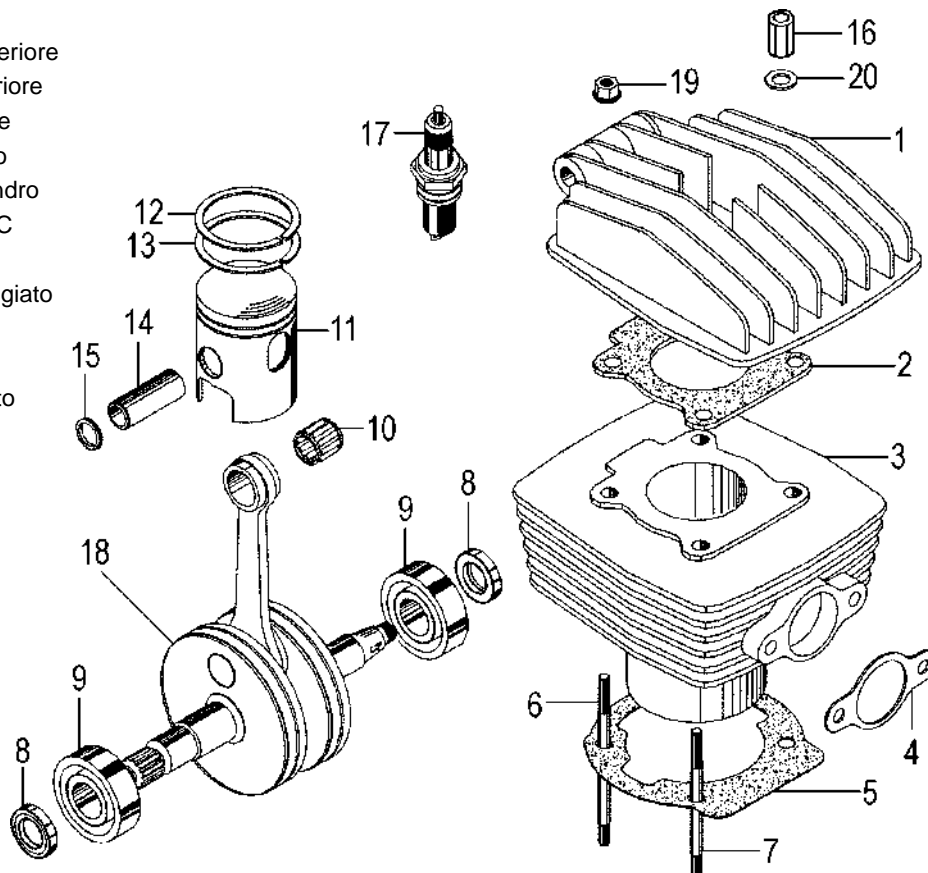

Nr.	Code	Q.ty	Description
-----	------	------	-------------

1	670.001.00	1	Head
2	670.021.00	1	Head gasket
3	670.002.00	1	Cylinder
4	607.208.00	1	Gasket
5	670.022.00	1	Cylinder gasket
6	670.162.00	2	Cylinder stud bolt
7	670.161.00	2	Cylinder stud bolt
8	601.184.00	2	Oil seal 17 x 27 x 6
9	104.028.00	2	Bearing 17 x 40 x 12
10	607.143.00	1	Roller cage 12 x 15 x 15
11	670.003.00	1	Piston
12	670.005.00	1	Piston ring (upper)
13	670.006.00	1	Piston ring (lower)
14	670.004.00	1	Piston pin
15	601.015.00	2	Piston seeger ring
16	670.163.00	2	Cylinder spacer
17	670.043.00	1	Spark plug ER8TC
18	670.008.00	1	Crankshaft
19	604.099.00	4	Head nut
20	616.025.00	2	Washer
--	135.051.03	1	Engine assy Grizzly 10 CE

Nr.	Codice	Q.tà	Descrizione
1	620.025.00	4	Vite fissaggio raccordo
2	616.147.00	4	Rondella elastica
3	616.143.00	1	Raccordo carburatore
4	670.025.00	1	Guarnizione raccordo
5	670.104.00	1	Valvola lamellare
6	620.160.00	2	Vite valvola lamellare
7	616.146.00	2	Rondella valvola
8	603.321.00	1	Carburatore completo SHA 14/12 R

Nr.	Code	Q.ty	Description
1	620.025.00	4	Fixing screw
2	616.147.00	4	Washer
3	616.143.00	1	Carburettor union
4	670.025.00	1	Gasket
5	670.104.00	1	Reed valve
6	620.160.00	2	Reed valve screw
7	616.146.00	2	Washer
8	603.321.00	1	Carburettor assy SHA 14/12 R

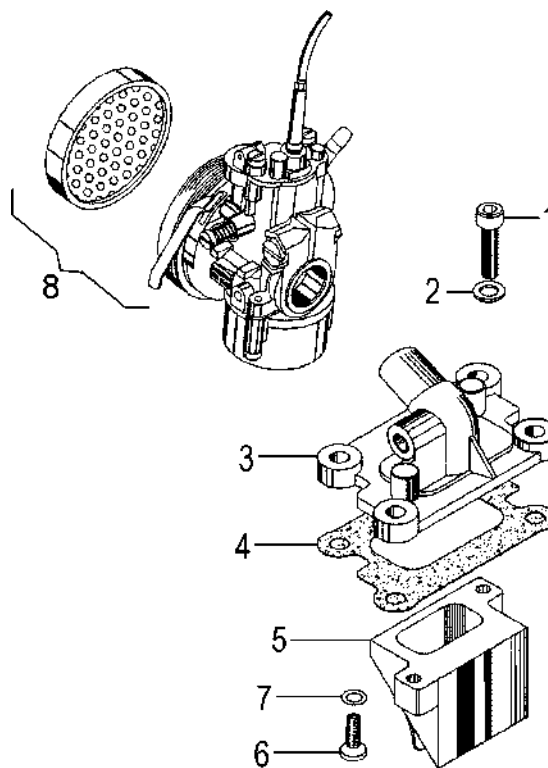

Nr.	Codice	Q.tà	Descrizione
1	601.184.00	1	Anello di tenuta 17 x 27 x 6
2	607.213.00	1	Gabbia a rulli HK 1712
3	670.063.00	1	Carter motore dx
3A	670.064.00	1	Carter motore sx
4	617.193.00	2	Spina supporto rinvio
5	670.024.00	1	Guarnizione carter
6	603.318.00	1	Cuscinetto 17 x 35 x 10
7	601.211.00	1	Seeger
8	620.033.00	1	Vite carter
9	620.031.00	7	Vite carter
--	135.051.03	1	Motore completo Grizzly 10 CE

Nr.	Code	Q.ty	Description
1	601.184.00	1	Oil seal 17 x 27 x 6
2	607.213.00	1	Roller cage HK 1712
3	670.0633.00	1	R/h crankcase
3A	670.064.00	1	L/h crankcase
4	617.193.00	2	Pin
5	670.024.00	1	Crankcase gasket
6	603.318.00	1	Bearing 17 x 35 x 10
7	601.211.00	1	Seeger
8	620.033.00	1	Screw
9	620.031.00	7	Screw
--	135.051.03	1	Engine assy Grizzly 10 CE

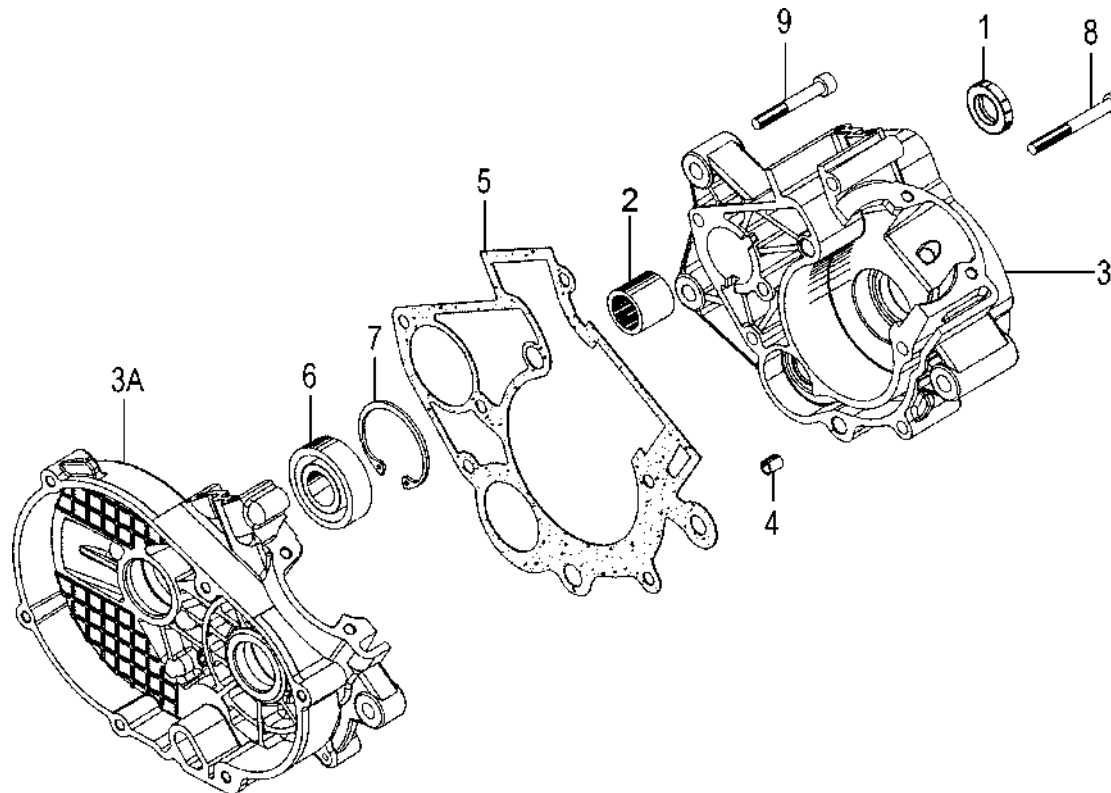

GRIZZLY 10" CE (2008 / 2009)

Trasmissione - Avviamento

Gearbox - Starter device

Nr.	Codice	Q.tà	Descrizione
-----	--------	------	-------------

1	614.145.00	1	Pignone Z 10
2	601.213.00	2	Seeger
3	616.144.00	1	Rondella
4	602.056.00	1	Boccola ingranaggio
5	670.083.00	1	Ingranaggio + campana
6	604.105.00	1	Distanziale
7	611.125.00	1	Frizione completa
8	611.115.00	1	Molla a tazza
9	609.110.00	1	Dado innesti frontali
10	670.061.00	1	Coperchio frizione
11	616.025.00	1	Rondella
12	620.041.00	1	Vite olio
13	607.030.00	1	Guarnizione
14	618.009.00	1	Tappo olio
15	670.164.00	1	Vite
16	670.101.00	1	Leva messa in moto
17	601.213.00	2	Seeger
18	601.032.00	1	Seeger
19	616.144.00	1	Rondella
20	620.027.00	6	Vite
21	670.023.00	1	Guarnizione
22	616.144.00	1	Rondella
23	670.181.00	1	O-Ring
24	670.082.00	1	Albero messa in moto
25	670.086.00	1	Molla richiamo
26	616.027.00	1	Rondella
27	601.021.00	1	Seeger
28	609.109.00	1	Ingranaggio scorrevole
29	611.114.00	1	Molla
30	618.091.00	1	Corona + albero

Nr.	Code	Q.ty	Description
-----	------	------	-------------

1	614.145.00	1	Chain sprocket Z 10
2	601.213.00	2	Seeger
3	616.144.00	1	Washer
4	602.056.00	1	Bush
5	670.083.00	1	Clutch housing + gear
6	604.105.00	1	Spacer
7	611.125.00	1	Clutch assy
8	611.115.00	1	Spring
9	609.110.00	1	Nut
10	670.061.00	1	Clutch housing cover
11	616.025.00	1	Washer
12	620.041.00	1	Oil drain plug
13	607.030.00	1	Gasket
14	618.009.00	1	Oil cap
15	670.164.00	1	Screw
16	670.101.00	1	Kick-starter lever
17	601.213.00	2	Seeger
18	601.032.00	1	Seeger
19	616.144.00	1	Washer
20	620.027.00	6	Screw
21	670.023.00	1	Gasket
22	616.144.00	1	Washer
23	601.212.00	1	O-Ring
24	670.082.00	1	Kick start shaft
25	670.086.00	1	Spring
26	616.027.00	1	Washer
27	601.021.00	1	Seeger
28	609.109.00	1	Idle gear
29	611.114.00	1	Spring
30	618.091.00	1	Gear sprocket + shaft

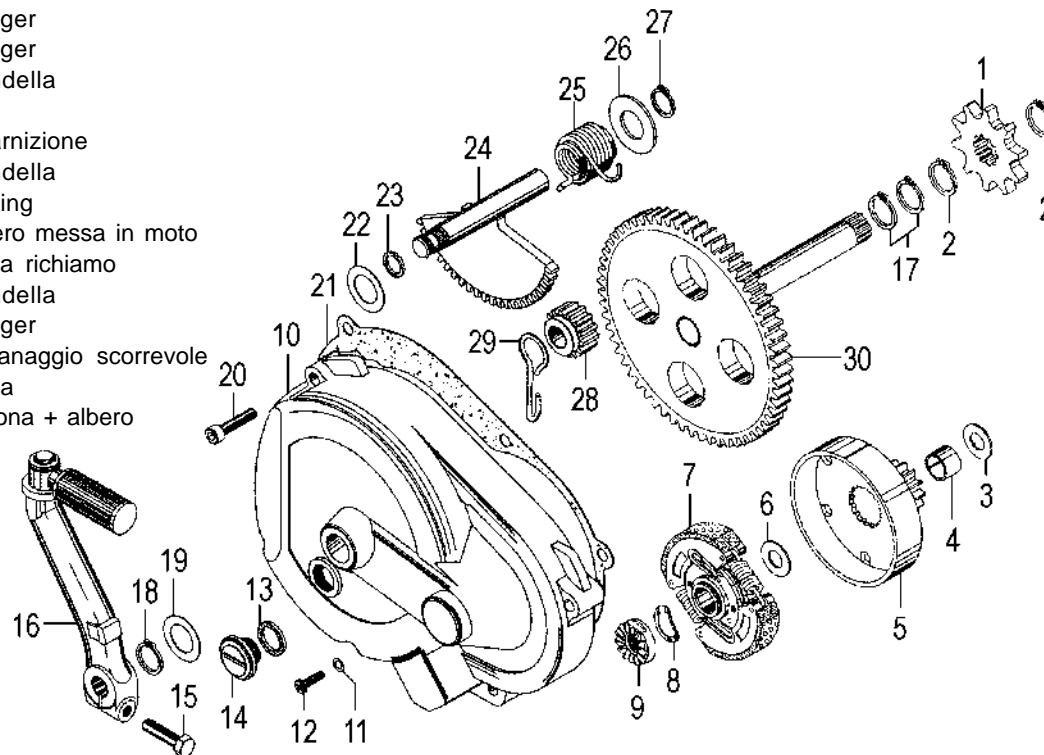

Volano - Accensione Flywheel - Ignition

Nr.	Codice	Q.tà	Descrizione
1	670.062.00	1	Coperchio volano
2	604.106.00	1	Dado volano
3	670.041.00	1	Bobina A. T.
4	670.042.00	1	Volano
5	620.068.00	1	Vite coperchio volano
6	616.029.00	4	Rondella
7	620.159.00	3	Vite coperchio volano
8	620.094.00	2	Vite bobina

Nr.	Code	Q.ty	Description
1	670.062.00	1	Flywheel cover
2	604.106.00	1	Flywheel nut
3	670.041.00	1	H. T. Coil
4	670.042.00	1	Magneto flywheel
5	620.068.00	1	Screw
6	616.029.00	4	Washer
7	620.159.00	3	Screw
8	620.094.00	2	Screw

