

[www.olympiamilano.it](http://www.olympiamilano.it)

**olympia**



*Edizione*  
**Novembre**  
**2019**

*Catalogo*  
*Ricambi*



# CONDIZIONI GENERALI DI VENDITA

## ARTICOLI

Gli articoli presenti su questo catalogo sono di produzione Europea ed Extraeuropea.

## PREZZI

I prezzi si riferiscono a merce resa franco nostro stabilimento. Sono indicativi e faremo il possibile per mantenerli inalterati. Qualora per ragioni indipendenti dalla nostra volontà vi saranno variazioni anomale di mercato, ci riterremo autorizzati a modificarli senza alcun preavviso.

## CONSEGNE E SPEDIZIONI

La merce viaggia sempre a rischio e pericolo dell'acquirente anche se venduta franco destino. Non si accettano responsabilità per eventuali ritardi delle spedizioni derivanti da cause di forza maggiore e da eventi che possano ritardare il processo di fabbricazione, quali agitazioni sindacali, mancata consegna da parte dei fornitori, difficoltà di approvvigionamento di materie prime o simili.

In mancanza di precise istruzioni, ci riserviamo la scelta dei mezzi di trasporto più adatti a nostro insindacabile giudizio con spedizione in porto assegnato.

## PAGAMENTO

I pagamenti dovranno essere eseguiti al nostro domicilio nella forma prevista dagli ordini accettati.

Sui ritardi di pagamento verranno applicati interessi al tasso bancario corrente più le spese.

La merce viaggia con "Patto di riservato dominio".

## IMBALLAGGI

Nel prezzo non è compreso l'imballo che verrà da noi fatturato a parte.

## RECLAMI

Non verranno presi in considerazione i reclami pervenuti oltre 10 giorni dal ricevimento della merce.

## RESI DI MATERIALE

La Legge 27/4/1989 n°154 ha modificato il decreto IVA n°633/72 e di conseguenza non è possibile per ragioni fiscali sostituire gratuitamente il materiale resoci con una semplice bolla di "sostituzione". L'unica procedura fiscalmente valida, e quindi da noi adottata è quella dell'accredito degli articoli resi e della fatturazione degli articoli che invieremo in sostituzione.

Affinché l'accredito sia possibile è tassativamente necessario che:

### per ragioni organizzative della nostra società:

- 1) la restituzione del materiale deve essere anticipatamente autorizzata per iscritto e per telefono dai nostri uffici commerciali. Non si possono quindi, senza preventivo consenso dell'azienda, prendere decisioni sull'argomento.
- 2) Nel caso si tratti di restituzione di materiali inviati da noi erroneamente e non conformi all'ordine, la restituzione deve avvenire entro un mese dalla data della nostra bolla. Dopodiché per nessuna ragione potrà da noi essere accettato alcun reso.
- 3) Il materiale dev'essere indirizzato al nostro magazzino (1) unicamente in porto franco, poiché gli addetti al magazzino stesso non sono autorizzati ad accettare spedizioni in porto assegnato e quindi si vedrebbero costretti a respingere le spedizioni stesse.

### per ragioni fiscali:

- 4) la restituzione della merce deve avvenire in ogni caso entro un anno solare dalla fattura di acquisto.
- 5) La bolla di accompagnamento della merce resa con causale
  - a) reso per materiale non conforme all'ordine
  - b) reso materiale per controllodeve citare i riferimenti delle fatture originarie d'acquisto per ogni articolo reso (specificare numero fattura o bolla con relativa data).

IMPORTANTE: Verranno respinti i resi che non presentino requisiti di cui ai punti 1-2-3-4-5 e precisamente verranno rifiutati oppure se ritirati rispediti in porto assegnato senza ulteriore avviso.

## CONTROVERSIE

Per qualsiasi controversia sarà competente il Foro di MILANO.





**Edizione Novembre 2019**

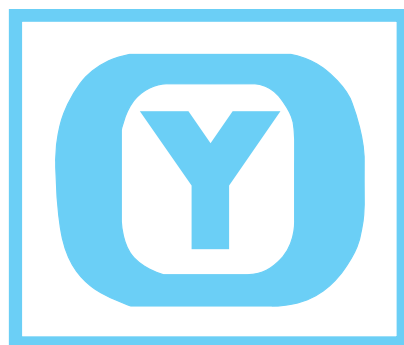

**olympia**

**OLYMPIA s.r.l.**

20148 Milano - Via Vodice, 9  
Tel. 02 4042439 - 02 48707043  
Fax 02 48702440

[olymilan@tin.it](mailto:olymilan@tin.it) • [www.olympiamilano.it](http://www.olympiamilano.it) • [olympiasrl@pec.it](mailto:olympiasrl@pec.it)

## INDICE

<b>DENOMINAZIONE</b>	<b>PAG.</b>	<b>DENOMINAZIONE</b>	<b>PAG.</b>
<b>A</b>			
ALBERI CAMBIO	<b>137</b>	CENTRALINE ELETTRONICHE	<b>201</b>
ALBERI MOTORE	<b>8</b>	CERCHIONI RUOTA	<b>180</b>
ALBERI TRASMISSIONE RUOTA	<b>131</b>	CHIAVELLE	<b>12</b>
ALZA VALVOLE	<b>250</b>	CHIAVI CANDELA	<b>126</b>
AMMORTIZZATORI	<b>38</b>	CHIOCCIOLA MOTORE	<b>88</b>
ANCORAGGIO FARO	<b>221</b>	CILINDRETTI FRENO	<b>145</b>
ANELLI FRIZIONE	<b>214</b>	CILINDRI MOTORE	<b>13</b>
ANELLI PORTA SPAZZOLA	<b>207</b>	CINGHIA BATTERIA	<b>241</b>
ASSE RUOTA POSTERIORE/ANTERIORE	<b>137</b>	CINGHIA FERMAPORTE	<b>244</b>
ASTA RUBINETTO	<b>131</b>	CINGHIA POMPA OLIO	<b>145</b>
ASTUCCIO A RULLI	<b>143</b>	CINGHIE TRAPEZIOIDALI	<b>234</b>
ATTACCO CANDELA	<b>184</b>	CLACSON	<b>99</b>
<b>B</b>			
BAULETTI	<b>88</b>	COLLETTORE ASPIRAZIONE	<b>115</b>
BIELLA COMPLETA	<b>11</b>	COMANDO FRENO/GAS	<b>61</b>
BLOCCHETTO AVVIAMENTO	<b>188</b>	COMMUTATORE LUCI	<b>212</b>
BOBINA	<b>209</b>	CONDENSATORI	<b>211</b>
BOCCHETTONE ASPIRAZIONE	<b>95</b>	CODULO	<b>129</b>
BOCCOLI DI FERMO	<b>116</b>	CONI PER PERNO RUOTAI	<b>132</b>
BOCCOLO FRIZIONE	<b>116</b>	CONTACHILOMETRI	<b>53</b>
BOCCOLO GRAFFITE	<b>250</b>	CONTATTI	<b>210</b>
BOCCOLO PORTA RUOTA LIBERA	<b>158</b>	COPERCHIO CHIOCCIOLA E VENTOLA	<b>88</b>
BOCCOLO RUOTA/SEMIASSE	<b>143</b>	COPERCHIO PRESA BASSA TENSIONE	<b>225</b>
BORDI SCUDO	<b>96</b>	COPERCHI RADDRIZZATORE DI CORRENTE	<b>225</b>
BRACCIO SOSPENSIONE	<b>36</b>	COPERCHIO CONTACHILOMETRI	<b>53</b>
BULLONE ATTACCO AMMORTIZZATORE	<b>38</b>	COPERCHIO MANUBRIO VESPA	<b>90-245</b>
BULLONE FISSA PROTEZIONE	<b>90</b>	COPERCHIO MOZZO	<b>52</b>
BULLONE FISSA MANUBRIO	<b>63</b>	COPERCHIO PRESELETTORE	<b>92</b>
BULLONE FISSA MOTORE	<b>132</b>	COPERCHIO RUOTA SCORTA	<b>231</b>
BULLONE RUOTA VESPA	<b>51</b>	COPPIA FIANCHI	<b>82-83</b>
<b>C</b>			
CALOTTE PER PERNO	<b>132</b>	COPPIA FRECCE	<b>218</b>
RUOTA CALOTTE STERZO	<b>42</b>	COPPIA INGRANAGGI COPPIA	<b>136</b>
CAMMA VOLANO	<b>158</b>	PASTIGLIE	<b>161</b>
CAMPANE FRIZIONE	<b>117</b>	COPPIA PEDALI	<b>94</b>
CARRELLO REGGIMOTO	<b>81</b>	COPPIA TAMPONI TRAVERSA	<b>230</b>
CATENE DI DISTRIBUZIONE	<b>244</b>	COPPIA TRASMISSIONE	<b>136</b>
CAVALLETTI	<b>65</b>	COPRIDADO RUOTA	<b>37</b>
CAVI CONTACHILOMETRI	<b>57</b>	COPRIFORCELLA	<b>37</b>
CAVI ELETTRICI	<b>217</b>	COPRIMANUBRIO SCOOTER	<b>82</b>
		COPRISTERZO VESPA CORNICE	<b>44</b>
		FARO CROMATE CORNICE	<b>229</b>
		FARO	<b>220</b>
		CORNICE ON-OFF	<b>48</b>
		CORNICE TARGA	<b>243</b>
		CORRETTORI DI COPPIA	<b>120</b>

<b>DENOMINAZIONE</b>	<b>PAG.</b>	<b>DENOMINAZIONE</b>	<b>PAG.</b>
CRESTE PARAFANGO	<b>87</b>	GRIGLIA PER FRONTALE	<b>45</b>
CROCERA CAMBIO	<b>92</b>	GRUPPO CAVI ELETTRICI	<b>217</b>
CROCERA SEMIASSE RUOTA	<b>143</b>	GRUPPO FRIZIONE	<b>112</b>
CUFFIE RAFFREDDAMENTO MOTORE	<b>179</b>	GRUPPOCAMBIO VESPA	<b>145</b>
CUFFIE TENUTA	<b>124</b>	GUARNIZIONI CLACSON	<b>101</b>
CUSCINETTO DI BANCO	<b>185</b>	GUARNIZIONI MOTORE	<b>25-121</b>
		GUARNIZIONI RACCORDO/SCARICO	<b>121</b>
		GUARNIZIONI TAPPO	<b>127</b>
		GUARNIZIONI SCOCCA/SERBATOIO	<b>222</b>
<b>D</b>		<b>K</b>	
DADO ALBERO MOTORE	<b>10</b>	KIT CRESTA / GRIGLIA	<b>87</b>
DADO FISSA MANUBRIO	<b>63</b>	KIT GOMMINI	<b>89-226</b>
DADO FISSA RUOTA	<b>37</b>	KIT MOLLE GANASCE	<b>136</b>
DEPURATORE	<b>156</b>	KIT REVISIONE ALBERO MOTORE	<b>185</b>
DEVIO LUCI	<b>212</b>	KIT REVISIONE ASSE PEDIVELLA	<b>94</b>
DINAMO MOTORE	<b>249</b>	KIT REVISIONE GIRANTE	<b>20</b>
DISCO FRIZIONE	<b>111</b>	KIT REVISIONE MOTORINO AVVIAMENTO	<b>183</b>
<b>F</b>		KIT REVISIONE SEMIASSE	<b>143</b>
FANALI	<b>218-242</b>	KIT SERRAFILO	<b>108</b>
FILTRO ARIA	<b>154</b>	KIT SPORTELLINO	<b>47</b>
FILTRO ARIA OLIATO	<b>174</b>	KIT REVISIONE SUPPORTO MOTORE VESPA	
FILTRO BENZINA CODULO	<b>129</b>	KIT TRASMISSIONE C/KM	<b>250</b>
FILTRO GASOLIO	<b>155</b>	<b>I</b>	
FILTRO OLIO	<b>155</b>	INDICATORE DI CARBURANTE	<b>130</b>
FLANGIA PORTARUOTA	<b>230</b>	INGRANAGGIO AVVIAMENTO	<b>142</b>
FODERO PER FORCELLE	<b>37</b>	INGRANAGGIO CAMBIO	<b>142</b>
FORCELLE	<b>35</b>	INGRANAGGIO CICLOMOTORE	<b>137</b>
FRENO A DISCO	<b>196</b>	INGRANAGGIO CONTACHILOMETRI	<b>55</b>
FRIZIONE COMPLETA	<b>112</b>	INGRANAGGIO DUPLO-SCORREVOLE APE	<b>139</b>
FRONTALE VESPA - SCOOTER	<b>44-82</b>	INGRANAGGIO INNESTO MOTORINO	<b>141</b>
FRECCE	<b>218</b>	INGRANAGGIO M/M	<b>141</b>
FUSELLO MOZZO	<b>241</b>	INGRANAGGIO MOTORE VESPA	<b>114</b>
<b>G</b>		INGRANAGGIO MULTIPLO VESPA PX	<b>138</b>
GABBIE A RULLI	<b>12</b>	INTERRUTTORE CHIAVE	<b>214</b>
GANASCE FRENO	<b>103</b>	INTERRUTTORE CLACSON	<b>178</b>
GANCI PORTABORSA	<b>102</b>	INTERRUTTORI FRECCHE	<b>178</b>
GHIERA BLOCCAGGIO CUSCINETTO	<b>225</b>	INTERRUTTORI LUCI	<b>178</b>
GHIERA CONTACHILOMETRI	<b>229</b>	INTERRUTTORI STOP	<b>177</b>
GIRANTI POMPE ACQUA	<b>20</b>	INTERRUTTORE TERMICO	<b>178</b>
GIUNTO ELASTICO	<b>144</b>	INTERMITTENZA	<b>206</b>
GOMMINO PEDALE FRENO	<b>109</b>	IMPIANTI ELETTRICI	<b>217</b>

DENOMINAZIONE	PAG.
<b>L</b>	
LAMELLE	<b>160</b>
LEVA COFANO MOTORE	<b>231</b>
LEVE FRENO FRIZIONE	<b>58</b>
LEVA STARTER VESPA 50	<b>224</b>

<b>M</b>	
MANICOTTO CAMBIO VESPA	<b>91</b>
MANICOTTO CARBURATORE	<b>157</b>
MANIGLIA PORTA	<b>127</b>
MANOPOLE	<b>62</b>
MANUBRI	<b>63</b>
MARMITTE	<b>232</b>
MASSE AVVIAMENTO E FRIZIONE	<b>110</b>
MASSETTE	<b>110</b>
MEMBRANA CARBURANTE	<b>248</b>
MISURINO	<b>127</b>
MODANATURA	<b>46</b>
MOLLA ANCORAGGIO FARO	<b>221</b>
MOLLE	<b>133</b>
MOLLE CAVALLETTO	<b>80</b>
MOLLE SELLA	<b>215</b>
MORSETTO CAVO	<b>109</b>
MOTORINO AVVIAMENTO	<b>182</b>
MOTORINO TERGICRISTALLO	<b>131</b>
MOZZO RUOTA	<b>249</b>

<b>P</b>	
PARAFANGHI	<b>84</b>
PARAOLIO	<b>123</b>
PARASPRUZZI	<b>82-97</b>
PASSACAVO USCITA COMANDI	<b>216</b>
PASTIGLIE FRENO	<b>161</b>
PEDALE FRENO	<b>109</b>
PEDANA CENTRALE	<b>34</b>
PEDIVELLE	<b>93</b>
PERNI CAVALLETTO	<b>80-134</b>
PERNI RUOTA CICLOMOTORE	<b>132</b>
PERNI SELLA	<b>126</b>
PERNI SOSPENSIONE	<b>50</b>
PIASTRA POSTERIORE	<b>222</b>
PIASTRINE FISSA CAVALLETT	<b>66</b>
PICK-UP	<b>206</b>

DENOMINAZIONE	PAG.
PIEDINI CAVALLETTO	<b>65</b>
PISTONE COMPLETO	<b>28</b>
POMPA FRENO	<b>146 - 251</b>
POMPA MISCELATORE CARBURANTE	<b>130</b>
PORTA LAMPADA	<b>219</b>
PORTA SPAZZOLE	<b>207</b>
PORTA TARGA CICLOMOTORE	<b>98</b>
PORTA TARGA VESPA	<b>223</b>
PRESA BASSA TENSIONE	<b>213</b>
PRESELETTORE CAMBIO	<b>92</b>
PROTEZIONE PEDALE FRENO	<b>109</b>
PRIGIONIERI FISSA CILINDRO	<b>132</b>
PROTEZIONE FILO CONTACHILOMETRI	<b>127</b>
PROTEZIONE IMPIANTO ELETTRICO	<b>225</b>
PROTEZIONE PARASPRUZZO POSTERIORE	<b>97</b>
PROTEZIONE RUOTA SCORTA VESPA PX	<b>90-231</b>
PULEGGIA CAMBIO GAS / CAMBIO	<b>91</b>
PULEGGIA CONDOTTA	<b>158</b>
PULEGGIA FRIZIONE MOTRICE	<b>118</b>
PULSANTE SPEGNIMENTO	<b>214</b>
PUNTALINI STRISCE PEDANA	<b>33</b>

<b>Q</b>	
QUADRUPLO	<b>138</b>

<b>R</b>	
RACCORDO AMMISSIONE LAMELLARE	<b>176</b>
RACCORDO ASPIRAZIONE	<b>115-95</b>
RACCORDO CARBURATORE/DEPURATORE	<b>124</b>
RACCORDO GOMMA FILTRO ARIA	<b>157</b>
RACCORDO SERBATOIO OLIO	<b>130</b>
RACCORDO SCARICO AMMISSIONE	<b>95-176</b>
RACCORDO TUBO-TESTA	<b>26</b>
RADIATORE OLIO/ACQUA	<b>155</b>
RALLINI FRIZIONE	<b>117</b>
REGISTRO FILO FRENO	<b>108</b>
REGOLATORI	<b>203-239</b>
RELE'	<b>207</b>
RIBATTINI	<b>97</b>
RINVIO CONTACHILOMETRI	<b>55</b>
RUBINETTI	<b>128</b>
RULLO PER VARIATORE	<b>30</b>

<b>DENOMINAZIONE</b>	<b>PAG.</b>	<b>DENOMINAZIONE</b>	<b>PAG.</b>
RUOTA DENTATA	<b>118</b>	SUPPORTO ELASTICO-MOTORE	<b>144</b>
RUOTA LIBERA	<b>158</b>	SUPPORTO FANALE POSTERIORE	<b>82</b>
		SUPPORTO RUOTA SCORTA	<b>216</b>
<b>S</b>		<b>T</b>	
SCARPETTE CAVALLETTO	<b>65</b>	TAMBURI FRENO	<b>51</b>
SCATOLE PORTA ATTREZZI	<b>98</b>	TAMBURO PULEGGIA	<b>110</b>
SCUDETTI PER FRONTALI	<b>44</b>	TAMPONE ATTACCO AMM.	<b>38</b>
SCUDI FRONTALI SCOOTER	<b>82</b>	TAMPONE SCONTRO CAV. SCOOTER	<b>80</b>
SEMIASSE	<b>143</b>	TAMPONE SCONTRO CAV. PX	<b>65</b>
SEMIPULEGGE MOTRICE/FISSA	<b>119</b>	TAPPETI	<b>34</b>
SERBATOIO BENZINA	<b>251</b>	TAPPO OLIO MOTORE	<b>127</b>
SERBATOIO OLIO	<b>131</b>	TAPPO RUOTA	<b>181</b>
SERIE BULLONI MOTORE	<b>240</b>	TAPPO SERBATOIO	<b>127</b>
SERIE CALOTTE	<b>42</b>	TARGHETTE	<b>147</b>
SERIE DI PESI E GRAMMATURE	<b>31</b>	TELERUTTORE	<b>208 - 243</b>
SERIE GOMMINI	<b>122</b>	TENDICATENA	<b>159</b>
SERIE GUARNIZIONI CILINDRO	<b>25</b>	TERMINALI STRISCE	<b>33</b>
SERIE GUARNIZIONI MOTORE	<b>121</b>	TESTE CILINDRO	<b>26</b>
SERIE MOLLEGGIO	<b>36</b>	TIRANTE STARTER	<b>64</b>
SERIE PARAOLI MOTORE	<b>123</b>	TIRANTE TAPPO V.50 ET3	<b>216</b>
SERIE PARASTRAPP	<b>111</b>	TRASMISSIONE CONTACHILOMETRI	<b>56</b>
SERIE RULLI VARIATORE	<b>30</b>	TUBO BENZINA	<b>129-250</b>
SERIE SEGMENTI	<b>27</b>	TUBO COMANDO CAMBIO/GAS	<b>91</b>
SERIE STRISCE PEDANA	<b>32</b>	TUBO FRENO	<b>200</b>
SERRAFILO	<b>108</b>		
SERRATURE	<b>47</b>	<b>U</b>	
SETTORI AVVIAMENTO	<b>139</b>	UTENSILI	<b>125</b>
SFIATATOIO OLIO	<b>127</b>		
SOFFIETTI	<b>124-242</b>	<b>V</b>	
SOTTOMANUBRIO VESPA	<b>224</b>	VARIATORI	<b>29</b>
SPECCHIO CROMATO	<b>218</b>	VASCHETTA RACCOGLI OLIO	<b>224</b>
SPIA OLIO	<b>127</b>	VENTOLA	<b>119</b>
SPORTELLI - PULSANTE	<b>89-251</b>	VETRO CONTACHILOMETRI	<b>228</b>
STAFFE PORTAFANALE	<b>64</b>	VITI FISSA LEVA	<b>60</b>
STAFFE CAVALLETTO	<b>66</b>	VALVOLA LAMELLARE	<b>176</b>
STAFFE CENTRALINA	<b>224</b>		
STAFFE PER BOBINA	<b>224</b>		
STAFFE SUPPORTO CAVI	<b>225</b>		
STAFFE PORTA BATTERIA	<b>231</b>		
STARTER	<b>207</b>		
STATORI	<b>207-239</b>		
STELI FORCELLA	<b>36</b>		
STELO SPOSTAMENTO MARCE	<b>92</b>		
STRISCE PEDANA	<b>32</b>		
SUPPORTO BOBINA	<b>207</b>		

## INDICE PER FAMIGLIA PRODOTTI

<b>MOTORE</b>	<b>PAGINA</b>	<b>MATERIALE ELETTRICO</b>	<b>PAGINA</b>
ALBERI CAMBIO	<b>137</b>	AVVIAMENTI VESPA	<b>214</b>
ALBERI MOTORE	<b>8</b>	COMMUTATORI	<b>212</b>
ASSI RUOTA	<b>137</b>	CONTATTI CONDENSATORI	<b>210-211</b>
ATTACCHI CANDELA	<b>184</b>	GRUPPO CAVI ELETTRICI COMPLETI	<b>217</b>
BIELLA COMPLETA	<b>11</b>	GRUPPO FANALI ANT.POST.CORNICI FARO	<b>218-221</b>
CAMPANE FRIZIONE VESPA	<b>117</b>	PRESE CORRENTE	<b>213</b>
CILINDRI COMPLETI	<b>13-19</b>	TELERUTTORI-BOBINE A.T.	<b>208-209</b>
CINGHIE MOTORE	<b>234-238</b>		
COLLETTORI ASPIRAZIONE SCOOTERS	<b>176</b>	<b>ELETTRONICA</b>	
COPPIA TRASMISSIONE VESPA	<b>136</b>	CENTRALINE	<b>201-202</b>
DISCHI FRIZIONE VESPA	<b>111</b>	REGOLATORI TENSIONE	<b>203-205</b>
FILTRI ARIA-OLIO-GASOLIO	<b>174-175</b>	INTERMITTENZE - PICK-UP	<b>206</b>
FILTRI OLIATI ARIA	<b>154-155</b>	RELE' - SUPPORTI BOBINE	<b>207</b>
FRIZIONI CENTRIFUGHE	<b>112</b>		
FRIZIONI COMPLETE SCOOTERS	<b>114</b>	<b>TELAIO</b>	
FRIZIONI COMPLETE VESPA	<b>113</b>	AMMORTIZZATORI E TAMPONI	<b>38-41</b>
FRIZIONI CICLOMOTORI PIAGGIO	<b>118</b>	ASTE RUBINETTI BENZINA	<b>131</b>
GABBIE SPINOTTO	<b>12</b>	ASTUCCI APE	<b>143</b>
INGRANAGGI CAMBIO	<b>142</b>	BLOCCHETTI AVVIAMENTO - SCOOTERS	<b>188-195</b>
INGRANAGGI SCOOTERS	<b>136</b>	BOCCOLI FERMO SCOOTERS	<b>116</b>
INGRANAGGIO M/M SCOOTERS	<b>141</b>	BORDI SCUDO	<b>96</b>
INGRANAGGIO M/M VESPA	<b>142</b>	CAVALLETTI CENTRALI - LATERALI APRILIA	<b>70-72</b>
KIT PESI VARIATORE	<b>30-31</b>	CAVALLETTI CENTRALI - LATERALI GILERA	<b>73</b>
KIT REVISIONE - BANCO CUSCINETTI- PARAOLI	<b>185-187</b>	CAVALLETTI CENTRALI - LATERALI HONDA	<b>77</b>
KIT REVISIONE POMPA ACQUA	<b>20-24</b>	CAVALLETTI CENTRALI - LATERALI KIMCO	<b>78</b>
LAMELLE	<b>160</b>	CAVALLETTI CENTRALI - LATERALI MALAGUTI	<b>74</b>
MARMITTE	<b>232-233</b>	CAVALLETTI CENTRALI - LATERALI PEUGEOT	<b>79</b>
MOTORINI AVVIAMENTO	<b>182-183</b>	CAVALLETTI CENTRALI - LATERALI YAMAHA	<b>75-76</b>
PISTONI COMPLETI	<b>28</b>	CAVALLETTI CENTRALI CON PIASTRA MODIFICATA	<b>81</b>
PRESELETTORI-CROCERE-INNESTI VESPA	<b>92</b>	CAVALLETTI CENTRALI - PIEDINI	<b>65-68</b>
PULEGGE CICLOMOTORI PIAGGIO	<b>118</b>	CAVALLETTO-PIASTRINE PIAGGIO	<b>65-68</b>
QUADRUPLI VESPA	<b>138</b>	CAVALLETTI LATERALI PIAGGIO	<b>69</b>
RACCORDI AMM.-SCARICO-ASPIRAZIONE	<b>95</b>	CHIAVI CANDELA- PERNI SELLA	<b>126</b>
RALLINI	<b>117</b>	CILINDRETTI FRENO	<b>145</b>
RUOTA LIBERA	<b>158-159</b>	CLACSON ORIGINALI	<b>99-101</b>
SEMIPULEGGE-VENTOLE SCOOTERS	<b>119-120</b>	COLLETTORI ASPIRAZIONE SCOOTERS	<b>115</b>
SERIE GUARNIZIONI - SCARICHI	<b>121</b>	COMANDI FRENO - FRIZIONE	<b>61</b>
SERIE GUARNIZIONI CILINDRO (TRIS)	<b>25</b>	COMANDI GAS-CAMBIO VESPA	<b>91</b>
SERIE PARAOLI MOTORE	<b>123</b>	CONTACHILOMETRI	<b>53-54</b>
SERIE PARASTRAPPI VESPA	<b>111</b>	COPERCHI MANUBRIO VESPA	<b>90</b>
SERIE SEGMENTI	<b>27</b>	COPERCHI MOZZO RUOTA	<b>52</b>
SETTORI AVVIAMENTO	<b>139-140</b>	COPERCHI RUOTA EPOCA	<b>231</b>
TENDICATENA	<b>158-159</b>	COPPIA TAMPONI MOTORE	<b>230</b>
TESTA CILINDRO	<b>26</b>	COPPIE PASTIGLIE	<b>161-173</b>
VARIATORI	<b>29</b>		
VARIATORI CICLOMOTORI PIAGGIO	<b>118</b>		

## INDICE PER FAMIGLIA PRODOTTI

<b>TELAIO</b>	<b>PAGINA</b>	<b>TELAIO</b>	<b>PAGINA</b>
COPRIVENTOLA - BAULETTO VESPA	<b>88</b>	RUBINETTI	<b>128-129</b>
CRESTE PARAFANGO	<b>87</b>	SCATOLE PORTATARGA	<b>98</b>
CROCERE RUOTA	<b>143</b>	SCATOLE PORTATTREZZI	<b>98</b>
CUFFIE SEMIASSI	<b>124</b>	SERBATOI OLIO	<b>131</b>
CUFFIE VESPA	<b>179</b>	SEMIASSI APE	<b>131</b>
DADI RUOTA	<b>37</b>	SERIE CALOTTE STERZO	<b>42-43</b>
ESTRATTORI	<b>125</b>	SERIE GOMMINI FRENO	<b>122</b>
FILTRI	<b>128-129</b>	SERIE STRISCE COMPLETE	<b>32</b>
FILTRI ARIA COMPLETI SCOOTERS - APE	<b>157</b>	SERRATURE	<b>47-49</b>
FILTRI ARIA VESPA	<b>156</b>	SOFFIETTI ASPIRAZIONE	<b>124</b>
FORCELLE	<b>35-36</b>	SPORTELLI LATERALI VESPA	<b>89</b>
FRENI DISCO	<b>196-199</b>	SUPPORTI MOTORE VESPA	<b>144</b>
FRONTALI VESPA	<b>44-46</b>	SUPPORTI RUOTE SCORTA	<b>216</b>
GANASCE FRENO	<b>103-107</b>	TAMBURI FRENO	<b>51</b>
GANCI PORTABORSE	<b>102</b>	TAPPETI	<b>34</b>
GHIERE CONTACHILOMETRI	<b>229</b>	TAPPI SEBATOIO	<b>127</b>
GIUNTI APE	<b>144</b>	TARGHETTE	<b>147-153</b>
INGRANAGGI RINVIO CONTACHILOMETRI	<b>55</b>	TIRANTI STARTER	<b>63-64</b>
INTERRUPTORI	<b>177-178</b>	TRASMISSIONI-CAVI CONTACHILOMETRI	<b>56-57</b>
KIT GOMMINI SPORTELLI E KIT COMPLETI	<b>226-227</b>	TUBI BENZINA	<b>128-129</b>
KIT SEMIASSI	<b>143</b>	TUBI FRENO	<b>200</b>
KIT SERRAFILO	<b>108-109</b>	VARIE VESPA EPOCA	<b>224-225</b>
LEVE FRENO - FRIZIONE	<b>58-60</b>	VETRINI CONTACHILOMETRI	<b>228</b>
MANIGLIE APE	<b>127</b>		
MANOPOLE	<b>62-63</b>		
MANUBRI STAFFE PORTAFARO	<b>63-64</b>		
MASSETTE FRIZIONE - TAMBURI FRIZIONE	<b>110</b>		
MOLLE VARIE EPOCA	<b>215</b>		
MORSETTI	<b>35-36</b>		
PARAFANGHI PLASTICA PIAGGIO	<b>85-86</b>		
PARAFANGHI CIAO	<b>85-86</b>		
PARAFANGHI VESPA	<b>84</b>		
PARASPRUZZI POSTERIORI VESPA	<b>97</b>		
PEDANE	<b>35-36</b>		
PEDALI E GOMMINI FRENO	<b>108-109</b>		
PEDANE	<b>35-36</b>		
PEDIVELLE M/M MOTO	<b>93-94</b>		
PEDALI CICLOMOTORE	<b>93-94</b>		
PERNI CON MOLLA CAVALLETTI	<b>80</b>		
PERNI SOSPENSIONE	<b>50</b>		
PIASTRE POSTERIORI VESPA	<b>222-223</b>		
PLASTICHE PIAGGIO - APRILIA - GILERA	<b>82-83</b>		
POMPE BENZINA	<b>130</b>		
POMPE FRENO	<b>146</b>		
PRIGIONIERI - PERNI RUOTA	<b>132</b>		
PULSANTI	<b>177-178</b>		
PUNTALINI PER SERIE STRISCE	<b>33</b>		



- 1184154** Albero motore - Ciao - Boxer - Bravo - SI - spinotto ø 10 (con gabbia)
- 1184154 CR** Albero motore anticipato - Ciao - Boxer - Bravo - SI - spinotto ø 10 (con gabbia)
- 71615** Albero motore - Vespa 50S - 50SS (con gabbia)
- 71615 CR** Albero motore anticipato - Vespa 50 - 50S - 50SS (con gabbia)
- 1224587** Albero motore - Vespa PK50 - PK50S (dal 1985) - PK50XL - (con gabbia) - ø asse volano mm 20
- 1224587 CR** Albero motore anticipato - Vespa PK50 - PK50S (dal 1985) - PK50XL - (con gabbia) - ø asse volano mm 20
- 71617** Albero motore - Vespa 125 Primavera - ET3 (con gabbia)
- 71617 CR** Albero motore anticipato - Vespa 125 Primavera - ET3 - (con gabbia)
- 1224788** Albero motore - Vespa PK125 - PK125S (dal 1985) - PK125XL - (con gabbia) - ø asse volano mm 19 (intercambiabile P.223711)
- 1224788 CR** Albero motore anticipato - Vespa PK125 - PK125S (dal 1985) - PK125XL - (con gabbia) - ø asse volano mm 19
- 79450** Albero motore - Vespa 125 - 150 2% - Super Sprint (con gabbia)
- 80116** Albero motore - Vespa P125X - P150X (con gabbia)
- 80116 CR** Albero motore anticipato - Vespa P125X - P150X (con gabbia)
- 80118** Albero motore - Vespa P200E (con gabbia)
- 80118 CR** Albero motore anticipato - Vespa P200E (con gabbia)



- 1846267** Albero motore - Ape 50 (2003-2010)



- 55244** Albero motore - PK125XL - **modificato** - adattabile a Vespa PK50XL



- 1969428** Albero motore Piaggio 50 - 4 tempi  
Liberty RST 4T 2004 - Fly 4T 2005 -  
Vespa LX 4T 05 - Zip 4T Euro 2 00/04 -  
(sedi cuscinetto mm 17-20)





**58230** Albero motore - Minarelli - Yamaha - YP 125

**58231** Albero motore - Minarelli - Yamaha - YP 150



**1431625** Albero motore - Sfera - Zip - Zip Fast Rider-  
Quartz - Free - Typhoon

**55433** Albero motore - MBK Booster - Aprilia Amico  
(motori verticali)

**55473** Albero motore - Yamaha Jog - F10 - Centro -  
Minarelli (motori orizzontali)

**55526** Albero motore - Peugeot Buxy - Zenith -  
Speedake - SV 50 - Geo - Trekker 50

Malaguti Crosser

**55740** Albero motore - Honda Bali 50 - SFX -  
(sede cuscinetto ø 20)



**58248** Coppia ingranaggi sull'albero motore  
Motori Minarelli - Yamaha YP 125-150-180



**1289519** Dado albero motore scooters - Piaggio



**55951** Dado M10 x 1,25 - H = 8 mm -  
Albero motore - Motori Minarelli

**55952** Dado M10 x 1 - H = 8 mm - Frizione -  
Motori Minarelli



**91051** Dado bloccaggio volano - Vespa PX 125-150-200E  
(S. 21112)



**73556** Dado bloccaggio volano - Super - Sprint - GTR - VLM2  
VLB1 - VBC1 - VBA - VBB - 1959  
(S. 1544 - S. 12066)



- 55016** Biella completa - Ciao - Boxer - Bravo - con gabbia ø 12  
**55032** Biella completa - Ciao - Boxer - Bravo - SI - con gabbia ø 10  
**55032 CR** Biella completa - Ciao - Boxer - Bravo - SI - cromata e alleggerita con gabbia argentata ø 10  
**71619** Biella completa - Vespa 50S - 50SS - PK50 - PK50XL - RUSH - N - V - Ape 50 con gabbia  
**71619 CR** Biella completa cromata e alleggerita - Vespa 50 - 50S - PK50 - PK50XL - RUSH - N - V - Ape 50  
**58254** Biella completa Piaggio **4T** 50  
**71620** Biella completa - Vespa 90 - 90SS - 125 Primavera - ET3  
**71620 CR** Biella completa cromata e alleggerita - Vespa 125 Primavera - ET3 - PK125  
**79255** Biella completa - Vespa 125 - 150 dal 1960 (modelli al 2%)  
**80122** Biella completa - Vespa 125 gtr - 125 ts - 150 Super - 150 Sprint Veloce - P125X - P150X  
**80123** Biella completa - Rally 200 - P200E  
**58303** Biella completa - Vespa 125 - dal 1951/1952  
**58304** Biella completa - Vespa 125 - 1953 (VM 1T)  
**58305** Biella completa - Vespa 125 - 1955/1957 (VN1 - VN2)  
**58359** Biella completa Vespa 125 - dal 1954  
**89979** Biella completa - Ape C4  
**93008** Biella completa - Ape MP  
**97004** Biella completa - Ape CAR  
**55317** Biella completa - Aprilia 125 - Rotax (con gabbia argentata)



- Asse accoppiamento mm 20 x 49  
**55349** Biella completa - Sfera - Zip - Zip Fast Rider - Quartz - Free - Typhoon  
**55353** Biella completa - Aprilia Amico - MBK Booster  
**55356** Biella completa - Peugeot Metropolis - SC  
**55360** Biella completa - Peugeot ST - Rapido  
**55358** Biella completa - Peugeot SV - Geo  
**55363** Biella completa - Honda Vision  
**55464** Biella completa - Sfera 80  
**58249** Biella completa - Honda SH 125-150 - @ 125-150



- 58149** Biella completa - Kymco 150 - Asse **30 x 39**  
**58152** Biella completa - Piaggio 125 **4T**  
**58153** Biella completa - Yamaha Majestic 125 - MBK Skyliner 125  
**58302** Biella completa - Majestic 150  
**58163** Biella completa - Yamaha Majestic 250



- 35015** Chiavella volano - Vespa tutti i tipi - Ciao - Boxer - Bravo - SI  
**35163** Chiavella frizione - Vespa 125 - 150 - 180 - 200 - Ape MP  
**86011** Chiavella frizione - Vespa 50 - 90 - 125 Primavera - ET3



- 71636** Gabbia a rulli spinotto - Vespa 50 tutti i tipi (12 - 17 - 13)  
**79262** Gabbia a rulli spinotto - Vespa 90 - 125 - 150 (15 - 19 - 20)  
**86826** Gabbia a rulli spinotto - Vespa 180SS - 200 Rally - Ape 175 -  
 Ape MP (16 - 20 - 20)  
**97008** Gabbia a rulli spinotto - Ape CAR (18 - 23 - 20)  
**42031** Gabbia a rulli spinotto - Lambretta J50 - Lui - Garelli  
 (12 - 16 - 13)  
**55008** Gabbia a rulli spinotto - FBM - F. Morini - Ciao - Bravo - SI  
 (12 - 15 - 15)  
**1166920** Gabbia a rulli spinotto - Ciao - Bravo - SI (10 - 13 - 14)  
**55324** Gabbia a rulli spinotto - Ape 50 - Vespa 50 (12 - 17 - 15)  
**55355** Gabbia a rulli spinotto - Aprilia Amico - MBK Booster -  
 Peugeot Metropolis - SC - ST - Rapido - Honda Vision  
**(10 - 14 - 13)**  
**42031 A** Gabbia a rulli - **12 x 16 x 16** - Suzuki Katana L.C.  
 SR Aprilia L.C. dal 2000



## MOTORI PIAGGIO

**56060****Ciao - Boxer - Bravo**Elaborazione **5 travasi** ø **43** - completa di guarnizioni, testa cilindro, pistone con spinotto ø **12****56061****Ciao - Boxer - Bravo**Elaborazione **5 travasi** ø **43** - completa di guarnizioni, testa cilindro, pistone con spinotto ø **10** - SI**56068****SI**Elaborazione **5 travasi** ø **43** - completa di guarnizioni, testa cilindro, pistone con spinotto ø **10** - SI**56069****SI**Elaborazione **5 travasi** ø **43** - completa di guarnizioni, testa cilindro, pistone con spinotto ø **12****56062**Elaborazione **5 travasi** ø **43** - completa di guarnizioni, pistone con spinotto ø **12****56063**Elaborazione **5 travasi** ø **43** - completa di guarnizioni, pistone con spinotto ø **10****56014**Cilindro completo **4 travasi** ø **38,4** - completo di guarnizioni, pistone con spinotto ø **12****56015**Cilindro completo **4 travasi** ø **38,4** - completo di guarnizioni, spinotto ø **10****71623 C**Cilindro completo - **Vespa 50** - ø **38,4** - **3 travasi****71040 T3****Vespa 50 - PK50 e Ape 50 a 75 cc.**Elaborazione **3 travasi** - ø **47** - completa di pistone, testa cilindro, guarnizioni e prigionieri**56030****Vespa 50 - PK50 e Ape 50 a 75 cc.**Elaborazione **6 travasi** - ø **47** - completa di pistone, testa cilindro, guarnizioni e prigionieri**56031****Vespa 50 - PK50 e Ape 50 a 100 cc.**Elaborazione **6 travasi** - ø **55** - completa di pistone, testa cilindro, guarnizioni e prigionieri**56065****Vespa 50 - PK50 e Ape 50 a 80 cc.**Elaborazione **3 travasi** - ø **50** - completa di pistone, testa cilindro, guarnizioni e prigionieri



- 56032 Vespa P125X - P150X a 175 cc.**  
Elaborazione -  $\varnothing$  **63** - a **7 travasi**  
+ 3 luci di scarico  
completa di pistone, testa cilindro, guarnizioni



- 56051 Vespa 125 Primavera - 125 ET3 - 125PK**  
Elaborazione cilindro in ghisa -  $\varnothing$  **57** -  
a **5 travasi**  
completa di pistone, testa cilindro, guarnizioni e  
prigionieri



- 56086** Gruppo motore **scooters - Piaggio -  $\varnothing$  40 - Originale**



- 56080** Sfera - Zip - Zip Fast Rider - Free - Typhoon  
Elaborazione **6 travasi** -  $\varnothing$  **47**



- 56093** Motori **Piaggio H20 -  $\varnothing$  40 - NRG - NRG MC 2 - NTT - Quartz - Zip SP H2O - Runner**



**56109** Gruppo motore scooters - **Piaggio - H<sub>2</sub>O** -  
ø **40** - dal **1998** (R.O. 830656)

**56110** Gruppo motore scooters - **Piaggio - H<sub>2</sub>O** -  
ø **47**



**56028** Cilindro completo **Ape MP - MPR -  
MPV** - con pistone ø **69** e spinotto ø **16**

**56029** Cilindro completo **Ape CAR - P501 - P601 -  
P601V** - con pistone ø **69** e spinotto ø **18**

**56079** Cilindro completo **Ape TM P703**  
con pistone ø **69** e spinotto ø **18**



**1828864** Cilindro completo APE TM 703-703 V  
CAR 602-P3  
(P.832349)

## MOTORI MINARELLI - YAMAHA



- 56082** Aprilia Amico - MBK Booster - Italjet  
Elaborazione **5 travasi**  $\varnothing$  **47** -  
**attacco lamellare** - motori verticali Minarelli
- 56084** Come sopra **senza testa**



- 56083** Yamaha - F10 - Centro - Minarelli  
Elaborazione **5 travasi** -  $\varnothing$  **47** -  
**ammissione normale** - motori orizzontali Minarelli
- 56085** Come sopra **senza testa**
- 56119** Motori Minarelli - CPI - Popcorn - Oliver - Kway -  
Focus - Hurricane - Matrix  
 $\varnothing$  **47** - **spinotto**  $\varnothing$  **12**  
Motori orizzontali

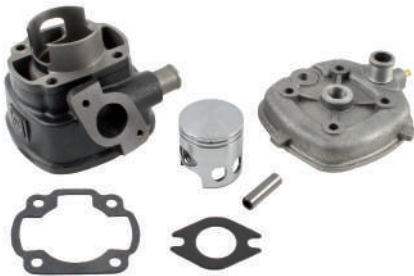

- 56091** Motori Minarelli H2O -  $\varnothing$  **40** - Aprilia - Gulliver  
H2O - Rally H2O - SR H2O - Malaguti F15  
F12 H2O - MBK Nitro - Beta Ark
- 56092** Motori Minarelli H2O -  $\varnothing$  **47** - Aprilia - Gulliver  
H2O - Rally H2O - SR H2O - Malaguti F15  
F12 H2O - MBK Nitro - Beta Ark
- 56101** Gruppo Motori Minarelli H2O -  $\varnothing$  **47** -  
Aprilia - Gulliver H2O - Rally H2O - Malaguti F15 -  
F12 H2O - MBK Nitro - Beta Ark  
**(testa doppia connessione)**





**56112** Gruppo motore completo  
Derbi Senda 4V - 6V - GPR50 - Bultaco Lobito  
L.C. -  $\varnothing$  **40**

**56112 TC** Testa cilindro -  $\varnothing$  40

**56112 PT** Pistone completo -  $\varnothing$  40 - 40,4 - 40,8

**56112 SS** Serie segmenti -  $\varnothing$  40 - 40,4 - 40,8

**56114** Gruppo motore completo  
Derbi Senda 4V - 6V - GPR50 - Bultaco Lobito  
L.C. -  $\varnothing$  **47**

**56114 TC** Testa cilindro -  $\varnothing$  47

**56114 PT** Pistone completo -  $\varnothing$  47 - 47,4 - 47,8

**56114 SS** Serie segmenti -  $\varnothing$  47 - 47,4 - 47,8

**Z56112** Serie guarnizioni -  $\varnothing$  40 - 47



**56107** Gruppo motore scooters -  $\varnothing$  **40,3** - AM6

**Aprilia:** Motori AM345, AM6, AM6 EUI

**Betamotor:** Motori AM6, AM6 EUI

**HM:** Motori AM6, AM6 EUI

**HRD:** Motori AM6, AM6 EUI

**Motorhispania:** Motori AM6, AM6 EUI

**Peugeot:** Motori AM6, AM6 EUI

**Rieju:** Motori AM6, AM6 EUI

**Yamaha:** Motori AM6, AM6 EUI

**56107 PT 40,3** Pistone completo -  $\varnothing$  **40,3** - AM6

**56111** Gruppo motore scooters -  $\varnothing$  **49** - AM6

**Aprilia:** Motori AM345, AM6, AM6 EUI

**Betamotor:** Motori AM6, AM6 EUI

**HM:** Motori AM6, AM6 EUI

**HRD:** Motori AM6, AM6 EUI

**Motorhispania:** Motori AM6, AM6 EUI

**Peugeot:** Motori AM6, AM6 EUI

**Rieju:** Motori AM6, AM6 EUI

**Yamaha:** Motori AM6, AM6 EUI

**56111 TC** Testa cilindro -  $\varnothing$  49

**56111 PT** Pistone completo -  $\varnothing$  49 - 49,4 - 49,8

**56111 SS** Serie segmenti -  $\varnothing$  49 - 49,4 - 49,8

**Z56107** Serie guarnizioni -  $\varnothing$  40,3

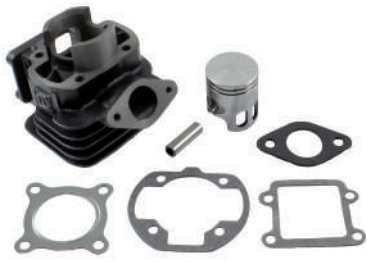

**56089** Motori Minarelli  $\varnothing$  **40** - **Verticale** -  
MBK Booster - Aprilia Amico -  
**attacco lamellare**

**56090** Motori Minarelli  $\varnothing$  **40** - **Orizzontali** -  
Jog - F10 - Centro -  
**ammissione normale**



**56118** Motori Minarelli - CPI - Popcorn - Oliver - Kway -  
Focus - Hurricane - Matrix  
 $\varnothing$  **40** - **spinotto**  $\varnothing$  **12**  
Motori orizzontali

## MOTORI HONDA - KYMCO - MORINI - PEUGEOT



**56097** Cilindro completo  $\varnothing$  **40** - Peugeot speedfight **L.C.**



**56127** Gruppo motore completo  
Peugeot Ludix - 50 cc. Ø 40

**56095 PT** Pistone completo Peugeot Ludix 50  
Ø 40 - 40,4 - 40,8

**56095 SS** Serie segmenti (2 AC x 1,5) Ø 40 - 40,4 - 40,8



**56095** Motori Peugeot ø **40** - Buxy - RS -  
Speedake - SQUAB - SV50 - GEO - Zenith

**56096** Cilindro completo ø **39**  
Honda SH 50 del 1996 - Honda Bali - Sky - SFX

**56099** Cilindro completo ø **41**  
Motori Franco Morini - Italjet formula - Velocifero -  
Suzuki Adress - Malaguti Crosser



**56106** Suzuki Katana - **L.C.** - ø **41** -  
Aprilia SR **L.C.** dal 2001



**55771 C** Kit revisione girante - Pompa acqua  
Motori Minarelli - Yamaha L.C.  
(completi di cuscinetti e paraolio)

**Aprilia** Rally 50 L.C. - SR 50 L.C. -  
Area 51 - Gulliver 50 L.C. - Sonic 50

**Beta** Ark 50 L.C.

**Malaguti** F-12 Phantom - F-15 Firefo

**MBK** Nitro 50 - Mach G L.C. <sup>x</sup>

**Yamaha** Jog 50RR L.C. - Aerox 50



**58168** Motori Minarelli - Yamaha 50  
con puleggia motrice



**1289508 C** Kit revisione girante - Pompa acqua  
Motori Piaggio L.C.  
(completi di cuscinetti e paraolio)

**Derbi** GP 1

**Gilera** Runner 50

**Piaggio** Zip 50 SP - NRG 50 -  
NRG mc /mc  
QUARTZ<sup>2</sup>92/1996



**1433593 C** Kit revisione girante - Pompa acqua

**Gilera** Runner FX 125/180 -  
FXR 125-180

**Italjet** Dragster 125-180

**Piaggio** Hexagon 125-150 -  
Hexagon LX 125-180  
Hexagon LXT 125-180

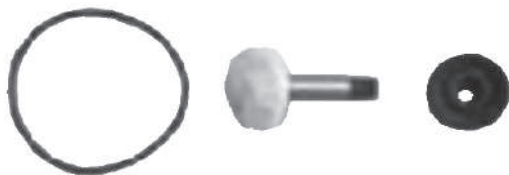

**58226** **Minarelli** 125-150-180  
**Yamaha** 125-150-180



**58565** Kit revisione girante.  
Pompa acqua **Yamaha** 50 4T L.C.

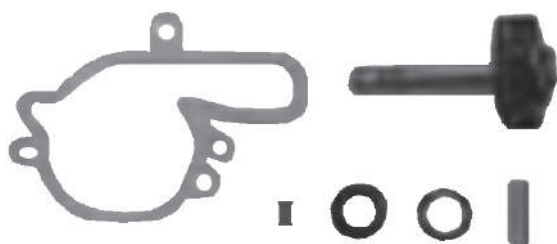

**58136 C** Kit revisione girante - Pompa acqua

<b>Aprilia</b>	Motori AM345 - AM6 - AM6 Euro 1
<b>Betamotor</b>	Motori AM6 - AM6 Euro 1
<b>HM</b>	Motori AM6 - AM6 Euro 1
<b>HRD</b>	Motori AM6 - AM6 Euro 1
<b>Motorhispania</b>	Motori AM6 - AM6 Euro 1
<b>Peugeot</b>	Motori AM6 - AM6Euro 1
<b>Rieju</b>	Motori AM6 - AM6 Euro 1
<b>Yamaha</b>	Motori AM6 - AM6 Euro 1
<b>Gas Gas</b>	RR Enduro, Supermotard



**58336** **Kimco** Dink 125-150 cc



**58337** **Kimco** Dink 250 cc



**58207 C** **Derbi Senda** GPR - GPR 50 R  
F - GPR Racing - L - Super Motard



**58338** **Derbi** Predator LG - Atlantis LC - Paddock LC



**55966 C** Kit revisione girante - Pompa acqua  
**Motori Franco Morini - Suzuki LC**  
(completi di cuscinetti e paraolio)



**58142 C** Kit revisione girante - Pompa acqua -  
**Aprilia** Ditech 50  
**Suzuki** Katana 50 LC

**58142 CB** **Aprilia** Ditech 50  
**Suzuki** Katana 50 LC - pale **mm 7**



**58339** **Suzuki** Burgman 125-150 cc



**58223** **Honda** Pantheon 125-150 2T



**58224** **Honda** SH 125-150 4T  
 Chiocciola 125-150 4T



**58558** Kit revisione girante.  
 Pompa acqua **Honda** SH 300



**58225** **Honda** Foresight 250 4T



**58340** Piaggio Beverly 500 cc - 2002/2004



**58320 C** Piaggio 125-200  
Vespa Granturismo - X8 - X9  
Beverly - MP3

**58376 C** Piaggio 250 Dal 2006 al 2008  
Beverly - Vespa GTS - GTV -  
X7 - X8 - MP3



**58528** Kit Piaggio revisione  
pompa acqua  
**Piaggio** Beverly 250 06-07  
-Carnaby - MP3 06-08  
- GTV-X7 - X8 - X9



**58529** Kit revisione pompa acqua  
**Piaggio** Beverly 250 RST 04-05



**58423** Piaggio Kit revisione pompa acqua  
Beverly 400/500 Euro 3 -  
MP3 - Cruiser - XEvo - Tourer (dal 2007)



**58169 C** Piaggio X8 - X9 - Granturismo  
Beverly - RLS -  
Super Hexagon 125-200 4T  
dal 2001

**1487459** Puleggia traino girante -  
X8 - X9 - Granturismo - Beverly - RLS -  
Super Hexagon 125-200 4T dal 2001



**58341** Kit pompa acqua  
**Kymco** Dink 180 cc





**58530** Kit revisione pompa acqua  
**Yamaha** XMax 125 - XCity 125



**58342** Kit pompa acqua  
**Yamaha** Majesty 400 cc

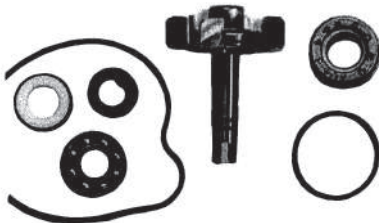

**58436** Kit revisione pompa acqua  
**Yamaha** T-Max 500



**58140 C** Kit revisione girante - Pompa acqua  
**Aprilia** Scarabeo 125-150  
Leonardo 125-150 dal 2000  
(r.o. 0220356)



**58227** **Minarelli** 250-270  
**Yamaha** 250-270



**SERIE GUARNIZIONI CILINDRO SCOOTERS  
(Base cilindro, scarico, testata)**

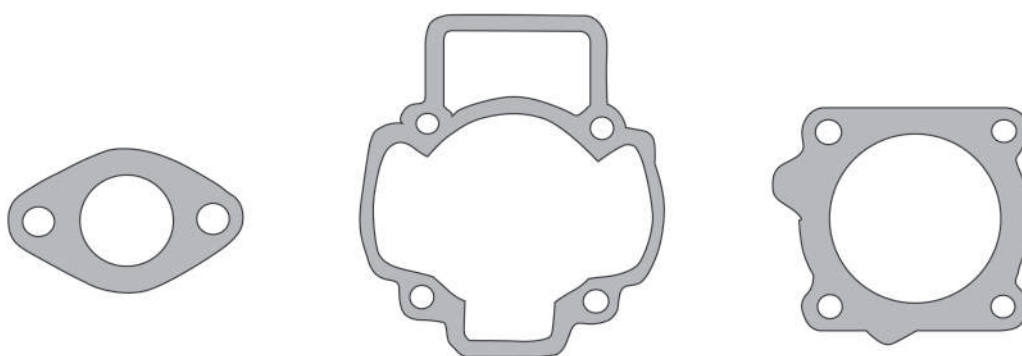

<b>Z55182</b>	Motori Piaggio (air cooled) - ø 47	<b>58063</b>	Hexagon GT250 (99-2000) - Super Hexagon GT250 (99-2000)
<b>Z55182-40</b>	Motori Piaggio (air cooled) - ø 40	<b>58361</b>	Aprilia Scarabeo 150 '99
<b>Z55346</b>	Motori Minarelli Orizzontali - ø 47	<b>58362</b>	Elkon 125 99-00 - Dink 125 97-98
<b>Z55346-40</b>	Motori Minarelli Orizzontali - ø 40	<b>58363</b>	Kimco Grand Dink 125 Euro 2
<b>Z55347</b>	Motori Minarelli Verticali - ø 47	<b>58364</b>	Kimco Grand Dink 250
<b>Z55347-40</b>	Motori Minarelli Verticali - ø 40	<b>58365</b>	Madison 150 99-00
<b>Z55597</b>	Motori Piaggio (liquid cooled) - ø 40 - ø 47	<b>58366</b>	F18 Warrior 125 Malaguti
<b>Z55598</b>	Motori Minarelli (liquid cooled) - ø 40 - ø 47	<b>58367</b>	Motori Piaggio 4 tempi - 50 cc
<b>Z56095</b>	Motori Peugeot - ø 40	<b>58368</b>	Super Hexagon GTX X9 - 125-00
<b>Z55917</b>	Motori Honda - ø 39 (SH50 dal 96 - BALI - SKY)	<b>58369</b>	Skipper 125-150 4 tempi - Liberty - Vespa 00-08
<b>58046</b>	Leonardo 125 (96-99)	<b>58370</b>	Super Hexagon GTX X9 180-00
<b>58047</b>	Scarabeo 125 (99)	<b>58371</b>	Piaggio Beverly 125-200 01-05
<b>58048</b>	Leonardo 150 (96-99)	<b>58372</b>	Piaggio Beverly 200 4 tempi - 2001-2003
<b>58049</b>	Scarabeo 150 (99)	<b>58373</b>	Piaggio X9 500 01-02
<b>58050</b>	Leonardo 250 (99) - Madison 250 (99-2001) - Majesty 250 (96-2001)	<b>58374</b>	Piaggio Beverly 500 02-08
<b>58052</b>	Runner 125 4T (2000-2001) - Super Hexagon 125 GT (2000-2001)	<b>58375</b>	Yamaha YP250 - Majesty DX 96-99
<b>58053</b>	Runner 180 FXR (97-2001) - Hexagon 180 LXT (98-99)		X-City 250 - X-Max 250
<b>58054</b>	Runner 180 VXR 4T (2000-2001) - Super Hexagon 180 GTX (2000-2001)	<b>58498</b>	Aprilia 125 - Atlantic EU3 (2006-2011) 125 SR MAX
<b>58055</b>	Honda @ 125 (2000-2001) - SH 125 (2001)		Piaggio 125 MP3 Yourban
<b>58056</b>	Honda @ 150 (2000-2001) - SH 150 (2001)	<b>58499</b>	Aprilia 300 Atlantic - 300 SR MAX
<b>58057</b>	Madison 125 (99) - Majesty 125 R (98-2001)	<b>58501</b>	Honda 300 SH (2007-2011)
<b>58058</b>	Hexagon 125 LX (94-97)	<b>58502</b>	Piaggio 300 MP3 IE - LT - MP3 Yourban
<b>58059</b>	Hexagon LX4 125 4T (98-99) - Sfera - Vespa ET4 - Liberty 125		300 Vespa GTS Super / Super Sport (2010-2011)
<b>58060</b>	Skipper 125 4T (2000-2001) - Typhoon - LX - Liberty	<b>58503</b>	Piaggio 400 MP3 (2008-2011) -400 X Evo (2007-2011)
<b>58061</b>	Skipper 125 LX (93-99)	<b>58504</b>	Yamaha 125 YW - BW'S (2010-2011) - 125 Zuma (2009-2012)
<b>58062</b>	Hexagon 150 (94-97)	<b>58506</b>	Yamaha 400 YP - Majesty (2007-2012)
		<b>58507</b>	Yamaha 500 XP - T MAX ABS (2005-2011) - T MAX (2001-2011)



**71668** Testa cilindro originale **Vespa 90** Ø **47**



**56060 TC** Testa cilindro Ø **43** - **SI**

**56061 TC** Testa cilindro Ø **43** - **Ciao - Boxer - Bravo**



**56030 TC** Testa cilindro Ø **47** per serie **Vespa 50 a 75**

**56031 TC** Testa cilindro Ø **55** per serie **Vespa 50 a 100**

**56032 TC** Testa cilindro Ø **63** per serie **Vespa P125X - P150X**

**56051 TC** Testa cilindro Ø **57** per serie **125 Primavera - 125 ET3 - 125PK**



**56074 TC** Testa cilindro Ø **47** Motori Piaggio

**56075 TC** Testa cilindro Ø **47** Motori Minarelli - **attacco lamellare**

**56076 TC** Testa cilindro Ø **47** Motori Minarelli - **ammissione normale**



**56093 TC** Testa cilindro H2O - Ø **40** - Piaggio

**56092 TC** Testa cilindro H2O - Ø **47** - Minarelli

**56097 TC** Testa cilindro Peugeot - Ø **40**

**56110 TC** Testa cilindro - Ø **47** mm

**56101 TC** Testa cilindro H2O - Ø **47** (doppia connessione)

**56102 TC** Testa cilindro H2O - Ø **40** (doppia connessione)

**56107 TC** Testa cilindro H2O - Ø **40,3**

#### TESTE ORIGINALI ARIA SCOOTERS 50 cc

**56086 TC** Testa cilindro Piaggio - (Ø 40 mm)

**56089 TC** Testa cilindro Minarelli - Yamaha verticali - (Ø 40 mm)

**56090 TC** Testa cilindro Minarelli - Yamaha orizzontali - (Ø 40 mm)

**56095 TC** Testa cilindro Peugeot Aria - (Ø 40 mm)

**56096 TC** Testa cilindro Honda - (Ø 39 mm)

**56099 TC** Testa cilindro Franco Morini - Suzuki Aria - (Ø 41 mm)

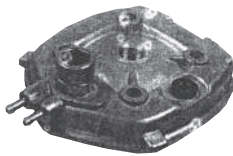

**55764** Raccordo Tubo-testa - Motori Piaggio - Gilera **L.C.** - (completo di fascetta e viti)



- 25005** Serie segmenti - **Garelli (2AC x 1,5)** -  
 ø **46 - 46,2 - 46,4 - 46,6 - 46,8**
- 56010 SS** Serie segmenti - **Ciao - Boxer - Bravo - SI (1AC - 1AL)** -  
 ø **41 - 41,2 - 41,4 - 41,6 - 41,8**
- 56026 SS** Serie segmenti - **Califfo (2AC x 1,5)** -  
 ø **41 - 41,2 - 41,4 - 41,6 - 41,8**
- 56028 SS** Serie segmenti - **Ape** - ø **69 - 69,4 - 69,8**
- 56030 SS** Serie segmenti - **Vespa 50 a 75 - 6 travasi (2AC x 1,5)**  
 ø **47 - 47,2 - 47,4 - 47,6 - 47,8**
- 56031 SS** Serie segmenti - **Vespa 50 a 100 e 125 Primavera 5T - PK125 5T (2AC x 1,5)** -  
 ø **55 - 55,2 - 55,4 - 55,6 - 55,8**
- 56032 SS** Serie segmenti - **Vespa P125X - P150X a 175 cc (2AC x 2)** - ø **63 - 63,2 - 63,4 - 63,6 - 63,8**
- 56051 SS** Serie segmenti - **Vespa 125 Primavera - 125 ET3 - PK125 a 5 travasi (2AC x 1,5)** -  
 ø **57 - 57,2 - 57,4 - 57,6 - 57,8**
- 56060 SS** Serie segmenti - **Ciao - Boxer - Bravo - SI (AC x 1,5)** - ø **43 - 43,4 - 43,8**
- 56065 SS** Serie segmenti - **Vespa 50 - PK50 - Ape 50 (2AC x 1,5)** - ø **50 - 50,4 - 50,8**
- 56080 SS** Serie segmenti - **Sfera - Zip - Zip Fast Rider - Free - Typhoon** - ø **47 - 47,4 - 47,8**
- 56082 SS** Serie segmenti - **Aprilia Amico - MBK Booster - Italjet** - ø **47 - 47,4 - 47,8**
- 56086 SS** Serie segmenti ø **40 - 40,4 - 40,8**
- 71623 SS** Serie segmenti - **Vespa 50 - 3 travasi (2AC x 1,5)** -  
 ø **38,4 - 38,6 - 38,8 - 39 - 39,2**
- 100659/660** Serie segmenti - **Ciao - Boxer - Bravo - SI - 4 travasi (1AC - 1AL)** -  
 ø **38,4 - 38,6 - 38,8 - 39 - 39,2**
- 1182518/519** Serie segmenti - **SI** ø **38,2**

- 25008** Pistone completo - **Garelli**  
 ø **46 - 46,2 - 46,4 - 46,6 - 46,8**
- 56010 PT** Pistone completo - **Ciao - Boxer - Bravo - SI - 6 travasi**  
 con spinotto ø 12  
 ø **41 - 41,2 - 41,4 - 41,6 - 41,8**
- 56014 PT** Pistone completo - **Ciao - Boxer - Bravo - SI - 4 travasi**  
 con spinotto ø 12  
 ø **38,4 - 38,6 - 38,8 - 39 - 39,2**
- 56015 PT** Pistone completo - **Ciao - Boxer - Bravo - SI - 4 travasi**  
 con spinotto ø 10  
 ø **38,4 - 38,6 - 38,8 - 39 - 39,2**
- 56024 PT** Pistone completo - **Minarelli V1**  
 ø **47 - 47,2 - 47,4 - 47,6 - 47,8**
- 56026 PT** Pistone completo - **Califfo - 5 travasi**  
 ø **41 - 41,2 - 41,4 - 41,6 - 41,8**
- 56028 PT** Pistone completo - **Ape** con spinotto ø 16  
 ø **69 - 69,4 - 69,8**
- 56029 PT** Pistone completo - **Ape** con spinotto ø 18  
 ø **69 - 69,4 - 69,8**
- 56030 PT** Pistone completo - **Vespa 50 a 75 - 6 travasi**  
 ø **47 - 47,2 - 47,4 - 47,6 - 47,8**
- 56031 PT** Pistone completo - **Vespa 50 a 100 - 6 travasi**  
 ø **55 - 55,2 - 55,4 - 55,6 - 55,8**
- 56032 PT** Pistone completo - **Vespa P125X - P150X - a 175 cc**  
 ø **63 - 63,2 - 63,4 - 63,6 - 63,8**
- 56051 PT** Pistone completo - **Vespa 125 Primavera - 125 ET3 - 125PK - 5 travasi**  
 ø **57 - 57,2 - 57,4 - 57,6 - 57,8**
- 56060 PT** Pistone completo - **Ciao - Boxer - Bravo - SI - 5 travasi**  
 ø **43 - 43,4 - 43,6 - 43,8 - spinotto ø 12**
- 56061 PT** Pistone completo - **Ciao - Boxer - Bravo - SI - 5 travasi**  
 ø **43 - 43,4 - 43,8 - spinotto ø 10**
- 56065 PT** Pistone completo - **Vespa 50 - PK50 - Ape 50**  
 ø **50 - 50,4 - 50,8**
- 56080 PT** Pistone completo - **Sfera - Zip - Zip Fast Rider - Free - Typhoon**  
 ø **47 - 47,4 - 47,8**
- 56082 PT** Pistone completo ø **47 - 47,4 - 47,8**
- 56086 PT** Pistone completo ø **40 - 40,4 - 40,8**
- 56089 PT** Pistone completo ø **40 - 40,4 - 40,8**
- 56120 PT** Pistone completo ø **39 - 39,4 - 39,8**
- 71031-47** Pistone completo - **Vespa 50 - PK50 - Ape 50 a 75 cc 3 travasi**  
 ø **47 - 47,2 - 47,4 - 47,6 - 47,8**
- 71623 PT** Pistone completo - **Vespa 50 - 3 travasi**  
 ø **38,4 - 38,6 - 38,8 - 39 - 39,2**





**55405** Gruppo variatore - Sfera - Zip - Typhoon - Storm - NRG - completo di 3 serie pesi

**55410** Gruppo variatore - Peugeot SV - Geo completo di 3 serie pesi

**1430189** Gruppo variatore completo - Sfera dal '94 - Zip dal '94 - Zip Fast Rider - Free - Quartz - Typhoon - Storm - NRG

**1434918** Gruppo variatore completo - Skipper - Hexagon (1ª serie)

**55905** Variatore completo - Piaggio 125-150 (2 tempi) - Skipper 125-150 (94-97) - Hexagon 125-150 (94-97)

**55906** Variatore completo - Kymco Dink 125-150 (N.O. 22101 - KBE - 9000)

**55908** Variatore completo - Majestic 125 - Skyliner 125

**1110301** Variatore completo (pesi mm 19) - Liberty 50 - Vespa ET2 - Free Delivery - NRG MC3 - Estrem - Diesis

**1487954** Variatore completo - Hexagon LX - LXT 125-180

**1103904** Variatore completo - (adatt. P. CM 103904) X8-125 - Vespa Granturismo 125 X9 - X9 Evolution 125

**1103901** Variatore completo - (adatt. P. CM 103901) Liberty 4T 125-150 - 2000-2002  
ET4 4T 125-150 - 1999-2002  
Skipper 4T 125-150 - 2000-2002



- 1103804 C** Kit pesi **19 x 17 gr 73**  
 Aprilia Scarabeo 125 4T LC Sportcity 125 4T  
 Gilera Runner 125 4T LC VX -  
 Piaggio Beverly 125 4T LC -  
 Super Hexagon 125 4T LC GTX -  
 Vespa Granturismo 125 4T LCX8 125 4T LC -  
 X9 125 4T LC



- 1102402** Rullino completo Typhoon 125 - Skipper 2T -  $\varnothing$  **19 - gr. 13,5**  
**1102402 C** Kit rullini (6 pz.) Typhoon 125 - Skipper 2T -  $\varnothing$  **19 - gr. 13,5**  
**1434852** Rullino completo Sfera - Hexagon Liberty - 125 4T -  $\varnothing$  **19 - gr. 12**  
**1434852 C** Kit rullini (6 pz.) Sfera - Hexagon Liberty - 125 4T -  $\varnothing$  **19 - gr. 12**  
**1436855** Rullino completo Stalker - Vespa 50 ET2 - Liberty -  $\varnothing$  **19 - gr. 6,4**  
**1436855 C** Kit rullini (6 pz.) Stalker - Vespa 50 ET2 - Liberty -  $\varnothing$  **19 - gr. 6,4**  
**1483364** Rullino completo Hexagon - Runner 180 cc -  $\varnothing$  **20 - gr. 15,5**  
**1483364 C** Kit rullini (6 pz.) Hexagon - Runner 180 cc -  $\varnothing$  **20 - gr. 15,5**  
**1487822** Rullino completo Sfera - Vespa 125 4T -  $\varnothing$  **19 - gr. 12**  
**1487822 C** Kit rullini (6 pz.) Sfera - Vespa 125 4T -  $\varnothing$  **19 - gr. 12**  
**1289927** Rullino completo Zip - Sfera (dal 1994) - Zip Fast Rider - Free - Quartz - Typhoon - Storm - NRG -  $\varnothing$  **16 - gr. 8,3**  
**1289927 C** Kit rullini (6 pz.) Zip - Sfera (dal 1994) - Zip Fast Rider - Free - Quartz - Typhoon - Storm - NRG -  $\varnothing$  **16 - gr. 8,3**  
**1435389** Rullino completo Skipper - Hexagon -  $\varnothing$  **19 - gr. 12,5**  
**1435389 C** Kit rullini (6 pz.) Skipper - Hexagon -  $\varnothing$  **19 - gr. 12,5**  
**55960 C** Kit rullini - Variatore modificato - **16x13 - gr. 3**  
**55786 C** Kit rullini - Variatore modificato - **16x13 - gr. 3,5**  
**55787 C** Kit rullini - Variatore modificato - **16x13 - gr. 4**  
**55788 C** Kit rullini - Variatore modificato - **16x13 - gr. 4,5**  
**55961 C** Kit rullini - Variatore modificato - **16x13 - gr. 5**  
**55962 C** Kit rullini - Variatore modificato - **16x13 - gr. 5,5**  
**55842 C** Kit rullini - Kymco Dink 125 - **20x15 - gr. 13,5**  
**55843 C** Kit rullini - Kymco Dink 150 - **20x15 - gr. 14,5**  
**55844 C** Kit rullini - Kymco Dink 125-150 - **20x15 - gr. 12**  
**55894 C** Kit rullini - Majestic 125 - Skyliner 125 - **20x12 - gr. 12**  
**55959 C** Kit rullini - **15x12 - gr. 3,5**  
**55862 C** Kit rullini - **15x12 - gr. 4,5**  
**55848 C** Kit rullini - **15x12 - gr. 5**  
**55847 C** Kit rullini - **15x12 - gr. 5,5**  
**55845 C** Kit rullini - **15x12 - gr. 6**  
**55846 C** Kit rullini - **15x12 - gr. 6,5**  
**55861 C** Kit rullini - **15x12 - gr. 7**  
**55860 C** Kit rullini - **15x12 - gr. 7,5**  
**58210 C** 17 X 12,3 - gr. 4  
**58211 C** 17 X 12,3 - gr. 4,5  
**58212 C** 17 X 12,3 - gr. 5  
**58213 C** 17 X 12,3 - gr. 5,5  
**58214 C** 17 X 12,3 - gr. 6  
**58215 C** 17 X 12,3 - gr. 7  
**58216 C** 17 X 12,3 - gr. 11,30  
**1831625 C** Kit rullini - Motori Piaggio 500 - 25 x 22 - gr. 28,5

**SERIE PESI VARIATORI SCOOTERS  
(6 pezzi)**

**Ø 23 x 18**

Honda foresight '98 Pantheon 125-150 cc

<b>Cod.</b>	<b>Gr.</b>
<b>58094 C</b>	13
<b>58095 C</b>	14
<b>58096 C</b>	18
<b>58097 C</b>	20
<b>58098 C</b>	22
<b>58099 C</b>	27

**Ø 20 x 14,6**

Kymco Dink 125-150 - People 125

<b>Cod.</b>	<b>Gr.</b>
<b>58082 C</b>	10
<b>58083 C</b>	11
<b>58084 C</b>	13
<b>58085 C</b>	13,4
<b>58086 C</b>	14,4
<b>58087 C</b>	15,5

**Ø 20 x 12**

Minarelli / Yamaha 250

<b>Cod.</b>	<b>Gr.</b>
<b>58072 C</b>	14
<b>58073 C</b>	13
<b>58074 C</b>	12
<b>58075 C</b>	9
<b>58076 C</b>	8
<b>58077 C</b>	8,5
<b>58078 C</b>	9,5
<b>58079 C</b>	10
<b>58080 C</b>	10,5
<b>58081 C</b>	11

**Ø 23,8 x 18**

Suzuki Burgman 250

<b>Cod.</b>	<b>Gr.</b>
<b>58100 C</b>	31
<b>58101 C</b>	29
<b>58102 C</b>	27

**Ø 20 x 17**

Aprilia Leonardo 125-150 - Scarabeo 125-150

<b>Cod.</b>	<b>Gr.</b>
<b>58088 C</b>	8
<b>58089 C</b>	8,5
<b>58090 C</b>	9
<b>58091 C</b>	9,5
<b>58092 C</b>	10
<b>58093 C</b>	11

**Ø 26 x 12,8**

Suzuki Burgman 400

<b>Cod.</b>	<b>Gr.</b>
<b>58109 C</b>	21
<b>58110 C</b>	19
<b>58111 C</b>	17

**Ø 19 x 17**

Gilera Runner 180 - Typhoon 125 -  
Piaggio Hexagon 125-150 - Lyberty 4T 125-150 -  
Skipper 125-150 - Skipper 4T 125-150 -  
Vespa ET4 4T 125

<b>Cod.</b>	<b>Gr.</b>
<b>58103 C</b>	8,5
<b>58104 C</b>	9
<b>58105 C</b>	9,5
<b>58106 C</b>	10
<b>58107 C</b>	11
<b>58108 C</b>	13





- 55003** Serie strisce pedana complete di gomma, puntalini e ribattini - Vespa 50 - 90 - 125 Primavera - ET3
- 55004** Serie strisce pedana complete di gomma, puntalini e ribattini - Vespa 125 - GTR - 125 "ts" - 150 Sprint - 200 Rally
- 55029** Serie strisce pedana complete di gomma, puntalini e ribattini - Vespa P125X - P150X - P200E - dal 1982 - PX125E - PX150E - PX200E (Serie Arcobaleno)
- 55030** Serie strisce pedana - Vespa PK
- 55627** Serie strisce pedana - Vespa 125 - 150 VBB - 150 GL (6 listelli)
- 58407** Serie strisce pedana completa Vespa 125 VN1 - VN2 - 54/57 (8 listelli)
- 58412** Serie strisce pedana completa Vespa 150 GS - VS 2/3/4/5 dal 56 (11 listelli)
- 58360** Serie strisce pedana complete VNA-VNB Completa di puntalini - Profilato di gomma - Ribattini

## STRISCE PEDANE VESPA D'EPOCA



- 58404** Vespa 125 (V1 - V15) dal 1949 al 1950
- 58405** Vespa 125 (V30 - V33) dal 1951 al 1952
- 58406** Vespa 125 (VM1 - VM2) dal 1953 al 1954
- 58408** Vespa 150 (VL1 - VL2) dal 1954 al 1956
- 58409** Vespa 150 (VL3) dal 1956 in poi
- 58410** Vespa 150 (VB1) anno 1958
- 58411** Vespa 150 GS (VS1) dal 1955 al 1956
- 58413** Vespa 160 GS (VSB1) dal 1962 in poi
- 58414** Vespa 150 (VBA1 - VBB1) dal 1959 in poi
- 58415** Vespa 125 (VNA 1/2) dal 1957 al 1958
- 58416** Vespa 125 (VNB 1/2) dal 1959 al 1961
- 58417** Vespa 125 (VNB2-3-4-5-6) dal 1962 in poi
- 58418** Vespa 125/150 (VNC1 / VBC1) dal 1963 in poi
- 58419** Vespa 150GL (VLA1) dal 1963 in poi

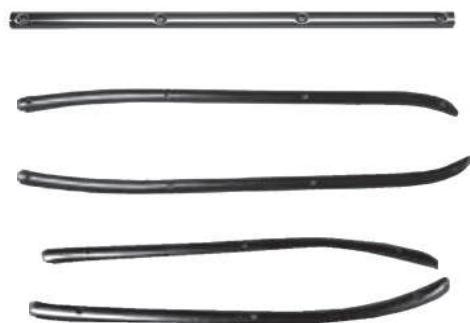

- 1180048** Listello per tappeto centrale - Vespa PX
- 79321/322** Coppia listelli per fissaggio tappeto centrale Vespa Super - GTR - TS - Rally - Sprint (adatt. P.85073 - 85074)
- 71755/756** Coppia listelli per fissaggio tappeto centrale Vespa 50 - 125 Primavera - ET3 (adatt. P.100446 - 100447)





**58301** Serie completa listelli pedane in gomma  
Vespa 50 V5A1T - Vespa 90 V9A1T



**71797** Terminale strisce pedana (alluminio) - Vespa 50S - 50 Special - 90 -  
125 Primavera - 125/150 Super

**79822** Terminale strisce pedana (alluminio) - Vespa GTR - Sprint - Rally



**1182174** Puntalino strisce pedana - P125X - P150X - P200E - dal 1982

**1197077** Terminale strisce esterne pedana - anteriore destro - Vespa PK

**1197078** Terminale strisce esterne pedana - anteriore sinistro - Vespa PK



**1215414** Terminale strisce esterne pedana - posteriore - Vespa PK



**1215415** Terminale strisce interne pedana - Vespa PK

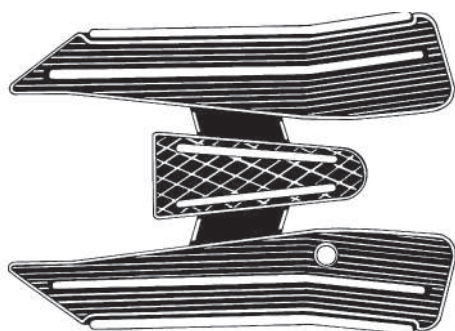

**55001** Tappeto - Vespa 50 - 90 -  
125 Primavera - ET3 - **Nero**

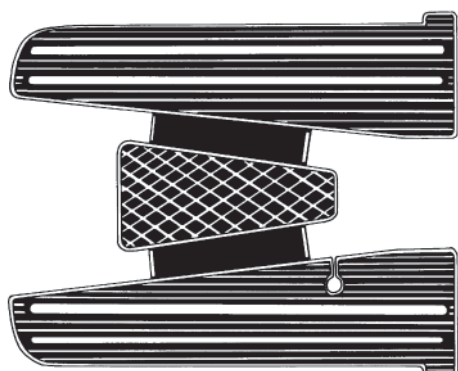

**55077** Tappeto - Vespa PX125E - PX150E -  
PX200E - (Arcobaleno) - **Nero**

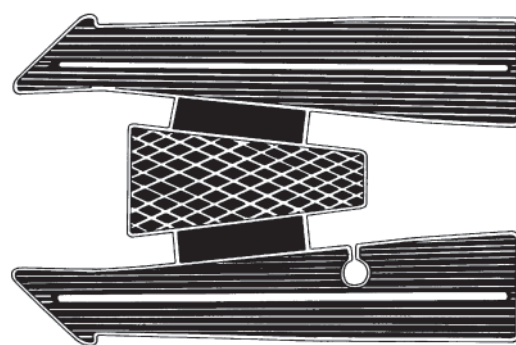

**55028** Tappeto - Vespa PK50 - 50S - 125 -  
125S - **Nero**



**71796** Tappeto pedana Vespa 125 Primavera - ET3

**79338** Tappeto pedana Vespa Super - GTR - "ts" - Rally

**1180052** Tappeto pedana Vespa PX



**1244692** Pedana centrale Ciao PX -  
(foro alla base)



**1234171 / 172** Coppia pedane Dx - Sx Vespa 50 - 125 - PK - XL - Rush-N

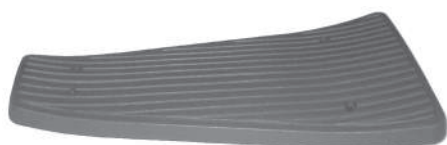

**1219109** Pedana centrale  
Vespa PXE Arcobaleno  
Vespa PX 125-150-200 (grigia)



**1214512** Pedana appoggiapiedi PK - XL  
PKS 50 - 100 - 125

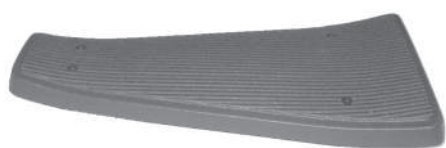

**1226093** Pedana centrale Vespa T5 (nera)



**1183678** Forcella - Vepa 50 - 90 -  
125 Primavera



**1183435** Forcella - Vespa P125X - P150X -  
P200E  
al 1981 con perno  $\varnothing$  16

**1178050** Forcella - Vespa P125X - P150X -  
P200E  
dal 1982 con perno  $\varnothing$  20

**1216744** Forcella - Vespa PX125E - PX150E -  
PX200E - (Serie Arcobaleno)



**1183436** Braccio sospensione anteriore forcella - Vespa P125X - P150X - P200E - con perno ø 16

**1178051** Braccio sospensione anteriore forcella - Vespa P125X - P150X - P200E - PX125E - PX150E - PX200E - con perno ø 20 - (Serie Arcobaleno)

**1273711** Braccio sospensione anteriore - Sfera 50-125 - Vespa ET2-ET4



**55017** Serie molleggio anteriore - Ciao PX



**55685** Steli forcella - Booster (coppia)



**55682** Forcella nuda - Malaguti F12



**58021** Forcella - MBK Nitro 50-100 - 2002 - Yamaha Aerox 50-100 - 2002 - (sede calotta ø 30)

**58022** Forcella - Honda @ 125-150 Dylan 125-150



**55450** Forcella - Typhoon



**100749** Forcella - Ciao



**100514** Forcella anteriore (nuda) - Boxer



**1267001** Copridado ruota - Sfera



**1266829** Copertura forcella - Sfera



**1273075** Copriforcella - Sfera dal 1995



**1163933** Fodero per forcella - "SI" - destro

**1163934** Fodero per forcella - "SI" - sinistro



**1267608** Copridado - "SI F.L." - dal 1992



**93151** Dado fissa ruota - Ape MP - MPR - MPM - MPV - CAR



**89907** Dado ruota Vespa 150 VBB2  
Adatt. Piaggio 019411



**71271** Ammortizzatore anteriore - **Piaggio**  
Vespa 50 - Vespa 50S - 50 Special - 90 - 125 Primavera - ET3 -  
PK50 - PK50S - PK50XL

**1174446** Ammortizzatore anteriore (completo) - **Piaggio**  
Vespa P125X - P150X - P200E

**1056187** Ammortizzatore **Piaggio** anteriore Vespa PX **Freno disco**  
(R.O. 56187 R)

**1216211** Ammortizzatore anteriore (completo) - **Piaggio**  
Vespa PK125 - PK125S - Sfera



**71395** Ammortizzatore posteriore - **Piaggio**  
Vespa 50 - 90 - 125 Primavera - ET3 - 125/150 - dal 1964 -  
Sprint - Sprint Veloce - Super - Rally 180 - Rally 200 -  
125GTR - 125TS - P125X - P150X - P200E - PK50 - PK125



**71395 C** Ammortizzatore posteriore completo di molla

**1216387** Ammortizzatore posteriore - **Piaggio**  
Vespa PK50 - PK50S - PK50XL - PK125 - PK125S



**1216387 C** Ammortizzatore posteriore - Vespa PK50 - PK50S  
- K50XL - PK125 - PK125S completo di molla



**73200** Ammortizzatore anteriore - **Piaggio**  
Vespa 125/150 al 1965 - Sprint - Sprint Veloce - Super -  
Rally 180 - Rally 200 - 125GTR - 125TS - Ape C - Ape C4 -  
Ape 175

**73200 ME** Ammortizzatore anteriore Vespa 125/150 al 65 - **Piaggio**  
Sprint - Sprint Veloce - Super - Rally 180 - Rally 200 -  
GTR - TS - Ape C4 - Ape 175 (copertura metallo)



**86669** Tampone attacco superiore ammortizzatore  
Vespa 50 - 90 - 125 Primavera - ET3 -  
PK50 (P. 57012) (anteriore)



**1174085** Tampone attacco superiore ammortizzatore  
Vespa P125X - P150X - P200E (anteriore)



**1178150** Tampone di riscontro superiore  
Ammortizzatore post.  
Vespa PK 50-125  
diam.int. 12 - diam.est. 31 - H. mm 18



**73208** Bullone attacco superiore ammortizzatore anteriore  
Vespa 125 GTR - Super - Sprint Veloce - Rally 200  
P. 9141



**73209** Bullone attacco inferiore ammortizzatore anteriore  
Vespa 125 GTR - Super - Sprint Veloce - Rally 200  
P. 9142



**1225533** Ammortizzatore anteriore -  
**Ape** TM P703

**91098** Ammortizzatore anteriore  
**Ape** 50 - **Ape** 250TM

**93129** Ammortizzatore anteriore  
**Ape** MP - MPM - MPR - MPV

**97038** Ammortizzatore anteriore  
**Ape** CAR

**91156** Ammortizzatore posteriore  
**Ape** 50 - **Ape** 250 TM

**93130** Ammortizzatore posteriore  
**Ape** MP - MPR - MPM - MPV  
- **Ape** CAR

**1566506** Ammortizzatore anteriore  
**Ape** TM - Diesel - Max Diesel



**74689 C** Ammortizzatore posteriore (1958 - 1966) **Piaggio**  
Vespa Super - Sprint GL - GS - GTR  
Rally 200  
(R.O. 20360) Molla biconica - **mm 45** - nero

**74689 FS** Fosfatato - tipo originale  
Molla biconica - **mm 45**



- 55419** Ammortizzatore posteriore **registrabile** - **MBK** Booster - **Malaguti** F10 - Interasse mm 245
- 55422** Ammortizzatore posteriore **registrabile** - **Aprilia** SR
- 55423** Ammortizzatore posteriore **registrabile** - **Malaguti** Centro
- 55437** Ammortizzatore posteriore **registrabile** - Zip **Piaggio**
- 55342** Ammortizzatore completo posteriore scooter - **Aprilia** - Amico - Peugeot - Metropolis SC - Interasse mm 275
- 55343** Coppia ammortizzatori completi posteriori scooter - **Honda** SH 50 - Tipo **rinforzato** - Interasse mm 290
- 55344** Ammortizzatore completo posteriore scooter - **Yamaha** Booster MBK - Ovetto - Interasse mm 245
- 55454** Ammortizzatore completo posteriore scooter - **Malaguti** Phantom F12-  
Aprilia Amico Sport - Interasse mm 260
- 55469** Ammortizzatore posteriore **registrabile** - Sfera - Typhoon
- 55900** Ammortizzatore posteriore - **Kymco** Dink 125-150  
(N.O. 52400 KBE 9000 - interasse mm. 300)



- 1562444**  
Ammortizzatore anteriore **Piaggio**  
completo - Vespa ET2 - ET4



- 1561128**  
Ammortizzatore posteriore  
**Piaggio** completo - Vespa  
ET2 - ET4 - 50 cc



- 1601014**  
Coppia ammortizzatori posteriori  
**Piaggio** completi  
Piaggio Beverly 125-250-300"  
Tourer - Euro 3 - RST  
Dal 2001 - 2010  
(P.56138R-56174R-597327-  
598923)



- 1056232**  
Ammortizzatore posteriore  
**Piaggio** completo  
Piaggio Liberty 125-150-200  
2006-2013 (P.56232R)  
**1056232 EC**  
Tipo Economico



- 1058518**  
Ammortizzatore posteriore  
Piaggio Beverly 125 - 300 - RST  
2010 - 2018 (P.58518R5)



- 1056286**  
Ammortizzatore anteriore  
**Piaggio** completo  
Piaggio Vespa 125-200-250-  
300 Super GTV-GTS-4T-GT-  
GTV 60-Granturismo  
(P.601876-597765-56263R-  
56192R)



- 1646959**  
Ammortizzatore anteriore  
**Piaggio** completo  
Piaggio Vespa LX 150 Touring  
2005-2013 Vespa LX 50-125-  
150 2T-4T-IE (P.601997-56214R-  
56266R-58509R)



- 1056452**  
Ammortizzatore anteriore  
completo Piaggio Vespa  
GTS-300 2010 - 2013 -  
Vespa GTS Super IE 4T 3V  
150 2014 - Vespa GTS  
Super 300 2008 - 2013 -  
Vespa GTS IE 4T Super 125  
2009 - 2015 - Vespa GTS  
250 2005 - 2014 (P. 56452R)





**1056174** Coppia ammortizzatori posteriori  
**Piaggio** Beverly RST-Tourer  
125-250-300 (39 mm) (R.O. 56174R)



**55565** Ammortizzatore posteriore  
**registrabile - Aprilia**  
Scarabeo  
Interasse mm 290



**58319** Ammortizzatore completo  
**Yamaha** Majesty 250 -  
**Aprilia** Leonardo 250 -  
**Peugeot** Eliseo 125/150 4T -  
Skylaner 250 - Madison 125/150 -  
BMW C1



**58291** Coppia ammortizzatori posteriori  
registrabili - **Honda** SH 125-150

**58263** Coppia ammortizzatori posteriori  
registrabili - **Aprilia** Leonardo 125-150  
dal 99 (adatt. 8123796)



**58289** Ammortizzatore posteriore registrabile  
**Scarabeo** 125-150 dal 99  
(adatt. 8123795)

**100702**

Serie completa calotte sterzo -  
Ciao - Bravo  
completa di gabbie a sfera - dado

**100493**

Serie completa calotta sterzo -  
Boxer - Bravo - SI - Zip - Free

**1153025**

Serie superiore calotte sterzo - Vespa 50 - 90 - 125 Primavera - ET3  
- P125X - P150X - P200E - PK50 - PK125 - PX125E -  
PX150E - PX200E (Serie Arcobaleno) - Quartz - Zip Fast Rider -  
Typhoon - Skipper - Hexagon

**1153024**

Serie inferiore calotte sterzo - Vespa 50 - 90 - 125 Primavera - ET3 -  
P125X - P150X - P200E - PK50 - PK125 - PX125E -  
PX150E - PX200E (Serie Arcobaleno) - Quartz - Zip Fast Rider -  
Typhoon - Skipper - Hexagon

**1153507**

Serie calotte superiori - Ape MP - MPM - MPV - Ape CAR

**1154606**

Serie calotte superiori - Ape TM P602 - TM P703 - TM P703V

**1153915**

Serie calotte superiori - Ape 50

**5748**

Serie calotte Vespa 125 VNA - VNB 3 - VBA  
VBB 1T - VGLB 1T



- 1153508** Serie calotte inferiori - Ape MP - MPR - MPM - MPV
- 1154536** Serie calotte inferiori - Ape CAR
- 1154605** Serie calotte inferiori - Ape TM P602 - TM P703 - TM P703V
- 1154509** Serie calotte inferiori - Ape 50



- 15974285** Serie completa calotta sterzo **Piaggio**  
Beverly 125-200-250 RST 2001 - 2007



- 16008725** Serie completa calotta sterzo **Piaggio**  
Beverly 125-200-300 - Tourer - Cruiser euro 3



- 55677** Serie completa calotte sterzo - Booster Spirit - Malaguti F10
- 55678** Serie completa calotte sterzo - Target
- 55678 B** Serie completa calotte sterzo - Booster NG - Spirit - Rocket - Track - Nitro - Ovetto
- 55679** Serie completa calotte sterzo - Aprilia SR - Scarabeo (adattabile 8203666)
- 55710** Serie completa calotte sterzo  
Honda: SH50 - Vision - Lead - Wallaroo - Bali  
Peugeot: 50 - 80 - 125 - SC - SV



- 58290** Serie calotte sterzo  
MBK Nitro - Yamaha Aerox dal 2002



- 58316** Serie calotte sterzo  
Peugeot Speedfight
- 58317** Serie calotte sterzo  
Honda SH 125-150
- 58318** Serie calotte sterzo  
Kymco Dink 50-125-150  
Heroism 50-125-150



- 58596** Serie Calotte Sterzo Honda SH 300

**1198122**

Scudetto per frontale Vespa PK50XL - PK125XL - 50V F.L. 2

**1256344**

Frontale Vespa 50V F.L. 2 - PK50XL - PK125XL

**1256344B**

Frontale Vespa PK50XL - PK125XL - Rush

**1198122**

Scudetto per frontale Vespa PK50XL - PK125XL - Rush

**1198122**

Scudetto per frontale - PX125E - PX150E - PX200E (Serie Arcobaleno)

**1198123**

Targhetta per frontale - PX125E - PX150E - PX200E (Serie Arcobaleno)

**1219118**

Frontale - PX125E - PX150E - PX200E - (Serie Arcobaleno)

**1219119**

Griglia per frontale - PX125E - PX150E - PX200E Arcobaleno (mm. 115)

**1219119 CR** Come sopra **cromato****1183779 N**Copristerzo - P125X - P150X - P200E - **Nero****80330 C**

Confezione targhetta - scudetto e vite di fissaggio per copristerzo





**1232893** Frontale Vespa T5



**1232894** Griglia per frontale Vespa T5



**1214387** Frontale PK 50 - PK 125 (1ª serie)  
PK 50 S - PK125 S



**1149876** Scudetto per frontale PK 50 - PK 125 (1ª serie)  
PK 50 S - PK 125 S



**1216719** Targhetta per frontale PK 50 - PK 125 (1ª serie)  
PK 50 S - PK 125 S



**1672792** Frontale PX 125 - PX 150  
MILLENNIUM - Freno disco



**1295486** Scudetto PX 125 - PX 150  
MILLENNIUM - Freno disco



**1576967** Griglia cromata Vespa PX 125 - PX 150  
MILLENNIUM (mm. 108) - Freno disco

11



**72102** Copristerzo - Vespa 50 - 90 - 125 Primavera - ET3



**72107** Modanatura per copristerzo (con molle) -  
Vespa 50 - 90 - 125 Primavera - ET3



**72102 N** Copristerzo Vespa 50 - 90 - Primavera ET3 -  
nero



**55252 N** Serratura completa bauletto - Vespa PX125E -  
PX150E - PX200E (Serie Arcobaleno) - XL

**55252 EC** Modello economico



**1025911** Serratura sacca  
Vespa 150 - VL3 - VB1 - 150GS - V 2-3-4-5  
(P. 025911)



**1178961** Leva per serratura bauletto - Vespa PX - PK - XL

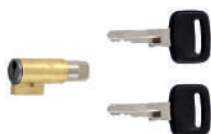

**100466** Serratura antifurto tipo ZADI - Ciao - Boxer - Bravo -SI -  
corta (nasello mm 6)

**100466 EC** Modello economico

**1139371** Serratura antifurto tipo ZADI - 50 - 90 - 125 Primavera -  
P125X - P150X - P200E - lunga (nasello mm 6)

**79556** Serratura antifurto tipo NEIMAN - corta - Vespa 50 -  
90-125 Primavera - 125/150 - Rally - Ape 50 - al 1976  
- Ciao - Boxer - Bravo (nasello mm 4)

**79556 EC** Modello economico

**71961** Serratura antifurto tipo NEIMAN - lunga - Vespa 50 - 90  
- 125 Primavera - 125/150 Super - Sprint - Rally -dal  
1977 - P125X - P150X - P200E (nasello mm 4)

**71961 EC** Modello economico



**71961N** Serratura lunga (P. 152096 / 139188) (nasello mm. 4)  
Vespa 50 - 90 - 125 Primavera - 125 - 150 Super Sprint -  
Rally - P125X - P150X - P200E - CHIAVI TIPO NIEMAN



**100466 C** Serratura antifurto tipo ZADI (completa) - Ciao - Boxer -  
Bravo - SI - corta (nasello mm 6)



**55374** Kit sportellino + chiodo - molla



**86863** Serratura bauletto - Vespa 125S - Rally - P125X  
-P150X - P200E - 125 Primavera - Sprint - Super

**86863 EC** Modello economico



**1163259 CR** Serratura completa sella Vespa PX **CROMATA**



**1163259** Serratura completa sella Vespa PX



**1174754** Serie serratura completa  
Vespa 125 VNL 2 - VMA 2 - VMB 1  
Vespa 150 VBC 1T - VLB 1T  
Vespa PX 125 - 150 - PE 200



**58321** Serie serratura completa  
Vespa PX 125-150-200 E - Arcobaleno  
PX 125-150 - freno disco - **(cromata)**  
Completo di 3 cilindretti





**58516** Serie completa serrature (sterzo, bauletto) singola chiave - Vespa P125 X - P150 X - P200 E (nasello mm. 6)

**58516 EC** Mod. economico



**80187** Coppia serrature sterzo e bauletto (con un solo tipo di chiave) - Vespa 125 g.t.r. - 125 "ts" - 150 Super - 150 Sprint - Rally 200

**80187 EC** Modello economico



**1082416** Serratura bloccasterzo  
Vespa 125 - 150 dal 1951 - 1964  
**Attacco mm 450**



**1082416 B** Serratura bloccasterzo  
Vespa 125 - 150 dal 1951 - 1964  
**Attacco mm 245**



**62072** Corpo serratura  
Vespa 150GS - VSB1T



**1059263** Serratura cofano laterale Vespa 125 - Hoffmann 150 - T1 3/CS - VL - VB1 - VS1 - 125 VN - 150 VL - Faro Basso (P. 59263)



**1256967** Cornice "ON-OFF" - Zadi - PK50XL - Rush - Free - Skipper 125-150 - Cosa 2 - CL - CLX - Sfera 1992-93 - Vespa FL - FL2 - HP



**1254536** Cornice "On-Off" - Zadi - Vespa Arcobaleno - T5 - Hexagon - PK - XL - Rush - N - Zip - NRG - NTT



**1298581** Cornice "ON-OFF"  
**Gilera**  
Ice 50 / 01 - Runner 50 - FL - Poggiali Purejet / 97/04  
Runner 125/150/200-Fx/Fxr/Vx/Vxr / 97/02  
**Piaggio**  
Beverly 125/200/250/500 / 01/04 - Rst 125 / 04 -  
Fly 50 2-4T - 150 cc / 05 - Hexagon Lx4 125 /  
Lx-Lxt 125-180 / 98/99 - Super Gtx 12" 125/180 / 01/02  
Hexagon Gts - Hexagon Gtx 250 / 98/00  
Super Hexagon Gtx 125/180 / 00 - Liberty 50 2/4T / 97/02 -  
Rst 50 2/4T - 125 / 04 - Rst 125/150/200 -  
Skipper 4T 125-150 - Lx 125-150 - Vespa 50 Et2 iniezione -  
Et4 50 - Et4 125-125-150 - Vespa Gran Turismo 125-200  
X8 125-200 - X9 125-200-250-500 -  
X9 Evolution 125-200-250-500 - X9 Amalfi 180 -  
Zip Sp 50 - Zip 50- 4T





**1196467** Serie serrature (5 cilindretti + 2 chiavi) per Vespa PK



**1196486** Serratura bauletto - Vespa PX125E - PX150E - PX200E  
(Serie Arcobaleno - 1 serratura, 2 chiavi)

**1196486 EC** Mod. economico



**1179292** Serie completa serrature - Vespa PX125E - PX150E - P200E  
(Serie Arcobaleno - 3 serrature, 2 chiavi) - Typhoon - Skipper

**1179292 EC** Mod. economico

**1259547** Serie completa serrature - Zip - Zip Fast Rider



**1258664** Serratura completa - Ape tm P50



**1265828** Serie completa serrature (sterzo, sella, bauletto anteriore)  
3 cilindretti, 2 chiavi - Vespa PK50XL - Rush - 50N -  
50V F.L. 2



**1257703** Serie completa serrature - "Sfera" - Quartz - Storm - NRG

**1256937** Serie completa serrature - Vespa HP - V - N  
(2 rotori - 2 chiavi)



**1573512** Serie completa serrature - (2 cilindretti) - Vespa ET2 - Liberty



**90158** Perno completo sospensione anteriore - Ape 175



**91133** Perno completo sospensione anteriore - Ape 50 - con foro ingrassatore

**1154676 C** Perno completo sospensione anteriore - Ape 50 - dal 1985



**93179** Perno completo sospensione anteriore - Ape MP



**93750** Perno completo sospensione anteriore - Ape MPR - MPM - MPV - Ape CAR



**97045** Perno completo sospensione anteriore - Ape MPR - MPM - MPV - Ape CAR - con foro per ingrassatore



**1154604** Perno completo sospensione anteriore - Ape 602 - P703 - TM

**1154604 M** Perno completo sospensione anteriore - Ape 602 - P703 - TM - con foro ingrassatore



**55508** Perno completo sospensione - Ape TM Maxi



**73677** Perno completo sospensione anteriore - Vespa 125/150 al 1963 Ape C



**86655** Perno completo sospensione anteriore - Vespa GS 160 - 180SS



**74876** Perno completo sospensione anteriore - Vespa Sprint - GT - Super - Rally



**71315** Perno completo sospensione anteriore - Vespa 50 - 90 - 125 Primavera



**1174098 C** Perno completo sospensione anteriore - Vespa P125X - P150X - P200E al 1981

**1177451 C** Perno completo sospensione anteriore - Vespa P125X - P150X - P200E dal 1982 - PX125E - PX150E - PX200E (Serie Arcobaleno) - "Sfera"



**71707** Tamburo ruota posteriore in alluminio - 5 attacchi  
Vespa 50 Special - 50SS - 90SS - 125 Primavera - ET3

**71733** Tamburo ruota anteriore in alluminio - 5 attacchi  
Vespa 50 Special - 50SS - 90SS - 125 Primavera - ET3

**79547** Tamburo ruota posteriore - Vespa 150 VBB2 - GL -  
Sprint - Rally - P125X - P150X - P200E



**1216001** Tamburo ruota anteriore - Vespa PK50 - PK50S

**1215993** Tamburo ruota posteriore - Vespa PK50 - PK50S - PK125 -  
PK125S - PK50XL - 125XL - Rush - N - V

**1235940** Tamburo ruota posteriore - Vespa PX125T5 - PX Freno disco

**1174032** Tamburo ruota anteriore - Vespa PX - perno da 16

**1177444** Tamburo ruota anteriore - Vespa P125X - P150X - P200E -  
dal 1982 - PX125E - PX150E - PX200E (Serie Arcobaleno) -  
PX125T5



**1194433** Tamburo ruota posteriore - Vespa P125X - P150X - P200E -  
dal 1982 - PX125E - PX150E - PX200E (Serie Arcobaleno)



**74348** Tamburo freno posteriore Vespa 150 - '59/64  
VNA - VNB (P. 23831)



**91241** Tamburo ruota posteriore - Ape TM1 - TL2 - tm P50



**71186** Bullone ruota Vespa  
tutti i tipi (adatt. P.70156 - P.139466)



**71281** Coperchio mozzo - Vespa 50 - 90 -  
125 Primavera - ET3  
**Lucido**



**71281 N** Coperchio mozzo - Vespa 50 - 90 -  
Primavera ET3 - **nero**



**71324** Scatoletta mozzo anteriore - Vespa 50 - 90 -  
125 Primavera - ET3



**1178048** Coperchietto mozzo - Vespa PX  
(Serie Arcobaleno)



**1178048N** Coperchio mozzo  
Vespa PX - 2ª serie - Nero



**1174359** Coperchio mozzo  
Vespa PX125 - 150 - 200PX - PE



**1216966** Coperchio Mozzo  
Vespa PK 50 S - PK 50 XL



**62005** Coperchio sospensione anteriore in alluminio  
Vespa 125 VNB 6T - VNC 1T - VNL 3T  
Vespa 150 VBC 1T - VNL 2T dal 30001 - VLB 1T  
Vespa Rally 180 VSD 1T - Vespa Rally 200 VSE 1T  
P. 079227



**62006** Coperchio sospensione anteriore in alluminio  
Vespa 125 dal V 30T al V 33T - VM 1/2T -  
VN 1T - VNB 1/2/3/4/5T  
Vespa 150 VL 1/2/3T - VBA 1T - VBB 1/2T  
Vespa 150 GL VLA 1T - Vespa 150 GS VS  
1/2/3/4/5T - P. 015435



**62000** Coperchio sospensione anteriore in alluminio  
Vespa GS160 - VSBI - P. 56778



**71937** Coperchio contachilometri - Vespa 50 Special

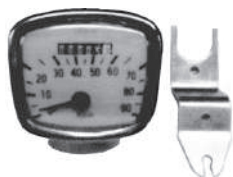

**58379** Contachilometri - Vespa 125 VNB 58/65



**71369** Contachilometri - Vespa 50



**71369 C** Contachilometri vespa 50 N-L-R Scala 80 Km/h Completo di trasmissione e pignoncino rocchetto (P.190748)



**71960 C** Contachilometri Vespa 50 Special Elestart Scala 80 Km/h completo di trasmissione e pignoncino rocchetto (P. 123474)



**71960** Contachilometri - Vespa 50 Special



**58385** Kit trasmissione / rinvio per 71369 - 71960



**1190523** Contachilometri - Vespa P125X - 150X - P200E cornice cromata



**1190523 N** Contachilometri Vespa PX 125 - PX 150 - PX 200 E Cornice nera



**1190523 C** Contachilometri **cromato** Vespa PX 125 - 150 - 200 Scala 120 Km/h completo di trasmissione e pignoncino rocchetto (P. 190523)



**1190523 NC** Contachilometri **Nero** Vespa PX 125 - 150 - 200 - 1ª Serie Scala 120 Km/h completo di trasmissione e pignoncino rocchetto



**1583074** Contachilometri - Vespa PX - Freno disco -  
PX Millennium



**71781 B** Contachilometri  
125 Primavera - **(Bianco)**  
Super 125-150 - SS



**71781 BC** Contachilometri Vespa 125 Primavera  
Scala 120 Km/h completo di trasmissione e  
pignoncino rocchetto (P. 121051)



**71781 N** Contachilometri  
ET3 - Sprint - **(Nero)** - Rally 180-200 - Veloce

**71781 NC** Contachilometri Vespa 200 - Vespa Rally  
Scala 120 Km/h completo di trasmissione e  
pignoncino rocchetto (P.141712)



**1089377** Contachilometri 100 Km/h  
Vespa 150 VBA1T - VBB1/2T - VGLA - VGLB  
Vespa 150 GL VLA1T



**1098844** Contachilometri 110 Km/h  
Vespa 125 - VNL2T dal telaio 30001  
Vespa 150 - VLB1T dal telaio 195330 -  
VLA1T - VLB1T



**1089379** Contachilometri 120 Km/h  
Vespa 150 GS VS5T  
Vespa 160 GS VSB1T



**58495** ontachilometri Vespa 125 VM VN -  
Vespa 150 VL Struzzo (51-57)  
Veglia connessione mm. 1,9



**58496** Contachilometri  
Vespa 125 VM VN - Vespa 150 VL 1 Struzzo  
Vespa 150 VL 2 - 3 - Connessione mm. 1,9



**71303** Ingranaggio contachilometri  
Vespa 50 - 90 - 125 Primavera - Z8 - **Rosso**

**71304** Ingranaggio contachilometri  
Vespa 50 - 90 - 125 Primavera - Z10 - **Rosso**

**74869** Ingranaggio contachilometri  
Vespa 125/150 - quadro mm 2,7 - Z11 - **Bleu**



**79780** Ingranaggio contachilometri  
Vespa 125/150 - quadro mm 2,7 - Z9 - **Nero**



**1174048** Ingranaggio contachilometri  
P125X - P150X - P200E - al 1981 - Z12 - **Bianco**

**1177508** Ingranaggio contachilometri  
P125X - P150X - P200E - dal 1982 - Z12 - **Grigio**

**1217128** Ingranaggio contachilometri  
Vespa PK125 - PK125S - **Arancione**



**55892** Rinvio c/km - MBK Booster



**58556** Rinvio c/Km Aprilia Scarabeo  
50-100 2T-4T 1993-2012



**1560974** Rinvio c/Km PIAGGIO Liberty 4T 50 200-2002  
Liberty PTT  
Liberty 50-125 1997-2005



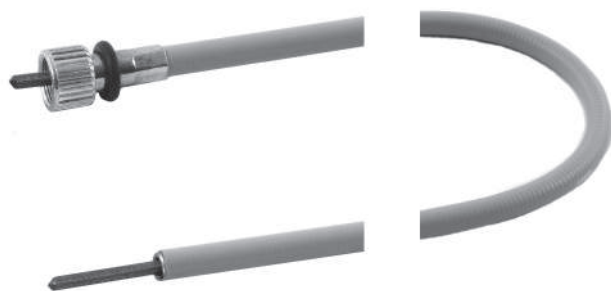

### TRASMISSIONI CONTACHILOMETRI

- |  |   |  |
|--|---|--|
| <b>71835</b> Vespa 50 - 90 - 125 Primavera                               | <b>1270977</b> Gilera Typhoon                                       | <b>55620</b> Malaguti F15                                  |
| <b>79187</b> Vespa 125 VNB 1 - 2 - 3 - 4 - 150 GL                        | <b>1272340</b> Zip (attacco rapido) Zip Fast Rider                  | <b>55621</b> Honda Bali                                    |
| <b>79374</b> Vespa 150 VBA - VBB   | <b>1273667</b> Sfera - RST  | <b>55622</b> Honda SH50 dal '96                            |
| <b>79823</b> Vespa Sprint - GTR - Super - Rally 180 - 125 ts - Rally 200 | <b>1600540</b> Liberty 50 2T - 4T - RST - 2004-2006                 | <b>55665</b> Leonard 125/150                               |
| <b>86805</b> Vespa GS 160 - GS 180                                       | <b>1600281</b> Liberty 125-200 - RST 2004-2005 125 RST PTT (Leader) | <b>55628</b> Peugeot Speedfight                            |
| <b>86866</b> Vespa GS 180 SS   | <b>1599866C</b> Beverly RST 125-250 2004-2005                       | <b>55792</b> Scarabeo 125 - 150 Leonardo 125 - 150         |
| <b>90404</b> Ape 175   | <b>1599685C</b> Beverly 500 2002-2006                               | <b>55793</b> Aprilia SR 95-96                              |
| <b>91090</b> Ape 50 TL   | <b>55387</b> Aprilia Amico (al 1991)                                | <b>55794</b> Aprilia SR - SR Stealth 125 - 150             |
| <b>91091</b> Ape 250 TM  | <b>55388</b> Aprilia Amico (dal 1992)                               | <b>55795</b> Honda SFX                                     |
| <b>93260</b> Ape MP  | <b>55389</b> MBK Booster  | <b>55796</b> Honda Sky                                     |
| <b>93584</b> Ape MPR   | <b>55518</b> Booster R - Yamaha - Breeze - Flame R                  | <b>55797</b> Kymco 50 Top Boy                              |
| <b>93585</b> Ape MPM   | <b>55519</b> Booster NG   | <b>55798</b> Kymco 50 People                               |
| <b>97122</b> Ape CAR   | <b>61612</b> Malaguti "Centro"                                      | <b>55799</b> Kymco 50 - 125 - 150 Dink                     |
| <b>1194371</b> Ape TM  | <b>61613</b> MBK Target   | <b>55800</b> Kymco 125 Movie                               |
| <b>100875</b> Ciao   | <b>61615</b> Peugeot SC Metropolis                                  | <b>55801</b> Kymco 125 Heroism                             |
| <b>100876</b> Boxer  | <b>61616</b> Peugeot ST   | <b>55802</b> Malaguti Crosser                              |
| <b>100877</b> Bravo  | <b>61617</b> Peugeot Rapido   | <b>55803</b> Peugeot 50 - 100 cc Elisee                    |
| <b>1174161</b> Vespa P125X - P150X - P200E                               | <b>61618</b> Peugeot SV - Geo                                       | <b>55804</b> Peugeot Speedfight                            |
| <b>1183582</b> Vespa ET3   | <b>61624</b> Peugeot Zenith   | <b>55805</b> MBK Spirit - Yamaha BW'S                      |
| <b>1186324</b> SI  | <b>61625</b> Peugeot Buxy   | <b>55806</b> MBK Track - Yamaha Bumb Spy                   |
| <b>1195407</b> Vespa PK50 - PK125 - PK50XL - PK125XL - Rush - N          | <b>55543</b> Typhoon dal 1996                                       | <b>55807</b> MBK Cignus R - Yamaha flame 125 1ª serie      |
| <b>1179271</b> Vespa PX125E - PX150E - PX200E (Serie Arcobaleno)         | <b>55566</b> Aprilia Scarabeo                                       | <b>55808</b> MBK Flipper - Yamaha Why                      |
| <b>1229358</b> Cosa  | <b>1561805</b> Vespa ET2 - ET4                                      | <b>55809</b> MBK Nitro - Yamaha Aerox                      |
| <b>1266321</b> Vespa 50V F.L.2   | <b>1560973</b> Piaggio Liberty                                      | <b>55810</b> MBK Ovetto                                    |
| <b>1266848</b> Sfera   | <b>1298746</b> NTT - NRG MC2  | <b>55811</b> MBK Skyliner - Yamaha Majestic 125            |
| <b>1268263</b> Quartz - Skipper  | <b>1561997</b> ZIP SP   | <b>1273456</b> 125 - 150 Hexagon                           |
| <b>1268292</b> Free  | <b>1561152</b> Gilera Stalker                                       | <b>1561710</b> Gilera Runner                               |
| <b>1269062</b> Zip   | <b>55619</b> Malaguti F12   | <b>1563796</b> Vespa PX - freno disco dal 1998 al 2001     |
|  |   | <b>58172</b> SH 125-150 - (adatt. Honda 44830 - KPR - 900) |
|  |   | <b>58173</b> SH 125-150                                    |
|  |   | <b>58295</b> Honda @ 125-150 (Honda 44830 - KGF - 900)     |





- 1650836** Trasmissione C/Km Vespa S 50-125-150
- 1650837** Trasmissione C/Km Vespa GTV 125-250-300
- 1650838** Trasmissione C/Km Vespa LXV 50-125
- 1650849** Trasmissione C/Km Vespa GTS Super I E 4T 3V - GTS I E - GTS 4T I E Super - GTS Super - GTS - GTS Super Sport - GTS I E Touring
- 1651072** Vespa Gran Turismo 125 - GTS 125 2007-2012

## TRASMISSIONI CONTACHILOMETRI

- 1649347** Vespa LX 4T 3V I E - Touring 150 2012-2013 - Vespa LX 4T 3V I E - Touring 125 2012-2013 - Vespa LX 4T 4V Touring 50 2010-2013 - Vespa LX 2T Touring & 30Km 50 2010-2013 - Vespa LX 4T - 4V 50 2009-2013 - Vespa LX 2T 50 2009-2013 - Vespa LX Touring 150 2010-2012 - Vespa LX 4T EURO 3 Touring 125 2010-2011 - Vespa LX EURO 3 I E 150 2009-2011 - Vespa LX EURO 3 I E 125 2009-2011 - Vespa LX 4T FL 150 2009-2009 - Vespa LX 4T FL 125 2009-2009 - Vespa LX EURO 3 150 2006-2008 - Vespa LX EURO 3 125 2006-2008 - Vespa LX 4T 50 2005-2008 - Vespa LX 2T 50 2005-2008 - Vespa LX 150 2005-2006 - Vespa LX 125 2005-2006

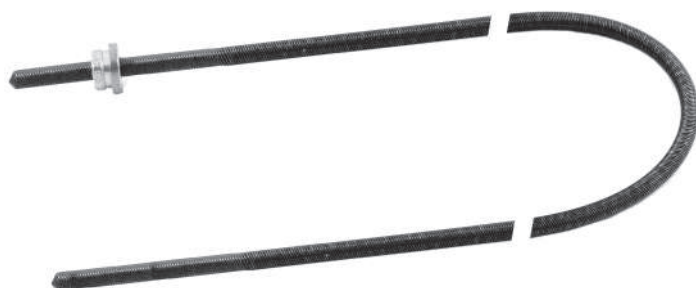

## CAVI INTERNI CONTACHILOMETRI

- 71805** Vespa 50 - 90 - 125 Primavera
- 79143** Vespa 125 VNB 1 - 2 - 3 - 4
- 79352** Vespa 150 VBA - VBB
- 86848** Vespa GS 180 SS
- 90371** Ape C4
- 90372** Vespa Sprint - GTR - Super - Rally 80 - Rally 200 - 125 ts - Ape 175
- 93214** Ape MP
- 93540** Ape MPM
- 97090** Ape CAR
- 100859** Ciao
- 100860** Boxer
- 100861** Bravo
- 1174160** Vespa P125X - P150X - P200E
- 1186332** SI
- 1195409** Vespa PK50 - PK125 - PK50XL - PK125XL - Rush - N
- 1563797** Vespa PX - freno disco dal 1998 al 2001
- 1179272** Vespa PX125E - PX150E - PX200E (Serie Arcobaleno)
- 1267160** Vespa 50V F.L.2
- 1267750** Sfera - Quartz - Skipper
- 1229357** Sfera - RST - Cosa
- 1269063** Zip
- 1270978** Gilera Typhoon
- 1268293** Free
- 55448** Gilera ECO
- 55449** Zip Fast Rider
- 55544** Typhoon dal 1996
- 55567** Aprilia Scarabeo
- 1561806** ET 2
- 1563075** Liberty
- 58294** Honda @ 125-150



**55377** Leva destra - Aprilia Amico - MBK Booster

**55378** Leva sinistra - Aprilia Amico - MBK Booster



**1176945** Leva sinistra in plastica - **Nera** - Ciao PX - Bravo - SI



**1177340** Leva destra in plastica - **Nera** - Ciao PX - Bravo - SI



**1176946** Leva alzavalvola in plastica - **Nera** - Ciao PX - Bravo - SI



**55276** Leva alzavalvola - Ciao 1988 - SI 1988 - Boss



**1228967** Leva sinistra in alluminio sagomata - **Nera**  
Ciao PX 1988 - SI 1988 - Boss

**1228966** Leva destra in alluminio sagomata - **Nera**  
Ciao PX 1988 - SI 1988 - Boss



**1165279** Leva freno frizione - Vespa 50 - 90 - 125 Primavera - ET3  
**Lucida**

**80201** Leva freno frizione - Vespa P125X - P150X - P200E  
**Lucida**

**1225340** Leva freno frizione PX125E - PX150E - PX200E  
(Serie Arcobaleno) - **Lucida**



**79621** Leva freno-frizione - Vespa 50 - **pallino piccolo**



**1274546** Leva destra - Vespa HP (alluminio lucido)

**1274547** Leva sinistra - Vespa HP (alluminio lucido)



**55671** Coppia leve destra e sinistra  
MBK Booster - NG - NITRO (alluminio)



**1178705/365** Coppia leve freno frizione **nera**  
Vespa PK - XL - Rush - N



**1248318/319** Coppia leve freno frizione **grigie**  
Vespa PK - XL - Rush - N



**1265947** Leva grigia destra Vespa 50 V F.L. 2

**1265948** Leva grigia sinistra Vespa 50 V F.L. 2



**1267954** Leva nera sinistra Skiper - Zip - Zip F.R. - Typhoon

**1271999** Leva nera destra Skiper - Zip - Zip F.R. - Typhoon

**1494473** Leva lucida destra ET2 - ET4 - Liberty

**1560579** Leva lucida sinistra ET2 - ET4 - Liberty



**1646803** Leva destra

**1564683** Leva sinistra

Piaggio Fly 50 - Vespa S - NRG - GTS -  
Liberty 50 - 125 - 200 - Vespa LX 50 - 125 - 150



**55890** Leva dx - sx - Aprilia SR 2000



**55890 L** Leva dx-sx lucida - Aprilia SR dal 2000  
(adatt. 8218288)

**1267689** Leva sx - Cosa 1-2

**1267685** Leva dx - Cosa 1-2

**55478** Leva sinistra **nera** - Aprilia Scarabeo  
freni tamburo - (R.O. 8218176)

**55478 L** Leva sinistra **lucida** - Aprilia SR 50 FD -  
Gulliver 50 FD impianto Grimeca - (R.O. 8218274)



**55478-1** Leva sinistra **lucida** - Aprilia Scarabeo  
freni tamburo - (R.O. 8218329)

**55781** Leva sinistra **lucida** - Aprilia Scarabeo 2 FD -  
(ant.-post.) - Leonardo 125-150 1ª serie - (R.O. 8118461)



**55477** Leva destra **nera** - Aprilia Scarabeo  
freni tamburo - (R.O. 8218172)

**55477 L** Leva destra **lucida** - Aprilia Scarabeo freni tamburo

**55780** Leva destra **lucida** - Aprilia Scarabeo 2 FD  
(ant.-post.) - Leonardo 125-150 1ª serie -  
SR 50 FD Grimeca - (R.O. 8218273)



**55780 N** Leva destra **nera** - Aprilia Scarabeo FD  
Grimeca - (R.O. 8218156)



**58119 Malaguti** Madison 125-150-180-200-250-400 - 99/02  
 Madison Restyling 125-400 2002  
 (R.O. 12114303) (dx - sx)



**58120 Gilera** Dna 50-125-180-Ice 50  
**Piaggio** Beverly 125-200-X9 125-250-500-  
 Amalfi 180  
**MBK** Skyliner 125-150 98/02  
 Dodo 125-150 2000/02  
 Thunder 125-150 2001/02  
**Yamaha** Majesty 125-150 98/02  
 Maxter 125-150 2001/02  
 Teo's 125-150 2000/02  
 (dx - sx - Brembo)



**58121 Piaggio** Beverly 125-200  
 (dx - sx - Heng Tong)

**58187 Honda** Leva manubrio destra - Honda SH 125-150 -  
 Chiocciola 125-150 (adatt. 53175 - GCS - 006)

**58188 Honda** Leva manubrio sinistra - Honda SH 125-150 -  
 Chiocciola 125-150 - (adatt. 53178 - GCS - 000)



**58381 Honda** Leva dx - SH 300



**58382 Honda** Leva sx - SH 300



**1242314** Leva frizione Vespa PX 125 - 150  
 Arcobaleno **freno disco**

**1494804** Leva freno Vespa PX 125 - 150  
 Arcobaleno **freno disco**



**79658** Vite fissa leve freno e frizione - Vespa - tutti i tipi



**100741** Vite con dado fissa leva freno e frizione - PK



- |                |  |                |   |
|----------------|--|----------------|---|
| <b>1188056</b> | Comando sinistro - SI - CIAO PX  | <b>55384</b>   | Portaleva destro - Peugeot ST50 - ST125 - GEO                                     |
| <b>1188057</b> | Comando GAS - SI - CIAO PX   | <b>55479</b>   | Portaleva destro - Aprilia - Scarabeo   |
| <b>1268071</b> | Comando sinistro - SI - CIAO F.L.2   | <b>55480</b>   | Portaleva sinistro - Aprilia - Scarabeo   |
| <b>1268072</b> | Comando GAS - SI - CIAO F.L.2  | <b>55481</b>   | Portaleva destro - Peugeot - Speedake - Buxy - Zenith                             |
| <b>1268085</b> | Comando GAS - SI - CIAO F.L.2 - Con frecce   | <b>55482</b>   | Portaleva sinistro - Peugeot - Speedake - Buxy - Zenith                           |
| <b>1267252</b> | Comando sinistro - Sfera   | <b>55980</b>   | Comando sinistro Scarabeo 50 2 Freni disco  |
| <b>1267114</b> | Comando GAS - Sfera  | <b>55981</b>   | Comando sinistro SR 50 dal '96 - SR 50 WWW  |
| <b>1268722</b> | Comando sinistro - ZIP   | <b>55982</b>   | Comando sinistro Booster Spirit 2000 - N.G. - Track - Yamaha - BWS '2000 - Rocket |
| <b>1268721</b> | Comando GAS - ZIP  | <b>55983</b>   | Comando sinistro Booster R - Spirit   |
| <b>55403</b>   | Comando GAS - Gilera - Typhoon   | <b>55984</b>   | Comando sinistro Ovetto - Neo's   |
| <b>55404</b>   | Comando portaleva - Gilera - Typhoon   | <b>55985</b>   | Comando sinistro Flipper - Why  |
| <b>1560422</b> | Comando Gas Piaggio Sfera 50-125 - RST   | <b>55986</b>   | Comando sinistro MBK Stunt  |
| <b>1274498</b> | Comando Gas Piaggio Zip F.R. - RST - SP - Skipper 125-150                            | <b>55987</b>   | Comando sinistro Majestic 125 dal 2000  |
| <b>1561807</b> | Comando gas - Vespa ET2 - ET4 - Liberty  | <b>1560373</b> | Comando sinistro Piaggio Sfera 50-125 - RST                                       |
| <b>1274211</b> | Portaleva sinistra - Vespa ET2 - ET4 - Liberty                                       | <b>1274585</b> | Comando sinistro Piaggio Zip F.R. - RST - SP - Skipper 125-150                    |
| <b>55375</b>   | Comando GAS - Aprilia Amico  | <b>55988</b>   | Comando Gas Scarabeo 50 1 Freno disco   |
| <b>55381</b>   | Comando GAS - MBK Booster  | <b>55989</b>   | Comando Gas Scarabeo 50 2 Freni disco   |
| <b>55382</b>   | Comando sinistro - MBK Booster   | <b>55990</b>   | Comando Gas SR dal '96  |
| <b>55383</b>   | Portaleva sinistro - Peugeot ST50 - ST125 - GEO - Aprilia Amico - Sport - LK - LX 92 | <b>55992</b>   | Comando Gas Booster N.G. - Spirit 2000 - Track - Rocket - BW'S 2000 - Stunt       |
|                |  | <b>55993</b>   | Comando Gas MBK Flipper - Why   |
|                |  | <b>55994</b>   | Comando Gas Majestic 125 dal 2000   |



**1229741/745** Coppia manopole - Sfera - Zip - Zip Fast Rider - Free - Typhoon

**1560580/582** Coppia manopole - Vespa ET2 - ET4 - Liberty



**1274489/491** Coppia manopole ø 22 - 24  
Sfera dal 1955 - NRG - NTT - Skipper

**1274489** Coppia manopole - Vespa HP - ø 22



**1227077** Manopola - Vespa PK50XL

**1248317** Manopola - Vespa Rush - 50N - 50N Speedmatic



**72046** Manopola - Vespa 50 - 90 - 125 Primavera - ET3 - Vespa Super - Ape 350 - 400 - 500 - MPM - MPV - tipo originale

**79941** Manopola - Vespa 125 gtr - Sprint - 180 Rally - 200 Rally - PX tipo originale



**1178159** Manopola gomma - Vespa PK - tipo originale



**1179833** Manopola - Vespa PX125E - PX150E - PX200E - tipo originale (Serie Arcobaleno)



**1233072/075** Coppia manopole - Ciao PX - SI - F.L.



**1266187** Manopola - Vespa 50V F.L. 2



**1582324** Manopole Vespa PX 125-150-200  
Freno disco dal 1998 - PX Millenium



**58315** Coppia manopole ø **24** - (grigie)  
Vespa 50 A1T - SS1T  
Vespa 90 A1T - SS1T  
Vespa 125 VMA1T - VNA - VNB  
Vespa 150 VL3T



**79156** Coppia manopole ø **21** - (grigie)  
Vespa 125 VNB 3/4/5/6T  
Vespa 150 VB1T - VBA1T - VBB1/2T  
Vespa 150 GL VLA1T  
Vespa 160 GS VSB1T  
Vespa 180 SS VSB1T



**1268100** Manubrio nudo - Sfera  
**55366** Manubrio nudo - Aprilia Amico



**1581716** Manubrio nudo - Liberty 50 - 125 - 150  
Vespa ET2 50  
Vespa ET4 125 - 150



**79925** Bullone fissa manubrio - Vespa tutti i tipi



**79614** Dado quadrato fissaggio manubrio  
Vespa PX - PE



**1215997** Staffa sostegno trasmissioni - "SI" - Ciao PX



**1164149** Tirante comando starter ciclomotore



**71833** Tirante starter  
Vespa 50-90-125 - Primavera ET3 - PK 50 - XL -  
(adatt. P. 98568 - 214280)



**80047** Tirante starter  
Vespa PX tutti i tipi -  
Ape 50 P-TM-TMP-FL-FL2-FL3 -  
(adatt. P. 580938)



**1266148** Tirante starter PK 50-XL-XL125-  
Rush -N



## PIAGGIO



**55079 C** Cavalletto completo - SI - Grillo



**100703** Cavalletto - Ciao PX con perno grosso ø 14

**100208** Cavalletto - Ciao SC

**55079** Cavalletto - "SI" - Grillo



**71342** Cavalletto - Vespa 50 - 90 - 125 Primavera

**79770** Cavalletto - Vespa 125 GTR - 125 "ts" - 150 Sprint - 200 Rally - GL

**1176160** Cavalletto - Vespa P125X - P150X - P200E - PX125E - PX150E - PX200E - (Serie Arcobaleno)

**1216247** Cavalletto - Vespa PK50 - XL - Rush - N - V - PK125 - PK125XL



**74408** Cavalletto completo Vespa 125 VNA - VNB - 1958 Vespa 150 VBA - VBB dal 1959  
**h. mm 225**

**79670** Cavalletto completo Vespa 150 VLA1 - VGLB - 61/62/63 - 150 GL - GT **h. mm 265**



**1174773** Tampone scontro cavalletto Vespa PX 125 - PX 150 P 200 E



**62076** Coppia scarpette Vespa 125 - 150 - 150 GS (foro Ø 15 mm) P. 26034 / 26264



**71367/368** Coppia scarpette - Vespa 50 - 90 - 125 Primavera



**74526/527** Coppia piedini cavalletto Vespa 125 GTR - TS - 150 Sprint - GL 200 Rally - Ø 20



**1176166** Scarpetta cavalletto - Vespa P125X - P150X - P200E - PK50 - XL - Rush - N - V



**62107** Coppia scarpette cavalletto Vespa 125 V30/33t - 1951/52 Vespa 125 VM 1/2t - 1953/54 Vespa 150 VL 1/2t 1954/55 Vespa 150 GS - VS/1t



**62108** Coppia scarpette cavalletto Vespa 125 Cambio Bacchetta 1950



**1176167/168** Coppia piastrine cavalletto -  
Vespa P125X - P150X - P200E - PX125E -  
PX150E - PX200E - (Serie Arcobaleno)

**1216251/252** Coppia piastrine cavalletto -  
Vespa PK50 - PK125 - XL - Rush - N - V

**74525** Coppia piastrine cavalletto -  
Vespa 50 - 125 Primavera - ET3



**1271200 C** Cavalletto completo - Sfera dal 93 - Quartz 93



**1464633 C** Cavalletto completo - Piaggio Liberty - Free



**1560784 C** Cavalletto completo - Vespa ET2

**1562355 C** Cavalletto completo - Vespa ET4

## PIAGGIO



**1581092 C** Cavalletto Liberty 125 **PTT** con perno e molla



**1647563 C** Cavalletto Liberty 125 - 4T. PTT - Motori Leader



**1581835 C** Cavalletto completo - Liberty 125-150 -  
Motore leader 50 - 4 tempi

**1580902 C** Cavalletto completo -  
Vespa ET4 125-150 - Motore leader

**1581641 C** Cavalletto completo -  
Skipper 125-150 (4 T.) - Motore leader



**1563708 C** Cavalletto completo -  
Skipper 125 - Typhoon 125 -  
Runner FX-FXR 125-180

## PIAGGIO



**58424 C** Cavallo - Piaggio GTS 2005-09 - GTV 4 T 2008 - GTV 250 2006-09 (P. 665553)



**58390** Piaggio Carnaby 125 - 200 - 250



**58392** Piaggio X7 250

## PIAGGIO



**55064 N** Cavalletto laterale - Vespa 50 - 50 Special - 90 - 125 Primavera - ET3 - **Nero**

**55065 N** Cavalletto laterale - Vespa P125X - P150X - P200E - **Nero**

**55066 N** Cavalletto laterale - Vespa PK50 - PKXL - V - N - Rush



**55874** Cavalletto laterale - Liberty 50-125-150



**58357** Cavalletto laterale Liberty 50 dal 2000 - 4 tempi



**58460** Cavalletto laterale Piaggio Vespa GTV 200 - 300



**58542** Cavalletto laterale Vespa Primavera 50 - 125 (2014)



**58543** Cavalletto laterale Vespa LX (2014)

## APRILIA



**55541 C** Cavalletto completo - Aprilia SR 94/97 - Rall



**55542 C** Cavalletto completo - Aprilia Scarabeo



**58019 C** Scarabeo 50 Ditech



**55866 C** Cavalletto completo -  
Aprilia Sonic - Sonic GP



**55870 C** Cavalletto completo -  
Aprilia SR 50 DITECH

## APRILIA



**55871 C** Cavalletto completo -  
Aprilia Leonardo 125-150



**55573** Cavalletto laterale - Aprilia Scarabeo

## APRILIA



**58331** Cavalletto laterale  
Aprilia Scarabeo 50-100 - 4 tempi



**58332** Cavalletto laterale  
Aprilia Scarabeo Street 50 - 2 tempi



**58384** Cavalletto laterale  
Aprilia Sport city 250 - 4T  
Scarabeo 125-200



## GILERA



**1271016 C** Cavalletto completo - Gilera Typhoon - Storm - NRG - NTT



**1562910 C** Cavalletto completo - Gilera Runner



**1562805 C** Cavalletto completo - Gilera Stalker



**55458** Cavalletto laterale - Gilera Typhoon - Storm - NRG - NTT

**55572** Cavalletto laterale - Gilera Stalker

## MALAGUTI



**55476 C** Cavalletto completo - Malaguti F12 - F15 Centro - Beta



**55539 CR** Cavalletto laterale - Malaguti Crosser - cromato



**58393** Cavalletto laterale - Malaguti Phantom F12 R

## YAMAHA



**55365 C** Cavalletto completo - MBK Booster T.T. - BWS - Pista - NG



**55579 C** Cavalletto completo - MBK Ovetto - Yamaha Neo's



**55666 C** Cavalletto completo - MBK Nitro

**55868 C** Cavalletto completo - MBK Booster N.G.

**55867 C** Cavalletto completo MBK Stunt Slider (N.O. 5 JHF 711100)



**55676 C** Cavalletto completo - MBK Flipper - WHY Nitro dal 2010



**55474** Cavalletto laterale - MBK Booster - BWS - R - NG

**55474 CR** Come sopra - cromato

**55571** Cavalletto laterale - MBK Booster Track - Next Generation

**55571 CR** Come sopra - cromato

## YAMAHA



**55626**

Cavalletto laterale - MBK Nitro

**55873**

Cavalletto laterale - MBK Stunt - Slider



**58394**

Cavalletto laterale -  
MBK Mach - Yamaha Jog R50



**58396**

Cavalletto laterale -  
Yamaha Giggle 50 4T - MBK Booster

## HONDA



**55970 C** Cavalletto - Honda SH 125-150  
Completo di bulloni e molle

**55971 C** Cavalletto - Honda @ 125-150  
Completo di bulloni e molle

**55995 C** Bulloni con molle - Honda SH 125-150

**55975 C** Bulloni con molle - Honda @ 125-150



**58205** Kit bussole per perno cavalletto  
SH 125-150 - Chiocciola 125-150  
(adatt. 50503 - KGF - 890 - 50504 - KGF - 890)



**58330** Cavalletto laterale  
Honda SH 125 - 150 al 2009



**58456** Cavalletto laterale  
Honda SH 125 - 150 dal 2010

**KYMCO**

**55865** Cavalletto -  
Kymco People 125-150

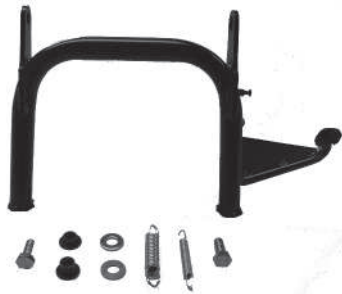

**58461C** Cavalletto completo  
Kymco Super 8

**58475C** Cavalletto completo  
Kymco Agility 50 4T ruota 16"



**58425 C** Cavalletto - Kymco - Agility 50 4 T  
(r.o. 00150056)



**58428 C** Cavalletto - Kymco - Agility 125 4 T 2008  
(r.o. 00150057)



**58429 C** Cavalletto - Kymco - Agility 125/150 4 T 2009  
(r.o. 00150139)

**58430 C** Cavalletto - Kymco - Agility 125 RS (ruota 12)  
(r.o. 00164128)

**58431 C** Cavalletto - Kymco - People125/200  
(r.o. 0016704)

## PEUGEOT



**55584 CR** Cavalletto laterale cromato - Peugeot Bury Speedaker



**55587** Cavalletto laterale - Peugeot Speedfight

**55587 CR** Come sopra - cromato



**58395 B** Cavalletto laterale - Peugeot Ludix - Ruota Alta



**58397 C** Cavalletto - Peugeot Ludix 50 - ruota 12/14  
h. mm 220

**58398 C** Cavalletto - Peugeot Ludix 50 - ruota 10  
h. mm 185



**58395** Cavalletto laterale  
Peugeot Ludix 50 (ruota 14)



**1216255** Molla cavalletto - Vespa PK50 - PK50S - PK125 - PK125S



**55884** Molle cavalletto - Vespa ET4 150 Skipper 125-150

**55886** Molle cavalletto - Skipper 125 - Typhoon 125 - Runner FX - FXR 125-180

**55128** Molle cavalletto - Beverly 125-150



**55887** Bulloni completi di molle - Scarabeo 125-150 Leonardo 125-150



**55727** Tampone di scontro universale per cavalletti Scooters



**1271584 M** Perno modificato completo di anelli e molle - Sfera dal 94 - Zip Fast Rider - Free - Typhoon - Stalker - Runner - ET2 - Liberty

**55812** Perno completo di molle - Vespa ET4



**55644 C** Perno completo - Cavalletti Honda

**58116** Perno completo Habana SR - Scarabeo - D - Teck

**55606** Perno completo Aprilia SR 94/97 - Rally - Scarabeo

**55607** Perno completo Malaguti F10 - F12 - MBK - Sorriso

**55608** Perno completo MBK Booster T.T. - BWS - Pista - Next Generation

**55609** Perno completo MBK Ovetto





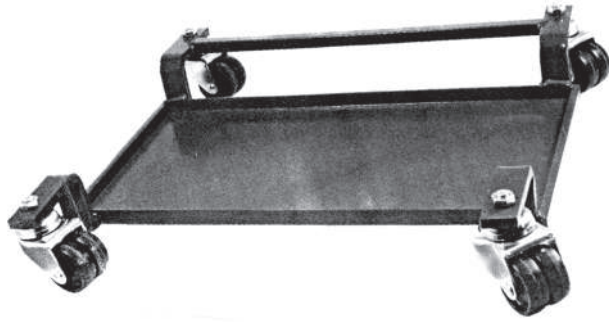

**55956** Carrello reggimoto  
Scooters - Motorini  
(Lung. 470 mm - Larg. 245 mm)



**1472400** Coprimanubrio Vespa ET2 - ET4



**1822200** Paraspruzzi posteriore Vespa ET2 - ET4



**1821500/600** Coppie fianchi posteriori Vespa ET2 - ET4



**1816300** Scudo anteriore - Piaggio Liberty



**1472200** Frontale anteriore Vespa ET2 - ET4



**1816400** Frontalino anteriore - Piaggio Liberty



**1923000** Scudo frontale Typhoon



**1272455** Coperchio manubrio - Typhoon



**1915000** Coprimanubrio - Sfera dal 1995



**55656** Coprimanubrio Scarabeo



**1923300** Fianco laterale destro - Typhoon



**1923200** Fianco laterale sinistro - Typhoon



**55513** Scudo frontale - MBK Booster

**55514** Scudo frontale - MBK Booster - Next Generation



**55658** Frontale Scarabeo



**55659** Frontale Scarabeo con for



**71313** Parafango anteriore - Vespa 50 - 90 - 125 Primavera



**79313** Parafango anteriore Vespa 150 - 2% 1959/60 (P. 89301)



**1177497** Parafango anteriore - Vespa P125X - P150X - P200E

**1226754** Parafango - Vespa PK50XL - PK125XL - PK50 - PK125 (metallo)

**1232926** Parafango - Vespa PX125T5

**1563811** Parafango anteriore - Vespa PX125-150 - Freno disco





**1215876** Parafango anteriore Vespa PK 50 - 125  
1<sup>a</sup> serie saldatura centrale



**1256342** Parafango anteriore - Vespa 50N -  
50N Speedmatic - 50V F.L.2  
(plastica)

**1256343** Paraspruzzi - Vespa 50N -  
50N Speedmatic - 50V F.L.2



**1666528** Parafango anteriore Vespa LX 50 - 125 - 150



**1651029** Parafango anteriore Vespa GTS 125 - 250 - 300



**1655753** Parafango anteriore Liberty 50 - MOC 2T - 4T  
Liberty 125 - 150 - 4T - Euro 3  
Liberty RST 2004 - 2009



**1653588** Parafango anteriore  
Beverly Cruiser 250 - 500  
Beverly Tourer 125 - 250 - 400  
2007 - 2012



**58600** Parafango anteriore X Max 125 . 250 - 400 dal 2010 al 2016



**58601** Parafango anteriore Honda SH 300 dal 2015 al 2018



**79909** Parafango anteriore Vespa  
VNL 2-3 - VLB - VNC 1 - VBC 1 - VSE  
GTR - "ts" - 125-150 Super -  
150 Sprint Veloce - Rally 180-200



**79909 CS** Parafango anteriore Vespa  
VNL 2-3 - VLB - VNC 1 - VBC 1 - VSE  
GTR - "ts" - 125-150 Super -  
150 Sprint Veloce - Rally 180-200  
**con staffa interna**



**1427000** Parafango anteriore Vespa ET2 - ET4



**1817000** Parafango anteriore -  
Piaggio Liberty



**100721** Parafango posteriore -  
Ciao SC

**1188095** Parafango posteriore -  
Ciao PX



- 1924800** Parafango posteriore SI FL -  
**con portatarga**
- 55660** Parafango anteriore Scarabeo
- 91285** Parafango posteriore - Ape 50 - **Grigio**
- 91285 N** Parafango posteriore - Ape 50 - **Nero**
- 1198399 N** Cresta parafango - Vespa PX 125 - 200 Nera
- 1198399 CR** Cresta parafango - **cromata**
- 55733 CR** Kit cresta e griglia - **cromata**  
(Arcobaleno)
- 71942** Cresta parafango (lucidata) -  
Vespa 50 - 125 Primavera - ET3
- 71714** Cresta parafango - Vespa 50 R (tipo stretta)
- 58312** Cresta parafango  
Vespa 125 VNL2 - 150 VLA - VLB1 -  
160 GS VSB1 - 180 VSC-VSD1
- 62010** Cresta  
Vespa 150 VL 1-2-3 - Vespa VB 1 -  
Vespa 150 GS dal VS 1 al VS 5  
fino al telaio 59310  
P. 023535

**71863**Coperchio chiocciola - Vespa 50 - 90 - 125 Primavera - ET3 - **Nero****71863CR**Coperchio chiocciola - Vespa 50 - 90 - 125 Primavera - ET3 - **Cromato****1147568**Coperchio chiocciola - Vespa P125X - P150X - P200E - **Nero****1147568 CR**Coperchio chiocciola - Vespa P125X - P150X - P200E - **Cromato****1179138**Coperchio chiocciola - PK50L - **Nero****1179138 CR**Coperchio chiocciola - PK50L - **Cromato****72130N**Bauletto anteriore - Vespa 50 - 90 - 125 Primavera - ET3  
**Nero****55094**Staffa supporto bauletto (cp.)  
Vespa 50 - 125 Primavera - ET3





**71774** Sportello cofano motore  
Vespa 50 - 90 - 125 Primavera -  
ET3



**71776** Sportello cofano motore  
Vespa 50 - 90 - 125 Primavera - ET3  
**con serratura**

**71776 CR** Sportello cofano motore  
Vespa 50 - 90 - 125 Primavera - ET3  
**con serratura - cromato**



**1131093** Kit leva per sportello motore  
Vespa 50



**71357** Sportello cofano motore  
Vespa 50 N - 50 S - 90  
Tipo piccolo - **attacchi verticali**

**71357 CH** Sportello con chiave



**71773** Sportello cofano motore  
Vespa 50 L - R - S - 90  
Tipo piccolo - **attacchi orizzontali**



**1216915** Sportello sinistro - PK50S

**1216916** Sportello destro - PK50S

**1234515** Sportello sinistro - PK50XL

**1234516** Sportello destro - PK50XL



**62121** Kit gommini e boccole Sportelli laterali  
Vespa PK prima serie



**62122** Kit gommini e boccole sportelli laterali  
Vespa PK XL-Rush - HP - FL



**1159875** Protezione ruota di scorta - P125X - P150X - P200E



**1159873** Bullone fissa protezione ruota scorta - P125X - P150X - P200E



**1174014** Coperchio manubrio - Vespa PX - 125 - 150 1ª Serie (P. 174014)



**1139829** Coperchio manubrio - Vespa PX - PE "3 fori"



**1178933** Coperchio manubrio - Vespa PK 50S - PK125S



**1178637** Coperchio manubrio - Vespa PK 50 - 125 1ª Serie (P. 178637)



**1179731** Coperchio manubrio - Vespa PX125E - PX150E - PX200E (Serie Arcobaleno)



**1622430** Coperchio manubrio Vespa 125-150-200 PX - PE - Millenium - freno a disco



**1226730** Coperchio manubrio Vespa PK 50 XL - 125 XL



**58325** Coperchio manubrio - Honda - SH 125-150



- 71385** Tubo comando cambio - Vespa 50 - 3 velocità  
**71384** Tubo comando cambio - Vespa 50 - 90 - 4 velocità - al 1976  
**71964** Tubo comando cambio - Vespa 50 Special - al 1976 - 3 v.  
**72065** Tubo comando cambio - Vespa 50 Special - dal 1977 - 4 v.  
**79649** Tubo comando cambio - Vespa 125 Primavera - ET3 - GL - Super - Sprint - Rally - al 1976  
**72066** Tubo comando cambio - Vespa 125 Primavera - ET3 - Super - Sprint - Rally - dal 1977  
**79341** Tubo comando cambio - Vespa 150 - 4 velocità - al 1965  
**1219336** Tubo comando cambio - Vespa PK50 - PK50S - PK125 - PK125S  
**1219356** Tubo comando cambio - Vespa PX125E - PX150E PX200E (Serie Arcobaleno)  
**1247104** Tubo comando cambio - 3 velocità - Vespa RUSH - 50 N



- 1139796** Puleggia comando cambio  
 Vespa PX 125 - 150 - 200 - PK XL - T5  
 PK 50 - 125 - Rush - N



- 1266003** Tubo cambio - Vespa 50V F.L. 2



- 71386** Tubo comando gas - Vespa 50 - 90 - al 1976  
**72069** Tubo comando gas - Vespa 50 - 90 - dal 1977  
**71965** Tubo comando gas - Vespa 50 Special - al 1976  
**72070** Tubo comando gas - Vespa 50 - Special - dal 1977  
**79650** Tubo comando gas - Vespa 125 Primavera - Vespa 125/150 - al 1976  
**72072** Tubo comando gas - Vespa 125 Primavera - dal 1977 - ET3 - 125/150 - Super - Sprint - Rally



- 1139778** Tubo comando gas - Vespa PK50 - PK125 - PK50XL - PK125XL - P125X - P150X - P200E

- 1265991** Tubo comando gas - Vespa 50 F.L. 2



- 1139797** Puleggia comando gas  
 Vespa PX 125 - 150 - 200 - PK XL - T5  
 PK 50 - 125 - Rush - N



- 71759** Manicotto cambio Vespa 90 R - 90 SS  
 125 Primavera - ET3 - GT - GTR - Super  
 150 Sprint - Rally (P. 101192)



**1138865** Coperchio preselettore Vespa PX 125-150  
PE 200 - VNX - VLX - VSX - VNX2 - VLX2  
VSX2



**79280** Coperchio preselettore Vespa 125 GTR  
125 TS - 150 Super - 150 sprint Veloce  
Rally 200  
(P.59465)



**1178477** Coperchio preselettore - PK50 - XL - 125 - XL -  
Rush - N



**79293** Preselettore cambio - Vespa 125 - 150 -  
4 velocità - dal 1958 - Rally 200

**1138880** Preselettore cambio - Vespa P125X - P150X -  
P200E - (Serie Arcobaleno) T5 dal 1983

**89270** Preselettore cambio - Ape 150



**1179383** Preselettore cambio - Vespa PK50 - PK50S -  
PK125 - PK125S - PK50XL - PK125XL

**71202** Preselettore cambio - Vespa 50 - 90 -  
125 Primavera - ET3 dal 1978

**80168** Crociera cambio - Vespa 125 gtr - 125 ts -  
150 Super - 150 Sprint veloce - Rally 200 -  
P125X - P150X - P200E

**520164** Crociera cambio - Vespa Sprint VLB1 - G.T. VNL2 -  
Super 125 VNC1 - Rally 180 -  
Ape MPR al 032004 - Ape MPM al 67839 -  
Ape MPV al 20015 - Ape MP

**97022** Crociera cambio - Ape Car 1<sup>a</sup> - 2<sup>a</sup> vel.

**97023** Crociera cambio - Ape Car 3<sup>a</sup> - 4<sup>a</sup> vel.

**93672** Crociera cambio - Ape MPR dal 032005 -  
MPM dal 67840 - MPV dal 20016

**1223225** Crociera cambio - Vespa PX150E - PX200E -  
dal 1983 (Serie Arcobaleno) - PX150S - T5

**80179** Stelo spostamento marce  
Vespa 125 GTR - TS - 150 Super - Sprint Veloce  
Rally 200 - Vespa PX 1<sup>a</sup> serie - P. 130940

**1223232** Stelo spostamento marce Vespa PX 2<sup>a</sup> serie

**71699** Innesto marce - Vespa 50 - 90 - 125 Primavera -  
ET3 - 4 velocità - sino al 1978 (rif. orig. 111589)  
Vespa 50 - 90 - 4 velocità - sino al 1978  
(rif. orig; 112007)

**72021** Innesto marce - Vespa 50 - 90 - 3 velocità -  
dal 1979 (rif. orig. 165304)

**72022** Innesto marce - Vespa 50 - 90 - 125 Primavera -  
ET3 - 4 velocità - dal 1979 (rif. orig. 134902)





**71238** Pedivella avviamento - Vespa 50 - 90 - 125 Primavera - ET3



**79290** Pedivella avviamento - Vespa 125/150 al 1958 (mille righe)



**79533** Pedivella avviamento - Vespa 125/150 dal 1959 (5 righe)

**1174312** Pedivella avviamento - Vespa P125X - P150X - P200E - PX125E - PX150E - PX200E - TS (Serie Arcobaleno)

**1216141** Pedivella avviamento - Vespa PK50 - PK125



**74349** Tampone scontro pedivella Vespa PX 125 -150 - PE 200 (P.046742)



**74331** Molla ritorno pedivella avviamento Vespa PX 125 - PX 150 - P 200 E - 125 GT - GTR - TS - Super - 150 Sprint - Sprint Veloce - Rally 200



**55729** Pedivella messa in moto - Aprilia - Scarabeo - SR 94/96 - Gulliver - Stalith - Benelli



**55645** Pedivella M/M - MBK Booster - BWS - NG (Motori Minarelli verticali)



**55646** Pedivella M/M - Malaguti F10 - Jog (Motori Minarelli orizzontali)



**55647** Pedivella M/M - Peugeot Buxy - Zenith - Speedake



**1286214** Pedivella M/M - Sfera - Zip - Quartz  
Free - Typhoon - NRG - Skipper - Hexagon



**58034** Pedivella M/M - Suzuki Aria - Address  
Franco Morini Aria - Malaguti Crosser



**55889** Pedivella M/M -  
Booster NG - Nitro - Nitro F1 - NG CAT.



**1163653 C** Kit revisione asse pedivelle - SI  
**100707 C** Kit revisione asse pedivelle - Ciao - Bravo  
**100708 C** Kit revisione asse pedivelle - Boxer



**1175432** Coppia pedali - SI - CIAO - BRAVO  
BOXER - GRILLO





**71558** Raccordo scarico - Vespa 50 - 90 - 125 Primavera - PK50

**1222208** Raccordo scarico - PK125



**71559** Raccordo di ammissione - 50 - 50 Special - 16/10

**71560** Raccordo di ammissione - 50S - 90 - 16/16

**71893** Raccordo di ammissione - 125 Primavera - 19/19

**72184** Raccordo di ammissione - 125 Primavera - ET3



**1178726** Raccordo di aspirazione - Vespa PK50 - PK50S

**1196812** Raccordo di aspirazione - Vespa PK125 - PK125S

**55056** Raccordo di aspirazione per modifica 50/75 su Vespa PK50

**55319** Raccordo di aspirazione - flangia a due fori  $\varnothing$  19 (Vespa PK 1ª serie) - modifica Vespa PK50 - senza bussole



**71537** Bocchettone - 50 - 50S - 50 Special - 90

**71886** Bocchettone - 125 Primavera



**1178727** Bocchettone aspirazione - Vespa PK50

**1196778** Bocchettone aspirazione - Vespa PK125



**91398** Raccordo ammissione - Ape 50TL

**91399** Raccordo ammissione - Ape 250TM

**1224755** Raccordo aspirazione - flangia a tre fori  $\varnothing$  20 per carburatore SHBC20L - P.287152

**87000** Raccordo aspirazione per modifica 50/75 su Vespa PK50 - flangia a tre fori - carburatore 16/16



**1199598** Raccordo aspirazione - Vespa PK50 - PK50S - flangia a tre fori - carburatore 16/10

**1198178** Raccordo aspirazione - Vespa PK125 - PK125S - flangia a tre fori - carburatore 19/19



**72100** Bordo scudo - Vespa 50 -  
90 - 125 Primavera (**alluminio**)



**1192086 A** Bordo scudo - Vespa PK 50 S



**1218944** Bordo scudo -  
Vespa PX125E - PX150E -  
PX200E  
(Serie Arcobaleno)

**1226097** Bordo scudo - P125X - P150X  
- P200E -  
Vespa T5 - **nero**



**1256938** Bordo scudo - Vespa 50V F.L. 2  
PK 50 XL



**1149943** Bordo scuro Vespa PX  
1ª serie (alluminio)



**1622187/188** Bordo scudo dx/sx Vespa LX 50-125  
S 50-125

**1573001/002** Bordo scudo dx/sx Vespa ET2 - ET4





- 93290** Paraspruzzi posteriore - Ape MP500 - MP550 - MP600  
**100446** Paraspruzzi - Ciao  
**100785** Paraspruzzi - Boxer  
**1189478** Paraspruzzi - SI - SI F.L.



- S. 18020** Ribattino fissaggio paraspruzzi sul parafango - Ciao - SI - Boxer - Bravo (confezione 100 pezzi)



- 1162105** Protezione posteriore scocca - Vespa P125X - P150X - P200E



- 1219110** Protezione posteriore scocca - Vespa PX125E - PX150E - PX200E (Serie Arcobaleno)



- 1576969** Paraspruzzo posteriore scocca Vespa PX 125-150 **Millenium** (nero)



- 1214359C** Protezione posteriore scocca completa Vespa PKS 50-125 1ª serie



- 1214359** Protezione posteriore scocca



- 1216989** Paraspruzzi posteriore Vespa PKS 50-125 1ª serie



- 1234411** Protezione posteriore scocca Vespa PK50XL - PX125XL - Rush



- 1256343** Paraspruzzi posteriore Vespa 50N - 50N Speedmatic - 50V F.L.2 (per parafango 1256342)



- 1256940** Protezione posteriore scocca Vespa 50 N - V - HP



**72108** Scatola porta attrezzi - Vespa 50 - 90 - 125 Primavera - ET3



**1217310** Scatola porta attrezzi - Vespa PK



**55391** Portatarga universale completo di bulloni e dadi



**58296** Portatarga ciclomotore per nuove targhe 14 x 12 mm con passeggero trasportato



**1011635** Clacson con vite di registro  
Vespa 125 dal V1T al V15T - dal V30T al V33T  
fino al 1952



**1020250** Clacson senza vite di registro  
Vespa 125/150 VM1/2 - VUU1 - VM1/2  
dal 1953 al 1957



**1025714** Clacson cromato  
Vespa 150 VL3 - VB1  
dal 1956 al 1957



**1028249** Clacson cromato (corrente continua)  
Vespa 150 GS - VS2/3/4/5  
Vespa 160 GS - VSB



**1089840** Clacson cromato (corrente alternata)  
Vespa 150 - VBA - VBB



**1089840EC** Clacson cromato - corrente alternata  
Vespa 150 - VBA - VBB - Vespa 160 GS -  
Ape 150



**1093753** Clacson cromato  
Vespa 50 - V5A1 - V5SS  
Vespa 90 - V9A1 - V9SS  
Vespa 125 - VNB3/4



**1070300** Clacson  
Vespa 50/90/125  
V5SA1 - V9A1 - VMA2 - VNL2 - VNC1 ecc.



**1070300 EC** Clacson Vespa 50 - 90 - 125 - V5SA1  
V9A1 - VMA2 - VNL2 - VNC1 - Tipo economico



**55726** Clacson con staffa c.c. batteria 12V per  
ciclomotori Scooters e veicoli Piaggio  
con batterie



**62093** Clacson verniciato nero - Vespa 125 VNA1-2  
(senza batteria)



**62094** Clacson verniciato nero - Vespa 150 VL1T  
(senza batteria)



**62095** Clacson verniciato nero - Vespa 150 VL1T  
(con batteria)



**1025714B** Clacson cromato - Vespa 150 VL2-3 - 150 VB1  
(con batteria)



**62096** Clacson verniciato nero - Vespa 150 GS VS1  
(con batteria)



**62097** Clacson cromato - Vespa 150 GS VS2-3  
(con batteria)



**62098** Clacson verniciato nero - Vespa 125 VNB3T  
(senza batteria)



**62099** Clacson verniciato nero - Vespa 125 VNB1-2  
(con batteria)



**62100** Clacson cromato - Vespa 50L - 125 Super -  
150 Sprint - 150 Super - 180 SS - 180 Rally  
(senza batteria) - P. 097828



**62109** Guarnizione clacson  
Vespa 125 TS - GTR - Vespa Sprint - 180/200 Rally



**62077** Gancio portaborse  
Vespa 125 - 150 - 200PX - PE - P. 162035



**1186869** Gancio portaborsa o portacasco per sella -  
con serratura - Vespa tutti i tipi



**86738** Gancio portaborsa per sella anteriore - Vespa  
(Alluminio)



**1253469** Gancio portaborsa - Free - Skipper (dal '97) - Hexagon -  
Liberty - Cosa 1-2 - (sede per viti)

**1265093** Gancio portaborsa - Vespa N-FL - Sfera - Skipper  
125-150 ('94-'97) - NRG - NTT - Typhoon  
SH 125 - 150 (Foro Passante)



**1575819** Gancio portaborsa - X8 125-200 - Vespa Granturismo -  
X9 - Zip - Beverly - Liberty 50 2T-4T - Vespa S 50 - Fly 100  
- Carnaby 125



**1656849** Gancio portaborse - MP3 - Beverly RST 125-300-350



**1227153** Gancio portaborsa - Vespa 50-125 - PX - T5  
(Plastica)



**1267046** Coppia ceppi freno - anteriore - Sfera - Zip - Free

**1267051** Coppia ceppi freno - posteriore - Sfera - Zip - Zip Fast Rider - Quartz - Free - Typhoon

**1272711** Coppia ganasce freno - posteriore - Sfera - Zip - Zip Fast Rider - Typhoon - Free - NRG - NTT

**1273623** Coppia ganasce posteriori  
Sfera - Vespa ET2 - ET4 125-150 - Free - Typhoon - NRG - Hexagon 125-150 - Zip - FR - SP

**55434** Coppia ceppi freno - anteriore - posteriore  
MBK Booster

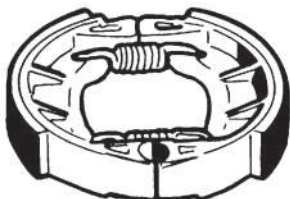

**100226** Coppia ceppi freno - anteriore - Ciao - Boxer - Bravo - SI (con ruote a raggi)

Mozzo GRIMECA ø 90 (rif. orig. 114408)



**100127** Ceppi freno - posteriore - Ciao - Boxer - Bravo - SI (rif. orig. 130240)

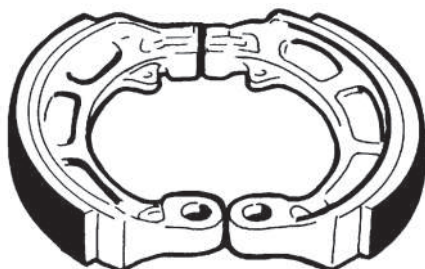

**71680** Coppia ceppi freno - posteriore  
Vespa 50S - 125 Primavera - ET3  
(rif. orig. 100492)



**79777** Coppia ceppi freno - posteriore - Vespa Sprint - GTR - Rally 200

Anteriore e posteriore - Vespa P125X - P150X - P200E - PK50 - PK125 - XL - Rush - N - V  
(rif. orig. 72339)



**71205** Coppia ceppi freno - posteriore - Vespa 50 - 50S - 90 (rif. orig. 90582)





- 74373** Coppia ceppi freno - anteriore - Vespa 50 - 50S - 50SS - 90 - 90SS - 125 Primavera - ET3 - 125 1958 ÷ 1965 - 150 VBA - VBB - Super - PK50 - PK50XL (rif. orig. 91058)

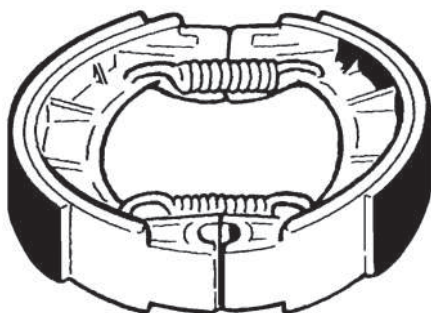

- 1082595** Coppia ceppi freno - posteriore - Piaggio - Liberty 50-125 - Runner - NRG - NTT - Hexagon 150



- 55052** Coppia ceppi freno  
Mozzi GRIMECA ø 90 con molla a ferro di cavallo

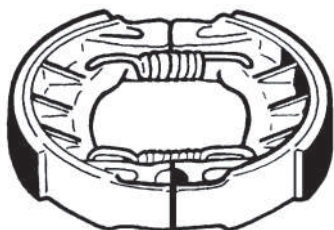

- 55051** Coppia ceppi freno  
Mozzi GRIMECA ø 105 - SI (con ruote in lega)

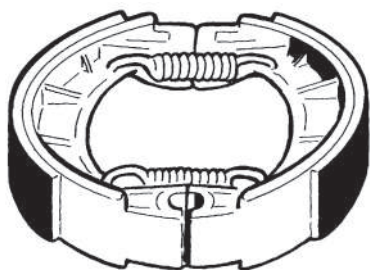

- 1229633** Coppia ceppi freno - Posteriore - "Cosa"

- 1229634** Coppia ceppi freno - Anteriore - "Cosa"



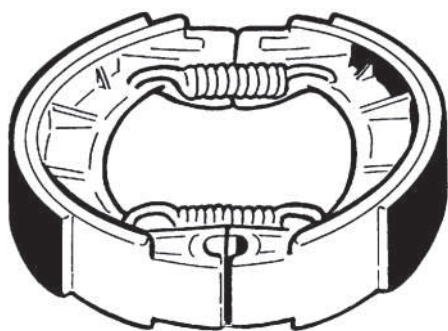

**55098** Coppia ganasce - Grimeca mozzo ø 140

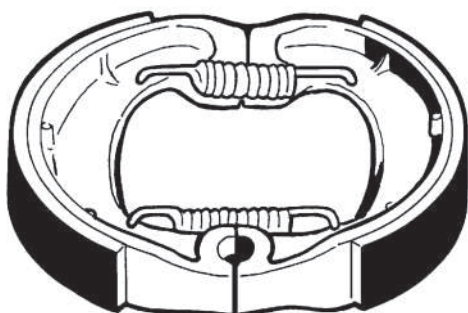

**55097** Coppia ganasce - Yamaha Ténéré

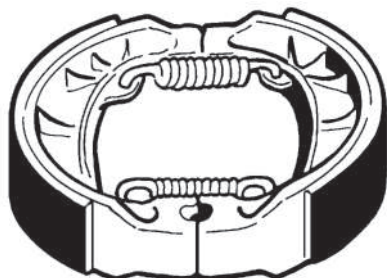

**55095** Coppia ganasce

**Honda:** Bali - SH50 - 125 (Italia) - Sky

**Peugeot:** Metropolis - SV50 - 125 GEI - Buxy - Zenith - Speedake

**Malaguti:** F10 - F12 - Centro

**Aprilia:** Amico - Scarabeo - Gulliver

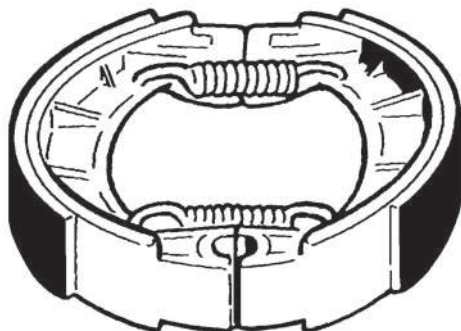

**58148** Coppia ceppi freno - posteriore -  
Honda SH 125-150 @ 125-150  
(R.O. 06430-GBJ-K20)

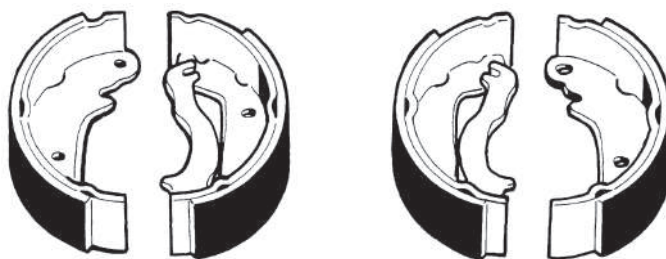

**91237** Serie completa (posteriore) - Ape 50 (P. 116118 = 117449 + 117448)

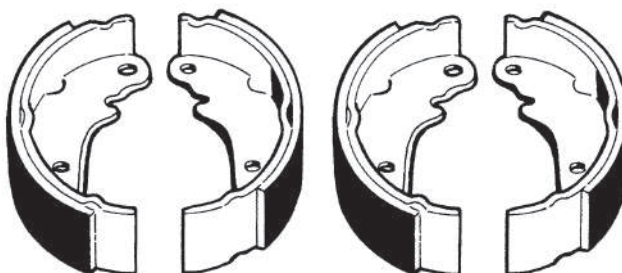

**58133A** Serie completa (anteriore) - Ape Poker (4 pezzi)

**58133P** Serie completa (posteriore) - Ape Poker (4 pezzi)



**58299** Serie ganasce posteriori  
Ape Porter 1000 92/98



**1850668** Serie completa ganasce freno posteriore  
Piaggio Porter Diesel



**55054** Serie completa (anteriore, posteriore) -  
Ape MPR - MPM - MPV - Ape CAR -  
Ape CAR 2 - Ape P601V - P501

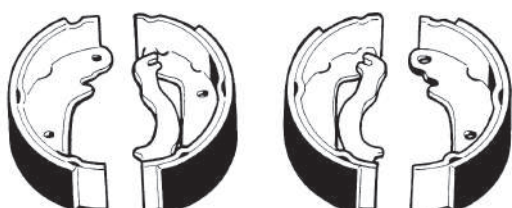

**55081** Serie completa (anteriore, posteriore) -  
Ape TM P703  
(P. 178797 + 178812 + 178813 + 179157)

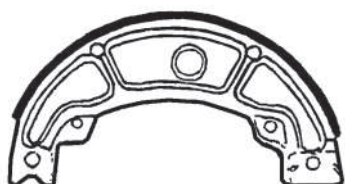

**58038** Coppia ceppi freno - Honda 250 CN 87/99 (post.)  
Piaggio 250 Hexagon GT (post.)

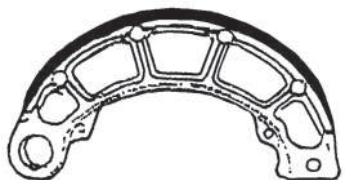

**58040** Coppia ceppi freno - Honda 125-150 -  
Pantheon 98 - 250 Foresight 98 (post.)

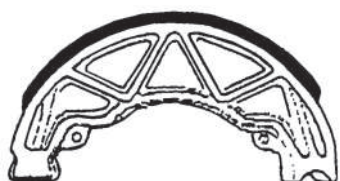

**58041** Coppia ceppi freno - Gilera 125-180 Runner FX -  
FXR 97/98 (post.)  
Piaggio 125 Liberty 98  
125-150 Skipper LX 98  
125-180 Hexagon LX - LXT 98 (post.)



**58042** Coppia ceppi freno - Suzuki 125-150 Epicuro 98 (post.)



**58043** Coppia ceppi freno - MBK - 125 Flame 95/96 -  
Flame R 97/98 (post.)  
Yamaha - 125 Cygnus 95/99 -  
Cygnus R 97/98 (post.)



**58044** Coppia ceppi freno - MBK - 125 Flame 95/96 (ant.)  
125 Skyliner 98 - 150 Vertex 97 (post.)  
Yamaha 125 Beluga 90/95 -  
Majesty - 150 Flyone (post.)



**73210 C** Kit serrafilo freno anteriore - Vespa tutti i tipi



**86153 C** Kit serrafilo freno posteriore - Vespa tutti i tipi



**79362C** Kit serra filo freno posteriore  
Vespa 125 GTR - GTS - 150 Super  
150 Sprint Veloce - Rally 200



**1191803** Cavo freno posteriore - Vespa - tutti i tipi  
(modificati)



**55467** Registro filo freno posteriore  
Scooters - **Quadro fino** Ø 5



**55468** Registro filo freno posteriore  
Scooters - **Quadro grosso** Ø 6



**62104** Registro freno ant. Vespa PX 125 - 150 - 200  
PE - Arcobaleno - Elestart

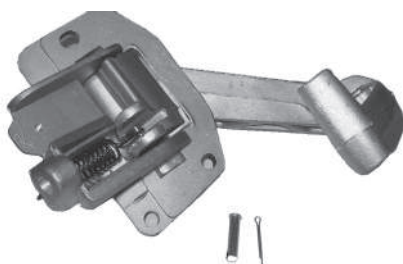

**1182049** Pedale freno completo  
Vespa 50 - PX - Arcobaleno - PK - T5  
- Vespa N - Rush (P.182049-138474)



**74842** Pedale freno posteriore Vespa Sprint -  
Veloce - Super - Rally 180 - 200 -  
GTR - TS (P. 94451)



**100197** Morsetto cavo freno - Ciao - Boxer -  
Bravo - SI



**71423** Protezione pedale freno  
Vespa 50-90-125 Primavera  
(P.100426)

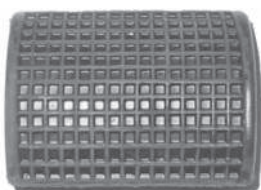

**1182051** Protezione pedale freno  
Vespa 50 - PX - Arcobaleno



**79294** Protezione in gomma leva avviamento  
Vespa 125 VNB3 - 6T - Super - GT - TS  
PX (1ª serie) - Super - Sprint - Sprint Veloce  
160 GS - 180 SS - Rally - PE



**100035 M** Ganascia esterna frizione - Ciao - Boxer - Bravo - SI -  
"Senza variatore"



**1289942** Massa per gruppo frizione - Sfera dal 94 - Zip dal 94 -  
Zip Fast Rider - Free - Quartz - Typhoon



**100040** Massa avviamento - Ciao - Boxer - Bravo - SI -  
"Senza variatore"



**100139** Massa avviamento - Ciao - Boxer - Bravo - SI -  
"Con variatore"



**100043** Molla richiamo masse frizione - Ciao - Boxer - Bravo - SI

**100044** Molla richiamo masse avviamento - Ciao - Bravo - Boxer  
- SI



**1289933** Tamburo puleggia condotta scooters - Piaggio

**55652** Tamburo puleggia condotta scooters - ø **105 mm**  
Motori Minarelli (frizioni con 2 masse)  
Malaguti 72602700

**55683** Tamburo puleggia condotta scooters - ø **107 mm**  
Motori Minarelli (frizioni con 3 masse)  
Rif. Minarelli 2600070 - Malaguti 72601700

**55903** Tamburo puleggia condotta - Kymco Dink 125-150

**55904** Tamburo puleggia condotta - Kymco People 125-150

**55910** Tamburo puleggia condotta - Majestic 125 - Skyliner 125



**1478688** Tamburo puleggia condotta - Gilera Runner 50

**1182503 R** Tamburo puleggia condotta - Sfera 125 - Liberty 125

**58240** Tamburo frizione Honda 125-150 - Chiocciola - SH

**58241** Tamburo frizione Motori Piaggio 50 - tipo economico  
(adat. P. 289933)

**58244** Tamburo frizione Aprilia - Ditech - 50

**1825176** Tamburo frizione - Motori Piaggio X9 - X9 Evolution 500  
Beverly 500





**71109** Disco frizione - Vespa 50 - 90 - 125 Primavera - ET3 - PK50 - PK125 - XL - Rush - N (Conf. 100 pz.)

**71109 C** Serie confezionata in busta (rif. orig. 79399)

**1285974** Disco frizione - Vespa 50V F.L. 2 - (Conf. 100 pz.)

**1285974 C** Serie confezionata in busta



**79465/89908 C** Dischi frizione - Vespa 150 - VBB2 - GL - Sprint - Super - 125 ts - P125X - P150X - (P. 94743/94780)

**1237267/268** Dischi frizione - Vespa PX 125-150-200 - freno a disco

**86472/86310 C** Dischi frizione - Rally 180 - 200 - P200E - (P. 59388/50721)



**56000** Serie dischi frizione comprensiva di molla - Vespa 50 - 90 - 125 Primavera - 125 ET3 Modifica (4 duchi guarniti - 3 acciaio)

**71652** Molla frizione

**71652 R** Molla frizione - **rinforzata**



**55311** Serie dischi frizione Modifica - 7 pz. Vespa 50V F.L. 2

**1286004 R** Molla frizione - **rinforzata** - Vespa 50V F.L. 2

**56002** Vespa PX 125-150 - Modifica - 7 pz.

**55080** Serie dischi frizioni Modifica - 7 pz. PX200 E



**71167** Serie parastrappi Vespa 50 - 90 - 125 Primavera - ET3 PK 50 - PK 125 - XL - Rush - N - V



**79543** Serie parastrappi Vespa P125 X - P150 X - VNL2 - VNL3 - VLB1 VBC1 (P. 077370 - 077371 - 078853)



**79892** Serie parastrappi - doppia molla Vespa P200E (P. 077370 - 077371 - 077372 - 078853)



- 55569** Gruppo frizione motori - Minarelli - Aprilia - Malaguti - MBK - ø **105 mm**
- 1289937** Gruppo frizione - Quartz - Zip Fast Rider - Typhoon - ø **107 mm**
- 55742** Gruppo frizione motori - Peugeot - Buxt - Speedake - Zenith
- 55789** Gruppo frizione - Morini - Malaguti crosser - Suzuki Sephia - ø **100 mm**



- 1840311** Frizione completa - Beverly 125 - 2001-2003
- 1831030** Frizione completa - X9 - X9 Evolution 200 dal 2003 Vespa Granturismo 125 dal 2003 - (adatt. P. 840312)
- 1842343** Frizione completa - X9 500 2001-2003 - (adatt. P. 840799)
- 55901 H** Frizione completa - Honda SH 125-150 - @ 125-150



- 1274703** Girante frizione originale Piaggio Beverly 250 - Tourer 250- Carnaby 250 - MP3 250 - GT 60 - GTV - MP3 300 - GTS - Aprilia - Scarabeo 200 - Atlantic 250 - Sport City 250



- 55669** Gruppo frizione - **registrabile** - Motori Minarelli ø 107 mm



- 55670** Gruppo frizione - Motori Minarelli 1ª serie (2 masse) ø 105



- 58255** Frizione completa - Scarabeo 125 (adatt. 0259739)
- 58256** Frizione completa - Scarabeo 150 (adatt. 0259738)
- 58257** Frizione completa - Scarabeo 200 (adatt. 0659250)





**58258** Frizione completa - Majestic 150  
MBK Skyliner 150



**58259** Frizione completa - Yamaha Majestic 250  
MBK Skyliner 250 (dal 2004)



**58536** Gruppo frizione completo Kymco Agility 50 - 4T  
R 10 - R 12 05-08 - R 16 08-12 (R.O. 00105099)



**58260** Frizione completa - Suzuki - Burgman 250

**80149** Frizione completa - Vespa P125X - P150X (al 1982) -  
125GTR - 125TS - 150 Sprint - 150 Super (con miscelatore)

**80149 M** Frizione completa - Vespa P125X - P150X (al 1982) -  
125GTR - 125TS - 150 Sprint - 150 Super (con miscelatore)  
(con serie dischi modif.)

**1174731** Frizione completa - Vespa P125X - P150X (dal 1983) -  
Vespa PX150E (Serie Arcobaleno)

**1174731 M** Frizione completa - Vespa P125X - P150X (dal 1983) -  
Vespa PX150E (Serie Arcobaleno) - (con serie dischi modif.)



**80150** Frizione completa - Vespa P200E - Rally 200

**80150 M** Frizione completa - Vespa P200E - Rally 200  
(con serie dischi modif.)

**1194585** Frizione completa - PX125E (Serie Arcobaleno) - Elestart

**1194585 M** Frizione completa - PX125E (Serie Arcobaleno) - Elestart  
(con serie dischi modif.)

**1245831** Frizione completa - Vespa T5

**71633** Frizione completa - Vespa 50 - 90 - 125 Primavera - PK50 -  
PK50XL - PK125 - Rush - N

**71633 M** Frizione completa - Vespa 50 - 90 - 125 Primavera - PK50 -  
PK50XL - PK125 - Rush - N - (con serie dischi modif.)



**1286020** Gruppo frizione - Ape 50 - Vespa 50 FL2

**1286020 M** Gruppo frizione - Ape 50 - Vespa 50 FL2 - con dischi modif.



**1432140** Frizione completa APE TM 703 - Car - Poker  
Motori diesel



- 80152** Ingranaggio motore - Vespa P125X - P150X (al 1982) -125 GTR - 125TS - 150 Sprint - 150 Super (con miscelatore) - 22/26
- 1174733** Ingranaggio motore - Vespa P125X - P150X (dal 1983) - Vespa PX150E (Serie Arcobaleno) - 21/26
- 80153** Ingranaggio motore - Vespa P200E - Rally 200 - 23/26
- 1178000** Ingranaggio motore - PX125E (Serie Arcobaleno) -Elestart - 20/26
- 1241346** Ingranaggio motore - Vespa T5 - 20/26



- 1827981** Frizione completa - Liberty 150 - Zip 125 -Vespa ET4 125 - 150 - Super Hexagon (adattabile 829184 Motori Leader 125-150)
- 55902** Frizione completa - Kymco Dink 125-150 - (N.O. 22300 KN7 - 6720)
- 55909** Frizione completa - Majestic 125 - Skyliner 125
- 58129** Frizione completa - Majesty 250
- 1485442** Frizione completa - Hexagon 250 - Skipper 125-150 - Honda CN 250



- 58537** Tamburo frizione Honda SH 125 - 150 - @ 125 - 150 (R.O. 22101 - KCW - 850)
- 55901 H** Frizione completa **Honda SH 125 - 150 @ 125 - 150**
- 58537 C** Gruppo completo campana girante



- 58477** Frizione completa **Honda SH 300**



- 58538** Tamburo frizione Honda SH 300 (R.O. 22100 - KFG - 000)
- 58538 C** Gruppo completo campana girante



- 58333** Frizione completa **Piaggio** Hexagon LX-LXT 125-180 1998-1999  
Skipper LX 125-150 1998-1999  
Skipper 125-150 1994-1997  
Hexagon 125-150 1994-1997  
Runner FX-FXR 125-180 1997-2002  
Typhoon 125 - X - XR 1995-2000



- 1082517** Campana frizione (adatt. P. 82517R)
- Gilera** 125-180-200 - Dna 01 - Runner VX - VXR 00/02
- Piaggio** Beverly 125-200 - Liberty 125-150 00/02 - X9 125-200 01/03 - X9 Amalfi 180 00/03 - X9 Evolution 125-200 03  
Skipper 4T 125-150 00/02  
Super Hexagon GTX 125-180 00 - Super Hexagon GTX 12" - 125-180 01  
Vespa ET4 125-150 99/02 - Vespa Granturismo 125-200 03 - Zip 125 00



- 58602** Campana frizione Piaggio 3 valvole Liberty 125 - 150 - LX - Primavera Sprint 125 - 150 - GTS 150 (P. 1Aoo4103)



- 18440494** Campana frizione Piaggio Aprilia - Gilera - Motori 125 - 180 - 200 - 250 - 300



**1484748** Collettore aspirazione  
Piaggio (484748) Beverly 125-200 -  
Hexagon GTX 125-180 - Super Hexagon GTX 125-180  
X9 125-180-200 - Vespa Granturismo 125-200



**1845946** Collettore aspirazione  
Piaggio (845946) - Fly 50 4T - Liberty 50 4T  
Vespa LX 50 4T - Zip 50 4T



**1871973** Collettore aspirazione  
Piaggio (871973)  
Liberty 125-150-200 4T 06-08 - Vespa LX 125-150 4T  
Vespa LXV 125 4T - Vespa S 125-150 4T



**1840949** Collettore aspirazione  
Piaggio (840949)  
Beverly 125-250 - X8 125-200 - X9 125-250  
Vespa GTV 125 - Vespa Granturismo 125-200



**1849465** Collettore aspirazione  
Piaggio (849465)  
Fly 125-150 - Vespa LX 125-150 - Vespa LXV 125 4T  
X8 125-150 - Liberty delivery ptt sport  
moc 125-150-200 4T



**1969405** Collettore aspirazione  
Piaggio (969405)  
Liberty 50 4T - Zip 50 4T - Vespa ET4 50 4T



**58562** Collettore aspirazione  
**Piaggio** Hexagon 125 94 - 97  
LX - LXT  
Hexagon 150  
Skipper  
**Gilera** Runner125 - Typhoon180  
(P.430206)

## BOCCOLI DI FERMO



**1288694** Boccolo di fermo - Sfera - Zip - Zip Fast Rider - Free - Quartz - Typhoon



**1433862** Boccolo di fermo - Sfera - Zip - Zip Fast Rider - Free - Quartz - Typhoon - Storn - NRG - spessore **mm. 4**

### **1478032 Gilera**

Typhoon 125 / 95/98 - Typhoon X-Xr 125 / 99/00  
Runner FX-Fxr 125-180 / 97/00

#### **Piaggio**

Skipper 125-150 / 94/97 - Skipper Lx 125-150 / 98/99  
Hexagon Lx Lxt 125-180 / 98/99  
Hexagon 125/150 / 94/97 - Vespa Et4 125-150 / 99/01  
Foro interno ø **17** mm - (r.o. 478032)



**1435027 Piaggio**  
Vespa 125 Et4 - Sfera 125 Rst - Liberty 125 1998 - Hexagon Lx4 125 - Foro interno ø **15** mm - (r.o. 435027)



**1827386 Piaggio**  
125-150-200 dal 2005 - Liberty X8 - X9 - MP3 - Vespa VTS - GTV - Granturismo

### **1479866 Gilera 50 cc**

Dna 00/02 - Dna GP Experience 03/04 - Ice 01 - Runner Poggiali - FL - Purejet 97/02 - Stalker 97/04 - Typhoon XR 00 - Typhoon 01/04

#### **Piaggio 50 cc**

Diesis 01 - Free Delivery 00/01 - Fly 2T/4T - Liberty - 2T RST 4T RST 04 - Liberty 97/02 - 4T 00/02 - NRG Extreme 99/00 - RST Mc2 96/98 - Mc3 01/02 - Purejet 02/04 - Vespa Et2 97/01 - Et2 iniezione 97/00 - Et4 00/02 - Zip Rst 96/99 - Sp 01/04 - Euro 1 00/02 - 4T 00/04

#### **Piaggio 100 cc**

Free 02/03



**58323 Honda**  
Bali 50

### **58322 Peugeot 50 cc**

Buxy 94/97 - Eliseo 99 - Elystar TSDI 2003 - Looxor 2001/02 - TSDI 02 - Metal X 2002 - Speedake 95/97 - Speedfight aria - Kat acqua 97/99 - Squab 95/97 - Vivacity 99 - Kat 99/02 - Serie speciali 2002 - Trekker 98/00 - Zenith L 94/96 - LN/LS - N 97/98 - X-Fight 2000 - X race 2003

#### **Peugeot 100 cc**

Elyseo 99/01 - Looxor 2001 - SVL 98 - Speedfight 97/00 - Trekker 98 - Vivacity 99/01 - X Fight 2000/01





**80144** Boccolo frizione - Vespa P125X - P150X - PX125E - PX150E (Serie Arcobaleno)  
125GTR - 125TS - 150 Sprint - 150 Super  
(con miscelatore)

**80146** Boccolo frizione - P200E - PX200E (Serie Arcobaleno)



**1285079** Boccolo frizione Vespa PX (freno disco)  
1998/2001  
Cosa 2 125-150-200



**520014** Campana interna frizione - Vespa 50 - 90 - 125 Primavera - PK50 - PK125 - PK50XL - PK125XL - Rush - N



**1286012** Campana interna frizione -  
Vespa 50V F.L. 2



**73935** Campana frizione - Vespa 125/150 - dal 1955

**80161** Campana frizione - Vespa PX 200 E

**71156 C** Rallino frizione con piattello e molla per Vespa 50 - 90 -

**1165019 C** Rallino frizione con piattello e molla per Vespa 50 - 90 - 125 Primavera - Ape 50 - XL - Rush - N - dal 1981

**1286305 C** Rallino completo frizione - Vespa 50V F.L. 2

**74252 C** Rallino frizione con piattello e molla per Vespa 125/150 - dal 1958 al 1983 - P125X - P150X - PX125E - PX150E - (Serie Arcobaleno)

**86039 C** Rallino frizione con piattello e molla per Vespa Rally 180 - Rally 200 - P200E - GS160 - 180SS - PX200E

**93043 C** Rallino frizione con piattello e molla per Ape MP

**93659 C** Rallino frizione con piattello e molla per Ape MPV - MPM - avviamento elettrico - Ape CAR



**100012** Campana frizione avviamento - Ciao - Boxer - Bravo - SI - **Senza variatore**





**100030** Puleggia motrice (frizione)  
**completa**  
Tipo senza variatore  
Ciao - Boxer - Bravo - SI



**1190312** Puleggia frizione - nuda -  
Ciao - Boxer - Bravo - SI -  
Grillo - **Con variatore**

**1190312 C** Puleggia frizione -  
**con massette e molle**  
Ciao - Boxer - Bravo - SI -  
Grillo - **Con variatore**



**100161** Puleggia frizione - completa - (ø 100)  
Ciao - Boxer - Bravo - SI - Grillo  
**Con variatore**



**1221169** Ganascia esterna frizione - Boxer - Bravo  
"Con variatore dal 1982"



**1221163 B** Puleggia motrice con variatore  
Ciao - Bravo - SI - Grillo - **8 rulli**  
dal 1995



**100024** Disco per puleggia motrice -Ciao - Bravo  
SI - con variatore (P. 114056)



**100007 C** Boccole per regolatore con semipuleggia  
Ciao - Bravo - Boxer - SI

**100068** Semipuleggia  
frizione avviamento - Ciao - Bravo - Boxer - SI



**1430191** Semipuleggia - Sfera  
dal 94 - Zip dal 94 -  
Zip Fast Rider -  
Free - Quartz -  
Typhoon



**1289831** Ruota dentata - Sfera -  
Zip - Zip Fast Rider -  
Free - Quartz - Typhoon

**1479561** Ruota dentata - Liberty -  
NRG - MC2 - Stalker



**1845607** Semipuleggia fissa  
Motori Piaggio 125 - 150 - 4T



**1287044** Ventola -Sfera - Zip -  
Zip Fast Rider - Free -  
Quartz - Typhoon



**1480410** Ventola - Liberty -  
Vespa ET2 - Zip -  
Zip RST - NRG



**55882** Semipuleggia motrice  
fissa - Peugeot Buxy -  
Zenith - Speedake -  
SV50 GEO



**55791** Puleggia traino girante -  
Motori Minarelli - H20



**1289952** Gabbia a rulli  
(raschiatore interno)  
**17 x 25 x 18**  
per puleggia fissa  
posteriore - Piaggio -  
Minarelli - MBK - Yamaha



**1289953** Cuscinetto **12 x 46 x 6**  
per puleggia fissa  
posteriore - Piaggio -  
Minarelli - MBK - Yamaha



**1434766** Semipuleggia motrice  
fissa - Piaggio 125-150 -  
(4 tempi)

**1478822** Semipuleggia motrice  
fissa - Piaggio 125  
(2 tempi)

**1485118** Semipuleggia fissa  
(Motori Leader)  
Skipper 4T. 125-150 -  
X9 - Liberty 125-150 -  
Beverly 125-150 - Vespa  
ET4 125-150 - Super  
Hexagon 125-180 GTX

**1834774** Semipuleggia fissa  
Hexagon GT - GTX250



**1832697** Semipuleggia motrice  
X9 Evolution 500 - 2003-2004  
Beverly 500 - 2002-2003  
MP3 400 2007-2011  
MP3 XEVO 2007-2011



**1832808** Semipuleggia mobile  
X9 Evolution 500  
Beverly 500 2002-2006  
Gilera Nexus 500 2006-2008



**1832774** Semipuleggia fissa  
Beverly 500  
X9 Evolution 500  
MP3 400  
Gilera Nexus 500

**Semipuleggia - CORRETTORE DI COPPIA - con doppia pista per modello originale e modello speciale**



**55615** APRILIA Amico 50cc - Gulliver H20 - Rally - Scarabeo - SR - SR 94 - SR Replica H20

BETA Chrono - Quadra - Tempo

GARELLI Pony - SR

ITALJET Bazooka - Pista - Pista 2 - Reporter - Scoop - Yankee

LEM Flash - Ghilbi - Tornado

MALAGUTI Centro - F10 - F12 Phantom LC H20

MBK Active - Booster - Booster N.G. - Equalis - Evolis - Fizz - Forte - Hot Champ - Rocket - Sorriso - Sorriso 96 - Target

YAMAHA Axis - Beluga - Breeze - BWS - BWS N.G. - CRZ - CT - Jog - Jog ER - SPV - Jog Z - Zest - Zuma



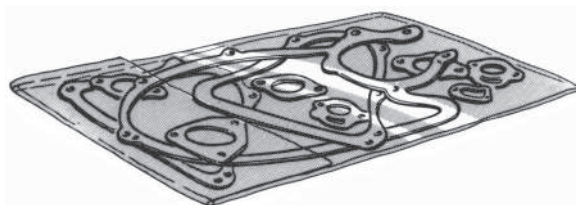

### SERIE GUARNIZIONI MOTORE

- |                |   |                |  |
|----------------|---|----------------|--|
| <b>55082</b>   | Cagiva 125 - 2T SST - SXT mod. 78-79                        | <b>71662</b>   | 125 Primavera  |
| <b>55083</b>   | Cagiva 125 - 2T SST - SXT mod. 80-81                        | <b>1154630</b> | PK125 - PK125XL  |
| <b>55084</b>   | Cagiva 125 - 2T SXT mod. 82                                 | <b>80136</b>   | P125X - P150X  |
| <b>55085</b>   | Cagiva 125 - 2T WMT mod. 81-83 - WRX mod. 82-83             | <b>80139</b>   | P200E - Rally 200 - 2ª Serie   |
| <b>55087</b>   | Cagiva 175 - 2T SX  | <b>91031</b>   | APE 50   |
| <b>55088</b>   | Cagiva 250 - 2T SX fino al 79                               | <b>93846</b>   | APE MPR - MPM - MPV - CAR  |
| <b>55089</b>   | Cagiva 250 - 2T SST - SX mod. 80-82 Ala Verde - Blu mod. 83 | <b>6459</b>    | 125 - 1961-1962 - 150 1959 al 1965   |
| <b>55090</b>   | Cagiva 350 - 2T SST - SX mod. 80-82 Ala Verde - Blu mod. 83 | <b>80135</b>   | 150 Sprint con miscelatore automatico - 2ª Serie                                       |
| <b>55107</b>   | Cagiva 125 - 2T Aletta Electra                              | <b>79857</b>   | Sprint - GT - Super  |
| <b>55108</b>   | Cagiva 125 - 2T WMX - GP 85                                 | <b>80137</b>   | Super - GTR con miscelatore automatico - 150 VBB2 - GL                                 |
| <b>55109</b>   | Gilera 125 - 2T RV - RX (senza testa cilindro)              | <b>6464</b>    | GS 160   |
| <b>55197</b>   | Cagiva 200 - 2T - Elefant 200 - 2/200                       | <b>79858</b>   | Rally 180  |
| <b>6465</b>    | Ciao - Boxer - Bravo - SI                                   | <b>1154699</b> | Vespa T5   |
| <b>71661</b>   | 50 - 50S - 50 Special - 90 - 2ª Serie                       | <b>1154609</b> | Ape P703 - P703V - P602 - TM   |
| <b>1154616</b> | PK50 - PK50XL - Rush - N - V                                | <b>1154873</b> | Sfera - Zip - Free - Zip Fast Rider - Typhoon  |
|                |   | <b>55395</b>   | Malaguti F10 - Centro - Yamaha Jog - CRZ - MBK Hot Champs - Target - Aprilia SR - Beta |
|                |   | <b>55611</b>   | Serie guarnizioni motore Piaggio H2O   |
|                |   | <b>55614</b>   | Serie guarnizioni motore Malaguti F12  |



- 71892** Guarnizione raccordo scarico - Vespa 50 - 50 Special - 90 - 125 Primavera - ET3 - PK50 - **rame amianto** - con foro prigioniero ø 8



- 71892 E** Guarnizione raccordo scarico - Vespa 50 - 50 Special - 90 - 125 Primavera - ET3 - PK50 - **Klingerite** - con foro prigioniero ø 8

- 1222209** Guarnizione raccordo scarico - Vespa PK125 - PK125XL

- 55599** Guarnizioni scarico motori Minarelli 50 cc



- 1259198** Guarnizioni scarico motori Piaggio - Gilera 50 cc

- 1432127** Guarnizioni scarico motori Piaggio 125 - 150 cc - 2 tempi

- 55893** Guarnizione scarico spirometallica motori Minarelli 50 cc (mm 25x35x5)



- 1196931** Guarnizione per raccordo aspirazione con flangia a tre fori Vespa PK50XL - PK125XL - PK50 - PK50S - PK125 - PK125S (dal 1985)



- 1259198 B** Guarnizione scarico - Modifica Scooters



- 91238** Serie gommini cilindretti freni - Ape 50  
**55007** Serie gommini cilindretto freno anteriore - Ape MP  
**90261** Serie gommini cilindretto freno posteriore - Ape 175 - MP - MPR - MPV - Ape CAR



- 91293** Serie gommini pompa centrale - Ape 50  
**90336** Serie gommini pompa centrale - Ape 175 - MP - MPM - MPR - MPV - Ap CAR



- 55248** Serie gommini cilindretto freno anteriore - Ape TM P602 - TM P703 - TM P703V  
**55250** Serie gommini cilindretto freno posteriore - Ape TM P602 - TM P703 - TM P703V  
**55545** Serie gommini cilindretto freno - Ape P 50 tm - dal 1996



- 55247** Serie gommini pompa centrale - Ape TM P602 - TM P703



<b>1498337</b>	<b>Piaggio</b> Sfera - Quartz - Zip - Fast Rider - Free - Typhoon - Storm	Lato volano: Lato frizione: Alberino primario: Albero ruota post.:	18 x 28 x 7 19 x 30 x 6 22 x 40 x 7 30 x 47 x 6	
<b>55692</b>	<b>Piaggio</b> Liberty	Lato volano: Lato frizione: Puleggia frizione post: Alberino primario: Albero ruota post.:	18 x 28 x 7 19 x 30 x 7 34 x 39 x 3 17 x 28 x 6 30 x 47 x 6	
<b>3244</b> <b>3244 OR</b> completo di OR	<b>Piaggio</b> Vespa 50 - 125 Primavera - ET3 PK50 -PK125- Ape 50 1° serie (N.O. 154816)	Lato volano: Lato frizione: Albero ruota post.:	19 x 32 x 7 22,7 x 47 x 7 27 x 37 x 7	<b>2180</b> <b>71075</b> <b>2327</b>
<b>3267</b> <b>3267 OR</b> completo di OR	<b>Piaggio</b> Vespa PX125 - PX150- PX 125E - PX150E - Arcobaleno 1° serie	Lato volano: Lato frizione: Albero ruota post.: Albero ruota post. Arcob.:	24 x 35 x 6 31 x 62,5 x 4,3 27 x 47 x 6 30 x 47 x 6	<b>80120</b> <b>80121</b> <b>80165</b> <b>2370</b>
<b>3268</b> <b>3268 OR</b> completo di OR	<b>Piaggio</b> Vespa PX200E - Arcobaleno	Lato volano: Lato frizione: Albero ruota post.:	24 x 35 x 6 31 x 62,5 x 4,3 27 x 47 x 6	<b>80120</b> <b>80121</b> <b>2370</b>
<b>1154819</b> <b>1154819 OR</b> completo di OR	<b>Piaggio</b> Vespa PK 50 XL - N - Rush - Ape 50 1°serie - FL1 - FL2	Lato volano: Lato frizione: Albero ruota post.:	20 x 32 x 7 22,7 x 47 x 7,5 27 x 37 x 7	<b>S.17016</b> <b>71075</b> <b>2327</b>
<b>3256</b>	<b>Piaggio</b> Vespa Sprint - Super - GL - TS	Lato volano: Lato frizione: Albero ruota post.:	20 x 62 x 6,5 20 x 40/60 x 7 27 x 37 x 7	<b>74272</b> <b>74273</b> <b>2327</b>
<b>1154821</b>	<b>Piaggio</b> Ape MP 501 (78/82 1°serie) - 190 cc. (Viton) Ape MP 601 (78/82 1°serie) - 220 cc. (Viton)	Lato volano: Lato frizione:	62 x 32 x 6 45 x 24,9 x 6,5	<b>89975</b> <b>86452</b>
<b>1154823</b>	<b>Piaggio</b> Ape MP 501 (dal 82 1°serie) - 190 cc. - Ape Car P2 - P3 - Ape TM P702 - P703 - P602 (Viton)	Lato volano: Lato frizione:	62 x 34 x 6 40 x 24,9 x 6,5	<b>1222478</b> <b>1169810</b>
<b>1154824</b>	<b>Piaggio</b> Ape MP 601 (dal 82 1° serie) - 220 cc. (Viton)	Lato volano: Lato frizione: Albero ruota post.:	62 x 34 x 6 45 x 32 x 5 40 x 25 x 7	<b>1222478</b> <b>1221438</b> <b>55914</b>
<b>55895</b>	<b>Piaggio Gilera</b> Paraoli banco (Viton) - Scooter 50 cc.		30 x 19 x 7 28 x 18 x 7	<b>1482314</b> <b>1482315</b>
<b>55896</b>	<b>Minarelli Yamaha</b> Paraoli banco (Viton) - Motori Verticali - Orizzontali 50 cc.		42 x 19 x 8 34/30 x 20 x 6	<b>55700</b> <b>55699</b>



**1576773** Soffietto aspirazione Liberty 50 2T - 4T  
PPT 125 Leader - PPT 150 Leader



**92711** Soffietto depuratore aria -  
Vespa 125/150 VBA - VBB - P125X -  
P150X - P200E



**1133404** Raccordo fra carburatore e depuratore -  
Ape MP - MPR - MPV - Ape CAR



**1220403** Raccordo fra carburatore e depuratore -  
Ape TM P703 - P703V



**80113** Raccordo carburatore  
Vespa 150 Sprint-VLB1-180 Rally  
(P.122327)



**86755** Raccordo in gomma  
Vespa GS 160-180SS  
(P.77628)



**91178** Cuffia tenuta olio semiassi -  
Ape 50



**71543** Cuffia protezione bocchettone  
aspirazione - Vespa 50 - 90 - 125 - ET3



**93076** Cuffia tenuta olio semiassi -  
Ape MP - MPR - MPM - MPV -  
Ape CAR



**1178694** Soffietto depuratore - Vespa PK50 -  
PK125



**62105** Soffietto raccordo immissione  
Vespa 125 V1T/15T - V30/33T - VM1/2T  
(P.11249)



**62106** Soffietto raccordo immissione  
Vespa 125 VN 1/2T - Vespa 150 VL 1/2/3 - VB 1T  
(P.22674)



**U 30627** Chiave per ghiera frizione - Vespa tutti i tipi  
(ad eccezione dei modelli 50 - 90 - 125 Primavera)



**55532** Estrattore volano - Peugeot -  $\varnothing$  **24** - passo **1 destro**

**55534** Estrattore volano - Piaggio -  $\varnothing$  **26** - passo **1 destro**

**55535** Estrattore volano - Malaguti -  $\varnothing$  **22** - passo **1,5 destro**



**U 20322** Estrattore frizione - Vespa tutti i tipi  
(ad eccezione dei modelli 50 - 90 - 125 Primavera)



**U 48564** Estrattore volano - Vespa 125/150 - dal 1970 - P125X -  
P150X - P200E - 180SS - 200 Rally



**U 29551** Estrattore frizione - Vespa 50 - 90 - 125 Primavera



**6670** Chiave candela - Vespa 125 - 150 - Sprint - Super - Rally (11 - 13 - 21)



**71546** Chiave candela - Vespa 50 - 125 Primavera (11 - 13 - 21)

**71890** Chiave candela - Vespa 50 - 125 Primavera (11 - 17 - 21)

**71889** Chiave candela - Vespa 50SS - 90SS (13 - 13 - 21)

**72040** Chiave candela - Vespa 50S - 90 (13 - 17 - 21)



**71828** Perno ancoraggio sella - Vespa 50 - 90 - 125 Primavera - ET3



**1161513** Perno ancoraggio sella - P125X - P150X - P200E



**71829 M** Perno ancoraggio 12x73 mm - modifica per sellone



**91069** Maniglia porte - Ape 50

**91069 N** Maniglia porte - Ape 50 (Nera)



**1085058** Misurino preparazione miscela



**1267798** Protezione filo contachilometri - SI F.L. - dal 1992



**80225** Bicchiere spia olio  
(veicoli con miscelatore separato)  
Vespa PX tutti i tipi  
(P. 155526)



**58335** Tappo olio motore - Honda - SH 125-150



**73594** Sfiatatoio olio - Vespa tutti i tipi -  
Ape 50 tutti i tipi (P. 19301)



**73840** Tappo serbatoio Vespa P125X - P150X -  
P200E Prima Serie



**73840 CH** Tappo serbatoio con chiave Vespa P125X -  
P150X - P200E Prima Serie



**58526 V** Tappo serbatoio Vespa 50 FL - N - PK - PX - T5  
(P. 575825) Ø 71



**58526 R** Tappo serbatoio Vespa 50 FL - N - PK - PX - T5  
Ø 60



**73454** Guarnizione apertura tappo serbatoio Vespa  
125 V1- VM - VN - TS 150 - VL - VB - VBA  
GS - VS1 - 180 SS - Rally - PX 80-125-150  
P 200E (Adatt. P.2319)



**58550** Guarnizione tappo serbatoio piccolo  
28 x 50 x sp. 4

**58551** Guarnizione tappo serbatoio grande  
56 x 72 x sp. 4



**71428** Rubinetto completo - Vespa 50 - 90 - 125 Primavera

**1158793** Rubinetto completo - Vespa P125X - P150X - P200E

**1214267** Rubinetto benzina - Vespa PK50 - PK50S - PK125 - PK125S - PK50XL - PK125XL

**1217872** Rubinetto carburante completo - Vespa PX125E - PX150E - PX200E (Serie Arcobaleno)

**1231005** Rubinetto benzina completo - Vespa 50V F.L. 2



**80235** Rubinetto completo con decantatore  
Vespa 125 GTR - TS - 150 Super - Sprint - Veloce  
Rally 200



**80235CR** Rubinetto benzina completo  
**Decantatore Vetro**  
Vespa 180 SS-  
Vespa 125 GTR-TS  
150 Super-150 GS-150 GL-160 GS  
Sprint-Sprint Veloce



**62111** Rubinetto benzina Vespa 125 VNA 1/2  
VNB 1/2 - 150 VBA 1T



**91291** Rubinetto carburante - Ape 50 - completo

**93295** Rubinetto carburante - Ape MP - completo

**93523** Rubinetto carburante - Ape MPR - MPV - MPM - completo

**97108** Rubinetto carburante - Ape CAR - completo

**100734** Rubinetto carburante - Ciao PX

**100770** Rubinetto carburante - Boxer

**1164034** Rubinetto carburante - SI



**1189320** Rubinetto carburante completo - Ape TM P703



**1295534** Rubinetto benzina - Free - Sfera - Zip - Zip Fast Rider - Typhoon

**55698** Rubinetto benzina - MBK "Ovetto" (adatt. 5BRF-4500-00)



**58167** Rubinetto benzina Derby 50





**55697** Rubinetto benzina - MBK  
Booster Next Generation Spirit  
(adatt. 4SBF-4500-00)



**55396** Rubinetto benzina - MBK Booster -  
Aprilia Amico



**58147** Rubinetto benzina Honda SH 50 dal '96 -  
(R.O. 16950-KJ9-751)



**1575833** Rubinetto benzina depressione

**1575320** Rubinetto benzina depressione  
Vespa ET2 - Zip - Zip 4 -  
Liberty 125-150 -  
Vespa ET4 125-150



**58002** Rubinetto benzina -  
(adatt. 5DSF4500)  
Majesty 125-150 - Skyliner 125-150



**55974/5** Codulo -  $\varnothing$  5

**55974/6** Codulo -  $\varnothing$  6

**55974/8** Codulo -  $\varnothing$  8

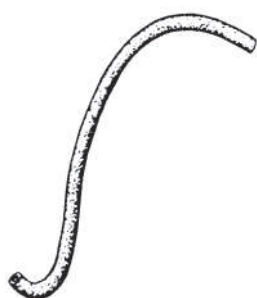

**58008-5** Tubo benzina  $\varnothing$  5 x 8 (mt)

**58008-6** Tubo benzina  $\varnothing$  6 x 10 (mt)

**58008-7** Tubo benzina  $\varnothing$  7 x 11 (mt)

**58008-8** Tubo benzina  $\varnothing$  8 x 12 (mt)



- 55922** Pompa miscelatore olio completa  
 MBK - Booster Malaguti - F10  
 Booster R F12  
 Spirit Centro  
 Evolis F15  
 Fizz  
 Forte  
 Nitro  
 Stunt



- 1197572** Raccordo serbatoio olio - Piaggio (R.O. 197572) -  
 Gilera (R.O. 574362)

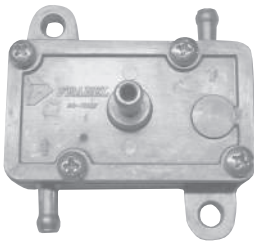

- 1431109** Pompa carburante - Piaggio - Hexagon 125-150  
 Gilera - Runner 50 - FX - FXR 125-180 -  
 Typhoon X 125 - Beta - 50 Tempo - Quadro - Crono

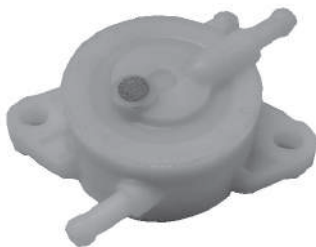

- 1120901** Pompa carburante (R.O. CM. 120901-827894)  
**Gilera** Runner VX-VXR 125-180-200 00/02  
**Piaggio** Super Hexagon 125-180 00 -  
 Hexagon LX  
 Super Hexagon GTX 12" 125-180 01  
 Beverly RST 250 - X9 125-200 01/03  
 X9 Evolution 180 -  
 X9 Amalfi 180 00/03  
 Vespa Granturismo 125-200  
 X8 125-200 - NRG Power



- 1259346** Indicatore di livello carburante - Zip - Zip Fast Rider



**1256349C** Asta rubinetto completa - Vespa 50V F.L.2 - 50N



**71397** Asta rubinetto completa  
Vespa 50 - 90 - 125 - ET3



**80224** Asta rubinetto completa - Vespa PK50 - PK125 -  
PK50XL - PK125XL - PX125 - PX150 - P200E



**62007** Asta carburante mm 119 Vespa VN 1T - VM 2T  
VN 1T - VN 2T - VNA 1T - VNA 2T - VL 1T - VL 2T  
VL 3T - VB 1



**62008** Asta carburante mm 96 Vespa GS 150 VS 1T -  
VS 2T - V3 3T - VS 4T - VS 5T  
P. 026043



**1623139** Serbatoio olio con indicatore livello  
Vespa PX 125 - PX 150 - P 200 E  
Lubrificazione separata



**1263449** Serbatoio olio - APE MP 501 - 601 - TM  
P 602 - P 703 con indicatore riserva



**1140925** Motorino tergicristallo  
Ape TM - P 602 - P 703



**1615341** Alberi trasmissione Porter 1400 diesel pianale cm 67



**1615339** Alberi trasmissione Porter 1300 16v benzina pianale  
cm 51,5



**55075** Calotta per perno ruota ciclomotore - ø 32

**55076** Calotta per perno ruota ciclomotore - ø 35

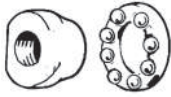

**55138** Cono per perno ruota ciclomotore - ø 11

**55139** Cono per perno ruota ciclomotore - ø 12

**55146** Gabbia a sfere per perno ruota ciclomotore - ø 11

**55393** Gabbia a sfere per perno ruota ciclomotore - ø 12

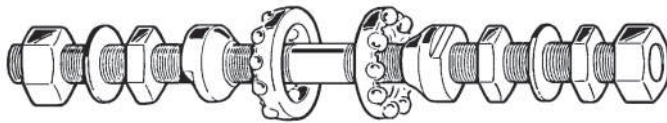

**55067** Perno ruota ciclomotore - completo - ø 11x180

**55068** Perno ruota ciclomotore - completo - ø 11x200

**55069** Perno ruota ciclomotore - completo - ø 11x200 con gabbie a sfera

**55070** Perno ruota ciclomotore - completo - ø 12x200

**1186524 C** Perno ruota ciclomotore - completo - ø 11x160 con gabbie a sfera - SI F.L. - dal 1992



**100407 C** Perno completo gruppo oscillante sostegno motore - Ciao - Boxer - Bravo - SI - Grillo

**71400** Bullone fissaggio motore - Vespa 50 - 90 - 125 Primavera - ET3

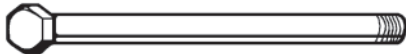

**74406** Bullone fissaggio motore - Vespa 125 g.t.r. - 125 ts - 125/150 Super - 150 Sprint - P125X - P150X - P200E - 200 Rally

**71152** Prigioniero fissa cilindro - Vespa 50 - PK50 - PK50XL

**74248** Prigioniero fissa cilindro - Vespa 125 Primavera - ET3 P125X - P150X - Arcobaleno - PK125 - PK125XL

**86500** Prigioniero fissa cilindro - P200E

**86042** Prigioniero fissa raccordo scarico (6x30) - Vespa 50- PK50 - PK50XL - 125 Primavera - PK125 - Ape 50

**86042 M** Prigioniero fissa raccordo scarico maggiorato ø 7

**71658** Prigioniero fissa raccordo scarico (8x35) - Vespa 125 Primavera - PK125XL

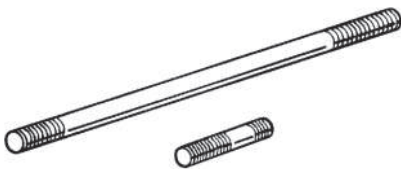

**100051** Prigioniero fissa cilindro - Ciao - Boxer - Bravo - SI

**1239382** Prigioniero fissa cilindro (6x106) - Sfera - Zip - Zip Fast Rider - Free - Typhoon

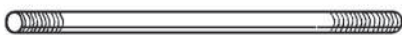

**55648** Prigioniero cilindro - Motori Minarelli - M7 x 110 - Rif. 49-0526-0





**1178810** Molla fissa ganasce - Ape TM



**1178750** Molla ganasce freno - tipo corto - Ape TM P602 - P703



**1178809** Molla ganasce freno - tipo lungo - Ape TM P602 - P703

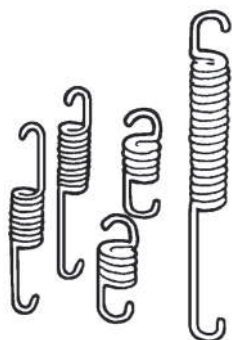

**55303** Kit molle ritegno ganasce - Ape TM P6703 - P703V



**71236** Molla per leva avviamento - Vespa 50 - 90 - 125 Primavera - ET3



**86036** Molla frizione - Vespa 125 - 150 - Super - Rally - Sprint - P125X - P150X - P200E - PX125E - PX150E - PX200E (Serie Arcobaleno)



**74042** Molla richiamo ganasce - Vespa 125/150



**71144** Molla parastrappi - Vespa 50 - 90 - 125 Primavera - ET3

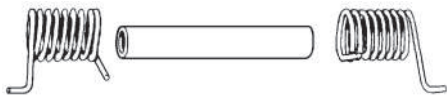

**100729** Perno fissaggio cavalletto - Ciao PX

**1164167** Perno fissaggio cavalletto - SI

**1164165/166** Coppie molle cavalletto SI



**1214226/205** Coppie molle cavalletto Bravo 82

**1214490** Perno cavalletto Bravo 82



**1164167 M** Perno cavalletto - Modifica - SI

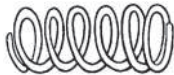

**1287011** Molla puleggia condotta - Sfera - Zip - Free



**55503** Set 2 molle a carichi maggiorati per variatore - Zip - Sfera

**55498** Set 2 molle a carichi maggiorati per variatore - Sfera dal 1995 - Quartz - Free - Zip Fast Rider - Typhoon - Storm - NTT - NRG



**55500** Kit molle con carico differenziato per frizioni motori - Piaggio



**55500 KB** Tris molle rinforzate



**100093** Anello elastico ganasce freno - Ciao - Boxer - Bravo - SI



**1221600** Molla richiamo masse frizione - Boxer - SI (con variatore)



**71417** Molla richiamo pedale freno  
Vespa 50 - 90 - 125 Primavera

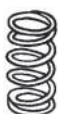

**93655** Molla frizione - Ape MP - MPR - MPV - MPM



**93170** Molla richiamo ganasce inferiore  
Ape MP - MPR - MPV - MPM

**93171** Molla richiamo ganasce superiore  
Ape MP - MPR - MPV - MPM

**79906** Molla sospensione anteriore - Vespa 125 gtr -  
125 ts - 150 Super - 150 Sprint - Rally 200



**93172** Molla sospensione anteriore - Ape MP - MPR - MPM  
- MPV

**1174079** Molla sospensione anteriore - Vespa P125X - P150X -  
P200E



**72155** Molla ritegno fanale - V50 Special (P. 124505)

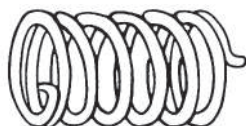

**1221172** Molla puleggia condotta con ganci



**55814** Molla pignone scorrevole  
motori Minarelli - MBK - Yamaha  
(R.O. 3VLE56730000)



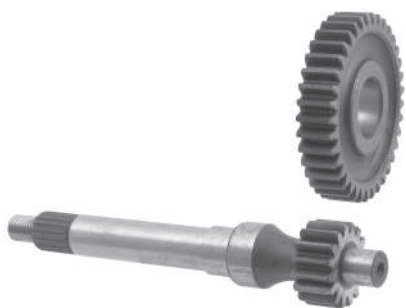

**55429** Coppia ingranaggi **Z15/38** - Free - Typhoon - Zip Fast Rider - Quartz

**55367** Coppia ingranaggi **Z16/37** - Sfera - Zip



**55451** Coppia ingranaggi - Peugeot SV - Geo 50 - **Z14/45**

**55452** Coppia ingranaggi - Malaguti - F10 - **Z17/40**

**55488** Coppia ingranaggi **Z16/47** - Sfera - Zip Fast Rider - Typhoon - Storm - NRG - dal 1995 (ø mm 17.67)

**55694** Coppia ingranaggi **Z15/55** - Piaggio Liberty

**55694 B** Coppia ingranaggi **Z15/55** - Piaggio Liberty - Vespa ET2 - (ultima serie e pressa)



**55373** Ingranaggio **Z16** per campana frizione originale - Vespa 50 - Ape 50

**520009/10CP** Coppia trasmissione pignone Z.18 - Corona Z.67 - Denti elicoidali - **con parastrappi** - Vespa 50 R Ape 50

**520009/10** Coppia di trasmissione con pignone Z.18 e corona Z.67 - dentatura elicoidale

**520011/12 DE** Coppia di trasmissione con pignone Z.22 e corona Z.63 - dentatura elicoidale

**55328** Coppia di trasmissione con pignone Z.22 e corona Z.63 - dentatura elicoidale - **senza parastrappi**

**520011/12DD** Coppia di trasmissione con pignone Z.24 e corona Z.72 - dentatura dritta

**520056/57 DE** Coppia di trasmissione con pignone Z.24 e corona Z.61 - dentatura elicoidale

**520056/57 DD** Coppia di trasmissione con pignone Z.27 e corona Z.69 - dentatura dritta





**1157800** Alberone cambio  
Vespa PXE Arcobaleno  
125 - 150 - 200

**1235908** Alberone cambio  
Vespa T5 - Cosa 2 - CL - CLX  
125 - 150 - 200  
Vespa PX freno disco 98-2001

**73120** Dado fissa albero ruota posteriore  
Vespa 50 - 50S - 125 Primavera

**1194424** Dado fissa albero ruota posteriore  
Vespa PK50 - PK125 - P125X -  
P150X - P200E (dal 1982) -  
PX125E - PX150E - OX200E  
(Serie Arcobaleno)

**1194423** Coperchietto fissa dado albero ruota posteriore - Vespa PK50 - PK125 - Vespa 50 - 50S -  
125 Primavera - P125X - P150X - P200E (dal 1982) - PX125E - PX150E - PX200E  
(Serie Arcobaleno)



**87001 DD** Serie completa ingranaggi -  
**rinforzati** - Ciao - Bravo - SI - con  
variatore - dentatura diritta



**72027** Asse ruota anteriore Vespa 50 - 90  
125 Primavera - ET3 (P. 158251)



**1289132** Asse ruota posteriore - Sfera dal 94 - Zip dal 94 -  
Zip Fast Rider - Free - Quartz - Typhoon

**1480053** Asse ruota posteriore - Piaggio Liberty  
**(lunghezza asse mm 146 -  
ø lato astuccio mm 12)**



**1224309** Boccola per asse ruota posteriore



**1176449** Ingranaggio duplo rinvio -  
denti elicoidali - Ciao PX

**1178696** Ingranaggio rinvio duplo - denti elicoidali - SI -  
con variatore - **tipo rinforzato**



**55877** Asse ruota posteriore - Malaguti -  
MBK (**1ª serie**)

	LT	LP	ø1	ø2
mm	126	55	22	17

**55863** Asse ruota posteriore - Malaguti -  
MBK (**2ª serie**)

	LT	LP	ø1	ø2
mm	146	79	22	17



**71695** Quadruplo - Vespa 50 Special - 90 - 125 Primavera -  
ET3 - PK50 - PK125 - XL (Z.10 - 14 - 18 - 22)



**80171** Ingranaggio multiplo - Vespa P125X - P150X -  
125GTR - 150 Sprint - completo



**93675** Ingranaggio duplo - Ape MPM - MPR - MPV -  
Ape CAR

**1169744** Ingranaggio duplo - Ape TM P602 - P703



**93677** Ingranaggio scorrevole - Ape MPM - MPR - MPV -  
Ape CAR



**520203** Settore avviamento  
Vespa 150 - VBA - VBB del 1959  
Attacco millerighe - P. 53681



**74683** Cuscinetto a rulli m/m completo  
Vespa 125 VNA - VNB 1958 -  
VNB 61-65 - Vespa 150 VBA -  
VBB 1959 - GL - VLA1 -  
Sprint - Super - Rally 180



**520008** Settore avviamento - Vespa 50 - 90 - 50SS - 90SS -  
125 Primavera - XL - Rush - N - V

**520027** Settore avviamento - Vespa 50S

**520679** Settore avviamento - Vespa dal 1964

**510826** Settore avviamento - Ape 175

**1148570** Settore avviamento - Vespa P125X - P150X - P200E -  
PX125E - PX150E - PX200E (Serie Arcobaleno)



**55737** Settore avviamento  
Scooters Minarelli - Motori verticali



**55738** Settore avviamento  
Scooters Minarelli - Motori orizzontali



**1827382** Settore avviamento -  
Skipper 125-150 (4 T.) - Liberty 150 -  
Zip 125 - Vespa ET4 125 - 150

**55741** Settore avviamento  
Scooters Peugeot - Buxy -  
Speedake - Zenith



**58032** Settore avviamento -  
Motori Suzuki Aria - Address -  
Franco Morini Aria - Malaguti Crosser



**1432054** Settore avviamento -  
Scooters Piaggio - Gilera 50 cc



**1478723** Settore avviamento - Vespa ET4 -  
Liberty 125 - Sfera 125 - Hexagon LX4

**1434087** Settore avviamento - Hexagon LX LT  
125-150 - Skipper 125-150 - LX

44  
mm

15 mm

**58146** Ingranaggio M/M Motori Honda 50  
(R.O. 28230-GN2-600)

42,5  
mm

13,5 mm

**58146B** Ingranaggio m/m  
Kymco 50 cc



**1483537** Ingranaggio M/M - motori Piaggio - Gilera 50cc

**1483539** Ingranaggio m/m Skipper 125-150 - Liberty 125-150 -  
Vespa ET4 125-150 - Hexagon LX4 125 - Zip 125

**58004** Ingranaggio m/m Peugeot 50 cc - tutti i tipi

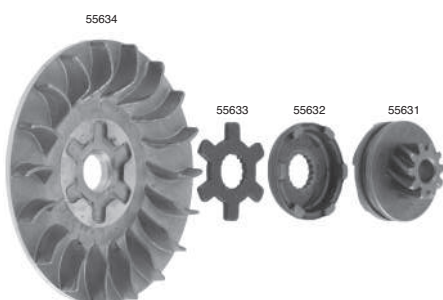

**55631** Ingranaggio m/moto - Motori Minarelli - Rif. 4006590 -  
Yamaha - Rif. 3AA 1563100

**55632** Ghiera dentata - Motori Minarelli - Rif. 2602730  
Yamaha - Rif. 3VL E565700

**55633** Piastrina dentata - Motori Minarelli - Rif. 2606707 -  
Yamaha - Rif. 9021413055

**55634** Puleggia anteriore fissa - Motori Minarelli -  
Rif. 6005050 - Yamaha - Rif. 3VL E761100

**55634 C** Kit completo avviamento - Motori Minarelli - Yamaha



**58006** Ingranaggio innesto motorino - puleggia avviamento fissa  
Motori Piaggio 50 cc (adatt. 82531R)

**58033** Ingranaggio innesto motorino - puleggia avviamento fissa  
Motori Franco Morini - Aria

**1293799** Ingranaggio innesto motorino - puleggia avviamento fissa  
125 Liberty - Sfera 125 - Hexagon LX4 - ET4 125

**58035** Ingranaggio innesto motorino -  
puleggia avviamento fissa - (adatt. 82612R)  
ET4 - Liberty - Skipper 4T. 125-150 - Beverly 125-200 -  
X9125 - X9180



**1096922** Ingranaggio innesto motorino - Puleggia  
avviamento fissa (P. 96922R)  
Piaggio Liberty 4T - Delivery - PTT -  
Moc 2009-2014 - NRG 2007-2009-  
Vespa ET4 200-2005 - Fly 4T 2005-2007



- 520007** Ingranaggio avviamento - Vespa 50 - 90 - 50SS - 90SS - 125 Primavera - XL - Rush - N - V
- 520026** Ingranaggio avviamento - Vespa 50S
- 520407** Ingranaggio avviamento - Vespa **Z12** - 13 innesti
- 520678** Ingranaggio avviamento - Vespa **Z12** - 12 innesti - P125X - PX125E
- 79883** Ingranaggio avviamento - Rally 180 - Rally 200 - P150X - P200E - PX150E - PX200E (Serie Arcobaleno)
- 91062** Ingranaggio avviamento - Ape 50 - **Z15** - 9 innesti

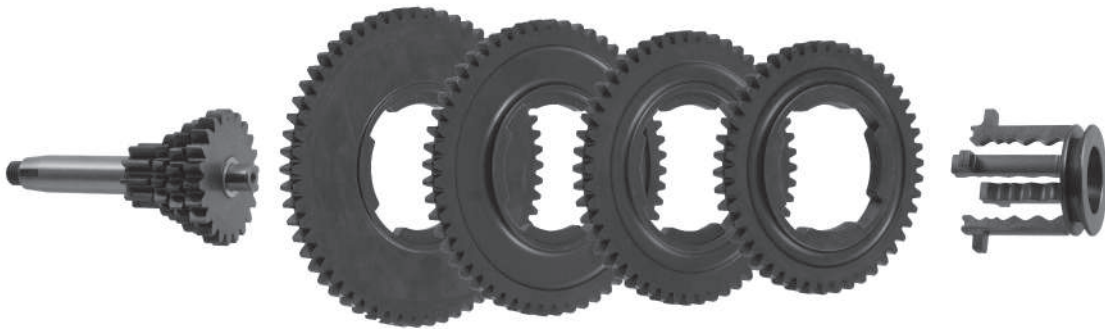

**71000 SA** Gruppo cambio - Vespa 50 - 4 velocità

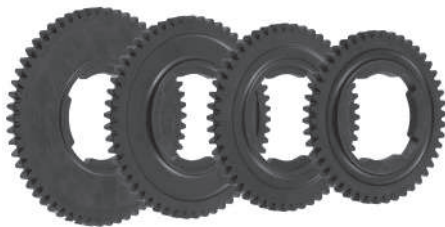

- 72014** Ingranaggio 1<sup>a</sup> velocità - Vespa 50S - 50Special - 125 Primavera - dal 1978 Z58
- 71686** Ingranaggio 2<sup>a</sup> velocità  
Vespa 50S - 125 Primavera - al 1977 - Z54
- 72016** Ingranaggio 2<sup>a</sup> velocità - Vespa 50S - 50 Special - 125 Primavera - dal 1978 - Z54
- 72018** Ingranaggio 3<sup>a</sup> velocità dal 1978
- 71689** Ingranaggio 3<sup>a</sup> velocità - Vespa 50S - 125 Primavera - al 1977 - Z50
- 71691** Ingranaggio 4<sup>a</sup> velocità - Vespa 50S - 125 Primavera - al 1977 - Z46
- 72020** Ingranaggio 4<sup>a</sup> velocità - Vespa 50S - 50 Special - 125 Primavera - dal 1978 - Z46





**1199076** Semiassse - Ape P703 - P703V



**1178003** Crocera ruota posteriore - Ape TM P703 - P703V

**1268311** Crocera ruota posteriore -  
Ape Poker benzina-diesel - Ape Max diesel -  
Ape Car P2/P3 - **fori mm 12**



**93098** Crocera sul semiassse - Ape TM P703 - P703V

**1268312** Crocera sul semiassse - Ape Poker  
benzina-diesel - Ape Max diesel -  
**fori mm 12**



**93138** Astuccio a rulli per albero ruota posteriore -  
Ape MP - CAR - MPR - MPM - MPV

**1177431** Astuccio a rulli per albero ruota posteriore -  
Ape TM P703 - P703V



**91180** Boccia ruota posteriore - Ape 50 -  
(adattabile P.128080)

**1168407** Boccia semiassse - Ape 50 (HK 20.16)



**55316** Kit revisione semiassse (lato ruota) - Ape 50 -  
Tm P50

**1154685** Kit revisione semiassse (lato ruota) - Ape MP -  
MPR - MPM - MPV - CAR - P601 - P601V -  
TM P703 - P703V



- 93165 IT** Giunto elastico Made in Italy  
**93165** Giunto elastico - Ape MP - MPR - MPV - Ape CAR  
**1226345** Giunto elastico - Ape Poker  
**1268253** Giunto elastico - Ape Poker  
 benzina-diesel - **fori mm 12**



- 74449** Supporto elastico ammortizzatore  
 post. Vespa tutti i tipi



- 93328** Supporto elastico motore - Ape MP - MPM -  
 MPR - MPV

- 91088** Supporto elastico carburatore - Ape TM P50 -  
 (P. 127350)



- 93050** Supporto elastico posteriore - Ape MP - MPM -  
 MPR - MPV - Ape CAR



- 71832** Supporto elastico motore - Vespa 50 -  
 125 Primavera - ET3 - PK50 - XL - Rush - N - V



- 1272750** Supporto motore **Piaggio**  
 (P. 272750)



- 93847 M** Supporto elastico carburatore - Ape MPR -  
 MPM - MPV - CAR



- 1266743** Supporto motore oleodinamico Ape Diesel



- 1174724** Supporto motore Vespa PX - PE



**91175** Cilindretto completo freni  
Ape 50  
imboccatura cono maschio

**1174529** Cilindretto completo freni  
Ape 50  
imboccatura cono femmina

**1245765** Cilindretto completo freni  
Ape P 50 tm -  
dal 1996



**90204** Cilindretto completo freni  
posteriore - Ape 175 -  
Ape MP - **destro**

**90208** Cilindretto completo freni  
posteriore - Ape 175 -  
Ape MP - **sinistro**



**93500** Cilindretto completo freno  
anteriore - Ape MPR -  
MPM - MPV - Ape CAR

**93693** Cilindretto completo freni  
posteriore - Ape MPR -  
MPM - MPV - Ape CAR

**1178222** Cilindretto completo freno  
anteriore - Ape TM P602 -  
TM P703 - TM P703V

**1177126** Cilindretto completo freno  
posteriore - Ape TM P602 -  
TM P703 - TM P703V



**1227549** Cilindretto posteriore  
Ape Poker



**1228828** Cilindretto completo posteriore - Cosa 1-2

**1248846** Cilindretto completo anteriore - Cosa 1-2



**58300** Cilindretto completo freno posteriore - Ape Porter



**1286162** Cinghia pompa olio - Scooters - Piaggio - Gilera 50 c

**1431370** Cinghia pompa olio - Scooters - Piaggio -  
Gilera 125-150 cc (2 tempi)



**91289** Pompa freno - Ape 50 -  
1ª Serie

**1219870** Pompa freno -  
Ape 50 Tm P - 2ª Serie

**1249519** Pompa freno -  
Ape 50 Tm P - 3ª Serie



**93240 SB** Pompa freno -  
Ape MP 600 (P. 140251)

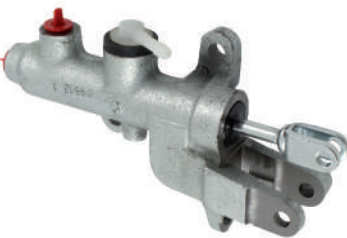

**1179379** Pompa freno -  
Ape TM P703 V dal 84 -  
Ape Car Diesel dal 86

**1197433** Pompa freno -  
Ape TM P602 - TM P703M

**1245593** Pompa freno -  
Ape Car P3 - 2ª Serie



**1249520** Pompa freno -  
Ape TM P703 -  
P703 V 84/89 - Ape Car -  
Max Diesel

**1265195** Pompa freno - Ape Poker  
benzina 93 -  
Poker Diesel 93

**1229217** Pompa freno -  
Ape Car P2 - 2ª Serie -  
P3 - 1ª Serie



**1229254** Pompa freno - Cosa

 **1216705** Targhetta per coperture laterali - Ciao - dal 1985

 **1231900** Targhetta "SI" per coperture laterali - dal 1985

 **100787** Targhetta "PIAGGIO" sulla copertura forcella

 **1198187** Targhetta "ELECTRONIC" - SI

 **1163966** Targhetta per copertura destra e sinistra - Ciao SC

 **1164529** Dicitura "Boxer 2"

 **1163967** Dicitura "Bravo"

**72112** Dicitura "Vespa" - al 1981 (interasse piolini mm 80)

**1194955** Dicitura "Vespa" - dal 1982 (interasse piolini mm 58)

 **1195629** Dicitura "Vespa" - PK50 - PK125 - PK50S - PK125S (interasse piolini mm 58)

**72117** Dicitura "125 Primavera"

 **72118** Targhetta "ET3"

 **72113** Targhetta posteriore Vespa 50 (P. 152509)

 **72115** Targhetta posteriore "50 Special"

 **72114** Targhetta posteriore "50S"

 **72116** Targhetta posteriore "Vespa 90"

 **72117** Targhetta posteriore "125 Primavera"

 **80256** Targhetta posteriore "125 g.t.r."

 **80259** Targhetta posteriore "150 Super"

<b>PK 50</b>	<b>1195630</b>	Targhetta posteriore "PK50"
<b>PK 125</b>	<b>1195634</b>	Targhetta posteriore "PK125"
<b>PK 50 S</b>	<b>1195631</b>	Targhetta posteriore "PK50S"
<b>PK 125 S</b>	<b>1195635</b>	Targhetta posteriore "PK125S"
<b>P 125 X</b>	<b>1181327</b>	Targhetta "P125X"
<b>P 150 X</b>	<b>1182117</b>	Targhetta "P150X"
<b>P 200 E</b>	<b>1181328</b>	Targhetta "P200E"
<b>PX 125 E</b>	<b>1194717</b>	Targhetta "PX125E"
<b>PX 150 E</b>	<b>1194718</b>	Targhetta "PX150E"
<b>PX 200 E</b>	<b>1195641</b>	Targhetta "PX200E"
<b>PX 125 E</b> 	<b>1198181</b>	Targhetta "PX125E" (Serie Arcobaleno)
<b>PX 150 E</b> 	<b>1198182</b>	Targhetta "PX150E" (Serie Arcobaleno)
<b>PX 200 E</b> 	<b>1198183</b>	Targhetta "PX200E" (Serie Arcobaleno)
<b>vespa</b>	<b>1197601</b>	Targhetta "Vespa" (Serie Arcobaleno)

**PX125****1272019** Targhetta resinata PX 125**PX150****1272080** Targhetta resinata PX 150***Gran Turismo*****55851** "Gran Turismo"  
4 pioli mm 3 - interassi mm 72 - mm 55***Vespa GT*****55852** "Vespa GT"  
3 pioli mm 3 - interassi mm 82 - mm 67 - cromata***150 Sprint*****55853** "150 Sprint"  
4 pioli mm 3 - interassi mm 37 - mm 35,5***Vespa Sprint*****55854** "Vespa Sprint"  
4 pioli mm 3 - interassi mm 64 - mm 64***Rally*****55855** "Rally"  
2 pioli mm 3 - interassi mm 64***Vespa Rally*****55855 B** "Vespa Rally"  
4 pioli mm 3 - interassi mm 64 - mm 52***Special*****55856** "Special"  
4 pioli mm 3 - interassi mm 26 - mm 36***Vespa*****55857** "Vespa"  
2 pioli mm 3 - interasse mm 103***Vespa S*****55858** "Vespa S"  
3 pioli mm 3 - interasse mm 81 - mm 52***Vespa GL*****58284** "Vespa GL" - nera  
lunghezza totale mm 167 (con fori)



*Vespa G.L.***58284 B** "Vespa GL" - lucida  
lunghezza totale mm 135 (con fori)*Vespa***55859** "Vespa" - blu notte  
lunghezza totale mm 141*Vespa***55859 L** "Vespa" - alluminio lucido  
lunghezza totale mm 141*Primavera***58271** "Primavera"  
4 pioli mm 3 - interassi mm 50 - mm 51*Vespa***58273** "Vespa" - grigio verde scura  
lunghezza totale mm 141*Sprint***58272** "Sprint" - lucida  
2 pioli mm 3 - interasse mm 64*Sport***58276** "Sport" - lucida  
2 pioli mm 3 - interasse mm 59*Vespa 50***58274** "Vespa 50" - lucida*150 Super***58278 B** "150 Super" - lucida  
4 pioli mm 3 - interasse mm 23 - mm 24*150***58281** "150" - lucida  
2 pioli mm 3 - interasse mm 23*50***58282** "50" - lucida  
2 pioli mm 3 - interasse mm 16



**58283** "R" - lucida  
2 pioli mm 3 - interasse mm 20

**58283 N** "R" - nera



**58288** "Vespa S.S." - lucida  
3 pioli mm 3 - interassi mm 80 - mm 72



**58275** "Super Sport" - lucida  
4 pioli mm 3 - interassi mm 51 - mm 59



**58286** "Vespa GS" - nera  
tipo grande - lunghezza mm 166



**58287** "Vespa GS." - nera  
tipo piccolo - lunghezza mm 141



**58280** "Lambretta"  
5 pioli mm 2



**58279** "Vespa 125"  
3 pioli mm 3 - interasse mm 74 - mm 51



**58285** "Vespa 150" - lucida



**79912** Scudetto Piaggio - grande (P. 152290)

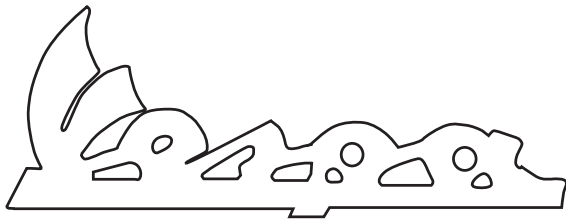

**1573290** Scritta Vespa ET2 - ET4 - Cofano laterale

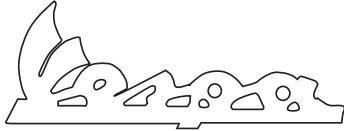

**1573289** Scritta Vespa ET2 - ET4 - Scudo frontale



**1574480** Scritta "Liberty" piccola



**1574479** Scritta "Liberty" grande



**1295486** Scudetto frontale ad incastro



**1295596** Scudetto resinato adesivo



**55415** Emblema "PIAGGIO" EPOCA - **Resina**

**55330** Emblema "PIAGGIO GENOVA" EPOCA - **Alluminio**



**58571** Scudetto **Piaggio** adesivo Vespa 50 N - Primavera 125 VMA1 T



**58437** Emblema "Piaggio" Epoca c/staffa - metallo

**58438** Emblema "Piaggio Genova" Epoca c/staffa - metallo

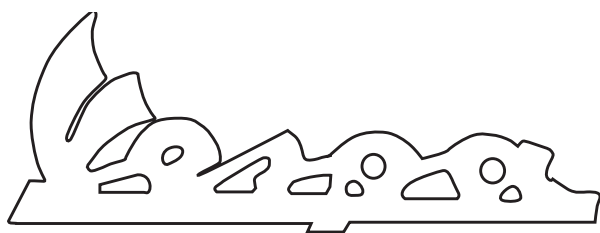

**1577081** Targhetta "Vespa" alluminio - grande



**1577082** Targhetta "Vespa" alluminio - piccola



**1656220** Targhetta Vespa grande  
GTS - GTV - LX - S - PX dal 2011



**1656219** Targhetta Vespa piccola  
GTS - GTV - LX - S - PX dal 2011



**1576464** Targhetta per frontale  
PX 125-150 - Freno disco -  
Vespa ET4 125-150

**HEXAGON**

**1575051** Targhetta "Hexagon"  
laterale

**PIAGGIO**

**1573488** Targhetta "Piaggio" post. Hexagon



**1577061** Targhetta frontale - X9



**80087** Filtro aria (P. 90926)  
Piaggio Vespa 125 - 150 VNA - VNB  
VBA - VBB - VLB1 - VNL2 - VBC1 - VNC1



**80088** Scatola filtro aria - VLB 1 - VBC 1 - PX E -  
PX Arcobaleno (P. 113125)



**58005** Filtro aria Honda - SH 125-150 - @ 125-150 -  
Dylan - (adatt. 17210-KGF-900)

**58569** Filtro aria **Honda** SH 125-150 dal 2014



**58314** Filtro aria  
Honda - SH 300



**97161** Filtro aria (P. 145880 - 248570) -  
Ape CAR - MP - TM P703



**1487845** Filtro aria Gilera Nexus 500 -  
X9 500 - 500 Evolution -  
Hexagon GTX 125-180 - Super Hexagon



**58308-1** Filtro aria centrale  
Yamaha T-Max 500



**58308-2** Filtro aria laterale dx  
Yamaha T-Max 500

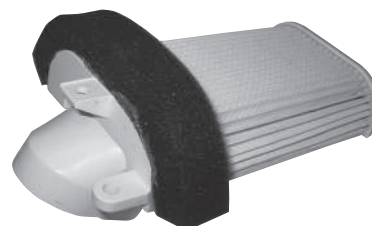

**58308-3** Filtro aria laterale sx  
Yamaha T-Max 500



**1247444** Filtro gasolio Ape Diesel



**1222721** Filtro olio Ape Diesel

**1830239** Filtro olio Motori 500 cc - Piaggio X9 - X9 Evolution - Beverly - Aprilia - Atlantic - Scarabeo



**1230414** Filtro aria - Ape CAR - TM P703 - **DIESEL**



**1410229** Filtro olio motori Piaggio - **4 tempi**



**55675** Filtro olio motore - Aprilia Leonardo 125/150 - **4 tempi**

**58003** Filtro olio motore - Suzuki Burgman 400

**55998** Yamaha Majestic 125-150  
MBK Skyliner 125-150  
Italjet Millennium 125-150  
Benelli Velvet 125-150  
Malaguti Madison 180



**1483727** Filtro olio motori Piaggio 150 - (4 tempi)



**1245305** Radiatore olio  
Ape TM P703 - P703 V Diesel 87-2004  
Ape Poker Diesel 93-97  
Ape Car - Max Diesel 86-96



**1644505** Radiatore Acqua - QUARGO



**55661** L = 85 ø 32

**55662** L = 85 ø 36



**55663** L = 45 ø 32

**55664** L = 45 ø 36



**1197072** Filtro depuratore aria - Vespa PK50 - PK125 - XL - Rush - N - V

**1197073** Depuratore aria completo - Vespa PK50 - PK125 - XL - Rush - N - V



**1183423** Depuratore completo - SI

**1186886** Depuratore completo - Ciao PX



**71904** Depuratore completo Vespa 50S - 90 (P. 112480 - P. 139683)



**71905** Depuratore completo - Vespa 125 Primavera - ET3



**71575** Filtro aria plastica per carburatore 16/10 Vespa 50 - 50 Special (P. 79884)



**71575ME** Filtro aria **Metallo** per carburatore 16/10 Vespa 50N - L - R





**91372** Filtro aria - Ape 50  
(N.O. 260569 - 119572)



**55849** Filtro aria - Malaguti F10-F12 - MBK Nitro -  
Ovetto - Yamaha Neo's - Aerox  
(N.O. 4BRE 44100 MBK)  
(N.O. 06605803 Malaguti)



**55813** Depuratore completo Booster - Spirit -  
Booster R - Booster N.G.  
(R.O. 3VLE441100100)



**55891** Raccordo in gomma per filtro aria -  
MBK Booster - Spirit - NG - R -  
Trach - Rocket (N.O. 3VLE 445302)



**55963** Filtro aria - Scarabeo 50  
(R.O. 8248127 Aprilia)



**1814424** Manicotto carburatore filtro  
Scarabeo 50-100 fino al 2006  
(AP 8144248)



**100011** Camma volano - Ciclomotori



**100158** Puleggia condotta per Ciao - Bravo - Boxer - SI (ø 90)

**100158 R** Puleggia condotta per Ciao - Bravo - Boxer - SI - ridotta (ø 80)



**100176** Ruota libera - Ciao - Boxer (Z 18)

**100689** Ruota libera - Bravo - SI (Z 16)



**55736** Ruota libera avviamento completa - Motori Minarelli - Yamaha - Malaguti - Aprilia (R. Mal. 74012500)



**58219** Ruota libera Motori Minarelli Yamaha 125-150

**58220** Ruota libera  
Honda SH 125-150 4T  
Chiocciola 125-150 4T  
Pantheon 125-150 4T

**58221** Ruota libera Honda Foresight 250 4T

**58222** Ruota libera Aprilia Scarabeo 125-150 - 4T



**1831322** Ruota libera completa di anello  
Piaggio - Beverly RST 250 -  
Beverly 500 2002/2005  
X9 500 - Evolution 500 - Vespa GTS 250



**100666** Boccola portaruota libera - Ciao - Boxer - Bravo - SI - Grillo



**100475** Tendicatena - Boxer



**1186948** Tendicatena - SI



**1214489** Molla tendicatena - Bravo 1982

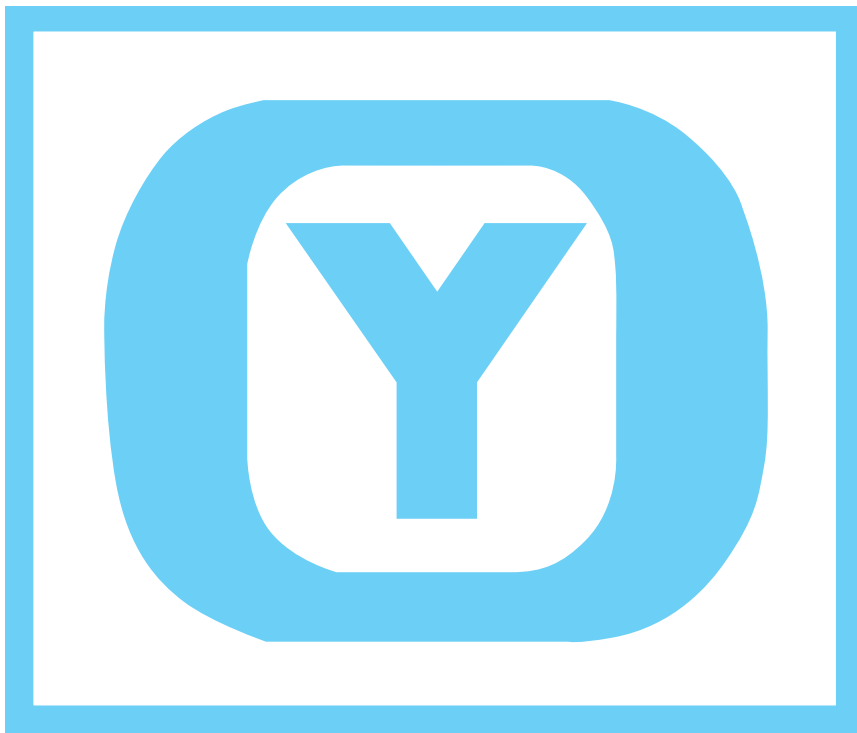

## COPPIA PASTIGLIE



**55483** Piaggio - Sfera dal 1995

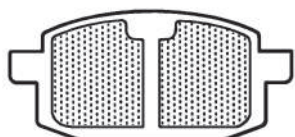

**55484** MBK - Yamaha - Jog 50 - CR 50Z - Target 50 -  
CR 90 - Italjet - Bazooka 2 - Pista 50 - MBK Cento

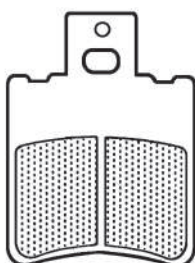

**55485** Aprilia: Amico 82 - Gulliver 95 - Rally 95 - RS 93 -  
Sport 92 - Scarabeo 95 - SR 50 replica  
Gilera: Storm - Typhoon 93 - NRG - Typhoon 50/125  
Malaguti: F10 94  
MBK: Booster 94/95 - Evolis 50/92  
Peugeot: Buxy 94  
Piaggio: Zip Fast Rider - Hexagon - Zip Easy Moving  
Yamaha: Breeze - Ye 50 2 est - Yog 2 50/90

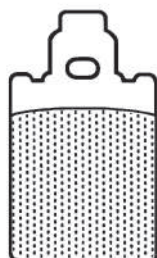

**55486** Piaggio Skipper 125/150 - Quartz 50

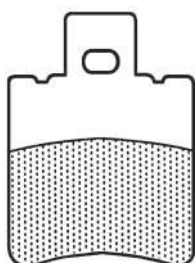

**55487** Piaggio NRG 50 - Storm - NTT

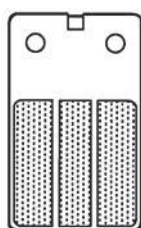

**55489** Gilera Bullit - Malaguti Crosser 95 - F12 94/95



**55491** Aprilia RS 50

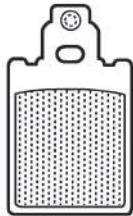

**55492 Malaguti:** Centro 93  
**Aprilia:** 50 Tuareg 86 -  
 50 Red Rose 90 -  
 AF150 86 - Futura 90 -  
 Europa 90 -  
 Tuareg Rally 90 - RX 50 -  
 Tuareg Wind - Climber 240

**Moto Guzzi:** 750 SP

**Fantic:** Fast 90 - Oasis 50 - Oasis 75

**Beta:** Alp 50 - TR34 - Mx Enduro -  
 Derbi 75

**Piaggio:** Free

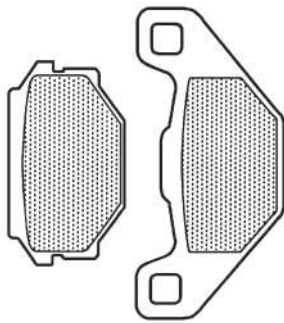

**55493** Lem Flash - Malaguti F10



**55494** Zip Fast Rider - dal 1996 - Vespa ET2 - ET4

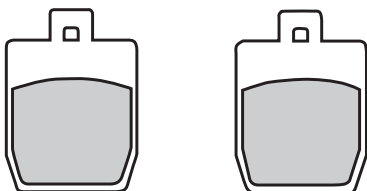

**55732** Coppia pastiglie posteriore  
 Yamaha Aerox LC - MBK Nitro

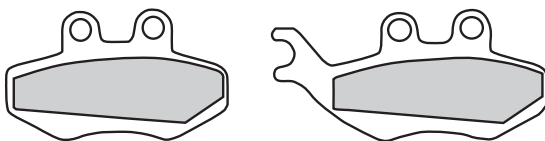

**1494628** Coppia pastiglie - Runner 180

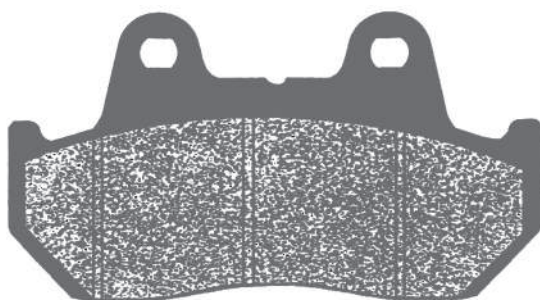

90 x 49 x 10,5

**55817** Honda 250 CN 95/99 (ant.)

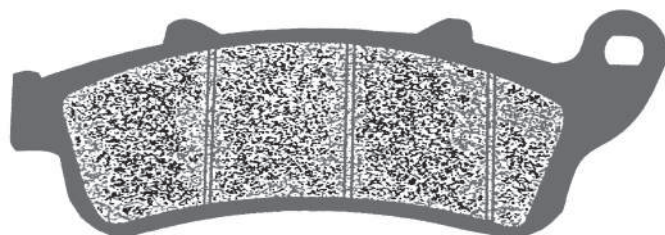

115 x 40 x 9

**55818** Honda 125-150 Phanteon  
250 Foresight 98 (ant.)

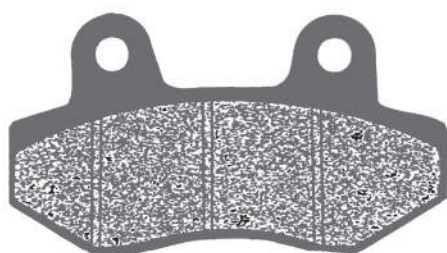
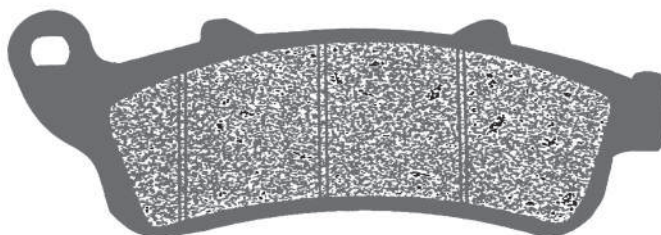

77 x 42 x 8,5

**55819** Kymco - 125-150  
Dink 97/98 (ant. - post.)

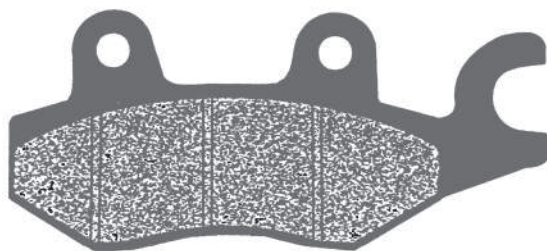

96 x 42 x 8,5



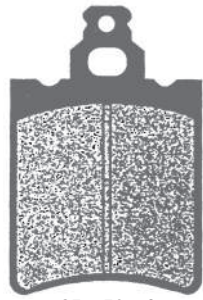

35 x 51 x 6

**55821** Aprilia - Cagiva - Gilera -  
Kymco - Laverda - Puch

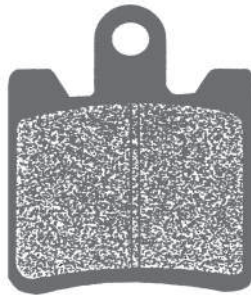

44,5 x 53 x 8,5

**55822** Suzuki - 250 Burgman 98/99  
400 Burgman 99  
(ant.)

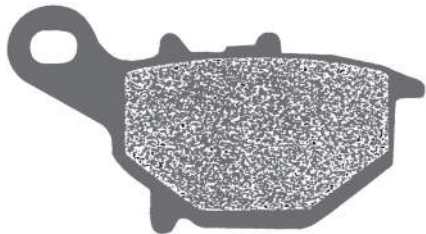

75,5 x 36 x 8

**55823** Suzuki - 125-150 Epicuro 99  
(ant.)



99 x 40 x 7,5

**55824** Suzuki - 250 Burgman 98/99  
400 Burgman 99 (post.)  
Honda - Sky 125 (ant.)

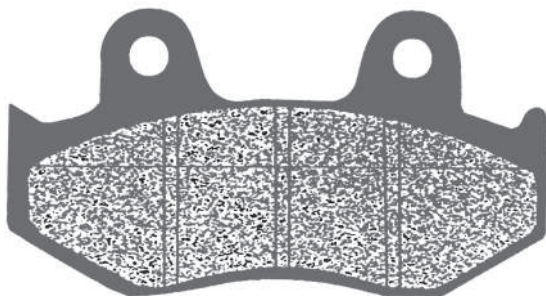

81 x 43 x 8,5

**55825** MBK - 125 Flame R 97/98  
150 Vertex 97  
Yamaha - 150 Flyone R 97/98  
150 Flyone 90/95  
125 Cygnus 97/98  
(Ant.)

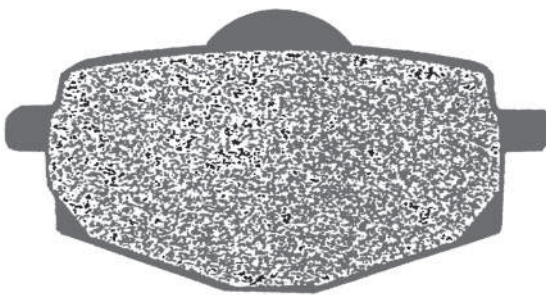

71,5 x 36 x 9

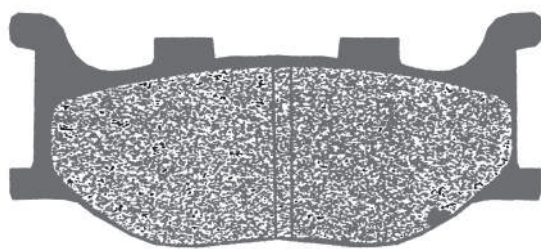

94 x 40 x 10

**55826** Yamaha - 250 Majesty 96/98  
DX 98  
(ant.)  
T-Max 2004/2007  
(ant.)

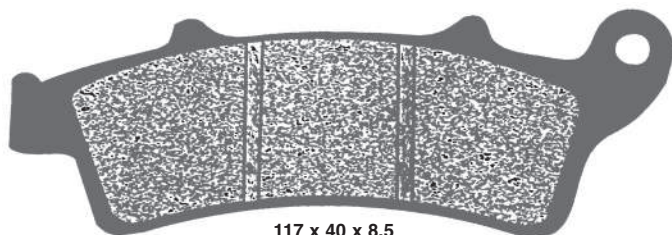

117 x 40 x 8,5

**55827** Malaguti - 250 Madison  
(ant.)

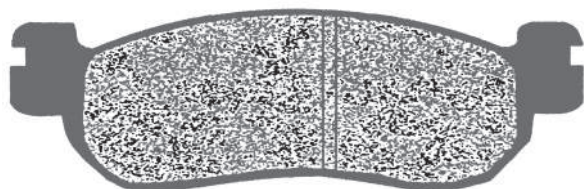
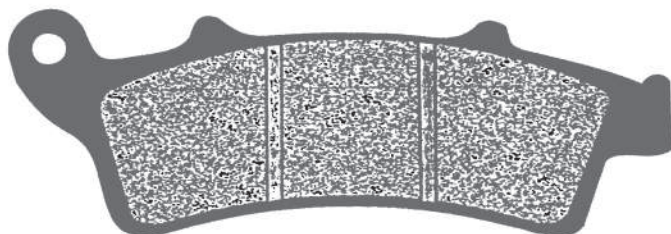

100 x 31 x 9

**55828** Yamaha - 250 Majesty DX 98  
250 Majesty 99  
(post.)

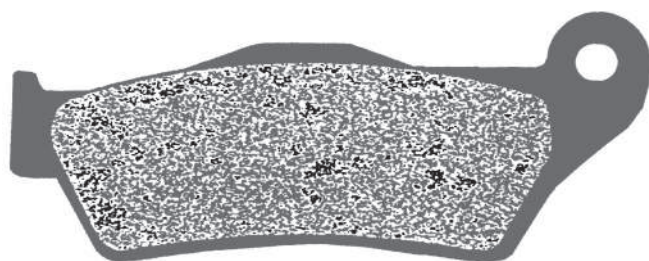

94 x 37 x 7,5

**55829** MBK - 125 Skyliner 98  
Yamaha - 125 Majesty 98  
(ant.)

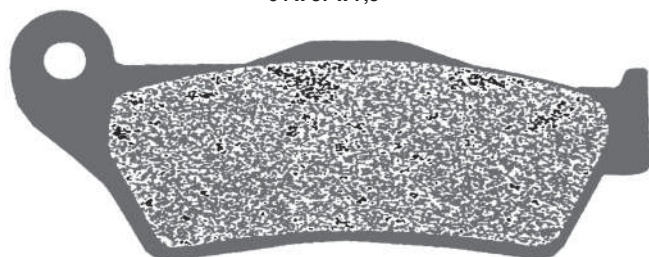

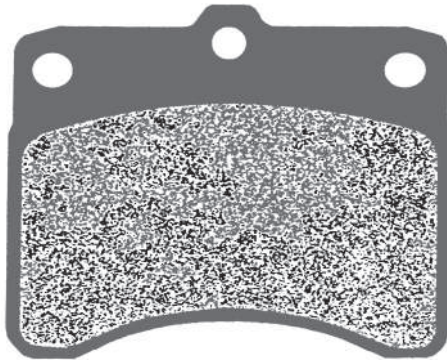

78,5 x 63,5 x 13,3

**55830** Piaggio - Porter 93 (4 pezzi)

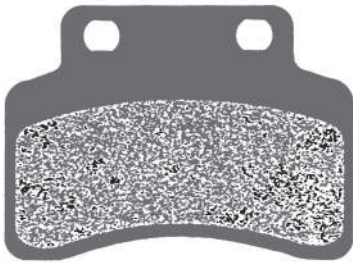

60 x 44 x 9

**55831** Kymco - 50-125-150 Heroism 95/97  
Peugeot - 80 SV Executive  
(ant.)

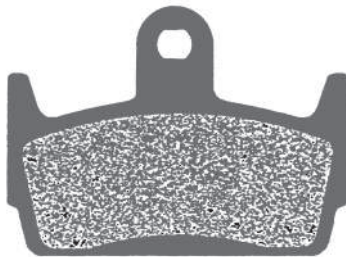

59 x 44,5 x 9,5

**55832** Kymco - 50 Sniper D.D. 94  
150 Heroism 95/97  
(post.)



35,7 x 49 x 7

**55833** MBK - 50 Nitro 97  
Piaggio - 50 Zip RST 96  
(ant.)



51 x 53 x 9,5

**55834** Aprilia - 125-150 Scarabeo -  
250 Leonardo  
Malaguti - Madison 125-150  
(post.)



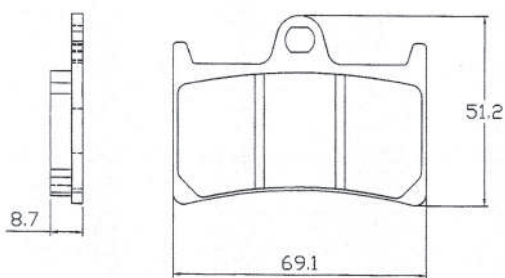

- 58492** Coppia pastiglie Suzuki GSXR 400 -  
Yamaha FZR 250 - XP - T MAX 500 (08-09) ABS  
FZG 600 - YZF 600 - TDM 900  
FZ1 Fazer - FZ1 1000 - FZS

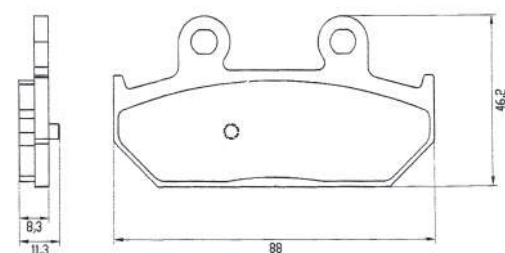

- 58493** Coppia pastiglie Malaguti Madison 3 125-250  
Suzuki AN 400 Burgman (pinza DX)  
AN 600 Burgman

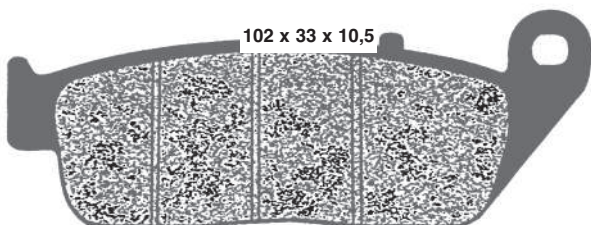
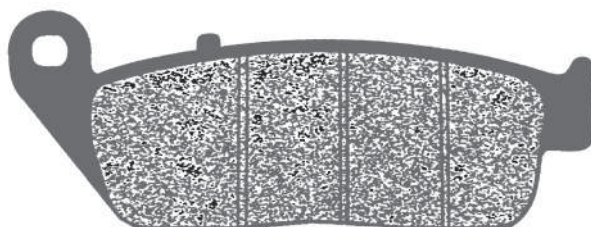

- 55835** Honda - 250 CN 87/94 (ant.)  
Kymco- People 250 (post.)

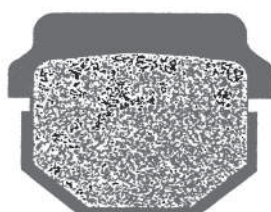

47,5 x 37 x 9,5



85 x 43 x 7,5

- 55836** Peugeot - 50 Buxy RS 94  
50 Squab 96  
50 Speedfight 97  
50 Speedfight  
100 Speedfight  
50 Road 97  
50 Trekker 97  
50 Trekker road 97  
PGO - 50 Comet 91/92  
50 Galaxy 92  
50 PS 93  
50 Road 95  
Suzuki - 50 Adress 50 92  
50 Sepia 92/95  
50 Tune 93  
50 ZZ Scooter 92  
70 Lido Scooter 89  
Honda - Italjet - Kawasaki -  
Suzuki - Yamaha (ant.)

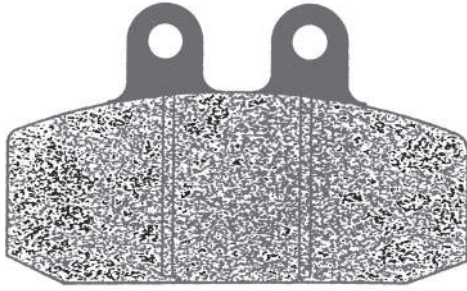

78,5 x 47 x 7,5

**55837** Aprilia - 125 - 150 Scarabeo  
250 Leonardo

Benelli - Beta - Gilera -  
Montesa - Motron (ant.)



56 x 46,6 x 6

**55838** Cagiva - 50 Super City 91  
Italjet - 50 Formula 94 (ant.)



41 x 43 x 7,9

**55839** Cagiva - 50 City 92  
Honda - 50 GP Dio 91  
50 Life Dio 94  
50 SR Dio ZX 94  
50 ZX Dio 95  
HSC 01 - 50 ZR 92

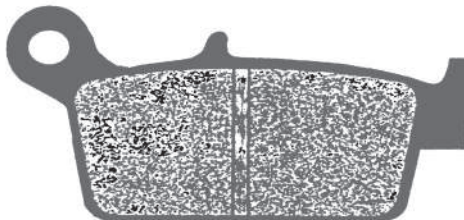

75 x 36 x 7,5

**55840** Kymco - 50 Sniper 94

Peugeot - 50 Zenith 95  
50 SV Geo 92  
80-125 SV Geo 91/92  
(ant.)

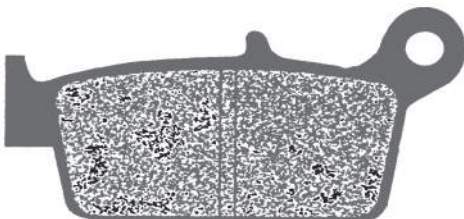



56 x 46,6 x 6

- 55779** Beta - 50 Elkon 98 (ant. - post.)  
 Cagiva - 50 Progress 97 (ant.)  
 Italjet - 50 Dragster 98/99 (ant. - post.)  
 50 Formula 94/99 (ant. - post.)  
 125 Formula 97/98 (ant. - post.)  
 50 - 125 Torpedo 97/99 (ant.)  
 Peugeot - 50 - 100 Speedfight aria 98 (post.)  
 50 Speedfight acqua 98 (ant. - post.)  
 50 Squab 96 (ant.)  
 50 Speedfight aria 97 (ant.)  
 50 Trekker - Trekker road 97 (ant.)  
 50 Road 97 (ant.)  
 50 Zenich 96 (ant.)  
 50 - 100 Eliseo 98 (ant.)  
 Derbi - Senda

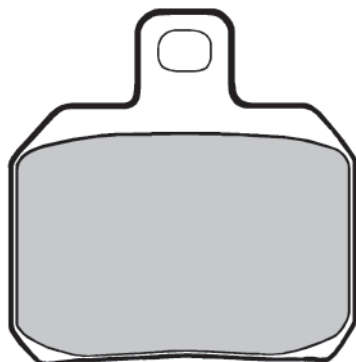

51,2 x 55 x 7,9

- 1497083** Piaggio X9 180 Amalfi  
 X9 250  
 X9 500  
 Beverly 500  
 (ant. - post.)  
 Majestic 125 dal 2001  
 Skyliner 125 dal 2001

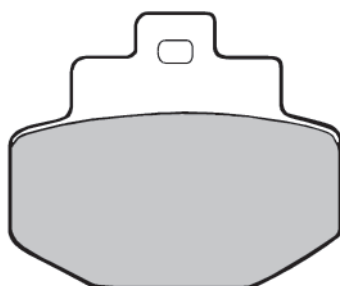

51,5 x 49 x 7,5

- 1497002** Piaggio Super Hexagon GTX 125  
 Super Hexagon GTX 180  
 Super Hexagon GTX 250  
 (post.)

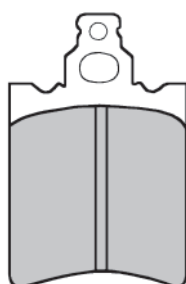

31,5 x 55 x 5,5

- 1494762** Piaggio PX 125 - 150 - 200 dal 2000

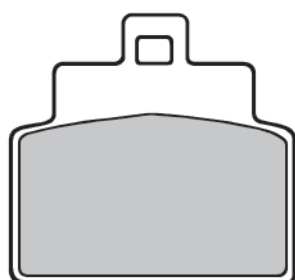

54 x 50,7 x 8

- 55958** Aprilia Scarabeo 100 dal 2000  
 Habana 125  
 Leonardo 125-150 dal '99  
 SR 125-150

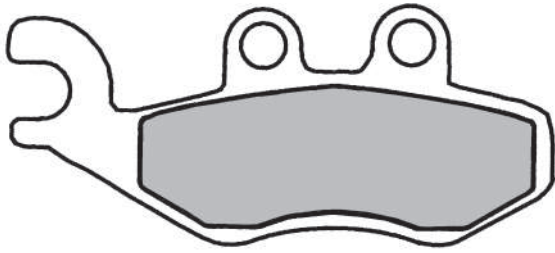

92 x 41 x 9

**1497116** Piaggio (impianto Heng-Tong)  
Beverly 125-200  
Super Hexagon GTX 125-180  
Runner 125-200  
(Post.)

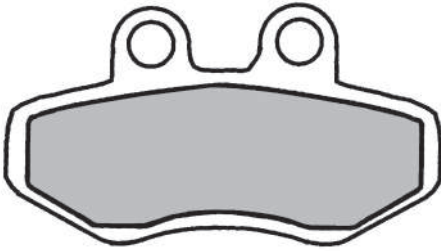

72 x 41 x 9

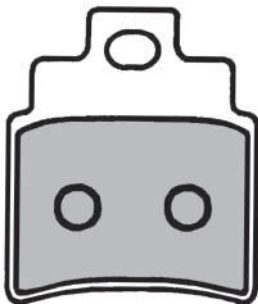

44,8 x 50,8 x 6,9

**58029** Kymco - Grand Dink 250  
(Ant.)

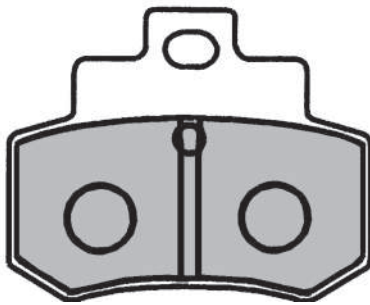

55,3 x 46 x 7,2

**58030** Kymco - Grand Dink 250  
(Post.)

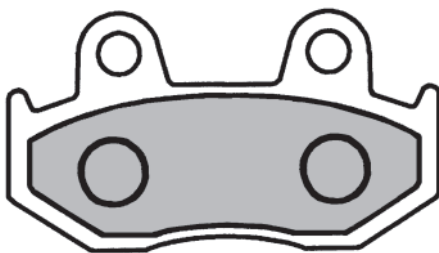

81,7 x 42,7 x 7,3

**58031** Honda - SH 125-150  
@ 125-150  
(Ant.)



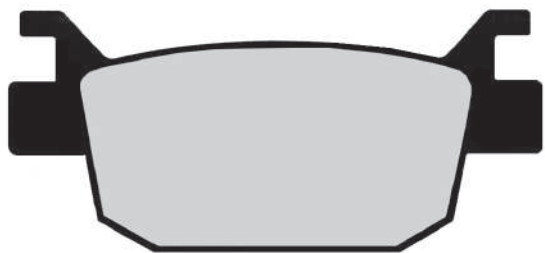

81,7 x 37,9 x 9,5

**58346** Honda - Forza 250 (post.)  
Jazz 250 (post.)  
SH 300 (post.)

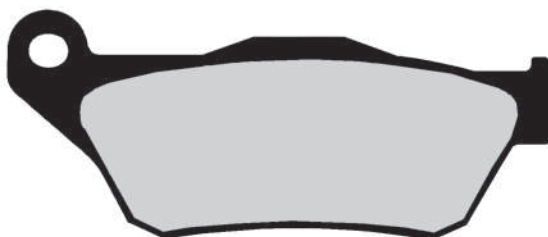

94,0 x 39,9 x 7,3

**58347** Yamaha - X-Max 125-250 (ant.)

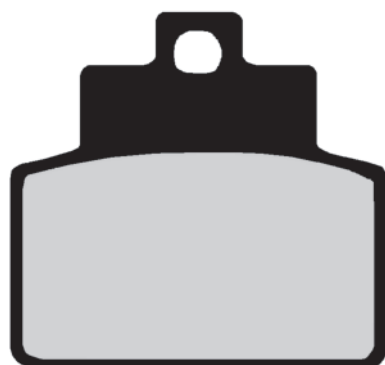
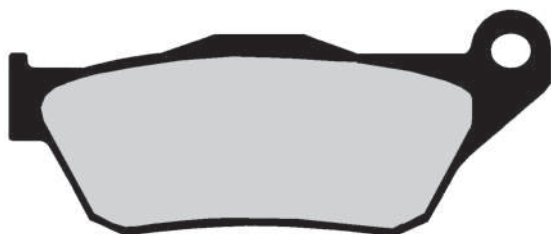

55,3 x 52,1 x 7,6

**58348** Piaggio - X8-X9 125-150 (post.)  
MP3 125-250 (post.)  
Beverly 500 (post.)



100 x 39,0 x 12,0

**58349** Yamaha - Maxam 250 (post.)  
Majesty 400 (post.)  
T-Max 500 (post.)  
MBK - Skyliner 400 (post.)

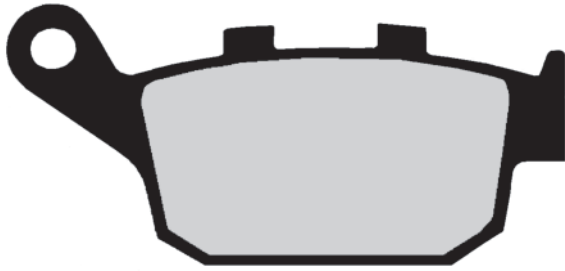

86,0 x 36,7 x 10,2

**58350** **Honda** - Pantheon 4T 125-150 (post.)  
Forza 250 (post.)  
Jazz 250 (post.)  
Reflex 250 (post.)  
**Peugeot** - SV 250 (post.)

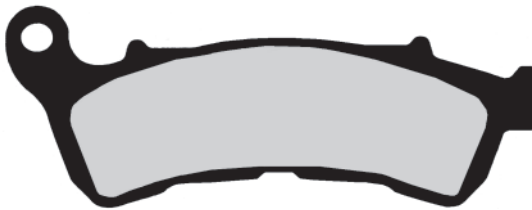

117,9 x 45,4 x 9,5

**58334** **Honda** - SH 300 (ant.)

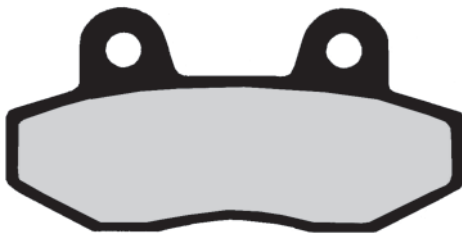
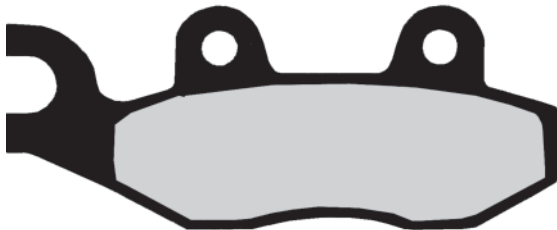

97,0 x 42,0 x 7,4

**58351** **Kymco** - Agility 50-125 (ant.)  
Filly 50 (ant.)  
Vitality 50 (ant.)  
Yup 50 (ant.)  
Cobra Racer 100 (ant.)  
Stryker 125-150 (ant.)  
Vivio 125-150 (ant.)  
People 250 (ant.)



102,2 x 40,0 x 10,0

**58352** **Yamaha** - T-Max 500 (ant.)

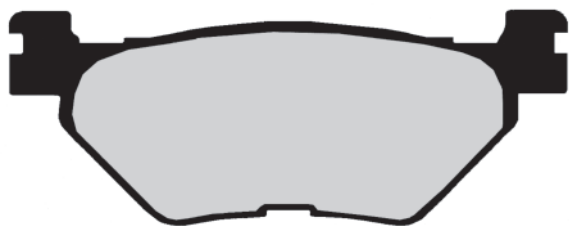

100,0 x 38,4 x 12,0

**58353** **Yamaha** - Majesty 400 (post.)  
T-Max 500 (post.)

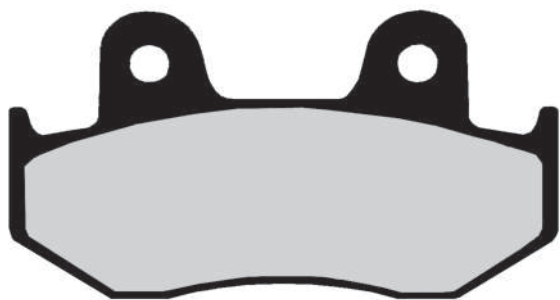

81,6 x 42,6 x 8,2

**58354** **Suzuki** - Burgman 250-400 (post.)

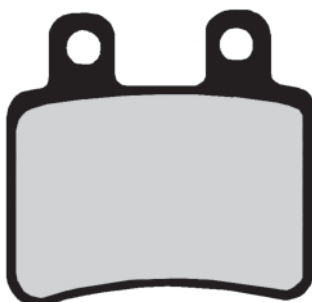

50,0 x 47,5 x 7,0

**58355** **Peugeot** - Elyseo 125-150 (post.)  
Elystar 50-125-150 (post.)



64,0 x 37,6 x 10,9

**58356** **Kymco** - People 125-150 (ant.)  
Super 9 125-250 (post.)



85,0 x 43,0 x 8,5

## FILTRI ARIA SCOOTERS OLIATI

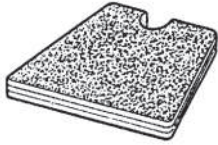

- 1257369** Sfera
- 1431780** Quartz
- 1433437** Gilera Typhoon
- 1431587** Free
- 1431838** Zip - Zip Fast Rider

- 55424** Malaguti F10 - Centro - Ovetto
- 55425** MBK Booster
- 55426** Honda NH 50 - Lead - SH50 - Peugeot Metropolis SC
- 55427** Aprilia Amico - 50 LK/LX/Sport - SR50 - Urban - Viper - Replica
- 55432** Honda Vision - Squab
- 55442** Peugeot Zenith

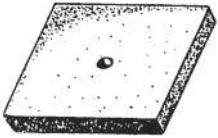

- 1431975** Skipper
- 1434363/364** Hexagon (2 pz.)

- 55546** Cagiva City
- 55547** Aprilia Scarabeo
- 55548** Aprilia Leonardo 125
- 55549** Honda Wallaroo
- 55550** Honda Bali
- 55551** Honda GP 50 DIO
- 55552** Honda SC 01
- 55553** Italjet Cruise Pista II S

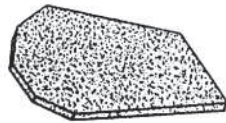

- 55554** Malaguti Fifty
- 55555** Malaguti Crosser
- 55556** Kymko Sniper
- 55557** Kymko DJY 50 (2 pz.)

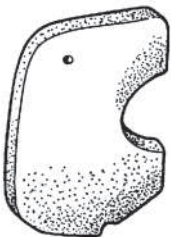

- 55558** Peugeot Rapido
- 55559** Peugeot GEO/SV
- 55560** Peugeot Fox
- 55561** Suzuki CP 50 Lido
- 55562** Yamaha CT 50/Reporter
- 55563** Yamaha CR 50 / Target
- 55564** Malaguti F15 - Fire Fox
- 1436478** Vespa ET2 - ET4
- 1482738** Piaggio Liberty

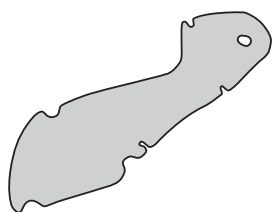

**1478240** Quartz - Skipper 125 - Typhoon 125 - XR

**1478536** Zip Fast Rider - RST - Freno disco SP

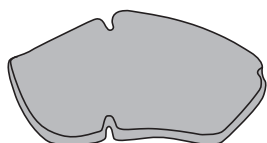

**1479748** Runner - RST - Stalker - NRG MC3 - NRG RST MC2 - NRG Extreme

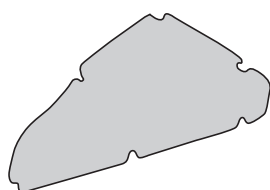

**1480084** Runner FX - Skipper LX 125-150 ('98-'99)

**1487287** Liberty 50 4T - 125 4T - 150 4T



**1487401** Skipper 125-150 4T - Vespa ET4 50-125-150 (1999-2000)

**1495375** Hexagon GT - Super GTX 250 cc

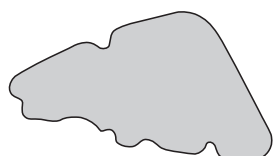

**1826438** Hexagon 125-180

**1827694** Zip 125 4T

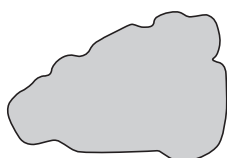

**1827936** Runner 180

**1829258** Beverly 125-200

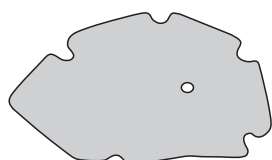

**1178018** Ape Porter 1000  
(adatt. P. 1780187Z01000)



**55997** Valvola lamellare - Motori Minarelli - Yamaha - orizzontali



**55996** Collettore aspirazione - Motori Minarelli - Yamaha - orizzontali

**55997 C** Raccordo completo - ammissione lamellare - Motori Minarelli - Yamaha - orizzontali



**55604 R** Raccordo in gomma per gruppi lamellari  
**Motori Piaggio**



**55653 R** Raccordo in gomma per gruppi lamellari  
**Motori Minarelli verticali**



**1480799** Raccordo ammissione - Vespa ET4 - Sfera 125 - Liberty 125 4T



**58130** Raccordo ammissione  
Skyliner 125 - Majesty 125



**58130-1** Raccordo ammissione Yamaha -  
2 connessioni (n.o. 5XME - 3585-0000)



**58313** Raccordo ammissione  
Majestic 125 - Skyliner 125  
**iniezione**



- 55604** Raccordo completo  
**ammissione lamellare** -  
Motori Piaggio



- 55653** Raccordo completo -  
**ammissione lamellare** -  
Motori Minarelli



- 79742** Interruttore STOP - veicoli c/batteria  
Vespa 125 VNB1T - Vespa 150 VBA1T  
VBB1T - GS VS3/4/5T - VLA GL-160GS  
180SS (P.93722)



- 74834** P. 55316 - 93772 - 181637 - 203204  
Interruttore stop Vespa 125/150 -  
Super - 125 GTS - 150 Sprint -  
Rally 180 - Rally 200



- 71495** P. 70138 - 181878 - Interruttore stop  
(pulsante nero)  
Vespa 125 ET3 - Primavera -  
PX125-150-200E -  
Arcobaleno - PK 125



- 1181881** P. 73661 - 181881 - Interruttore stop  
(pulsante bianco)  
Vespa P125X - 150X - 200E -  
Arcobaleno - T5 - PK50 - PK125 -  
XL - HP - Rush



- 58125** Interruttore stop - Piaggio - Gilera  
Attacco a filetto  
MBK 50-125-150  
Yamaha 50-100-125-150  
(R.O. 5839801000)



- 58126** Interruttore stop - attacco ad incastro



- 1583575** Interruttore STOP **Piaggio** Vespa - Liberty -  
Beverly X8 - X9 - MP3 50 - 125-200-300-400-500  
(P.0278010)  
GILERA Runner - Stalker 50-125-180-200  
APRILIA Atlantic - Sport City  
DERBI



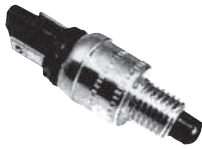

**1126899** Interruttore STOP universale Scooters  
Piaggio Vespa 50 (F.L.2) Automatica - PK 50  
(F.L.2) Free 50 - Quartz 50 - Skipper 125-150 -  
Zip 50 Zip 50/Fast rider - NRG 50 - NTT 50 -  
Gilera Typhoon 50 Storm 50 - Easy 50/Moving  
(per tutti i tipi dalla nascita fino al 95')



**1580953** Interruttore STOP universale Scooters  
Aprilia - Piaggio - Derbi - Gilera



**1293301** Interruttore termico Piaggio Hexagon  
GTX 125-150 - LX LXT 125-180  
GT - Super Hexagon 125-180  
(temperatura di set 85°)

**1294152** Interruttore termico Piaggio Hexagon  
GTX 125-150 - LX LXT 125-180  
GT - Super Hexagon 125-180  
(temperatura di set 95°)



**1082622** Comando a termistore  
X8 125-150 - Vespa Granturismo 125-150-200  
X9 Evolution- Beverly RST 125-200  
Super Hexagon - Zip SP -NRG RST MC2 Extreme



**1293571** Interruttore luci - Sfera 50 RST dal 1995  
Sfera 125 RST - Vespa ET2 - ET4 -  
Liberty 50



**1293572** Commutatore luci - Sfera 50 RST dal 1995 -  
Sfera 125 RST - Vespa ET2 - ET4 -  
Liberty 50



**1294723** Deviatore frecce Sfera 50 RST dal 1995 -  
Sfera 125 RST - Vespa ET2 - ET4 -  
Liberty 50



**1293550** Pulsante claxon - Sfera 50 RST dal 1995 -  
Sfera 125 RST - Vespa ET2 - ET4 -  
Liberty 50 - Gilera Stalker - Gilera Runner



- 1293549** Pulsante avviamento - Sfera 50 RST dal 1995  
Sfera 125 RST - Vespa ET2 - ET4 -  
Liberty 50 - Gilera Stalker - Gilera Runner



- 1292364** Interruttore clacson  
Sfera - Zip - Zip RST - FR - Free - NTT -  
NRG - Typhoon 50 - Hexagon 125-150 -  
Skipper 125-150 - Ape MX - Ape RST



- 1294398** Interruttore avviamento  
Sfera - Zip - Zip RST - FR - Free - NTT -  
NRG - Typhoon 50 - Hexagon 125-150 -  
Skipper 125-150 - Ape MX - Ape RST



- 71628** Cuffia raffreddamento cilindro - Vespa 50  
**71630** Cuffia raffreddamento cilindro  
Vespa 125 Primavera - ET3  
**1174168** Cuffia raffreddamento cilindro -  
P125X - P150X  
**79836** Cuffia raffreddamento cilindro - P200E



- 55309** Kit molla fissaggio deflettore al cilindro



**86370** Cerchione ruota 3.00 - 3.5 x 10"  
Vespa 50 - Special - 90SS - 125 -  
Primavera - PX 125-150-200E -  
GTR - SPRINT - Rally 180-200



**86370 CR** Cerchione ruota 3.00 - 3.5 x 10"  
**cromato**



**58443** Vespa 50 R (71/76) - Vespa 50 Special 3 marce  
(r.o. 135172)  
Per tamburo a 4 attacchi -  
diametro esterno mm 248 -  
Verniciato grigio metallizzato



**58444** Vespa V5A1T (63/65) -  
Vespa 50 N (63/69)  
con sportello piccolo lato motore (r.o. 98012)  
Diametro esterno mm 248 -  
Verniciato grigio metallizzato



**58445** Vespa 50 S - Vespa 90  
(r.o. 098011)  
Diametro esterno mm 278 -  
Verniciato grigio metallizzato



**58446** Vespa 125 (51/65) - Vespa 150 (55/66)  
(r.o. 014894)  
Diametro esterno mm 235 -  
Verniciato grigio metallizzato



**58447** Vespa GS 160 - 180 SS  
 Diametro esterno mm 278 -  
 Verniciato grigio metallizzato  
 (5 fori d'attacco)



**79548** Tappo tamburo  
 Vespa 50R



**91106** Tappo ruota metallo cromato  
 tipo piccolo  
 (P.126410) Ape 50 tutti i tipi



**1182546** Tappo ruota metallo cromato tipo grosso  
 (adatt. P.182546-092517)  
 Vespa 50-125 - PX 125-150-200 -  
 Arcobaleno - Sfera 50-125 RST - Liberty -  
 T5 - ET2 iniezione - Vespa LX - Hexagon -  
 Zip - Zip F.R. - Zip SP



**62110** Tappo tamburo anteriore  
 Vespa Super 125 - 150



**1179116** Motorino avviamento completo Piaggio  
Vespa 50 PK XL - Rush - N - FL -  
Ape 50 - TMX - FL - FL2 - RST - FL3 -  
FL2 HP -



**1286172** Motorino avviamento  
completo scooters -  
Motori Piaggio



**1249235** Motorino avviamento  
Vespa PX 125-150-P200E - Freno  
Arcobaleno PX Euro 2 - Trenta anni  
Cosa 125-150 disco -  
**Avviamento elettrico** -



**55655** Motorino avviamento  
completo scooters -  
Motori Minarelli -  
**perno lungo  
mm 16,7**  
Orizzontale



**58328** Motorino avviamento  
Motori Minarelli - Yamaha  
125 - 150 - 180



**58343** Motorino avviamento  
Kymco 125-150 cc - People - Dink  
Heorism - Movie - Vivio -



**58559** Motorino avviamento **Honda** SH 125-150



**58560** Motorino avviamento **Honda** SH 300

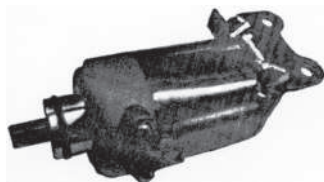

**58344 B** Motorino avviamento

**Aprilia** - Leonardo 125-150  
Scarabeo 125-150  
(Motore Rotax)  
(A.P. 0295625)



**1086811** Motorino avviamento (P82611 R)  
**Piaggio** Vespa GTS 125 - 150  
LX 125 - 150 - Fly 150 - GTV -  
Beverly 125 - 180 X9 - 200 Carnaby  
Liberty 200 - X9 Evolution



**1058142** Motorino avviamento  
Atlantic - Sport City 125-200-250 - Nexus 125-  
250-300 - Quad - Beverly 250-300 - Carnaby  
250-300 - MP3 250 - X7 - X8 - X9 125-250 -  
Evo 250 - Scarabeo 125-150-200-250 - Vespa  
GT250 - GTS 125-150-300 - GTV 250-300

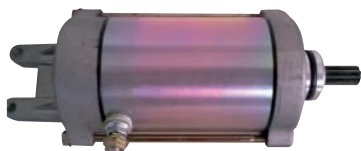

**1082699** Motorino avviamento  
Atlantic 500 - Fuoco 500 - Nexus 500 - Beverly  
400-500 - MP3 400-500 - Tourer 500 - X8 400 -  
X9 500 - Scarabeo 400-500



**1289094** Motorino avviamento Skipper 125 -  
Hexagon 125



**1096921** Motorino avviamento  
**Piaggio** 50 cc - 4T - Zip - Liberty - ET4 -  
LX 4T  
Motorino cavalletto centrale  
**Piaggio** X9 500 01-02 - X9 Evolution 03-04



**55790** Kit revisione motorino avviamento -  
**Piaggio** Ape 50 - PK 50 - XL - Rush -  
Cosa - Ape 50  
avviamento elettrico  
(P. 248293)



**100301** P. 103936 Attacco candela  
Ciao - Bravo - Free - Liberty - NRG -  
Quartz - Sfera - Typhoon - Zip -  
Hexagon 125-180 (cavo ø 7)



**1244395** Cappuccio candela in gomma  
Vespa 50 - 125 - ET3 - PK - PK XL  
PX 125 - 150 - 200 E -  
Ape 50 - TM 50 - FL - FL 2



**Z17** Attacco candela schermato - Scooters -  
Motori Piaggio - Motori Minarelli

**Z18** Attacco candela schermato - Scooters -  
Motori Franco Morini

**Z19** Attacco candela schermato -  
Piaggio - Minarelli **L.C.**



**KIT REVISIONI ALBERO MOTORE**  
(Cuscinetti NTN - SKF - NADELLA con paraoli)

**CUSCINETTI E PARAOLI**



<b>55701</b>	<b>Piaggio</b> - Sfera - Quartz - Zip - Zip FR - Free - Liberty - Vespa ET2 - Gilera - Typhoon - Stalker - Storm	2 - <b>1431125</b>	<b>NTN</b>	20 x 52 x 12
		1 - <b>1482315</b>	p/olio	18 x 28 x 7/7,5
		1 - <b>1482314</b>	p/olio	19 x 30 x 7
<b>55702</b>	<b>Minarelli - Yamaha</b> Motori Orizzontali / Verticali	2 - <b>5006</b>	<b>NTN</b>	20 x 47 x 14 C3
		1 - <b>55699</b>	p/olio	20 x 30/34 x 61
		1 - <b>55700</b>	p/olio	20 x 42/43 x 8/9
<b>55703</b>	<b>Piaggio</b> Vespa 50 - 125 Prim. ET3 PK 50 - PK 50S - PK 125 - PK 50 XL - W - V	1 - <b>5072</b>	<b>NTN</b>	17 x 47 x 14
		1 - <b>5006 EC</b>	<b>NTN</b>	20 x 47 x 14 C3
		1 - <b>71075</b>	p/olio	22,7 x 47 x 7/7,5
		1 - <b>2180</b>	p/olio	19 x 32 x 7
		1 - <b>S.17016</b>	p/olio	20 x 32 x 7
<b>55704</b>	<b>Piaggio</b> Vespa PX - PXE	1 - <b>86466</b>	<b>Nadella</b>	25 x 62 x 12
		1 - <b>80128</b>	<b>Nadella</b>	Lato volano a rulli 25 x 38 x 15
		1 - <b>80120</b>	p/olio	24 x 35 x 6
		1 - <b>80121</b>	p/olio	31 x 62,5 x 4,3
<b>55705</b>	<b>Piaggio</b> Ciao - Boxer - Bravo-SI	1 - <b>5001</b>	<b>NTN</b>	15 x 35 x 11
		1 - <b>35015</b>		Chiavella volano
		1 - <b>2092</b>	p/olio	15 x 24 x 5
		1 - <b>6465</b>		S. guarnizioni
<b>55706</b>	<b>Piaggio</b> Hexagon - Typhoon 125 - (2 tempi) Skipper 125	2 - <b>1483970</b>	<b>NTN</b>	25 x 68 x 12
		2 - <b>80120</b>	p/olio	24 x 35 x 6
<b>55707</b>	<b>Piaggio</b> Sfera 125 4T - Vespa ET4	2 - <b>1483970</b>	<b>NTN</b>	25 x 68 x 12
		1 - <b>2234</b>	p/olio	22 x 32 x 7
		2 - <b>1482315</b>	p/olio	18 x 28 x 7/7,5
<b>55756</b>	<b>Morini</b> Motori Franco Morini - Italjet Formula - Velocifero - Suzuki - Adress - Malaguti Crosser (3 paraoli)	1 - <b>5006 EC</b>	<b>NTN</b>	25 x 68 x 12
		1 - <b>55745</b>		
		1 - <b>55748</b>	p/olio	17 x 27 x 6
		1 - <b>55749</b>	p/olio	24 x 43 x 6
		1 - <b>55750</b>	p/olio	25 x 37 x 6

**KIT REVISIONI ALBERO MOTORE**  
(Cuscinetti NTN - SKF - NADELLA con paraoli)

**CUSCINETTI E PARAOLI**

<b>55757</b>	<b>Honda</b> SH50 dal 96 - SKY	1 - <b>55728</b>	<b>NTN</b>	25 x 56 x 12
		1 - <b>55751</b>	p/olio	15 x 30 x 7
		1 - <b>55753</b>	p/olio	20 x 31 x 7

<b>55758</b>	<b>Honda</b> SH 50 1ª Serie	1 - <b>55746</b>		20 x 42 x 12
		1 - <b>55747</b>		25 x 47 x 12
		1 - <b>55752</b>	p/olio	20 x 30 x 7
		1 - <b>55753</b>	p/olio	20 x 31 x 7

<b>55760</b>	<b>Honda</b> Bali - SFX	2 - <b>55708</b>	<b>NTN</b>	20 x 56 x 12
		1 - <b>55753</b>	p/olio	20 x 31 x 7
		1 - <b>55754</b>	p/olio	15 x 25,4 x 7

<b>55759</b>	<b>Peugeot</b> Buxy - Speedake - Zenith	2 - <b>1431125</b>	<b>NTN</b>	20 x 52 x 12
		1 - <b>55752</b>	p/olio	20 x 30 x 7
		1 - <b>55755</b>	p/olio	15,6 x 25,5 x 7

<b>58307</b>	<b>Piaggio</b> Kit revisione albero motore Piaggio 50 4T dal 2005	1 - <b>1096925</b>	<b>NTN</b>	17 x 42 x 13
		1 - <b>1082671</b>	<b>NTN</b>	20 x 60 x 13
		1 - <b>1969028</b>	p/olio	17 x 28 x 7

<b>55782</b>	<b>Piaggio</b> Kit revisione albero motore Vespa GL - Super - Sprint - GTR - TS	2 - <b>86466</b>	<b>Nadella</b>	25 x 62 x 12 (8 sfere)
		1 - <b>74272</b>	p/olio	20 x 62 x 6,5
		1 - <b>74273</b>	p/olio	20 x 40 x 7

**KIT REVISIONI ALBERO MOTORE**  
(Cuscinetti NTN - SKF - NADELLA con paraoli)

**CUSCINETTI E PARAOLI**

<b>58027</b>	<b>Piaggio</b> Kit revisione albero motore Ape TM P703 - P602 Ape CAR P2/P3	1 - <b>1134591</b>		28 x 45 x 17 C4
		1 - <b>1169809</b>	<b>NTN</b>	25 x 62 x 17 C3
		1 - <b>1222478</b>	p/olio	34 x 62 x 6
		1 - <b>1169810</b>	p/olio	24,9 x 40 x 6,5
<b>1154681</b>	<b>Piaggio</b> Kit revisione albero motore - Ape MP - 501 - P601	1 - <b>93018</b>		Cuscinetto a Rulli (P.113255)
		1 - <b>89991</b>		25 x 62 x 14 C4
		1 - <b>89975</b>	p/olio	32 x 62 x 6
		1 - <b>86452</b>	p/olio	24,9 x 45 x 6,5
<b>1154679</b>	<b>Piaggio</b> Kit revisione albero motore - Ape MP	1 - <b>93018</b>		Cuscinetto a Rulli (P.113255)
		1 - <b>89991</b>		25 x 62 x 14 C4
		1 - <b>89975</b>	p/olio	32 x 62 x 6
		1 - <b>86452</b>	p/olio	24,9 x 45 x 6,5
1 - <b>86454</b>	p/olio	32 x 52 x 5		
<b>58171</b>	<b>Derbi</b> Senda 50	2 - <b>5006C</b>	<b>NTN</b>	20 x 47 x 14 C3
		2 - <b>58189</b>	p/olio	20 x 35 x 7
<b>58177</b>	<b>Piaggio</b> 50 4T	1 - <b>55728</b>	<b>NTN</b>	25 x 56 x 12
		1 - <b>1096925</b>	<b>NTN</b>	17 x 42 x 13
		1 - <b>1969028</b>	p/olio	17 x 28 x 7
<b>58178</b>	<b>Honda</b> SH - 125-150 @ 125-150	1 - <b>58193</b>		35 x 72 x 15
		1 - <b>58194</b>		35 x 72 x 17
		1 - <b>58195</b>	p/olio	20,8 x 53 x 6/9
<b>58179</b>	<b>Minarelli</b> AM 345 - AM 6	2 - <b>5072</b>	<b>NTN</b>	17 x 47 x 14
		1 - <b>58202</b>	p/olio	24 x 35 x 7
		1 - <b>58203</b>	p/olio	17 x 35 x 8
<b>58180</b>	<b>Minarelli</b> Yamaha 125 - 150 - 180 4T	2 - <b>1169809</b>	<b>NTN</b>	25 x 62 x 17
		1 - <b>58192</b>	p/olio	22 x 32 x 7
<b>58181</b>	<b>Yamaha</b> Majestic 250	1 - <b>58197</b>		70 x 72 x 19
		1 - <b>58198</b>		28 x 68 x 18
		1 - <b>58174</b>	p/olio	30 x 45 x 5
		1 - <b>58196</b>	p/olio	14 x 27 x 6

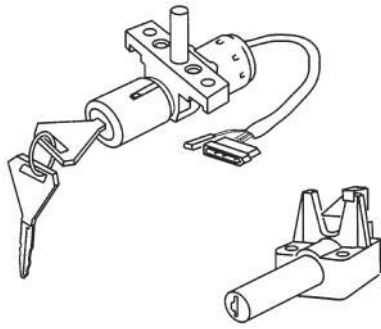

**55504** Blocchetto avviamento - MBK Booster

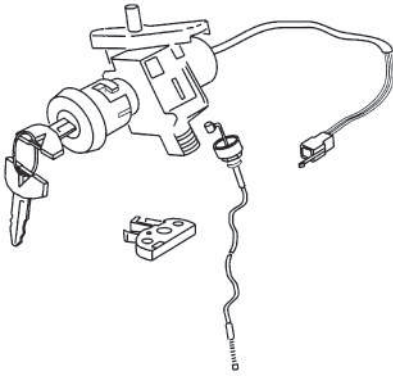

**55730** Blocchetto avviamento - MBK Ovetto -  
Yamaha NEOS

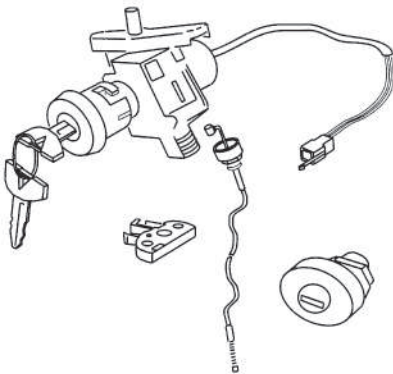

**55761** Blocchetto avviamento - MBK Flipper -  
Yamaha WHY

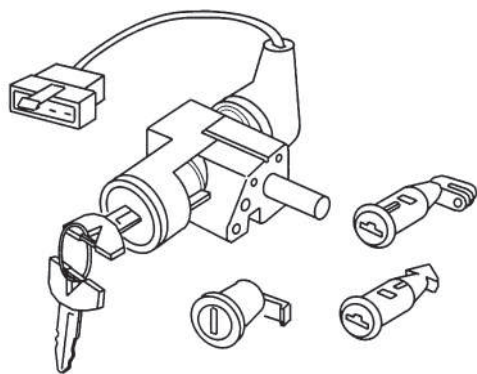

**55762** Blocchetto avviamento - Honda Bali

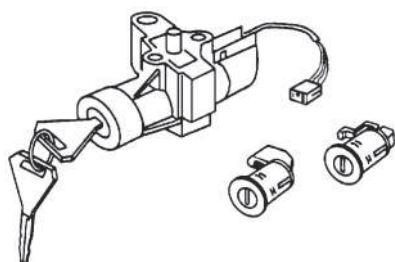

**55629** Blocchetto avviamento - Honda SH 50 dal 96

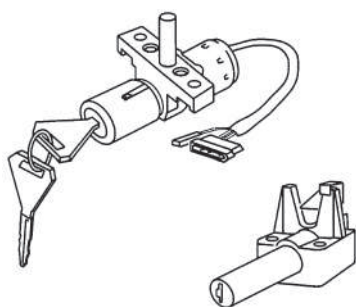

**55723** Blocchetto avviamento - Honda Sky

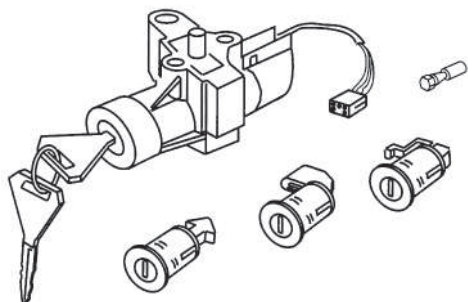

**55575** Blocchetto avviamento - Peugeot SV -  
GEO

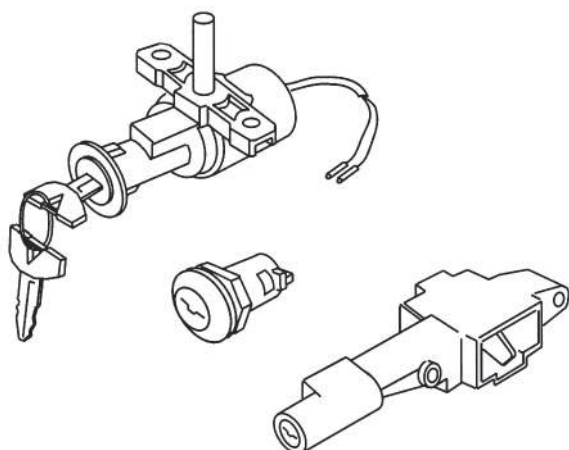

**55768** Blocchetto avviamento -  
Malaguti F10

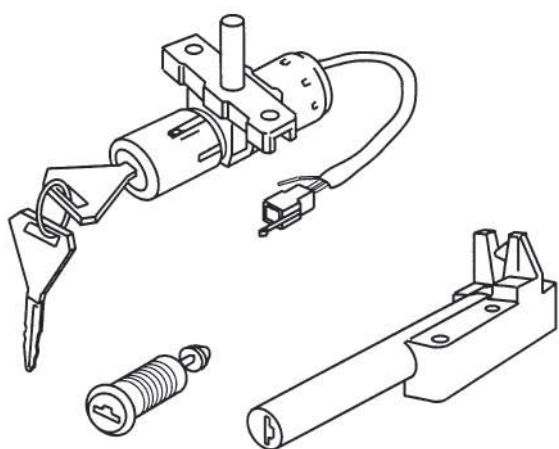

**55529** Blocchetto avviamento -  
Aprilia Amico

**55530** Blocchetto avviamento  
Aprilia Scarabeo

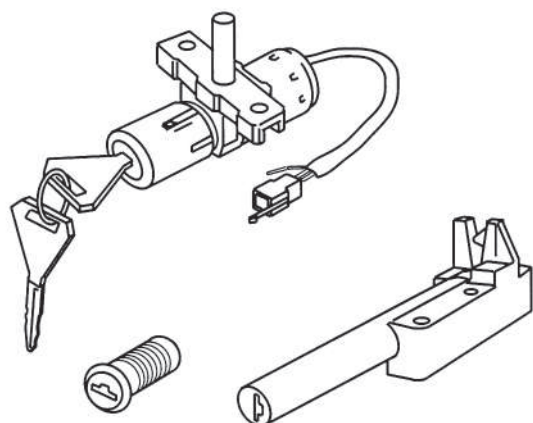

**55531** Blocchetto avviamento -  
Aprilia - Rally - SR

**55964** Blocchetto avviamento -  
Aprilia SR dal 2000 - R.O. 8202218  
Motori DI-TECH



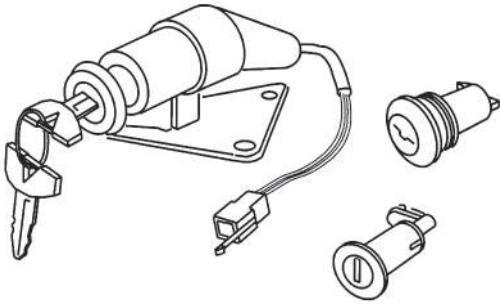

**55765** Blocchetto avviamento - Kimco  
DJX50 (91-93)  
DJY50 (93)  
DJW50 (94-98)

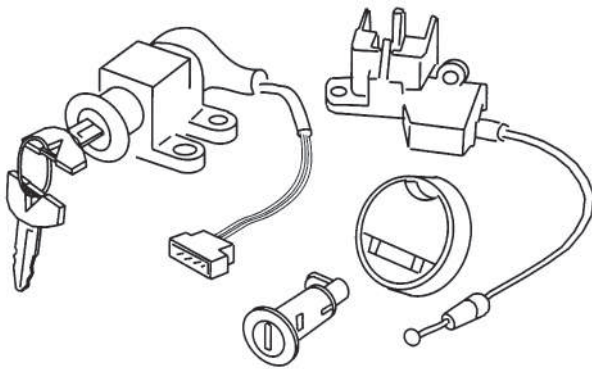

**55766** Blocchetto avviamento -  
Kimco Filly 50

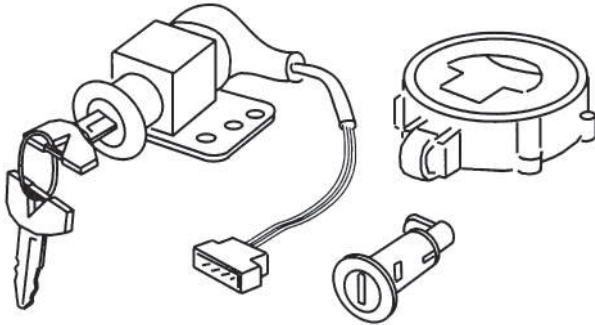

**55767** Blocchetto avviamento - Kimco Dink  
50 - 125 - 150

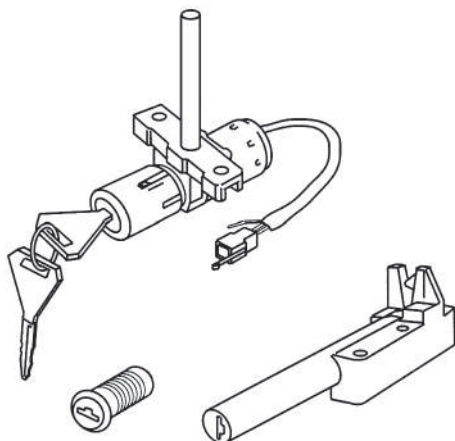

**55783** Blocchetto avviamento -  
Leonardo 125

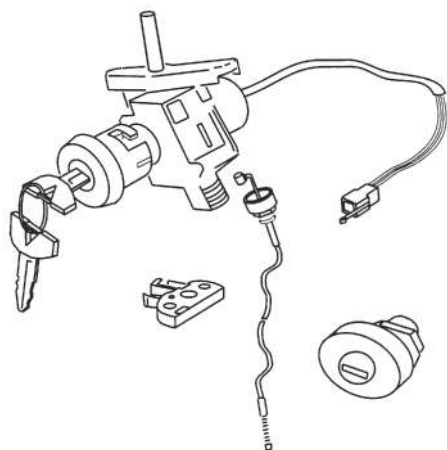

**55784** Blocchetto avviamento - MBK Skyliner 125 -  
Yamaha Majesty 125

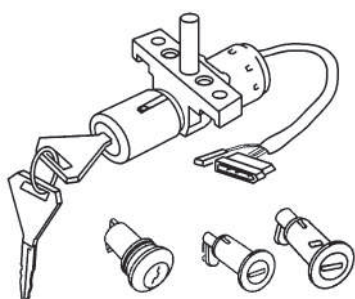

**55785** Blocchetto avviamento -  
Honda Phanteon 125 - 150

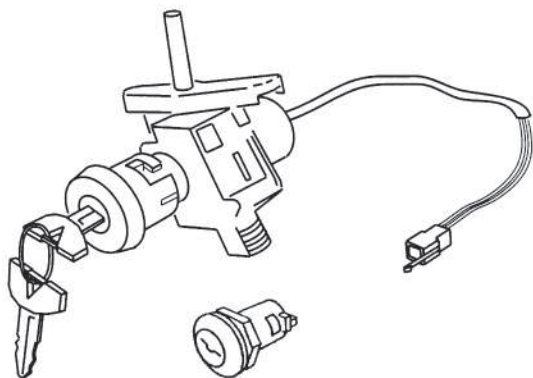

**55841** Blocchetto avviamento - Scarabeo 125 - 150

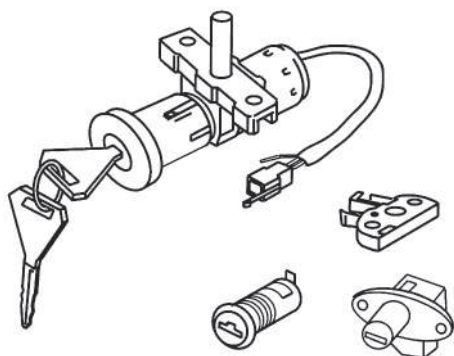

**55770** Blocchetto avviamento - Malaguti F15  
(N.O. 09003500)

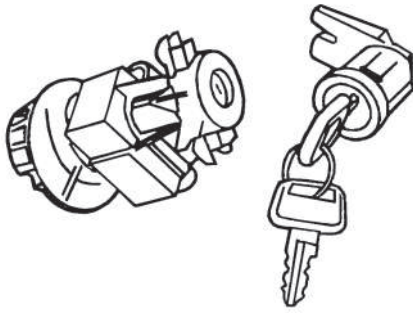

**55973** Blocchetto avviamento -  
Peugeot Speedfight - Squab - Trekker

**55954** Blocchetto avviamento - Honda SH 125 - SH 150

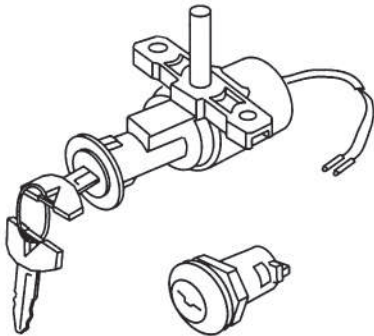
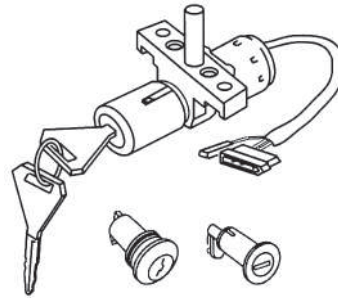

**58010** Blocchetto avviamento - Malaguti "Ciak"

**58024** Blocchetto avviamento - Scarabeo Ditech

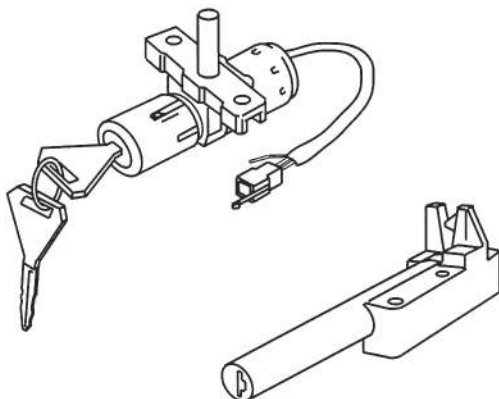
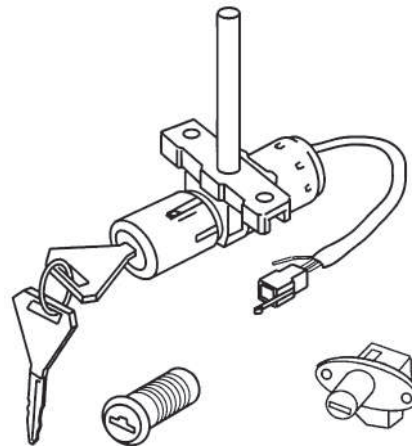

**58064** Blocchetto avviamento -  
Honda X8RS - X8RX

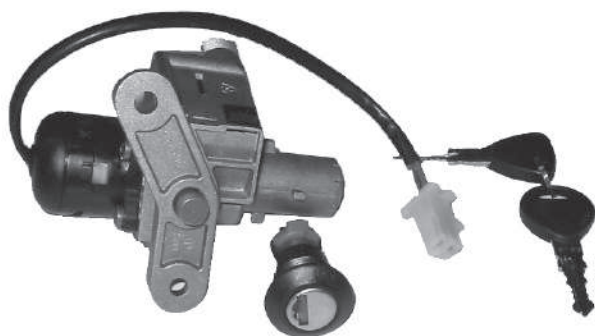

**58262** Blocchetto avviamento  
SH 125-150 dal 2005  
(adatt. 35010 - KTF - 640)



**58293** Blocchetto avviamento Honda  
Dylan 125 - 150

## FRENI DISCO

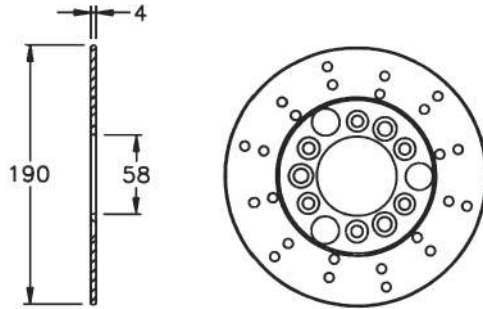

- 55927** **Aprilia** SR 50 - Rally 50 - Gulliver (ant. - post.)  
**Aprilia** Habana - SR 125 (ant.)  
**Aprilia** Area 51 - Leonardo 125 - 150 post.)  
**Atala** Hacker - Skeggia 50 (ant.)  
**Benelli** 491 - K-2 - Naked (ant. - post.)  
**Beta** Chrono - Quadra - Ark - Eikon 50 (ant. - post.)  
**Gilera** Stalker (ant.)  
**Honda** Sky 50 - Bali 50-100 - Shadow 50-90 - Yupy 90 (ant.)  
**Italjet** Dragster 50 (post.)  
**KTM** Chrono - Kross - Ark (ant.)  
**Macal** Thunder (ant.)  
**Malaguti** Phantom F-12-50 - Crosser - F-15 Firefox (ant. - post.)  
**MBK** Ovetto - Nitro - Booster NG (dal '99) - Stunt (ant. - Post.)  
**Peugeot** Buxy - Speedake - Squab - Trekker - Vivacity (ant.)  
**Peugeot** SV 50 - SV 80-100-125 - Elyseo 50 (ant.)  
**Piaggio** Typhoon - Storm - NRG - NTT (ant.)  
**Rieju** First - Crosser (ant.)  
**Yamaha** Neo's - Aerox - Bw's NG (dal '99) - Slider (ant. - post.)

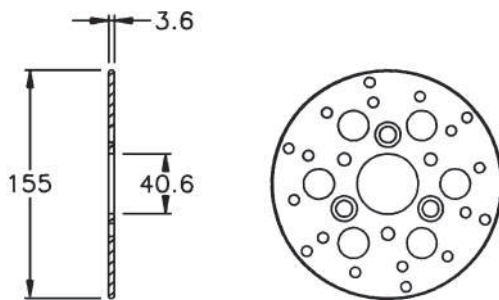

- 55928** **Aprilia** Amico - Sonic (ant.)  
**Derbi** Vamos (ant.)  
**Fantic** Racer - Grinta - Queenie (ant.)  
**Italjet** Pista - Yankee - Scoop (ant.)  
**MBK** Forte - Fizz - Evolis - Booster Spirit (1ª serie) (ant.)  
**Peugeot** SV 50 (2ª serie) - Zenith (2ª serie) (ant.)  
**PGO** Big max - Tornado - Hot - PMX (ant.)  
**Piaggio** Zip - Zip Fast Rider (ant.)  
**Yamaha** Jog - Axis - Zest - Breeze - Bw's Original (1ª serie) (ant.)

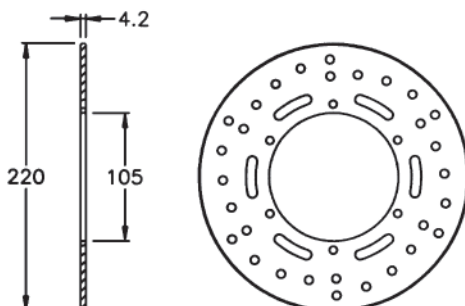

- 55930** **Piaggio** Liberty (ant.)

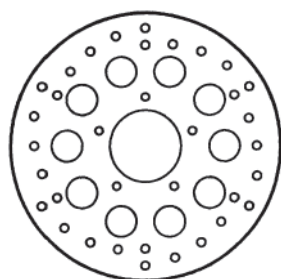
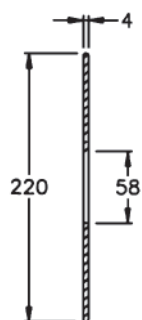

- 55932 Gilera** Runner (ant.)  
**Piaggio** NRG Extreme - Skipper (dal '99)  
 (post.)



- 58494 Piaggio** Dischi anteriori Ape Porter  
 (ø 227 esterno)

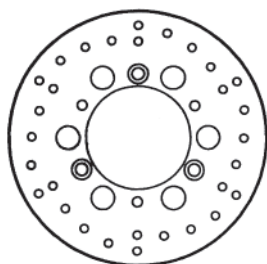
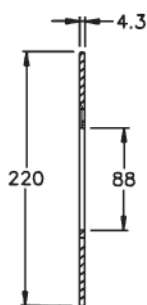

- 55933 Honda** Scoopy SH 50-100 (dal '96) (ant.)  
**Honda** NSR 50 - NS1 75 - CBR 600 F  
 (87-90) (post.)  
**MBK** Flipper (ant.)  
**Yamaha** Why (ant.)

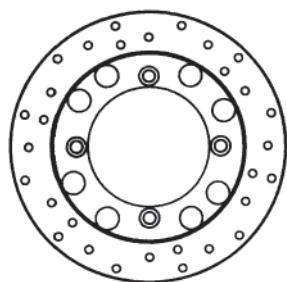
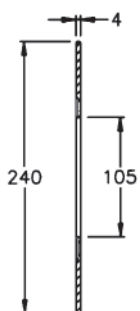

- 55934 Honda** Pantheon 125-150 -  
 Foresight 250 - CB 250 (ant.)  
**Honda** CB 500 - CB 500 S -  
 CB 750 Seventy (post.)  
**Honda** XL 500 V Transalp - X  
 RV 650 Africa Twin (post.)

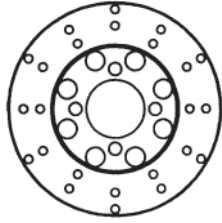
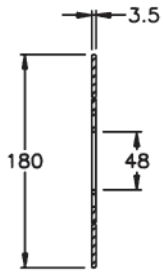

- 55935 MBK** Booster NG (prima del '98) - Rocket - Track - Spirit (2ª serie) (ant.)  
**Yamaha** Bw's NG (prima del '98) - Spy - Bump - Original (2ª serie) (ant.)

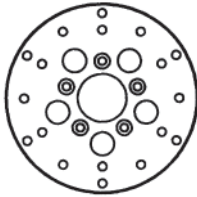
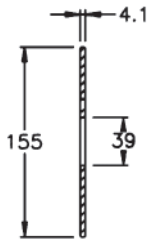

- 55936 Atala** Byte 50 (ant.)  
**Macal** Sting (ant.)  
**Malaguti** F-10 - Yesterday (ant.)  
**Peugeot** SV 50 (1ª serie) - Zenith (1ª serie) (ant.)  
**Rieju** F-10 (ant.)

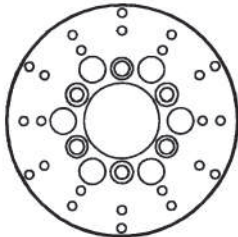
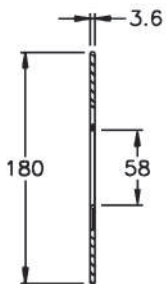

- 55937 Kymco** Dink 50-125-150 (ant.)  
**Peugeot** Speedfight (ant.)

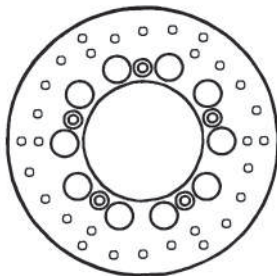
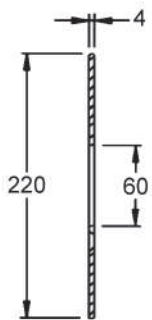

- 55939 Aprilia** Scarabeo 50 (dal '98) (ant.)



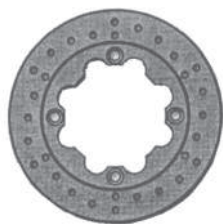
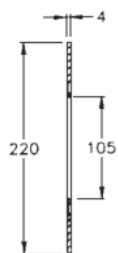

- 58182** Honda SH 125-150  
Chiocciola 125-150  
(adatt. 45351 - KGF - 900)  
(ant.)



HONDA r.o. 45351-KTW-901  
300 SH 300 07-12  
300 SH 300 ABS 07-12

256 x 144 x 4,5 - fori 6 x 10,5

- 58598** Disco freno anteriore Honda SH 300 - 300 I  
( $\varnothing$  Est. mm 256 -  $\varnothing$  Int. mm 144 - Spessore mm 4,5 -  
 $\varnothing$  Fori Fissaggio mm 10,5)



- 58599** Disco freno posteriore + pastiglie freno  
Honda SH 300 - 300 IE / ABS dal 2007 al 2015  
( $\varnothing$  Est. mm 256 -  $\varnothing$  Int. mm 144 - spessore mm 5 -  
 $\varnothing$  fori fissaggio mm 10,5)

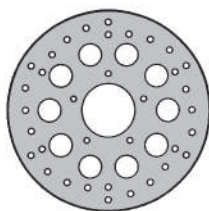
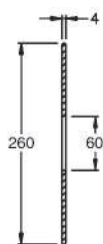

- 58183** Aprilia Scarabeo 125-150  
Scarabeo 200-500  
Atlantic 500  
Arrecife 500  
(ant.)

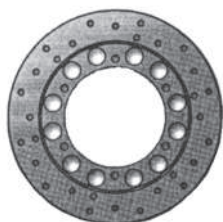
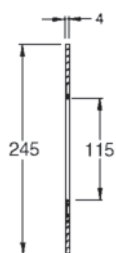

- 58184** Yamaha Majesty 250  
(ant.)

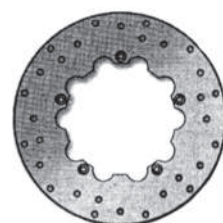
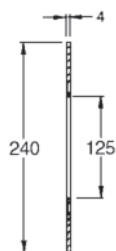

- 58186** Piaggio X9 125 (ant. - post.) ad. 564371  
Gilera Eaglet (ant.)

## TUBI FRENO



- 1563886** Vespa ET2 50 - ET2 iniezione 50 - ET4 125-150
- 1564288** Runner - **Post.**
- 1564254** NRG MC3 - RST MC2 - Extreme - **Ant.**
- 1563847** Skipper - LX - 4T 125-150 - **Ant.**
- 1274924** Runner FX - FXR 125-180 - **Ant.**
- 1274351** Runner 50 - **Ant.**
- 1271470** Typhoon 50-125 - **Ant.**
- 1564417** Zip - Zip 4T - **Ant.**
- 1564166** Liberty 50-125 - **Ant.** (98-99)
- 1563806** Vespa PX 125-150-200 - **Ant.**
- 1273244** Stalker 50 - **Ant.**
- 91318** Ape tutti i tipi - **Post.**
- 1246636** Ape TM P703 - P703V - Diesel - FL2 - TM P602 - **Ant.**
- 1246635** Ape Car P2/P3 - Max Diesel - **Ant.**
- 93777** Ape MP P501-P601 - **Post.**

## CENTRALINE ELETTRONICHE



**55940 Malaguti** F10 - F12 - Centro - Centro SL -  
Crosser - R.O. 02403300



**55942 Piaggio** - Free - NRG - NTT -  
Quartz - Sfera - Sfera FL - Zip  
R.O. 252537



**55943 Malaguti** F10 - Centro  
**Yamaha** BWS - R - NG - Aerox - Neo's - Why  
**MBK** Booster - Target - Evolis - Sorriso -  
Active - Fizz - Track - Nitro - Flipper - Stunt  
R.O. Yamaha 3GF-H5540-00



**1639978 Piaggio** Centalina elettronica  
50 cc - **4 Tempi**

**1639832 Piaggio** Centalina elettronica  
100 cc - **4 Tempi**



**55950 Piaggio** - SI - Vespa 50 PK -  
Typhoon - Storm - NRG 50  
R.O. 244127



**55947 Piaggio** - Vespa 50 HP - Ape 50  
Vespa PX 125-150-200-125 ET3 - 125 PK  
R.O. 244128

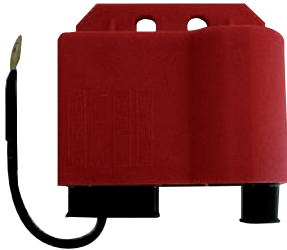

**1244129** Centralina **Piaggio**  
TM703 benzina rossa  
(R.O. 195010 - 195760 = 240275 - 244129)

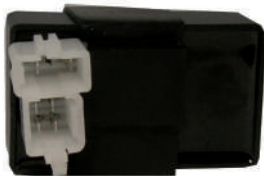

**58463** Centralina **Kimco** (R.O. 00168923)  
B & W 125 - 150 - Dink LX - Classic 125 - 150  
Gran Dink 125 - 150

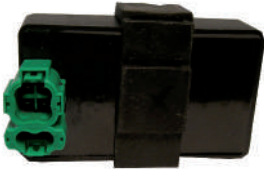

**58464** Centralina **Kimco** (R.O. 00169303)  
People 50 99-2008

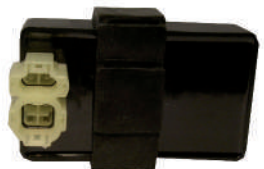

**58465** Centralina **Kimco** (R.O. 00169397) People 125 - 150  
Malaguti (R. O. 02406500) Ciak 125 - 150



**1294150** Centralina (Mitsuba)  
**Piaggio** (R.O. 294150) Liberty 125 - Hexagon 125 LX4

## REGOLATORI

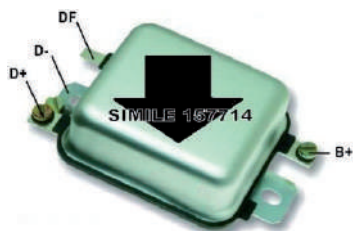

**1157714** Regolatore di tensione

**Piaggio** Ape MP -  
P. 501 - P. 601  
Ape CAR - Ape TM -  
P. 602 - P. 703 (78-2005)



**1161639** Regolatore di tensione  
12V - 20A  
3 attacchi

**Piaggio** Vespa PX 125-150-200  
Arcobaleno -  
Vespa PK 125 S - T5



**1294016** Regolatore di tensione  
12V - 20A  
5 attacchi

**Piaggio** Vespa PX avv. elett. - FL2 -  
ET2 -Sfera - RST -  
Maquillage 2 - Sfera 125 -  
Zip - Zip F.R. - Zip SP -  
Free - NRG - NRG MC2 -  
Quartz - Ape 50 FL - FL2



**1058096** Regolatore di tensione  
12V - AC DC  
8 attacchi

**Piaggio** Hexagon 125 LX4  
Vespa ET4 125  
Liberty 125  
(P. 294878-82587R)  
Vespa ET2 - Zip -  
Euro 1-SP -  
Free FL delivery -  
Ape Mix RST -  
Typhoon dal 2001 -  
NRG - MC2 - MC3 - RST



**55976** Regolatore di tensione  
12V - 20A

**Aprilia** Amico - SR. - Scarabeo -  
Gulliver - Rally  
**MBK** Booster - Target -  
Evolis - CT - Fizz -  
Forte - Ovetto - Nitro -  
NG - Flipper

**Yamaha** BWS - R - NG - Aerox -  
Neo's - Why  
**Malaguti** F10 - F12 - F15 - Centro

**58124** Regolatore di tensione

**Malaguti** Madison 125-150  
(R.O. 02601400)  
**MBK** Skyliner 125-150 -  
Doodo 125 -  
Thunder 125-150  
(R.O. 5DSH1960.00)  
**Yamaha** Majesty 125-150 -  
Teo's 125 -  
Maxter 125-150  
(R.O. 5DSH1960.00)  
**Benelli** Velvet 125-150  
(R.O. R51510061AO)  
**Italjet** Millennium 125-150  
(R.O. 4870706560)





- 58265** Regolatore di tensione  
**Yamaha** Majesty 125-150-180 dal 2002  
 Skyliner 125-150-180 dal 2002

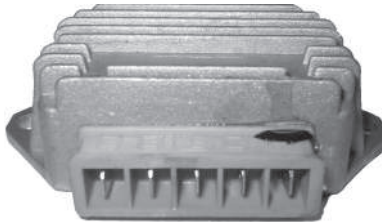

- 1230824** Regolatore di tensione  
**Piaggio** Vespa PK50XL - Rush-N-FL-T5-PX  
 Arcobaleno  
 Cosa 1-2  
 (motori con avviamento elettrico)



- 58266** Regolatore di tensione  
**Aprilia** Leonardo 125-150  
 Scarabeo 125-150  
 (adatt. 8112906)

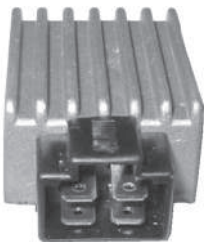

- 58267** Regolatore di tensione  
**Kimco 50** Dink-Classic euro 2 - People -  
 Heroism-Djw-Djy-Djx-CX-CX  
 Super-KB-K12-Top boy-  
 Sniper DD-Sniper-Filly-LX-  
 Fever ZX-Super 9-Bew-Yup  
**Kimco 125-150** People-Vivio-Movie-Movie X

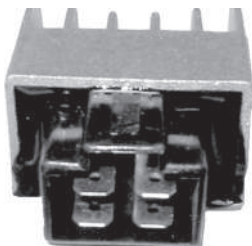

- 58268** Regolatore di tensione  
**Aprilia 50** Sr H20 Racing/Sport 00 - Habana  
 Custom  
**Honda 50** SH-SFX-Bali-SRX-X8R S7X8R XU  
 Shadow  
**Honda 100** Bali



- 58269** Regolatore di tensione  
**Kimco 125-150** Heroism-Dink-DinkLX-  
 Gran Dink - Dink Classic -  
 Bew - People - Yup  
**Kimco 250** Bew  
**Malaguti 125-150** F18 Warrior  
**Sym 125-150** Shark-Euro MX-Joy Rid-  
 Husky 125 - Superduke 150-  
 New Duke 125





**58270** Regolatore di tensione  
**Honda 125-150** @-SH-Dylan



**58466** Regolatore  
**MBK** (R.O. 4XY819600000) Skyliner 250  
**Yamaha** XP - T MAX 500 - Majesty 250 - X Max 250



**58467** Regolatore  
**Yamaha** (R.O. 5BN 819600000)  
X Max 125 - 150 - X Max Black 250



**58469** Regolatore  
**KIMKO** (R.O. 00169004) Agility 50 - Dink 50 -  
Dink Classic 50 - People 50 - 125 - 150 - Filly 50 -  
Sniper 50 - Vitality 50  
**Malaguti** (R.O. 02601500) Ciak 125 - 150  
**Peugeot** (R.O. 735871) Eliseo 50 - 100 - Ludix 50 -  
Speedfight 50 - 100 - Squab 50 - Trekker 50 - 100 -  
Zenith 50 - Vivacity 50 - 100



**58470 B** Regolatore  
**Honda** SH 125 - 150 Iniezione



**1639751** Regolatore  
**Piaggio** (R.O. 639751) Fly 50 - 100 - Liberty 50 - 100  
Vespa ET4 50 - LX 50  
**Aprilia** Scarabeo 50 4 t - 100 4 t



**1969382** Regolatore  
Atlantis - Boulevard - Fly 100-150 - Liberty 50 - Zip 100  
- Scarabeo 100 - 50 4T - Vespa LX50 - Primavera 50



**1058096** Regolatore  
**Aprilia** (R.O. 58096R) Scarabeo 50 - SR 50  
**Gilera** Runner 50 - Stalker 50 - Storm 50 - Typhoon 50  
**Piaggio** Ape 50 - Fly 50 - Free - Hexagon 125  
Liberty 50 - Vespa ET 2 - ET 4 - LX - LXV - S





- 1058090** Regolatore  
**Aprilia** (R.O. 58090R) Atlantic - Scarabeo - Sportcity 125 - 250  
**Gilera** Nexus 125 - Runner 50 - 125 - 200  
**Piaggio** Beverly 125 - 200 - Carnaby 125 - 200  
 Fly 125 - Hexagon 125 - 180 - Liberty 125 - 150 - 200  
 Skipper 125 - 150 - Vespa GTV - GTS - ET4 - LX 125 - 150 Granturismo - X 7 - X 8 - X 9



- 1058086** Regolatore  
**Aprilia** (R.O. 58086R) Atlantic 250 - 400 - 500  
 Scarabeo 250 - 300 - 400 - 500 - Sportcity 250 - 300  
**Gilera** Nexus 125 - 250 - 300 - 500  
**Piaggio** Beverly 250 - 400 - 500 - Carnaby 250 - 300 - MP3 125 - 250 - 400 - Vespa GTS - GTV - GT60 - X Evo - X 7 - X 8 - X 9 250 - 400 - 500  
**Malaguti** (R.O. 02602400) Madison - Spidermax 250 - 500



- 55999** Intermittenza (flasher) - (adatt. 3VL - H3350)  
 MBK Booster - Booster R - Spirit - Evolis



- 58358** Intermittenza  
**Honda** SH - @ - Dylan 125-150  
 (38301 - MBW - D21)



- 1163968** Intermittenza **Piaggio**  
 (P. 291016 - Sfera - Zip - Zip RST - FR - SP - Stalker - P. 195703) GSM 50 - Typhoon 50-125 - Runner - FX - FX R 125-180



- 1640289** Intermittenza  
 Vespa: GT 60 EURO 3 - GTS - GTV - GTS I E - GTS Super - GTS 4T I E Super -X7 EURO 3 - X7 EVO IE EURO 3 - Beverly 4T 4V I E EURO 3 Sport Touring - Liberty 4T 3V I E EURO 3 - Liberty 4T 3V LEM - S 4T 3V I E - LXV I E 4T - Beverly RST 4T 4V I E EURO 3



- 1196549** Pick-up **Piaggio**  
 Vespa PXE 125-150-200 Arcobaleno - PK XL - Rush - N - FL - FL2 HP - PK 50-125 - PK XL 125 - PXT5 - Ape 50 TM - FL - FL2 - FL3 - RST - MIX - Cosa 2 125-150-200 - PX 125-150-200

- 1498865** Pick-up motori **Piaggio** - Gilera 50 - Liberty - ET2 - Sfera - Free - Quartz - Zip - Zip F.R. - Zip RST - Zip SP - Typhoon - NRG - NTT - NRG MC2



- 1479093 Starter automatico** per carburatori Dell'Orto Motori Piaggio 50cc. 2T  
Liberty 97-05-Free 92-94-Free FL 95-02  
Zip 00-04-RST 96-99-ZIP  
SP 96-00-NRG MC3 01-04-HEXAGON LX-LT



- 1058115 Relé 12V 80A - Piaggio**  
(P. 580062-582518-583337-58115 R)  
Zip - Free - Quartz - NRG - Liberty - Sfera - ET2 - Skipper 125/150 - Beverly 125/150 - Hexagon GTX 125/180 - Yamaha Aerox - Bw's - Majesty - TMax

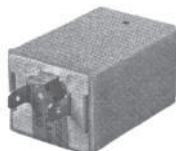

- 1213594 Relé intermittenza - Piaggio**  
(adatt. P. 195703)  
Vespa PX Arcobaleno



- 1582690 Relé avviamento Piaggio** (R.O. 592690) Beverly 400 - 500 - MP3 400  
X8 400 - X9 500 - X9 Evolution  
Yamaha Majesty 250 - T Max 500



- 1291383 Anello Portaspazzole Piaggio**  
Vespa PK 50 - Ape 50 - XL 50 - Rush - FL  
(R.O. 179755 - 291383)



- 58566 Anello porta spazzole Honda** SH 125-150



- 1969228 Supporto bobina completo**  
Motori **Piaggio** 4 T. - 50 cc.  
Vespa ET4 - Liberty 50 - PK 50XL - Delivery - Fly  
ZIP 50



- 1199500 Supporto bobine completo - Piaggio**  
Vespa PK 50-125 - Ape 50 FL - FL2 - RST MIX - FL3 Europa - **5 fili**

- 1217866 Supporto bobine completo Piaggio**  
Vespa PXE 125-150-200 Arcobaleno dal 1981 al 2001

- 1217983 Supporto bobina completo Piaggio**  
Vespa PX - Arcobaleno  
**Avviamento elettrico**

- 1830294 Statore completo motori Piaggio** 50  
Liberty - ET2 - Sfera - Sfera RST - Zip - Zip RST - Zip F.R. - NTT - NRG - Zip SP - Free - Quartz - Stalker - Runner - Typhoon - Storm



- 1584690 Supporto bobine Piaggio**  
Beverly 125 - Fly 125-150-200 - Typhoon 125-X8  
125-150-200-X9 125 - Vespa GT 125-200  
Vespa LX 150 - Vespa S 125-150



**1199495** Supporto bobine **Piaggio** Ape 50 - PK 50 - **3 fili**



**1256309** Supporto bobine completo **Piaggio**  
Ape 50 - FL3 - **3 fili** - IIª serie



**1150776** Supporto bobine 125 VNA - VNB - GT - GTR 1ª serie - Super - TS - 1ª serie - 150 VBA - VBB - T4 - GL - Sprint - C 1ª serie - Super 1ª serie 3 bobine 6 volts 5 spire senza batteria add. P. 150776



**1218824** Teleruttore **Piaggio**  
Typhoon 125 - PXE 125-150-200 - PK XL - N - FL - FL2 HP - PX - T5 - Cosa 2 125-150-200 - Skipper 125-150 - Hexagon 125-150 - Ape 50 TM P - FL - FL2 - FL3 Europa - Cosa CL - CLX 125-150-200 - Ape Poker benzina-diesel - Ape Car max diesel - Ape TM P703



**1058246** Teleruttore 12V-30A **Piaggio**  
Vespa LX-LXV-S 50-125-150  
Liberty 4T-125-150-200  
Beverly RST-Euro 3  
(P.58246R)



**58326** Teleruttore avviamento 100 A  
**Kymco** 125-150-250  
**Malaguti** motori Kymco



**1157713** Teleruttore avviamento Piaggio  
APE MP 501 - 601 - TM 703



**58567** Teleruttore avviamento Piaggio  
APE MP 501 - 601 - TM 703  
**Nuovo tipo** P.1E000371



- 72121** Bobina esterna A.T. **Piaggio**  
Ciao SC-PX - Grillo-Bravo Si -  
Vespa 50 L-R-Special-90-SS -  
125 Primavera - P125-150X-150 Sprint - Super-  
GT-TS-GL Spring-Ape 50 TL1-TL2  
(P. 244114)



- 74858** Bobina alta tensione **Piaggio**  
Vespa 125 GTR - TS - 150 Sprint (P. 90613)



- 55978** Bobina A.T. **MBK** Booster - R - Spirit - NG  
Flipper - Track -  
Skyliner 125-150  
**Yamaha** BWS - R - NG - Aerox  
Neo's - Why



- 58462** Bobina A.T.  
**Malaguti** (R.O. 02405000)  
**Madison** 125 - 150 - Phantom  
**MBK** (R.O. 3RWH231000000) Skyliner 125 - 150 - 180  
**Yamaha Majesty** 125 - 150 - 180



- 1058095** Bobina CDI  
Aprilia (R.O. 58095R) Scarabeo 50 - SR 50  
Gilera Runner 50 - Stalker 50 - Storm 50  
Piaggio Liberty 50 - NRG 50 - Zip 50 - Fly 50 -  
Vespa LX 50 - LXV 50



- 1828817** Bobina A.T.  
Piaggio (R.O. 58120R) MP3 250 - 400 - Beverly 250 -  
400 - 500 - Vespa GTS - GTV - GT60 - X 7 - X 8 - X9  
Aprilia Atlantic Scarabeo 250 - 300 - 500  
Gilera Nexus 125 - 300 - 500  
Malaguti Madison - Spider Max



- 1292418** Bobina A.T. esterna  
**Gilera** Easy Moving 50 - Storm 50 - Typhoon 50  
(accensione per antifurto)  
Typhoon X-XR 125 99/00 -  
Runner FX-FXR 125-180 97/2000  
**Piaggio** Hexagon LX4 125 98/99 -  
Hexagon LX/LXT 125-180 98/99 -  
Hexagon 125-150 94/97 -  
Skipper 125-150 94/97 -  
Skipper LX 125-150 98/99 -  
Vespa ET4 125 96/99 -  
Sfera 125 95/97 - Sfera 50 RST 95/97 -  
Sfera base 91/93 - Liberty 125 92/94 -  
ZIP base 50 92/96 -  
(R.O. 292418-826115)



**58327** Bobina alta tensione  
Peugeot 50 cc - **2 Tempi**



**1829337** Bobina A.T.  
Aprilia (R.O. 829337 / 58083R)  
Atlantic 125 - 250 - 06-08 Mot. Piaggio  
Gilera (R.O. 829337 / 58083R)  
Runner 125 VX - 200 VXR 02-04  
Honda (R.O.30510-GW2-000)  
Chiocciola 125 - 150 - SH 50 - 100 - 125 - 150  
Kimco Agility 125 - 150 4T R16 08  
Peugeot (R.O. 718513 / 738724)  
Elyseo 50 - 100 - Speedfight 50 A/C Cat. 99  
Speedfight 250 Aria 05-06 - Speedfight 100 97-00  
Piaggio (R.O. 829337 / 58083R)  
Beverly 125 - 200 01-03 Beverly 250 06-07  
Hexagon 125 GTX - Liberty 125 RST PTT - MP3 125 -  
Vespa GTS 125 - GTV 125 - ET4 125 - 150  
Granturismo 125 - 200 - X7 - X8 - X9 - Evolution 125 - 250



**1829337 E** Bobina A.T.  
Aprilia (R.O. 829337 / 58083R)  
Atlantic 125 - 250 - 06-08 Mot. Piaggio  
Gilera (R.O. 829337 / 58083R)  
Runner 125 VX - 200 VXR 02-04  
Honda (R.O.30510-GW2-000)  
Chiocciola 125 - 150 - SH 50 - 100 - 125 - 150  
Kimco Agility 125 - 150 4T R16 08  
Peugeot (R.O. 718513 / 738724)  
Elyseo 50 - 100 - Speedfight 50 A/C Cat. 99  
Speedfight 250 Aria 05-06 - Speedfight 100 97-00  
Piaggio (R.O. 829337 / 58083R)  
Beverly 125 - 200 01-03 Beverly 250 06-07  
Hexagon 125 GTX - Liberty 125 RST PTT - MP3 125 -  
Vespa GTS 125 - GTV 125 - ET4 125 - 150  
Granturismo 125 - 200 - X7 - X8 - X9 - Evolution 125 - 250



**71473** Contatto (P. 129434)  
Piaggio Vespa 125 Primavera - Vespa 90 - GT 125 -  
Sprint 150 - Sprint Veloce



**80273** Contatto (P. 140963)  
Piaggio Vespa 125 - 150 1972 - Vespa PX 125 -  
150 Senza Frecce - Ape 400 - 500 - P 401



**72128** Contatto (P. 141838)  
Piaggio Vespa 125 Primavera - 150 Super -  
180 Rally - 200 Rally - Ape 50 P - Ape 250 TM





**1134117** Contatto (P. 134117 / 182342)  
PIAGGIO Vespa PX 125 - 150 - Con Frecce 1978



**100322** Contatto (P. 103133)  
Piaggio Ciclomotori Tutti Tipi



**71862** Contatto (P. 71186 - 101761)  
Piaggio Vespa 50 - Vespa 50S - Vespa 50 Special  
Vespa R - S - L - N (dal 63 - 73)



**71470** Condensatore (P. 78937) 20x31  
Piaggio Vespa 50 - 1957-72 - 50 S - 50 SS



**71471** Condensatore (P. 79697) 20x31  
Piaggio Ape 50 - 250 - Vespa Primavera 125  
150 Super - 180 SS - 90 - 90 SS



**93824** Condensatore (P. 123828) 14x35  
Piaggio Ape 550 MPV - 600 MP - 600 MPV



**1182343** Condensatore (P. 182343 / 134116)  
Piaggio Vespa PX 125 - 150 Con Frecce



**74604** Condensatore (P. 155973) 20x30,5  
Piaggio Vespa 125 GTR - TS - Sprint - 150 Super -  
180 Rally

## COMMUTATORI LUCE



- 71466** P. 92654 Vespa 50-50R (63/83) - V5A1  
**62017** P. 72476 Vespa 50  
**71860** P. 73169 Vespa 50 S - 50 SS - V5SA1  
**74816** P. 92041 Vespa 90-125 Super (65/78) - Primavera (67/83) - TS - 180 Rally (68/73) - V9B1 - VMA2  
**62018** P. 144972 Vespa 150 Super - 150 Sprint - 180 SS c/batteria  
**72140** P. 143324 Vespa 125 ET3 (76/83) - Rally 200 (72/89) - VMB1  
**62019** P. 143680 Vespa Rally 200 c/batteria  
**79390** P. 87558 - P. 29865 Vespa 150 (59/62) - 150 GL (63/64)  
**90478** P. 57663 Ape 150 - 250 - 450 - MP - Pentarò



**62020** P. 61350 Vespa 150 GS - 160 GS



**74126** Commutatore luci  
Vespa 125 - 150 VN 1/2 T dal 1954 - 1957



- 71972** P. 142966 - P. 123152 Vespa 50 Special (70/83) - 90 S  
**62021** P. 216442 Vespa PK50 - PK50 S - PK125  
**1160752** P. 160752 Vespa P125X - 150X (77/86) - P150 S dal 78 - No frecce  
**1163132** P. 163132 - P. 215669 Vespa P125X - 150X - P200E (77/82) - P150S  
**62022** P. 215668 Vespa P125X - 150X - 200E dal 1982 - con frecce  
**62023** P. 164516 Vespa P125X - 150X - 200E - con batteria  
**1149185** P. 149185 Vespa P125X - 150X - 200E fino all'82 - P150 S - con frecce  
**1160740** P. 160740 Vespa P125X - 150X - 200E dall'81 - no frecce  
**62024** P. 189916 Ape P50 (80/84)  
**62025** P. 230268 Ape P50 dall'84  
**62026** P. 230471 Ape TM50 dall'86





**71242** P. 70744 Presa bassa tensione  
Vespa 50 - 90SS - ET3 - Ape 50

**74878** P. 120811 Presa bassa tensione  
Vespa 125GTR - 150 Super -  
GL - 150 Sprint veloce - 180 Rally -  
200 Rally



**62055** Presa bassa tensione marrone  
Vespa 125 - VNA - 1-2-3-4-5 - VNB5



**62056** Presa bassa tensione nera  
Vespa 125 VNA - 1-2-3-4-5



**62057** Presa bassa tensione marrone  
Vespa 150 VBA - VBB1-2 - GL



**62058** Presa bassa tensione nera  
Vespa 150 VBA - VBB1-2 - GL



**62059** Presa bassa tensione nera  
Vespa 125 Super - 150 Super - GL - 180 Rally



**62060** Presa bassa tensione nera  
Vespa GS - 180SS - P. 56985



**62061** Presa bassa tensione nera  
Vespa 150 GS - VS 2-3-4-5 - P. 26936



- 62052** Presa bassa tensione centralina  
Vespa 200 Rally - P. 125803



- 62053** Presa alta tensione Vespa 125 - al 1957 - P. 20155



- 62054** Presa bassa tensione  
Vespa 125 - 150 - 150GS - VS1 - P. 2506

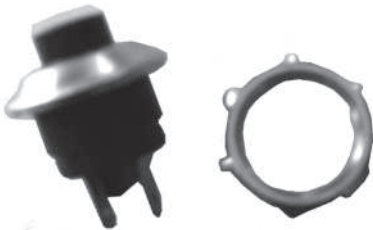

- 80295** P. 73185 Pulsante spegnimento  
Vespa 200 Rally - Ape 450 -  
MP 500 - 550 - 600



- 73037** Ghiera frizione - P. 20375



- 73901** Anello ritegno ghiera frizione - P. 22313



- 72153** Interruttore chiave Vespa 125 primavera - ET3  
P. 148151



- 1160743** Interruttore chiave Vespa P125X - P150X - P200E



**62036** Coppia molle biconiche color verde dx - sx  
sella anteriore Vespa 125  
VM1T - VM2T - VN1T - VN2T



**62037** Coppia molle biconiche cromate dx - sx  
sella anteriore Vespa 125  
VM1T - VM2T - VN1T - VN2T



**62038** Coppia molle biconiche dx - sx  
sella anteriore Vespa 150  
VL - VL2T (P. 610277M)



**62039** Coppia molle coniche dx - sx  
sella anteriore Vespa 125  
V1T - V15T - V30T - V33T (P.11207)



**62040** Coppia molle cavalletto Vespa 125  
V1T - V15T - V30T - V33T - VM1/2 -  
VU1 - VN 1/2 (P. 610083M)  
Vespa 150 VL 1/2/3 - VB1  
Vespa 150 GS VS1/2/3/4/5



**71404 C** Tirante tappo - Vespa 50 - 90 - 125 - Primavera - ET3 (P. 92217C)



**71826** Passacavo uscita comandi - Vespa 50 - 90 - 125 - Primavera - ET3 (P. 70219)



**1291017** Supporto in gomma per dispositivo lampeggiatori tutti modelli Piaggio



**58439** Supporto ruota - Vespa 50 S (ruota 9) - mm 197

**58440** Supporto ruota - Vespa 50 - 90 - 125 Primavera - ET3 - GL - GS - Sprint (ruota 10) - mm 197

**58441** Supporto ruota - Vespa 50 - 90 (ruota 9) - mm 73

**58442** Supporto ruota - Vespa 125 - 150 Super (ruota 8) - mm 175



**62118** Kit guarnizioni supporto ruota scorta Vespa 50 Special - 50 R  
**Cerchio aperto**



**62119** Kit guarnizioni supporto ruota scorta Vespa 125 Super - 150 Super



**62120** Kit guarnizioni supporto ruota scorta Vespa 50 N - L  
**Cerchio chiuso**

## GRUPPO CAVI ELETTRICI COMPLETI



- 1142965** Vespa 50 Special dal 1972
- 1102462** Vespa 50 L - 50 R
- 1149247** Vespa 125 ET3
- 1144505** Vespa 125 Primavera
- 1114309** Vespa - 180 Rally - GTR - TS - Sprint Veloce
- 1217897** Vespa PX Arcobaleno - Senza avviamento elettrico
- 1242182** Vespa PX Arcobaleno - Con avviamento elettrico
- 1162064** Gruppo cavi elettrici completo  
Piaggio Vespa PX 125 - 150 - PE 200 - 1ª Serie - Senza Frecce  
Adattabile (P. 162064 - 182312)
- 1181940** Gruppo cavi elettrici completo  
Piaggio Vespa PX 125 - 150 - PE 200 - 2ª Serie - Con Frecce  
Adattabile (P. 181940-182311-243566)
- 1099340** Gruppo cavi elettrici completo  
Piaggio Vespa 150 GL - 1963-1965 - Adattabile (P. 99340)



**58400** Coppia frecce anteriori - Vespa PX 125 - 150 - 200 E - T5 (**gemme bianche**)

**58401** Coppia frecce anteriori - Vespa PX 125 - 150 - 200 E - T5 (**gemme arancioni**)



**1058174/175** Coppia frecce anteriori  
Vespa LX 50-125



**1058176/177** Coppia frecce posteriori  
Vespa LX 50-125



**58402** Coppia frecce posteriori - Vespa PX 125 - 150 - 200 E - T5 (**gemme bianche**)

**58403** Coppia frecce posteriori - Vespa PX 125 - 150 - 200 E - T5 (**gemme arancioni**)



**58523 DX** Specchio cromato destro - Vespa PX 125 - 150  
Millenium - Freno disco 98-2011 - Ø 20  
(P: 181301)



**58524 SX** Specchio cromato sinistro - Vespa PX 125 - 150  
Millenium - Freno disco 98-2011 - Ø 20  
(P: 181302)



**58525 C** Staffa supporto specchio Vespa PX



**1143687** Fanale posteriore completo Vespa 50 Special,  
50 Elestart calotta grigia (P. 143687)



**1162740** Fanale posteriore completo  
Piaggio Vespa PX 125 - 150 - P200E



**1058263** Fanale posteriore completo con lampadina  
Vespa LX 50-125



**1058269** Fanale posteriore completo lampadina/guarnizione  
Vespa PX 125-150 20011 2013  
Vespa P125X-P150X 30 anni 2007 2008  
(P.583081)





**80009** Fanale posteriore in metallo cromato  
Vespa 125 Super - GT - 150 Super Sprint  
180 SS - 180 Rally



**79730** Fanale posteriore completo con lampadina e guarnizione  
Vespa 125 Super VNC 1T - GT VNL 2  
150 Super VBC 1T - Sprint VLB 1T  
180 SS VSC 1T (R.O. 91419)



**58540** Guarnizione fanale posteriore



**79395** Fanale posteriore completo in metallo  
lampadina/guarnizione  
Vespa 125-150  
(P.89442-93186)



**71479** Fanale posteriore completo in metallo  
lampadina/guarnizione  
Vespa SuperSprint-125-Primavera  
(P.78641)



**58539** Guarnizione per 71479



**74828** Fanale anteriore metallo cromato - vetro  
Vespa VNB 3-6 - 150 VBA - VBB - VGLA  
Vespa 160 GS - Ø 115 mm.



**80011** Fanale completo  
Piaggio Vespa 125 GTR - TS - 150 Sprint Veloce -180 -  
200 Rally



**1191192** Fanale anteriore Vespa 50 Special, 50 Elestart (P. 191192)



**72148** Fanale completo  
Piaggio Vespa 90 SS - 125/150 Super - 125 Primavera -  
ET3





**62081** Porta lampada  
Vespa 125 - 150 - 180 - 200 - P.163190



**79733** Fanale completo  
Piaggio Vespa 125 GT - GL - Sprint - 180 Super



**1161235** Fanale completo  
Piaggio Vespa PX 125 - 150 - P200E  
Vespa PX Arcobaleno



**1232834** Fanale completo  
Piaggio Vespa T5 125



**1058259** Fanale anteriore completo con lampadina  
Vespa LX 50-125



**1058258** Fanale anteriore completo con lampadina  
Liberty 4T Euro3 125-150-200 2006 2012  
(P.584787)

**1058258 B** Fanali con lampadina **H7**



**1058260** Fanale anteriore completo con lampadina **H7**  
Vespa LX 125-150 2005 2013  
(P.638649-639290)



**71747** Cornice faro - Vespa 125 Primavera -  
ET3 (P. 151742)



**71938** Cornice faro - Vespa 50 - 90 (P. 124200)



**79727** Cornice faro Piaggio  
Vespa 125 GT - 150 GL - 150 Sprint - 180 SS



**71746** Cornice faro tondo  
Vespa 50 L - R - N



**71504** Molla ancoraggio faro - Vespa 50 - 90 - 125 -  
Primavera - ET3 (P. 138006)

## GUARNIZIONI SCOCCA / SERBATOIO sughero / gomma



- 58545** Vespa 125 V1 - 150
- 58546** Vespa 125 VNA - VNB  
Vespa 150 VBA - VBB
- 58547** Vespa 125 GT - TS  
150 GL - Super - 160 GS  
180 SS - Rally - PX 125 - 150 - 200
- 58548** Vespa 125 VM - VN1  
Hoffmann - ACMA
- 58549** Vespa 125 VN2 - 150 VL2/3 - VBB



- 62062** Piastra posteriore serbatoio c/filettatura  
Vespa 50 - 90 - 125 - P. 139987



- 62063** Piastra posteriore serbatoio s/filettatura  
Vespa 50 - 90 - 125



- 62064** Piastra posteriore  
Vespa 125 VNA1 - VNB1 - 2 - 3 - 4 - 5 - 150 VBA1  
VBB1 - 2 - GL - P. 083995



- 62065** Rinforzo per sella posteriore  
Vespa 125 VNA1 - 2 - VNB1 - 2 - 3 - 4 - 5 -  
150 VBA1 - VBB1 - 2 - GL



**62066** Piastra posteriore  
Vespa 125 VNBG - GT - GR - GTR Super  
150 Sprint Veloce - (adattabile TS - PX - PE  
senza miscelatore) - P. 175371



**62067** Piastra posteriore  
Vespa 125 VN1T - 150 VL1T



**62068** Piastra posteriore  
Vespa 125 VN2T - 150 VL2 - 3 - VB1T



**62069** Piastra posteriore  
Vespa 125 - 1953-54 - VM1 - 2



**62070** Piastra posteriore  
Vespa 125 - 1951-52



**62071** Piastra posteriore  
Cambio bacchetta 125 - 1949-50



**62074** Porta targa  
Vespa 90 - 90 SS - 125 Primavera - ET3  
P. 0704106



**62075** Porta targa  
Vespa 125 fino al 64 - Vespa 150 fino al 63  
P. 018306



**62112** Supporto Targa Vespa 50 - N - L - R Special

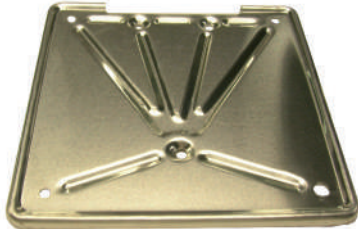

**62073** Supporto targa  
Vespa 150 GS - 160 GS - P. 24667



**71821C** Levetta starter Vespa 50 - 90 - 125 Primavera - ET3  
50 PK - 125 PK - P. 78305



**62079** Sotto manubrio Vespa 125TS - GTR - Primavera -  
ET3 - 150 Sprint - Veloce - 180 - 200 Rally  
P.114764/65



**62080** Sotto manubrio Vespa 125GT - Sprint - GL - 180SS  
P.71002//03



**71926** Vaschetta raccogli olio  
Vespa 90 - 125 Primavera ET3 - P.111123



**72141S** Staffa centralina Vespa ET3



**1164844** Staffa per bobina Vespa PX 125 - 150 - 200 PE



**71702** Piastra supporto cavi  
Vespa 50 tutti i tipi - P. 79001



**1241037** Piastra supporto cavi  
Vespa 90 - 125 Primavera - ET3 - PK50 - PK125



**71299** Ghiera bloccaggio cuscinetto ruota ant.  
Vespa 50S - 90 - P. 57940



**62078** Protezione impianto elettrico  
Vespa 125 ET3



**62050** Coperchio presa bassa tensione  
Vespa GS150 - VS 2-3-4-5 - P. 26937



**62051** Coperchio raddrizzatore di corrente  
Vespa 125 - VNB1T - 150 VBA1T - GL - P. 84724

**62041**

Kit gommini sportello motore piccolo attacchi verticali  
Vespa 50 1963/1965 - Vespa 90

**62042**

Kit gommini e boccole sportello motore piccolo  
attacchi orizzontali  
Vespa 50 dal 1965 - Vespa 90

**62043**

Kit gommini e boccole sportello motore  
Vespa 50 - 125 Primavera - ET3

**62044**

Kit gommini cofano motore  
Vespa 125 VNA 1-2 - VNB 1-2-3-4-5-6 - GT Super  
Vespa 150 VBA1T - VBB 1-2 - GL - Super - Sprint

**62045**

Kit gommini cofani dx - sx  
Vespa 150 Sprint - 160 GS - 180 SS

**62046**

Kit gommini cofani dx - sx  
Vespa 125 TS - 150 Sprint Veloce - 180 Rally  
200 Rally - 125 - 150 - 200 PX/PE s/freccie

**62047**

Kit gommini cofano motore  
Vespa 125 GTR - 150 GS - VS5



**62048**

Kit gommini cofani dx - sx  
Vespa PX 125 - 150 - 200 E

**62049**

Kit gommini cofani dx - sx  
Vespa PX 125 - 150 - 200 E Arcobaleno

**58478**

Kit gommini completi  
Vespa PX 125 - 150 - 200 E

**58479**

Kit gommini completi  
Vespa Sprint

**58603**

Kit gommini completi Vespa 50 Special - R - L - N -  
125 Primavera - ET3



**62131** Vetrolcontachilometri Vespa 50 Special - V5B 3T  
(P. 610355M)



**62082** Vetrol c/km  
Vespa 125 fino al 57 - 150 VL 1-2-3-4 - P. 017713



**62083** Vetrol c/km  
Vespa 125 VNA 1-2 - VNB 1-2-3-4-5-6 - P. 083202



**62084** Vetrol c/km  
Vespa 125 - 150 - 160 - 180 - P. 084803



**62085** Vetrol c/km  
Vespa 150 VB1T - 150 GS - VS 1-2-3-4 - P. 024818



**62086** Vetrol c/km  
Vespa 90SS - 125 Super - Primavera - ET3 - TS  
GTR - 150 Super - 180 Rally - 200 Rally - P. 100619



**62087** Vetrol c/km  
Vespa PX 125 - 150 - 200 PE



**62088** Vetrol c/km  
Vespa 125 - 150 - 200 PX - Arcobaleno  
PK 50 - PK 125



**62089** Ghiera c/km nera  
Vespa PX 125 - 150 - 200 E



**62090** Ghiera c/km cromata  
Vespa PX 125 - 150 - 200 E



**62091** Ghiera c/km nera  
Vespa PX 125 - 150 - 200 Arcobaleno  
PK 50 - PK 125



**62092** Ghiera c/km cromato  
Vespa PX 125 - 150 - 200 Arcobaleno  
PK 50 - PK 125



**62129** Ghiera contachilometri cromata Vespa 125 - VM - VN  
- Vespa 150 VL - Struzzo dal 1951 al 1957 (P. 83204)



**62130** Ghiera contachilometri cromata Vespa 50 Special -  
V5A 2/3 - V5B 1/2/3 (P. 610355M)

**58517**

Coppia tamponi traversa motore  
Vespa GS 160 - 180 SS - 180 Rally - 200 Rally

**58518**

Coppia tamponi traversa motore  
Vespa 50 - 50 S - Special - 125 Super - GT - GTR -  
150 GL - Super - Sprint - Sprint Veloce  
P125 X - P150X

**58518C**

Kit revisione supporto motore  
Vespa PX 125 - PX 150 tutti i tipi

**520015**

Flangia porta ruota  
Vespa 50 - 90 - 90 SS (P. 78941)



**62113** Staffa supporto batteria Vespa 125 VNB 1T  
Vespa 150 VBA 1T - VBB 1T - GL



**62114** Staffa porta batteria Vespa 150 VL2/3T - VB 1T



**62115** Staffa porta batteria Vespa GS - VS1 / 2 / 3 / 4 / 5



**62116** Coperchio in metallo per ruota di scorta  
Vespa 160 GS - Vespa 180 SS



**62117** Protezione per ruota di scorta  
Vespa 125 TS - Vespa 180/200 Rally (plastica)



**1178311/317** Coppia leva ancoraggio cofani laterali  
Vespa PX tutti i tipi



**1137655** Marmitta Vespa 50 - V5 B1/B2/B3



**1120218** Marmitta Vespa 125 Primavera - VMA2



**1417806** Marmitta Vespa PX 125 - PX 150  
VNX - VLX - VNX 2 - VLX 2



**1417809** Marmitta Vespa P 200 E - PE 200 - VSX - VSX 2



**1124046** Marmitta Vespa 150 Sprint - GL - Sprint Veloce  
VLB - VLB 1T - VLA



**1243130** Marmitta Vespa PK 50 S - PK 50 XL



**1830452** Marmitta  
Ape 50 TM - Europa



**1216493** Marmitta PK 125



**1850088** Marmitta  
Quargo - Porter



**58586** Marmitta Porter benzina 1300 dal 2010  
(P. B005218)



**58587** Terminale scarico marmitta **Piaggio** APE - Porter  
fino al 2010  
(P. B004288)



**58588** Marmitta **Piaggio** APE Poker  
(P. 256671)



**1417484** Marmitta APE TM 703 **Diesel**  
CAR MAX-Poker **Diesel**



**1242899** Marmitta APE TM 703-602-MP601 **Benzina**





## Cinghie trasmissione motori Piaggio

CODICE	APPLICAZIONE	CC	ANNO
<b>1029052</b>	CIAO EURO 1-2 - MIX - TEEN - S/VAR		
<b>1124593</b>	SI	50	1996-1999
	SI FL2	50	1991-1997
	SI	50	1979-1988
<b>1309382</b>	BRAVO	50	
<b>1286175</b>	ZIP - SFERA	50	1991-1993
<b>1430728</b>	FREE FL	50	1995-2002
	NRG RST MC2	50	1996-1998
	NTT	50	1995-1996
	NRG	50	1994-1996
	FREE	50	1992-1994
<b>1431190</b>	VESPA ET2	50	1997-2005
	ZIP SP	50	1996-2000
	ZIP RST	50	1996-1999
	ZIP FAST RIDER RST	50	1996-1997
	SFERA RST	50	1995-1997
	ZIP BIMODALE	50	1994-1997
	ZIP	50	1995-1996
	QUARTZ	50	1992-1996
	SFERA MAQUILLAGE 2	50	1994
ZIP FAST RIDER	50	1993-1994	
<b>1431258</b>	HEXAGON LX-LXT	125	1998-1999
	SKIPPER	125	1994-1997
	HEXAGON 2T	125	1994-1997
<b>1434812</b>	SKIPPER	125	1994-1999
	HEXAGON	125	1994-1997
<b>1436864</b>	VESPA SPRINT 2T 2V	50	2014
	VESPA PRIMAVERA 2T	50	2013-2014
	NRG POWER DD	50	2007-2013
	NRG POWER DD SERIE SPECIALE	50	2007-2012
	TYPHOON	50	2009-2011
	NRG POWER DT	50	2007-2011
	NRG POWER DT SERIE SPECIALE	50	2007-2008
	TYPHOON	50	2005-2008
	NRG POWER DT	50	2006
	NRG POWER DD	50	2006
	NRG POWER DD	50	2005
	NRG PUREJET	50	2002-2004
	TYPHOON	50	2001-2004
	NRG MC3	50	2001-2004
	FREE FL	50	1995-2002
	DIESIS	50	2001
FREE DELIVERY	50	2000-2001	
NRG EXTREME	50	1999-2000	
NRG RST MC2	50	1996-1998	
<b>1478547</b>	VESPA ET4	125	1996-1998
	SFERA	125	1995-1997

CODICE	APPLICAZIONE	CC	ANNO
<b>1825059</b>	LIBERTY	125	1998-2000
	HEXAGON LX	125	1998-1999
<b>1082645</b> (P. 82645R)	VESPA LX 4T-4V TOURING	50	2010-2013
	VESPA LX 2T TOURING & 30KG	50	2010-2013
	VESPA LX 4T-4V	50	2009-2013
	VESPA LX 2T	50	2009-2013
	ZIP 2T	50	2008-2013
	ZIP SP EURO2	50	2006-2013
	ZIP 4T	50	2006-2013
	VESPA S 4T-4V & COLLEGE	50	2008-2012
	VESPA S 2T & COLLEGE	50	2007-2012
	ZIP 4T	100	2006-2010
	VESPA LXV 2T	50	2006-2009
	VESPA LXV 2T NAVY	50	2008
	VESPA LX 4T	50	2005-2008
	VESPA LX 2T	50	2005-2008
	ZIP 4T	50	2000-2005
	VESPA ET4	50	2000-2005
	VESPA ET2	50	1997-2005
	ZIP SP	50	2001-2004
	ZIP	50	2000-2004
	VESPA ET2 INIEZIONE	50	1997-2000
<b>1827826</b>	X9	500	2001-2001
<b>1082941</b> (P. 82941)	MP3 LT BUSINESS - SPORT ABS	300	2014
	VESPA GTS IE	300	2012-2014
	MP3 YOURBAN ERL	300	2011-2014
	VESPA GTS SUPER	300	2008-2014
	VESPA GTS	250	2005-2014
	MP3 IE LT - IE LT SPORT	300	2011-2013
	MP3 IE LT TOURING	300	2011-2013
	VESPA GTV 4T 4V IE	300	2010-2013
	VESPA GTS SUPER SPORT	300	2010-2013
	MP3 4T 4V IE ERL IBRIDO	300	2010-2013
	VESPA GTS IE TOURING	300	2011-2012
	MP3 YOURBAN LT ERL	300	2011-2012
	MP3 IE TOURING	300	2011-2012
	MP3 300 IE MC	300	2011
	MP3 4T 4V IE LT IBRIDO	300	2010-2011
	MP3 300 IE LT	300	2010-2011
	VESPA GTV VIA MONTENAPOLEONE	300	2010
	MP3 300 IE MC	300	2010
	X7 EVO IE EURO 3	300	2009-2010
	MP3 MC	250	2008-2009
	MP3 LT	250	2008-2009
	VESPA GTV	250	2006-2009
	X7 EU3	250	2008
	MP3	250	2006-2008
	VESPA GTV 4T NAVY EU3	250	2007
	VESPA GT 60 EU3	250	2006-2007

CODICE	APPLICAZIONE	CC	ANNO
1829484	FLY 4T 100	100	2006-2008
1832738	MP3 RLTOURING	400	2011
	MP3 IE LT TOURING	400	2011
	X EVO	400	2007-2011
	MP3 MC	400	2008-2010
	MP3 IE LT - MP3 IE LT SPORT	400	2008-2010
	BEVERLY TOURER EU3	400	2008-2010
	MP3	400	2007-2008
	X8 EU3	400	2006-2008
	BEVERLY EU3	500	2006-2008
	X9 EVOLUTION ABS	500	2006-2007
	X9 EVOLUTION	500	2006-2007
	BEVERLY EU3	500	2006-2007
	BEVERLY	500	2005-2006
	X9 EVOLUTION	500	2003-2005
BEVERLY	500	2002-2004	
1833982	NRG	50	2004-2011
1840908	LIBERTY 4T EU3	200	2006-2008
	VESPA GRANTURISMO	200	2006-2007
	LIBERTY 4T SPORT EU3	200	2006-2007
	X8	200	2005-2007
	LIBERTY SPORT	200	2006
	LIBERTY	200	2006
	VESPA GRANTURISMO	125	2003-2005
	X8	125	2004
	LIBERTY RST	200	2004
	SUPER HEXAGON GTX 12	125	2001-2002
HEXAGON GTX	125	2000	
1841213	VESPA LT 4T 3V IE	150	2014
	VESPA GTS SUPER IE 4T 3V	150	2014
	VESPA 946 GT 4T 3V ABS	125	2013-2014
	LIBERTY 4T 3V LEM	150	2013-2014
	FLY 4T 3V IE E3 DT	125	2009-2014
	VESPA LX 4T 3V IE - TOURING	125	2013
	FLY 4T 3V IE EU3 LEM	125	2012-2013
	MP3 YOURBAN ERL	125	2012-2013
	VESPA LXV IE 4T	125	2010-2013
	LIBERTY MOC 4T EURO 3	125	2009-2013
	VESPA S 4T 3V IE	125	2012
	LIBERTY 4T 2V IE PTT - ITA	125	2012
	MP3 IE TOURING	125	2011-2012
	VESPA LX TOURING	125	2010-2012
	VESPA S 4T IE & COLLEGE	125	200-2012
	LIBERTY 4T 2V EU3	125	2009-2012
	X EVO	125	2007-2012
	VESPA GTS EU3	125	2007-2012
	LIBERTY 4T EU3 DELIVERY - SINGLE	125	2007-2012
	VESPA LX 4T EU3 TOURING	125	2010-2011
TYPHOON 4T 2V EU3	125	2010-2011	

pag.  
succ.



CODICE	APPLICAZIONE	CC	ANNO	
▲ pag. prec.	VESPA S 4T IE & COLLEGE	125	2009-2011	
	VESPA LX EU3 IE	125	2009-2011	
	VESPA LX EU3 IE	125	2009-2011	
	FLY EU3	125	2008-2011	
	FLY EU3	125	2008-2011	
	LIBERTY RST PTT	125	2005-2011	
	X7 EVO IE EU3	125	2009-2010	
	MP3 IBRIDO	125	2009-2010	
	VESPA LX 4T FL	125	2009	
	VESPA LX 4T FL	125	2009	
	VESPA S 4T	125	2008-2009	
	MP3 IE	125	2008-2009	
	LIBERTY 4T EU3 DELIVERY - TNT	125	2008-2009	
	VESPA LXV 4T EU3	125	2006-2009	
	X7 EU3	125	2008	
	VESPA GTV 4T NAVY EU3	125	2008	
	LIBERTY 4T SPORT EU3	125	2008	
	LIBERTY 4T EU3	125	2008	
	VESPA S 4T EU3	125	2007-2008	
	VESPA LXV 4T NAVY EU3	125	2007-2008	
	X8 STREET EU2	125	2006-2008	
	VESPA LX EU3	125	2006-2008	
	VESPA LX EU3	125	2006-2008	
	VESPA GTV	125	2006-2008	
	<b>1841213</b>	MP3	125	2006-2008
	LIBERTY 4T SPORT EU3	125	2006-2008	
	LIBERTY 47 EU3	125	2006-2008	
	X9 EVOLUTION EU3	125	2007	
	FLY EU3	125	2007	
	X8 STREET EU2	125	2006-2007	
	X8 PREMIUM EU3	125	2006-2007	
	VESPA GRANTURISMO EU3	125	2006-2007	
	VESPA GRANTURISMO	125	2006-2007	
	LIBERTY 4T	125	2006-2007	
	FLY	125	2006-2007	
	FLY	125	2005-2007	
	X8 PREMIUM EU2	125	2005-2007	
	LIBERTY SPORT	125	2006	
	X9 EVOLUTION	125	2006	
	X8	125	2005-2006	
	VESPA LX	125	2005-2006	
	VESPA LX	150	2005-2006	
	LIBERTY RST	125	2004-2005	
	VESPA GRAN TURISMO	125	2003-2005	
	X8	125	2004	
	X9 EVOLUTION	125	2003	
	X9	125	2001-2002	
	SUPER HEXAGON GTX 12	125	2001-2002	
	LIBERTY	125	2001-2002	
	ZIP	125	2000-2002	
	SKIPPER 4T	125	2000-2002	
	VESPA ET4	125	1999-2002	
	HEXAGON GTX	125	2000	

CODICE	APPLICAZIONE	CC	ANNO
1842009	X10 4T 4V IE EU3	125	2012-2013
	BEVERLY RST 4T 4V IE EU3	125	2010-2013
	CARNABY	125	2007-2010
	BEVERLY TOURER EU3	125	2007-2010
	BEVERLY EU3 SPORT	125	2007-2008
	BEVERLY EU3	125	2007-2008
	BEVERLY EU3 MIC	125	2007
	BEVERLY RST	125	2005-2007
	BEVERLY RST	125	2004-2005
	BEVERLY	125	2001-2003
1842011	CARNABY	200	2007-2008
	BEVERLY	125	2001-2003
1842907	VESPA SPRINT 4T 4V	50	2014
	VESPA PRIMAVERA 4T 4V	50	2013-2014
	FLY 4T 2V 25-30 KM/H	50	2012-2014
	FLY 4T 2V	50	2013
	FLY 4T 4V	50	2012-2013
	FLY 4T & 25730 KM7H	50	2008-2011
	FLY 4T MOTORE CHN	50	2006-2007
	FLY 4T	50	2005-2007
1856026	SCARABEO LIGHT	125	2007-2012
1841851 (B 013360)	BEVERLY	250-300	
	CARNABY	250-300	
1280102 (APO 280102)	LEONARDO	125-150	1996-2001
	LEONARDO ST	50	2001-2004
	SCARABEO 125-150-200-250	-	1999-2004
	SCARABEO (ROTAX)	50	1999-2004
1000014 (AP 2MCA000014)	SR 50 M20 DITECH_NEW	50	
	AREA 51 - AIR	50	
	AMICO - GULLIVER - RALLY	50	
1820610 (AP 8206109)	SCARABEO 2T	50	
1082646 (AP 82646R)	PIAGGIO 4T	100	



**1199491** Statore completo **Piaggio** PK50S 3 bobine 4 fili



**1294971** Statore completo **Piaggio** Vespa ET4 125 96-99 - Liberty 125 98- 2000-Hexagon LX4 125 98-99

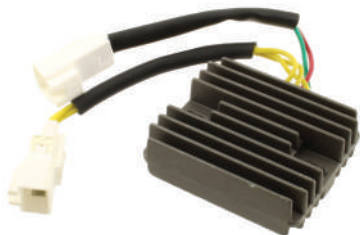

**1641709** Regolatore di tensione **Piaggio** BEVERLY RST-4T. 300 2010-13 MP3 I.E.-LT IBRIDO-TOURING-URBAN-VESPA GTS I.E.300 2012-13 VESPA GTS SUPER 300 2008-13-VESPA GTV 4T-4V-I.E. 300 2010-13

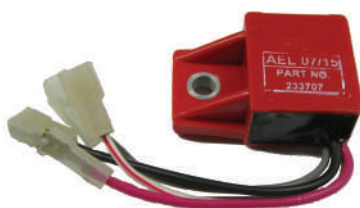

**1233707** Dispositivo antiripetitore avviamento Vespa PX 125-150-200-30 anni Vespa T5



**1218060** Regolatore di tensione **Piaggio** Ape FL3 Cross 50 1995-1998 APE 50 Cross RST - CROSS Country 1988-2013





**1582951** Commutatore a chiave **Piaggio**  
GTS - GTV - GT - Beverly - Crouiser -  
X9 250 - 500 - Carnaby



**1580621** Commutatore a chiave **Piaggio**  
ZIP SP 2006-2013 - ZIP 4T 50-100  
X7 125-150 - Vespa Sprint - S - Primavera 4T  
LX - LXV - Hexagon - Fly 2T-4T  
Aprilia Sport - SR  
Derby Boulevard  
Gilera Runner  
(P.643133)



**58557** Serie bulloni motore Vespa PX - PE 125-150-200



**55297** Kit prigionieri completi di dadi e rondelle di chiusura  
carter - Vespa 50 - PK50 - PK50XL - Rush - N -  
Primavera - ET3



**1218812**

Cinghia batteria Vespa PX125-150-200- Cosa-T5-  
PXE Arcobaleno  
VNX-VLX-VNX5T-VLR1T-VNX2-VLX2-VSX2

**1090854**

Cinghia batteria Vespa PX 1^ tipo- FL-PK XL-Rush-N

**58555**

Fusello mozzo ruota anteriore  
PIAGGIO Porter - QUARGO  
(P. B000824)



**1811508** Fanale anteriore SX Porter



**1811108** Fanale anteriore DX Porter



**1219488** Soffietto aspirazione carburatore  
APE TM 703 Diesel-CAR Max Diesel  
Poker Benzina-Diesel



**1263915** Raccordo aspirazione Porter -Quargo



**1174806** Piastra di fissaggio superiore ammortizzatore  
anteriore Vespa PX 125-150 - P 200E- T5



**74654** Carter coperchio frizione Vespa 125 VNA  
- TS - 150 VBA - Super Rally - PX 80 -  
P 200 E - Cosa - T5 rif. P. 50100/113995



**73680 C** Kit eliche registrazione ammortizzatore  
anteriore (P.2/35683 + 35582)



**73672 C** Perno snodo con supporto sospensione  
Vespa Super - GT -GTR - TS - GL  
(P.2/35581)

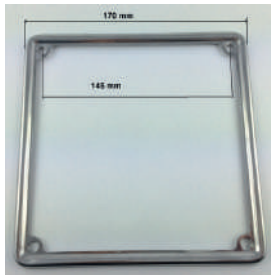

**62123** Cornice Targa Vecchio Tipo in ferro  
**cromata** Vespa, Moto

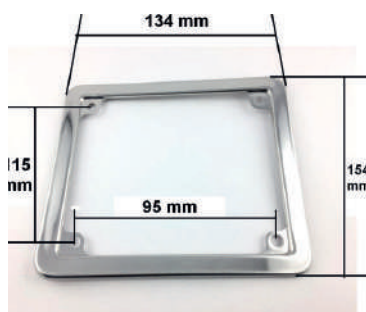

**62124** Cornice targa vecchio tipo in ferro cromato  
Vespa



**1157713** Teleruttore avviamento Piaggio  
APE MP 501 - 601 - TM 703



**1212569** Cinghia fermaporte Ape 50 - FL2 - FL3  
RST MIX - TM (lunghezza 135 mm)

**1187686** Cinghia fermaporte Ape 50 benzina-diesel  
(lunghezza 175mm)  
Ape TM 602 - 703 benzina-diesel

**1096933** Catena distribuzione  
**Piaggio** Libety 50 4T. Liberty PTT  
Vespa LX 50 4T - 4V - Touring  
Vespa S 50 4T - Sprint 50  
**Aprilia** Scarabeo 50 ST  
(P.96933R)

**1082723** Catena distribuzione  
**Piaggio** Beverly 250 - Tourer 250 2007-2009  
X9 - Granturismo 250-300 - Super - MP3  
X7 - X8 - X9 250-300  
**Gilera** Nexus  
(P.82723R)



**1082643** Catena distribuzione  
**Piaggio** Liberty 125-150 - Fly 125-150  
ET4 125 - LXV 125-150 - S 125-150  
**Kymco** Dink 125  
**Honda** SH 150 2001-2012  
(P.82643R)

**1082644** Catena distribuzione  
**Piaggio** Beverly 125-150 2003-2007  
Granturismo 125 2003-2005  
Vespa GTS - Super - GTV 2009-2015  
**Gilera** DNA - Runner - Nexus 2008-2010  
(P.82644R)



**1921700** Coperchio manubrio - Vespa FL2 - HP



**1652935** Coperchio manubrio - Vespa LX 50-125-150



**1652681** Coperchio manubrio Vespa GTS 125-300



**1621143** Copristerzo Vespa GTS 125-300



**1657588** Copristerzo Vespa LX 50-125-150



**1816900** Sportello ispezione candela Liberty 97-2005



**58568** Parafango anteriore Honda SH 125-150 dal 2013



**1241071** Gommino passacavo Vespa PK - PKS - XL - HP - RUSH

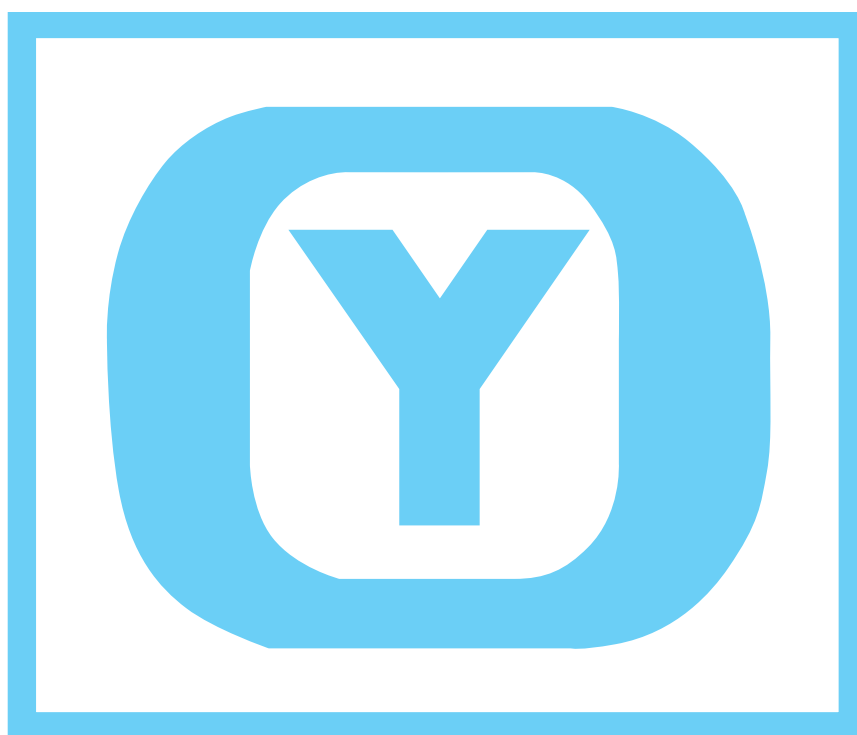





**58577** Membrana carburatore **Piaggio** Beverly - Sport - RST -  
Tourer 125 2007-2010  
X8 - X9 RT 200 2004-2009  
X9 Evolution 2004-2006  
(P. CM 140301)



**58578** Membrana carburatore **Aprilia** Leonardo 125-150  
1996 - 2004  
(AP 8106478)



**58579** Membrana carburatore **Piaggio** Liberty 125 1998 - 2000  
Hexagon LX4 125 1998 - 1999  
Vespa ET4 125 1996 - 1998  
Sfera 125 1995 - 1997  
(P. 478560)



**58580** Membrana carburatore **Piaggio**  
Beverly RST 125-250 2004 - 2005  
X8 - X9 Evolution - X9 Amalfi - Super Hexagon  
Hexagon GTX 2000 - 2002  
(P. CM 129701)



**58581** Membrana carburatore **Piaggio**  
Liberty 50 4T sport 2006-2007-2008  
(P. CM 146601)

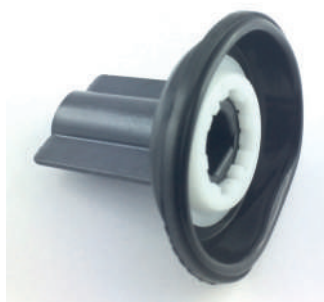

**58582** Membrana carburatore **Piaggio** Zip - Fly - 100 4T  
(P. CM 146602)



**58583** Membrana carburatore **Aprilia** Scarabeo 125-150 -200 motori **Rotax**  
(AP 8106661)



**58584** Membrana carburatore **Piaggio**  
Liberty - Vespa LX - LXV - X8 - 125-150-200  
Fly 2005-2007  
(CM 140302)



**58585** Membrana carburatore **Piaggio**  
Beverly 125-200 2001 2003  
Liberty 125-250 2001 - 2002 2004 - 2005  
X9 125 - X9 180 Amalfi - Zip 125  
(CM 140501)



**74721** Mozzo ruota anteriore - VBB2  
(P. 94534)



**74856** Mozzo ruota anteriore - Vespa 125  
VNB 5-6 1964 - 1965  
(P. 98709)



**1157715** Dinamo motore **Piaggio**  
APE CAR P2 - P3  
APE MP 500-550-600-601  
APE TM 602-703 Benzina e Diesel



**62125** Kit trasmissioni complete 9 pezzi  
Vespa 50 Special - L - N - 90

**62126** Kit trasmissioni complete 8 pezzi  
Vespa PX 125 - PX150 - P200E Prima serie



**1182356** Tappo serbatoio Piaggio Ciao PX - Grillo  
Ape 50 FL - FL2 - FL3 - 50 P



**100079 C** Alzavalvole completo Ciao - Bravo



**58604** Boccolo in graffite tubo scarico (P. 8263885)  
32 x 38 x 30,5



**58605** Boccolo in graffite tubo scarico (P. 8263885)  
38 x 35 x 25



**1472008** Pompa freno con servofreno - Piaggio Porter Quargo (P. 4720087Z01000)



**58570** Pompa freno senza servofreno - Piaggio Porter Quargo



**11386172** Serbatoio benzina (P. 1386172)  
Vespa 50 - 125 (dal 67 al 82)  
Vespa 50 S (V5SA1T dal 68 al 82)  
Vespa 50 L - R (V5A1T dal 70 al 83)  
Vespa 50 Special - Vespa 90 - 100  
Vespa 125 Primavera (VMA3T dal 67 al 83)  
Vespa 125 Primavera ET3 (VMB1T dal 76 al 83)



**12283725** Serbatoio benzina con miscelatore  
Vespa 125 T5  
Vespa PX 125 - 150 - 200



**1216624** Pulsante sportello bauletto Vespa PK (P. 216624)



**1216467** Sportello bauletto Vespa PK - S (P. 216467)

**AGENTI ITALIA****LOMBARDIA**

**Sala Simone** Cell.: 335 5948261  
Tel./Fax: 0362 561691  
simone72sala@alice.it

**PIEMONTE-LIGURIA-VALLE D'AOSTA**

**Ricardi Davide** Cell.: 347 2375412  
Fax: 011 - 9716869  
davide.ricardi@gmail.com

**VENETO - TRENTO**

**R.A.M. S.a.s.** Cell.: 329 2311831  
Tel.: 049 - 8070666  
Fax: 049 - 8074683  
ram.ricambi@libero.it

**EMILIA ROMAGNA**

**Pasqualotto Cristian** Cell.: 335 - 8333817  
Tel.: 051 - 850759  
Fax: 051 - 850759  
cristianpasqualotto@libero.it

**TOSCANA**

**Gilli Luca** Cell.: 335 - 6824646  
Tel.: 055 - 6829015  
Fax: 0187 - 418002  
gilligi@libero.it

**LAZIO**

**Ruello Massimo** Cell.: 348 - 3359299  
Tel.: 06 - 5371369  
Fax: 06 - 5371369  
massimoruello@tiscali.it

**UMBRIA**

**Olympia s.r.l.** Via Vodice, 9 - 201148 Milano  
Tel.: 02 - 4042439 - 02 48707043  
Fax: 02 - 48702440  
info@olympiamilano.it

**MARCHE - ABRUZZO - MOLISE**

**Giuliano Paradisi** Cell.: 335 - 5269383  
Fax: 071 - 7927496  
giu.paradisi@tin.it

**CAMPANIA - POTENZA**

**Capocotta Giuseppe** Cell.: 335 - 8426354  
Tel.: 081 - 7718968  
Fax: 081 - 5747956  
giuseppe.capocotta@email.it

**PUGLIA - MATERA**

**Alvisi Valerio** Cell.: 335 - 6509899  
Tel.: 080 - 5494403  
Fax: 080 - 5494403  
alvisi.valerio@gmail.com

**SICILIA - CALABRIA**

**Macri Giovanni** Cell.: 335 - 5285543  
Tel.: 095 - 7415084  
Fax: 095 - 7415084  
g.macri54@gmail.com

**SARDEGNA**

**Nurchi Fausto & Figli** Tel.: 070 - 240962  
Via dell'Artigianato, 11/4 Fax: 070 - 240958  
09122 Cagliari (CA) nurchif@tiscalinet.it

**AGENTI FRANCIA**

**Germouty Joel** Tel. uff.: 0033 - 2 - 38806336  
Cell.: 0033 - 6 - 14669040  
Fax: 0033 - 2 - 38806470  
j.germouty@wanadoo.fr

**AGENTI SPAGNA**

**Bassols Esteve** Tel. uff.: 0034 - 933716393  
Cell.: 0034 - 607222172  
Fax: 0034 - 933716393  
estev.bassols@telefonica.net

## NOTE

olympia

# NOTE

---

---

---

---

---

---

---

---

---

---

---

---

---

---

---

---

---

---

---

---

---

---

---

---

---

---

---

---

---

---







**OLYMPIA s.r.l.**

20148 Milano - Via Vodice, 9

Tel. 02 4042439 - 02 48707043

Fax 02 48702440

E-mail: [olymilan@tin.it](mailto:olymilan@tin.it)

[www.olympiamilano.it](http://www.olympiamilano.it)