

SUPPORTO
VENDITA
2019



LAMPA[®]
ACCESSORIES



INDICE

index:

Pall-Box / Promo-Box p. **1**

Scaffali a Doghe
Slat Panels Display Racks p. **2**

Scaffali Forati
Pegboard Display Racks p. **4**

Scaffali Rotanti
Spinner Display Racks p. **10**

Ripiani per scaffali
Shelves For Display Racks p. **16**

Barre orizzontali ed accessori
Cross bars and accessories p. **18**

Ganci per Scaffali
Display Racks Hooks p. **20**

Accessori per Scaffali
Display Racks Accessories p. **22**

Espositori
Displays p. **28**

Promozionale
Promo p. **44**

Abbigliamento
Wear p. **54**

PROMO BOX-1

PROMO-BOX - 1 - BALCONCINO

Indicato per prodotti di piccole e medie dimensioni

PROMO-BOX - 1 - TRAYS

Best for promotion display of small and medium size products

99060

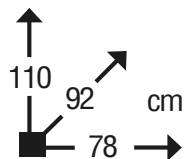

ASSORTIMENTO

Ogni promo box può contenere fino a 12 diverse tipologie di prodotto.

ASSORTMENT

Each display can contain up to 12 different references of product.

MODULARITÀ

Ogni balconcino può essere utilizzato intero oppure frazionato in 2 o 3 compartimenti

MODULAR

Each tray can be used for a single product or can be split into 2 or 3 to contain different items.

VERSATILITÀ

I promo-box si possono affiancare per formare una schiera continua oppure posizionare schiena contro schiena per un'esposizione su 2 fronti.

FLEXIBILITY

Promo-Boxes can be placed next to each other to create a highly effective display aisle or back-to-back to form a promotion island.

SEMPLICITÀ

Montaggio con solo 6 movimenti

SIMPLE

Easy and quick to assemble. Display is ready in just 6 steps.



Espositore fornito senza prodotti
Display supplied empty without products



PRONTO

Ogni box contiene al suo interno la merce già sistemata nei balconcini, pronta alla vendita.

QUICK

Every box contains 4 trays already filled with products, ready for sale.

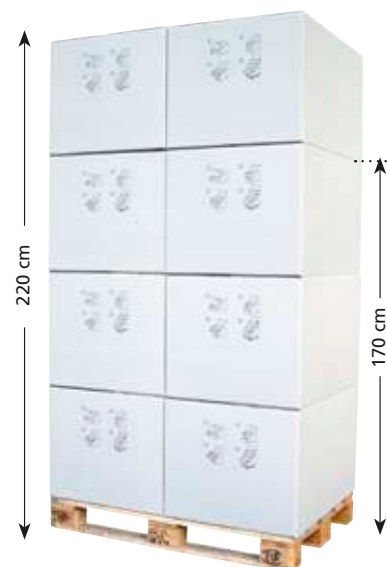

MINIMO INGOMBRO

Un europallet 120x80 cm può portare fino a 6/8 boxes (in assetto spedizione)

COMPACT SIZE

When packed, one euro-pallet can carry up to 6/8 boxes

PALL BOX-2

PALL-BOX - 2

Indicato per prodotti di medie e grandi dimensioni

PALL-BOX - 2

Best for promotion display of medium and large size products

99065

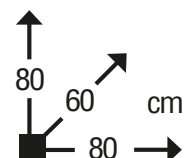

Espositore fornito senza prodotti

Display supplied empty without products

- Dimensioni 60x80 cm per posizionamento di 2 pezzi su un europallet 80x120cm.
- Fornito piegato, completo di base interna per appoggio prodotti, di 2 separatori e di crowner.
- Semplice e veloce, da assemblare direttamente sul punto vendita.
- Modularità: Il singolo comparto da 60x80 cm può essere utilizzato intero oppure frazionato in 4 compartimenti.

- Size cm 60x80.
- 2 pieces can fit on one euro-pallet.
- Supplied folded, complete with base, 2 inside walls and crowner.
- Easy and quick to assemble in the store.
- Modular system: the single 60x80 cm can be split into 4 smaller trays.

D1

SCAFFALE MODULARE A DOGHE D1 - 210 CM

- Monofronte
- Testata a filo
- Indicato per montaggio a parete
- Ripiani posizionabili fino a estremità montante alto

SLAT PANELS MODULAR DISPLAY RACK D1 - 210 CM

- Single face display
- On board logo panel
- Suitable for wall fitment
- Shelves can be moved up to the top end of the pillars



MODULARE
MODULAR

LATO
SIDE

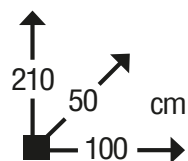

**Composto da:
Consisting of:**

KIT PANNELLI A DOGHE ED ACCESSORI

Con 1 ripiano

SLATS PANELS AND ACCESSORIES KIT

With 1 shelf

99266



COPPIA MONTANTI - 210 CM PAIR OF PILLARS - 210 CM

98995

D2

SCAFFALE ANGOLARE A DOGHE D2 - 210 CM

- Monofronte
- Testata a filo

SLAT PANELS ANGULAR DISPLAY RACK D2 - 210 CM

- Single face display
- On board logo panel



MODULARE
MODULAR



SINGOLO
STAND-ALONE

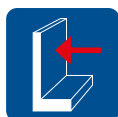
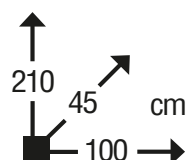

LATO
SIDE



**Composto da:
Consisting of:**

KIT PANNELLI A DOGHE ED ACCESSORI

Con 1 ripiano

SLATS PANELS AND ACCESSORIES KIT

With 1 shelf

99269

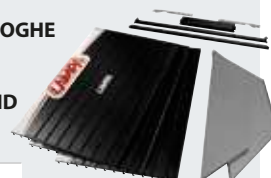

**Solo per versione singolo
Only for stand-alone version**

COPPIA MONTANTI - 210 CM PAIR OF PILLARS - 210 CM

98995



COPPIA PIEDI BASE 2 FEET

99032



Se lo scaffale angolare viene utilizzato in modo singolo, (senza alcun collegamento ad uno scaffale laterale), i 2 montanti dello scaffale devono essere tassativamente fissati alla parete tramite tasselli al fine di garantire una adeguata stabilità e maggiore sicurezza.

If the corner rack is installed as "stand alone" (without any connection to the side racks), the 2 pillars must be secured against the wall using specific wall plugs to guarantee proper stability and added safety.

D3

SCAFFALE MODULARE A DOGHE D3 - 210 CM

- Monofronte
- Testata a filo
- Indicato per montaggio a parete
- Ripiani posizionabili fino a estremità montante alto

SLAT PANELS MODULAR DISPLAY RACK D3 - 210 CM

- Single face display
- On board logo panel
- Suitable for wall fitment
- Shelves can be moved up to the top end of the pillars



MODULARE
MODULAR

1 LATO
SIDE

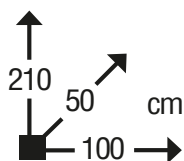

ARGENTO
METALLIZZATO
METALLIC SILVER

Composto da:
Consisting of:

KIT PANNELLI A DOGHE ED ACCESSORI
Con 1 ripiano

SLATS PANELS AND ACCESSORIES KIT
With 1 shelf

99267



COPPIA MONTANTI - 210 CM
PAIR OF PILLARS - 210 CM

N98995

D4

SCAFFALE ANGOLARE A DOGHE D4 - 210 CM

- Monofronte
- Testata a filo

SLAT PANELS ANGULAR DISPLAY RACK D4 - 210 CM

- Single face display
- On board logo panel



MODULARE
MODULAR



SINGOLO
STAND-ALONE

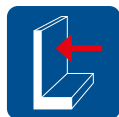
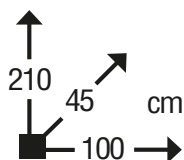

1 LATO
SIDE



ARGENTO
METALLIZZATO
METALLIC SILVER

Composto da:
Consisting of:

**KIT PANNELLI A DOGHE
ED ACCESSORI**
Con 1 ripiano

**SLATS PANELS AND
ACCESSORIES KIT**
With 1 shelf

99270

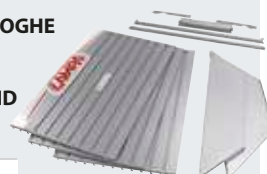

Solo per versione singolo
Only for stand-alone version

COPPIA MONTANTI - 210 CM
PAIR OF PILLARS - 210 CM

N98995



COPPIA PIEDI PER BASE
2 FEET

N99025



Se lo scaffale angolare viene utilizzato in modo singolo, (senza alcun collegamento ad uno scaffale laterale), i 2 montanti dello scaffale devono essere tassativamente fissati alla parete tramite tasselli al fine di garantire una adeguata stabilità e maggiore sicurezza.

If the corner rack is installed as "stand alone" (without any connection to the side racks), the 2 pillars must be secured against the wall using specific wall plugs to guarantee proper stability and added safety.

F1

SCAFFALE MODULARE FORATO F1 - 210 CM

- Monofronte
- Testata a filo
- Indicato per montaggio a parete
- Ripiani posizionabili fino a estremità montante alto

PEGBOARD MODULAR DISPLAY RACK F1 - 210 CM

- Single face display
- On board logo panel
- Suitable for wall fitment
- Shelves can be moved up to the top end of the pillars



MODULARE
MODULAR

1 LATO
SIDE

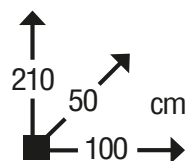

Composto da:
Consisting of:

KIT PANNELLI E ACCESSORI
Con 2 ripiani

PANELS AND ACCESSORIES KIT
With 2 shelves

99011



COPPIA MONTANTI - 210 CM
PAIR OF PILLARS - 210 CM

98995



F2

SCAFFALE MODULARE FORATO F2 - 210 CM

- Bifronte
- Indicato per montaggio in corsia centrale o ad isola

PEGBOARD MODULAR DISPLAY RACK F2 - 210 CM

- Double face display
- Suitable for aisle

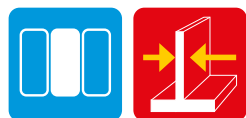

MODULARE
MODULAR

2 LATI
SIDES

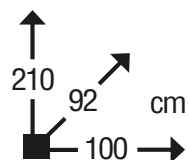

Composto da:
Consisting of:

KIT PANNELLI E ACCESSORI
Con 4 ripiani

PANELS AND ACCESSORIES KIT
With 4 shelves

98996



COPPIA MONTANTI - 210 CM
PAIR OF PILLARS - 210 CM

98995



F3

SCAFFALE MODULARE FORATO F3 - 210 CM

- Monofronte
- Testata a sbalzo
- Indicato per montaggio a parete

PEGBOARD MODULAR DISPLAY RACK F3 - 210 CM

- Single face display
- Pop out logo panel
- Suitable for wall fitment



MODULARE
MODULAR

1 LATO
SIDE

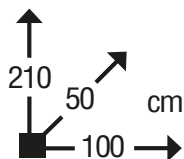

Composto da:
Consisting of:

KIT PANNELLI E ACCESSORI Con 1 ripiano

PANELS AND ACCESSORIES KIT
With 1 shelf

99012



COPPIA MONTANTI - 210 CM PAIR OF PILLARS - 210 CM

98995

F4

SCAFFALE ANGOLARE FORATO F4 - 210 CM

- Monofronte
- Testata a filo

PEGBOARD ANGULAR DISPLAY RACK F4 - 210 CM

- Single face display
- On board logo panel



MODULARE
MODULAR



SINGOLO
STAND-ALONE

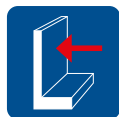
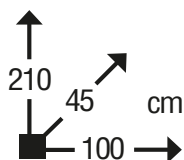

1 LATO
SIDE



Composto da:
Consisting of:

KIT PANNELLI E ACCESSORI Con 2 ripiani

PANELS AND
ACCESSORIES KIT
With 2 shelves

98998



Solo per versione singolo
Only for stand-alone version

COPPIA PIEDI BASE 2 FEET

99032

COPPIA MONTANTI - 210 CM PAIR OF PILLARS - 210 CM

98995



Se lo scaffale angolare viene utilizzato in modo singolo, (senza alcun collegamento ad uno scaffale laterale), i 2 montanti dello scaffale devono essere tassativamente fissati alla parete tramite tasselli al fine di garantire una adeguata stabilità e maggiore sicurezza.

If the corner rack is installed as "stand alone" (without any connection to the side racks), the 2 pillars must be secured against the wall using specific wall plugs to guarantee proper stability and added safety.

F5

SCAFFALE MODULARE FORATO
F5 - 210 CM

- Monofronte
- Testata a filo
- Indicato per montaggio a parete
- Ripiani posizionabili fino a estremità montante alto

PEGBOARD MODULAR DISPLAY RACK
F5 - 210 CM

- Single face display
- On board logo panel
- Suitable for wall fitment
- Shelves can be moved up to the top end of the pillars

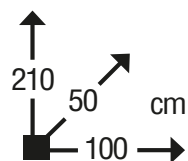

Composto da:
Consisting of:

KIT PANNELLI FORATI ED ACCESSORI
Con 2 ripiani
HOLES PANELS AND ACCESSORIES KIT
With 2 shelves

99265



COPPIA MONTANTI - 210 CM
PAIR OF PILLARS - 210 CM

N98995

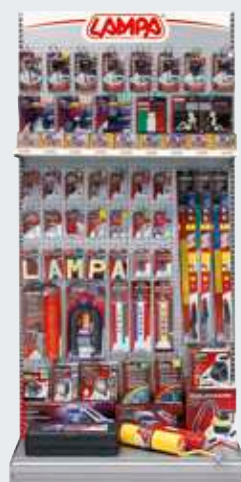

F6

SCAFFALE ANGOLARE FORATO
F6 - 210 CM

- Monofronte
- Testata a filo

PEGBOARD ANGULAR DISPLAY RACK
F6 - 210 CM

- Single face display
- On board logo panel

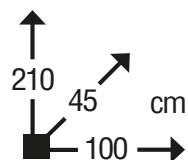

Composto da:
Consisting of:

KIT PANNELLI FORATI ED ACCESSORI
Con 2 ripiani
HOLES PANELS AND ACCESSORIES KIT
With 2 shelves

99268

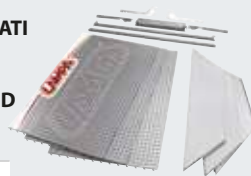

Solo per versione singolo
Only for stand-alone version

COPPIA MONTANTI - 210 CM
PAIR OF PILLARS - 210 CM

N98995



COPPIA PIEDI PER BASE
2 FEET

N99025



Se lo scaffale angolare viene utilizzato in modo singolo, (senza alcun collegamento ad uno scaffale laterale), i 2 montanti dello scaffale devono essere tassativamente fissati alla parete tramite tasselli al fine di garantire una adeguata stabilità e maggiore sicurezza.

If the corner rack is installed as "stand alone" (without any connection to the side racks), the 2 pillars must be secured against the wall using specific rawplugs to guarantee proper stability and added safety.

F7

SCAFFALE MODULARE FORATO F7 - 210 CM

- Monofronte
- Testata a filo
- Indicato per montaggio a parete
- Ripiani posizionabili fino a estremità montante alto

PEGBOARD MODULAR DISPLAY RACK F7 - 210 CM

- Single face display
- On board logo panel
- Suitable for wall fitment
- Shelves can be moved up to the top end of the pillars

NORDRIVE® series



MODULARE
MODULAR

1 LATO
SIDE

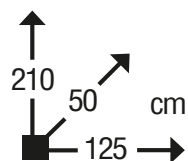

ARGENTO
METALLIZZATO
METALLIC SILVER

Composto da: Consisting of:

KIT PANNELLI E ACCESSORI

Con 2 ripiani

PANELS AND ACCESSORIES KIT

With 2 shelves

N99011



COPIA MONTANTI - 210 CM PAIR OF PILLARS - 210 CM

N98995



F8

SCAFFALE ANGOLARE FORATO F8 - 210 CM

- Monofronte
- Testata a filo

PEGBOARD ANGULAR DISPLAY RACK F8 - 210 CM

- Single face display
- On board logo panel

NORDRIVE® series



MODULARE
MODULAR



SINGOLO
STAND-ALONE

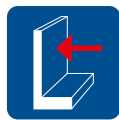
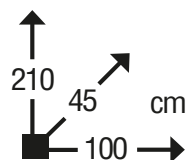

1 LATO
SIDE



ARGENTO
METALLIZZATO
METALLIC SILVER

Composto da: Consisting of:

KIT PANNELLI E ACCESSORI

Con 2 ripiani

PANELS AND ACCESSORIES KIT

With 2 shelves

N99012



Solo per versione singolo Only for stand-alone version

COPIA MONTANTI - 210 CM PAIR OF PILLARS - 210 CM

N98995



COPIA PIEDI PER BASE 2 FEET

N99025



Se lo scaffale angolare viene utilizzato in modo singolo, (senza alcun collegamento ad uno scaffale laterale), i 2 montanti dello scaffale devono essere tassativamente fissati alla parete tramite tasselli al fine di garantire una adeguata stabilità e maggiore sicurezza.

If the corner rack is installed as "stand alone" (without any connection to the side racks), the 2 pillars must be secured against the wall using specific rawlplugs to guarantee proper stability and added safety.

F9

SCAFFALE MODULARE FORATO
F9 - 160 CM

- Bifronte
- Indicato per montaggio in corsia centrale o ad isola

PEGBOARD MODULAR DISPLAY RACK
F9 - 160 CM

- Double face display
- Suitable for aisle

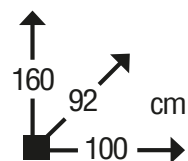

Composto da:
Consisting of:

KIT PANNELLI E ACCESSORI
PANELS AND ACCESSORIES KIT

98992



TESTATA BIFACCIALE SERIGRAFATA
HEADER DOUBLE SIDED PRINTING

98994



COPPIA MONTANTI - 142 CM
PAIR OF PILLARS - 142 CM

98990

Optional

per./for:

F9

COPPIA PANNELLI FORATI
ESTATA DI BANCO

1 lato per chiudere l'isola.

PAIR OF PEGBOARDS
FOR END UNIT

One side

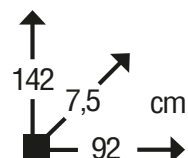

Composto da:
Consisting of:

COPPIA PANNELLI
PAIR OF PEGBOARDS

98993



COPPIA MONTANTI - 142 CM
PAIR OF PILLARS - 142 CM

98990



F10

SCAFFALE MODULARE FORATO F10 - 174 CM

- Monofronte
- Testata lineare ad incastro
- Indicato per montaggio a parete

PEGBOARD MODULAR DISPLAY RACK F10 - 174 CM

- Single face display
- Slot-in logo panel
- Suitable for wall fitment

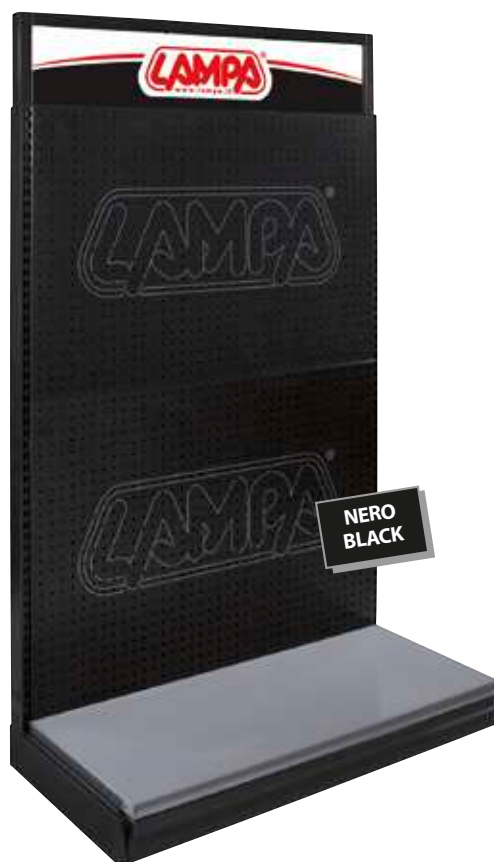
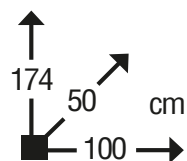
MODULARE
MODULAR1 LATO
SIDE

Composto da:
Consisting of:

KIT PANNELLI E ACCESSORI
PANELS AND ACCESSORIES KIT

99015



COPPIA MONTANTI - 142 CM
PAIR OF PILLARS - 142 CM

98990



F11

ESPOSITORE SINGOLO FORATO F11 - 167 CM

- Bifronte
- Telaio monoscocca
- Con ruote snodabili
- Facilmente mobile

PEGBOARD STAND ALONE RACK F11 - 167 CM

- Double face display
- Single chassis construction
- Casters with ball bearings
- Easily movable

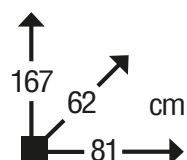
SINGOLO
STAND-ALONECON RUOTE
WITH WHEELS2 LATI
SIDES

Composto da:
Consisting of:

ESPOSITORE SINGOLO
STAND ALONE RACK

98985



TESTATA BIFACCIALE SERIGRAFATA
HEADER, DOUBLE SIDED PRINTING

98986



F12

ESPOSITORE SINGOLO - F12 - 182 CM

- Monofronte.
- Base fissa e 4 ripiani regolabili in altezza.
- Nota: per sfruttare al meglio la verticalità ed aumentare la superficie espositiva, si consiglia l'utilizzo dell'espositore con 6 ripiani (ordinare 1 ripiano supplementare art. 98987).
- Parete forata idonea anche per l'utilizzo di ganci (su fronte e retro)

STAND ALONE RACK - F12 - 182 CM

- Single face display.
- Base and 4 adjustable level shelves.
- Note: in order to optimize the verticality of the layout, we suggest to use this display with 6 shelves (order 1 additional shelf, art. 98987).
- Pegboard back panels suitable for hooks (front and back)



SINGOLO STAND-ALONE

LATO SIDE

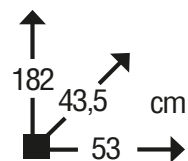

Composto da:
Consisting of:

ESPOSITORE SINGOLO

Con 4 ripiani

STAND ALONE RACK

With 4 shelves

98980



TESTATA HEADER

98981	Lampa
98982	Lampa / Turtle Wax
98983	Lampa / Carplan
98984	Lampa / Carlupe



Optional



RIPIANO AGGIUNTIVO (1 PEZZO)
ADDITIONAL SHELF (1 PIECE)

98987

R1

ESPOSITORE SINGOLO ROTANTE - R1 - 172 CM

- Quadrifacciale
- Compatto ma con ampia superficie espositiva

STAND ALONE SPINNER RACK - R1 - 172 CM

- 4 faces display
- Compact size but with large exhibiting surface

99105

Cartone / Carton 1



SINGOLO STAND-ALONE

4 LATI SIDES

ROTANTE SPINNING

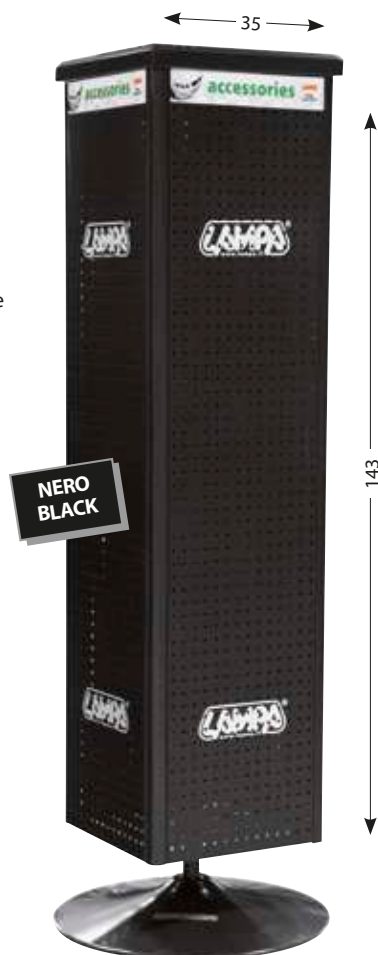
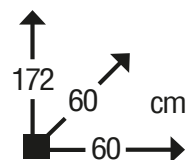

R2

ESPOSITORE SINGOLO ROTANTE - R2 - 172 CM

- Trifacciale.
- Struttura in metallo.
- Compatto ma con ampia superficie espositiva

STAND ALONE SPINNER RACK - R2 - 172 CM

- Three-sided.
- Made of metal.
- Compact size but with large exhibiting surface

99104

Cartone / Carton 1

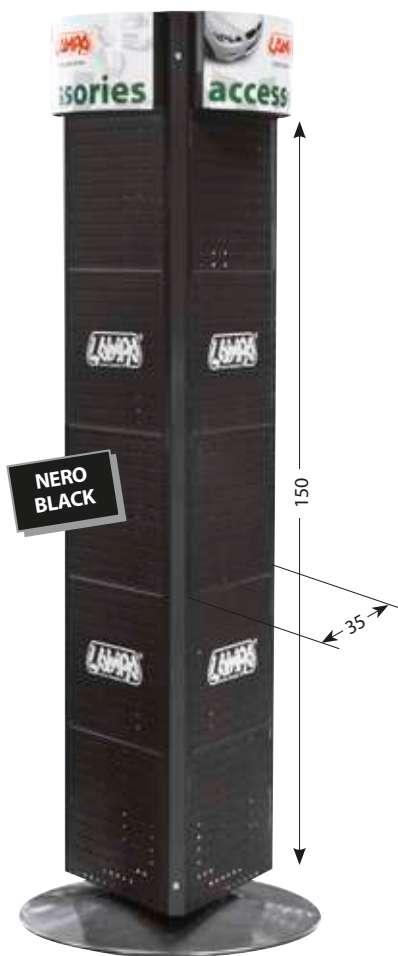
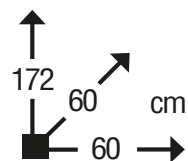

R3

ESPOSITORE SINGOLO ROTANTE - R3 - 172 CM

- Trifacciale.
- Struttura in metallo.
- Compatto ma con ampia superficie espositiva

STAND ALONE SPINNER RACK - R3 - 172 CM

- Three-sided.
- Made of metal.
- Compact size but with large exhibiting surface

99102

Cartone / Carton 1

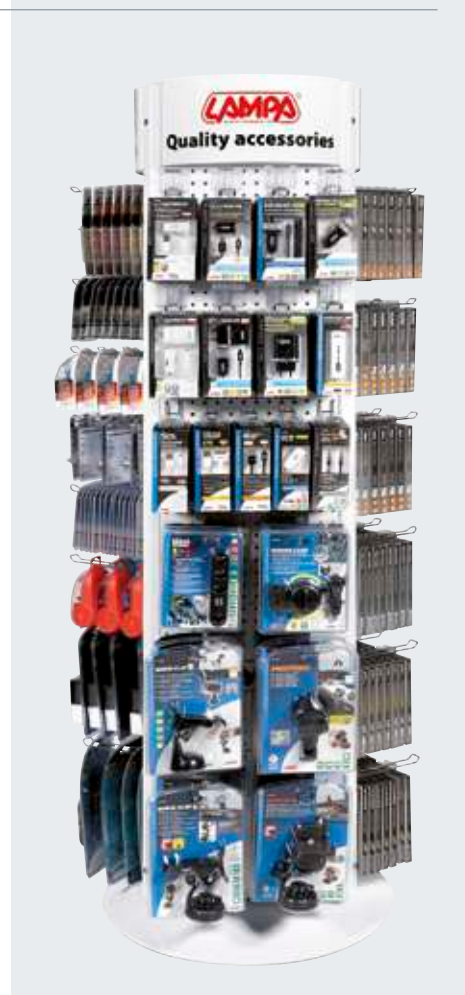
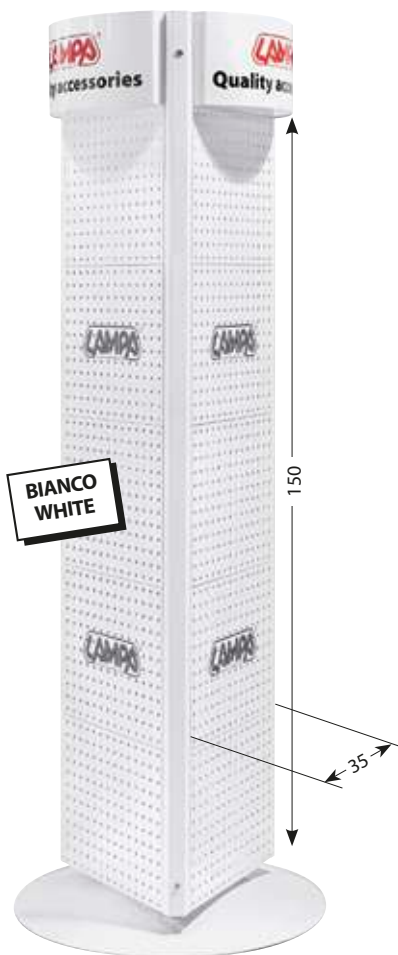
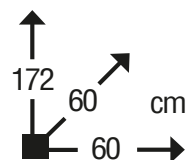

R4

ESPOSITORE SINGOLO ROTANTE - R4 - 157 CM

- Trifronte
- Rotante
- Compatto ma con ampia superficie espositiva

STAND ALONE SPINNER RACK - R4 - 157 CM

- Spinner
- Triple face display
- Compact size, but with large exhibiting surface

98999

Cartone / Carton 1

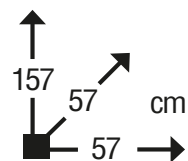

R5

ESPOSITORE SINGOLO ROTANTE - R5 - 183 CM

- Modello quadrifacciale a croce con funzione rotante
- 4 ampi pannelli espositivi in poco spazio

STAND ALONE SPINNER RACK - R5 - 183 CM

- Cross shape with 4 pegboards
- Compact size but with plenty of exhibiting space

98988

Cartone / Carton 1

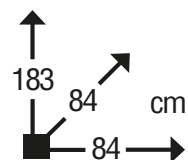

R6

ESPOSITORE SINGOLO ROTANTE - R6 - 171 CM

- Specifico per telefonia.
- 8 lati espositivi.
- Base in metallo e corpo in cartone.
- Completo di 40 ganci in plastica, lunghezza 15cm.

STAND ALONE SPINNER RACK - R6 - 171 CM

- Specific for mobile accessories.
- Eight-sided.
- Metal base and cardboard body.
- 40 plastic hooks included, 15cm length.

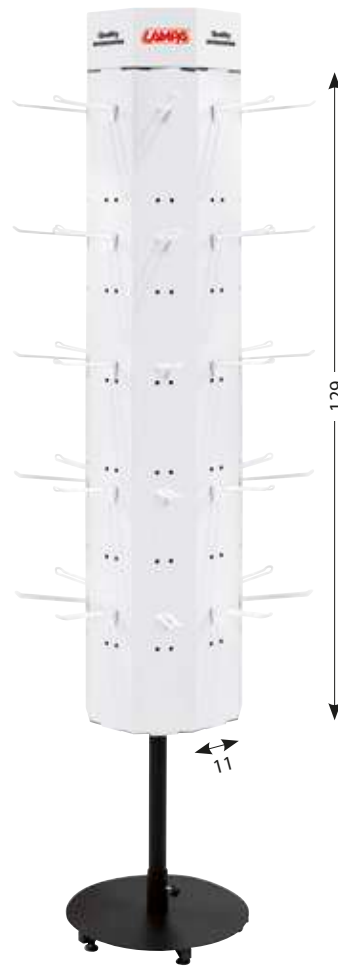
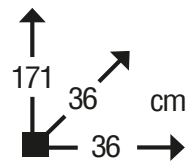

Composto da:
Consisting of:

ESPOSITORE OTTAGONALE IN CARTONE
CARDBOARD DISPLAY

99263

Cartone / Carton 1



BASE + PALO DI SUPPORTO IN METALLO
METAL SUPPORT POLE + BASE

99262

Cartone / Carton 1



S1

SCAFFALE MODULARE

In acciaio con verniciatura a polvere epossidica.
5 ripiani regolabili in acciaio.
Capacità massima di carico 100 kg per ripiano.

MODULAR DISPLAY RACK

Made of steel with epoxy powder coated.
5 adjustable steel board shelves.
Max load capacity 100 kg for shelf.

99078

 Cartone / Carton  1

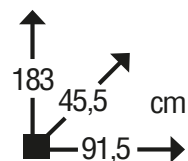
 SINGOLO
STAND-ALONE

Ripiani per Scaffali Modular display rack shelves





RIPIANO AGGIUNTIVO STEEL BOARD SHELF

99078R Per / For **S1**

 Scatola / Box  1

RIPIANO AGGIUNTIVO STEEL BOARD SHELF

99079R Per / For **S2**

 Scatola / Box  1

S2

SCAFFALE MODULARE

5 ripiani regolabili in acciaio.
Capacità massima di carico 100 kg per ripiano.
Verniciato a polvere epossidica

MODULAR DISPLAY RACK

5 adjustable steel board shelves.
Max load capacity 100 kg for shelf.
Epoxy powder coated

99079

 Cartone / Carton  1

 SINGOLO
STAND-ALONE



Ripiani per scaffali forati / Shelves for pegboard display racks

F

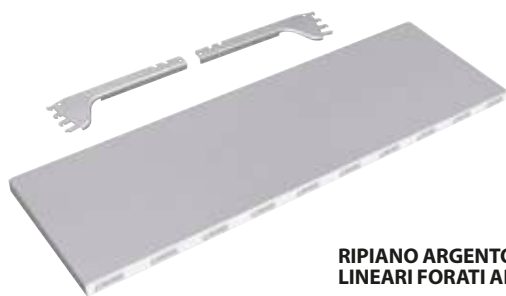

RIPIANO ARGENTO PER SCAFFALI LINEARI FORATI ARGENTO
SILVER SHELF FOR SILVER LINEAR PEGBOARD DISPLAY RACKS

Per scaffali tipo: **F5**
 Fits display racks:

99271 97x31 cm

Busta / Bag 4

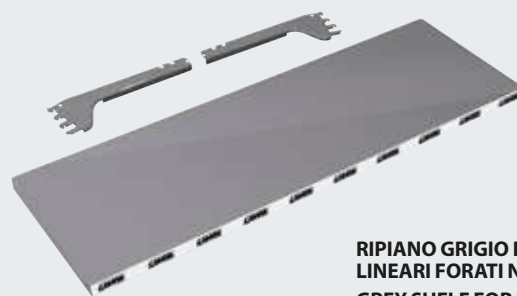

RIPIANO GRIGIO PER SCAFFALI LINEARI FORATI NERI
GREY SHELF FOR BLACK LINEAR PEGBOARD DISPLAY RACKS

Per scaffali tipo: / Fits display racks:

F1 F2 F3 F9 F10

99018 97x31 cm

Busta / Bag 4



RIPIANO ARGENTO PER SCAFFALI ANGOLARI FORATI ARGENTO
SILVER SHELF FOR SILVER ANGULAR PEGBOARD DISPLAY RACKS

Per scaffali tipo: **F6**
 Fits display racks:

99274 97x23 cm

Busta / Bag 4

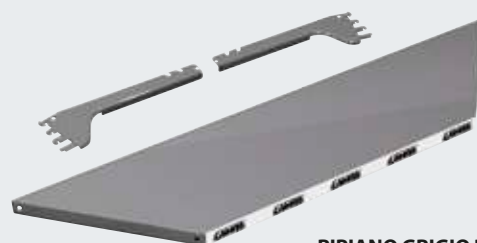

RIPIANO GRIGIO PER SCAFFALI ANGOLARI FORATI NERI
GREY SHELF FOR BLACK CORNER PEGBOARD DISPLAY RACKS

Per scaffali tipo: **F4**
 Fits display racks:

99292 97x23 cm

Busta / Bag 4

Ripiani per scaffali forati / Shelves for pegboard display racks

F7

NORDRIVE series



RIPIANO ARGENTO PER SCAFFALI LINEARI FORATI ARGENTO
SILVER SHELF FOR SILVER LINEAR PEGBOARD DISPLAY RACKS

Per scaffali tipo: **F7**
 Fits display racks:

N99015 122x31 cm

Busta / Bag 4

NORDRIVE series



BASE DA 80 CM
80 CM BASE

N99027 80x40cm

Busta / Bag 4

+

PIEDE PER BASE DA 80 CM
FOOT FOR 80 CM BASE

N99026

Busta / Bag 30

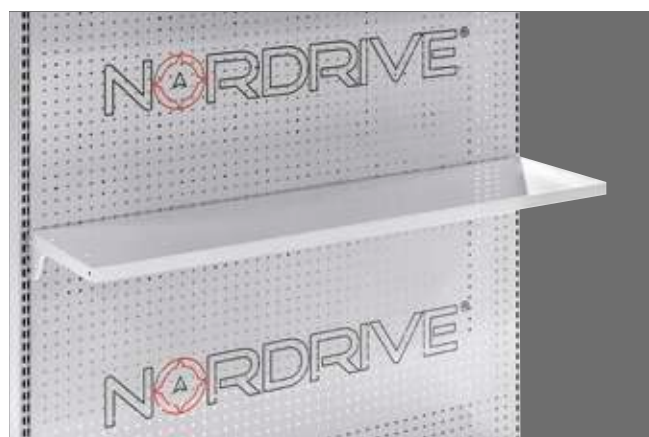

Per scaffali tipo: **F7**
 Fits display racks:

Ripiani per scaffali a doghe / Shelves for slatwall display racks

D



RIPIANO ARGENTO PER SCAFFALI LINEARI A DOGHE ARGENTO
SILVER SHELF FOR SILVER LINEAR SLATWALL DISPLAY RACKS

Per scaffali tipo: **D3**
Fits display racks:

99291 97x31 cm

Busta / Bag 4



RIPIANO GRIGIO PER SCAFFALI LINEARI A DOGHE NERI
GREY SHELF FOR BLACK LINEAR SLATWALL DISPLAY RACKS

Per scaffali tipo: **D1**
Fits display racks:

99290 97x31 cm

Busta / Bag 4



RIPIANO ARGENTO PER SCAFFALI ANGOLARI A DOGHE ARGENTO
SILVER SHELF FOR SILVER CORNER SLATWALL DISPLAY RACKS

Per scaffali tipo: **D4**
Fits display racks:

99272 97x23 cm

Busta / Bag 4



RIPIANO GRIGIO PER SCAFFALI ANGOLARI A DOGHE NERI
GREY SHELF FOR BLACK CORNER SLATWALL DISPLAY RACKS

Per scaffali tipo: **D2**
Fits display racks:

99273 97x23 cm

Busta / Bag 4

Ripiani per barre orizzontali / Cross bars shelves

NORDRIVE series



RIPIANO PER BARRA ORIZZONTALE
SHELF FOR CROSS BAR

N99056 80x35 cm

Busta / Bag 4



RIPIANO PORTA CATALOGHI PER BARRA ORIZZONTALE
CATALOGUES SHELF FOR CROSS BAR

N99060 43x29 cm

Busta / Bag 10



Barre Orizzontali per scaffali / Cross Bars for display racks

Per scaffali tipo: / Fits display racks:

F1 F2 F3 F5 F9 F10



BARRA ORIZZONTALE CROMATA
Per scaffali con pannellature forate
CHROMED CROSS BAR
For pegboard display racks

99020 97 cm

Busta / Bag 20



Max:
50 KG

Per scaffali tipo: **F7**

Fits display racks:

NORDRIVE series



BARRA ORIZZONTALE ARGENTO
Per scaffali tipo "F7"
SILVER CROSS BAR
For "F7" shelves

N99023 122 cm

Busta / Bag 20



Max:
50 KG

Per scaffali tipo: **D**

Fits display racks:

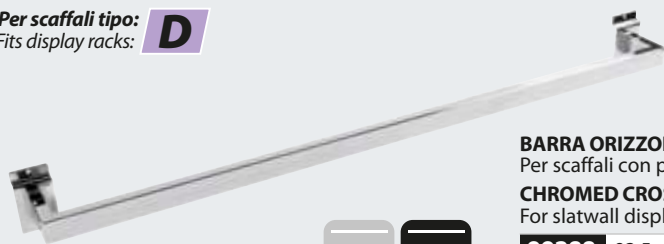

BARRA ORIZZONTALE CROMATA
Per scaffali con pannellature a doghe
CHROMED CROSS BAR
For slatwall display racks

99288 93,5 cm

Busta / Bag 20



Max:
50 KG

Accessori per barre orizzontali / Cross bars accessories

**PREDISPOSTO PER
PORTAPREZZI (Art. 99040)
PRICE HOLDER READY
(Art. 99040)**

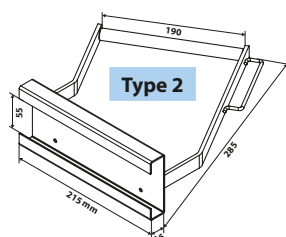
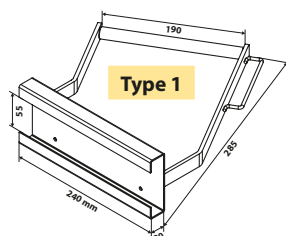

APPENDINO RINFORZATO ED INCLINATO
Indicato per tappeti, schienali o prodotti pesanti.
Con predisposizione per portaprezzi.
Colore argento. Idoneo per barre orizzontali

HEAVY DUTY INCLINED HANGER
For mats and cushions. Silver grey colour.
Price holder ready. Fits onto horizontal bars

99264 **Type 1** Universale per barre orizzontali "GDO"
Universal for **supermarket** horizontal bars

99289 **Type 2** Specifico per barre orizzontali "Lampas" (art. 99020, N99023)
Specific for **Lampas** horizontal bars (99020, N99023 items)

Scatola / Box 4

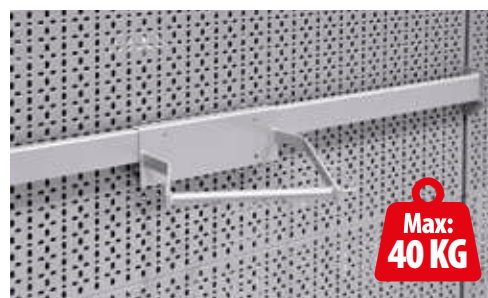

Max:
40 KG



Accessori per barre orizzontali / Cross bars accessories

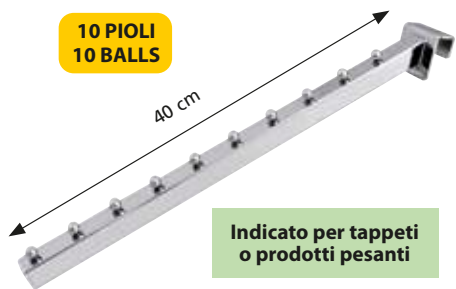

10 PIOLI
10 BALLS

40 cm

Indicato per tappeti
o prodotti pesanti

**APPENDINO CROMATO,
RINFORZATO ED INCLINATO A 10 PIOLI**
Per barre orizzontali.

**HEAVY DUTY 10 BALLS
INCLINED HANGER, CHROMED**
For cross bars

99287 40 cm

Sfuso / Bulk ☐ 50



GANCIO PORTACASCO CROMATO

Per barre orizzontali

HELMET HOLDER, CHROMED
For cross bars

99286

Sfuso / Bulk ☐ 50



**STAFFA PORTA
PNEUMATICI CICLO**
Per barre orizzontali

BICYCLE TYRE-HOLDER
For cross bars

99046 Grigio / Grey

Sfuso / Bulk ☐ 1

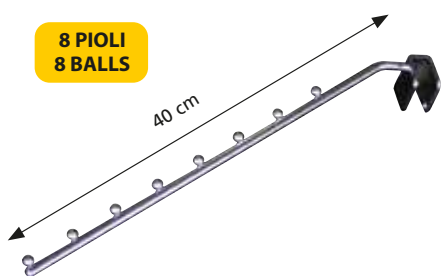

8 PIOLI
8 BALLS

40 cm

**APPENDINO CROMATO,
INCLINATO A 8 PIOLI**
Per barra orizzontale

8 BALLS INCLINED HANGER, CHROMED
For cross bar

99021 40 cm

Busta / Bag ☐ 50

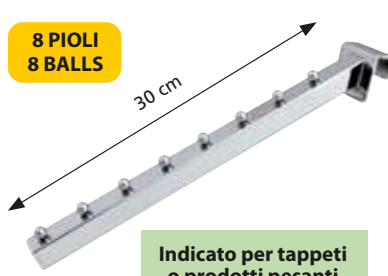

8 PIOLI
8 BALLS

30 cm

Indicato per tappeti
o prodotti pesanti

**APPENDINO CROMATO,
RINFORZATO ED INCLINATO A 8 PIOLI**
Per barra orizzontale, indicato per tappeti o
prodotti pesanti

**HEAVY DUTY 8 BALLS INCLINED HANGER,
CHROMED**
For cross bar

99026 30 cm

Busta / Bag ☐ 10 / 50

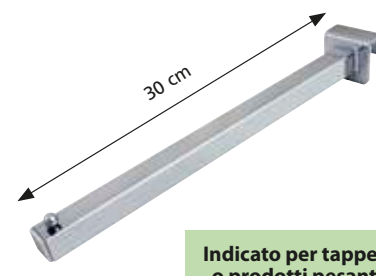

30 cm

Indicato per tappeti
o prodotti pesanti

**APPENDINO CROMATO A TUBO
ORIZZONTALE**

Per barra orizzontale, indicato per tappeti
o prodotti pesanti

**HORIZONTAL HEAVY DUTY HANGER,
CHROMED**
For cross bar

99027 30 cm

Busta / Bag ☐ 10 / 50



Ganci per scaffali forati / Hooks for Pegboard display racks

F R

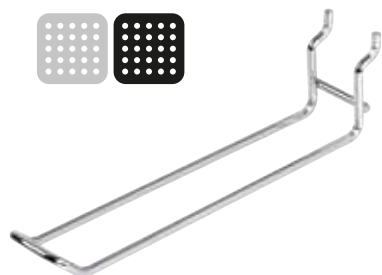

**GANCIO SICUREZZA CROMATO
DOUBLE WIRE CHROMED HOOK**

- 99030** 10 cm
- 99031** 15 cm
- 99025** 20 cm
- 99022** 30 cm

Sfuso / Bulk 25 / 200



**PREDISPOSTO PER
PORTAPREZZI (Art. 99040)
PRICE HOLDER READY
(Art. 99040)**

**GANCIO SICUREZZA CROMATO
CON PREDISPOSIZIONE PORTAPREZZI
DOUBLE WIRE CHROMED HOOK
WITH PRICE HOLDER FITTING**

- 99033** 10 cm
- 99034** 15 cm
- 99035** 20 cm
- 99036** 30 cm

Sfuso / Bulk 10 / 100



PORTAPREZZO
Per ganci con predisposizione.
Cartellino non incluso

PRICE HOLDER
For hooks with price holder fitting. Price tag not included

99040 6x4 cm
Sfuso / Bulk 20 / 4000

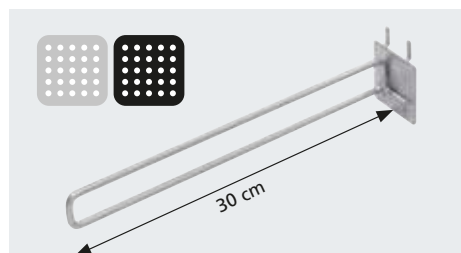

SEPARATORE, 30 CM

Attacco su pannelli forati. Indicato per esposizione verticale di barre portatutto.

SEPARATOR HANGER, 30 CM

Fixing on perforated panels. Suitable for standing roof bars boxes vertically.

N99039 30 cm Grigio / Grey

Busta / Bag 100

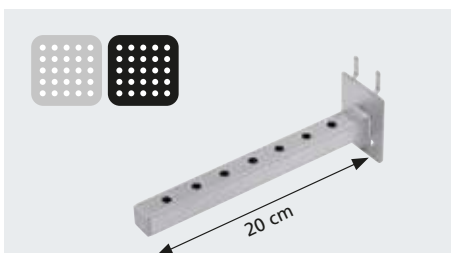

APPENDINO ORIZZONTALE, 20 CM

Attacco su pannelli forati. Indicato per esposizione orizzontale di barre portatutto sfuse.

HORIZONTAL HANGER, 20 CM

Fixing on perforated panels. Suitable for displaying bulk roof bars horizontally.

N99020 20 cm Grigio / Grey

Busta / Bag 30

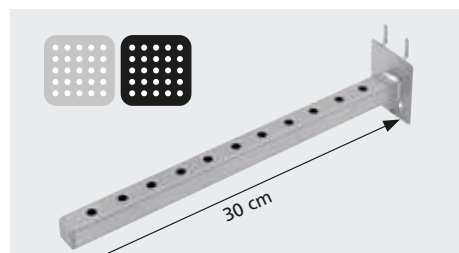

APPENDINO ORIZZONTALE, 30 CM

Attacco su pannelli forati. Indicato per esposizione orizzontale di barre portatutto sfuse.

HORIZONTAL HANGER, 30 CM

Fixing on perforated panels. Suitable for displaying bulk roof bars horizontally.

N99021 30 cm Grigio / Grey

Busta / Bag 30



COLLARE PORTABARRE CHIUSO

Indicato per esposizione verticale di barre portatutto confezionate.

CLOSED COLLAR

Fixing on perforated panels. Suitable for vertical display of the roof bars boxes

N99043 38x38 cm Grigio / Grey

Busta / Bag 5

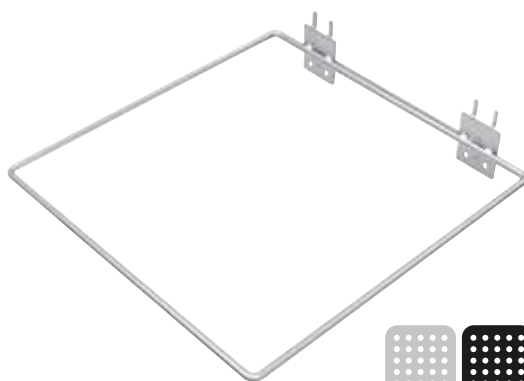

Ganci per scaffali a doghe / Hooks for Slatwall display racks

D



**GANCIO SICUREZZA CROMATO
CON PREDISPOSIZIONE PORTAPREZZI**

Per pannelli a doghe

**DOUBLE WIRE CHROMED HOOK
WITH PRICE HOLDER FITTING**

For slats panels

99280	10 cm
99281	15 cm
99282	20 cm
99283	30 cm
99284	40 cm

**PREDISPOSTO PER
PORTAPREZZI (Art. 99040)
PRICE HOLDER READY
(Art. 99040)**

Sfuso / Bulk 10 / 50



**GANCIO SICUREZZA CROMATO
Per pannelli a doghe**

DOUBLE WIRE CHROMED HOOK
For slats panels

99275	10 cm
99276	15 cm
99277	20 cm
99278	30 cm

Sfuso / Bulk 10 / 100



GANCIO PORTACASCO
Per pannelli a doghe

HELMET HOLDER
For slats panels

99285

Sfuso / Bulk 10 / 50





**NERO
BLACK**



TESTATA A SBALZO
Con stampa serigrafica
POP OUT LOGO PANEL
With printed logos

98997

Cartone / Carton 1

Per scaffali tipo: / Fits display racks:

F1 F2 F3 F5
D1 D3

4
pcs



Max:
180 KG
4 ruote/wheels

SET 4 RUOTE STANDARD
SET 4 STANDARD WHEELS

99019 Ø 50 mm

Cartone / Carton 10

Per scaffali tipo: / Fits display racks:

F1 F2 F3 F5 F7 F9
F10 D1 D3 R4 R5

1
pc



Max:
70 KG
1 ruota/wheel

RUOTA MAXI CON FRENO
HEAVY DUTY WHEEL
WITH BRAKE

99047 Ø 75 mm

Busta / Bag 20

Per scaffali tipo: / Fits display racks:

F1 F2 F3 F5 F7 F9
F10 D1 D3 R4 R5



**Senza fori
No holes**

**NERO
BLACK**

**KIT TAMPONAMENTO
POSTERIORE**

Senza fori, indicato quando la schiena è visibile, es. esposizione contro parete con vetro

BACK PANELS KIT

Without holes, specific for using when the back of shelf is visible, such as back facing windows.

99016



Per scaffali tipo: / Fits display racks:

D1 D3 F1 F3 F5





TESTATA A SBALZO RETROILLUMINATA, 230V
Per scaffali lineari. Stampa intercambiabile. Illuminazione a Led frontale e verso l'esposizione dei prodotti sottostanti

POP OUT LOGO BACKLIGHT PANEL, 230V
For linear display racks. With interchangeable printed panel. Includes light projection onto pegboard display panel. Led light

99293	Nero	Black
99294	Argento	Silver

Cartone / Carton 1

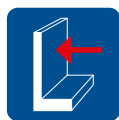

1 LATO SIDE

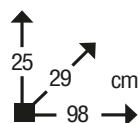

Per scaffali tipo: / Fits display racks:

F1 F2 F3 F5
D1 D3



Luce frontale e verticale
Front and vertical light



100-230 V	900 mm LED Light
6500° K	14 W

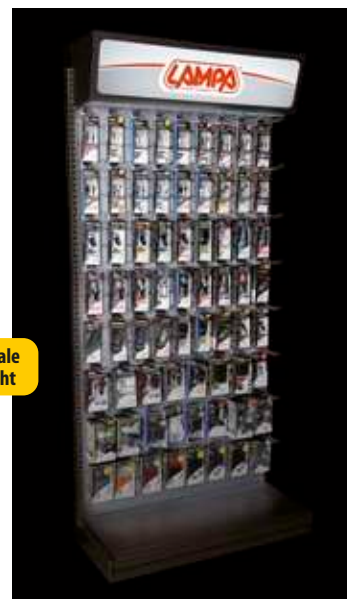

TESTATA SLIM RETROILLUMINATA, 230V
Per scaffali lineari. Stampa intercambiabile. Illuminazione a Led

SLIM LOGO BACKLIGHT PANEL, 230V
For linear display racks. With interchangeable printed panel. Led light

99297	Nero	Black
99298	Argento	Silver

Cartone / Carton 1

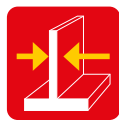

2 LATI SIDES

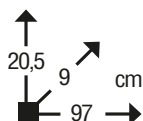

Per scaffali tipo: / Fits display racks:

F1 F2 F3 F5
D1 D3



Luce frontale e sul retro
Front and rear light



100-230 V	900 mm LED Light
6500° K	14 W





Appositamente studiati per illuminare i prodotti esposti sui display
Especially designed to light up Products shown on a display



STRISCIA ELETTRICA ADESIVA, 12/24V
Per espositori dimostrativi
Cavo 200 cm

**ADHESIVE QUICK CONNECT
12/24V POWER STRIP**
For demo displays
Cable 200 cm

98989 90 cm

Scatola / Box 50

Per scaffali tipo: / Fits display racks:
**F1 F2 F3 F4 F5
F6 F7 F8 F9 F11**



**BASE ADESIVA
ADHESIVE BASE**

IN	12/24V	Cavo 200 cm
OUT	9x 12/24V	Morsetti 1 A

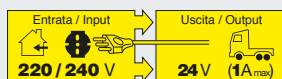

TRASFORMATORE 230>24V, 5A
Per strisce elettriche Art. 98989
POWER ADAPTER 230>24V, 5A
For adhesive power strips
Art. 98989

99029

Scatola / Box 10

IN	230V
OUT	2x 24V Morsetti 5 A



Attenzione: prodotto per installazioni professionali.
Non idoneo per altri utilizzi. Maneggiare con cura e tenere lontano dalla portata dei bambini.

Note: for professional use only. Not suitable for other uses.
Handle with care and keep out of the reach of children.



BLOCCO ANTITACCHEGGIO SCORREVOLE CON CHIAVE
FLAT TYPE ANTI-THEFT LOCK WITH KEY

99084

Sfuso / Bulk 50 / 500

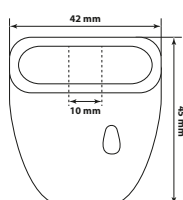

BLOCCO ANTITACCHEGGIO MAGNETICO "KEY-LESS"
"KEY-LESS" MAGNETIC LOCK

99082

Sfuso / Bulk 20



CHIAVE MAGNETICA PER SBLOCCO ANTITACCHEGGIO "KEY-LESS" ART. 99082
MAGNETIC KEY FOR "KEY-LESS" LOCKS ART. 99082

99083

Sfuso / Bulk 1

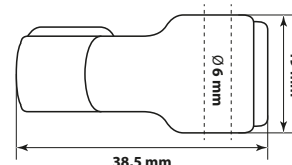

CARTELLINO FINE GANCIO ORIGINAL ARTICLE CARD

99100

DOUBLE-FACE



CARTELLINO FINE GANCIO E CARTELLINO PREZZI END UNIT TAG FOR HOOK AND PRICE TAG

99103 70x120 mm

Sfuso / Bulk 200

PREZZO PRESTAMPATO
 Personalizzabile cancellando i caratteri tramite una penna nera
UNIVERSAL DIGITS
 By using a black pen, erase the proper links to form the desired price



2 in 1 **DOPPIO UTILIZZO**
DOUBLE USE



KIT 50 PZ - ASOLA PORTA PREZZI
50 PCS KIT - BUTTONHOLE PRICE HOLDER

99260

Busta / Bag 40

+



=



KIT 50 PZ - ADESIVO CON PREZZO
50 PCS KIT - ADHESIVE WITH PRICE

99261

Busta / Bag 400



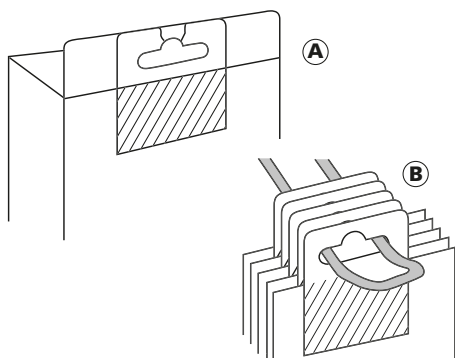

ASOLA ADESIVA, 100 PZ
Per applicazione al prodotto
o per riparazione

SELF-ADHESIVE HANG TAB, 100 PCS
To repair and/or reinforce

99096

Busta / Bag 120

100
pcs

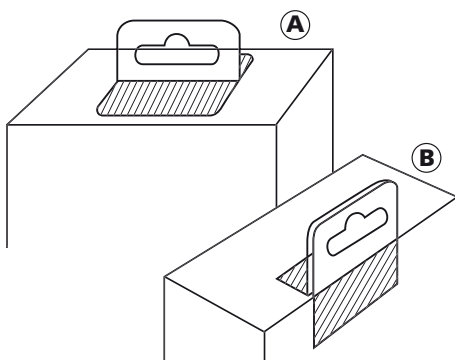

DOPPIA ASOLA ADESIVA, 100 PZ
In PET, 1100 g max

**ADHESIVE SADDLE HANG TABS,
100 PCS**
1100 g max

99098

Busta / Bag 40

100
pcs

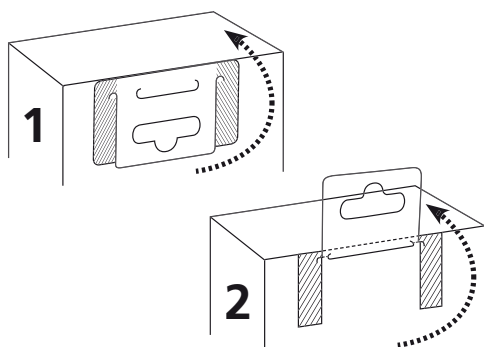

**ASOLA ADESIVA PIEGHEVOLE,
100 PZ**
In PET, 500 g max

FOLDING HANG-UP, 100 PCS
500 g max

99099

Busta / Bag 120

100
pcs

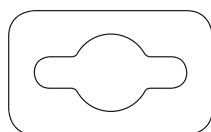

**ADESIVO PER RINFORZO O
RIPARAZIONE ASOLE DIN, 100 PZ**
**ADHESIVE REINFORCING OR
REPAIR TAB, 100 PCS**

99101

Busta / Bag 40

100
pcs



**STRISCIA CAVALIERE
ADESIVA, 100 PZ**
450 g max

FLEXI WOBBLER, 100 PCS
450 g max

99097 230x15 mm

Busta / Bag 10

100
pcs



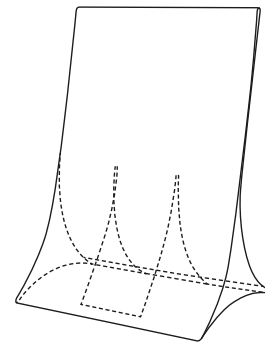

**ESPOSITORE PER DEPLIANT
STANDING LEAFLET HOLDER**

99093	A4 (210x297 mm)	Busta / Bag	25
99094	A5 (148x210 mm)	Busta / Bag	20

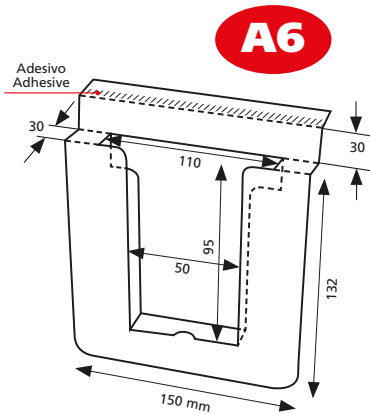
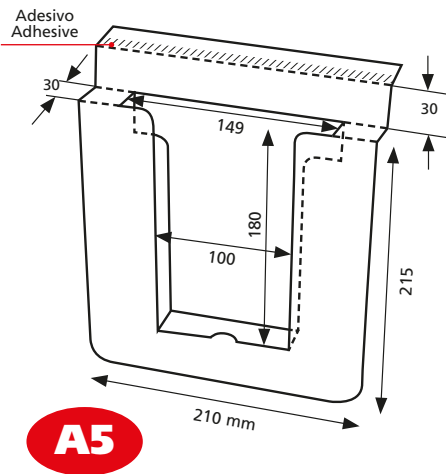

**10
pcs**

**PORTA DEPLIANT DA RIPIANO, 10 PZ
LEAFLET HOLDER FOR SHELF, 10 PCS**

99085	A5 (148x210 mm)	Busta / Bag	20
99086	A6 (105x148 mm)	Busta / Bag	20



STRISCIA ESPOSITIVA VERTICALE, 10 PZ

90 cm, 18 asole

VERTICAL CLIP STRIP, 10 PCS

90 cm, 18 slots

99089

Sfuso / Bulk 50

**10
pcs**

**GANCIO PER STRISCIA
ESPOSITIVA, 10 PZ**

**METAL HOOK FOR VERTICAL CLIP
STRIP, 10 PCS**

99088

Busta / Bag 400

**10
pcs**





18 COPPIE
18 PAIRS

Espositori
forniti senza
prodotti
Displays
supplied empty
without
products

**ESPOSITORE CALZE DA
NEVE AUTOSOCK
DISPLAY FOR AUTOSOCK**

- 99070** 6 coppie
- 99071** 18 coppie



6 COPPIE
6 PAIRS



**ESPOSITORE CATENE
Per 44 valigette auto o 40
valigette furgone
DISPLAY RACK
Holds 44 boxes (car-chains) or
40 boxes (van-chains)**

99076



ESPOSITORE SPAZZOLE TERGICRISTALLO

Completo di 24 ganci.
Esposizione a tre livelli circa 120 confezioni

DISPLAY STAND FOR WIPER BLADES

Supplied with 24 hooks.
Holds approximately 120 packs.
Three level display

99505	Gruppo A	cm 56x30x159
99506	Gruppo B	cm 61,5x30x159

Cartone 1

Espositori
forniti senza
prodotti

Displays
supplied empty
without
products



1
LATO
SIDE

CARRELLLO ESPOSITORE SPAZZOLE TERGICRISTALLO

Con ruote, completo di ganci.
Esposizione a due livelli su due fronti per circa 190 confezioni

WHEELED DISPLAY STAND FOR WIPER BLADES

Supplied with hooks. Holds approximately 190 packs. Two level display on both fronts

99051	cm 65x45x168
--------------	--------------

Cartone 1



2
LATI
SIDES

Gruppo A



Per/Fit:
Skylon, Raptor, Gran pree (1pz), Premium Top, Refill, Spazzole tradizionali (1pz) / Standard Wiper Blade (1pz)

Gruppo B

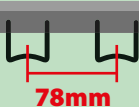

Per/Fit:
Gran Pree (2pz), Pilot Spazzole Standard (1pz) / Standard Wiper Blade (1pz), Bracci Spazzolanti / Wiper Arm and Blade



ESPOSITORE TAPPETI A COLONNA A DUE LIVELLI
DOUBLE LEVEL COLUMN
DISPLAY STAND FOR MATS

99008 75x75x207 cm

Cartone / Carton 1

Espositori
forniti senza
prodotti
Displays
supplied empty
without
products



ESPOSITORE STANDARD
CON RUOTE PER TAPPETI
MATS DISPLAY STAND ON WHEELS

99007 105x45x155 cm

Cartone / Carton 1



ESPOSITORE TAPPETI A COLONNA 1 LIVELLO
SINGLE LEVEL COLUMN
DISPLAY STAND FOR MATS

99009 75x75x121 cm

Cartone / Carton 1

ESPOSITORE CON RUOTE
PER 3 BOX TETTO
WHEELED DISPLAY RACK
FOR 3 BOXES

N60030



1
LATO
SIDE



235

Espositori
forniti senza prodotti
Displays supplied empty
without products



DISPLAY ESPOSITORE DA BANCO
PER 10 CONFEZIONI MCGARD
COUNTER DISPLAY FOR 10 MCGARD BLISTER

MG90216



DISPLAY ESPOSITORE DA BANCO
PER 24 CONFEZIONI MCGARD
COUNTER DISPLAY FOR 24
MCGARD BLISTER

MG90217



SET LOCANDINA DA BANCO PRIVACY
- 2 tendine a forma di piedestallo
- 1 tasca porta volantini
- 100 volantini prodotto formato A2
PRIVACY POS COUNTER DISPLAY
- 2 sunshade-type stands
- 1 leaflet pocket
- 100 printed leaflets

99171

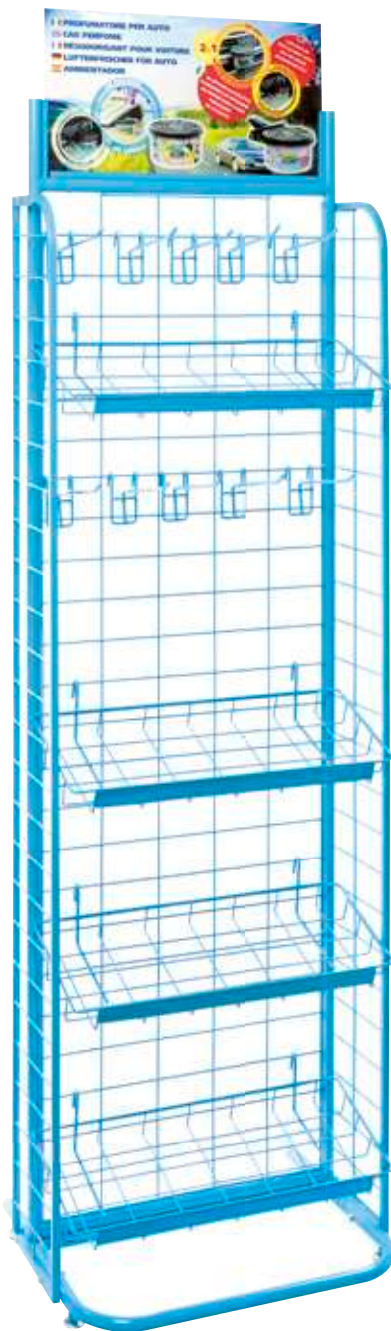

**Espositori
forniti senza
prodotti**

**Displays
supplied empty
without
products**

Esempio di esposizione:
Loading type:

96 Magic-Cup
+
40 Magic-Cup
Vent-clip

**ESPOSITORE DA PAVIMENTO,
DEODORANTI "MAGIC-CUP"**
Fornito senza prodotti.
Telaio in metallo

**FLOOR DISPLAY "MAGIC CUP"
AIR-FRESHENERS**
Supplied empty without products.
Metal frame

35370 48x36x171cm

Cartone / Carton ☐ 1



**Su 2 livelli
On 2 levels**

Esempio di esposizione:
Loading type:

12 Magic-Cup
+
12 Magic-Cup
Vent-clip

**ESPOSITORE DA BANCO,
DEODORANTI "MAGIC CUP"**
Fornito senza prodotti. Telaio in metallo
DISPLAY "MAGIC-CUP" AIR-FRESHENERS
Supplied empty without products.
Metal frame

35371 27x21x38 cm

Cartone / Carton ☐ 1

**Espositori
forniti senza
prodotti**

**Displays
supplied empty
without
products**

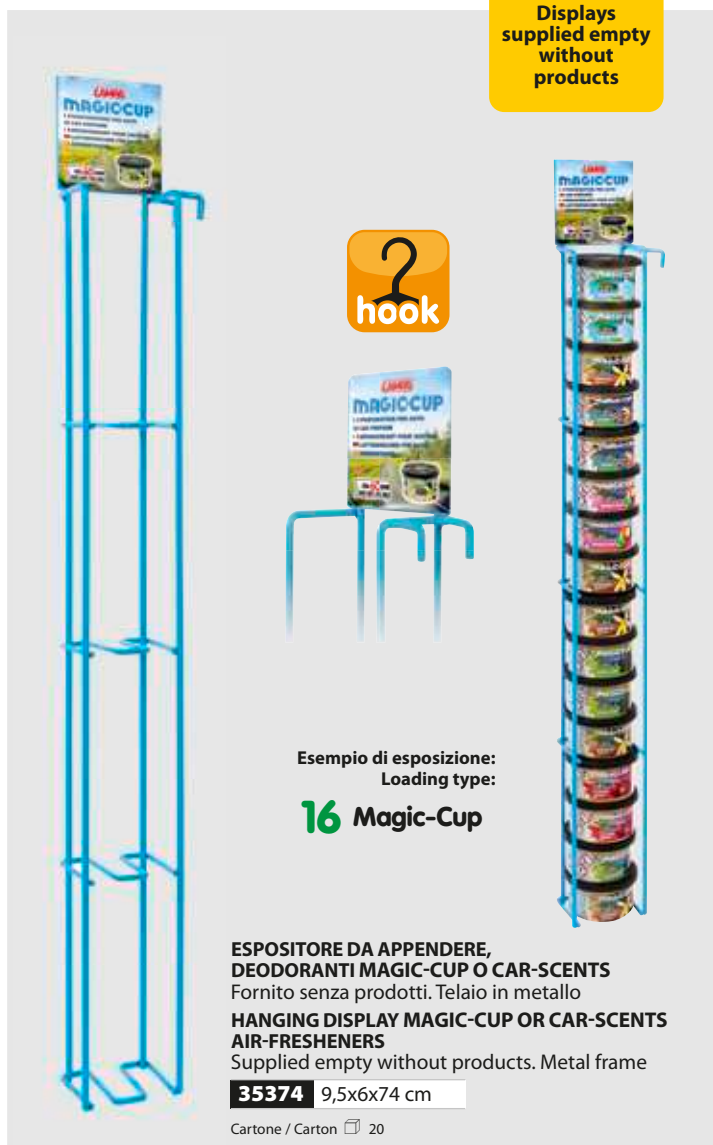

hook

Esempio di esposizione:
Loading type:

16 Magic-Cup

**ESPOSITORE DA APPENDERE,
DEODORANTI MAGIC-CUP O CAR-SCENTS**
Fornito senza prodotti. Telaio in metallo
**HANGING DISPLAY MAGIC-CUP OR CAR-SCENTS
AIR-FRESHENERS**
Supplied empty without products. Metal frame

35374 9,5x6x74 cm

Cartone / Carton ☐ 20

LATO
SIDE

Espositori
forniti senza
prodotti

Displays
supplied empty
without
products

**ESPOSITORE GIREVOLE DA
BANCO 12 GANCI**

Può contenere 216 pezzi.
Fornito senza prodotti

**BENCH SPINNER DISPLAY
12 HOOKS**

It can contain 216 pcs.
Supplied empty without
products

TA505431 cm 68,5x23x33

Scatola / Box  1



ESPOSITORE DA TERRA 24 GANCI CON RUOTE

Può contenere 576 pezzi. Fornito senza prodotti

24 HOOKS DISPLAY STAND WITH WHEELS

It can contain 576 pcs. Supplied empty without products

TA505163 cm 154x38x39

Scatola / Box  1

Espositori
forniti senza
prodotti
Displays
supplied empty
without
products



NAVIGARE, ESPOSITORE DA BANCO GIREVOLE PER 24 PAIA DI OCCHIALI
Fornito vuoto

NAVIGARE, BENCH SPINNING DISPLAY FOR 24 PAIR GLASSES
Empty supplied

NAESP100

Cartone / Carton 1



ESPOSITORE DA TERRA GIREVOLE PER 84 PAIA DI OCCHIALI
Fornito vuoto

FLOOR SPINNING DISPLAY FOR 84 PAIR GLASSES
Empty supplied

DESPO6 cm 177x50x50

Cartone / Carton 1



ESPOSITORE DA TERRA PER 96 PAIA DI OCCHIALI
Fornito vuoto

FLOOR DISPLAY FOR 96 PAIR GLASSES
Empty supplied

DESPO3 cm 176x50x37

Cartone / Carton 1



Espositore
fornito senza
prodotti

Display
supplied empty
without
products

**ESPOSITORE DOUBLE-FACE
PER 24 PAIA DI SCARPE
DOUBLE-FACE DISPLAY
FOR 24 PAIRS OF SHOES**

99072 55x170x54 cm

Cartone / Carton  1



**MINI-SCIARPA, DISPLAY ESPOSITORE FORNITO
VUOTO, SENZA PRODOTTI**

Adatto per esporre 18 mini sciarpe x 5 pz cadauno
**MINI-SCARF, WALL-DISPLAY SUPPLIED EMPTY
WITHOUT PRODUCTS**

Suitable to display 18 mini scarf x 5 pcs each

99500 cm 62,5x120

Cartone / Carton  10



ESPOSITORE CARPLAN 4 RIPIANI
 Materiale: plastica resistente
CARPLAN DISPLAY STAND, 4 SHELVES
 Material: hard plastic

CPS003 47x173x35 cm

Cartone / Carton 1

Espositori
forniti senza
prodotti
Displays
supplied empty
without
products

ESPOSITORE PER 7 DEFLETTORI ARIA "DGA"
 In cartone

"DGA" WIND AIR DEFLECTORS FLOOR DISPLAY
 Made of carton

99388

Scatola / Box 1



ESPOSITORE STP A 3 RIPIANI

Con plexiglass protettivo e chiusura a chiave.

3 SHELF FLOOR DISPLAY FOR STP PRODUCTS

With protective window and lock.

STP520852

Cartone / Carton 1



ESPOSITORE TURTLE-WAX, 4 RIPIANI
Materiale: plastica resistente
TURTLE-WAX DISPLAY STAND, 4 SHELVES
Material: hard plastic

TW00001 64x185x46 cm

Scatola / Box ☐ 1



ESPOSITORE, 50CM
Vassoio in plastica e testata
removibile in cartone.
Personalizzati linea Odor-X
SHELF TRAY DISPLAY, 50CM
With Odor-X branding

TW00004 50x50x38 cm

Sfuso / Bulk ☐ 20



ESPOSITORE, 100CM
Vassoio in plastica e testata
removibile in cartone.

SHELF TRAY DISPLAY, 100CM

TW00005 100x50x38 cm

Sfuso / Bulk ☐ 20

Espositori
forniti senza
prodotti

Displays
supplied empty
without
products



VASSOIO ESPOSIZIONE MODULARE DA APPOGGIO
Con testata rialzata
MODULAR SHELF TRAY DISPLAY

TW00003 Color Magic 50x3x30,5 cm
TW00006 Turtle Wax

Sfuso / Bulk ☐ 20



VASSOIO ESPOSIZIONE MODULARE DA APPOGGIO
Con testata rialzata.
MODULAR SHELF TRAY DISPLAY

TW00002 30x2,5x33 cm

Sfuso / Bulk ☐ 20





Espositori
forniti senza prodotti
Displays supplied
without products

Con cornice
With frame



Senza cornice
Without frame

ESPOSITORE INCLINATO DA PAVIMENTO - 171 CM

- Specifico per telefonia
- Struttura e testata in cartone.
- Completo di 25 ganci in plastica, lunghezza 15cm.

FLOOR DISPLAY- 171 CM

- Specific for mobile accessories.
- Made of cardboard.
- 25 plastic hooks included, 15cm lenght.

P16251

Scatola / Box 1



ESPOSITORE INCLINATO DA PAVIMENTO - 171 CM

- Specifico per telefonia
- Struttura e testata in cartone.
- Completo di 25 ganci in plastica, lunghezza 15cm.

FLOOR DISPLAY- 171 CM

- Specific for mobile accessories.
- Made of cardboard.
- 25 plastic hooks included, 15cm lenght.

P16252

Scatola / Box 1

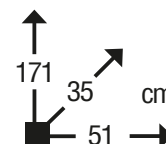



ESPOSITORE ROTANTE DA BANCO IN CARTONE

- Trifacciale
- Completo di 18 ganci in plastica, lunghezza 15cm.

SPINNING CARDBOARD BENCH DISPLAY

- Three-sided.
- 18 plastic hooks included, 15cm length.

99042

Scatola / Box 1

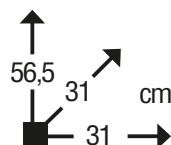

SINGOLO STAND-ALONE

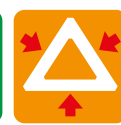

3 LATI SIDES

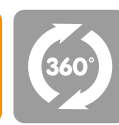

ROTANTE SPINNING

Espositori forniti senza prodotti
Displays supplied without products



Base inclinata
Inclined base

PERSONALIZZA LA TUA ESPOSIZIONE
CUSTOMIZE YOUR EXPOSITION

sistema modulare • modular system



SINGOLO STAND-ALONE



1 LATO SIDE

ESPOSITORE DA BANCO IN CARTONE

Specifico per telefonia. Fornito vuoto

CARDBOARD COUNTER DISPLAY

Specific for mobile accessories.

Supplied empty

P16250

Sfuso / Bulk 50

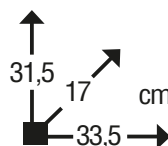



Esempio

ESPOSITORE ROTANTE DA BANCO IN CARTONE

- Bifacciale
- Completo di 7 ganci in plastica.

SPINNING CARDBOARD BENCH DISPLAY

- Two-sided.
- 7 plastic hooks included.

P16253

Scatola / Box ☐ 1

55
32 cm
32

**ESPOSITORI PERSONALIZZABILI
CUSTOMIZABLE DISPLAYS**



23
13 cm
27

ESPOSITORE DA BANCO IN CARTONE

Predisposto per essere appeso ai ganci degli scaffali.

CARDBOARD BENCH DISPLAY

It can be hung on the shelf hooks.

P16255

Busta / Bag ☐ 20



41
13 cm
23

ESPOSITORE DA BANCO IN CARTONE

Predisposto per essere appeso ai ganci degli scaffali.

CARDBOARD BENCH DISPLAY

It can be hung on the shelf hooks.

P16254

Busta / Bag ☐ 20



Espositori
forniti senza prodotti
Displays supplied
without products



Impilabile grazie al
sistema ad incastro
Stackable thanks to
the joint system



ESPOSITORE DA BANCO A 9 SLOT IN ACRILICO
Testata intercambiabile ad applicazione magnetica,
con grafiche incluse per adattarsi all'assortimento
desiderato.

Fornito senza prodotti

9 SLOT ACRYLIC COUNTER DISPLAY

Interchangeable magnetic header, graphics
included to adapt to the content.
Supplied without products

38819 Display

Cartone / Carton 1

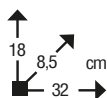

ESPOSITORE MODULARE DA BANCO IN ACRILICO

Testata intercambiabile ad applicazione magnetica, con
grafiche incluse per adattarsi all'assortimento
desiderato.

Fornito senza prodotti

ACRYLIC MODULAR COUNTER DISPLAY

Interchangeable magnetic header, graphics included to
adapt to the content.
Supplied without products

38805 Display

Cartone / Carton 1

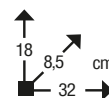

**DISPLAY DA BANCO PERSONALIZZABILE
PER POWER STATION (ART. 38946)**

Sistema anti taccheggio per Power Station e per i cavi collegati.
Inserto personalizzabile: 9,5x20 cm

**CUSTOMIZABLE COUNTER DISPLAY
FOR POWER STATION (ART. 38946)**

Anti-theft system for Power Station and connected cables.
Customizable insert paper: 9,5x20 cm

38942

Cartone / Carton 6





DISPLAY DA BANCO, MANUBRIO CON RISER PER ESPOSIZIONE PRODOTTI MOTO
 Ottimo per l'esposizione di specchi moto, linea Opti, interruttori e prese Usb, manopole, ...
 Può essere fissato ai ganci tramite i supporti in dotazione

BENCH DISPLAY, HANDLEBAR WITH RISER FOR MOTORCYCLE PRODUCTS EXPOSURE
 Suitable Great for show motorcycle mirrors, Opti line, switches and Usb sockets, knobs, ...

90454

Cartone / Carton 1

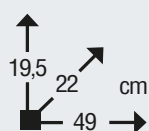

BASE ESPOSITORE OPTI-LINE, APPLICAZIONE A BANCO O SU ESPOSITORI FORATI

Ideale come base per display da banco art. 90454.
 In acciaio verniciato colore argento.
 Staffa di aggancio in dotazione

OPTI-LINE DISPLAY BASE, FOR COUNTER OR PEGBOARD DISPLAY RACKS

Ideal base for bench display art. 90454.
 Made of steel, painted in silver colour.

90418 49x22x19,5 cm

Cartone / Carton 6



Espositore fornito senza prodotti
Display supplied empty without products

230V



DISPLAY DA BANCO PRE-CABLATO PER LUCI A LED MOTO
PRE-WIRED LED LIGHT BENCH DISPLAY

99095

Cartone / Carton 1



DEMO MINIATURA COPRIMOTO OPTIMA, DEMO MINI MOTORCYCLE COVER

99299

Sfuso / Bulk 8



DEMO MINIATURA COPRIMOTO COVERLUX, DEMO MINI MOTORCYCLE COVER

99300

Sfuso / Bulk 8



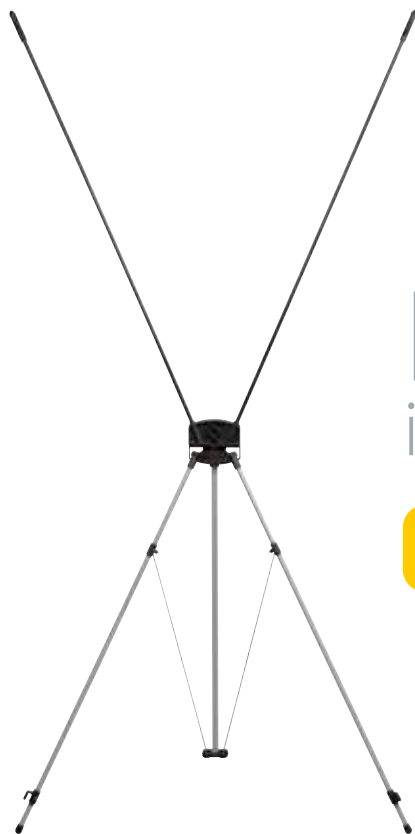

Poster
in PVC

58x160 cm



99198

LAMPAS



99199

CATENE
DA NEVE
SNOW CHAINS

Fornito con
telaio
Supplied
with frame



99139

ACCESSORI ELETTRICI
ELECTRICAL ACCESSORIES



99195

BRACCIOLI
ARM-RESTS



99168

CARPLAN



99169

TURTLE WAX

COPRISEDILI CAR SEAT COVERS

LAMPAS www.lampa.it

99170
SEAT COVERS
COPRISEDILI

TAPPETI E VASCHE BAULE CAR & TRUNK MATS

LAMPAS www.lampa.it

99177
TAPPETI
CAR MATS

POWER INVERTERS

Trasformano il corrente da 12/24V (sistema auto) a 220V (sistema domestico).
Possiedono il circuito di protezione contro sovraccarichi e 12/24V in uscita. Sono dotati di 12/24V automatico, fuso e cerniera a scatto.
Protezione contro l'over-voltage e commutazione.

POWER INVERTER
Modified Sine Wave
and
Pure Sine Wave

CARICABATTERIA
Battery Chargers

MANUALE ELETTRONICO
INTELLIGENTI per uso PROFESSIONALE e FA DA TE

PER TRAINER
APPLICAZIONE DIGIT
GENUS-TECH

LAMPAS www.lampa.it

99196
POWER INVERTERS

TELEFONIA MOBILE ACCESSORIES

COVER PER SMARTPHONES

CARICATORI USB
FAST CHARGE

PORTATELEFONI E TABLET

POWER-PACK

LAMPAS www.lampa.it

99135
ACCESSORI TELEFONIA
MOBILE PHONE ACCESSORIES

NORDRIVE® TRANSPORT SOLUTIONS

BOX TETTO Roof Boxes

PORTABICI Bike-Carriers

PORTASCI Ski-Carriers

MYURA Milgrytes

NORDRIVE® is a registered trade mark of LAMM S.p.a.
www.lampa.it

99138
NORDRIVE TEMPO LIBERO
NORDRIVE LEISURE TIME

NORDRIVE® TRANSPORT SOLUTIONS

BARRE PORTATUTTO
SU MISURA PER AUTO
Custom fit Roof Bars for cars

PROFILO INTEGRATO ALUMINIO

RAILING STANDARD

NORDRIVE® is a registered trade mark of LAMM S.p.a.
www.lampa.it

99133
NORDRIVE BARRE PORTATUTTO
PER AUTO

NORDRIVE® TRANSPORT SOLUTIONS

BARRE PORTATUTTO
PER VEICOLI COMMERCIALI
Roof Bars for Commercial Vehicles

Kargo (struttura in ACCIAIO) commerciali con gamma di cromature in PVC

Kargo-Plus (struttura in ALLUMINIO) con 12 posizioni di ancoraggio LTT (LIFT-LOCK)

50 kg di capacità SPORADICA PER OGNI INNESTO DI VEICOLO

FOOT-PIES

NORDRIVE® is a registered trade mark of LAMM S.p.a.
www.lampa.it

99137
NORDRIVE KARGO,
VERSIONE ITALIANA

NORDRIVE® TRANSPORT SOLUTIONS

ROOF BARS
FOR COMMERCIAL VEHICLES

Kargo Per veicoli commerciali con rete in PVC

Kargo-Plus Anodized aluminum roof bars with LTT locks

50 kg di capacità SPORADICA PER OGNI VEICOLO

FOOT-PIES

NORDRIVE® is a registered trade mark of LAMM S.p.a.
www.lampa.it

99229
NORDRIVE KARGO,
ENGLISH VERSION

SUPERIOR
FODERE SU MISURA

PIRELLI ACTIVE

OLTRE 5.000 VARIANTI

COLORE DISPONIBILE

LAMPA Distribute applicazioni complete ed appoggiate
www.lampa.it

99134
FODERE SU MISURA
CUSTOM-FIT SEAT COVERS

SPAZZOLE TERGICRISTALLO
WIPER BLADES

MULTI-FIT SYSTEM
Fit Almost International

Linea Skylon
MULTI FIT

Linea Evo-Blade
MULTI FIT

Linea Raptor
MULTI FIT

Linea Nova
MULTI FIT

Linea Premium
MULTI FIT

ASSORTIMENTO COMPLETO e DIVERSE APPLICAZIONI
disponibili su www.lampa.it

LAMPA

99149
TERGICRISTALLI
WIPER BLADES

PRIVACY
Tendine su misura
Custom made shades

L'elegante, pratica e funzionale alternativa alle pellicole e ai cristalli oscurati

The elegant and practical alternative to window film and privacy glass

OCCLUSIONAMENTO SICUREZZA ANTIRIFLESSI PROTEZIONE UV VENTILAZIONE CONFORT ESTIVO

Fornita come optional dalle principali case automobilistiche europee

LAMPA

99172
POSTER
PRIVACY

99172T
TENDINA E CLIPS
PER ART. 99172

DEFLETTORI ARIA
WIND DEFLECTORS

QUI DISPONIBILI ON SALE HERE

Chiedi il modello per il tuo camion
Choose the model for your truck

su misura custom fit

LAMPA **PILOT**

99392
DEFLETTORI
WIND DEFLECTORS

LAMPA Accessori Camion
Truck Accessories

CURTAINS
Tende

SEAT COVERS
Coprisedili

STEERING WHEEL COVERS
Coprivalanti

CUSTOM FIT MATS
Tappeti su misura

...e molto altro ancora... www.lampa.it

99146
CAMION INTERNO
TRUCK INTERIOR

LAMPA Accessori Camion
Truck Accessories

LED LIGHTS
Fari e Luci a Led

SIDE LIGHTS
Luci Perimetrali a Led

ANTI-THEFT DEVICES
Antifurti

PLUGS AND SOCKETS
Spinotti e Prese

...e molto altro ancora... www.lampa.it

99145
CAMION ELETTRICO
TRUCK ELECTRICAL

TAPPETI CAMION
TRUCK MATS

QUI DISPONIBILI ON SALE HERE

Chiedi il modello per il tuo camion
Choose the model for your truck

In simpatia
Leather mats

su misura custom fit

LAMPA

99390
CAMION TAPPETI
TRUCK MATS

BARRE IN ACCIAIO INOX
STAINLESS STEEL BARS

QUI DISPONIBILI ON SALE HERE

Chiedi il modello per il tuo camion
Choose the model for your truck

su misura custom fit

BARRE PONTAFARI PER TETTO
ROOF BARS

BARRE FRONTALI
FRONT BARS

BARRE PARAURTI
BUMPER BARS

ALISI 304
Anodi in zinco
Zinc anodes

LUCIDATURA A SPECCHIO ESEGUITA MANUALMENTE
HAND MADE MIRROR POLISHED

LAMPA **PILOT**

99391
BARRE IN ACCIAIO INOX
STAINLESS STEEL BARS

ANTENNE
ANTENNAS

PILOT www.pilot-tuning.it

99175
ANTENNE
ANTENNAS

Extraordinary Lighting

PREMIUM SERIES Lampadine alogene

LAMPADINE SPECIALI AD ALTE PRESTAZIONI

XENON-TOP +120% LUMEN +6000h	XENON-ULTRA +90% LUMEN +6000h
XENON-PLUS +50% LUMEN +6000h	XENON-BLUE +50% LUMEN +6000h

SMD LED Lampadine a Led

HALO-LED Kit conversione a led per fari alogeni

H.I.D. XENON Lampadine xenon

H.I.D. XENON Kit conversione xenon compatibili

PILOT www.pilot-tuning.it

99178
LAMPADINE E HID XENON
BULBS & HID XENON

DISTANZIALI
E BULLONERIA
WHEEL SPACERS & BOLTS

PILOT www.pilot-tuning.it

99180
DISTANZIALI
WHEEL SPACERS

TERMINALI
DI SCARICO
TAIL PIPES

Acciaio Inox - Stainless Steel

PILOT www.pilot-tuning.it

99184
TERMINALI DI SCARICO
TAIL-PIPES

GEAR ZONE

PILOT www.pilot-tuning.it

99187
GEAR ZONE

FILTRI SPORTIVI
SPORT AIR-FILTERS

PERFORMANCE

FILTRI ARIA AD ALTE PRESTAZIONI

- Progettati per garantire una portata d'aria maggiore rispetto ai filtri convenzionali. Filtri in carta ad alta resistenza e massima performance nel motore.
- Facili e realizzabili più volte per una lunga durata e per un risparmio nei costi.

PRE-OLIATI pronti all'installazione

PILOT www.pilot-tuning.it

99185
FILTRI SPORTIVI
SPORT AIR-FILTERS

LAMPA
motorcycle accessories

PORTATAROGA **TELEFONIA**

PRECCHE **PROTEZIONI**

MANOPOLE **SPECCHI**

BORSE **CARICA BATTERIE**

...e molto altro ancora

PILOT www.lampa.it

99193
ACCESSORI MOTO
MOTORCYCLE ACCESSORIES

Banner in PVC

160x58 cm

LAMPA
www.lampa.it

Accessori per **AUTO, CAMION, MOTO** - Accessories for **CAR, TRUCK, MOTORCYCLE**

PILOT | **NORDRIVE** | **SnowDrive** | **FOFI** | **mygear**

99213

LAMPA

PILOT
TUNING PROJECT

CAR STYLING and PERFORMANCE TUNING

www.pilot-tuning.it | **PILOT** - un'esperienza che nasce da LAMPA S.p.A.

99197

PILOT

NORDRIVE
TRANSPORT SOLUTIONS

www.nordrive.it

99214

NORDRIVE

SnowDrive
TRACTION DEVICES | www.lampa.it

Catene da neve e dispositivi per la trazione invernale | Snow Chains and Winter Traction Devices

Auto | SUV, Furgoni, Camper, 6x4 | Camion, Bus | AutoSock | AutoSock High Performance

99215

SNOWDRIVE



CARTELLA COLORI FODERE SUPERIOR
SUPERIOR,
SEATCOVER COLOUR
CARD

99369

Busta / Bag 1



MAZZETTA TESSUTI FODERE SUPERIOR
SUPERIOR, SEATCOVER
FABRICS-BOOKLET

99370

Busta / Bag 1

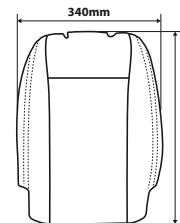

DEMO COPRISDILE LINEA SUPERIOR
IN MINIATURA

SUPERIOR, DEMO MINI SEAT-COVER

99371	A		Nocciola	Brown
99372	B		Beige	Beige
99373	C		Grigio/Nero	Grey/Black
99374	D		Nero/Blu	Black/Blue
99375	E		Nero/Rosso	Black/Red
99376	F		Nero/Grigio	Black/Grey

Busta / Bag 1



MINIATURA TAPPETI SU MISURA
IN MOQUETTE
CUSTOM FIT CARPET MAT
MINIATURE

99383

Sfuso / Bulk 1



MINIATURA TAPPETI SU
MISURA IN GOMMA
CUSTOM FIT RUBBER MAT
MINIATURE

99384

Sfuso / Bulk 1 / 50



MINIATURA TAPPETO
NOVLINE
NOVLINE MAT
MINIATURE

99228

Sfuso / Bulk 1



3 pcs

VETROFANIA ADESIVA, 3 PZ
In PET cromato

CHROMED PET STICKER, 3 PCS

99203	Lampa	540x110 mm
99206	Pilot	540x110 mm

Busta 10 / 100



KIT ADESIVI LAMPAS
Misure assortite, 31 pz
LAMPAS ADHESIVE KIT
Assorted sizes, 31 pcs

31 pcs

99209

Busta 10 / 50



KIT ADESIVI NORDRIVE
Misure assortite, 27 pz
NORDRIVE ADHESIVE KIT
Assorted sizes, 27 pcs

27 pcs

99208

Busta 10 / 1000



KIT ADESIVI PILOT, 36 PZ
PILOT ADHESIVE KIT, 36 PCS

36 pcs

99207 93x30 mm

Busta 10 / 100



KIT ADESIVI NORDRIVE, 36 PZ
NORDRIVE ADHESIVE KIT, 36 PCS

36 pcs

99212 120x22 mm

Busta 10 / 100



**RACCOGLITORE ANELLI 4X25 MM
RING BINDER, 4X25 MM**

99230

Maniglia ☐ 10 / 60



**RACCOGLITORE ANELLI 4X40 MM
CON BUSTE
RING BINDER, 4X40 MM WITH
FOLDERS**

99239

Sfuso ☐ 12 / 48



**RACCOGLITORE ANELLI 4X65 MM
CON BUSTE
RING BINDER, 4X65 MM WITH
FOLDERS**

99237

Sfuso ☐ 12 / 24



**SET 20 BUSTE PER RACCOGLITORE
ANELLI**

**SET 20 FOLDERS FOR RING
BINDERS**

99236

Busta ☐ 10 / 100



**RACCOGLITORE CON BUSTE
BINDER WITH FOLDERS**

99232 40 buste / folders

Busta ☐ 10 / 60

99231 60 buste / folders

Busta ☐ 6 / 36



**CARTELLA PORTADOCUMENTI 2
TASCHE**

FOLDER WITH 2 POCKETS

99235

Sfuso ☐ 25 / 200



**CARTELLA PORTADOCUMENTI
ELASTICO**

FOLDER WITH ELASTIC

99242

Busta ☐ 12 / 48



**CARTELLA PORTADOCUMENTI
BOTTONE**

FOLDER WITH BUTTON

99233

Sfuso ☐ 12 / 720



**CARTELLA PORTADOCUMENTI
LATERALE**

FOLDER SIDE OPEN

99234

Sfuso ☐ 12 / 960



CATALOGHI - CATALOGUES

99321	Auto
99322	Moto
99323	Camion
99324	Ciclo
99325	Catene neve
99333	Nordrive
99330	Telefonia
99131	Occasioni
99141	Guida applicativa
99125	Supporto vendita

**AGGIORNAMENTI
UPDATES**

99326	1
99327	2
99329	4

**LISTINO PREZZI
PRICE-LIST**

99320	
--------------	--



**MONOGRAFIA
MONOGRAPHY**

99331	Italiano
99332	Inglese

**BLOCCO ORDINI/COMMISSIONE
ORDER FORM BLOCK**

99107	Carta normale
99110	Carta chimica

Busta 5

**BLOCCO NOTE
BLOC NOTES**

99108	A4
99109	A5
99106	A6

Busta 5





OMBRELLLO AUTOMOTIVE
"LAMPAS"
"LAMPAS" AUTOMOTIVE
UMBRELLA

99340

Busta / Bag  12 / 36



PORTA BIGLIETTI DA VISITA
BUSINESS CARD HOLDER

99240

Busta / Bag  30 / 120



LACCIO PORTACELLULARE
CON CLIP
NECK-LACE WITH CLIP

99254

Busta / Bag  50 / 500



PENNA A SFERA
BALLPOINT PEN

99343

Busta / Bag  100 / 1000



PENNA A SFERA
IN ALLUMINIO
ALUMINIUM
BALLPOINT PEN

99344

Busta / Bag  25 / 500



PENNA A SFERA
IN ALLUMINIO
ALUMINIUM
BALLPOINT PEN

99345

Busta / Bag  25 / 500



PENNA A SFERA
IN OTTONE
BRASS
BALLPOINT PEN

99346

Busta / Bag  25 / 500



PENNA A SFERA
IN ALLUMINIO
ALUMINIUM
BALLPOINT PEN

99347

Busta / Bag  25 / 500



**TUTA LAVORO
OVERALLS**

99243	M
99244	L
99245	XL
99246	XXL
99247	XXXL

Busta / Bag  10



**CAMICE LAVORO
OVERALL**

99248	S
99249	M
99250	L
99251	XL
99252	XXL
99253	XXXL

Busta / Bag  10



CAPPELLO LAMPA TAGLIA UNICA
ONE SIZE LAMPA HAT

99400

Busta / Bag 50 / 200

CAMICIA
MANICA CORTA
SHORT-SLEEVED SHIRT



99301	S
99302	M
99303	L
99304	XL
99305	XXL
99306	XXXL

Busta / Bag 50

CAMICIA
MANICA LUNGA
LONG-SLEEVED
SHIRT



99311	S
99312	M
99313	L
99314	XL
99315	XXL
99316	XXXL

Busta / Bag 50



GILET CON ZIP
GILET WITH ZIP

99334	S
99335	M
99336	L
99337	XL
99338	XXL
99339	XXXL

Busta 25

CAMICIA MANICA
LUNGA
LONG-SLEEVED
SHIRT



99351	S
99352	M
99353	L
99354	XL
99355	XXL
99356	XXXL

Busta 50



POLO

99357	S
99358	M
99359	L
99360	XL
99361	XXL
99362	XXXL

Busta 50



T-SHIRT

99363	S
99364	M
99365	L
99366	XL
99367	XXL
99368	XXXL

Busta 50





Art. 99125
Catalogo
Supporto Vendita



LAMPA S.p.A.

Via G. Rossa, 53/55
46019 Viadana (MN) Italy
Tel. (+39) 0375 820700
Fax (+39) 0375 820800

✉ info@lampa.it - 🌐 www.lampa.it