

2013
Book

**FORM &
PERFORMANCE**



LEGENDA SIMBOLI / SYMBOL CHART



Logo che indica la tecnologia che a partire dal 2017 tutela della sicurezza dell'operatore. Uno speciale circuito interno trasforma la corrente 230V in arrivo in inoffensiva corrente 4V. Con questo innovativo step si eliminano i rischi di shock elettrico.

This logo indicates the technology developed since 2017 for the operator's safety. A special internal circuit transform the incoming 230V electricity into an harmless 4V DC electric tension. With this innovative technological step all risk of electric shock have been eliminated.



Logo che indica l'utilizzo di motori raffreddati da una ventola integrata. Con questo tipo di motore il gruppo della centralina/motore del sollevatore può operare anche a ritmi molto serrati senza per questo surriscaldare pericolosamente il motore. Studiati per i centri revisione.

This logo indicates the use of electrical motor cooled by a built-in fan. With this kind of motor the group power unit/motor can work continuously and at high external temperatures without taking the risk of dangerous over-heatings. Developed for the motorcycle review centers.



Logo che indica l'utilizzo del nuovo sistema di recupero olio in vigore dal 2019. Oltre ad aver dotato tutti i nostri cilindri di un ingrassatore posto sulla testa del pistone, una tubazione collega l'interno del cilindro con la centralina, consentendo ad eventuali gocce di olio di rimanere all'interno del circuito di lubrificazione e non cadere all'esterno.

This logo indicates the use of the new system of oil recovery and spill prevention, active since 2019. We have equipped our cylinders of a greaser located onto the head of the piston and also there is a drainpipe that connects the cylinder to the power unit, allowing eventual oil spill to remain inside the lubrication circuit and not drop out on the lift's basement.



Logo di prevenzione incidenti e uso non conforme dei cavalletti per moto. L'utilizzo dei cavalletti, sia anteriori che posteriori, è esclusivamente per uso statico, pertanto è proibito salire sulla moto quando sia posta sui cavalletti. E' altresì vietato accendere il motore e inserire una marcia anche se l'operatore non è sulla moto. Il mancato rispetto di queste raccomandazioni può essere causa di incidenti.

Accidents prevention logo that indicates a non-compliant use of our bike stands. The use of bike stands, front or rear they may be, it is exclusively for static purposes, therefore it is forbidden to ride the bike when the stands are in use. It is forbidden as well to switch on the engine and set a gear on, even if the operator is not riding the bike. Fail to follow these recommendations can be cause of accidents and serious injuries for the owner.

INDICE INDEX

SOLLEVATORI - LIFTS	6-36	43-50
ACCESSORI PER SOLLEVATORI - LIFTS ACCESSORIES	37	42
MORSE PER SOLLEVATORI - WHEEL CLAMPS	51	54
ATTREZZATURA PER E-BIKES - E-BIKES EQUIPMENT	55	60
MODOFLEX	61	75
RACING	76	85
CAVALLETTI - STANDS	86	109
SVILUPPO OFFICINA - WORKSHOP DEVELOPMENT	110	111
ATTREZZATURE OFFICINA - WORKSHOP EQUIPMENT	112	129
MORSE PER FURGONI - VAN & TRAILERS WHEEL CLAMPS		130
ATTREZZI PROFESSIONALI - PROFESSIONAL TOOLS	131	138

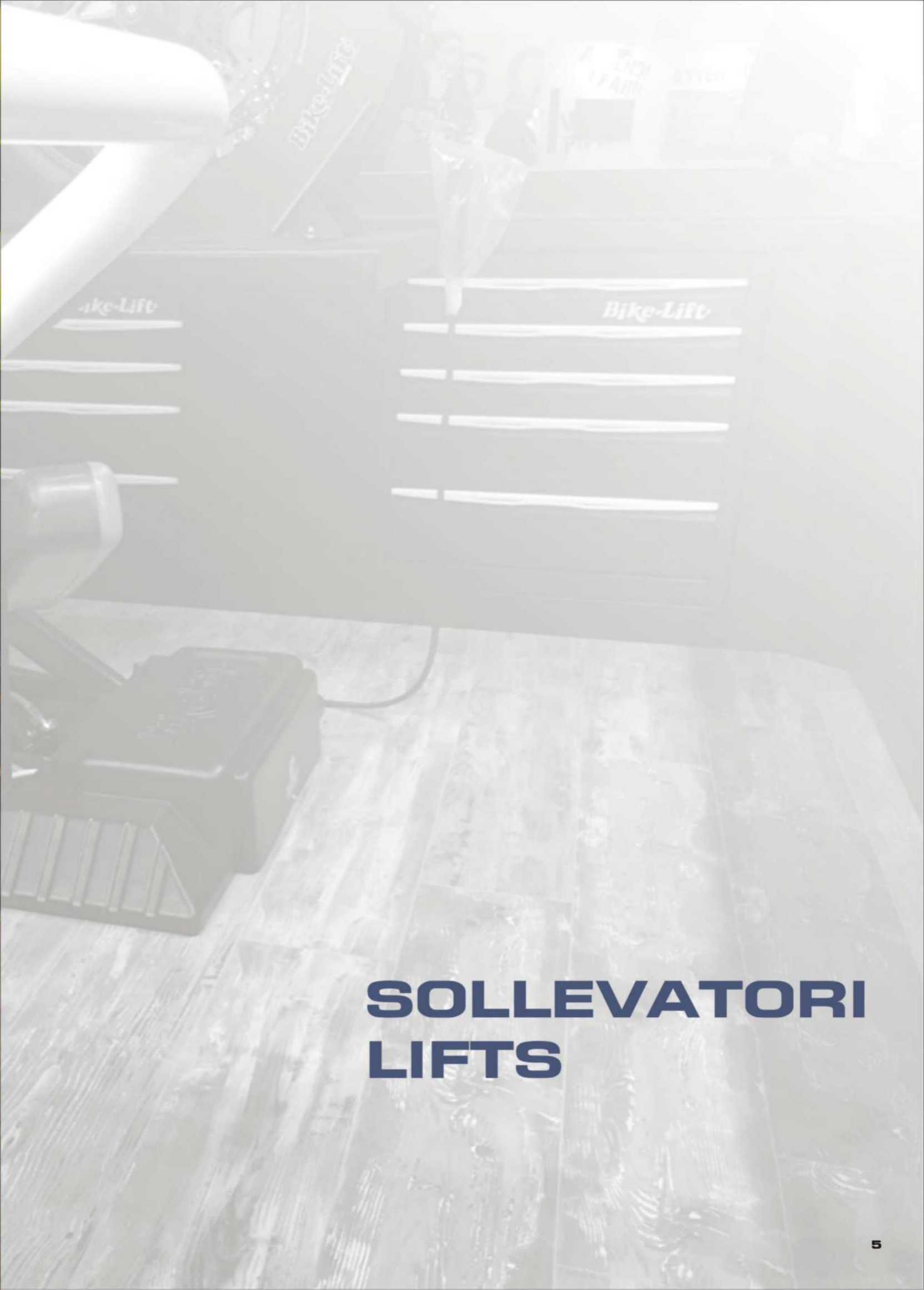

SOLLEVATORI LIFTS

ONE FITS ALL

Un sollevatore unico , progettato e realizzato per veicoli a due o quattro ruote, con capacità massima di 1000 kg. Dotato di un sistema brevettato di allargamento e di bloccaggio, si adatta facilmente e velocemente alle diverse necessità di intervento, garantendo stabilità, sicurezza e la massima accessibilità operativa su ogni lato del veicolo.

Grazie all'esclusiva progettazione ed alla struttura molto robusta, è in grado di arrivare ad una altezza massima di 130 cm garantendo sempre una perfetta stabilità e la massima sicurezza durante tutta la fase di intervento. Un solo sollevatore consente di intervenire su diverse tipologie di veicoli rendendo quindi l'officina polifunzionale e tecnicamente completa. E' azionato da una centralina elettro-idraulica silenziosa, potente e veloce, che garantisce un sollevamento costante e privo di vibrazioni, sia nella fase di salita che di discesa. Il WIDER viene fornito con sicurezza meccanica a 12 posizioni, sgancio pneumatico della sicura, rampe di salita e ferma ruote anteriori.



A unique bike-lift, designed and manufactured for two or four-wheeled vehicles, with a maximum load capacity of 1000 kg. It is equipped with a patented widening and locking system and adapts quickly and easily to all operating needs, ensuring stability, safety and accessibility to all sides of the vehicle.

Thanks to its unique design and extremely robust structure it can reach a maximum height of 130 cm, always providing perfect stability and the utmost safety during each phase of the operation. One lift alone that allows to work on various types of vehicles, thus making the workshop multi-functional and technically complete. The lift is operated by a silent, powerful and fast electro-hydraulic unit, ensuring a constant lifting and descent movement without vibrations. The WIDER lift is equipped with a mechanical safety device with 12 different locking positions that is released pneumatically, two run-up ramps and two front wheel end stop plates.

WIDER 1000

Patent N° 11183040.2

WD-003 | Pompa Elettro Idraulica / Electro-hydraulic Pump



Portata / Max load capacity	1000 Kg / 2204 Lbs
Altezza Max / Max Height	130 cm / 4.2 Ft
Altezza Min. / Min. Height	20 cm / 7.8 Inch.
Posizioni Sicura / Safety Position	12
Lunghezza / Length	230 cm / 7.5 Ft
Dim. Piano Sollevamento Chiuso / Tabletop size when closed	84x230 cm / 2.7x7.5 Ft
Dim. Piano Sollevamento Aperto / Tabletop size when open	150x230 cm / 4.9x7.5 Ft
Dimensioni Binario / Ground Rail size	40x150 cm / 1.3x4.9 Ft
Dimensioni Rampa di Salita / Run-up Ramp size	82x40.5 cm / 2.7x1.3 Ft
Ingombro Totale Sollevatore / Overall Dimensions	240x100 cm / 7.8x3.3 Ft
Peso / Weight	300 Kg / 661 Lbs

Centralina Elettro-Idraulica Electro-Hydraulic Power Unit

Potenza / Power	1,1 Kw
Europa / Europe	230 Volts - 50 Hz
Giappone / Japan	200 Volts - 50/60 Hz
America / USA	110 Volts - 60 Hz

Torretta di controllo
Control Panel Di serie / Included

DOTAZIONE DI SERIE / STD EQUIP.

Rampe / Run-up Ramps	2 pcs
Imballo Std. Cassa Legno Std. Packing wood box	235x102x60cm
Peso Imballo/Packing Weight	320 kg
Ferma ruota / Wheel stop	2 pcs
Torretta / Tower Control	1 pc



OUR LIFTS USE **MOTOREX**

THE QUAD MASTER

IL DUO 1000, è composto da due unità separate che si sollevano in contemporanea fino ad una altezza di 130cm, lasciando perfettamente accessibile tutta la parte centrale dei veicoli. Inoltre utilizzando gli accessori disponibili è possibile sollevare l'avantreno o il retrotreno dei veicoli per mezzo di un carrello con martinetto idraulico (DL-A02) che scorre nella parte centrale del sollevatore e velocizza le operazioni di cambio gomme, smontaggio ammortizzatori e sostituzione braccetti sterzo, oppure caricare e sollevare veicoli a tre ruote applicando una piastra di collegamento (DL-A01) nella parte anteriore o posteriore del sollevatore. Come per il modello Wider anche il DUO viene fornito con sicurezza meccanica a 12 posizioni, sgancio pneumatico della sicura, rampe di salita e ferma ruote anteriori.

The DUO 1000 lift is composed of two separate units lifting at the same time up to a maximum height of 130cm, leaving a free space in the middle to access vehicles from the center. Furthermore, by using the available accessories one can lift the front end axle of the rear end axle of the vehicle by means of a sliding trolley with an hydraulic jack fitted on it (DL-A02) that slides in the lift center and allows to quickly replace tires, disassemble the shock absorbers and replace the steering arms. By fitting the dedicated connecting plate (DL-A01) in the front or rear part of the lift, one can also load and lift three-wheeled vehicles. Just like the WIDER, the DUO 1000 is equipped with a mechanical safety device with 12 different locking positions that is released pneumatically, two run-up ramps and two front wheel end stop plates.



DUO 1000

DL-003 | Pompa Elettro Idraulica / Electro-hydraulic Pump

Portata / Max load capacity

Altezza Max / Max Height

Altezza Min. / Min. Height

Posizioni Sicura / Safety Position

Lunghezza / Length

Dimensioni Rampa di Salita / Run-up Ramp size

Ingombro Totale Sollevatore / Overall Dimensions

Peso / Weight



1000 Kg / 2204 Lbs

130 cm / 4.2 Ft

20 cm / 7.8 Inch.

12

210 cm / 6.9 Ft

62x44.5 cm / 2x1.4 Ft

220x135 cm / 7.2x4.4 Ft

270 Kg / 595 Lbs

Centralina Elettro-Idraulica
Electro-Hydraulic Power Unit

Potenza / Power
Europa / Europe
Giappone / Japan
America / USA

1,1 Kw
230 Volts - 50 Hz
200 Volts - 50/60 Hz
110 Volts - 60 Hz

Torretta di controllo/Control Panel
Di serie / Included

DOTAZIONE DI SERIE / STD EQUIP.

Rampe / Run-up Ramps	2 pcs
Imballo Std. Cassa Legno	
Std. Packing	235x102x60cm
Peso imb./pack. Weight	290 kg
Ferमारुota / Wheel stop	2 pcs



DL-A01
(Optional)

DL-A02
(Optional)



OUR LIFTS USE **MOTOREX**

A MEAN MACHINE

IL TWIN ARMS E' IL SOLLEVATORE per moto più completo e tecnologico sul mercato. La struttura classica è stata completata con un sistema di sollevamento idraulico a due bracci sincronizzati che, una volta assicurate le pedane o l'inserimento del perno passante, consente di sollevare dal piano di lavoro una o addirittura entrambe le ruote.

LA VERSATILITA' d'uso e la semplicità di gestione del veicolo fanno del Twin Arms un sollevatore unico nel suo genere, simbolo di alta tecnologia e design funzionale, particolarmente apprezzato dalle officine che effettuano molti cambi gomme o interventi sulle forcelle e ammortizzatori. La massima capacità di carico del sollevatore è di 500 Kg. Raggiunge l'elevazione massima di 120 cm ed i due bracci si sollevano a loro volta fino a 60 cm. Viene fornito con una cinghia automatica di sicurezza in dotazione.

THE TWIN ARMS BIKE LIFT is the most complete and technologically advanced lift on the market. The classical scissor lift structure has been integrated by a hydraulic lifting system of two synchronized arms that allows to detach one or even both wheels from the lifting platform once the footpegs are safely secured to the arms or the motorbike is taken from the central swing arm by means of an adapter sliding through it. Its VERSATILE use and a simple vehicle management make the Twin Arms a unique lift, a symbol of high technology and functional design, particularly appreciated by workshops that perform many tyre changes or work on forks and shock absorbers. The maximum load capacity of the lift is 500 kg. It reaches the maximum height of 120 cm and the two arms raise up to another 60 cm. It is supplied with an automatic safety tie down strap included.



MAX Twin Arms 500



MTA516-002 | Pompa ad Aria / Air Pump
 MTA516-003 | Pompa Elettro-Idraulica / Electro-Hydraulic Pump
 MTA516-004/R | Pompa Elettro-Idraulica con Comando Remoto / Electro-Hydraulic Pump w/Remote

Portata / Max load capacity	500 Kg / 1100 Lbs
Altezza Max / Max Height	120 cm / 4 Ft
Altezza Min. / Min. Height	20 cm / 7.8 Inch.
Posizioni Sicura / Safety Position	8
Dimensione Piano Sollevamento / Tabletop size	210x75 cm / 6.8x2.4 Ft
Dimensioni Rampa di Salita / Run-up Ramp size	82x51 cm / 2.7x1.7 Ft
Ingombro Totale Sollevatore / Overall Dimensions	220x99 cm / 7.2x3.2 Ft
Portata Max bracci idraulici / Arms Max. load Capacity	350 kg / 771 Lbs
Altezza Max bracci idraulici / Max. Height Arms	60 cm / 1.97 Ft
Altezza Min. bracci idraulici / Min. Height Arms	20 cm / 7.8 Inch
Peso / Weight	280 Kg / 617 Lbs

Centralina Elettro-Idraulica Electro-Hydraulic Power Unit

Potenza / Power	1,1 Kw
Europa / Europe	230 Volts - 50 Hz
Giappone / Japan	200 Volts - 50/60 Hz
America / USA	110 Volts - 60 Hz

DOTAZIONE DI SERIE / STD EQUIP.

Rampe / Run-up Ramps	1 pc
Imballo Std. / Std. Packing	
Scat. Cartone con pallet Legno / Cardboard w/wooden crate	
Morsa W-36s / W-36s Wheel Clamp	1 pcs
Supporti Pedane/Foot-peg supports	2 pcs
Cinghiette Pedane/Short Tie-down	4 pcs
Cinghia Autom. RTD-6/ Automatic Tie-down RTD-6	1 pc

BUILT TO LAST

L'ABSOLUTE 756 SPLIT è stato sviluppato per essere una macchina infaticabile ed affidabile intervento dopo intervento, anno dopo anno. Originariamente sviluppato per operare con moto di dimensioni considerevoli si è dimostrato nel corso degli anni molto versatile anche su moto sportive o Street bikes. Capace di sollevare 750 kg in completa sicurezza e bilanciamento fino ad una altezza di 130 cm. Nella versione SPLIT la parte anteriore può essere sganciata per avere una maggiore rapidità del cambio gomma o di un intervento sulle forcelle.

THE ABSOLUTE 756 WAS DEVELOPED to be a tireless and reliable machine, intervention after intervention, year after year. Originally designed to operate on larger motorcycles, it has proved to be very versatile over the years, even on sport bikes or street bike. It can lift 750 kg in complete safety and balancing up to an height of 130 cm. In the SPLIT version the front part can be unhooked and dropped for faster tire changeover or service on the forks.



ABSOLUTE 756 Split

Patent Design No. 2546986-0001

AS756-002 | Pompa ad Aria / Air Pump
 AS756-003 | Pompa Elettro-Idraulica / Electro-Hydraulic Pump
 AS756-004/R | Pompa Elettro-Idraulica con Comando Remoto / Electro-Hydraulic Pump w/Remote

Portata / Max load capacity	750 Kg / 1650 Lbs
Altezza Max / Max Height	130 cm / 4.3 Ft
Altezza Min. / Min. Height	20 cm / 7.8 Inch.
Posizioni Sicura / Safety Position	8
Dimensione Piano Sollevamento / Tabletop size	220x75 cm / 7x2.5 Ft
Dimensioni Rampa di Salita / Run-up Ramp size	82x51 cm / 2.7x1.7 Ft
Ingombro Totale Sollevatore / Overall Dimensions	230x92 cm / 7.5x3 Ft
Ingombro Tot. Piano di Sollev. / Tabletop overall Dimensions	220x92 cm / 7x3 Ft
Dimensioni Ali Laterali / Side Wings Dimensions	161x8.5 cm / 5 Ft x 3.3 Inch
Dimensione Sportello Gate / Sliding panel Dimensions	60x36 cm / 23x14 Inch
Dimensione Sportello Split / Drop panel Dimensions	75x44.5 cm / 29x17 Inch
Peso / Weight	265 Kg / 584 Lbs



Centralina Elettro-Idraulica
Electro-Hydraulic Power Unit

Potenza / Power	1,1 Kw
Europa / Europe	230 Volts - 50 Hz
Giappone / Japan	200 Volts - 50/60 Hz
America / USA	110 Volts - 60 Hz

Pompa ad Aria / Air Pump

Pressione Aria / Air Pressure	7-10 Bar
Consumo Aria / Air Consumption	300L/Min

DOTAZIONE DI SERIE / STD EQUIP.

Rampe / Run-up Ramps	1 pc
Imballo Std. / Std. Packing	
Scat. Cartone con pallet Legno/ Cardboard w/wooden crate	
Feraruota / Wheel stop	1 pc
PZA Placca Protez./PZA Chequerplate	1 pc
Ali Laterali / Side Wings	2 pcs



OUR LIFTS USE **MOTOREX**

(BIG) CRUISER FRIENDLY

LA VERSIONE ABSOLUTE GATE, LA PIU' utilizzata nelle officine a forte incidenza di grandi Cruiser e moto Custom. Il modello che più rappresenta l'idea di stabilità, sicurezza e durata nel tempo che da sempre sono i punti fermi della nostra filosofia costruttiva, ed un punto di riferimento per tutto il mondo del sollevamento moto.

THE ABSOLUTE 756 GATE VERSION is mostly used in workshops working on large Cruisers or Custom bikes. This is the lift model that mostly accounts for stability, safety and durability in time, which are the strongholds or our manufacturing philosophy, and is a worldwide point of reference for the entire motorcycle lifting sector.



ABSOLUTE 756 Gate

Patent Design No. 2546986-0001



AG756-002 | Pompa ad Aria / Air Pump
 AG756-003 | Pompa Elettro-Idraulica / Electro-Hydraulic Pump
 AG756-004/R | Pompa Elettro-Idraulica con Comando Remoto / Electro-Hydraulic Pump w/Remote

Portata / Max load capacity	750 Kg / 1650 Lbs
Altezza Max / Max Height	130 cm / 4.3 Ft
Altezza Min. / Min. Height	20 cm / 7.8 Inch.
Posizioni Sicura / Safety Position	8
Dimensione Piano Sollevamento / Tabletop size	220x75 cm / 7x2.5 Ft
Dimensioni Rampa di Salita / Run-up Ramp size	82x51 cm / 2.7x1.7 Ft
Ingombro Totale Sollevatore / Overall Dimensions	230x92 cm / 7,5x3 Ft
Ingombro Tot. Piano di Sollev. / Tabletop overall Dimensions	220x92 cm / 7x3 Ft
Dimensioni Ali Laterali / Side Wings Dimensions	212x8.5 cm / 5 Ft x 3.3 Inch
Dimensione Sportello Gate / Sliding panel Dimensions	60x36 cm / 23x14 Inch
Peso / Weight	260 Kg / 573 Lbs



Centralina Elettro-Idraulica
 Electro-Hydraulic Power Unit

Potenza / Power 1,1 Kw
 Europa / Europe 230 Volts - 50 Hz
 Giappone / Japan 200 Volts - 50/60 Hz
 America / USA 110 Volts - 60 Hz

Pompa ad Aria / Air Pump

Pressione Aria / Air Pressure 7-10 Bar
 Consumo Aria / Air Consumption 300L/Min

DOTAZIONE DI SERIE / STD EQUIP.

Rampe / Run-up Ramps 1 pc
 Imballo Std. / Std. Packing
 Scat. Cartone con pallet Legno/
 Cardboard w/wooden crate
 Fermaruota / Wheel stop 1 pc
 PZA Placca Protez. / PZA Chequerplate 1 pc
 Ali Laterali / Side Wings 2 pcs



PZA

OUR LIFTS USE **MOTOREX**

TRIKE THIS

I TRIKE SONO SEMPRE PIU' PRESENTI nel panorama motociclistico internazionale quindi non poteva mancare nella nostra gamma questa versione specifica. Considerando la struttura di un Trike ed il suo peso non potevamo che scegliere il modello ABSOLUTE come base, su cui sono state applicate due robustissime ali per le ruote posteriori o anteriori del Trike. La stabilità è certamente la dote principale di questo sollevatore, che sicuramente si pone come punto di riferimento sul mercato.

TRIKES ARE MORE AND MORE PRESENT in the international motorcycle scene, so we couldn't miss this specific lift version in our range. Considering the structure of a Trike and its weight we couldn't do anything but choose the ABSOLUTE model as a base, on which two very sturdy side extension wings were applied for the front wheels of the Trike. Stability is the main feature of this lift, which certainly stands as a benchmark on the market.



ABSOLUTE 756 Spider

Patent Design No. 2546986-0001



SP756-003 | Pompa Elettro-Idraulica / *Electro-Hydraulic Pump*
 SP756-004/R | Pompa Elettro-Idraulica con Comando Remoto / *Electro-Hydraulic Pump w/Remote*

Portata / <i>Max load capacity</i>	750 Kg / 1650 Lbs
Altezza Max / <i>Max Height</i>	130 cm / 4.3 Ft
Altezza Min. / <i>Min. Height</i>	20 cm / 7.8 Inch.
Posizioni Sicura / <i>Safety Position</i>	8
Dimensione Piano Sollevamento / <i>Tabletop size</i>	220x75 cm / 7x2.5 Ft
Dimens. Rampa di Salita(centrale) / <i>Run-up Ramp size (central)</i>	82x51 cm / 2.7x1.7 Ft
Ingombro Totale Sollevatore / <i>Overall Dimensions</i>	230x160 cm / 7.5x5.2 Ft
Dimens. rampe di allargamento/ <i>Run-up side tool wings</i>	23.5x82 cm / 9.3x2.7 Ft
Peso / <i>Weight</i>	290 Kg / 638 Lbs



Centralina Elettro-Idraulica
Electro-Hydraulic Power Unit

Potenza / *Power* 1,1 Kw
 Europa / *Europe* 230 Volts - 50 Hz
 Giappone / *Japan* 200 Volts - 50/60 Hz
 America / *USA* 110 Volts - 60 Hz

DOTAZIONE DI SERIE / *STD EQUIP.*

Rampe / *Run-up Ramps* 3 pc
 Imballo Std. / *Std. Packing*
 Scat. Cartone con pallet Legno/
Cardboard w/wooden crate
 Fermaruota / *Wheel stop* 3 pc
 PZA Placca Protez, / *PZA Chequerplate* 1 pc
 Ali Allargamento/*Extension Wings* 2 pcs



OUR LIFTS USE



SLIDE AND SAVE (SPACE)

POTER SOLLEVARE UNA MOTO fino a 130cm di altezza non è certamente indispensabile, ma sicuramente è di grande aiuto in termini di efficacia e comfort durante l'intervento sul veicolo. Il MASTER 504 rappresenta la miglior soluzione per le officine che hanno una clientela varia e quindi una tipologia di intervento che va dallo scooter alle grandi sportive o Sport Tourer. E' dotato di un ampio Gate a scomparsa e, unico modello nella nostra gamma, di una rampa di salita integrata e scorrevole, che rientra automaticamente all'interno del sollevatore quando viene alzato.

LIFTING A MOTORCYCLE up to 130 cm height is certainly not essential, but it surely helps greatly in terms of effectiveness and comfort during vehicle servicing. The MASTER 504 lift represents the best solution for workshop that have a varied customer base and need therefore to intervene on vehicles ranging from mopeds to larger sport or street Touring bikes. It is equipped with a large sliding panel and, only model in our range, with an integrated and sliding run-up ramp, which automatically retracts into the chassis when it is raised.



MASTER 504



MA504-002	Pompa ad Aria / Air Pump
MA504-003	Pompa Elettro-Idraulica / Electro-Hydraulic Pump
MA504-004/R	Pompa Elettro-Idraulica con Comando Remoto / Electro-Hydraulic Pump w/Remote

Portata / Max load capacity	500 Kg / 1102 Lbs
Altezza Max / Max Height	130 cm / 4.3 Ft
Altezza Min. / Min. Height	20 cm / 7.8 Inch.
Posizioni Sicura / Safety Position	8
Dimensione Piano Sollevamento / Tabletop size	210x75 cm / 6.9x2.5 Ft
Dimens. Rampa di Salita mobile / Sliding Run-up Ramp size	70x50 cm / 2.30x1.60 Ft
Ingombro Totale Sollevatore / Overall Dimensions	220x92 cm / 7.2x3 Ft
Dimens. Ali Laterali / Side Wings Dimensions	210x8.5 cm / 6.9 Ft x 3.3 Inch
Ingombro Totale piano sollev. / Tabletop overall dimensions	210x92 cm / 6.9x3 Ft
Dimensioni Sportello Gate / Drop GATE panel dimensions	60x36 cm / 1.95x1.20 Ft
Peso / Weight	250 Kg / 551 Lbs



Centralina Elettro-Idraulica Electro-Hydraulic Power Unit

Potenza / Power	1,1 Kw
Europa / Europe	230 Volts - 50 Hz
Giappone / Japan	200 Volts - 50/60 Hz
America / USA	110 Volts - 60 Hz

Pompa ad Aria / Air Pump

Pressione Aria / Air Pressure	7-10 Bar
Consumo Aria / Air Consumption	300L/Min

DOTAZIONE DI SERIE / STD EQUIP.

Rampe / Run-up Ramps	1 pc
Imballo Std. / Std. Packing	
Scat. Cartone con pallet Legno/ Cardboard w/wooden crate	
Fermaruota / Wheel stop	1 pc
Lam. Protezione/Chequerplate	1 pc
Ali laterali / Side wings	1 pc



OUR LIFTS USE



LOW & HIGH EFFICIENCY



IL SOLLEVATORE A MINIMA ALTEZZA da terra è, per la nostra gamma, una assoluta novità. Abbiamo atteso e studiato tutte le problematiche che un progetto come questo presenta, a partire dalla stabilità e dalla robustezza. Lo sforzo generato sulla struttura è notevole e quindi abbiamo preferito avere la certezza di una macchina in linea con tutte le altre che hanno reso famoso nel mondo il marchio BIKE LIFT piuttosto che farsi condurre dalla fretta e lanciare sul mercato un sollevatore qualunque. Da questa idea di tecnologia e performances senza compromessi nasce il CUSTOM 500, con una altezza minima di 9 cm ed una massima di 110 cm, il partner ideale per le grandi Harley e le moto customizzate.

Basso ma con una ALTISSIMA EFFICIENZA operativa.

HAVING A LIFT AT MINIMUM HEIGHT from the ground is, for our range, an absolute novelty. We have awaited and studied all the problems that a project like this presents, starting from stability and robustness. The lifting effort generated on the lift structure is enormous and therefore we preferred to be sure of manufacturing a lift in line with all the other that have made BIKE-LIFT brand famous in the world, rather than being hurried and launch anything on the market. From this idea of technology and uncompromising performance comes CUSTOM 500, with a minimum height of 9 cm and a maximum height of 110 cm, this lift is the ideal partner for large Harleys and customized motorcycles. Low but with VERY HIGH operating efficiency,



CUSTOM 500



CM500-003 | Pompa Elettro-Idraulica / *Electro-Hydraulic Pump*
 CM500-004/R | Pompa Elettro-Idraulica con Comando Remoto / *Electro-Hydraulic Pump w/Remote*

Portata / <i>Max load capacity</i>	500 Kg / 1102 Lbs
Altezza Max / <i>Max Height</i>	110 cm / 3.6 Ft
Altezza Min. / <i>Min. Height</i>	9 cm / 3.5 Inch.
Dimensione Piano Sollevamento / <i>Tabletop size</i>	220x75 cm / 7.2x2.4 Ft
Dimens. Rampa di Salita mobile / <i>Sliding Run-up Ramp size</i>	51.6x24 cm / 1.69 Ft x 9.4 Inch
Ingombro Totale Sollevatore / <i>Overall Dimensions</i>	220x92 cm / 7.2x3 Ft
Dimens. Ali Laterali / <i>Side Wings Dimensions</i>	220x8.5 cm / 7.2 Ft x 3.3 Inch
Ingombro Totale piano sollev. / <i>Tabletop overall dimensions</i>	220x92 cm / 7.2x3 Ft
Dimensioni Sportello Gate / <i>Drop GATE panel dimensions</i>	60x28 cm / 1.95 Ft x11 Inch
Peso / <i>Weight</i>	285 Kg / 628 Lbs

Torretta Controllo / *Control Tower*
 Inclusa / *Included*

Centralina Elettro-Idraulica
Electro-Hydraulic Power Unit

Potenza / *Power* 1,1 Kw
 Europa / *Europe* 230 Volts - 50 Hz
 Giappone / *Japan* 200 Volts - 50/60 Hz
 America / *USA* 110 Volts - 60 Hz



Rampa automatica / *Automatic Ramp*

DOTAZIONE DI SERIE / *STD EQUIP.*

Rampa / <i>Run-up Ramp</i>	1 pc
Imballo Std. / <i>Std. Packing</i>	
Scat. Cartone con pallet Legno/ <i>Cardboard w/wooden crate</i>	
Fermaruota / <i>Wheel stop</i>	1 pc
PZA Placca Prot./ <i>PZA Chequerplate</i>	1 pc
Ali laterali / <i>Side Wings</i>	2 pcs



OUR LIFTS USE **MOTOREX**

NORMALLY EXTRAORDINARY

IL PIU' VENDUTO DA SEMPRE. La migliore espressione della tecnologia e del design, semplice ma con performances straordinarie. Dal suo lancio sul mercato 15 anni fa sono state apportate tante piccole migliorie che lo hanno reso oggi la macchina più completa e versatile per ogni tipo di officina. Disponibile con tutte le opzioni di motorizzazione, dalla pompa a pedale alla centralina elettro-idraulica con comando remoto. Viene utilizzato anche come base per il montaggio delle ali di allargamento PSW516, che permettono al sollevatore di poter operare con veicoli a quattro ruote.

THE MOST SOLD LIFT EVER. The best expression of technology and design, simple but with extraordinary performances. Many small improvements have been made since its launch on the market 15 years ago, making this lift the most complete and versatile one for any kind of workshop. Available in all operating models, ranging from foot-pump to remotely controlled electro-hydraulic pump unit.

This lift is also used as base to install the PSW516 side extension wings, allowing it to be used for 4-wheeled vehicles as well.



MAX GATE 516



MG516-001	Pompa a Pedale / Foot Pump
MG516-002	Pompa ad Aria / Air Pump
MG516-003	Pompa Elettro-Idraulica / Electro-Hydraulic Pump
MG516-004/R	Pompa Elettro-Idraulica con Comando Remoto / Electro-Hydraulic Pump w/Remote

Portata / Max load capacity	500 Kg / 1102 Lbs
Altezza Max / Max Height	120 cm / 4 Ft
Altezza Min. / Min. Height	20 cm / 7.8 Inch.
Posizioni Sicura / Safety Position	8
Dimensione Piano Sollevamento / Tabletop size	210x75 cm / 6.9x2.5 Ft
Dimens. Rampa di Salita / Run-up Ramp size	82x51 cm / 2.7x1.6 Ft
Ingombro Totale Sollevatore / Overall Dimensions	220x99 cm / 7,3x3.3 Ft
Dimens. Ali Laterali / Side Wings Dimensions	210x12 cm / 6.8 Ft x 4.7 Inch
Ingombro Totale piano sollev. / Tabletop overall dimensions	210x99 cm / 6.8x3.3 Ft
Dimensioni Sportello Gate / Sliding GATE panel dimensions	60x36 cm / 1.95x1.20 Inch
Peso / Weight	250 Kg / 551 Lbs

Centralina Elettro-Idraulica
Electro-Hydraulic Power Unit

Potenza / Power	1,1 Kw
Europa / Europe	230 Volts - 50 Hz
Giappone / Japan	200 Volts - 50/60 Hz
America / USA	110 Volts - 60 Hz



Pompa ad Aria / Air Pump

Pressione Aria / Air Pressure	7-10 Bar
Consumo Aria / Air Consumption	300L/Min

DOTAZIONE DI SERIE / STD EQUIP.

Rampe / Run-up Ramps	1 pc
Imballo Std. / Std. Packing	
Scat. Cartone con pallet Legno/ Cardboard w/wooden crate	
Feraruota / Wheel stop	1 pc
Ali Laterali / Side Wings	2 pcs
PZA Placca Protez./PZA Chequerplate	1 pc



PZA

OUR LIFTS USE



MAX PERFORMANCE

VERSIONE CON PIANO DI sollevamento unico, senza lo sportello Gate. Viene utilizzato come base per il modello Twin Arms, grazie alla eccezionale stabilità e fluidità del movimento. Questo modello è la base ideale per il montaggio delle ali di allargamento PSW516 che trasformano il sollevatore moto in sollevatore per veicoli a 4 ruote, dove l'utilizzo del pannello Gate non è indispensabile.

This version has a FULL FLAT TABLE TOP, without the Gate panel. It is used as a base for the TWIN ARMS lift, thanks to its great stability and fluidity of movement. It is also the ideal base to install the PSW156 side extension wings, which transforms a standard motorcycle lift in a 4-wheeled vehicle lift, where the use of the Gate panel is not strictly necessary.



*Ali di allargamento non incluse /
Extension wings not included

MAX 516

M516-001	Pompa a Pedale / Foot Pump
M516-002	Pompa ad Aria / Air Pump
M516-003	Pompa Elettro-Idraulica / Electro-Hydraulic Pump
M516-004/R	Pompa Elettro-Idraulica con Comando Remoto / Electro-Hydraulic Pump w/Remote

Portata / Max load capacity

Altezza Max / Max Height

Altezza Min. / Min. Height

Posizioni Sicura / Safety Position

Dimensione Piano Sollevamento / Tabletop size

Dimens. Rampa di Salita / Run-up Ramp size

Ingombro Totale Sollevatore / Overall Dimensions

Dimens. Ali Laterali / Side Wings Dimensions

Ingombro Totale piano sollev. / Tabletop overall dimensions

Peso / Weight

500 Kg / 1102 Lbs

120 cm / 4 Ft

20 cm / 7.8 Inch.

8

210x75 cm / 6.9x2.5 Ft

82x51 cm / 2.7x1.6 Ft

220x99 cm / 7,3x3.3 Ft

210x12 cm / 6.8 Ft x 4.7 Inch

210x99 cm / 6.8x3.3 Ft

250 Kg / 551 Lbs



Centralina Elettro-Idraulica
Electro-Hydraulic Power Unit

Potenza / Power	1,1 Kw
Europa / Europe	230 Volts - 50 Hz
Giappone / Japan	200 Volts - 50/60 Hz
America / USA	110 Volts - 60 Hz

Pompa ad Aria / Air Pump

Pressione Aria / Air Pressure	7-10 Bar
Consumo Aria / Air Consumption	300L/Min

DOTAZIONE DI SERIE / STD EQUIP.

Rampa / Run-up Ramp	1 pc
Imballo Std. / Std. Packing	
Scat. Cartone con pallet Legno/ Cardboard w/wooden crate	
Feraruota / Wheel stop	1 pc
Ali Laterali / Side Wings	2 pcs
PZA Placca Protez./PZA Chequerplate	1 pc



PZA

OUR LIFTS USE **MOTOREX**

SLIM FOR BIGGER SPACE

IL MODELLO SPORT GATE 500 è stato progettato per rispondere a due esigenze specifiche : spazio limitato e necessità di operare nel modo più ergonomico possibile sulle moto sportive e scooters di grossa cilindrata. Il piano di lavoro, largo solo 60 cm, consente al meccanico di poter essere molto vicino alla moto e quindi di poter lavorare nella massima comodità, efficienza e sicurezza. E' fornito di un pannello GATE a caduta per lo smontaggio della ruota posteriore.

The SPORT GATE 500 LIFT has been designed to meet two specific requirements: limited space and necessity to operate as ergonomically as possible on sport bikes and large displacements mopeds. The table top is only 60 cm wide and allows the operator to work very close to the bike and with the utmost level easiness, efficiency and safety. It is equipped with a dropping GATE panel for an easy disassembly of the rear wheel.



SPORT GATE 500/17



SG-001 500/17	Pompa a Pedale / Foot Pump
SG-002 500/17	Pompa ad Aria / Air Pump
SG-003 500/17	Pompa Elettro-Idraulica / Electro-Hydraulic Pump
SG-004/R 500/17	Pompa Elettro-Idraulica con Comando Remoto / Electro-Hydraulic Pump w/Remote

Portata / Max load capacity	500 Kg / 1102 Lbs
Altezza Max / Max Height	120 cm / 4 Ft
Altezza Min. / Min. Height	20 cm / 7.8 Inch.
Posizioni Sicura / Safety Position	8
Dimensione Piano Sollevamento / Tabletop size	210x60 cm / 6.8x2 Ft
Dimens. Rampa di Salita / Run-up Ramp size	62x44.5 cm / 2x1.4 Ft
Ingombro Totale Sollevatore / Overall Dimensions	220x84 cm / 7,2x2.7 Ft
Dimens. Ali Laterali / Side Wings Dimensions	210x12 cm / 6.8 Ft x 4.7 Inch
Ingombro Totale piano sollev. / Tabletop overall dimensions	210x84 cm / 6.8x2.7 Ft
Dimensioni sportello Gate / Sliding Gate panel dimensions	60x36 cm / 1.95x1.2 Ft
Peso / Weight	200 Kg / 441 Lbs

Centralina Elettro-Idraulica
Electro-Hydraulic Power Unit

Potenza / Power	1,1 Kw
Europa / Europe	230 Volts - 50 Hz
Giappone / Japan	200 Volts - 50/60 Hz
America / USA	110 Volts - 60 Hz

Pompa ad Aria / Air Pump

Pressione Aria / Air Pressure	7-10 Bar
Consumo Aria / Air Consumption	300L/Min

DOTAZIONE DI SERIE / STD EQUIP.

Rampa / Run-up Ramp	1 pc
Imballo Std. / Std. Packing	
Scat. Cartone con pallet Legno/ Cardboard w/wooden crate	
Feraruota / Wheel stop	1 pc
Ali Laterali / Side Wings	2 pcs
PZA Placca Protez./PZA Chequerplate	1 pc



OUR LIFTS USE



BASIC EXCELLENCE

IL RACING 350 RAPPRESENTA la soluzione base tra tutti i modelli della nostra gamma, offrendo gli stessi standard di qualità tecniche dei modelli con maggiore capacità di sollevamento ad un prezzo più contenuto. Grazie alle dimensioni contenute è consigliato per le officine che intervengono principalmente su moto sportive, off-road e scooters, oltre che essere spesso scelto dai bikers che si dedicano al fai da te o dai restauratori di moto d'epoca.

The RACING 350 LIFT represents the basic solution among the entire range of our lifts, ensuring the same technical and quality standards of models with an higher load capacity, but at a lower price. Thanks to its smaller sizes it is recommended for workshops working mainly on sport bikes, off-road and mopeds, but it is also chosen by individual bikers that performs DIY repair or by vintage restorers



RACING 350/17



R-001 350/17	Pompa a Pedale / Foot Pump
R-002 350/17	Pompa ad Aria / Air Pump
R-003 350/17	Pompa Elettro-Idraulica / Electro-Hydraulic Pump
R-004/R 350/17	Pompa Elettro-Idraulica con Comando Remoto / Electro-Hydraulic Pump w/Remote

Portata / Max load capacity	350 Kg / 771 Lbs
Altezza Max / Max Height	120 cm / 4 Ft
Altezza Min. / Min. Height	20 cm / 7.8 Inch.
Posizioni Sicura / Safety Position	8
Dimensione Piano Sollevamento / Tabletop size	200x60 cm / 6.5x2 Ft
Dimens. Rampa di Salita / Run-up Ramp size	62x44.5 cm / 2x1.4 Ft
Ingombro Totale Sollevatore / Overall Dimensions	210x84 cm / 6.8x2.7 Ft
Dimens. Ali Lateral / Side Wings Dimensions	200x12 cm / 6.5 Ft x 4.7 Inch
Ingombro Totale piano sollev. / Tabletop overall dimensions	200x84 cm / 6.5x2.7 Ft
Peso / Weight	180 Kg / 397 Lbs



Centralina Elettro-Idraulica
Electro-Hydraulic Power Unit

Potenza / Power	1,1 Kw
Europa / Europe	230 Volts - 50 Hz
Giappone / Japan	200 Volts - 50/60 Hz
America / USA	110 Volts - 60 Hz

Pompa ad Aria / Air Pump

Pressione Aria / Air Pressure	7-10 Bar
Consumo Aria / Air Consumption	300L/Min

DOTAZIONE DI SERIE / STD EQUIP.

Rampa / Run-up Ramp	1 pc
Imballo Std. / Std. Packing	
Scat. Cartone con pallet Legno/ Cardboard w/wooden crate	
Fermaruota / Wheel stop	1 pc
Ali Lateral / Side Wings	2 pcs

WIDER IS BETTER

QUESTO SOLLEVATORE, INIZIALMENTE progettato per il sollevamento di trattorini tosaerba, grazie alle sue caratteristiche, ha trovato nel corso degli anni diverse applicazioni sia in campo industriale che privato. Ha un piano di sollevamento di 120 cm di larghezza e 215 di lunghezza ed una capacità di sollevamento di 1000 kg a 100 cm di altezza. E' fornito di serie con doppia rampa di salita.

This lift, initially designed to lift riding lawn mowers, thanks to its characteristics has found over the years various applications both in the industrial and private sectors.

It has a 120 cm wide and 215 long lifting table and a lifting capacity of 1000 kg at 100 cm height. It is supplied as standard with a double run-up ramp and two wheel stoppers.



GARDEN 1000



G-003/10
G-004/10R

Pompa Elettro-Idraulica / *Electro-Hydraulic Pump*
Pompa Elettro-Idraulica con Comando Remoto / *Electro-Hydraulic Pump w/Remote*

Portata / <i>Max load capacity</i>	1000 Kg / 2204 Lbs
Altezza Max / <i>Max Height</i>	100 cm / 3.2 Ft
Altezza Min. / <i>Min. Height</i>	20 cm / 7.8 Inch.
Posizioni Sicura / <i>Safety Position</i>	6
Dimensione Piano Sollevamento / <i>Tabletop size</i>	215x120 cm / 7.1x4 Ft
Dimens. Rampa di Salita / <i>Run-up Ramp size</i>	82x24 cm / 2.6 Ft x 9.4 Inch
Ingombro Totale Sollevatore / <i>Overall Dimensions</i>	225x120 cm / 7,5x4 Ft
Ingombro Totale piano sollev. / <i>Tabletop overall dimensions</i>	215x120 cm / 7.1x4 Ft
Peso / <i>Weight</i>	300 Kg / 661 Lbs

Centralina Elettro-Idraulica
Electro-Hydraulic Power Unit

Potenza / <i>Power</i>	1,1 Kw
Europa / <i>Europe</i>	230 Volts - 50 Hz
Giappone / <i>Japan</i>	200 Volts - 50/60 Hz
America / <i>USA</i>	110 Volts - 60 Hz

DOTAZIONE DI SERIE / *STD EQUIP.*

Rampe / <i>Run-up Ramps</i>	2 pcs
Imballo Std. / <i>Std. Packing</i>	
Scat. Cartone con pallet Legno / <i>Cardboard w/wooden crate</i>	
Fermapuota / <i>Wheel stop</i>	2 pcs



POWER IN ACTION

LA VERSIONE DEL GARDEN 754 (750 kg di sollevamento) è quella che si è più dimostrata versatile per usi industriali, dove è apprezzato da anni come valido strumento di movimentazione di materiali pesanti che devono essere sollevati per l'assemblaggio. Uno dei modelli più venduti nel Nord Europeo, utilizzato per interventi su trattorini tagliaerba ma anche per motoslitte.

THE GARDEN 754 VERSION (750 kg load capacity) has proved to be most versatile for industrial use, where it has been appreciated for years as a valid tools for handling heavy materials that must be lifted for assembly. One of the most sold models in Northern Europe, where it is used for service activities on riding lawn mowers but also on snowmobiles.



GARDEN 754



G-002	Pompa ad Aria / Air Pump
G-003	Pompa Elettro-Idraulica / Electro-Hydraulic Pump
G-004/R	Pompa Elettro-Idraulica con Comando Remoto / Electro-Hydraulic Pump w/Remote

Portata / Max load capacity	750 Kg / 1650 Lbs
Altezza Max / Max Height	130 cm / 4.2 Ft
Altezza Min. / Min. Height	20 cm / 7.8 Inch.
Posizioni Sicura / Safety Position	8
Dimensione Piano Sollevamento / Tabletop size	215x100 cm / 7.1x3.2 Ft
Dimens. Rampa di Salita / Run-up Ramp size	82x24 cm / 2.6 Ft x 9.4 Inch
Ingombro Totale Sollevatore / Overall Dimensions	225x100 cm / 7,5x3.2 Ft
Peso / Weight	280 Kg / 617 Lbs

Centralina Elettro-Idraulica
Electro-Hydraulic Power Unit

Potenza / Power	1,1 Kw
Europa / Europe	230 Volts - 50 Hz
Giappone / Japan	200 Volts - 50/60 Hz
America / USA	110 Volts - 60 Hz
	2 pcs

Pompa ad Aria / Air Pump

Pressione Aria / Air Pressure	7-10 Bar
Consumo Aria / Air Consumption	300L/Min

DOTAZIONE DI SERIE / STD EQUIP.

Rampe / Run-up Ramps	2 pcs
Imballo Std. / Std. Packing	
Scat. Cartone con pallet Legno/ Cardboard w/wooden crate	
Fermapuota / Wheel stop	2 pcs



SWING IT UP !

UNICO NEL SUO GENERE IL FROG 500 è un sollevatore progettato per la manutenzione dei veicoli a quattro ruote, come Quad, ATV e trattorini tosaerba. E' dotato di due pedane elevabili e basculanti che possono salire fino a 100 cm nella parte anteriore ed a 155 cm nella parte posteriore. Questa esclusiva soluzione progettuale permette un accesso alla parte inferiore del veicolo molto più agevole e consente di intervenire in piena sicurezza e comfort e con tempi di lavoro inferiori.

A LIFT UNIQUE IN ITS KIND, Frog 500 was designed for maintenance of 4 wheeled vehicles, such as Quads, ATVs and riding lawn mowers. It is equipped with two elevating and tilting platforms that can raise up to 100 cm in the front end and to 155 cm in the rear end. This exclusive design solution allows a much easier access to the lower part of the vehicle and to operate in full safety and comfort and with a shorter working times.



FROG 500



F500-002 | Pompa ad Aria / Air Pump
 F500-003 | Pompa Elettro-Idraulica / Electro-Hydraulic Pump
 F500-004/R | Pompa Elettro-Idraulica con Comando Remoto / Electro-Hydraulic Pump w/Remote

Portata / Max load capacity	500 Kg / 1102 Lbs
Altezza Max (posiz. orizzontale) / Max Height (horizontal pos.)	80 cm / 2.6 Ft
Altezza Min. / Min. Height	20 cm / 7.8 Inch.
Altezza Max (parte anteriore) / Max Height (front end)	100 cm / 3.2 Ft
Altezza Max (parte posteriore) / Max Height (rear end)	155 cm / 5 Ft
Posizioni Sicura / Safety Position	3
Distanza Max. binari (esterna) / Max. rails distance (external)	130 cm / 4.2 Ft
Distanza Min. binari (esterna) / Min. rails distance (external)	101 cm / 3.3 Ft
Dimensione Binario / Rails Size	200x26 cm / 6.5 Ft x 10 Inch
Distanza Max. Binario (interna) / Max. Rail distance (internal)	74 cm / 2.4 Ft
Distanza Min. Binario (interna) / Min. Rail distance (internal)	48 cm / 1.6 Ft
Dimensione Rampe Salita/ Run-up Ramp sizes	82x24 cm / 2.7 Ft x 9 Inch
Ingombro Totale Sollevatore /Overall Dimensions	200x130 cm / 6,5x4.2 Ft
Peso / Weight	285 Kg / 628 Lbs



Centralina Elettro-Idraulica
 Electro-Hydraulic Power Unit

Potenza / Power 1,1 Kw
 Europa / Europe 230 Volts - 50 Hz
 Giappone / Japan 200 Volts - 50/60 Hz
 America / USA 110 Volts - 60 Hz

Pompa ad Aria / Air Pump

Pressione Aria / Air Pressure 7-10 Bar
 Consumo Aria / Air Consumption 300L/Min

DOTAZIONE DI SERIE / STD EQUIP.

Rampe / Run-up Ramps 2 pcs
 Imballo Std. Cassa Legno
 Std. Package Wood box 207x132x35cm 300 kg
 Ferma ruota / Wheel stop 4 pcs

VERSIONI DA INCASSO FLOOR VERSION

I MODELLI ABSOLUTE Gate/Split 756 sono anche disponibili nella versione da incasso nel pavimento. Questo tipo di soluzione rende più agevole il posizionamento delle moto ed ottimizza l'utilizzo dello spazio interno dell'officina o dello show-room. Su richiesta è possibile fare anche altri modelli in versione floor, come il Racing 350, Sport 500 gate e il Max Gate 516.

The Absolute 756 Gate / Split models are available in a special version recessed into the floor (pit). This kind of installing solution makes it easier for operators to position the motorcycle on the lift table top as well as optimizing space inside the workshop or showroom. On demand, other models can also be produced in floor version, such as the Racing 350, the Sport 500 Gate and the Max Gate 516.

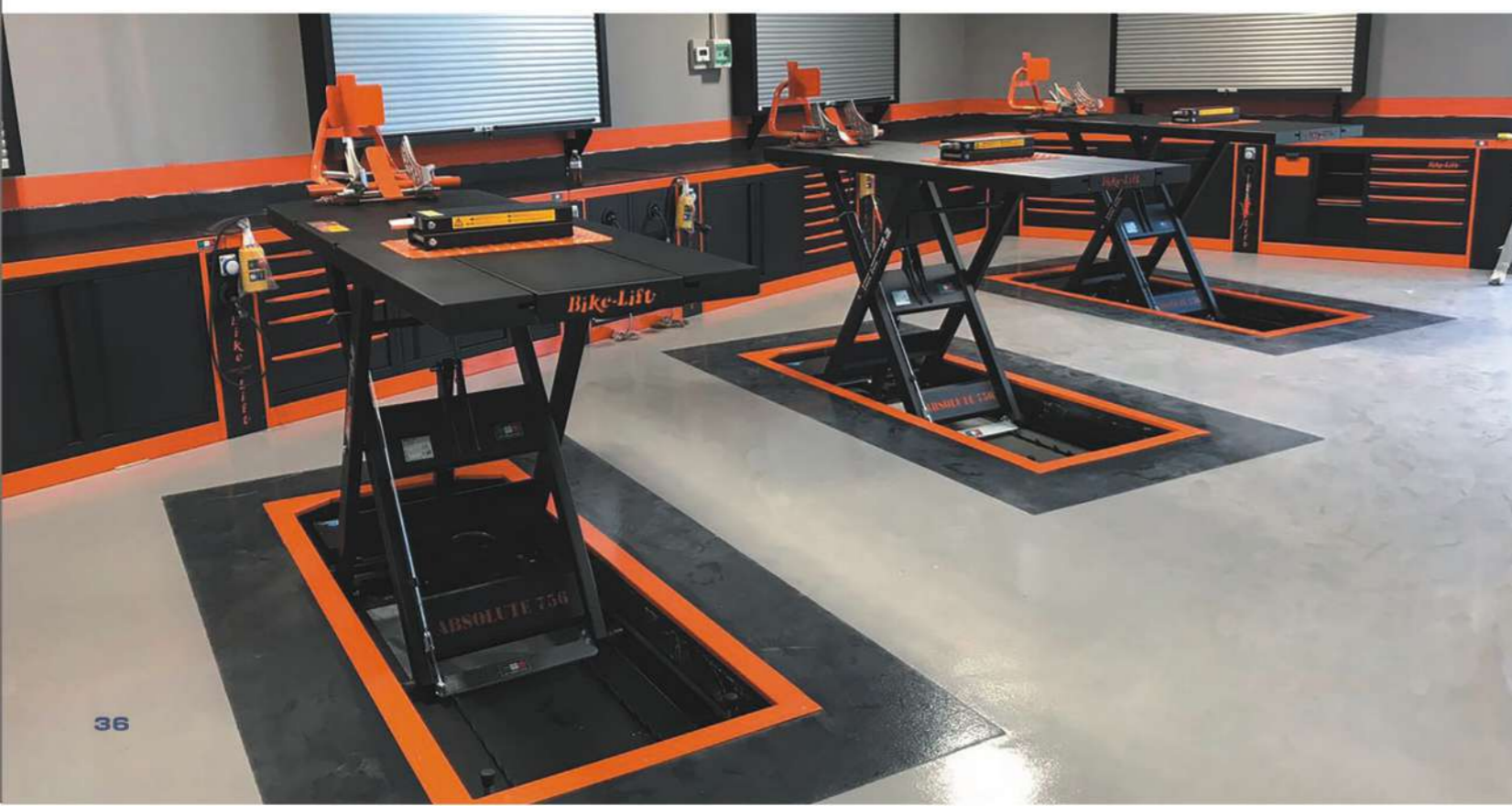

Accessori Sollevatori Lifts Accessories

Ali di allargamento
Extension Side Wings

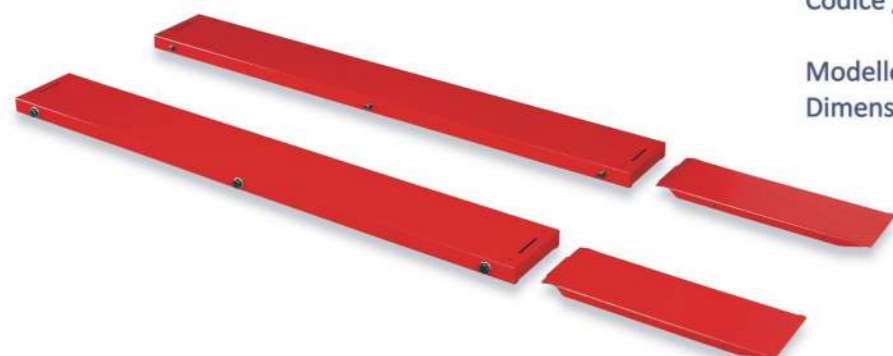

Codice / Item SW-756
Modello / Model AG-756
Dimensioni/Dimensions 27.5X212X60CM
0.9X6.96X1.9 FT

Codice / Item SW-516
Modello / Model M516/MG516
Dimensioni/Dimensions 27.5X210X50CM
0.9X6.89X1.6 FT

Sicurezza Pneumatica
Pneumatic Safety



Codice / Item PS-004
Optional applicabile a tutti i sollevatori con pompa elettro-idraulica
Optional applicable to all models with electro-hydraulic pump



Ali Speciali Pivottanti
Pivoting Extension Wings



Codice / Item PSW-516
Modello / Model M516/MG516
Dotazione Standard 2 Fermaruota
2 Rampe di salita
4 Ali fisse
2 Ali mobili
Standard Equipment 2 Wheel stoppers
2 Run-up ramps
4 Side fixed wings
2 Pivoting wings

Dimensioni / Dimensions
Ali Fisse / Side Wings
A 83cm/2.7ft
B 52.5cm/1.72ft
C 30cm/0.99ft

Ali Mobili / Pivoting Wings
A 104cm/3.4ft
B 43cm/1.41ft
C 30cm/0.99ft

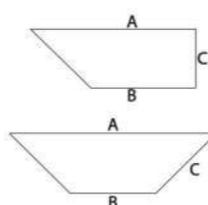

Guide Scorrevoli
Sliding hooks and rails



Codice / Item	Modello / Model
RAIL-350	R-350
RAIL-516	M516/MG516/SG500
	MA504
RAIL-756	AG-756
RAIL-756/S	AS-756

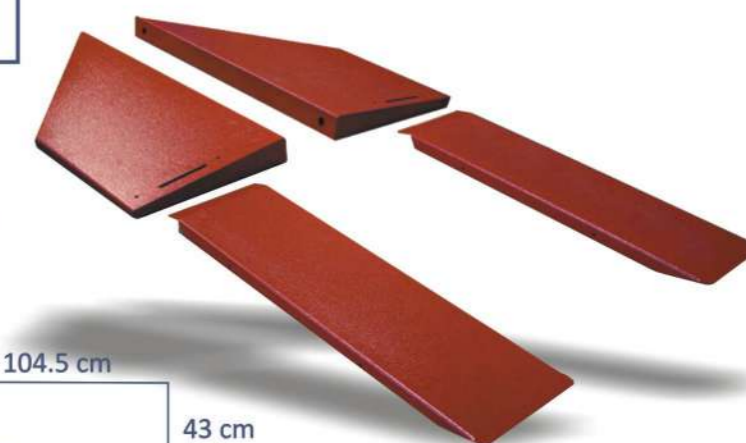

Estensioni laterali per veicoli a 3 ruote
Side Extension for 3 wheeled vehicles

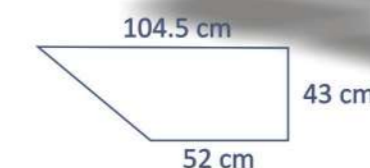

Codice / Item	Modello / Model
SW-SPIDER	AG-756/AS756

Adattatori in Gomma
Rubber Adapters



Codice / Item	Modello / Model
RA-20	140x120x20mm
RA-40	140x120x40mm
RA-60	140x120x60mm

Kit telecomando remoto
Remote control kit



Codice / Item	Modello / Model
LC-003	Sollevatori dal 2015 in poi Lifts from 2015 ahead



Cinghia Automatica
Automatic Tie-Down Straps

Codice / Item RTD-6
Lunghezza/Length 180 cm
Tenuta MAX/Max Strength 700 kg

Rampa per veicoli a 3 ruote
Extension run-up ramp for 3 wheeled vehicles



Codice / Item R-MP3
Dimensioni / Dimensions 77x110 cm
Modello / Model AG756/MG516
G754



Piastra aggancio rapido morsa W-36S
W-36S wheel clamp quick set



Codice / Item QRP

Attenzione : perni di fissaggio non inclusi.
Utilizzabile solo per modelli prodotti prima
del 2014

Warning : Locking pins not included.
Applicable only for lifts produced until 2014.



Tappeti protezione in gomma
Protection Rubber mats



RM

Codice / Item RM
33X44.5 cm
Codice / Item RM-SMALL
50X16.5 cm

RM-SMALL



Piastra Protezione anti-scivolo
Anti-skid protection plate

Codice / Item PZA
Modello / Model TUTTI/ALL
Dimensioni/Dimensions 55x34 cm



Pedaliera comandi sollevatore
Foot pedal control for lifts

Codice / Item FC/EL-CV



Pulsantiera con magnete
Hand control with magnet

Codice / Item HC



Pompa ad aria 200 bar
Air Pump 200 bar

Codice / Item AP



Pompa a pedale
Foot Pump

Codice / Item FP



Protection Mats **TAPPETI DI PROTEZIONE**

I tappeti di protezione sono tutti Made in Italy. Il materiale ha una densità di 800 gr per metro quadrato ed è gommato sulla parte interna per evitare scivolamenti. E' completamente lavabile e serve a prevenire graffi o macchie sui piani di lavoro dei sollevatori o banchi per officina. Oltre a proteggere dai graffi e macchie evita il rimbalzamento di eventuali parti metalliche come viti, dadi ecc. che altrimenti cadrebbero fuori dal piano di lavoro con il rischio di perderle. Il materiale ha una notevole capacità di assorbimento di liquidi e fluidi. All'esterno una bordatura previene l'usura ed le lacerazioni che con il tempo si potrebbero formare. I tappeti sono stampati con il logo Bike Lift ma su richiesta possono essere personalizzati con quantitativi minimi d'ordine.
Prodotto con feltro 100% poliestere, combustibile ma non infiammabile, da veli cardati e legati meccanicamente mediante aghi ed abbinato a gomma base lattice naturale al 100%.

The protection mats are all Made in Italy. The material has a density of 800gr per square meter and is rubber-coated in the bottom side for anti-skid purposes. It is 100% washable and protects against scratches and spots over tabletops of lifts and workbenches. In addition to that, it prevents metallic parts like screws or bolts that may get lost, from falling off the lift or workbench tabletop. The material has a considerable absorbing capacity for liquids and fluids. The mat edges are seamed so as to avoid any wear or tear during usage. The mats are printed with the Bike Lift logo and can be customized upon request (MOQ's to be agreed). Made of 100% polyester felt, combustible but not flammable, from carded and strapped layers mechanically knitted and bound with 100% natural latex base rubber.

Codice / Item	Serial No.	Modello/Model	Bordo/Edge color	Codice / Item	Serial No.	Modello/Model	Bordo/Edge color
BL-LC/756	911040100100	Absolute 756	Rosso/Red	BL-TC/2000	911040100400	MF-BL 2000	Rosso/Red
BL-LC/756	911040100150	Absolute 756	Grigio/Grey	BL-TC/1620	911040100500	MF-BL 1620	Grigio/Grey
BL-LC/516	911040100200	Max / Master	Rosso/Red	BL-TC/1000	911040100600	MF-BL 1000	Grigio/Grey
BL-LC/516	911040100250	Max / Master	Grigio/Grey	BL-TC/ANG	911040100800	MF-PANG	Rosso/Red
BL-LC/SPORT	911040100300	Sport	Rosso/Red	BL-TC/ALBN	911040100700	AL-BN	Rosso/Red
BL-LC/SPORT	911040100350	Sport	Grigio/Grey				

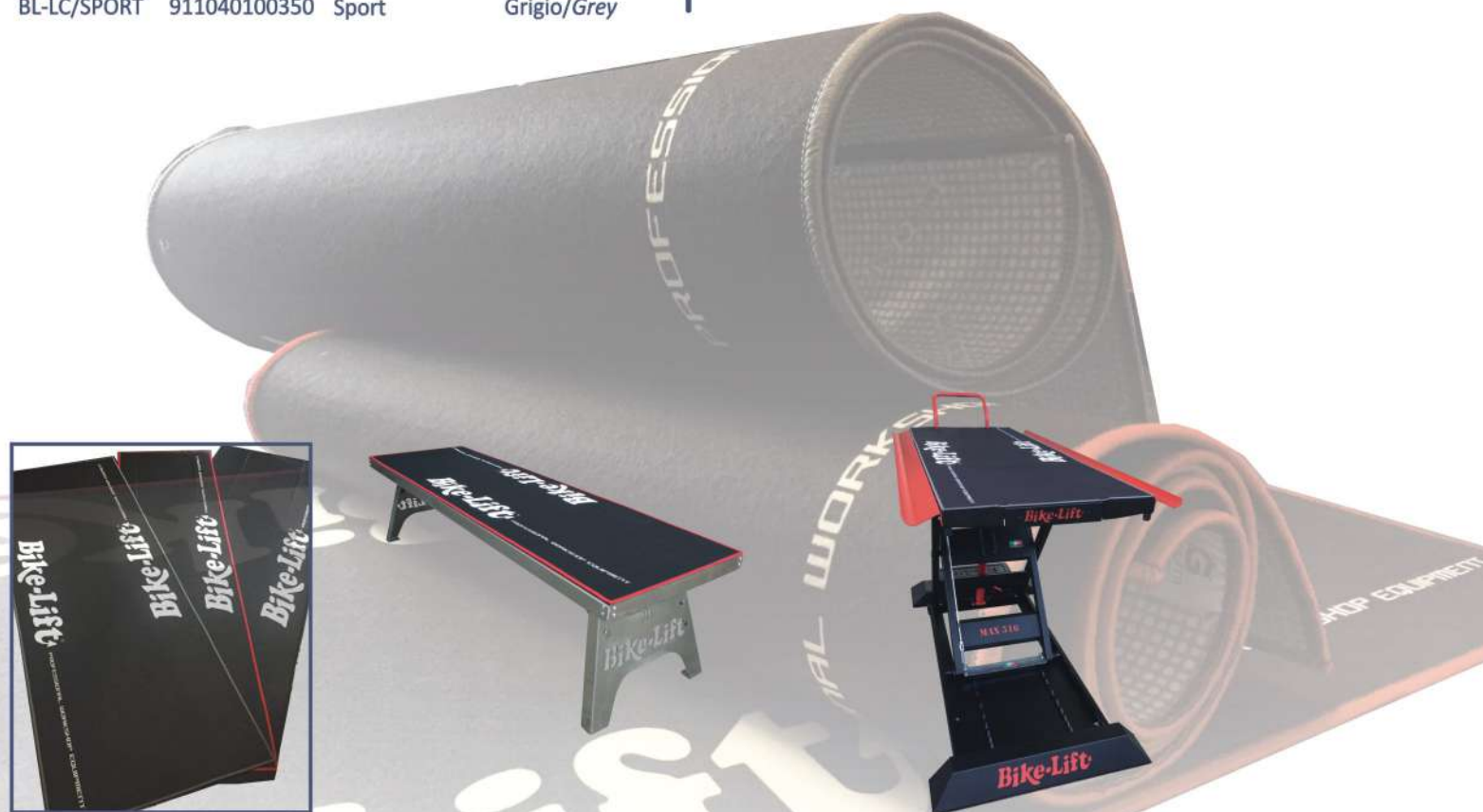

SOLLEVATORI CENTRALI *Central lifts*



CENTRAL STABILITY

PROGETTATO DA BIKE LIFT OLTRE 15 ANNI FA, il modello KODIAK 500 resta ancora oggi un sollevatore molto speciale sia in termini meccanici, progettuali e operativi. Il piano di sollevamento può ruotare di 360° quindi fornisce la migliore accessibilità durante l'intervento di manutenzione, sia su moto off-road che su Quads e ATV. Il sollevamento del veicolo avviene posizionando il piano di sollevamento al centro del telaio della moto o del quad, lasciando quindi completamente libere le ruote, le sospensioni e la trasmissione. Il KODIAK è estremamente stabile, anche alla massima estensione di 130 cm, grazie alla perfetta distribuzione dei carichi ed allo studio del baricentro variabile.

DESIGNED BY BIKE-LIFT MORE THAN 15 YEARS AGO, the KODIAK 500 nowadays still remains a very special lift in mechanical, design and operational terms. Its lifting platform can rotate 360° and therefore guarantees the best accessibility to the vehicle during servicing activities, be it an off-road bike or Quad chassis, leaving the wheels, suspensions and transmission completely free. The KODIAK is extremely stable, even at the maximum height of 130 cm, thanks to its perfect load distribution and the study of the variable barycenter.



KODIAK 500



KD-001	Pompa a Pedale / Foot Pump
KD-002	Pompa ad Aria / Air Pump
KD-003	Pompa Elettro-Idraulica / Electro-Hydraulic Pump
KD-004/R	Pompa Elettro-Idraulica con Comando Remoto / Electro-Hydraulic Pump w/Remote

Portata / Max load capacity	500 Kg / 1102 Lbs
Altezza Massima / Max Height	130 cm / 4.3 Ft
Altezza Minima / Min. Height	20 cm / 7.8 Inch.
Posizioni Sicura / Safety Position	12
Ingombro Totale Sollevatore / Overall Dimensions	190x78 cm / 6x2.5 Ft
Dimens. piano di sollevam. / Tabletop sizes	45x33 cm / 1.5x1 Ft
Peso / Weight	110 Kg / 242 Lbs



Centralina Elettro-Idraulica
Electro-Hydraulic Power Unit

Potenza / Power	1,1 Kw
Europa / Europe	230 Volts - 50 Hz
Giappone / Japan	200 Volts - 50/60 Hz
America / USA	110 Volts - 60 Hz

Pompa ad Aria / Air Pump

Pressione Aria / Air Pressure	7-10 Bar
Consumo Aria / Air Consumption	300L/Min

Imballo Std. / Std. Packing	
Scat. cartone con pallet legno / Cardboard w/ wooden crane	
Tappeto Gomma/Rubber Mat	1 pc

TINY BUT POWERFUL

IL PIU' PICCOLO SOLLEVATORE nella nostra gamma, progettato per l'utilizzo in spazi ristretti di intervento su Quad e ATV. La grande capacità di sollevamento fino a 400 kg permette di operare con accuratezza e sicurezza su ogni lato del veicolo. E' dotato di ruote e maniglia a sgancio rapido per la movimentazione all'interno dell'officina. Disponibile con pompa a pedale o con centralina elettro-idraulica.

THE SMALLEST LIFT in our range, designed for use on Quads and ATVs in narrow operating areas. Its high capacity up to 400 kg allows to work accurately and safely on each side of the vehicle. It is equipped with wheels and a quick-release handle for an easy displacement of the lift inside the workshop. It is available with foot-pump or electro-hydraulic pump unit with hand control.



HQL 400



HQL-001 | Pompa a Pedale / Foot Pump
HQL-003 | Pompa Elettro-Idraulica / Electro-Hydraulic Pump

Portata / Max load capacity	400 Kg / 880 Lbs
Altezza Massima / Max Height	80 cm / 2.6 Ft
Altezza Minima / Min. Height	23 cm / 9 Inch.
Posizioni Sicura / Safety Position	5
Dimens. piano di sollevam./ Tabletop sizes	53x36 cm / 20x14 Inch
Ingombro Totale Versione 003/Overall Dimensions type 003	88x50 cm / 2.8x1.6 Ft
Ingombro Totale Versione 001/Overall Dimensions type 001	78x50 cm / 2.5x1.6 Ft
Dimens. appoggio gomma / Rubber mat size	45x33 cm / 17x13 Inch
Peso / Weight	65 Kg / 143 Lbs



HQL-003

Centralina Elettro-Idraulica
Electro-Hydraulic Power Unit

Potenza / Power	1,1 Kw
Europa / Europe	230 Volts - 50 Hz
Giappone / Japan	200 Volts - 50/60 Hz
America / USA	110 Volts - 60 Hz

DOTAZIONE DI SERIE / STD EQUIP.

Imballo Std. / Std. Packing
Scat. cartone con pallet legno /
Cardboard w/ wooden crane

Maniglia di trasporto / Transport Handle	1 pc
Tappeto Gomma / Rubber Mat	1 pc

CFL 500



Ruote con freno
Braked Wheels

Codice / Item	CFL-500/Q
Larghezza / Width	38 cm
Portata Max./Max Load	500 kg
Azionamento/Action	pompa pedale foot pump
Altezza max./Max. Height	55 cm
Altezza min./Min. Height	21 cm
Posiz. Sicura/Safety locks	3



Versione Quad e ATV
Quad & ATV Model

Codice / Item	CFL-500
Larghezza / Width	38 cm
Portata Max./Max Load	500 kg
Azionamento/Action	pompa pedale foot pump
Altezza max./Max. Height	45 cm
Altezza min./Min. Height	11 cm
Posiz. Sicura/Safety locks	3



Ruote con freno
Braked Wheels

Versione Custom & Cruiser
Custom & Cruiser Model



HXL 160



Codice / Item	HXL-160
Larghezza / Width	33X45 cm
Portata Max./Max Load	160 kg
Azionamento/Action	pompa pedale foot pump
Altezza max./Max. Height	89 cm
Altezza min./Min. Height	39 cm
Molle Sicur./ Safety Hooks	2
Pos. Sicurezza/Safety Lock	4

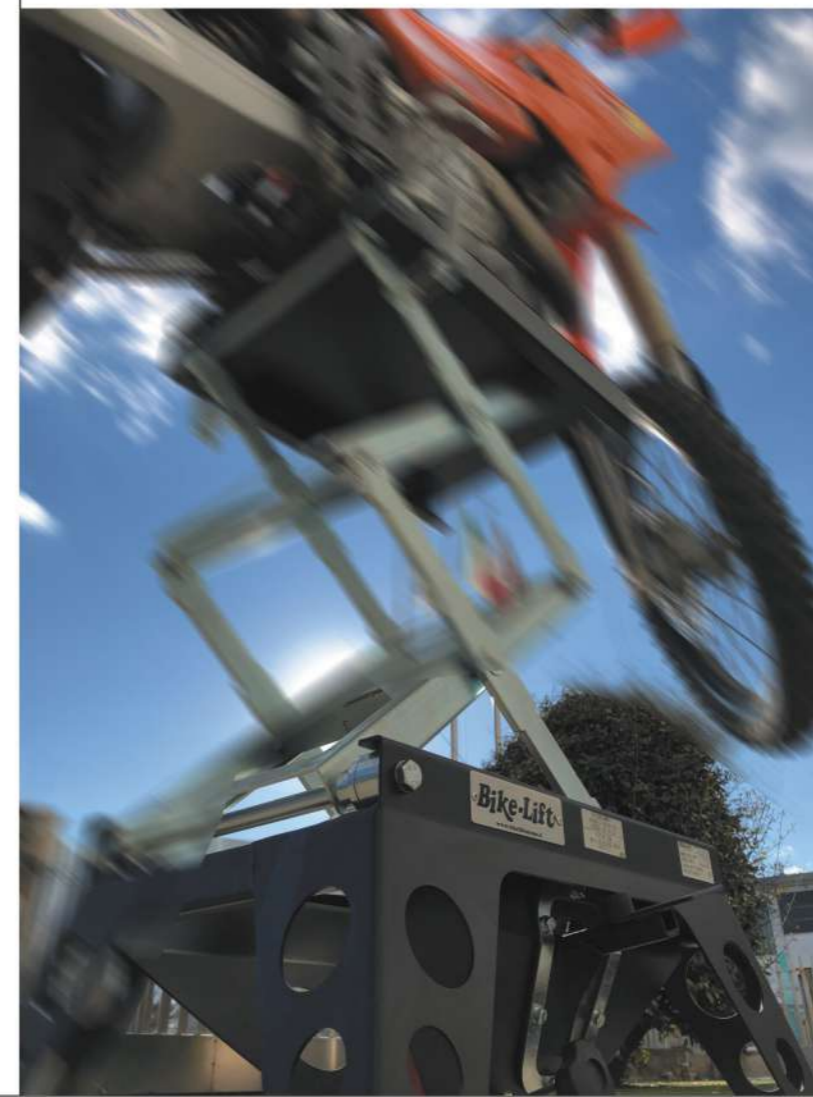

MCL-20

MCL-30

Bike-Lift
EUROPE

WARNING

NON UTILIZZARE MAI CHIAVI AD IMPULSO. POTREBBERO DANNEGGIARE LA VITE ED IL CUSCINETTO.
NEVER USE IMPACT WRENCHES AS THEY WOULD CHANGE THE THREADS AND BEARINGS.
NE JAMAIS UTILISER DE CLES A CHOC. ELLES POURRAIENT ENDOMMAGER LA VIS ET LE COUSINET A BILLES.
BENUTZEN SIE NEMALS SCHLAGSCHRAUBEN MIT DRUCKLUFTANTRIEB ZUR BETRIEBUNG. SIE KÖNNTEN DIE SPINDEL ODER DAS KUGELLAGER BESCHÄDIGEN.

DANGER

ASSICURARE LA MOTO CON CINGHIE DI SICUREZZA
FASTEN THE MOTORCYCLE WITH TIE DOWN

Codice / Item MCL-30

Larghezza / Width 25 cm
Altezza Max/Max Height 35 cm
Altezza Min./Min. Height 8.5 cm
Lunghezza/Length 40 cm
Portata Max/Max Load 500 kg
Azionamento Manuale
Manual Action



Codice / Item MCL-20

Larghezza / Width 15 cm
Altezza Max/Max Height 35 cm
Altezza Min./Min. Height 8.5 cm
Lunghezza/Length 40 cm
Portata Max/Max Load 500 kg
Azionamento Manuale
Manual Action



MCL-30



MCL-20

Supporti opzionali utilizzabili solo con il modello MCL-20 necessari quando non è possibile alzare la moto centralmente e bisogna quindi lavorare direttamente sulla parte inferiore del telaio.

Codice - Item
MCL-03A



Optional adapters only for MCL-20, to be used when it is not possible to lift the vehicle by its centre and so it is necessary to work directly on the bottom part of the frame.



MORSE

Wheel Clamps

W-38S



Codice / Item W-38 S

Regolabile/Adjustable
Azionamento Automatico / Automatic

Max Ruota/Max Wheel 21"
Min. Ruota/Min. Wheel 12"
Peso / Weight 12 kg
Azionamento/Action Automatic



W-42



Regolabile
Fully Adjustable



Codice / Item W-42
Max Ruota/Max Wheel 21"
Min. Ruota/Min. Wheel 12"
Dimensioni/Dimensions 36x61x40.5 cm
Peso / Weight 12 kg
Azionamento/Action Automatic

W-40



Codice / Item W-40

Apertura Max/Max Opening Range 225 mm
Apertura Min./Min. Opening Range 60 mm
Azionamento/Action Manual



W-36S



Codice / Item

W-36 S

Apertura Max/Max Opening Range
Apertura Min./Min. Opening Range
Azionamento/Action

205 mm
70 mm
Automatic



W-32N



Codice / Item

W-32 N

Apertura Max/Max Opening Range
Apertura Min./Min. Opening Range
Azionamento/Action

205 mm
55 mm
Pneumatic



W-34N



Codice / Item

W-34 N

Apertura Max/Max Opening Range
Apertura Min./Min. Opening Range
Azionamento/Action

215 mm
75 mm
Manual

MORSE PER FURGONI E TRAILER

WHEEL CLAMPS FOR VAN & TRAILERS



W-36F

Codice / Item	W-36 F
Lunghezza / Length	69 cm
Altezza / Height	43 cm
Peso / Weight	14 kg
Azionamento / Action	Automatic



W-38C

Codice / Item	W-38 C
Lunghezza / Length	67 cm
Altezza / Height	43 cm
Peso / Weight	8 kg
Azionamento / Action	Automatic



W-42

Codice / Item	W-42
Max Ruota/Max Wheel	21"
Min. Ruota/Min. Wheel	12"
Dimensioni/Dimensions	36x61x40.5 cm
Peso / Weight	12 kg
Azionamento/Action	Automatic



Regolabile
Fully Adjustable



W-28F

Codice / Item	W-28 F
Apertura Max/Max Opening Range	143 mm
Apertura Min./Min. Opening Range	51 mm
Peso / Weight	10 kg
Azionamento/Action	Automatic



**ATTREZZATURA
PER E-BIKE
E-BIKE
EQUIPMENT**

LEB-50 LIFT



LA NOSTRA IDEA DI SOLLEVATORE per le moderne biciclette, sia tradizionali che con pedalata assistita. Una struttura semplice ma efficace, con il suo sollevamento da 88cm fino a 198 cm di altezza e con un peso massimo di 50 kg. Dotato di una morsa rotante a 360° permette all'operatore di intervenire su qualsiasi punto del telaio in completo comfort ed efficacia. Fornito di vassoio porta attrezzi. Disponibile come optional un braccio superiore dotato di una potentissima lampada LED con attacco magnetico.

Codice - Item **LEB-50**

Capacità Max- <i>Max Capacity</i>	50 kg
Altezza Min.- <i>Min. Height</i>	88 cm
Altezza Max.- <i>Max. Height</i>	198 cm
Peso - <i>Weight</i>	70 kg



OUR LIFTING CONCEPT for modern bicycles, both standard and pedal-assisted. A simple but efficient structure, lifting from 95 cm up to 198 cm and with a maximum weight of 50 kg. Equipped with a 360° rotating clamp, this lift allows operators to work comfortably and efficiently on any part of the bicycle frame. A tool tray completes the standard equipment. As optional, an upper arm with a very powerful LED lamp with magnetic fitting is also available.

ELETTRICO con pulsantiera
Electric motion with hand control.

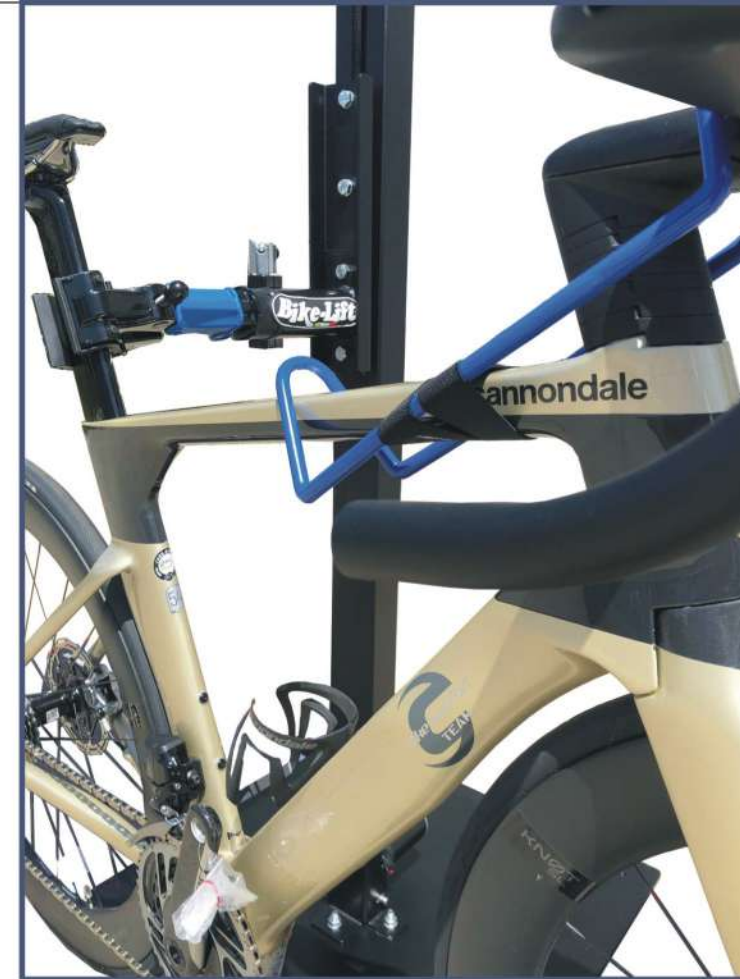

LEB-50 LIFT



Accessori in dotazione Equipment Included

Morsa girevole a 360°
360° Rotating Clamp

Vassoio Attrezzi
Tools Tray

Supporto Manubrio
Steering holder



Accessori Optional Optional Equipment

Braccio con luce LED magnetica, ricaricabile.
Autonomia 7 ore alla massima luminosità.

Extension arm with a magnetic, rechargeable LED light. 7 hours duration at max power.



MORSA DI TRASPORTO

W-29EB

LA morsa W-29EB è stata studiata per il trasporto in sicurezza delle E-Bike su furgoni o trailers. Si adatta a tutte le ruote fino a un diametro da 29" e sostiene la bicicletta in modo solido e sicuro. Grazie al peso della sua struttura non ha la necessità di essere fissata sul pianale del furgone o del trailer ed ha la possibilità di essere collegata con un'altra morsa a fianco, in modo da formare un rack estremamente stabile per il trasporto di più biciclette. L'estrazione della bicicletta è rapidissima, grazie al pedale di apertura.

The W-29EB wheel clamp has been developed for the transport of E-Bikes on trucks or trailers in full security. It is suitable for all wheels up to 29" and maintain firmly the bicycle. Thanks to its weight it doesn't need to be fixed on the truck or trailer flatbed and it has the possibility to be joined with another wheel clamp by a PVC connector so that it is possible to create a steady rack of clamps for the transport of 3 or 4 E-bikes together. The extraction of the bicycle is very fast thanks to the release pedal.



Connettore optional per collegare le morse

Optional connector to join the clamp to each other

Codice - Item

W-29EB CON

Codice - Item

W-29EB

Peso - Weight

10 kgs

CAVALLETTO POSTERIORE

Rear Stand

RS-EB PATENTED

Bike-Lift
EUROPE

E-BIKE Stand
PATENT



Il cavalletto RS-EB è un prodotto unico nel suo genere e deriva dalla nostra esperienza trentennale nel settore motociclistico. Oltre ad essere un solido e stabile cavalletto statico, l' RS-EB da anche la possibilità di poter effettuare interventi sulla ruota posteriore in quanto è completamente libera e sollevata da terra e quindi può girare. Questa funzione è assolutamente indispensabile quando si voglia fare la pulizia della catena, il settaggio o lubrificazione dei rapporti del cambio o semplicemente una pulizia profonda del mezzo. Il cavalletto RS-EB è disponibile in versione per carri simmetrici o asimmetrici.

Dimensioni : Larghezza / Width 35cm Lunghezza / Length 61cm Altezza / Height 37cm Peso / Weight 4,0 kg



The RS-EB stand is a unique product in its genre and origins from our thirty-years old experience in the motorcycle world. It is a steady and stable static stand, but it's unique feature is to give the possibility to make small mechanic and maintenance operations, because the rear wheel is lifted from the ground and completely free to spin. This feature is a must when it comes the time to clean the chain, the set-up or lubrication of gears or a simple high-pressure deep washing. The RS-EB is available in two versions : for symmetrical or non symmetrical rear forks.

SERVICE WORKSTATION

LA NOSTRA PROPOSTA di workstation è estremamente funzionale e modulare. Il kit è composto da un banco di lavoro con piano in acciaio inox, una cassettera da 5 cassetti, un cestino per carta, un modulo con rotolo carta ed un cestino per scarti metallici. La composizione può essere modificata o aumentata con altri moduli a scelta del cliente e può essere personalizzata con loghi a laser. Dotato di una pratica parete forata per gli attrezzi e due pensili con sportelli forniti di pistoncini a gas.



Codice - Item	Dimensioni - Dimensions
MF-BL BIKE2000	2000X800X900 H
MF-BL BIKE1620	1620X800X900 H

OUR PROPOSAL for a workstation is extremely functional and modular. The set is composed of a workbench with stainless steel working table top, a 5 drawers cabinet, a paper roll module and a bin for metal waste. The composition can be modified or increased with other modules chosen by the customer from our range and can be customized with laser-cut logos and brand names. It is equipped with a handy tool-holding wall grid and two hanging cupboards with gas strut doors.



Morsa girevole (optional)
Rotating Vice (optional)



**ARREDAMENTO
OFFICINA
WORKSHOP
FURNITURE**

MODOFLEX

Produced by Bike-Lift

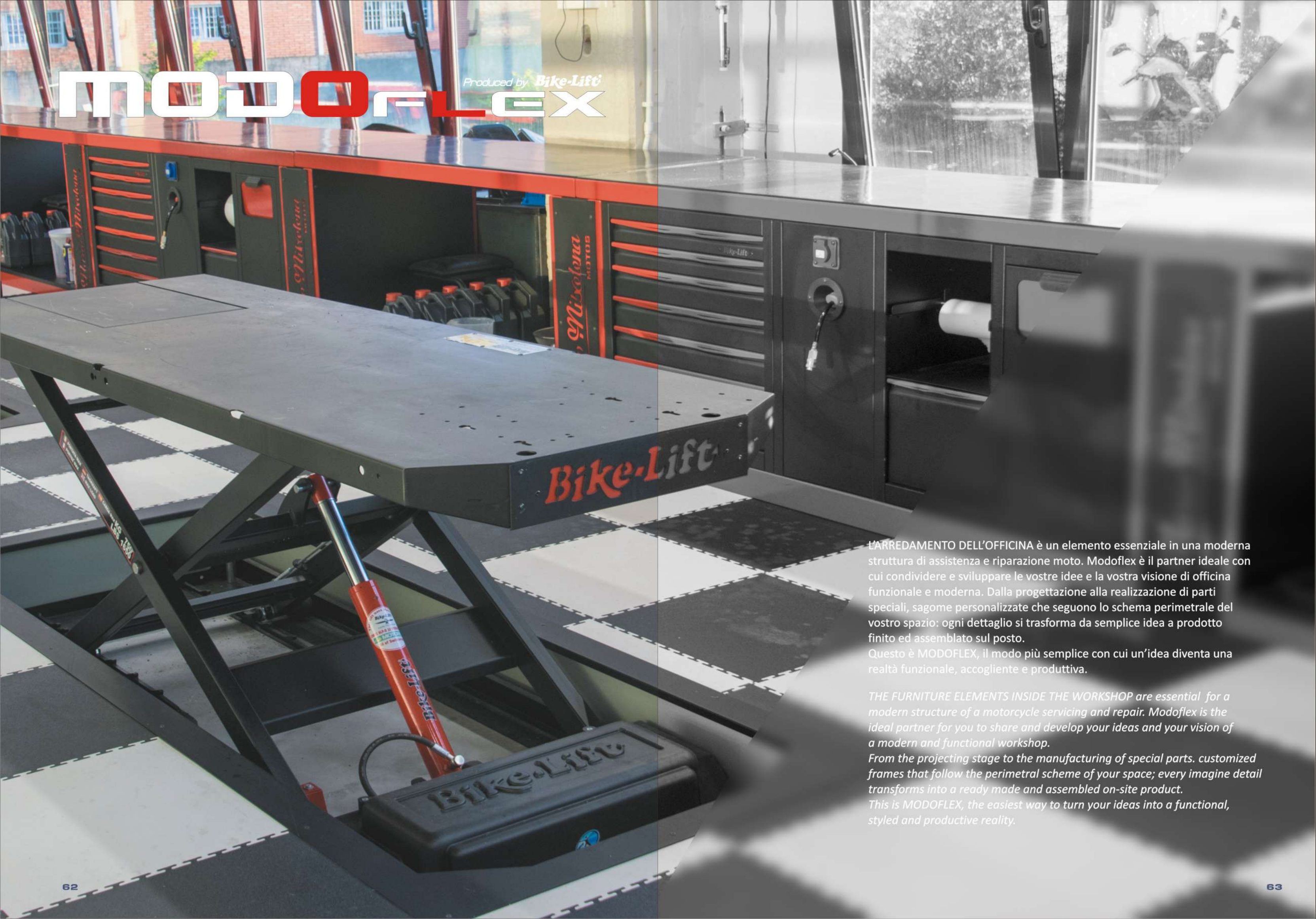

L'ARREDAMENTO DELL'OFFICINA è un elemento essenziale in una moderna struttura di assistenza e riparazione moto. Modoflex è il partner ideale con cui condividere e sviluppare le vostre idee e la vostra visione di officina funzionale e moderna. Dalla progettazione alla realizzazione di parti speciali, sagome personalizzate che seguono lo schema perimetrale del vostro spazio: ogni dettaglio si trasforma da semplice idea a prodotto finito ed assemblato sul posto. Questo è MODOFLEX, il modo più semplice con cui un'idea diventa una realtà funzionale, accogliente e produttiva.

THE FURNITURE ELEMENTS INSIDE THE WORKSHOP are essential for a modern structure of a motorcycle servicing and repair. Modoflex is the ideal partner for you to share and develop your ideas and your vision of a modern and functional workshop. From the projecting stage to the manufacturing of special parts, customized frames that follow the perimetral scheme of your space; every imagine detail transforms into a ready made and assembled on-site product. This is MODOFLEX, the easiest way to turn your ideas into a functional, styled and productive reality.

Banchi e Moduli MODOFlex
MODOFlex Workbenches and modules

Codice / Item	MF-BL 2000-01M	MF-BL 2000-01V	MF-BL 2000-03	MF-BL 2000-01V-L2
Versione / Version	Moduli/Modules	Ripiano/Shelf	Ripiano+Modulo/ Shelf+Module	Doppio Ripiano Double Shelf
Spazio Int./Internal Space	1750x695 mm	1750x695 mm	200x80x90h cm	200x80x90h cm
Dimensioni/Dimensions	200x80x90h cm	200x80x90h cm	200x80x90h cm	200x80x90h cm

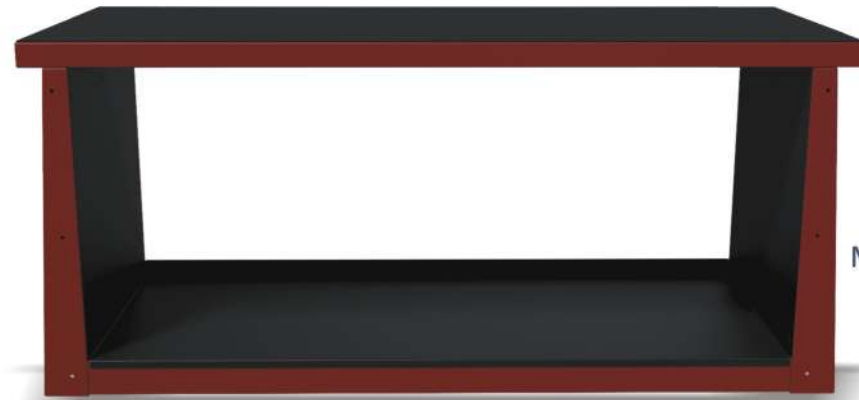

MF-BL 2000-01V

MF-BL 2000-01M



MF-BL 2000-03



MF-BL 2000-01V-L2

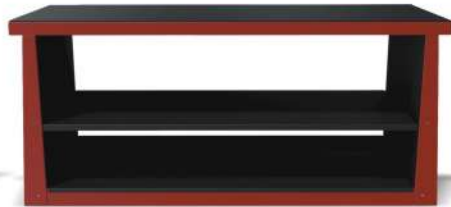

* modulo non incluso/module not included



Banco per carrello
(moduli non inclusi)
Workbench for drawers cabin
(modules not included)

Codice / Item	Dimensioni/Dimensions
MF-BL 2000-1MC	200x80x90h cm
MF-BL 1620-1MC	162x80x90h cm
MF-BL 1000-1MC	100x80x90h cm



Cassettiera c/ruote con
5 cassetti
5 Drawers cabin w/wheels
for workbench

Codice / Item	Dimensioni/Dimensions
MF-CB	67x46x81h cm



Banco a Penisola
T-Shaped workbench

Codice / Item	Dimensioni/Dimensions
MF-BL 2000 PE	290x80x90h cm

Codice / Item	MF-BL 1620-01M	MF-BL 1620-01V	MF-BL 1620-03	MF-BL 1620-01V-L2
Versione / Version	Moduli/Modules	Ripiano/Shelf	Ripiano+Modulo/ Shelf+Module	Doppio Ripiano Double Shelf
Spazio Int./Internal Space	1375x695 mm	1375x695 mm	162x80x90h cm	162x80x90h cm
Dimensioni/Dimensions	162x80x90h cm	162x80x90h cm	162x80x90h cm	162x80x90h cm

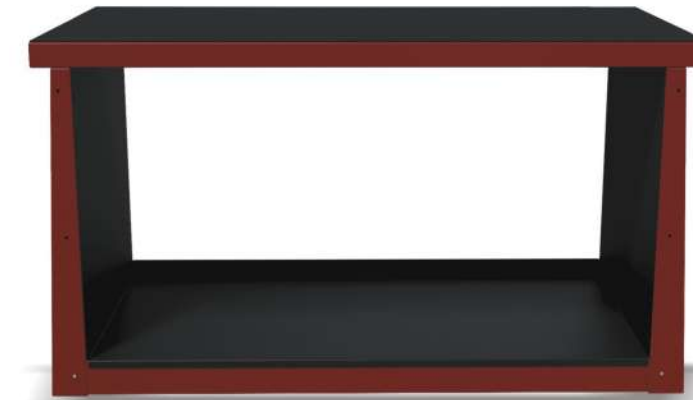

MF-BL 1620-01V

MF-BL 1620-01M



MF-BL 1620-03



MF-BL 1620-01V-L2

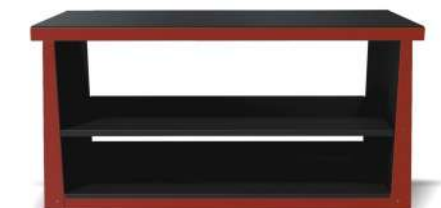

* modulo non incluso/module not included

Codice / Item	MF-BL 1000-01M	MF-BL 1000-01V	MF-BL 1000-01V-L2
Versione / Version	Moduli/Modules	Ripiano/Shelf	Doppio Ripiano Double Shelf
Spazio Int./Internal Space	1375x695 mm	1375x695 mm	162x80x90h cm
Dimensioni/Dimensions	162x80x90h cm	162x80x90h cm	162x80x90h cm



MF-BL 1000-01M



MF-BL 1000-01V-L2



MF-BL 1000-01V

MODULI - MODULES



Codice / Item Modulo 7 cassetti
MF-BL M1 7 Drawers Module



Codice / Item Modulo 5 cassetti
MF-BL M2 5 Drawers Module



Codice / Item Modulo Vano Sportello
MF-BL M3 con ripiano regolabile
Tool Tray w/door and adjustable tray



Codice / Item Modulo Bidone
MF-BL M4 Litter Module



Codice / Item Modulo Bidone XL
MF-BL M4-XL Wide Litter Module



Codice / Item Modulo 2 Ripiani
MF-BL M5 2 Shelves Module



Codice / Item Modulo Rotolo Carta
MF-BL M6 Paper Roller Module



Codice / Item Modulo Olio c/pistola
MF-BL M7 e arrotolatore 15 mt
Oil Module w/oil gun and 15mt hose reel



Codice / Item Modulo 6 Cassetti
MF-BL M13 6 Drawers Module



Codice / Item Modulo 2 Sportelli+
MF-BL M9 ripiano regolabile
2 Doors w/shelf and adjustable tray module



Codice / Item Modulo 2 Sportelli+
MF-BL M10 ripiano regolabile
2 Doors w/shelf and adjustable tray module



Codice / Item Modulo 5 Cass. Largo
MF-BL M12 Wide 5 Drawers Mod.

SCHEMA COMPOSIZIONE BANCHI
WORKBENCHES COMPOSITION SCHEME

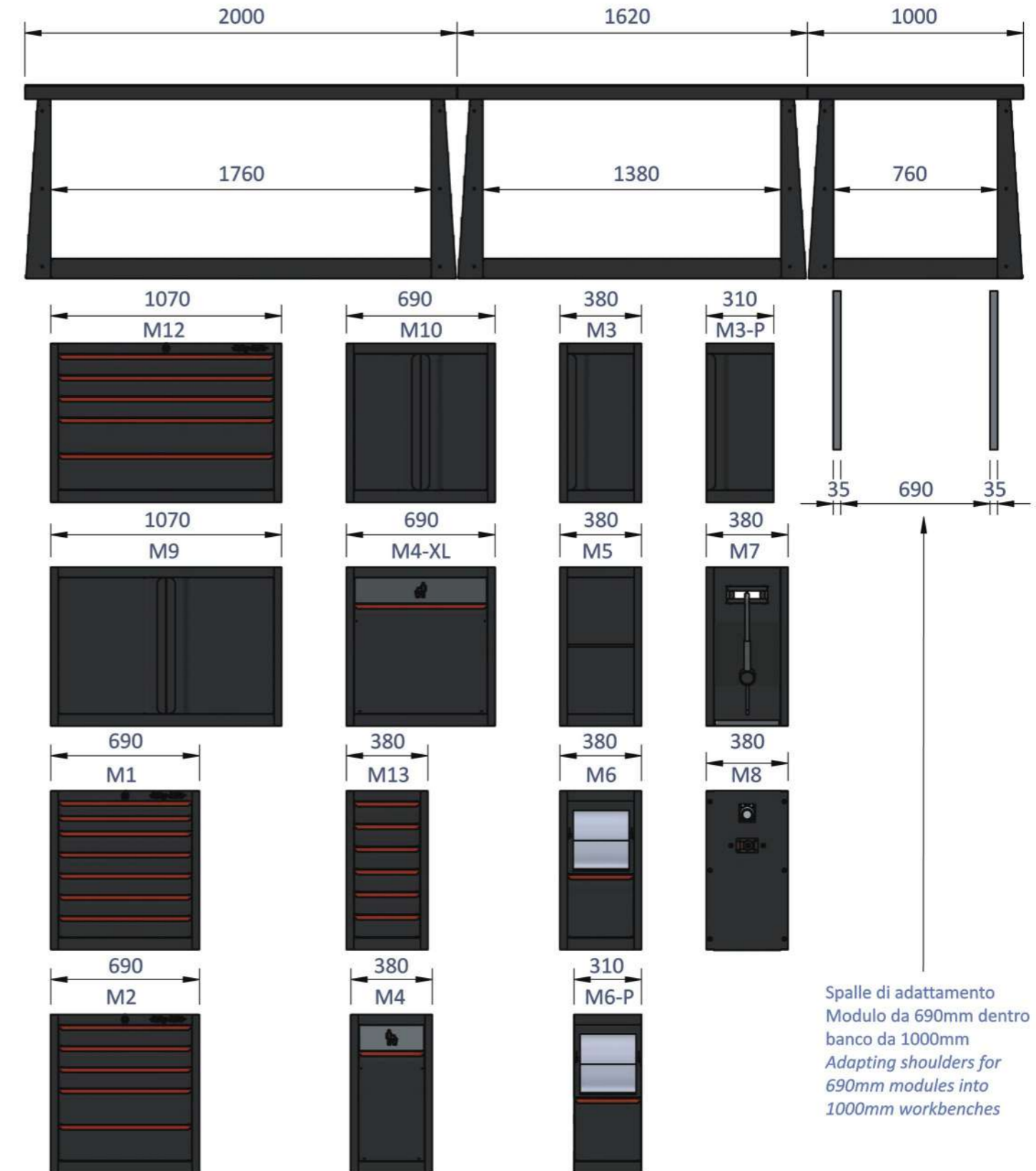

PANNELLI DI CONGIUNZIONE E UTILITA'
JUNCTION AND UTILITY PANELS



Pannello unione banchi con tubo aria e presa di corrente (inclusi)
Connection panel with 10mt air hose and electric plug (included)

Codice / Item	Dimensioni/Dimensions
MF-PU-AE	190x25x825mm



Pannello unione banchi con tubo aria e arrotolatore elettrico (inclusi)
Connection panel with 10mt air hose and 15mt electric reel (included)

Codice / Item	Dimensioni/Dimensions
MF-PU-AE2	190x25x825mm



Pannello angolare unione banchi con presa e tubo aria (inclusi)
Corner connection panel with electric plug and 10mt air hose(included)

Codice / Item
MF-PU-AEA



Pannello angolare unione banchi
Corner connection panel
Codice / Item
MF-PU-A



Pannello unione banchi con tre prese di corrente
Connection panel with 3 AC plugs electric plugs (included)

Codice / Item	Dimensioni/Dimensions
MF-PU-3	190x25x825mm



Pannello unione banchi con presa Schuko e cavo LAN e arrot. aria 10 mt(inclusi)
Connection panel with Schuko plug, LAN cable and air hose 10 mt (included)

Codice / Item	Dimensioni/Dimensions
MF-PU-ASL	190x25x825mm



Pannello unione banchi con logo
Connection panel with logo

Codice / Item
MF-PU-U

Tutti i pannelli con logo possono essere personalizzati a richiesta.
All panels with logo can be customized on demand.

ANGOLI ED ACCESSORI MODOFLEX
MODOFLEX CORNERS AND ACCESSORIES

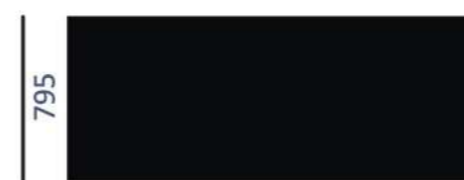

1995
Copertura gomma anti-olio
Oil-Resistant rubber cover

Codice / Item	Dimens./Dimensions
MF-PG2000-01/03	1995x795x3mm
MF-PG2000-01	1995x795x6mm

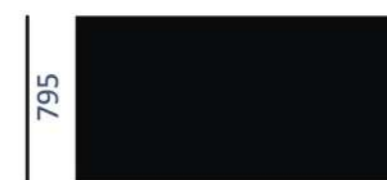

1610
Copertura gomma anti-olio
Oil-Resistant rubber cover

Codice / Item	Dimens./Dimensions
MF-PG1620-01/03	1610x795x3mm
MF-PG1620-01	1610x795x6mm



995
Copertura gomma anti-olio
Oil-Resistant rubber cover

Codice / Item	Dimens./Dimensions
MF-PG1000-01/03	995x795x3mm
MF-PG1000-01	995x795x6mm



Piano ad Angolo / *Corner Shelf*

Codice / Item	Dimensioni/Dimensions
MF-PANG-900	900x900 mm



Copertura gomma anti-olio per Piano Angolo
Oil-Resistant rubber cover for Corner Shelf

Codice / Item	Dimensioni/Dimensions
MF-PGANG-01/03	895x895x3 mm
MF-PGANG-01	895x895x6 mm

Codice / Item
MF-P-INOX

Piano di lavoro in acciaio disponibile per tutti i nostri banchi di lavoro
Worktable cover made of stainless steel available for all our workbenches

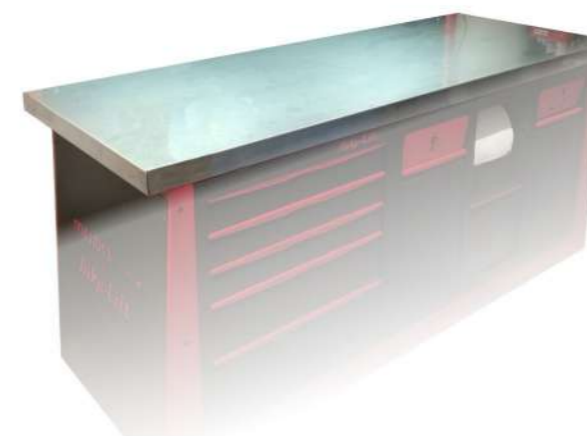

PANNELLI PORTA ATTREZZI E ACCESSORI
WALL TOOLS GRID AND ACCESSORIES

GRIGLIA PORTA ATTREZZI
WALL TOOLS GRID



Codice / Item Dimensioni/Dimensions
MF-PA2000-01 200x81x5 cm



Codice / Item Dimensioni/Dimensions
MF-PA1620-01 162x81x5 cm



Codice / Item Dimensioni/Dimensions
MF-PA1000-01 100x81x5 cm



Codice / Item Dimensioni/Dimensions
MF-BL LED800 L=800 mm
MF-BL LED1000 L=1000 mm

Luci magnetiche a led bianco ghiaccio da applicare sotto ai pensili.
Magnetic ice white led lights to position under the cupboards.

ARMADIO PORTA ATTREZZI CON
SERRANDA DI CHIUSURA A SERRATURA
TOOL TRAY WALL TOP CHEST WITH
PANEL AND LOCK



Codice / Item Dimensioni/Dimensions
MF-MA2000-01 200x100x20 cm

Codice / Item Dimensioni/Dimensions
MF-MA1620-01 162x100x20 cm

PENSILI
CUPBOARDS



Codice / Item Dimensioni/Dimensions
MF-BL M14 81x40x30 cm

Codice / Item Dimensioni/Dimensions
MF-BL M15 100x40x30 cm

GRIGLIE PER
PENSILI
GRIDS FOR
CUPBOARDS

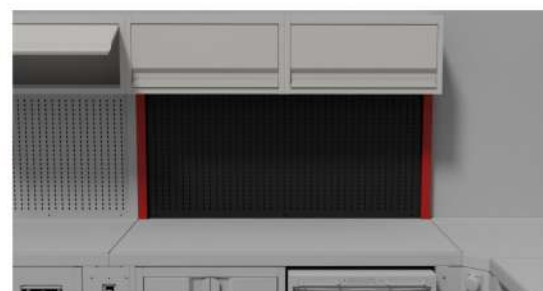

Codice / Item Dimensioni/Dimensions
MF-BL KGP1000 100x70.5x5.5 cm
MF-BL KGP1620 162x70.5x5.5 cm
MF-BL KGP2000 200x70.5x5.5 cm

PANNELLI PORTA ATTREZZI E ACCESSORI
WALL TOOLS GRID AND ACCESSORIES



Codice / Item Dimensioni/Dimensions
MF-AR 2000x1000x700 mm

Armadio con tre ripiani regolabili.
Wardrobe with three adjustable shelves



Codice / Item Dimensioni/Dimensions
MF-GPPLAST-08 diam.30mm L=75mm

Confezione / Package
Pezzo Sing./Single piece



Codice / Item Dimensioni/Dimensions
MF-GPPLAST-04 diam.5mm L=40mm

Confezione / Package
box 100 pcs



Codice / Item Dimensioni/Dimensions
MF-GPPLAST-07 diam.5mm L=50mm

Altezza/Height
45 mm Confezione / Package
box 100 pcs



Codice / Item Dimensioni/Dimensions
MF-GPPLAST-05 diam.5mm L=35mm

Occhiello/Eye
8 mm Confezione / Package
box 100 pcs



Codice / Item Dimensioni/Dimensions
MF-GPPLAST-06 diam.5mm L=38mm

Occhiello/Eye
14 mm Confezione / Package
box 100 pcs



Codice / Item Dimensioni/Dimensions
MF-GPPLAST-03 diam.5mm L=25mm

Confezione / Package
box 100 pcs



Codice / Item Dimensioni/Dimensions
MF-GPPLAST-02 diam.5mm L=55mm

Confezione / Package
box 100 pcs



Codice / Item Dimensioni/Dimensions
MF-GPPLAST-01 diam.5mm L=35mm

Confezione / Package
box 200 pcs



Codice / Item Dim./Dimens.
MF-GPMETAL01/P diam.5mm L=100mm

box 100 PCS

MF-GPMETAL02/P diam.5mm L=150mm

box 50 PCS

MF-GPMETAL03/P diam.5mm L=200mm

box 50 PCS



Codice / Item Dimensioni/Dimensions
MF-BPPUNTE-01 95x65x35mm



Codice / Item Dimensioni/Dimensions
MF-VATRASP-02 125x125x65mm



Codice / Item Dimensioni/Dimensions
MF-VATRASP-01 105x105x45mm



Set 142 pezzi chiavi a cricchetto
Set 142 pcs flank sockets
Codice / Item 214201
Mis. / Size 1/4"-3/8"

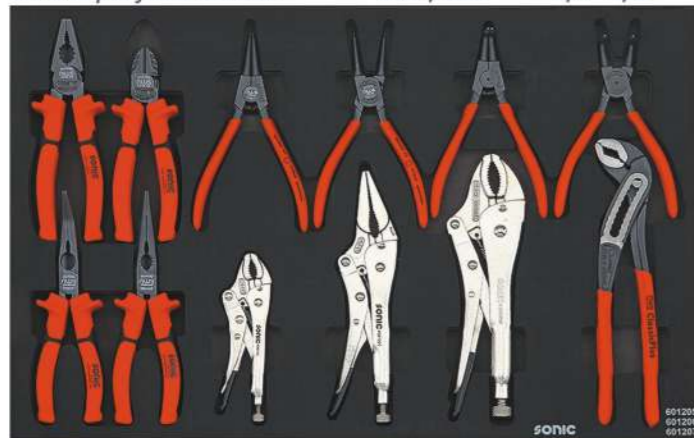

Set 12 pezzi pinze
Set 12 pcs pliers
Codice / Item 601207



Set 23 pz. mart./pinze/scalp./lime
Set 23 pcs hamm./plier/chisel/file
Codice / Item 602302 v.4

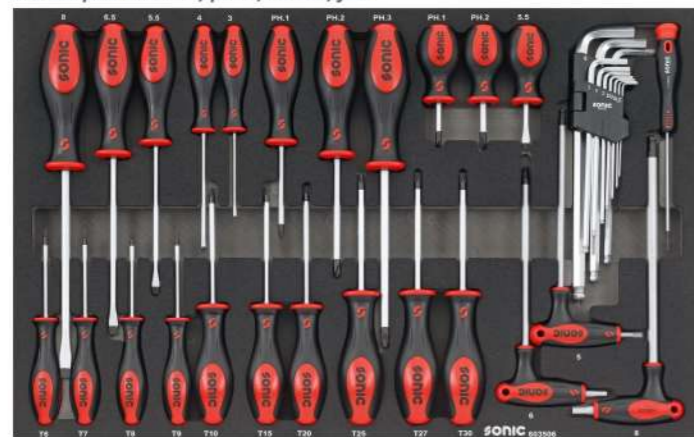

Set 35 pz. cacciaviti/brugole
Set 35 pcs screwdrivers
Codice / Item 603506



Set 93 pz. chiavi a cricc. SAE
Set 93 pcs SAE flank sockets
Codice / Item 309301 v.02
Mis. / Size 1/4"-3/8"-1/2"



Set 21 pz. cacc.bussola/viti esag.
Set 21 pcs socket scr./hex grip key
Codice / Item 602104



Set 31 pz. chiavi SAE
Set 31 pcs SAE wrenches
Codice / Item 603101



Set 40 pz. chiavi
Set 40 pcs wrenches
Codice / Item 604002 v.2

Scaffale per pneumatici appositamente studiato per lo stoccaggio delle gomme per moto e scooters. I ripiani possono essere regolati in 13 diverse posizioni.

Tyres shelf specifically designed for the storage of motorcycle and mopeds tyres. The shelves can be adjusted in 13 different positions.

Codice / Item Dimensioni / Dimensions
MF-SP1500-01 1500x2350x350 mm

MF-SP1500-01



MF-PD2000-01

Codice / Item Dimensioni / Dimensions
MF-PD2000-01 2000x1940x350 mm

Parete divisoria attrezzata con pannello porta attrezzi a due facce e due ripiani. Montato su ruote girevoli.

Double sided tool tray wall with shelves. Mounted on pivoting castors.



Carrello da officina con 3 ripiani
Workshop trolley with 3 shelves
Codice / Item Dimensioni / Dimensions
MF-CO670-01 670x875x370 mm



Carrello da officina con 3 ripiani
Workshop trolley with 3 shelves
Codice / Item Dimensioni / Dimensions
MF-CO900-01 900x1100x650 mm

VASCA LAVAPEZZI CABINATA
CABIN PARTS WASHER

Pompa ad alta presione da 160bar con pistola e selettore di azionamento sul pannello frontale.
Capacità operativa 9L/minuto.
Selettore di azionamento pompa a pressione per lavaggio con pennello.
Struttura esterna in ferro e vasca interna in acciaio INOX.

High pressure 160bar pump supplied with a washing gun operating through a front panel switch.
Operative capacity 9L/minute.



Brush cleaning operating with a low pressure pump with activation by a front panel switch.
External chassis made of iron and internal parts made of stainless steel.

Codice / Item	MF-PW1000-01
Dimensioni/ Dimensions	103x70x119 cm
Dimensioni Interne Internal Dimensions	600x800 mm
Capacità vasca Tank Capacity	80 L
Peso / Weight	100 kg

MODULI SPECIALI ED ACCESSORI BANCHI
SPECIAL MODULES & WORKBENCHES ACCESSORIES

Codice / Item MF-WOT



Modulo con vasca in acciaio INOX per il contenimento di olio esausto, dotato di pompa di aspirazione per lo svuotamento della vasca.
Fornita di pulsante a pressione di azionamento.

*Workshop module with stainless steel basin for exhausted oil.
Equipped with a suction pump to connect to the main waste oil container.
Supplied of a push button for the pump activation.*

Modulo con vasca in acciaio INOX per lo svuotamento dell'olio delle forcelle. Dotato di sportello per l'inserimento del contenitore in cui l'olio defluisce per gravità.

*Workshop module with stainless steel basin for the exhausted fork oil.
Equipped with a side door for the receiving tank in which the oil drains for gravity.*

PUNTO ATTREZZATO con presa Schuko (tedesca) presa LAN per computer e uno slot vuoto a scelta. Sistema di apertura POP-UP a scomparsa inseribile come optional su tutti i nostri banchi, anche con comando sollevatori..
RETRACTABLE POP-UP Schuko type power socket outlet with LAN network and free slot to be installed as optional on all our workbenches. Can be provided of up & down buttons to control the lift.



Codice-Item	MF-BL/POP
Dimensioni-Dimensions	120x142.5x5mm

Codice / Item MF-FOB



aprilia RACING TEAM GREVINI

RACING EQUIPMENT



MRA

Codice / Item	MRA
Larghezza / Width	565 mm
Altezza / Height	900 mm
Lunghezza / Length	1688 mm
Peso / Weight	83 kg



Frutto della lunga collaborazione fra Bike-Lift Europe ed il Team GRESINI nasce l' MRA in alluminio, creato per ottimizzare gli interventi nel box e minimizzare i costi di trasporto nelle trasferte internazionali della MotoGP.

Il modulo MRA ha un peso pari ad 1/3 di un modulo tradizionale, mantenendo le performances di robustezza e praticità necessarie ad un attrezzo a cui è richiesto ogni giorno di dimostrarsi professionale ed affidabile al 100%.

Created by the long cooperation between Bike-lift Europe and the GRESINI Team, the MRA has been developed to optimize the paddock operations and minimize the freight costs for the worldwide races of the MotoGP Championship.

The MRA module weighs 1/3 of a traditional one but offers the same performances of strength and practical use required by a tool that has to prove every day to be 100% professional and reliable.



100% ALLUMINIO

100% ALUMINIUM



Il modulo MRA può essere costruito con colori a scelta del TEAM ed è componibile con moduli diversi da quelli in foto.

The MRA module can be built with colors chosen by the TEAM and it can be assembled with other modules than those in the pictures.



MRA-MXGP



Codice / Item	MRA-MXGP
Larghezza / Width	565 mm
Altezza / Height	900 mm
Lunghezza / Length	1868 mm
Peso / Weight	88 kg

Versione del modulo racing MRA con un modulo con sportello (M3) anziché il pannello servizi.

Version of the racing module MRA featuring a module with door and shelf (M3)instead the services panel.

MRF



Codice / Item	MRF
Larghezza / Width	565 mm
Altezza / Height	900 mm
Lunghezza / Length	1688 mm
Peso / Weight	249 kg

Stesse caratteristiche costruttive del modello MRA ma costruito con lamiera di ferro anziché alluminio.

Pensato per i Team che non fanno gare internazionali e che quindi non devono sopportare costi di trasporto gravosi.

Anche questo modello può essere con i colori decisi dal Team e con moduli anche diversi da quelli in foto.

Same technical characteristics of the MRA model but built in metal plate instead of aluminium.

Developed for those Teams that do not compete internationally and don't need to save on weight for freight costs. This model can also be painted/coated at Team's choice and with modules different than those in the pictures.



photo courtesy BLACKFLAG Motorsport

MRS-MOTO3



Codice / Item	MRS-MOTO3
Larghezza / Width	565 mm
Altezza / Height	900 mm
Lunghezza / Length	1258 mm
Peso / Weight	138 kg

Scrivania da paddock AL-DK non inclusa
Paddock writing-desk AL-DK not included

L' MRS-MOTO3 è un altro dei numerosi prodotti sviluppati in collaborazione con il GRESINI Racing Team. Modulo dalle dimensioni più contenute rispetto ai precedenti, dal momento che deve posizionarsi ed essere operativo in spazi minori all'interno del paddock. Costruito in lamiera di ferro è molto compatto e modulabile sia in termini di colorazione che di servizi al suo interno.

The MRS-MOTO3 is another of the many products developed with the GRESINI Racing Team. It is a module featuring smaller sizes in comparison with the previous models, because it has to be positioned and be operative in smaller areas inside the paddock. Built with iron plate it is very compact and can be modulable in terms of color and services inside it.



photo courtesy GRESINI Junior TEam

AL-BN

Codice / Item	AL-BN
Larghezza / Width	60 cm
Altezza / Height	60 cm
Lunghezza / Length	200 cm
Peso / Weight	25 kg

Panca in alluminio pieghevole con rampa
Folding aluminium bench with ramp



photo courtesy GRESINI Junior Team



photo courtesy SIC58 Racing Team



Tappeto di protezione optional.
Rif. pagina 42.
Optional cover mat. See page 42.

AL-DK

Codice / Item	AL-DK
Larghezza / Width	70 cm
Altezza / Height	69 cm
Lunghezza / Length	150 cm
Peso / Weight	25 kg

Scrivania da paddock interamente in alluminio.
Dotata di gambe pieghevoli per il trasporto.
Completamente personalizzabile.

*Paddock writing-desk made in full aluminium.
Equipped with folding legs for the easy transport
and storage. Fully customizable.*



personalizzabile
customizable

AL-WT

Codice / Item	AL-WT
Larghezza / Width	55 cm
Altezza / Height	148 cm
Lunghezza / Length	140 cm

Porta pneumatici da Pitlane
Pitlane alu wheel trolley



MF-SR

Codice / Item	MF-SR
Peso / Weight	16 kg

Sedia racing da paddock
Racing char for paddock



FPS-25 HIGH

Codice / Item FPS-25 HIGH

Larghezza / Width 40 cm
Altezza / Height 810 cm
Lunghezza / Length 20 cm

Candelabri per pedane racing
Footpeg racing stand

RS-KALEX MOTO 2

Codice / Item RS-KALEX

Cavalletto posteriore per telaio KALEX moto 2
Rear stand for KALEX moto 2 frame



RS-MOTO 3

Codice / Item RS-MOTO 3

Cavalletto posteriore per MOTO 3
Rear stand for Moto 3



SUPPORTO MOTORE

Supporto per trasporto e stoccaggio motori con adattatori universali.
Support for the transport and storage of engines, with universal pin included.



Codice / Item SM-19

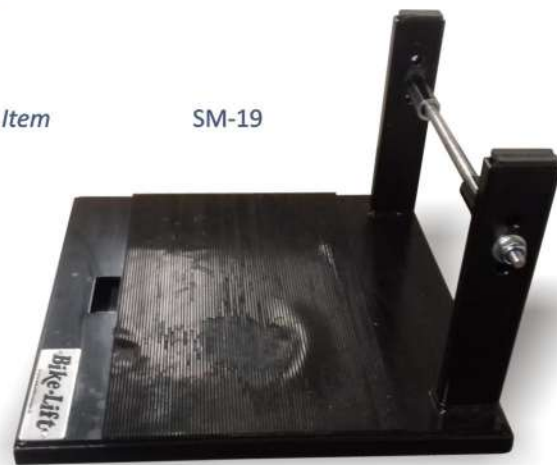

CAVALLETTI STANDS

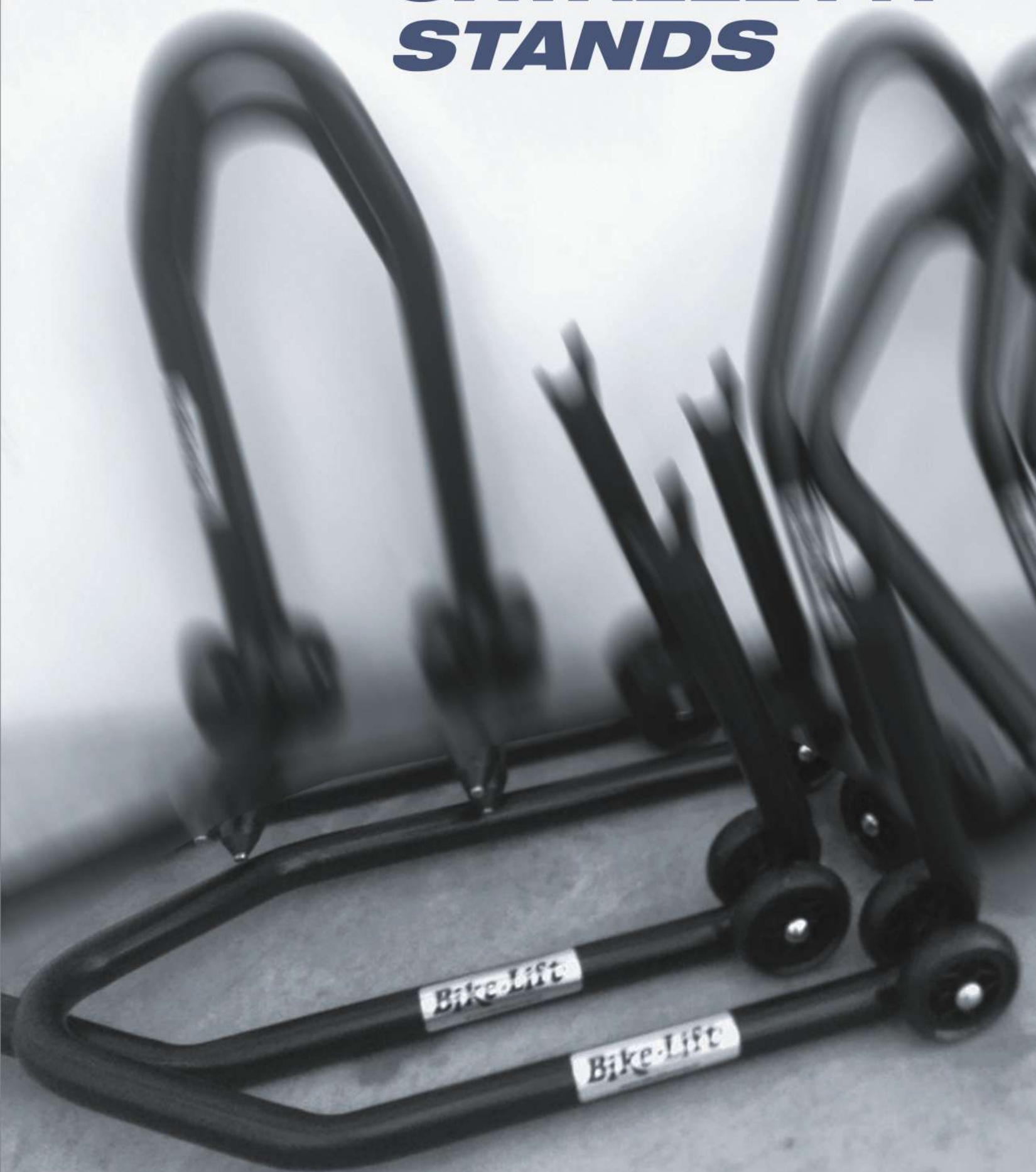

XXI RACING



Cavallo posteriore in edizione limitata sviluppato in collaborazione con il GRESINI Racing Team MotoGP, costruito interamente in alluminio.

Limited edition rear stand, developed in cooperation with the MotoGP GRESINI Racing Team, in full aluminium.

Codice / Item	XXI GR
Larghezza / Width	35.5 cm
Peso / Weight	4.2 kg
Lunghezza / Length	63 cm
Altezza / Height	34 cm

NON montare sulla moto quando il cavalletto è in uso.
DO NOT ride the motorcycle when the stand is in use



BLACK ICE

NON montare sulla moto quando il cavalletto è in uso.
DO NOT ride the motorcycle when the stand is in use



Supporto a cono
Underfork Adapter

Codice / Item BI-SC

Larghezza Max. / Max. Width 24 cm
Larghezza Min. / Min. Width 16 cm



Supporto a forchetta
V-Shaped Adapter

Codice / Item BI-SF

Larghezza Max. / Max. Width 36.5 cm
Larghezza Min. / Min. Width 29 cm



Supporto in gomma
Rubber Adapter

Codice / Item BI-SG

Larghezza Max. / Max. Width 33.5 cm
Larghezza Min. / Min. Width 27 cm



Supporto a rullo per pinze radiali
Roller adapters for radial calipers

Codice / Item BI-SAP

Larghezza Max. / Max. Width 23.5 cm
Larghezza Min. / Min. Width 15.5 cm



Supporto in gomma piccolo
Small rubber Adapter

Codice / Item BI-SGS

Larghezza Max. / Max. Width 23.5 cm
Larghezza Min. / Min. Width 15.5 cm



BLACK ICE RS cavalletto posteriore / rear stand

Codice / Item BI-RS



Larghezza / Width 52 cm
Peso / Weight 4.0 kg
Lunghezza / Length 67 cm
Altezza / Height 37 cm

BLACK ICE FS cavalletto anteriore / front stand

Codice / Item BI-FS



Larghezza / Width 41.5 cm
Peso / Weight 3.8 kg
Lunghezza / Length 68 cm
Altezza / Height 34 cm



Usare il cavalletto anteriore SOLO se già posizionato il cavalletto posteriore.
Use the front stand ONLY if the rear stand has been positioned first



PATENT DESIGN

FLUO & COLORED COLLECTION





Include
Included



Protezioni in gomma che hanno anche funzione di stabilizzare il cavalletto.
Protection pads that are also a mean to stabilize the stand.

FRONT STANDS

FS-10



NON montare sulla moto quando il cavalletto è in uso.
DO NOT ride the motorcycle when the stand is in use



Usare il cavalletto anteriore SOLO se già posizionato il cavalletto posteriore.
Use the front stand ONLY if the rear stand has been positioned first



FS-9



COLORI STANDARD
FACTORY COLORS



RAL 3002



RAL 9005

E' possibile realizzare altri colori Ral su richiesta per lotti minimi di produzione, sia per il tubolare che per le ruote.
It is possible to produce other RAL colors on demand and for MOQ of production, both for the pipe and the wheel-tyre.

FS-10 cavalletto anteriore / FS-10 front stand

Codice / Item FS-10



Larghezza / Width 43 cm
Peso / Weight 3.7 kg
Lunghezza / Length 67 cm
Altezza / Height 33 cm

FS-9 cavalletto anteriore / FS-9 front stand

Codice / Item BI-FS



Larghezza / Width 35 cm
Peso / Weight 3.0 kg
Lunghezza / Length 61 cm
Altezza / Height 32 cm

CODICE / ITEM SAG-10



Supporto in gomma
Rubber Adapter
Larghezza Span
Max.25cm
Min. 16cm

CODICE / ITEM SAP-10



Supporto a Rullo per Pinze Radiali
Roller Adapter
Larghezza Span
Max.23.5cm
Min. 15.5cm

Inserti rinforzati
Reinforced adapter head



CODICE / ITEM SAC-10



Supporto a Cono
Underfork Adapter
Larghezza Span
Max.24.5cm
Min. 16cm

CODICE / ITEM SAC-10/Y



Supporto a Cono
Underfork Adapter
Larghezza Span
Max.24.5cm
Min. 16cm

CODICE / ITEM SAR-10



Supporto a Rullo
Roller Adapter
Larghezza Span
Max.24cm
Min. 15cm

FRONT STANDS



Usare il cavalletto anteriore SOLO se già posizionato il cavalletto posteriore.
Use the front stand ONLY if the rear stand has been positioned first



FS-10/H

cavalletto alto per pinze radiali con supporti SBG-P
high stand for radial callipers with SBG-P adapters included



NON montare sulla moto quando il cavalletto è in uso.
DO NOT ride the motorcycle when the stand is in use

COLORI STANDARD
FACTORY COLORS



RAL 3002



RAL 9005

E' possibile realizzare altri colori Ral su richiesta per lotti minimi di produzione, sia per il tubolare che per le ruote.
It is possible to produce other RAL colors on demand and for MOQ of production, both for the pipe and the wheel-tyre.

FS-10/H-S

senza supporti / without adapters



FS-10/H cavalletto anteriore / FS-10/H front stand

Codice / Item FS-10/H

Larghezza / Width 36 cm
Peso / Weight 3.8 kg
Lunghezza / Length 62 cm
Altezza / Height 35 cm
Supporti inclusi SBG-10/P

FS-10/H cavalletto anteriore / FS-10/H-S front stand

Codice / Item FS-10/H-S

Larghezza / Width 36 cm
Peso / Weight 3.8 kg
Lunghezza / Length 62 cm
Altezza / Height 35 cm
Supporti inclusi SBG-10/P

CODICE / ITEM SAP-10



Supporto a Rullo per Pinze Radiali
Roller Adapter
Larghezza Span
Max.23.5cm
Min. 15.5cm

Inserti rinforzati
Reinforced adapter head



Include/Included



Protezioni in gomma che hanno anche funzione di stabilizzare il cavalletto.
Protection pads that are also a mean to stabilize the stand.

REAR STANDS

REAR STANDS



Bike-Lift
EUROPE



Incluse/Included

Protezioni in gomma che hanno anche funzione di stabilizzare il cavalletto.
Protection pads that are also a mean to stabilize the stand.



RS-17

senza adattatori
without adapters



NON montare sulla moto quando il cavalletto è in uso.
DO NOT ride the motorcycle when the stand is in use

RS-17/L

con supporti a forchetta inclusi/
with V-Shaped adapters
included



RS-17 cavalletto posteriore / RS-17 rear stand

Codice / Item	RS-17
Larghezza / Width	54 cm
Peso / Weight	3.9 kg
Lunghezza / Length	67 cm
Altezza / Height	34 cm

RS-17/L cavalletto posteriore basso / RS-17/L low rear stand

Codice / Item	RS-17/L
Larghezza / Width	54 cm
Peso / Weight	3.8 kg
Lunghezza / Length	70 cm
Altezza / Height	31 cm
Supporti inclusi Adapters included	SAF-10

COLORI STANDARD
FACTORY COLORS

RAL 3002



RAL 9005



E' possibile realizzare altri colori Ral su richiesta per lotti minimi di produzione, sia per il tubolare che per le ruote.
It is possible to produce other RAL colors on demand and for MOQ of production, both for the pipe and the wheel-tyre.



REAR STANDS



Nottolini in alluminio / Aluminium Bobbins



Include/
Included



Protezioni in gomma che hanno anche funzione di stabilizzare il cavalletto.
Protection pads that are also a mean to stabilize the stand.

NON montare sulla moto quando il cavalletto è in uso.
DO NOT ride the motorcycle when the stand is in use



Codice / Item	Colore/Color	Modello/Model
NA-M6/R	Rosso/Red	YAMAHA/APRILIA/TRIUMPH
NA-M6/B	Blu/Blue	YAMAHA/APRILIA/TRIUMPH
NA-M6/T	Titanio/Titanium	YAMAHA/APRILIA/TRIUMPH
NA-M6/N	Nero/Black	YAMAHA/APRILIA/TRIUMPH
NA-M8/R	Rosso/Red	SUZUKI/HONDA/DUCATI
NA-M8/B	Blu/Blue	SUZUKI/HONDA/DUCATI
NA-M8/T	Titanio/Titanium	SUZUKI/HONDA/DUCATI
NA-M8/N	Nero/Black	SUZUKI/HONDA/DUCATI
NA-M10/R	Rosso/Red	KAWASAKI
NA-M10/B	Blu/Blue	KAWASAKI
NA-M10/T	Titanio/Titanium	KAWASAKI
NA-M10/N	Nero/Black	KAWASAKI



Nottolini in alluminio KTM
Aluminium Bobbins for KTM
Codice / Item NA-M10/K

Codice / Item SBG-10
Supporto in Gomma
Rubber Adapter
Larghezza/Width Max. 34.5cm
Min. 27.5 cm



Codice / Item SAF-10
Supporto a forchetta
V-Shape Adapter
Larghezza/Width Max. 37 cm
Min. 30 cm

RS-17/XL

Supporti a forchetta inclusi
V-Shaped adapters included



RS-17/XL cavalletto post. Extra Basso
RS-17/XL Extra Low rear stand

Codice / Item	RS-17/XL
Larghezza / Width	58 cm
Peso / Weight	3.7 kg
Lunghezza / Length	70.5 cm
Altezza / Height	28.5 cm
Supporti Inclusi Supports Included	SAF-10



REAR STANDS



Include
Included



Protezioni in gomma che hanno anche funzione di stabilizzare il cavalletto.
Protection pads that are also a mean to stabilize the stand.

RS-17/TB



RS-17/TB cavalletto posteriore
Triumph Bonneville
RS-17/TB rear stand for
Triumph Bonneville

Codice / Item	RS-17/TB
Larghezza / Width	43 cm
Peso / Weight	2.8 kg
Lunghezza / Length	62 cm
Altezza / Height	36.5 cm



NON montare sulla moto quando il cavalletto è in uso.
DO NOT ride the motorcycle when the stand is in use

RS-17/Ducati Scrambler rear stand
RS-17/ Ducati Scrambler rear stand

Codice / Item RS-17/SCRAMBLER



Larghezza / Width 55 cm
Peso / Weight 3.8 kg
Lunghezza / Length 67 cm
Altezza / Height 30 cm

Supporti inclusi
Adapters included



RS-17/Scrambler

COLORI STANDARD
FACTORY COLORS

RAL 3002



RAL 9005



E' possibile realizzare altri colori Ral su richiesta per lotti minimi di produzione, sia per il tubolare che per le ruote.
It is possible to produce other RAL colors on demand and for MOQ of production, both for the pipe and the wheel-tyre.



REAR STANDS

RS-18/F



Include/Included

Protezioni in gomma che hanno anche funzione di stabilizzare il cavalletto.
Protection pads that are also a mean to stabilize the stand.



Codice / Item RS-18/F



Cavalletto Posteriore Fisso
Fixed Rear Stand

Larghezza / Width 41 cm
Peso / Weight 3.9 kg
Lunghezza / Length 63 cm
Altezza / Height 37.5 cm

Supporti Gomma Inclusi
Rubber Supports Included

COLORI STANDARD
FACTORY COLORS



E' possibile realizzare altri colori Ral su richiesta per lotti minimi di produzione, sia per il tubolare che per le ruote.
It is possible to produce other RAL colors on demand and for MOQ of production, both for the pipe and the wheel-tyre.

NON montare sulla moto quando il cavalletto è in uso.
DO NOT ride the motorcycle when the stand is in use



RS-18/G



Codice / Item RS-18/G



Cavalletto Posteriore Fisso
Fixed Rear Stand

Larghezza / Width 41 cm
Peso / Weight 3.9 kg
Lunghezza / Length 60 cm
Altezza / Height 31 cm

Supporti Forchetta Inclusi
V-Shape Supports Included

REAR STANDS



NON montare sulla moto quando il cavalletto è in uso.
DO NOT ride the motorcycle when the stand is in use

FPS-25



FPS-25 cavalletto posteriore pedane racing regolabile
FPS-25 adjustable rear stand for footpegs

Codice / Item FPS-25
Larghezza / Width 40 cm
Peso / Weight 3.0 kg
Lunghezza / Length 20 cm
Altezza Max. Max Height 43 cm
Altezza Min. Min. Height 37 cm

COLORI STANDARD
FACTORY COLORS



E' possibile realizzare altri colori Ral su richiesta per lotti minimi di produzione, sia per il tubolare che per le ruote.
It is possible to produce other RAL colors on demand and for MOQ of production, both for the pipe and the wheel-tyre.

RE-M Easy Mover rear stand
RE-M Easy Mover rear stand

Codice / Item RE-M

Larghezza / Width 64 cm
Peso / Weight 8.2 kg
Lunghezza / Length 73 cm
Altezza / Height 32.5 cm

Utilizzabile solo con adattatori SAF-10
Recommended with SAF-10 adapters only



RE-M

REAR STANDS



Include
Included



Protezioni in gomma che hanno anche funzione di stabilizzare il cavalletto.
Protection pads that are also a mean to stabilize the stand.

Codice / Item RS-S
Cavalletto Posteriore per Scooters
Mopeds rear stand



Larghezza / Width 54 cm
Peso / Weight 3.5 kg
Lunghezza / Length 57 cm
Altezza / Height 33 cm
Supporti Non Inclusi
Adapters not included

COLORI STANDARD
FACTORY COLORS

RAL 3002



RAL 9005



NON montare sulla moto quando il cavalletto è in uso.
DO NOT ride the motorcycle when the stand is in use



RS-S



Codice / Item RS-S-MI
Adattatore Minarelli
Minarelli Adapter

Codice / Item RS-S-PEU
Adattatore Peugeot
Peugeot Adapter



Codice / Item RS-S-PIA
Adattatore Piaggio
Piaggio Adapter



REAR STANDS



RS-16 cavalletto posteriore monobraccio
RS-16 Single Swing arm rear stand



RS-16

Codice / Item RS-16
Larghezza / Width 55 cm
Peso / Weight 5.6 kg
Lunghezza / Length 70 cm
Altezza / Height 42.5 cm

Perni non inclusi
Pins not included

COLORI STANDARD
FACTORY COLORS

RAL 3002



RAL 9005



NON montare sulla moto quando il cavalletto è in uso.
DO NOT ride the motorcycle when the stand is in use

E' possibile realizzare altri colori Ral su richiesta per lotti minimi di produzione, sia per il tubolare che per le ruote.
It is possible to produce other RAL colors on demand and for MOQ of production, both for the pipe and the wheel-tyre.

Perni / Pins



Codice / Item PMB-1200K
Modello / Model BMW
Diametro/Diameter 53mm



Codice / Item PMB-CB08-18
Modello / Model Honda CBR>2018
Diametro/Diameter 18.1mm



Codice / Item PMD-98/40
Modello / Model DUCATI
Diametro/Diameter 40.5 mm



Codice / Item PMD-01
Modello / Model DUCATI
Diametro/Diameter 21.8/25.9 mm



Codice / Item PMH-01
Modello / Model Honda
Diametro/Diameter 28.7 mm



Codice / Item PMH-CB08
Modello / Model Honda1000 CBR<2018
Diametro/Diameter 28.25 mm



Codice / Item PMM-01
Modello / Model MV AGUSTA
DUCATI
BMW
Diametro/Diameter 42.5 mm



Codice / Item PMT-01
Modello / Model Triumph-KTM S.Duke
Diametro/Diameter 27.5 mm



Include
Included



Protezioni in gomma che hanno anche funzione di stabilizzare il cavalletto.
Protection pads that are also a mean to stabilize the stand.

REAR STANDS



Include
Included



Protezioni in gomma che hanno anche funzione di stabilizzare il cavalletto. Protection pads that are also a mean to stabilize the stand.



RS-16/R

NON montare sulla moto quando il cavalletto è in uso.
DO NOT ride the motorcycle when the stand is in use



Codice / Item RS-16/R
Cavalletto Posteriore
Monobraccio Destro
Rear Single Swing Arm
right side



Larghezza / Width 55 cm
Peso / Weight 5.6 kg
Lunghezza / Length 70 cm
Altezza / Height 42.5 cm
Perni Non Inclusi
Pins not included

COLORI STANDARD
FACTORY COLORS

RAL 3002



RAL 9005



Codice / Item PMD-01/R
Modello / Model DUCATI
Diametro/Diameter 29.8 mm



Codice / Item PMB-650
Modello / Model BMW F650CS-F800-S/ST
Diametro/Diameter 30.0 mm



Codice / Item PMB-1200
Modello / Model BMW R1200 GS
Diametro/Diameter 51 mm



Codice / Item PMB-1200K
Modello / Model BMW
Diametro/Diameter 53 mm

CENTER STANDS

CS-24N cavalletto centrale
CS-24N Central Stand



Codice / Item CS-24/N

Larghezza / Width 56 cm
Peso / Weight 5.2 kg
Lunghezza / Length 48 cm
Altezza / Height 57 cm

Perni non inclusi
Pins not included



CS-24N

COLORI STANDARD
FACTORY COLORS

RAL 9005



E' possibile realizzare altri colori Ral su richiesta per lotti minimi di produzione, sia per il tubolare che per le ruote.

It is possible to produce other RAL colors on demand and for MOQ of production, both for the pipe and the wheel-tyre.



Codice / Item CS-VFR
Modello / Model HONDA VFR 1200



Include
Included



Protezioni in gomma che hanno anche funzione di stabilizzare il cavalletto. Protection pads that are also a mean to stabilize the stand.

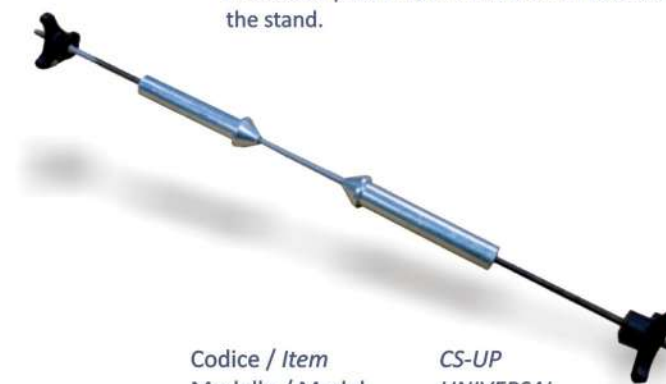

Codice / Item CS-UP
Modello / Model UNIVERSAL



NON montare sulla moto quando il cavalletto è in uso.
DO NOT ride the motorcycle when the stand is in use

CENTRAL STANDS



MCL-20

Codice / Item MCL-20

Larghezza / Width 15 cm
 Altezza Max/Max Height 35 cm
 Altezza Min./Min. Height 8.5 cm
 Lunghezza/Length 40 cm
 Portata Max/Max Load 500 kg
 Azionamento Manuale
 Manual Action

Supporti opzionali utilizzabili solo con il modello MCL-20 necessari quando non è possibile alzare la moto centralmente e bisogna quindi lavorare direttamente sulla parte inferiore del telaio.

Optional adapters only for MCL-20, to be used when it is not possible to lift the vehicle by its centre and so it is necessary to work directly on the bottom part of the frame.

Codice - Item
 MCL-03A



MCL-30

Codice / Item MCL-30

Larghezza / Width 25 cm
 Altezza Max/Max Height 35 cm
 Altezza Min./Min. Height 8.5 cm
 Lunghezza/Length 40 cm
 Portata Max/Max Load 500 kg
 Azionamento Manuale
 Manual Action

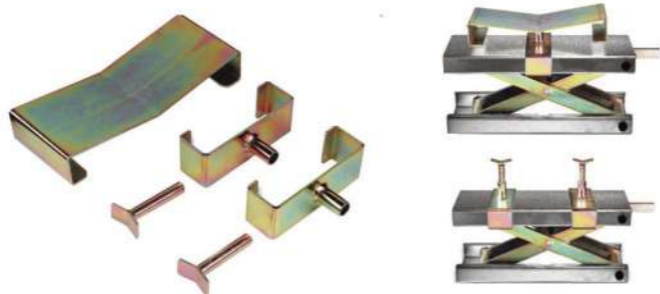

MCL-03A

WARNING

- I** NON UTILIZZARE MAI CHIAVI AD IMPULSO. POTREBBERO DANNEGGIARE LA VITE ED IL CUSINETTO.
- UNA GB** NEVER USE IMPACT WRENCHES AS THEY WOULD DAMAGE THE THREADS AND BEARINGS.
- F** NE JAMAIS UTILISER DE CLES A CHOC. ELLES POURRAIENT ENDOMMAGER LA VITE ET LE COUSSINET A BILLES.
- D** BENUTZEN SIE NIEMALS SCHLAGSCHRAUBEN MIT DRUCKLUFTANTRIEB ZUR BETÄTIGUNG. SIE KÖNNTEN DIE SPINDEL ODER DAS KUGELLAGER BESCHÄDIGEN.

DANGER

ASSICURARE LA MOTO CON CINGHIE DI SICUREZZA
FASTEN THE MOTORCYCLE WITH TIE DOWN



NON montare sulla moto quando il cavalletto è in uso.
 DO NOT ride the motorcycle when the stand is in use

CENTER STANDS



Versione Quad e ATV
 Quad & ATV Model

Versione Custom & Cruiser
 Custom & Cruiser Model



Codice / Item

CFL-500

Larghezza / Width 38 cm
 Portata Max./Max Load 500 kg
 Azionamento/Action pompa pedale foot pump
 Altezza max./Max. Height 45 cm
 Altezza min./Min. Height 11 cm
 Posiz. Sicura/ Safety locks 3



Codice / Item

CFL-500/Q

Larghezza / Width 38 cm
 Portata Max./Max Load 500 kg
 Azionamento/Action pompa pedale foot pump
 Altezza max./Max. Height 55 cm
 Altezza min./Min. Height 21 cm
 Posiz. Sicura/ Safety locks 3



CENTRAL STANDS



Codice / Item	HXL-160
Larghezza / Width	33X45 cm
Portata Max./Max Load	160 kg
Azionamento/Action	pompa pedale foot pump
Altezza max./Max. Height	89 cm
Altezza min./Min. Height	39 cm
Molle Sicur./ Safety Hooks	2



Utilizzare sempre la sicura meccanica dopo aver sollevato la moto sul cavalletto HXL, oltre ai due ganci di sicurezza.

Always use the mechanical safety after the motorcycle has been lift onto the HXL central stand. Use as well the two safety hooks.



PADDOCK STANDS



Codice / Item	WP-400
Larghezza / Width	46.8 cm
Peso / Weight	8.0 kg
Lunghezza / Length	51 cm
Altezza / Height	5.9 cm
Portata / Max Load	400 kg

WP-400

Piattaforma di Parcheggio
Wheel Parking Platform

Codice / Item	SE-400
Larghezza / Width	14 cm
Peso / Weight	6.0 kg
Lunghezza / Length	86.5 cm
Altezza / Height	6.5 cm
Portata / Max Load	400 kg



SE-400

Estensione cavalletto laterale
Extension for side stand

Codice / Item	RS-Q-400
Larghezza / Width	50 cm
Peso / Weight	4.2 kg
Lunghezza / Length	65 cm
Altezza / Height	36 cm



RS-Q

Cavalletto per Quad
Rear stand for Quad

ERGAL STANDS



NON montare sulla moto quando il cavalletto è in uso.
DO NOT ride the motorcycle when the stand is in use



RS-17/E

Codice / Item RS-17/E
Cavalletto Posteriore
Ergal con supporti
Ergal rear stand with
V-shape support
Larghezza / Width 54 cm
Peso / Weight 2.0 kg
Lunghezza / Length 67 cm
Altezza / Height 34 cm
Perni Inclusi
Pins included

Larghezza/Width
Max 37 cm
Min. 30 cm



Codice / Item FS-17/E
Cavalletto Anteriore Ergal
con supporti inclusi
Ergal front stand with
underfork support
Larghezza / Width 43 cm
Peso / Weight 1.9 kg
Lunghezza / Length 67 cm
Altezza / Height 33 cm
Adattatori Inclusi
Adapters included



Larghezza/Width
Max 24.5 cm
Min. 16 cm

FS-17/E



HEADSTOCK STANDS



FS-11

FS-11 cavalletto sottocanotto
FS-11 headstock stand

Codice / Item	FS-11
Larghezza / Width	48 cm
Peso / Weight	7.1 kg
Lunghezza / Length	63 cm
Altezza max / Max Height	82 cm
Altezza min / Min. Height	65 cm

COLORI STANDARD
FACTORY COLORS

RAL 3002



RAL 9005



PERNI / PINS



Il cavalletto FS-11 è disponibile in 2 versioni, una con il kit completo di 7 perni oppure con un solo perno a scelta del cliente. I codici sono :
FS-11 kit 7 perni 901030101100
FS-11 1 perno 901030101800

The FS-11 stand is available in 2 versions, one including the 7 pins full kit or in alternative with 1 pin only chosen by the customer.

I codici sono :
FS-11 kit 7 pins 901030101100
FS-11 1 pin 901030101800



NON montare sulla moto quando il cavalletto è in uso.
DO NOT ride the motorcycle when the stand is in use



HEADSTOCK STANDS



NON montare sulla moto quando il cavalletto è in uso.
DO NOT ride the motorcycle when the stand is in use



FS-11 Sport



Perno Universale Conico
Universal Cone Pin



Perno pivotante in Nylon
per Ducati e MV Agusta
Pivoting nylon pin for
Ducati and MV Agusta

Codice / Item FS-11/S
Cavalletto Sottocanotto
Headstock Stand

Larghezza / Width 37 cm
Peso / Weight 7.0 kg
Lunghezza / Length 57 cm
Altezza min.
Min. Height 65.5cm
Altezza Max.
Max Height 81.5cm
Perni Inclusi
Pins included

Codice / Item FS-11/NEW
Cavalletto Sottocanotto
Headstock Stand

Larghezza / Width 37.5 cm
Peso / Weight 11.7 kg
Lunghezza / Length 50 cm
Altezza Min.
Min. Height 65 cm
Altezza Max
Max Height 80 cm
Perni Inclusi
Pins included



Perno Universale Conico
Universal Cone Pin



Piastra Ducati e
MV Agusta
Ducati and MV Agusta
plate



FS-11 New

OFFROAD STANDS



PPE cavalletto cross
PPE Offroad stand

Codice / Item	PP/E PP/E-R
Larghezza / Width	24 cm
Lunghezza / Length	24 cm
Altezza / Height	43 cm
Portata / Load Cap.	150kg



KS-2012 Offroad
SKS-2012 Motard

Codice / Item	KS-2012
Larghezza / Width	21 cm
Lunghezza / Length	28 cm
Altezza Min./Min.Height	31.5 cm
Altezza Max./Max Height	43.3 cm
Portata/ Load Cap.	160 kg

Codice / Item	SKS-2012
Larghezza / Width	21 cm
Lunghezza / Length	28 cm
Altezza Min./Min.Height	25.7 cm
Altezza Max./Max Height	37.5 cm
Portata/ Load Cap.	160 kg



NON montare sulla moto quando il cavalletto è in uso.
DO NOT ride the motorcycle when the stand is in use



SVILUPPO OFFICINA Workshop Build-Up

Bike-Lift Europe fornisce ai propri clienti un servizio professionale nella realizzazione della propria officina, sia di nuovo allestimento che di riassetto.

Quando si decide di aprire un'officina moto, o semplicemente di rinnovare il proprio luogo di lavoro, è necessario avvalersi di un partner che possa garantire un servizio a 360°, affiancando il cliente non solo nella fornitura dei migliori materiali ma anche nella realizzazione e studio del progetto, affinché sia il più funzionale possibile. Un team di esperti della Bike-Lift Europe, dopo un primo sopralluogo dei locali ed un approfondito colloquio con il cliente, in cui verranno fissate le esigenze di tipo logistico e lavorativo (target, volume di lavoro, numero postazioni, tipologia di interventi sui veicoli etc.) dell'officina, svilupperà un progetto finalizzato al miglior allestimento possibile, in termini di efficacia ed efficienza. Il valore aggiunto che Bike-lift Europe offre ai propri clienti è quello di trovare in un unico interlocutore la competenza e professionalità mirate a poter garantire soluzioni idonee alla propria tipologia di lavoro, sfruttando al meglio lo spazio disponibile e garantendo un servizio studiato ad-hoc.

Bike-Lift Europe offers to its customers a professional service about the realization of the workshop, a new one or a refurbishing of an existing one.

When you decide to open a motorcycle workshop or just renovate your workplace, it is important to rely on a partner that can ensure an all-round service and support the client not only by supplying the best materials but also implementing the project. A Bike-Lift Europe team of experts will visit the premises and talk to the customer to pin-point logistic and work requirements (target, volume of work, number of bays, type of interventions on the vehicles etc.) and develop the project in order to obtain the best result possible in terms of effectiveness and efficiency. Bike-Lift Europe's added value is about providing a single interface to the customer that can ensure the best solution to meet all requirements, making use of all the available space and guaranteeing a tailor-made service that stands out for professionalism.

Bike-Lift[®]
EUROPE

BIKE-21N

CARATTERISTICHE TECNICHE TECHNICAL DETAILS

Smontagomme semi-automatico per motocicli, scooters quad, go-karts e macchine da giardinaggio. E' ideale per utilizzatori che necessitano di un sistema di stallonatura tradizionale. Il piatto auto-centrante permette di serrare cerchi da 6" a 24".

Le principale caratteristiche sono :

- Braccio orizzontale a ribaltamento laterale e bloccaggio manuale del braccio verticale porta utensile.
- Piatto auto-centrante avente capacità da 6" a 24" grazie a 3 differenti posizioni di bloccaggio facilmente selezionabili senza necessità di utensili.
- Sistema di stallonatura tradizionale dotato di specifica paletta con protezione.
- Torretta di montaggio con inserti in plastica per cerchi in lega.

Semi-automatic tyre changer, designed to mount and demount motorcycle, mopeds, ATV, Quads, Go-karts and turf vehicles. It is conceived for operators looking for a traditional bead breaking system. The self-centering turntable locks rims from 6" to 24" with the standard adapters supplied.

The main features are:

- Proven and reliable semi-automatic swing arm configuration and manual locking system of the vertical working arm.
- Self-centering turntable with capacity from 6" to 24" performing 3 different clamping positions easily selectable without the use of extra tools.
- Traditional bead braking system equipped with a specific rim protection cover.
- Tool head supplied with plastic protection inserts for alloy rims.



Smontagomme Semi-Automatiko
Semi-automatic Tyre Changer

Accessori in dotazione / Accessories included



Codice / Item
BIKE-21N/230V

Codice / Item
BIKE-21N/380V

Potenza / Power	230V	380V
Peso / Weight	174 kg	174 kg
Aria / Air	08-10bar	08-10bar
Pot. Motore/Engine Pwr.	0.75/1 Kw	0.75/1 Kw
Apert.Griffe/Clamp Range	6"-24"	6"-24"
Apertura Max Stallonatore/ Bead breaker max opening	310mm	310mm
Forza Stallonatore/Bead breaker Pwr.	2500kg	2500kg
Diam. Ruota Max./Max Wheel Diam.	960mm(37")	960mm(37")
Largh. Max Ruota/ Max Wheel width	250mm(10")	250mm(10")
Velocità rotazione/Rotation Speed	6 Rpm	6 Rpm
Dimensioni / Dimensions	1830x1060x1020mm	1830x1060x1020mm

BIKE-35N

CARATTERISTICHE TECNICHE TECHNICAL DETAILS

Smontagomme automatico professionale per motocicli, scooters, quad, go-karts e macchine da giardinaggio. E' ideale per utilizzatori che necessitano di un sistema di stallonatura tradizionale. Il piatto auto-centrante permette di serrare cerchi da 6" a 26".

Le principale caratteristiche sono :

- Palo verticale dotato di sistema recupero giochi a boccole coniche.
- Piatto auto-centrante a doppio senso di rotazione dotato di bielle curve per mantenere costante la forza di serraggio al variare del diametro del cerchio.
- Sistema di stallonatura tradizionale dotato di specifica paletta con protezione.
- Torretta di montaggio con inserti in plastica per cerchi in lega.

Automatic professional tyre changer, designed to mount and demount motorcycle, mopeds, ATV, Quads, Go-karts and turf vehicles. It is conceived for operators looking for a traditional bead breaking system. The self-centering turntable locks rims from 6" to 26" with the standard adapters supplied.

The main features are:

- Vertical post equipped with conic bushes to recover clearances which could appear after an intensive use of the machine.
- 2 ways rotation turntable clamping system which employs unique rod geometry to constant and even clamping power throughout all rim diameters.
- Traditional bead braking system equipped with a specific rim protection cover.
- Tool head supplied with plastic protection inserts for alloy rims.



Smontagomme Automatico
Automatic Tyre Changer

Accessori in dotazione / Accessories included



Codice / Item
BIKE-35N/230V

Codice / Item
BIKE-35N/380V

Potenza / Power	230V	380V
Peso / Weight	250 kg	250 kg
Aria / Air	08-10bar	08-10bar
Pot. Motore/Engine Pwr.	0.75/1 Kw	0.75/1 Kw
Apert.Griffe/Clamp Range	6"-26"	6"-26"
Apertura Max Stallonatore/ Bead breaker max opening	330mm	330mm
Forza Stallonatore/Bead breaker Pwr.	3000kg	3000kg
Diam. Ruota Max./Max Wheel Diam.	1000mm(39")	1000mm(39")
Largh. Max Ruota/ Max Wheel width	250mm(10")	250mm(10")
Velocità rotazione/Rotation Speed	6 Rpm	6 Rpm
Dimensioni / Dimensions	1720x1100x930mm	1720x1100x930mm

TBB-17/21



Codice / Item TBB-17/21

Stallonatore Manuale per gomme offroad.
Manual Offroad Tyre Charger.

Peso / Weight 8.0 kg
Diam.Ruota Max/ 21"
Max Wheel Diam. 21"
Dimensioni/Dimensions 78.5x31 cm

BIKE-SM



Codice / Item BIKE-SM
Smontagomme Manuale Portatile
Manual Portable Tyre Charger.

Peso / Weight 20.0 kg
Diam.Ruota 12" a 21"
Max Wheel Diam. 12" to 21"



Codice / Item BL-PSC-A
Colore / Color Arancio/Orange



BL-PSC-B Blu/Blue



BL-PSC-C Cromo/Chrome



BL-PSC-G Grigio/Grey



BL-PSC-N Nero/Black



BL-PSC-O Oro/Gold



BL-PSC-R Rosso/Red



BL-PSC-V Verde/Green



BL-PSC-W Bianco/White

Confezioni da 50 strisce da 45 gr l'una
Package of 50 stripes of 45 gr each

Codice / Item BL-51548



Monta valvole pneumatici
Revolving Nozzle

Codice / Item WR-27



Rimuovi piombi in plastica
Rim weight remover

Codice / Item BL-4980



Smonta valvole pneumatici
Stubby valve core remover

ACCESSORI SMONTAGOMME TYRE CHANGER ACCESSORIES

Codice / Item KA-7023

Protezione cerchioni
Rim protectors



Codice / Item BL-4320

Leva smontagomme 280mm
Tyre lever 280mm



Codice / Item BL-4330

Leva con protezione
Lever with plastic protection

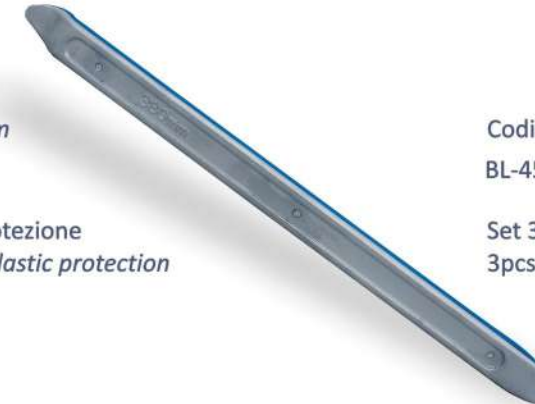

Codice / Item BL-4540

Set 3 leve professionali in acciaio
3pcs professional tyre iron levers



Codice / Item UCA

Kit n.4 griffe ruote da cross 5"-25"
4pcs off-road tyre clamps 5"-25"



Codice / Item ATV

Kit n.4 griffe bloccaggio ruote ATV
4pcs ATV tyreslocking clamps



**ACCESSORI
SMONTAGOMME**
TYRE CHANGER
ACCESSORIES



Codice / Item
CKM

Kit 4pz griffe bloccaggio
4pcs rim clamps kit



Codice / Item
GKS

Kit 4pz protezioni in
plastica per griffe
4pcs rim clamps plastic
protections kit



Codice / Item
PPM

Kit 6pz protezioni in
plastica stallonatrice
6pcs bead breaker
plastic protections kit



Codice / Item
KIT GK

Kit 4pz adattatori
bloccaggio ruote kart
4pcs kart wheels
locking adapters kit



Codice / Item
CUP

Corpo utensile in
plastica
Plastic demount
head



Codice / Item
UPA

Utensile in plastica
completo con attacco
rapido.
Plastic demount head
with fast-lock fitting



Codice / Item
TRS

Torretta in acciaio per
ruote scooter da 8"
8" Moped wheels s/steel
demount head

**ACCESSORI
SMONTAGOMME**
TYRE CHANGER
ACCESSORIES

Codice / Item
IP1-2K

Set 5pz inserti in plastica
per torretta 2K
5pcs demount head 2K
plastic inserts set



Codice / Item
IP2-2K

Set 5pz inserti in plastica
per torretta 2K
5pcs demount head 2K
plastic inserts set



Codice / Item
MC-98

Torretta in acciaio 13"-23"
13"-23" st. steel demount head



Codice / Item
BL-221618

Utensile in plastica
Plastic demount head



Codice / Item
DHF

Flangia per utensile
BL-221618
BL-221618 demount
head flange



Codice / Item
BL-10604

Pistola di gonfiaggio
con manometro
Inflating gun with
manometer



Codice / Item
BL-42599

Pistola di gonfiaggio con manometro
certificato
Certified inflating gun with manometer



Codice / Item
BL-69924

Manometro regolazione
pressione
Tyre pressure gauge



Codice / Item
BL-TL

1kg lubrificante per mont./
smontaggio pneumatici
1kg mount/demount tyre
lubricant grease



BIKE-62N

CARATTERISTICHE TECNICHE TECHNICAL DETAILS

Equilibratrice elettronica con programmi distinti per moto e quad. Presenta la caratteristica esclusiva di poter tarare unicamente la flangia moto senza il relativo gruppo meccanico, quindi con risultati più precisi. Sulla base sono predisposti dei supporti per ruote per poter rendere trasportabile la macchina, rendendola ideale per il servizio mobile. Per agevolare questi tipo di servizio la macchina può essere alimentata anche a 12-24V tramite l'apposito alimentatore fornito con presa per accendisigari auto. La macchina viene fornita con un corredo accessori completo per la messa in opera immediata e senza necessità di ulteriori accessori. Le caratteristiche principali sono:

- Lancio manuale della ruota.
- Acquisizione manuale dei dati geometrici della ruota.
- Freno di stazionamento a pedale.
- Calibrazione gruppo flangia senza il relativo gruppo meccanico.
- 2 programmi di bilanciatura ruote (statico e dinamico).
- Programma divisione pesi.
- Programma pesi nascosti.

Electronic wheel balancer featuring two separate balancing programs for motorcycles and quads. It has the unique feature of calibrating the single motorbike flange without its mechanical group, thus assuring a more accurate results. The base is provided of dedicated feet to which connect casters and so making the machine movable and ideal for a mobile service. To allow this service the machine can work with 12-24V with the use of a specific cable supply included in the accessories that can be plug into the car lighter socket. The machine is supplied with a comprehensive set of accessories for its immediate operativity, without the need of extra tools. The main features are:

- Hand spin of the wheel.*
- Manual acquisition of the geometric wheel data.*
- Mechanical pedal brake.*
- Flange calibration without the motorbike mechanical group.*
- 2 balancing programs (static and dynamic).*
- Split weight program.*
- Hidden weight program.*



Bilanciatrice Elettronica
Electronic Wheel Balancer

Codice / Item
BIKE-62N

Accessori in dotazione / Accessories included



Potenza / Power	230V
Peso / Weight	80 kg
Dimensioni / Dimensions	125x42x105 cm
Peso Max Ruota/Max Wheel weight	70 kg
Diam. Max ruota/Max diam. wheel	112 cm
Larghezza cerchio/Rim width	59 cm
Diam. Cerchio Impostabile / Settable Rim Diameter	8" - 35"
RPM	<100 rpm
Precisione Squilibrio/Balancing precision	1 gr
Velocità di equilibratura/Balancing Speed	5.5 sec.



Kit Bilanciamento Optional / Optional Balancing Kit

Flangia/Mandrino a innesto Cilindrico D.40	Carrier/Cylindrical insert chuck D. 40
Dado Esagonale	Hexagonal Nut
Albero moto D. 14mm	Motorbike shaft D. 14mm
Kit di fissaggio	Fixing Kit
Boccole 15mm-17mm-20mm	Centering sleeves 15mm-17mm-20mm
Cono centraggio standard	Standard centering cone
Cono centraggio 16-45mm	Centering cone 16-45mm
Bloccaggio rapido per perno D.14mm	Quick-lock for D. 14mm shaft
Dado Zigrinato	Knuled Nut
Tubo distanziatore 15mm	Spacing Sleeve 15mm
Boccola centraggio Piaggio-Vespa	Piaggio-Vespa centering sleeve
Tassello di spinta per BMW	BMW pressure piece
Prolunga tastatore interno	Prolonge for internal tester
Chiave a forchetta	Open-ended spanner

ACCESSORI BILANCIATRICE ELECTRONIC BALANCER ACCESSORIES

<p>Codice / Item A-141</p>  <p>Adattatore per BMW con perno D. 14mm <i>Adapter for BMW for D. 14mm pin</i></p>	<p>Codice / Item A-191</p>  <p>Adattatore Harley Davidson per perno D. 19mm <i>Adapter for Harley Davidson for D. 19mm pin</i></p>	<p>Codice / Item A-192</p>  <p>Adattatore Suzuki GSXR per perno D. 19mm <i>Adapter Suzuki GSXR for D. 19mm pin</i></p>
<p>Codice / Item A-193</p>  <p>Adattatore per Aprilia-BMW-Yamaha per perno D. 19mm <i>Adapter for Aprilia-BMW Yamaha for D. 19mm pin</i></p>	<p>Codice / Item A-194</p>  <p>Adattatore Harley-Davidson V-Road per perno D. 19mm <i>Adapter for Harley-Davidson V-Road for D. 19mm pin</i></p>	<p>Codice / Item A-195</p>  <p>Centraggio 25mm per perno D. 19mm <i>25mm centering adapter for D. 19mm pin</i></p>
<p>Codice / Item A-196</p>  <p>Centraggio 35mm per perno D. 19mm <i>35mm centering adapter for D. 19mm pin</i></p>	<p>Codice / Item A-197</p>  <p>Adattatore Honda 650-GL1800 per perno D. 19mm <i>Honda 650-GL 1800 for D. 19mm pin</i></p>	<p>Codice / Item A-198</p>  <p>Adattatore MV-Agusta perno D. 19mm <i>Adapter MV-Agusta for D. 19mm pin</i></p>
<p>Codice / Item A-199</p>  <p>Adattatore Ducati-Triumph per perno D. 19mm <i>Ducati-Triumph adapter for D. 19mm pin</i></p>	<p>Codice / Item BR-14 BR-19</p>  <p>Bloccaggio rapido per perno da 14mm o 19mm <i>Quick lock for 14mm or 19mm pin</i></p>	<p>Codice / Item PB14-B62 PB19-B62</p>  <p>Perno D. 14mm / Pin D. 14mm Perno D. 19mm / Pin D. 19mm</p>

BIKE-35N

Bilanciatrice Statica
Static Wheel Balancer



Bilanciatrice Statica
Static Wheel Balancer

Codice / Item
B-35N

Bilanciatrice statica utilizzabile su tutte le ruote fino a 21". Progettata per ottimizzare la logistica delle spedizioni, per facilitare il montaggio e per migliorare l'estetica ed il design, nonché completarne la funzionalità con nuovi accessori.

Veloce da montare, meno ingombrante e più leggera, la B-35N offre tutte le funzionalità necessarie nell'ambito della bilanciatura. Fornita con asta in acciaio da 12mm e coppia di coni con diametro massimo da 40mm. Fornita in scatola di montaggio.

Static balancer applicable on all kind of wheels till 21". Designed to obtain a better logistic size to have an easier assembling procedure, to achieve a better design and complete the functionality with new accessories.

Quick to assemble, reduced dimensions and lighter in weight, it offers all the necessary functionalities when working on wheel balancing. Supplied with a 12mm stainless steel shaft bar and a pair of cones with maximum diameter of 40mm. Supplied in assembling kit box.



Codice / Item
B-SR
KIT CENTRAGGIO PER
CERCHI A RAGGI
CENTERING KIT FOR
SPOKED RIMS



BL-124-00

Bilanciatrice Statica
Static Wheel Balancer



Bilanciatrice Statica
Static Wheel Balancer

Codice / Item
BL-124-00

Bilanciatrice statica completa di tutti gli accessori necessari al bilanciamento e centraggio dei cerchi della maggioranza dei modelli moto e scooters. E' fornita di asta in acciaio di 12mm di diametro con coni da 10" a 21", ruotante su cuscinetti a sfera in acciaio. Perni regolabili a punta conica da 16mm a 30mm ed asta per il centraggio dei cerchi a raggi con check-point a 90°. Fornita anche di livella a bolla incorporata. Fornita in scatola di montaggio.

Static balancer supplied with all necessary tools for the balancing and centering of the rims of almost all models of motorcycles and mopeds. It is supplied with a steel shaft bar of 12mm diameter with cones from 10" up to 21", spinning on stainless steel ball bearings, tapered cone axle stoppers from 16 up to 30mm and rim centering bar at 90°. It is equipped with a level-eye. Supplied in assembling kit box.



**ADATTATORI
BILANCIATRICE**
WHEEL BALANCER
ADAPTERS



Codice / Item
B-AU

Kit di 3 coni componibili e due dadi di fermo, che permette di lavorare su praticamente tutti i cerchi moto e scooter.
3 cones+2 nuts universal kit that allows to operate on almost all models of motorcycle and moped rims.



Codice / Item
B-A01

Adattatore monobraccio
Single sided swing-arm adapter



Codice / Item
B-A03

Adattatore maxi scooters diam. 10mm
Maxi scooters adapter diam. 10mm



Codice / Item
B-A05

Adattatore BMW dal 2006 in poi.
BMW adapter for models from 2006 onwards



Codice / Item
B-A00

Adattatore standard diam. 12mm
Standard adapter diam. 12mm



Codice / Item
B-A02

Adattatore BMW
BMW adapter



Codice / Item
B-A04

Adattatore Piaggio X9
Piaggio X9 adapter



Codice / Item
BL-124-01

Adattatore BMW 1200.
BMW 1200 adapter.

ES-06



SUPPORTO MOTORE CON RUOTE
ENGINE STAND WITH CASTERS

ACCESSORI OPZIONALI
OPTIONAL ACCESSORIES



Flangia per motori DUCATI
DUCATI engines flange

**CARATTERISTICHE TECNICHE
TECHNICAL DETAILS**



DIMENSIONI / DIMENSIONS
PESO / WEIGHT

50x70x120 cm
25 kg

Codice / Item
ES-06



Flangia per motori maxi scooters
Maxi scooters flange

SA-07



Codice / Item SA-07

SMONTA AMMORTIZZATORI
SHOCK ABSORBER DISASSEMBLER

Peso / Weight 20 kg
Dimensioni/Dimensions 25X25X100 cm

Adattatori in Dotazione Standard
Standard included adapters



- Diametro/Diameter 45 mm
- Diametro/Diameter 47 mm
- Diametro/Diameter 50 mm
- Diametro/Diameter 53 mm
- Diametro/Diameter 56 mm
- Diametro/Diameter 59 mm
- Diametro/Diameter 62 mm
- Diametro/Diameter 66 mm
- Diametro/Diameter 68 mm
- Diametro/Diameter 71 mm
- Diametro/Diameter 75 mm
- Diametro/Diameter 77 mm
- Diametro/Diameter 80 mm
- Diametro/Diameter 83 mm
- Diametro/Diameter 87 mm



PSB-20



CARATTERISTICHE TECNICHE
TECHNICAL DETAILS

PRESSA IDRAULICA 20 TON
20 TONNE HYDRAULIC PRESS

DIMENSIONI / DIMENSIONS 170x85 cm
PESO / WEIGHT 150 kg
CORSO CILINDRO / STROKE 26 CM
DIMENS. INT. / INT. DIM. 50 CM

Codice / Item PSB-20



VASCA LAVAPEZZI MOBILE 60L
MOVABLE PARTS WASHER 60L



VASCA LAVAPEZZI 138L
STATIONARY PARTS WASHER



Codice / Item 5904

Alimentazione/Voltage 230V
Potenza/Power 60 W
Press. Max/Max. Pressure 0.5 bar
RPM 2800
Protezione/Protection IP 54
Cap.vasca totale/Basin total cap. 138 L
Cap.utile /Working capacity 62 L
Dimensioni/Dimensions 50x70x112 cm
Peso/Weight 53 kg



Codice / Item 5953

Aliment./Air Supply 4 bar
Press. Max/Max. Pressure 4 bar
Cap.vasca tot./Basin cap. 60 L
Dimensioni/Dimensions 56x70x81cm
Peso/Weight 36 kg

**ATTREZZATURE
EQUIPMENT**



AM40/315

AM80/8
AM85/8



Codice / Item AM80/8

Cavo aria da 10mt con tubo in PU
Air Hose 10mt with PU tube

Codice / Item AM85/8

Cavo aria da 15mt con tubo in PU
Air Hose 15mt with PU tube

Codice / Item AM40/315

Cavo elettrico D.2mm 3Gx1.5mm con
protezione anti-riscaldamento.
Cavo interno 15mt + 1mt esterno
Electric cable D. 2mm 3Gx1.5mm with
over-heat protection.
Int. cable 15mt +1 mt external



Contenitore olio Usato
Waste Oil tank



Contenitore Batterie Usate
Waste Accumulator Tank



Codice / Item BT-300

Capacità/Capacity 297L-300kg
Dim. Int./Int. Dim. 94x64x50cm
Dimens./Dimensions 100x70x65cm

Codice / Item EXOIL-300
Codice / Item EXOIL-500
Capacità/Capacity 300 L / 500 L
Altezza/Height 108cm/124cm
Diam./Diam. 82cm / 96cm



Recuperatore Olio
Oil Drainer Recover



Codice / Item 3183

Cap.Vasca/Basin Cap. 10 L
Cap. Recup./Recovery Cap. 65 L
Press./Pressure 0.5 bar
Alt. Max/Max Height 140 cm
Peso/Weight 30 kg
Dimensioni/Dimensions 45x57x120cm



Base di Contenimento
Spill containment base



Codice / Item 8524/SE

Peso / Weight 55 kg
Dimens./Dimensions 92x83x34cm

**ATTREZZATURE
EQUIPMENT**



Base di contenimento per 2 fusti
2 drums spill containment base



Codice / Item 8532/E
Peso/Weight 35 kg
Dimens./Dimensions 135x83x34 cm

Codice / Item ECO-T10



Capacità/Capacity 10 L
Dimens./Dimensions 57X32X13cm



Tanica Olio Esausto 10 L
10 L Waste Oil Tank



Tanica Olio Esausto 12 L
12 L Waste Oil Tank

Codice / Item ECO-T12



Capacità/Capacity 12 L
Dimens./Dimensions 57X37X13.5cm



Vasca Olio Esausto per Scooter
Moped Waste oil Pan



Codice / Item BL-04265

Capacità/Capacity 3 L
Peso / Weight 1.5 kg



RAMP-4000

Codice / Item	RAMP-4000
Lunghezza/Length	240 cm
Larghezza/Width	28 cm
Altezza bordo/ Edge Height	50 mm
Peso/Weight	7 kg
Portata/Capacity	Max 340 kg

DISPONIBILE ANCHE IN VERSIONE
COLORATA DA ABBINARE AL COLORE
DEL PROPRIO VEICOLO.

COLORED VERSION ON DEMAND
TO MATCH THE COLOR OF YOUR
OWN VEHICLE



Codice / Item	TD-1B
Lunghezza/Length	180 cm
Tenuta / Max Strength	500 kg



Confezione da 2 pz
2 pcs rack pack



Confezione da 2 pz
2 pcs rack pack



Codice / Item	R-1B
Lunghezza/Length	360 cm
Tenuta / Max Strength	500 kg

Codice / Item	RTD-6
Lunghezza/Length	180 cm
Tenuta / Max Strength	700 kg



Automatica
Automatic

MORSE PER FURGONI E TRAILER

WHEEL CLAMPS FOR
VAN & TRAILERS

W-36F



Codice / Item: W-36 F
Lunghezza / Length: 69 cm
Altezza / Height: 43 cm
Peso / Weight: 14 kg
Azionamento / Action: Automatic



W-38C



Codice / Item: W-38 C
Lunghezza / Length: 67 cm
Altezza / Height: 43 cm
Peso / Weight: 8 kg
Azionamento / Action: Automatic



W-42



Codice / Item: W-42
Max Ruota/Max Wheel: 21"
Min. Ruota/Min. Wheel: 12"
Dimensioni/Dimensions: 36x61x40.5 cm
Peso / Weight: 12 kg
Azionamento/Action: Automatic



W-28F



Codice / Item: W-28 F
Apertura Max/Max Opening Range: 143 mm
Apertura Min./Min. Opening Range: 51 mm
Peso / Weight: 10 kg
Azionamento/Action: Automatic



W-29EB



Codice / Item: W-29 EB
Apertura Max/Max Opening Range: 143 mm
Apertura Min./Min. Opening Range: 51 mm
Peso / Weight: 10 kg
Azionamento/Action: Automatic



Per moto da Cross
Dirt Bike only

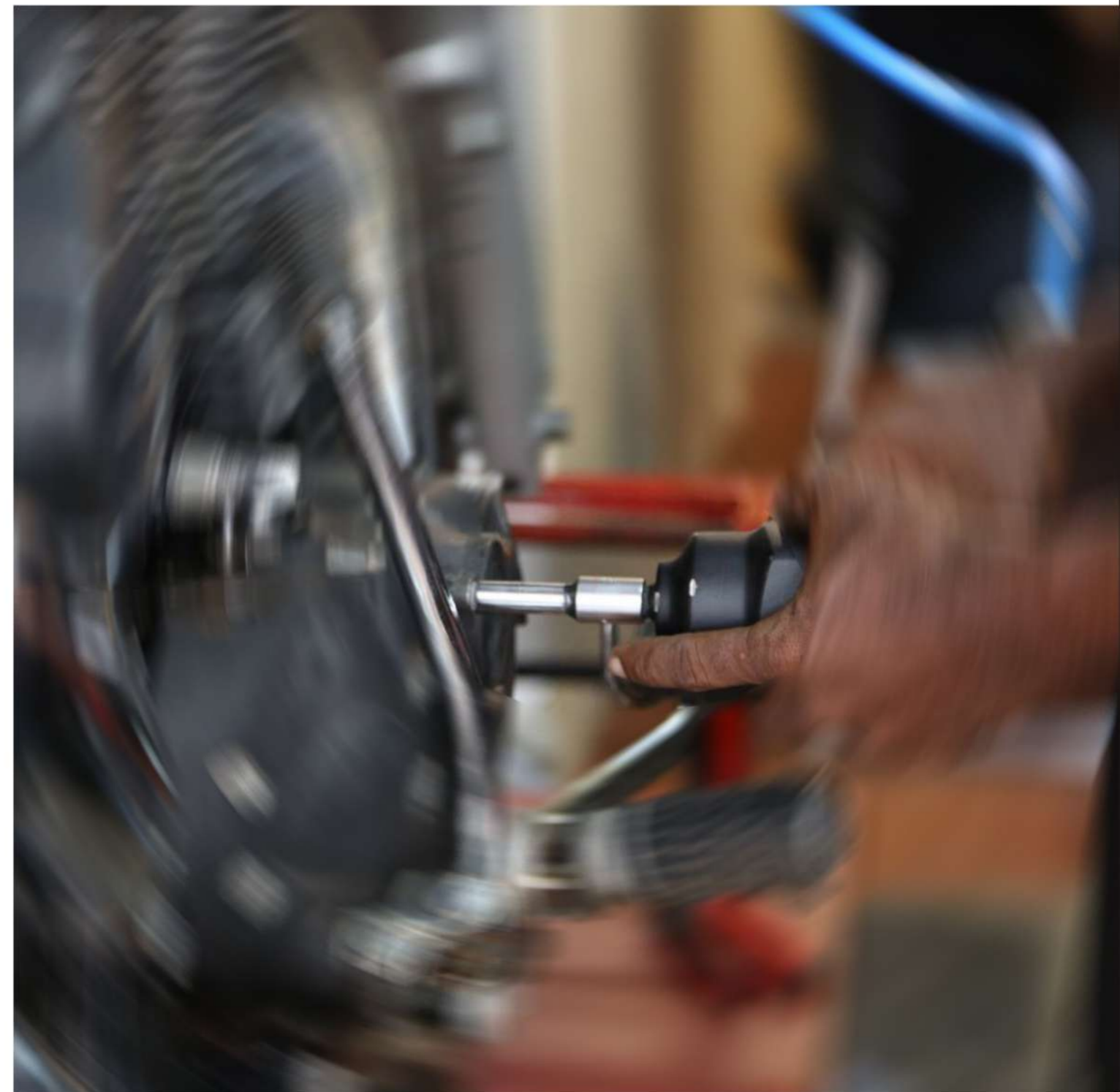

ATTREZZI PROFESSIONALI
PROFESSIONAL TOOLS



Codice / Item
BL-1642

Multichiave per asse ruote con attacco 3/8"
H17-H19-H22-H24
3/8" Spindle tool



Codice / Item
BL-1622

Multichiave in alluminio per asse ruote con
attacco 3/8"
H17-H19-H22-H24
3/8" Aluminium Spindle tool



Codice / Item
BL-35384

Vaschetta magnetica tonda D. 15 cm
Magnetic round tray D. 15 cm



Codice / Item
BL-56332

Vaschetta magnetica rettangolare
24x14 cm
Rectangular magnetic tray 24x14 cm



Codice / Item
24955

Chiave a bussola poligonale per ruota post. Ducati
3/4" 12pts flank socket for Ducati rear wheel



Codice / Item
BL-1630

Chiave a settore regolabile 25-70mm
25-70mm adjustable hook wrench



Codice / Item
BL-72805

Vaschetta magnetica rettangolare 36x16 cm
Rectangular magnetic tray 36x16 cm



Codice / Item
BL-31317

Bacinella ni rete di acciaio per vasca
lava pezzi D. 27 cm
Stainless steel mesh parts bowl D. 27 cm



Codice / Item
BL-KRT
Morsa girevole professionale 125mm
Professional vice with swivel base 125mm



Codice / Item
BL-14180

Protezioni magnetiche per morsa da banco
Magnetic soft jaws for bench vice



Codice / Item
BL-45856

Kit estrattori viti spezzate -
3-6/6-8/8-11/11-14/14-18mm
5pcs broken screw extractor set



Codice / Item
BL-4030 (0.6mm) BL-4035 (0.8mm)
Filo inossidabile in bobina da 450 gr.
Lock wire spools of 450 grs.



Codice / Item
088-021
Uncino per trazione molle
Spring hook tool



Codice / Item
BL-4020
Pinza torcifilo acciaio 9"
9" lock wire twisting plier



Codice / Item
BL-30826
Utensile separazione pistoncini freni
Disc brake adjuster



Codice / Item
BL-0320

Utensile rimozione cuscinetti sterzo 26-39 mm
Head cup for steering bearings 23-39mm / 1,1-32"/1.17-32"



Codice / Item
BL-0330

Utensile rimozione cuscinetti sterzo mm
Head cup for steering bearings 39-57mm
1.17-32" / 2.1-1/4"



Codice / Item
BL-3815

Strumento misurazione livello olio forcelle
Fork oil level measuring instrument



Codice / Item
BL-0310

Utensile montaggio cuscinetti radiali
Race setting tool set



Codice / Item
BL-2768

Estrattore per volano M14x1.5R/M16x1.5R/M18x1.5
M24x1.5R/M10x1.25R/M27x1.0L
Flywheel puller



Codice / Item
BL-1370

Spazzola pulisci catena
Motorcycle chain brush



Codice / Item
BL-7226152

Kit universale smagliatura/rivettatura catena
Universal heavy duty chain tool kit



Codice / Item
BL-7224744

Kit 11pcs chiave di bloccaggio universale
11pcs kit universal holder

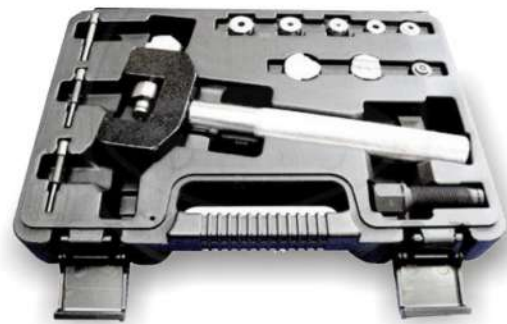

Codice / Item
J-6

Kit smagliatura e rivettatura catena 415>630
Heavy duty chain tool for chains 415>630



Codice / Item
BL-0340

Utensile installazione cuscinetti sterzo 3x42
1x46 1x38 1x36 e 1x32
Steering bearings installation
tool set



Codice / Item
BL-2210

Blocca volano e pulegge
Flywheel holder



Codice / Item
BL-7220544

Attrezzo regolazione valvole
Tappet adjustment driver set



Codice / Item
BL-3650

Kit installazione guarnizioni forcella mm: 35/36-39-41-43-45-
46/47-48-49/50-54
Fork gasket installation set.



Codice / Item
BL-3620

Morsa universale portatile
Universal portable clamp vice



Codice / Item
BL-6210

Giraviti angolare per carburatore
Angle driver for carburetor



Codice / Item
BL-5925

Disco graduato fasatura motori Ducati
Timing degree gauge for Ducati engines



Codice / Item
BL-19613

Spessimetro combinato 0.03-1.00mm
0.001-0.040 inches feeler gauge dual reading



Codice / Item
BL-0430

Set estrattori cuscinetti interni motore. MM 8-10-12-15-17-20-25-30
Engine bearing puller set



Codice / Item
BL-7222912

Kit montaggio cuscinetti mm 40-45-50-59-63-65
Bearing race and seal driver set



Codice / Item
BL-6141691

Set 30 pz chiavi per filtri olio da D.65>108mm
30pcs set oil filter wrenches

21706 M5x0.8
21708 M6x1.0
21709 M8x1.25
21710 M10x1.5
21711 M12x1.75



Codice / Item
BL-217...

Set filetti metrici di ricambio (12pz)
Metric thread insert refill set (12pcs)



Codice / Item
BL-56379

Assortimento anelli elastici(seegeer) 285pz
Circlip assortment 285pcs (int./ext.)



Codice / Item
BL-63941

Assort. anelli elastici(seegeer) est. 300pz
Circlip assortment 300pcs (ext.)



Codice / Item
BL-79205

Set metrico maschi e filiere 75 pz
Combination tap and die set 75 pcs



5xHSS punte trapano / 5xHSS maschi rinnova filetti / 5x strumenti rimozione del trascinatore / impugnatura bobinatrice intercambiabile / 5x 1/4" femmina esagonale per gravite magnetica / 2mm chiave esagonale / 60 pz filetti vari
5xHSS twist drills / 5xHSS Second taps / 5x tang breaking tool / interchangeable insert winder handle / 5x 1/4" hex. for magnetic screw insert drivers / 2mm hex key / 60 pcs various threads

Codice / Item
BL-21690

Kit riparazione filetti
Thread repair and workshop kit



Codice / Item
BL-7223530

Attrezzo spurgo olio freni professionale.
Professional brake bleeder set.



Codice / Item
BL-56345

Assortimento o-ring metrici 419 pz
3.0mm x 1.5mm > 50mm x 3.5mm
O-rings assortment 419 pcs



Codice / Item
BL-7224777

Serbatoio ausiliario per motori a iniezione 3,6 L
Auxiliary fuel tank for injection engines



Codice / Item
BL-7223068

Serbatoio ausiliario benzina Lt 1
Auxiliary fuel bottle 1 Lt



BL-43963 1 Lt BL-43964 3 Lt BL-43965 5 Lt

Codice / Item
BL-4396..

Caraffe con tubo flessibile con scala metrica e US
Flexible spout jug with metric and US graduation



Codice / Item
BL-56141

Imbuto PVC con tubo flessibile D. 110 mm
Diam. 110mm PVC flexible funnel



Codice / Item
BL-52427

Calibro digitale doppia misurazione
S.Steel digital caliper dual reading



Codice / Item BL-49949 20L BL-49952 10L BL-49957 5L

BL-499...
Tanica in acciaio a norma per carburante.
Fuel tankers.



Codice / Item
BL-43853

Set 4 imbusti D. 50/75/100/120 mm
Plastic funnels set 4 pcs



Codice / Item
BL-45458

Contafiletto a 20 lame
20 blades metric screw pitch gauge



Codice / Item
BL-11954

Specchietto flessibile per ispezione
Flexible inspection mirror



Codice / Item
BL-56375

Assortimento coppie 555 pz
Split pin assortment 555 pcs



Le immagini a colori sono puramente indicative e possono non corrispondere alle tonalità reali dei prodotti. I disegni sono indicative alle informazioni ed illustrano l'impiego dei prodotti. Bike-Lift Europe Srl si riserva la possibilità di cambiare, modificare od eliminare prodotti da questo catalogo senza preavviso.

© 2019-2020 Bike-Lift Europe Srl. Tutti i diritti riservati. E' vietata qualsiasi forma di riproduzione anche parziale.

The color pictures are merely indicative and may not match the exact product color or true tone. The designs refers to the information and explain the use of the products. Bike-Lift Europe Srl reserves the right to change, modify or eliminate products in this catalogue without prior notice.

© 2019-2020 Bike-Lift Europe Srl. All rights reserved. The reproduction even partial is forbidden.

we support only the best teams

