



DISEGNI PASTIGLIE E LORO APPLICAZIONE PER SCOOTER

PAD DRAWINGS AND THEIR SCOOTER APPLICATIONS

LISTE DES APPLICATIONS SCOOTER ET CROQUIS

ZEICHNUNGEN DER BELAGEN UND ANWENDUNG FUER
SCOOTER

DISEÑO DE PASTILLAS Y SU APLICACIÓN PARA SCOOTER





07001.CC	94 x 36.2 x 8
-----------------	---------------

07001.12 GENUINE	“ “ “
----------------------------	-------

07001.23 GENUINE	“ “ “
----------------------------	-------

07001.35 GENUINE	“ “ “
----------------------------	-------

07001.78 GENUINE	“ “ “
----------------------------	-------

07001.XS	“ “ “
-----------------	-------

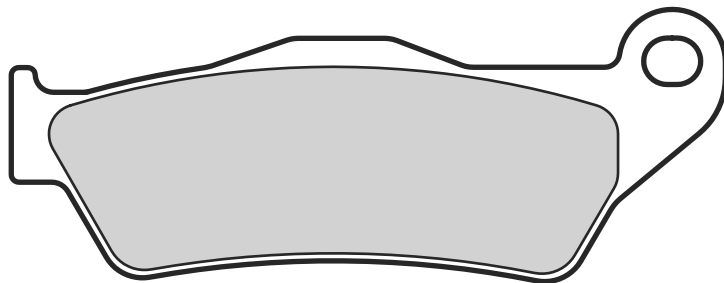
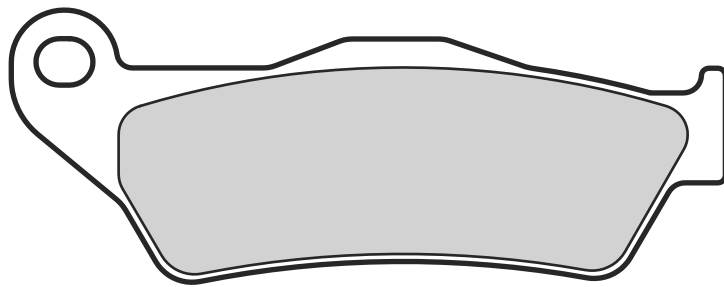
**GILERA**

500 NEXSUS (EURO 3)	06 >	•
500 NEXSUS SP (EURO 3)	06 >	•
500 NEXUS	03 > 05	•
800 GP 800	07 >	•

MBK

125 SKYLINER	99 > 01	•
125 SKYLINER	02 >	•
125 THUNDER	01 >	•
150 SKYLINER	00 > 00	•
150 SKYLINER	01 >	•

150 THUNDER

02 >



180 SKYLINER

04 >



300 XC KILIBRE

03 >

**PIAGGIO**

400 BEVERLY I.E.	06 >	•
500 X9 EVOLUTION	04 >	•
500 X9 EVOLUTION ABS	04 >	•

SUZUKI

125 BURGMAN	01 > 06	•
150 BURGMAN	04 >	•

YAMAHA

125 MAJESTY	98 > 00	•
125 MAJESTY	01 >	•
125 MAXSTER	01 >	•
150 MAJESTY	98 > 00	•
150 MAJESTY	01 >	•
150 MAXSTER	01 >	•
180 MAJESTY	03 > 03	•
180 MAJESTY	04 >	•
300 XC VERSITY	03 > 04	• •
300 XC VERSITY	05 >	•



07002.CC 39.7 x 49.5 x 6.3

07002.18 " " "
GENUINE

07002.23 " " "
GENUINE

07002.34 " " "
GENUINE

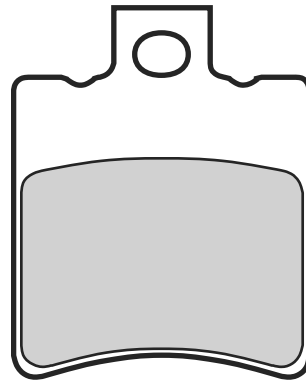

APRILIA

50 AMICO	92 > 95	•
50 BUSINESS	97 >	•
50 CLASSIC	96 >	•
50 CLUB	97 >	•
50 MC GULLIVER	95 >	•
50 RALLY	96 >	•
50 RALLY AC	96 >	•
50 RALLY LC	92 > 96	•
50 RALLY LC	97 >	• •
50 SCARABEO	94 > 97	•
50 SCARABEO	98 > 01	•
50 SCARABEO BRIGHT	98 >	• •
50 SCARABEO DE LUXE	98 >	• •
50 SCARABEO DITECH	02 >	•
50 SCARABEO STREET	98 >	•
50 SONIC GP	98 > 99	•
50 SONIC GP CAT	99 > 02	•
50 SONIC SPICE	98 >	•
50 SR DITECH	00 >	•
50 SR R	05 >	•
50 SR R FACTORY	05 >	•
50 SR R FACTORY REPLICA		
50 SBK	10 >	•
50 SR RACING	97 >	• •
50 SR STEALTH LC	97 >	• •
50 SR STREET	05 >	•
50 YOUNGER	97 >	•
125 LEONARDO	96 > 96	•

ATALA

50 HACKER AT 12	96 >	•
-----------------	------	---

BENELLI

50 491 ARMY	97 > 01	• •
50 491 GT	97 > 99	•
50 491 NAKED	99 > 01	•
50 491 RACING	97 > 99	• •
50 491 RR, GP	00 > 01	• •
50 491 SPORT	97 > 01	•
50 491 ST	01 > 03	•
50 491 SUPERBIKE	97 > 01	• •
50 CHRONO	94 >	•
50 K2	98 > 01	• •
50 K2 NAMUR	99 > 02	• •

50 NAKED	94 > 01	•
50 NEMO	94 >	•
50 PEPE	99 > 04	•
50 PEPE 4T	05 > 14	•
50 PEPE CLASSIC	05 > 14	•
50 QUADRA	94 >	•
100 NAKED	02 >	•
100 PEPE	99 > 04	•
125 BORN IN HELL	98 > 99	•
125 VELVET	99 > 04	•
125 VELVET TOURING	01 > 03	•
150 VELVET	00 > 04	•
150 VELVET TOURING	01 > 03	•
250 VELVET	99 > 01	•
250 VELVET TOURING	01 > 03	•
400 VELVET DUSK	03 > 03	•

BETA

50 ARK	96 > 98	•
50 ARK	99 >	• •
50 EIKON	99 > 03	• •
50 EIKON	04 >	•
50 QUADRA	95 > 96	•
50 TEMPO	99 >	•
50 TEMPO "13"	00 >	•
50 TEMPO "16"	00 >	•
125 EIKON	00 > 03	•
150 EIKON	04 >	•

BS VILLA

50 AX	93 >	•
50 GZ	93 >	•

CAGIVA

125 CUCCILO	98 > 99	•
-------------	---------	---

DERBI

50 VAMOS (BREMBO CAL.)	95 > 97	•
------------------------	---------	---

GARELLI

50 FLO'	00 >	•
125 PANTHER	02 >	•
150 PANTHER	02 >	•
250 PANTHER	02 >	•

GILERA

50 DNA	01 >	•
50 DT STALKER	97 >	•
50 EAGLET	97 >	•
50 EASY MOVING	96 >	•
50 ICE	02 >	•
50 NRG	94 >	•
50 RUNNER	96 > 05	•
50 RUNNER DD	96 > 05	•
50 RUNNER RACING		
50 REPLICA	03 > 05	•
50 STALKER	97 >	•
50 STORM	96 >	•
50 TYPHOON	93 > 95	•
70 RUNNER	98 >	•
80 TYPHOON	95 >	•
125 DNA	01 >	•
125 TYPHOON XR	95 >	•
180 DNA	01 >	•
200 STALKER	97 >	•
250 STALKER	97 >	•

HERCULES

50 GIPSY	95 >	•
----------	------	---

HONDA

50 FORMULA	94 >	•
50 SFX	96 >	•
50 SH	00 >	•
50 SH FIFTY	95 >	•
50 SKY	96 >	•
50 SKY CLASSIC	00 >	•
50 SKY VETRO	00 >	•
50 SXR	98 >	•

HYOSUNG

125 EXCEED	02 >	•
125 GPS D	00 >	•
125 GRAN PRIX PLUS	98 > 01	•
125 HYPER	99 >	•
150 EXCEED	02 >	•
150 GRAN PRIX PLUS	98 >	•





ITALJET

50	FORMULA	94 >	•
80	FORMULA	94 >	•
125	FORMULA	94 >	•

KEEWAY

50	ARN	08 >	•
50	GOCCIA	08 >	•
50	HACKER	08 >	•
125	ARN	06 >	•
125	HACKER	08 >	•
150	ARN	06 >	•
150	HACKER	08 >	•

MALAGUTI

50	CENTRO SL	93 >	•
50	CIAK	02 >	• •
50	CIAK ELECTRONIC POWER	03 >	•
50	CIAK MASTER	06 >	•
50	CROSSER	97 >	•
50	F10	94 >	•
50	F10 TIMEMACHINE	03 >	•
50	F10 WAP	02 >	•
50	F12 PHANTOM	98 > 99	•
50	F12 PHANTOM DIGIT	00 >	•
50	F12 PHANTOM DUCATI CAPIREX	04 >	• •
50	F12 PHANTOM FOGGY	00 >	• •
50	F12 PHANTOM GP	04 >	• •
50	F12 PHANTOM SPECTRUM	00 >	• •
50	F12 RACING LIFE	03 >	• •
50	F12 TYRE TRACK	03 >	• •
50	F15 FIRE FOX FUN	03 >	• •
50	F15 FIREFOX BLUE RACE	05 >	• •
50	F15 FIREFOX DUCATI SBK	04 >	• •
50	F15 FIREFOX MECHATRONIC	03 >	• •
50	F15 FIREFOX RED RACE	05 >	• •
50	F15 FIREFOX TDS	99 >	• •
50	FIREFOX	05 >	• •
50	YESTERDAY	97 >	•

100	CIAK	99 >	• •
100	F 12 PHANTOM TWIN DISK	02 >	• •
100	F12 PHANTOM	00 > 01	•
125	F18 PROJECT	00 >	•
125	F18 WARRIOR	00 >	•
150	F18 PROJECT	00 >	•
150	F18 WARRIOR	00 >	•

MBK

50	BOOSTER ALL MODEL	96 > 99	•
50	BOOSTER NAKED	04 >	•
50	BOOSTER R	93 > 95	•
50	BOOSTER SPIRIT	00 >	•
50	FLIPPER	98 >	•
50	MACH	02 >	•
50	NEO'S	94 >	•
50	NITRO	97 >	•
100	NITRO	00 >	•
100	OVETTO	00 >	•

MOTRON

50	SPIKE-S	98 >	•
50	STING	96 >	•
50	SYNCR0	99 >	•
50	ZR THUNDER	95 >	•

PEUGEOT

50	BUXY R (BREMBO CAL.)	94 > 97	•
50	SPEEDAKE (BREMBO CALIPER)	94 > 97	•
50	SPEEDFIGHT (BREMBO CAL.)	96 >	•
50	SQUAB	94 >	•
50	ZENITH LUXE	94 >	•

PIAGGIO

50	ENERGY EXTREME DD	99 >	•
50	ENERGY EXTREME DT	99 >	•
50	FREE	97 >	•
50	NRG DD	02 >	•
50	NRG DT	02 >	•
50	NTT	96 >	•

SIAMOTO

50	FALCON	97 >	•
50	S CROSS	97 >	•
125	FALCON	97 >	•

SUZUKI

50	KATANA LC	97 >	•
50	KATANA RX	98 >	•
50	R7	95 > 97	•
50	RF	95 > 97	•
50	W, WR	00 >	•

SYM

125	XS K	11 >	•
-----	------	------	---

YAMAHA

50	AEROX	97 > 12	•
50	AEROX REPLICIA	97 > 06	•
50	AEROX ROSSI	04 > 06	•
50	AXIS	95 > 96	•
50	AXIS MOFA	97 > 98	•
50	BW SPORT R	02 >	•
50	BW'S BUMP	95 > 98	•
50	BW'S NEXT GENERATION	99 >	•
50	JOG R	02 >	•
50	NEO'S	96 >	•
50	NEO'S 4	09 >	•
50	OVETTO	96 >	•
50	SPY	96 >	•
50	WHY	98 > 09	•
100	AEROX	00 >	• •
100	NEO'S	00 >	•
125	TEO'S	01 >	•
150	TEO'S	02 >	•



07003.CC 39.7 x 49.5 x 7

07003.34 “ “ “
GENUINE

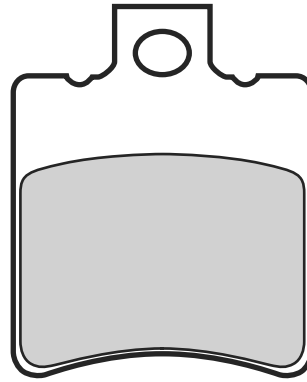

3



ANCILLOTTI

80 CROSS 80 > •

APRILIA

50 AREA 51 98 > 01 • •
50 AREA 51 SUPERBIKE 00 > 02 • •
50 COMPAY 09 > 13 •
50 GULLIVER 96 > 98 •
50 HABANA 99 > 02 •
50 HABANA CUSTOM 99 > 02 •
50 MOJITO 03 > 12 •
50 MOJITO CUSTOM 03 > 12 •
50 MOJITO RETRO 03 > 03 •
50 SCARABEO 98 > 01 •
50 VIPER-REPLICA 94 > •
125 LEONARDO 97 > 98 •
150 LEONARDO 97 > 98 •

BENELLI

100 K2 99 > 02 •
125 ADIVA 00 > •
150 ADIVA 00 > •

FANTIC MOTOR

50 CABALLERO RC 90 > •
50 CABALLERO RS 90 > •

GILERA

50 RUNNER PURE JET 98 > 05 •
50 RUNNER SP 98 > 05 •

HONDA

50 X8R S/X 98 > •
100 SH FIFTY 96 > •

MACAL

50 FLASH 99 > •

MALAGUTI

125 CIAK 00 > •
125 CIAK MASTER 00 > •
150 CIAK 00 > •
150 CIAK MASTER 00 > •

MBK

125 DOODO 00 > •
150 DOODO 01 > •

PEUGEOT

125 ENDURO 84 > •

PIAGGIO

50 NRG ALL MODEL 95 > 97 •
50 NRG DD 02 > •
50 NRG EXTREME 01 > •
50 NRG POWER DD 05 > • •
50 NRG PUREJET 05 > • •
50 STORM 94 > 95 •
50 TYPHOON 94 > 95 •
50 TYPHOON CATALYZED 02 > • •
50 VESPA LXV 08 > •
50 VESPA S COLLEGE 4T 11 > •
50 ZIP FAST RIDER 93 > 95 •
100 FREE 02 > •
125 HEXAGON 94 > 97 •
125 TYPHOON CATALIZ. 02 > • •
125 VESPA LXV 08 > •
150 HEXAGON 94 > 97 •

YAMAHA

125 TEO'S 99 > 00 •





07004.CC	50.2 x 53.2 x 7.8
07004.18 GENUINE	“ “ “
07004.30 GENUINE	“ “ “
07004.35 GENUINE	“ “ “
07004.65 GENUINE	“ “ “
07004.XS	“ “ “

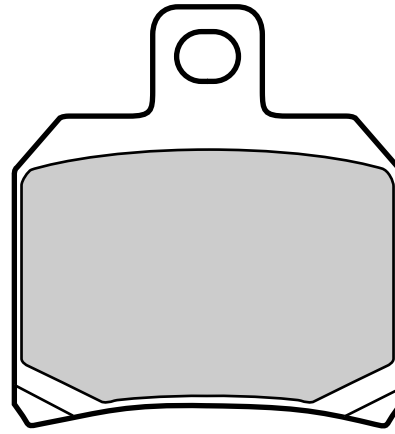

3

**ADIVA**

250 AD 200	06 >	• •
------------	------	-----

APRILIA

50 RS	06 >	•
-------	------	---

BENELLI

1130 TNT R	17 >	•
------------	------	---

DERBI

50 GP1	05 >	•
250 GP1	05 >	•

GILERA

500 NEXSUS (EURO 3)	06 >	•
500 NEXSUS SP (EURO 3)	06 >	•
500 NEXUS	03 > 05	•

MALAGUTI

125 MADISON	99 >	•
125 MADISON 3	08 >	•
250 MADISON	99 >	•
500 SPIDER MAX GT	04 >	•
500 SPIDER MAX RS	09 >	•
500 SPIDERMAX	04 >	•

MBK

125 SKYCRUISER	06 >	•
125 SKYLINER	02 >	•
125 THUNDER	01 >	•
150 SKYLINER	01 >	•
150 THUNDER	02 >	•
180 SKYLINER	04 >	•

PEUGEOT

50 SPEEDFIGHT 3 LC, LC RS	10 >	•
50 SPEEDFIGHT TOTAL SPORT	16 >	•
125 ACTIVE	13 >	•
125 CITYSTAR	11 >	•
125 DJANGO HERITAGE	14 > 16	•
150 DJANGO HERITAGE	14 > 15	•
200 CITYSTAR	13 >	•

PIAGGIO

125 X8	04 > 04	•
125 X9	00 > 02	• •
125 X9	03 >	•
125 X9 right caliper	04 > 05	•
180 X9	00 > 02	• •
180 X9 AMALFI	00 > 02	• •
200 X8	04 > 04	•
200 X9	03 >	• •
200 X9 EVOLUTION	03 > 04	• •

250 X9	00 > 02	• •
250 X9	03 >	•
500 BEVERLY	02 > 04	• •
500 BEVERLY	05 >	•
500 BEVERLY CRUISER	08 >	• •
500 BV	06 >	• •
500 X9	00 > 02	• •
500 X9 EVOLUTION	04 >	•
500 X9 EVOLUTION ABS	04 >	•

RIEJU

50 MRT PRO, PRO SUPERMOTARD	09 >	• •
50 TANGO	08 >	•

SUZUKI

125 BURGMAN	01 > 06	•
150 BURGMAN	04 >	•

YAMAHA

125 MAJESTY	01 >	•
125 MAXSTER	01 >	•
125 X CITY	08 > 15	•
125 X MAX	06 > 09	•
125 X MAX	10 > 13	•
125 X MAX SPORT EDITION	11 >	•
150 MAJESTY	01 >	•
150 MAXSTER	01 >	•
180 MAJESTY	04 >	•



07005.CC

69.8 x 41 x 8.2
85.1 x 42.9 x 8.2

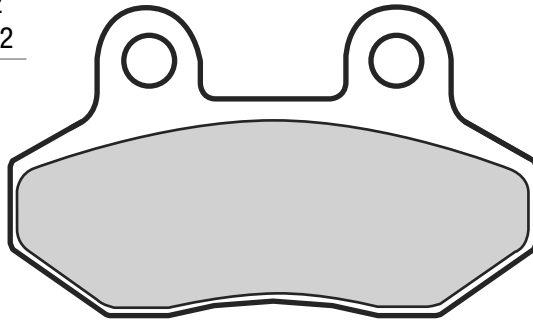

3

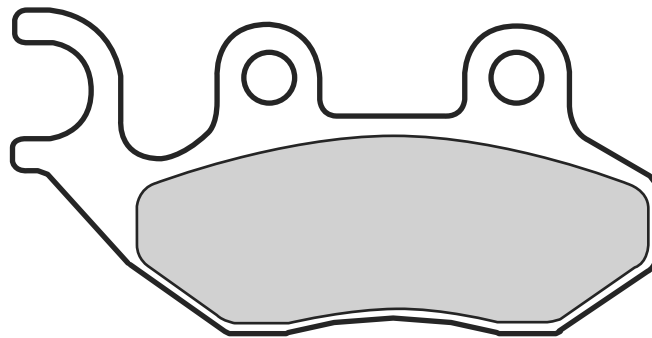

CAGIVA

50	CITY LUCKY	95 > 97	•
125	PASSING	95 >	•

GARELLI

50	KRS	02 >	•
50	SPORT PMX	00 >	•
125	FREELAND	02 >	•
125	T-TEX	00 >	•
150	FREELAND	02 >	•

PEUGEOT

50	TWEET	10 > 12	•
50	TWEET PARIS	16 >	•
50	TWEET RS	10 > 12	•
125	LXR	10 >	•
125	TWEET	10 > 12	•
125	TWEET PARIS	16 >	•
125	TWEET RS	10 > 12	•
150	TWEET	10 > 12	•
150	TWEET PARIS	16 >	•
150	TWEET RS	10 > 12	•
200	LXR	10 >	•

PGO

50	DR.BIG	01 >	•
50	G-MAX	06 >	•

50	I DEP	09 >	•
50	LIBRA	10 >	•
50	LIGERO	06 >	•
50	PMX	01 >	•
50	SPORT	01 >	•
50	T-REX	99 >	•
100	LIGERO	06 >	•
100	MY BUBU	02 >	•
110	T-REX	99 >	•
125	CHARGE	02 > 02	•
125	LIBRA	10 >	•
125	LIGERO	06 >	•
125	MY BUBU	02 >	•
125	T-REX	99 >	•
125	X-HOT	10 >	•
150	T-REX	01 >	•
150	TR 3	02 >	•

SANYANG

50	JET	95 > 98	•
50	JUNGLE	96 >	•
50	RED DEVIL	97 >	•
50	SUPER FANCY	95 > 97	•
100	PARTY	97 >	•
100	SUPER FANCY	95 >	•
125	ATTILA	95 >	•
125	SUPER DUKE	95 >	•
150	SUPER DUKE	96 >	•

SYM

50	ALLO	11 >	•
50	CROX	14 >	•
50	FIDDLE	09 >	•
50	JET	95 >	•
50	JET 4 NAKED, R	11 >	•
50	JET BASIX	07 >	•
50	JET EURO X	05 >	•
50	JET SPORT X	06 >	•
50	JUNGLE	96 >	•
50	MASK	00 >	•
50	MASK LC	00 >	•
50	ORBIT	12 >	•
50	RED DEVIL	97 >	•
50	SUPER FANCY	95 > 97	•
50	SYMPHONY	09 >	•
50	SYMPHONY S	10 > 14	•
50	SYMPHONY S	18 >	•
50	SYMPHONY SR	11 >	•
50	SYMPHONY ST	15 > 15	• •
50	SYMPHONY ST	18 >	• •
50	SYMPLY	08 >	•
50	X'PRO	14 >	•
100	JET	00 >	•
100	JET EURO X	05 >	•
100	JET SPORT X	06 >	•
100	PARTY	97 >	•
100	SUPER FANCY	95 >	•

110 STAR	03 > •	125 MEGALO	02 > •	150 SYMPHONY	10 > •	125 ALLO	11 > •	150 SYMPHONY SR	11 > •
125 ATTLA	00 > •	125 NEW DUKE	02 > 07 •	183 N TRAZER	18 > •	125 CITYCOM	09 > •	200 FIDDLE II	11 > •
125 CROX	14 > •	125 SUPER DUKE	95 > 01 •	200 HD EVO	07 > •	125 EVO	14 > •	200 SYMPHONY ST	18 > •
125 FIDDLE	09 > •	125 SYMPHONY	09 > •	300 CITYCOM	09 > 14 • •	125 GTS	07 > •	600 MAXSYM SPORT	18 > •
125 HD EVO DT	10 > •	125 SYMPHONY EX	17 > •			125 JET 14	17 > •		
125 JET 4	11 > •	125 SYMPHONY SR	11 > •			125 JET 4	11 > •		
		125 SYMPLY	08 > •						
		125 X'PRO	14 > •						
		150 ATTLA	00 > •						
		150 FIDDLE II	11 > •						
		150 SUPER DUKE	96 > 01 •						

TGB

50 AKROS TEC.	94 > •
---------------	--------

07006.CC	78.9 x 46.9 x 7.3		
07006.XS	“ “ “		

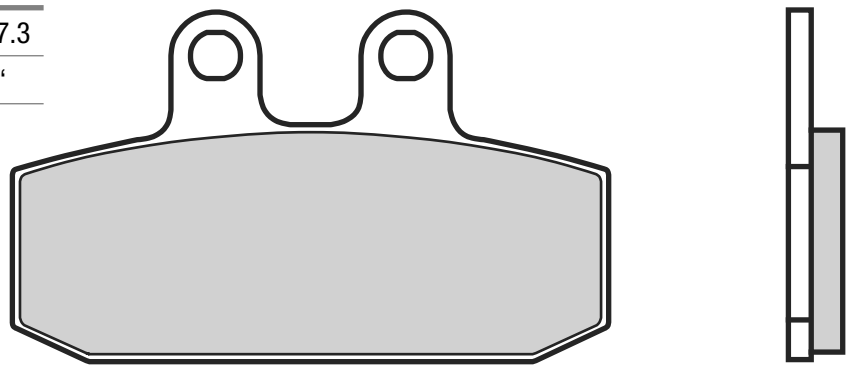

APRILIA		500 ATLANTIC	02 > 05 •	GILERA		125 ARIZONA HAWK	85 > •	
50 SR MOTARD	12 > •	500 SCARABEO CLASSIC	10 > •	125 RC	90 > •	125 RUNNER	97 > •	
125 RX	86 > 89 •	500 SCARABEO GT ABS right caliper	06 > •	125 X1	89 > 89 •	200 FAST BIKE	88 > •	
125 SCARABEO	99 > 03 •	500 SCARABEO ie right caliper	06 > •	200 RTX	85 > •			
125 SPORTCITY	05 > •	500 SCARABEO right caliper	04 > 05 •					
125 SR MOTARD	12 > •	600 TUAREG	86 > 87 •	HONDA		125 NSR, F	88 > 89 •	
125 TUAREG RALLY	86 > 88 •			MALAGUTI		125 RUNNER	87 > •	
150 SCARABEO	99 > •	CAGIVA		500 SPIDERMAX	04 > •			
200 SCARABEO	02 > 06 •	50 BLUES	89 > 93 •			MOTO MORINI		
200 SCARABEO GT	01 > •	125 BLUES	89 > 93 •			501 CAMEL	85 > 86 •	
200 SPORTCITY	05 > •					501 EXCALIBUR	87 > 88 •	
250 LEONARDO	99 > •	DERBI						
250 SPORTCITY	06 > •	125 RAMBLA	10 > •					
250 TUAREG RALLY	86 > •	250 RAMBLA	10 > •					
300 LEONARDO ST	05 > •	300 RAMBLA	08 > •					
300 SPORTCITY CUBE	08 > •							
350 ETX	86 > •							
350 TUAREG WIND	87 > 87 •							
400 SCARABEO I.E.	06 > •							

**07007.CC**

78.9 x 46.9 x 7.5

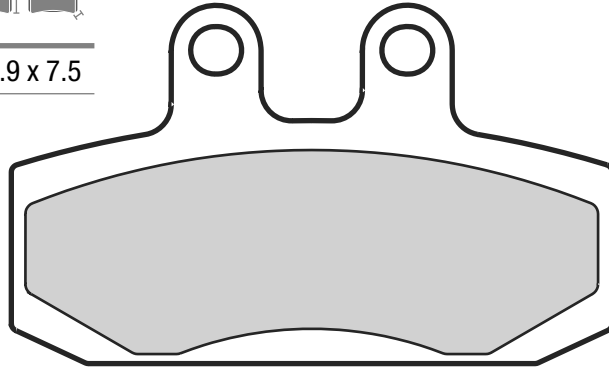

3

**CIMATTI**

125 ROADSTER 94 > •

HONDA50 SJ BALI 96 > 98 •
100 SJ BALI 95 > •**PEUGEOT**50 ELYSEO 02 > •
100 ELYSEO 96 > 99 •
125 ELYSEO 98 > 99 •**07008.CC**

31.4 x 51.9 x 5.5

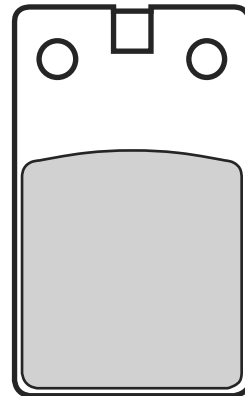
**APRILIA**50 AF-1 86 > 92 •
50 RED ROSE 88 > 89 •
125 TX 86 > •**BETA**50 AE 88 > •
50 ALP 90 > •
50 RV VRS 88 > •
125 TR32 86 > 87 •
125 TR33 86 > 87 •
125 TR34 88 > 88 •
240 TR33 86 > •
260 SYNT 92 > •**FANTIC MOTOR**50 TRIAL 87 > 88 •
125 STRADA HP1 85 > •125 TRIAL 86 > •
201 TRIAL 85 > •
241 TRIAL 87 > • •
243 TRIAL 87 > • •
301 TRIAL 85 > •
303 TRIAL 87 > • •
343 TRIAL 87 > • •**GILERA**

50 BULLIT 90 > •

KEEWAY125 SPEED 06 > •
150 SPEED 06 > •**MALAGUTI**50 CH 86 > •
50 CROSSER 95 > 96 •50 ENDURO DUNE 87 > 88 • •
50 F12 PHANTOM 94 > 97 •
50 F15 FIRE FOX 96 > •
50 FIFTY MISTRAL 90 > •
50 RST SPORT 97 > • •
450 RONCO MGX 87 > •**MONTESA**

360 ENDURO 86 > •

RIEJU

50 DRAG 92 > •

TRESOLDI

80 CR 85 > •

ZÜNDAPP

80 KS TOURING LK 81 > •





07009.CC

31.6 x 57.2 x 5.5

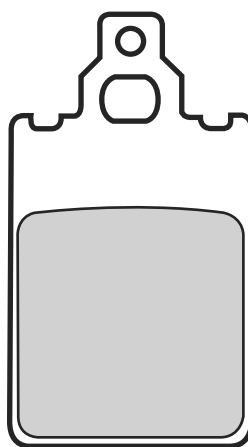

3



APRILIA

50	AF-1 EUROPA	90 > 91	•
50	AF-1 FUTURA	90 > 92	•
50	ET TUAREG	86 >	•
50	RED ROSE	90 > 91	•
50	RED ROSE CLASSIC	92 >	•
50	RX	90 > 91	•
50	TUAREG	86 >	•
50	TUAREG RALLY	90 >	•
240	CLIMBER	89 > 90	•
275	CLIMBER	89 > 90	•

ATALA

50	CAROSSELLO AT 15	97 >	•
----	------------------	------	---

BENELLI

50	CHRONO	92 > 93	•
----	--------	---------	---

BETA

50	ALP	90 >	•
50	CHRONO "13"	94 >	•
50	MX ENDURO	92 >	•
125	TR34	88 > 88	•

DERBI

75	GPR	89 >	•
----	-----	------	---

FANTIC MOTOR

50	FAST	90 >	•
50	OASIS	90 >	•
75	OASIS	89 >	•

GARELLI

50	SAHEL	91 >	•
----	-------	------	---

KTM

50	GO	94 >	•
----	----	------	---

MALAGUTI

50	CIAK	99 > 01	•
50	F12 PHANTOM	98 > 99	•
50	F12 PHANTOM DIGIT	00 >	•
50	F12 PHANTOM LC	94 >	•
50	F15 FIREFOX L.C.	96 >	•
50	MDX ENDURO	87 >	•
50	MLX	87 >	•
50	SILVERFOX	96 >	•

YAMAHA

50	DTR	98 > 01	•
----	-----	---------	---



07010.CC

74.9 x 36.1 x 7.5

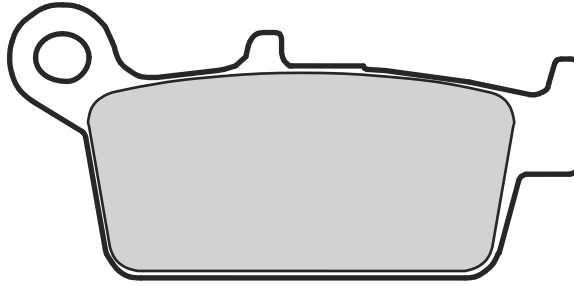

3

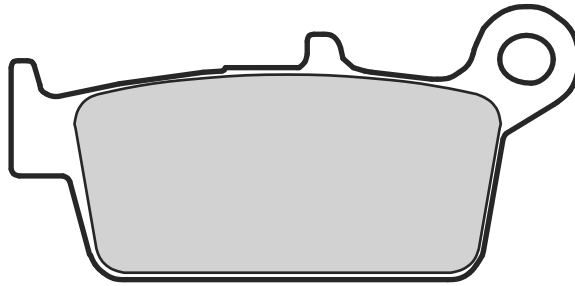

HONDA

75	YUPY	90 >	•
90	YUPY	90 > 94	•

KYMCO

50	CX SUPER	94 >	•
50	FEVER ZX	96 >	•
50	HEROISM	95 > 96	•
50	K12	95 >	•

50	KB	95 >	•
50	SCOUT	95 >	•
50	SNIPER-DD	94 >	•
50	TOP BOY	99 >	•
100	KB	99 >	•
100	TOP BOY	99 >	•
150	FREEWAY	95 >	•

PEUGEOT

50	SV GEO	92 > 92	•
80	SV	91 > 92	•
125	EXECUTIVE	94 >	•
125	SV GEO	91 > 92	•

SIAMOTO

50	KD	00 >	•
125	KD	00 >	•



07011.CC

74.9 x 36.1 x 9

3

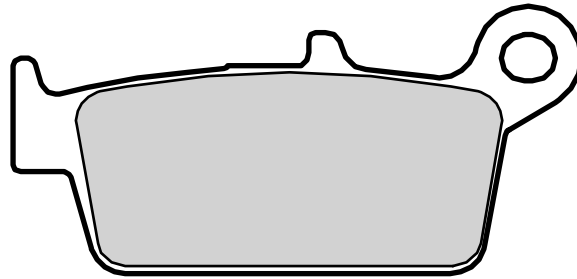
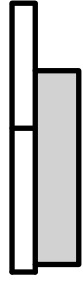
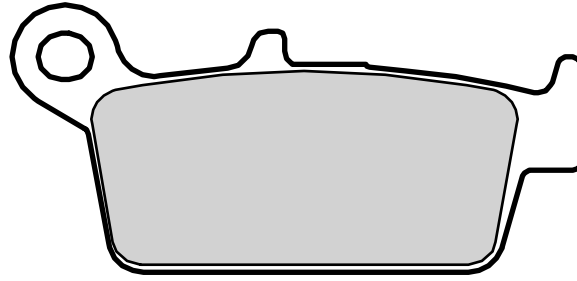

DAELIM

50 BESBI 07 > •

ITALJET

125 AMARCORD 08 > •

MOTOR UNION

125 JC 98 > •

HONDA

50 CRM 89 > 92 •

50 CRM 93 > 96 •

50 NH 94 > •

80 MBX FWD 83 > •

80 NSR R 93 > •

150 NS 92 > •

KYMCO

50 COBRA CROSS 01 > •

50 COBRA EXCLUSIVE 01 > •

50 COBRA RACER 01 > •

50 CURIO CX 96 > •

50 EASY 01 > •

50 FILLY 01 > 01 •

50 VITALITY 4-STROKE 04 > •

50 YUP 00 > •

PEUGEOT

50 SV GEO 93 > •

50 SV L 93 > •

80 SV 93 > 95 •

125 SV C EXECUTIVE 96 > •

125 SV EXECUTIVE 94 > •

125 SV GEO 93 > •

SIAMOTO

125 COLUMBUS 00 > •

**07012.CC**

76.5 x 41.9 x 7.3

94.4 x 42.1 x 7.3

07012.XS

“ “ “

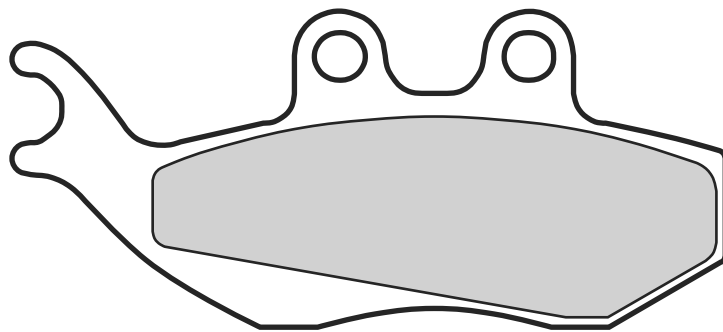
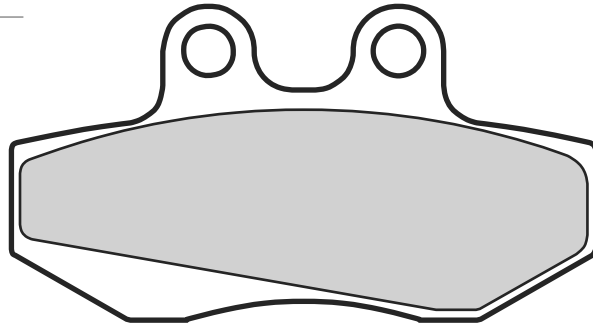

3

**APRILIA**

50	MX	03 >	•
50	PEGASO	70 >	•
50	RS EXTREMA	00 >	•
50	RS REPLICA	00 > 05	•
50	RX	92 > 05	•
50	RX RACING	04 > 07	•
125	ETX	99 >	•
125	PEGASO	92 >	•
125	RX	92 > 92	•

BENELLI

400	VELVET DUSK	03 > 03	•
-----	-------------	---------	---

BETA

50	RR	04 >	•
50	RR ENDURO	04 > 09	•
50	RR SUPERMOTARD ALU	04 >	•

GILERA

50	DNA	01 >	•
125	DNA	01 >	•
125	RUNNER FX (GRIMECA CALIPER)	00 >	•

125	RUNNER FX SP (GRIMECA CALIPER)	00 >	•
125	RUNNER VX 4T (GRIMECA CALIPER)	01 >	•
180	DNA	01 >	•
180	RUNNER FXR	98 >	•
180	RUNNER FXR (GRIMECA CALIPER)	00 >	•
180	RUNNER FXR SP (GRIMECA CALIPER)	00 >	•
180	RUNNER SP	99 >	•
200	RUNNER FX SP	98 >	•
200	RUNNER VXR	02 >	•

HM

50	CRE BAJA RR	07 > 09	•
50	CRE SIX COMPETITION	07 > 08	•

HONDA

50	SJ BALI	94 > 95	•
----	---------	---------	---

MALAGUTI

50	XSM	03 >	•
125	MADISON	99 >	•
150	MADISON	99 >	•
180	MADISON	02 >	•

200	MADISON	03 >	•
200	MADISON BLACK RIDER	03 >	•

PIAGGIO

125	HEXAGON	98 >	•
125	HEXAGON GTX	00 >	•
125	HEXAGON LX	98 > 99	•
125	SKIPPER	96 > 98	•
125	SKIPPER LX	99 >	•
125	SUPERHEXAGON	01 >	•
150	HEXAGON	98 >	•
150	SKIPPER	94 > 97	•
150	SKIPPER LXT-ST	99 >	•
150	SUPERHEXAGON	99 > 00	•
150	SUPERHEXAGON	01 >	•
180	HEXAGON	94 >	•
180	SUPER HEXAGON GTX 12"	01 > 03	•
180	SUPERHEXAGON	99 > 00	•
180	SUPERHEXAGON	01 >	•
250	HEXAGON	98 >	•
250	SUPERHEXAGON	99 > 01	•

RIEJU

50	RS1	01 >	•
50	RS1 CASTROL	01 >	•





07013.CC

31.6 x 51.1 x 5.5

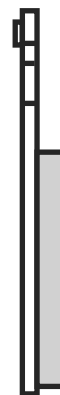
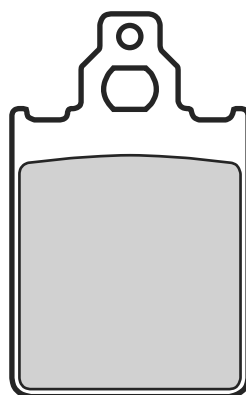

3



CAGIVA

50 PRIMA	93 >	•
80 PRIMA	92 >	•
125 PRIMA	92 >	•

ITALJET

50 FORMULA	94 >	•
80 FORMULA	94 >	•
125 DRAGSTER	97 >	• •
125 FORMULA	94 >	•
180 DRAGSTER	99 >	• •

LML

125 STAR 2T	10 >	•
125 STAR DELUXE	01 > 03	•
125 STAR I 4T	10 >	•
150 STAR 2T	10 >	•
150 STAR DELUXE	01 > 03	•
150 STAR I 4T	10 >	•
151 STAR I 4T	10 >	•
200 STAR I 4T	10 >	•

PIAGGIO

50 QUARTZ	95 >	•
-----------	------	---



50 SKIPPER	92 >	•
75 SFERA	96 > 97	•
80 SKIPPER	93 > 95	•
125 SKIPPER	93 > 95	•
125 VESPA PX	96 > 01	•
150 VESPA PX	96 > 01	•
150 VESPA PX	08 >	•
200 VESPA PX	96 > 01	•

SYM

600 I MAXSYM SPORT	18 >	•
--------------------	------	---





07014.CC

84.9 x 42.4 x 7.5

55.8 x 34.9 x 9.7

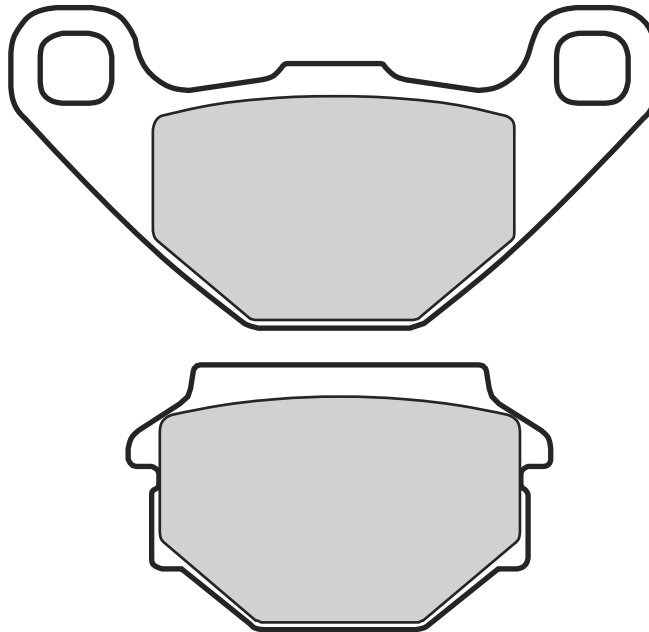

3



APRILIA

125 RX 92 > 92 •

FANTIC MOTOR

50 BIG WHEEL 93 > •

50 GRINTA 95 > •

50 LEADER 95 > •

MZ

660 BAGHIRA MUZ 96 > •

660 BLACK PANTHER MUZ 00 > •

660 MASTIFF MUZ 00 > •

660 STREET MOTO MUZ 00 > •

PEUGEOT

50 SV ROLAND GARROS 93 > •

SACHS

125 ROADSTER 01 > •

125 X-ROAD 4T 05 > •

125 XTC 99 > •

125 XTC N 99 > •

125 ZX 99 > •

125 ZZ 99 > •

500 MADASS 05 > •

650 ROADSTER 01 > •

800 ROADSTER 00 > •

SIMSON

125 RS 01 > •

SYM

125 HUSKY 96 > 98 •





07015.CC

84.9 x 42.4 x 6.5

55.8 x 34.9 x 8.7

3

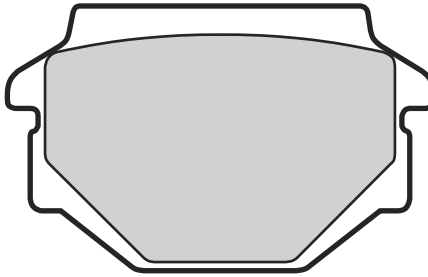
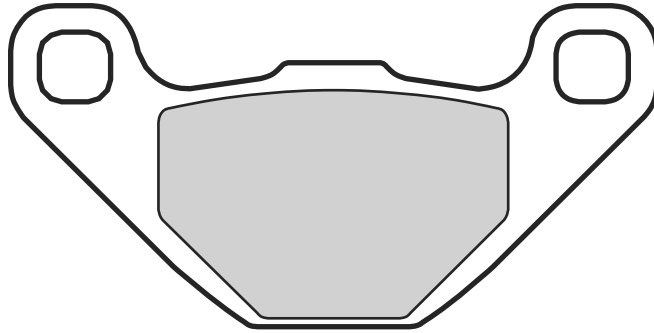

APRILIA

125 MX supermotard	04 > 06	•
125 MX supermoto	07 >	•
125 PEGASO	92 >	•
125 RX	90 > 90	•
125 SX	08 >	•
125 TUAREG RALLY	90 > 91	•
125 TUAREG RALLY	92 >	•
600 PEGASO	90 >	•

CAGIVA

50 WMX	89 >	•
--------	------	---

GILERA

50 RC TOP RALLY	89 >	• •
125 SUPERMOTARD	04 >	•

HERCULES

SUPRA GP	80 >	•
----------	------	---

KYMCO

125 AGILITY CITY	11 >	•
------------------	------	---

MALAGUTI

50 F10	92 > 93	•
50 MEX	86 >	•

PEUGEOT

50 SV SPORT	93 >	•
-------------	------	---



07016.CC

58.8 x 44.5 x 9.5

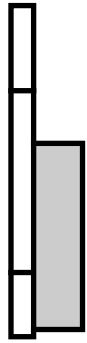
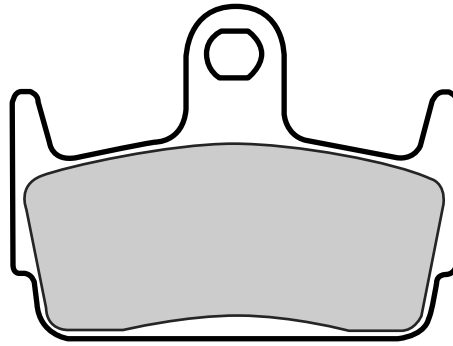

3



HONDA

50	X8R S/X	98 >	•
80	CR	03 >	•

KYMCO

50	SNIPER-DD	94 >	•
125	HEROISM	96 >	•
150	HEROISM	96 >	•

SYM

100	JET SPORT X	06 >	•
-----	-------------	------	---



07017.CC

31.5 x 49 x 7

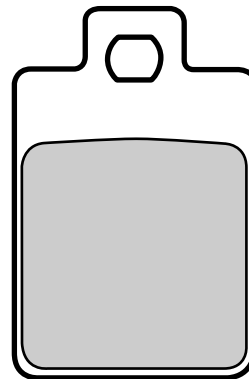

GILERA

50	TYPHOON BENETTON	96 >	•
50	TYPHOON MARTINI	96 >	•

PIAGGIO

50	FREE	93 > 96	•
50	NRG	98 >	•
50	SFERA RST	96 > 98	•

50	STORM	96 >	•
50	TYPHOON	96 > 01	•
80	SKIPPER	96 >	•
80	TYPHOON	96 >	•
125	TYPHOON	96 >	•





07018.CC

59.6 x 43.7 x 9.1

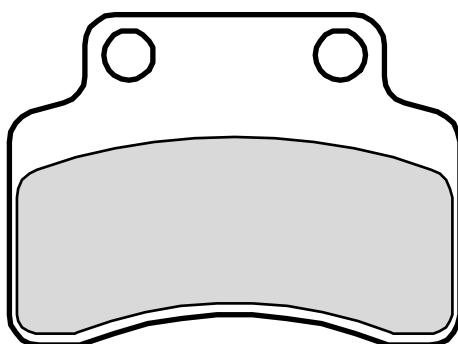

3



BENELLI

50	49 X	08 > 16	•
50	QUATTRO NOVE X	08 > 16	•

CAGIVA

50	NAG	08 >	•
125	BRILLO	08 >	•

CPI

50	ARAGON CLUB	07 >	•
50	ARAGON SP	07 >	•
50	OLIVER CITY	03 >	•
50	OLIVER SPORT	03 >	•

GARELLI

50	FLEXI	12 >	•
50	GSP	09 >	•
50	XO	12 >	•
50	XO' I	08 > 09	•
50	XO' I	10 > 11	• •

ITALJET

50	SX1	08 >	•
----	-----	------	---

KEEWAY

50	F-NKD	10 >	•
50	FLASH ELECTRIC	10 >	•
50	FOCUS	06 >	•
50	MATRIX	06 >	•
50	MATRIX ELECTRIC	10 >	•
50	MATRIX RACING SPORT	10 >	•
50	RY 8	07 > 09	•
50	RY 8	10 >	•
125	FOCUS	06 >	•
125	MATRIX	06 >	•
125	MATRIX RACING SPORT	10 >	•
150	FOCUS	06 >	•
150	MATRIX	06 >	•
150	MATRIX RACING SPORT	10 >	•

KYMCO

50	CALYPSO	97 >	•
50	HEROISM	97 >	•
125	CALYPSO	99 >	•
125	HEROISM	96 >	•
150	HEROISM	96 >	•

PEUGEOT

50	SV GEO EXECUTIVE	96 >	•
50	VIVACITY	08 >	•
50	VIVACITY SPORTLINE	11 >	•
80	SV	96 >	•

TGB

50	EXPRESS	09 >	•
50	GT	09 >	•
125	EXPRESS	09 >	•



07019.CC

35.3 x 48.8 x 6.9

07019.XS

“ “ “

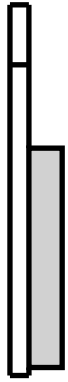
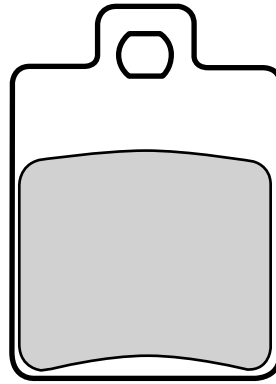

3



DERBI

50	SONAR	10 >	•
125	SONAR 4-STROKE	10 >	•
150	SONAR 4-STROKE	10 >	•

GILERA

180	RUNNER FXR	98 >	•
180	RUNNER SP	99 >	•
180	RUNNER VXR	01 >	•
180	RUNNER VXR 4T (HENGTONG CALIPER)	00 >	•

200	RUNNER VXR	02 >	•
200	RUNNER VXR 4T (HENGTONG CALIPER)	01 >	•
250	STALKER	97 >	•

PIAGGIO

50	ENERGY EXTREME DD	99 >	•
50	LIBERTY S 2-STROKE, 4-STROKE	06 >	•
50	VESPA S 2T	07 >	•
50	VESPA S 4T-4V	09 >	•

50	ZIP	96 >	•
50	ZIP 4T	00 >	•
50	ZIP CATALYZED	00 >	•
50	ZIP II	01 >	•
50	ZIP SPORT RST	96 > 97	•
125	LIBERTY S	06 >	•
125	MP3	09 >	•
125	MP3 HYBRID	10 >	•
125	MP3 IE	09 > 09	•
150	VESPA LX	08 >	•
300	MP3 LT I.E.	10 >	•
500	MP3 SPORT	10 >	•





07020.CC

50.6 x 53.4 x 9.4

07020.XS

“ “ “

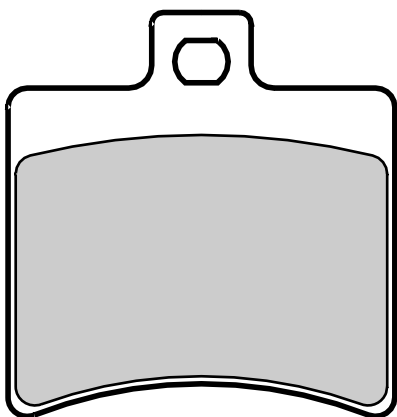

3



APRILIA

50	SCARABEO DITECH	02 >	•
50	SR DITECH	00 >	•
50	SR R	05 >	•
50	SR R FACTORY	05 >	•
50	SR R FACTORY REPLICA SBK	10 >	•
50	SR STREET	05 >	•
125	ATLANTIC	03 >	•
125	RS	06 > 16	•
125	SCARABEO	99 > 03	•
125	SCARABEO GT	04 >	•
125	SCARABEO I.E.	08 >	•
125	SPORTCITY	05 >	•
150	SCARABEO	99 >	•
150	SCARABEO GT	04 >	•
200	ATLANTIC	03 >	•
200	SCARABEO	02 > 06	•
200	SCARABEO	07 >	•
200	SCARABEO CLASSIC	10 >	•
200	SCARABEO GT	01 >	•
200	SCARABEO I.E.	12 >	•
200	SPORTCITY	05 >	•

250	ATLANTIC	04 >	•
250	LEONARDO	99 >	•
250	SCARABEO	04 > 05	•
250	SCARABEO I.E.	06 >	•
250	SPORTCITY	06 >	•
300	ATLANTIC	10 >	•
300	LEONARDO ST	05 >	•
300	SCARABEO SPECIAL	10 >	•
300	SPORTCITY CUBE	08 >	•
400	ATLANTIC SPRINT	06 >	•
400	SCARABEO I.E.	06 >	•
500	ATLANTIC	02 > 05	•
500	ATLANTIC SPRINT	06 >	•
500	SCARABEO CLASSIC	10 >	•
500	SCARABEO GT ABS right caliper	06 >	•
500	SCARABEO ie right caliper	06 >	•

BETA

50	EIKON	04 >	•
125	EIKON	00 > 03	•
150	EIKON	04 >	•

DERBI

125	RAMBLA	10 >	•
250	RAMBLA	10 >	•
300	RAMBLA	08 >	•

MALAGUTI

125	F18 PROJECT	00 >	•
125	F18 WARRIOR	00 >	•
125	PHANTOM MAX	04 >	•
150	F18 PROJECT	00 >	•
150	F18 WARRIOR	00 >	•
150	MADISON	99 >	•
180	MADISON	02 >	•
200	MADISON	03 >	•
200	MADISON BLACK RIDER	03 >	•
200	PHANTOM MAX	04 >	•
250	MADISON 3	08 >	•
250	MADISON RS	05 >	•
250	PASSWORD	06 >	•
250	PHANTOM MAX	05 >	•
400	MADISON	02 >	•



07021.CC

53.6 x 50.7 x 7.9

07021.XS

“ “ “

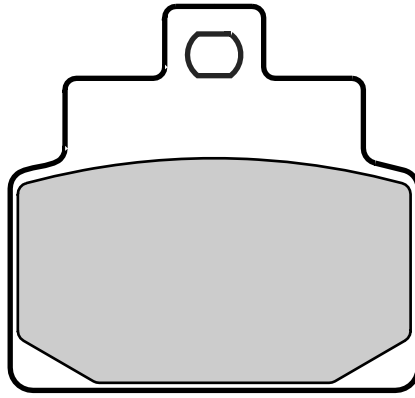

3



APRILIA

50	SCARABEO 4T	04 >	•
50	SCARABEO 4T RESTYLING	06 > 08	•
100	SCARABEO	00 >	•

100	SCARABEO 4-STROKE	04 >	•
100	SCARABEO NET	10 >	•
125	HABANA	99 > 02	•
125	HABANA CUSTOM	00 > 02	•
125	HABANA DITECH	02 > 02	•
125	LEONARDO	99 > 02	• •

125	MOJITO	03 > 08	•
125	SR	99 >	•
125	SR REPLICA	99 > 01	•
150	LEONARDO	99 > 02	• •
150	SR	99 >	•
150	SR REPLICA	99 >	•



07022.CC

84.8 x 43 x 8.6

64 x 36.7 x 11

07022.XS

“ “ “

3

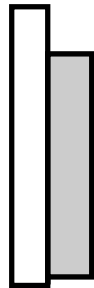
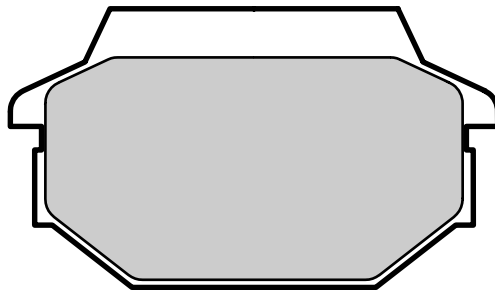
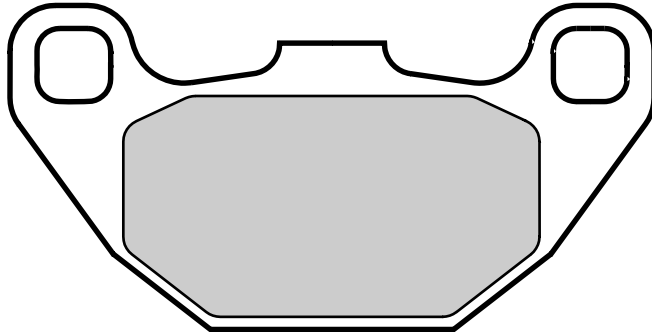

KYMCO

50	AGILITY R16	06 >	•
50	LIKE	08 > 09	•
50	MAXXER	03 >	•
50	MXU	05 >	•
50	PEOPLE	99 >	•
50	PEOPLE S	06 >	•
50	PEOPLE S 4-STROKE	06 >	•
50	SUPER 8	08 >	•
50	SUPER 9 L.C.	02 >	•
125	AGILITY 16 PLUS	14 >	•
125	AGILITY R16	08 >	•
125	MAXXER	03 >	•

125	PEOPLE	99 >	•
125	PEOPLE ONE I	14 >	•
125	PEOPLE S	06 >	•
125	SUPER 8	08 >	•
125	SUPER 9	00 >	•
150	AGILITY R16	08 >	•
150	MAXXER	03 >	•
150	MXU	05 >	•
150	PEOPLE	99 >	•
200	AGILITY	11 >	•
200	AGILITY 16 PLUS	14 >	•
200	AGILITY R16	11 >	•
200	PEOPLE S	05 >	•
250	SUPER 9	00 >	•



LAVERDA

125	PHOENIX	01 >	•
150	PHOENIX	01 >	•
200	PHOENIX	01 >	•

SYM

125	HD	05 >	•
125	JOYRIDE	01 >	•
150	JOYRIDE	01 >	•
200	HD	04 > 06	•
200	JOYRIDE	01 >	•
500	GT	07 >	•





07023.CC

105 x 43.8 x 7.9
65.8 x 36.5 x 12.7

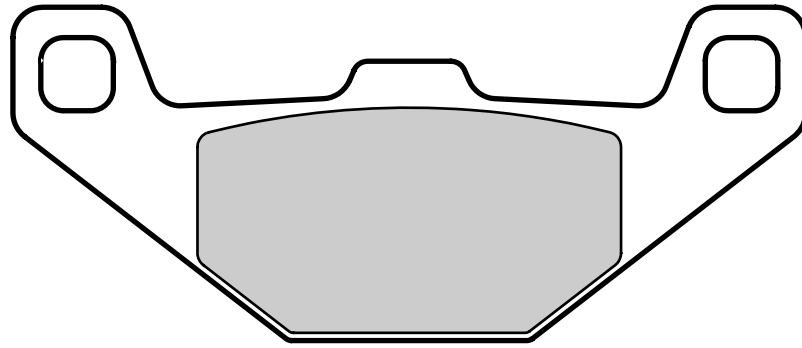

3

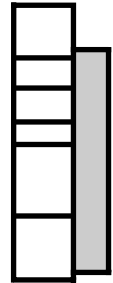
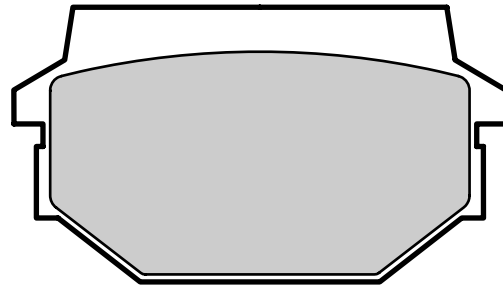

SYM

125 HUSKY	99 >	•
150 HUSKY	99 >	•

**07024.CC**

41.1 x 45 x 8

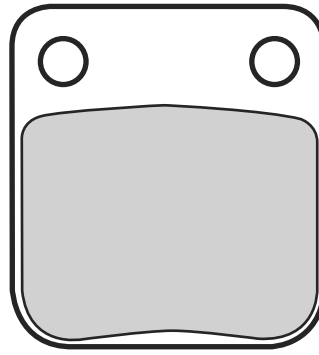
**DAELIM**

50	CORDI	06 >	•
50	DELFINO	99 >	•
50	E-FIVE	03 >	•
50	MESSAGE II	98 >	•
50	S-FIVE	06 >	•
50	TAPO	99 >	•
50	VIVO	99 >	•

100	ALTINO	99 >	•
100	DELFINO	99 >	•
125	ALTINO	02 >	•
125	DLX	01 >	• •
125	HISTORY	01 >	• •
125	MESSAGE II	00 >	•
125	NF	03 >	•
125	NS II	00 >	•
125	OTELLO	99 > 07	•

125	OTELLO	08 >	•
125	S2 FI	07 >	•
125	U3 FI	07 >	•
125	VS	95 > 99	•

HONDA

50	SC 01	91 >	•
50	SP	91 >	•

**07025.CC**

89.9 x 49 x 9

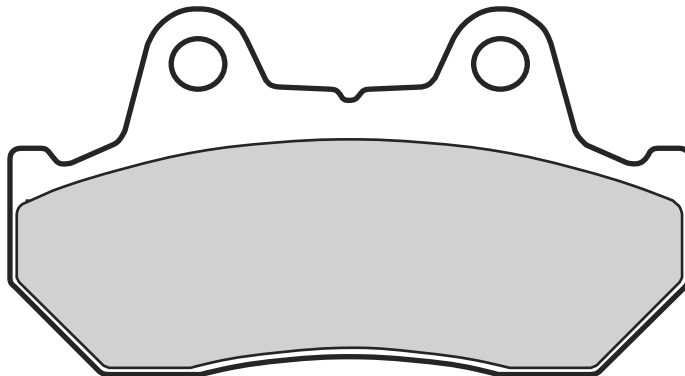
**HONDA**

250	CN	93 > 01	•
250	CN HELIX	86 > 87	•

250	CN HELIX	92 > 92	•
250	CN SCOOTER	88 > 92	•
250	CN SPAZIO	90 > 92	•

SYM

110	BULLET	93 >	•
125	AERO WOLF	70 >	•

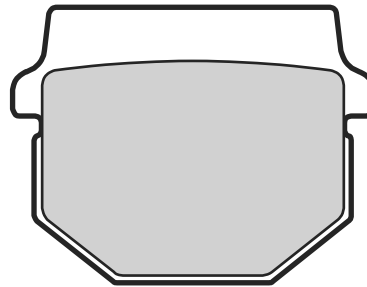
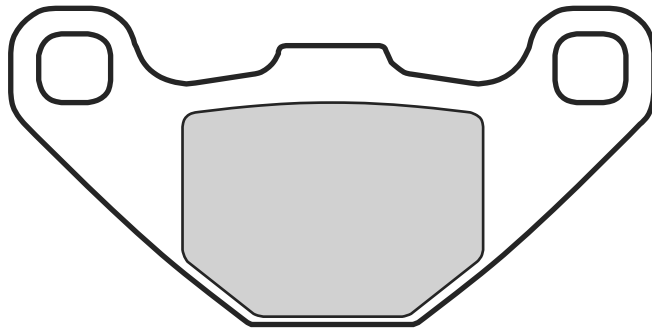
**07026.CC**84.9 x 42.4 x 7.8
47.4 x 37 x 10

3

**ADLY**

50	PANTHER	01 >	•
50	SILVER FOX	06 >	•
50	SUPERSONIC	00 >	•
50	THUNDERBIKE	97 >	•
100	PANTHER	01 >	• •
100	SILVER FOX	06 >	•
100	SUPERSONIC	01 >	• •
100	THUNDERBIKE	01 >	• •
125	SUPERSONIC	01 >	• •
125	THUNDERBIKE	01 >	• •

AEON

50	AERO	06 >	•
50	PULSAR	06 >	•
50	REGAL	06 >	•
50	TORCH	06 >	•
90	REGAL	06 >	•
100	PULSAR	06 >	•
110	AERO	06 >	•
110	PULSAR	06 >	•
125	PULSAR	06 >	•
125	URBAN	11 > 13	•
150	PULSAR	06 >	•
200	ELITE	11 >	•
350	URBAN	11 >	•

APRILIA

50	SX	14 >	•
----	----	------	---

FANTIC MOTOR

50	PONY SR	93 >	•
----	---------	------	---

GILERA

50	EAGLET	97 >	•
----	--------	------	---

HYOSUNG

50	AVANTI	99 >	•
50	CRUISE	95 >	•
50	PRIMA	98 >	•
50	RUSH	97 >	•
50	SB	00 >	•
50	SD	00 >	•
50	SENSE	98 >	•
50	SF	99 >	•
50	SUPER CAB	98 >	•
50	SUPER CAB PLUS	98 >	•
100	CAB	98 >	•
100	EZ	00 >	•
110	FX	02 >	•
110	MIDAS PLUS	98 >	•

ITALJET

50	CRUISE	94 >	•
----	--------	------	---

KEEWAY

50	FLASH	07 >	•
50	HURRICANE	06 >	•
90	HURRICANE	06 >	•

KREIDLER

50	FLORETT	99 >	•
----	---------	------	---

LINHAI

50	PRINCE	06 >	•
125	EGGY	06 >	•

MAICO

50	CRUISER	99 >	•
50	HARD ENDURO	99 >	•
50	SUPER CROSS	99 >	•

50	SUPERBIKE	99 >	•
50	THUNDERBIKE,II	99 >	•

MALAGUTI

125	BLOG	10 >	•
160	BLOG	10 >	•

MZ

50	MOSKITO MUZ	00 >	•
----	-------------	------	---

PEUGEOT

50	BUXY R (HENGTONG CAL.)	93 > 97	•
50	KISBEE	10 >	•
50	KISBEE RS	11 >	•
50	SPEEDAKE (HENGTONG CALIPER)	94 >	•
50	SPEEDFIGHT	97 >	•
50	SQUAB (HENGTONG CALIPER)	94 >	•
50	TREKKER OFFROAD	99 >	•
50	VIVACITY (HENGTONG CAL.)	05 >	•
100	SPEEDFIGHT	96 >	•
100	VIVACITY (HENGTONG CALIPER)	05 >	•

PGO

50	COMET	91 > 92	•
50	GALAXY	91 >	•
50	PS	93 >	•
50	ROAD 66	95 >	•
90	GALAXY	92 >	•





SIAMOTO

50	MAT	98 >	•
100	MAT	97 >	•

SMC

50	EASY RIDER	97 >	•
----	------------	------	---

SULA

50	THUNDER BIRD	99 >	•
100	THUNDER BIRD	99 >	•
125	THUNDER BIRD	99 >	•

SUZUKI

50	AE	88 >	•
50	AH ADDRESS	92 > 95	•
50	SEPIA	92 >	•
50	TUNE	92 >	•
50	ZZ	92 >	•
80	AH ADDRESS	88 >	•

100	AH ADDRESS	91 >	•
125	AN	93 > 93	•
125	LIDO VARIO	90 >	•

TGB

50	101 S	99 >	•
50	202 T	99 >	•
50	303 R	99 >	•
50	309 RS	00 >	•
50	409 F	00 >	•
50	AKROS	93 >	•
50	BULLET RR	11 >	•
50	BULLET RS	11 >	•
50	BUNNY	97 >	•
50	ERGON	93 >	•
50	HIW'S	99 >	•
50	HOOK	10 >	•
50	TAPO RS	11 >	•
90	101 S	99 >	•
90	202 T	99 >	•
90	AKROS	99 >	•

90	ERGON	99 >	•
90	HIW'S	99 >	•
125	101 S	99 >	•
125	202 T	99 >	•
125	303 R	99 >	•
125	309 RS	00 >	•
125	409 F	00 >	•
125	BULLET RR	11 >	•
125	BULLET RS	11 >	•
125	HOOK	10 >	•
150	303 R	00 >	•
150	309 RS	00 >	•
150	409 F	00 >	•

UVM

50	BETHERE	99 >	•
50	BINGO	99 >	•
125	BETHERE	99 >	•
125	BINGO	99 >	•
125	PARAGON	99 >	•



07027.CC

76.9 x 41.9 x 7

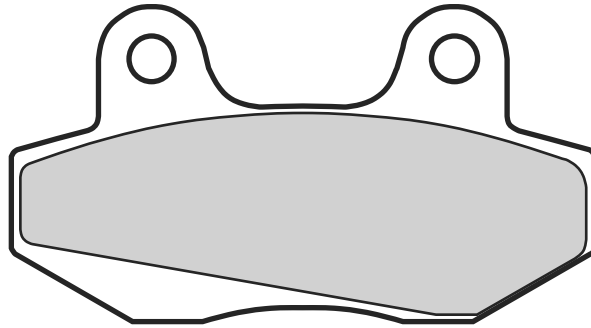

3



AXY

50	SLURP	08 > 11	•
125	GULP	07 >	•
125	SLURP	08 > 11	•
125	YUK	07 >	•
150	GULP	08 > 11	•
150	SLURP	08 > 11	•
150	YUK	07 >	•
200	GULP	07 >	•
200	YUK	07 >	•
300	ROAR	08 >	•

CAGIVA

50	MITO	99 > 02	•
116	STELLA	97 >	•

DAELIM

110	CITY ACE	03 >	•
-----	----------	------	---

GARELLI

125	JOKER	02 >	•
150	JOKER	02 >	•

HONDA

50	MBX FW, FWD, SW	83 > 90	•
50	MBX S	83 > 90	•
50	NS AERO	88 >	•
50	NS-1	91 >	•
50	NSR	87 >	•
75	NSR	88 >	•
80	MBX	83 > 85	•
80	MBX DX	82 >	•
80	MBX SW, SWD	83 >	•
80	MCX S	82 >	•
80	NSR R	87 > 92	•
125	CBX CUSTOM	88 >	•
125	FJ SONIC	03 >	•
125	MBX RWB	84 >	•
250	CB REBEL	86 >	•
250	CMX REBEL	85 > 95	•

HYOSUNG

125	EXCEED	02 >	•
125	GRAN PRIX PLUS	02 >	•
125	GT COMET	02 > 04	•
125	GV AGUILA	02 > 04	•
125	RT KARION	02 > 06	•

125	RX	00 >	•
125	XRX	99 > 06	•
250	GV	02 >	•
400	XRV	05 >	•
600	COMET	03 >	•

KYMCO

100	SPIKE	02 >	•
110	SPIKE	03 >	•
125	CK	04 >	•
125	JETIX	08 >	•
125	SPIKE	02 >	•

MZ

125	(MUZ) MANTIZZ S	07 >	•
-----	-----------------	------	---

SACHS

50	MADASS	04 > 04	•
50	MADASS	05 >	•

SYM

125	WOLF	02 >	•
125	WOLF CLASSIC	05 >	•
180	MF	03 >	•





07028.CC

74.9 x 36.1 x 9.5

3

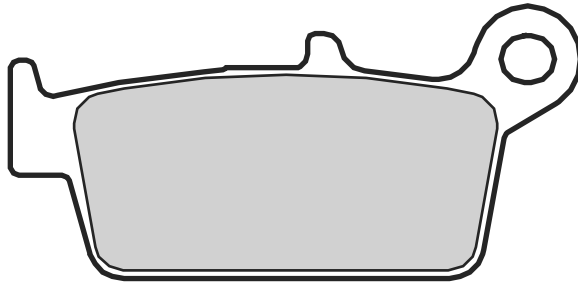
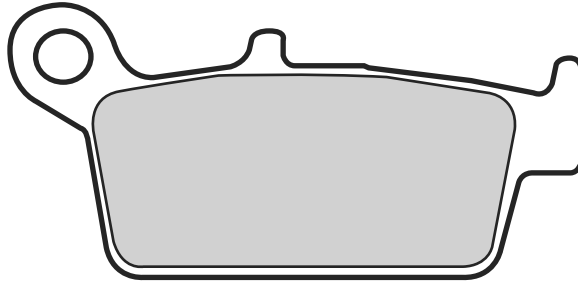

DAELIM

125 BESBI 08 > •

50 SKY VETRO 00 > •

50 SXR SHADOW 98 > •

90 SHADOW 98 > •

50 COBRA RACER 99 > 00 •

50 SUPER 9 00 > 01 •

50 ZX SUPER FEVER 02 > •

50 ZX12 06 > •

90 HANBOY 96 > •

125 SUPER 9 00 > •

250 SUPER 9 00 > •

HONDA

50 SHADOW 98 > •

50 SKY CLASSIC 00 > •

KYMCO

50 COBRA CROSS 99 > 00 •



07029.CC

86.1 x 39.9 x 10.7

07029.XS

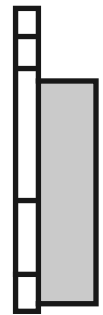
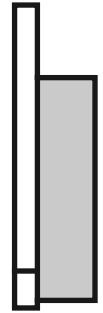
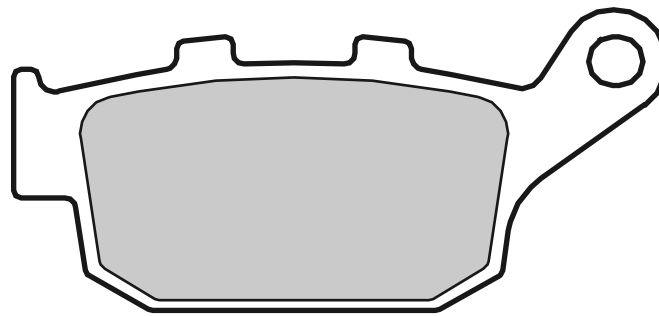
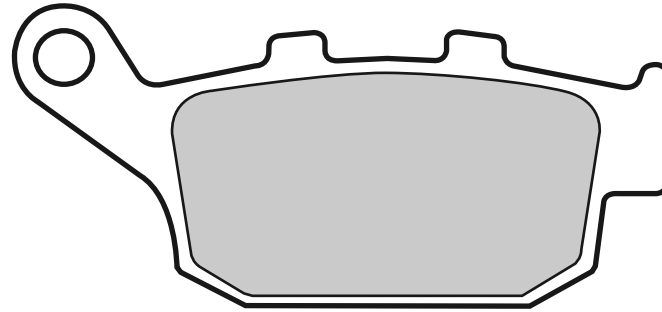

3



HONDA

125	PANTHEON FES	03 >	•
150	PANTHEON FES	03 >	•
250	FORESIGHT	00 >	•

PEUGEOT

250	SV	02 >	•
-----	----	------	---

**07031.CC**

51.7 x 36.5 x 8.3

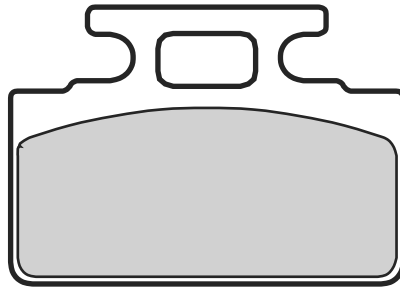
**HONDA**

50	NH LEAD	86 > 93	•
90	LEAD	89 >	•
125	NS	89 >	•
250	NS	89 >	•
250	RS R	93 >	•

KYMCO

50	MANBOY	95 >	•
50	ZAP	95 >	•
90	YUP SP	95 >	•

SANYANG

50	FEEL BIG	98 >	•
50	PURE	98 >	•

SYM

50	BULLET	93 >	•
50	CINDARELLA	01 >	•
50	DD	02 >	•
50	FEEL BIG	98 >	•
50	MIO	05 >	•
50	PURE	98 >	•
100	CINDARELLA	01 >	•
100	MIO	05 >	•

**07032.CC**

40.9 x 42.7 x 8

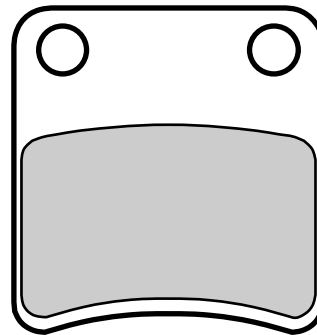
**BS VILLA**

50	ZX	93 >	•
----	----	------	---

CAGIVA

50	CITY	92 > 94	•
----	------	---------	---

DAELIM

50	BONITA	09 >	•
50	GZ	98 >	•

GARELLI

125	PANTHER	02 >	•
150	PANTHER	02 >	•
250	PANTHER	02 >	•

HONDA

50	CRM	93 > 96	•
50	GP DIO	90 > 97	•
50	SR DIO	90 > 93	•
50	ZX DIO	90 > 93	•

SANYANG

50	SUPER FANCY	98 >	•
----	-------------	------	---

SYM

50	CHA-CHA	99 >	•
50	CINDARELLA	99 > 00	•
100	CINDARELLA	99 > 00	•



07033.CC

76.9 x 41.9 x 9.2

96.6 x 41.9 x 9.2

07033.XS

“ “ “

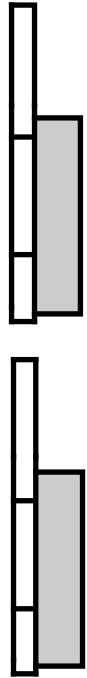
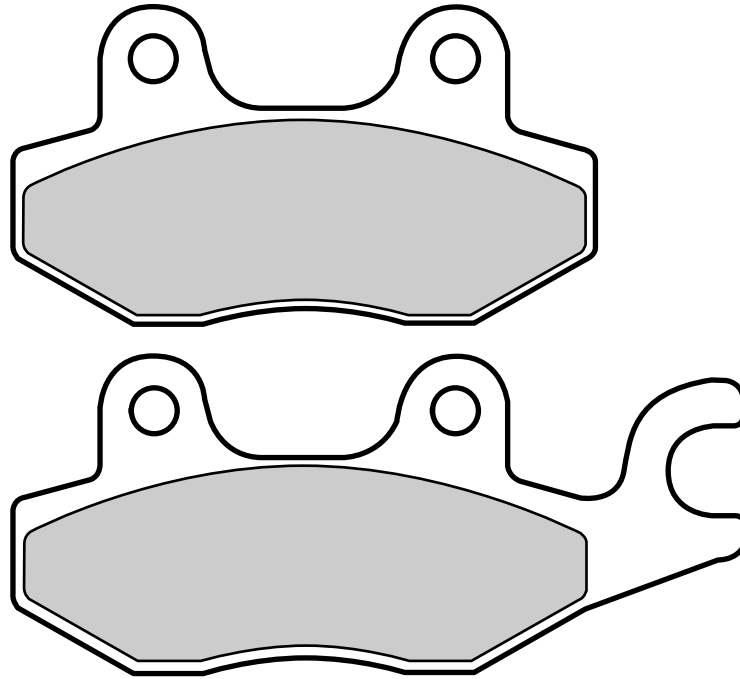

3



AEON

120 OZ	14 >	•
125 URBAN	14 >	•

DAELIM

125 ROADWIN	04 >	•
125 S3	11 >	•
150 ROADWIN X5	06 >	•
250 ROADWIN	08 >	•

HONDA

75 NS 1	92 >	•
80 NSR R	93 >	•

KEEWAY

100 PARTNER	06 >	•
110 PARTNER	06 >	•
125 SPEED	06 >	•
150 SPEED	06 >	•

KYMCO

50 AGILITY 4-STROKE	05 >	•
50 B & W	01 > 05	•
50 DINK	98 >	•
50 DINK CLASSIC	02 >	•
50 K-PIPE	12 >	•
50 LIKE	10 >	•
50 NEW DINK	08 >	•
50 SPACER	99 >	•

50 SUPER 9	02 >	•
50 SUPER 9 L.C.	02 >	•
50 YAGER	01 >	•
100 COBRA RACER	99 >	•
125 AGILITY 16 PLUS	14 >	•
125 B & W	00 >	•
125 DINK	98 >	•
125 DINK CLASSIC	02 >	•
125 DINK LX	99 >	•
125 GRAND DINK	02 >	•
125 HIPSTER	01 >	•
125 JOYRIDE	01 >	•
125 LIKE	10 >	•
125 MOVIE XL	99 >	•
125 NEW DINK	08 >	•
125 PULSAR	01 >	•
125 SPACER	99 >	•
125 TECHNO GT	06 >	•
125 YAGER	01 >	•
125 YAGER GT	09 >	•
125 ZING	96 >	•
150 AGILITY R16	08 >	•
150 B&W	00 >	•
150 DINK	98 >	•
150 DINK LX	98 >	•
150 GRAND DINK	02 >	•
150 HIPSTER	01 >	•
150 JOYRIDE	01 >	•
150 MOVIE XL	01 >	•
150 QUANON	10 >	•
150 SPACER	99 >	•

150 YAGER	01 >	•
150 ZING	99 >	•
200 AGILITY	11 >	•
200 AGILITY 16 PLUS	14 >	•
200 AGILITY R16	11 >	•
200 DINK CLASSIC	04 >	•
200 LIKE 200 I	10 >	•
200 NEW DINK	08 >	•
200 YAGER	04 >	•
250 B & W	00 >	•
250 PEOPLE	03 >	•
250 PEOPLE S left caliper	06 >	•
250 YUP	03 >	•
300 PEOPLE S	08 > 10	•
300 PEOPLE S1 left caliper	08 >	•
400 G 3 RIGHT CALIPER	00 >	•

MOTOR UNION

125 MAXI	99 >	•
150 MAXI	99 >	•
150 MIDI	99 >	•
400 MAXI	99 >	•

SYM

125 RS	05 >	•
150 RS	05 >	•

TGB

50 BUFFALO	03 >	•
50 FIRE, SKY	03 >	•





07034.CC

115 x 40.1 x 9.4

07034.XS

“ “ “

3

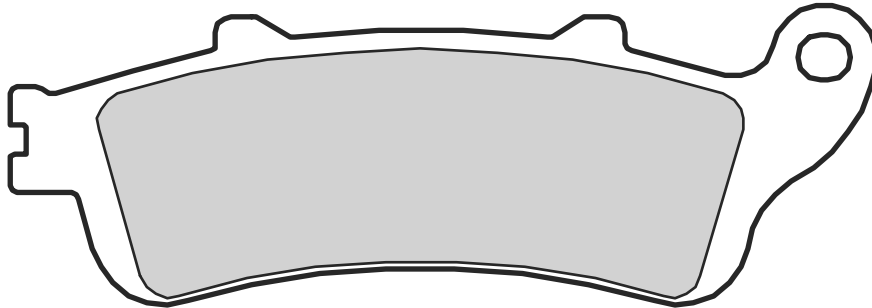
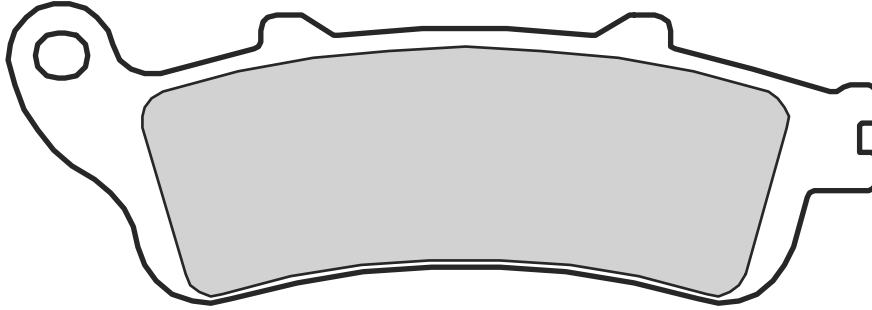

HONDA

125	PANTHEON	98 > 02	•
125	PANTHEON FES	98 > 02	•
125	PANTHEON FES	03 >	•
150	PANTHEON	98 > 02	•

150	PANTHEON FES	98 > 02	•
150	PANTHEON FES	03 >	•
250	FORESIGHT	97 > 99	•
250	FORESIGHT	00 >	•
250	FORZA	00 > 04	•

250	NSS JAZZ	00 > 04	•
1100	ST A6 ABS-TCS-CBS	96 >	•

PEUGEOT

250	SV	02 >	•
-----	----	------	---



07035.CC

76.9 x 41.9 x 9.2

96.6 x 41.9 x 9.2

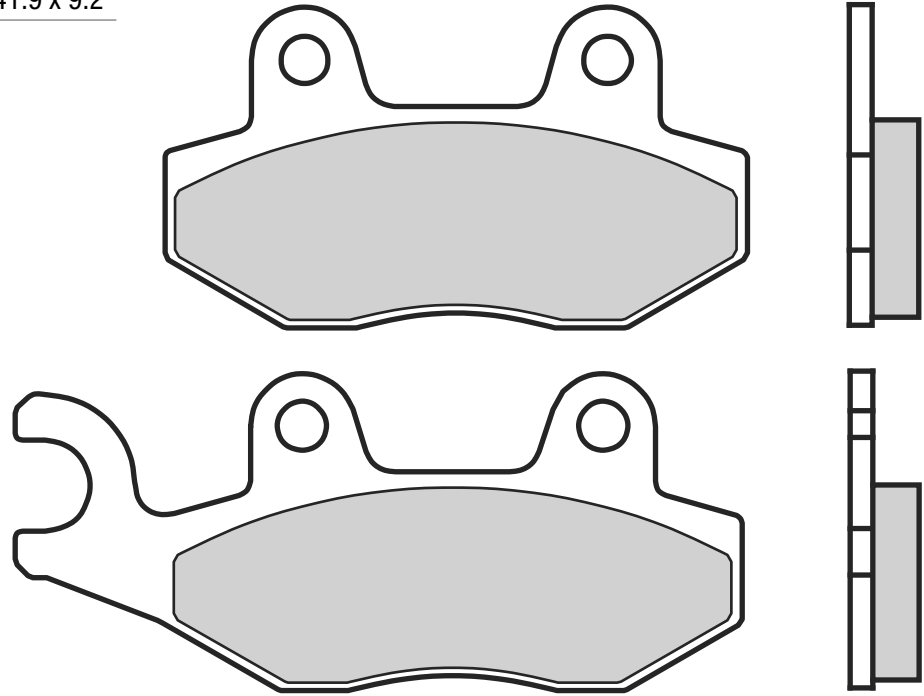

3



AEON

125 ELITE	13 >	•
125 URBAN	11 > 13	•
200 ELITE	11 >	•
350 URBAN	11 >	•
400 ELITE	13 >	•

BENELLI

150 CAFFE' NERO	11 > 15	• •
350 ZENZERO	12 >	•

DAELIM

50 A-FOUR	06 >	•
125 DELFINO	08 >	•

HONDA

250 CMX REBEL	97 >	•
---------------	------	---

KEEWAY

125 SUPERLIGHT	06 >	•
150 SUPERLIGHT	06 >	•
250 LAND CRUISER	06 >	•

KREIDLER

125 ENDURO	07 >	•
125 SUPERMOTO	07 >	•
200 ENDURO	07 > 09	•

KYMCO

50 AGILITY R10	06 >	•
50 AGILITY R12	06 >	•
50 FILLY	02 >	•
50 NEW SENTO	11 >	•
50 RS AGILITY NAKED	10 >	•
50 SENTO	08 > 10	•
50 YUP SP	02 >	•
125 AGILITY	05 > 07	•
125 AGILITY CITY	11 >	•
125 LIKE	10 >	•
125 MOVIE	98 >	•
125 STRYKER	99 >	•
125 VIVIO	00 >	•
150 STRYKER	01 >	•
150 VIVIO	00 >	•
200 LIKE 200 I	10 >	•
250 PEOPLE S right caliper	06 >	•
300 PEOPLE S	08 > 10	•
300 PEOPLE SI right caliper	08 >	•
400 G 3 LEFT CALIPER	00 >	•

MALAGUTI

125 BLOG	10 >	•
125 CENTRO IE	08 >	•
160 BLOG	10 >	•
160 CENTRO IE	08 >	•

MZ

125 SM	02 >	•
125 SX	02 >	•

PEUGEOT

250 GEOPOLIS	06 >	• •
250 SATELIS	06 >	• •

PGO

125 CHARGE	03 >	•
------------	------	---

TGB

50 203	05 >	•
50 APOLLO	99 >	•
90 APOLLO	99 >	•
250 DYNASTY	06 >	•





07036.CC

99.2 x 39.7 x 7.6

75.4 x 40.7 x 8.4

3

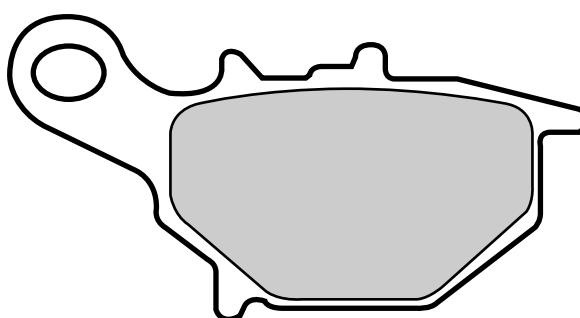
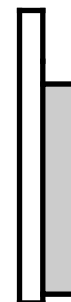
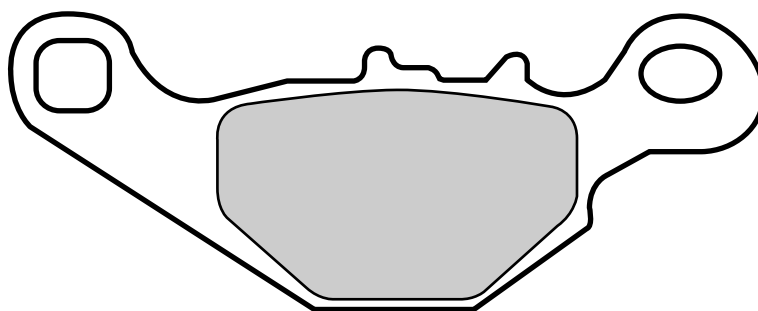

SUZUKI

50	AN	95 >	•
50	STREET MAGIC	98 >	•
80	RM T	96 >	•
85	RM	02 > 04	•

110	HOKUTO UG	00 >	•
125	AN	94 >	•
125	DR Z	03 >	•
125	EPICURO UC	99 >	•
125	VECSTAR	94 >	•

150	AN	96 >	•
150	EPICURO UC	99 >	•
150	UE	02 >	•
250	EPICURO	99 >	•
250	VECSTAR	94 >	•



07037.CC 44.5 x 53.5 x 8.6
07037.XS “ “ “

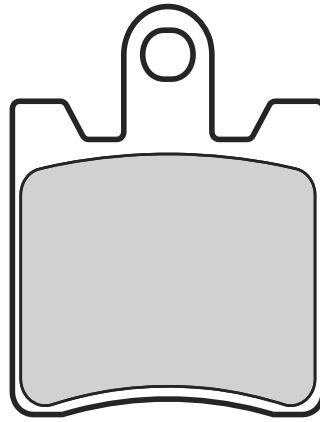

3



DAELIM

125 OTELLO	08 >	•
125 S2 FI	07 >	•
125 S3	11 >	•
125 U3 FI	07 >	•

KAWASAKI

250 SC EPSILON	02 >	•
----------------	------	---



SUZUKI

250 BURGMAN	98 > 03	•
250 BURGMAN	04 > 06	•
250 SKY WAVE TYPE II	98 >	•
400 BURGMAN	99 > 00	•
400 BURGMAN	01 > 06	•

SYM

200 JOYRIDE EVO	09 >	•
250 GTS	07 >	•
300 GTS	09 >	•
300 GTS EVO	11 >	•
300 JOY MAX EVO	10 >	•
300 JOYRIDE EVO	10 >	•
500 GT	07 >	•



07038.CC 80.9 x 41.7 x 9.3
07038.XS “ “ “

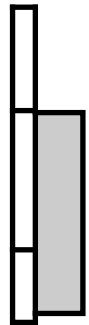
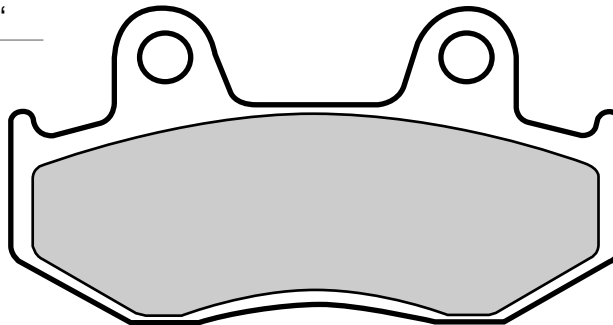

HONDA

110 LEAD	08 > 09	•
110 SCV	08 >	•
125 @ NES	00 >	•
125 DYLAN	02 >	•



125 PS	07 >	•
125 SH MODE	01 > 08	•
150 @ NES	00 >	•
150 DYLAN	02 >	•
150 PS I	06 >	•
250 CN SPAZIO	88 > 89	•

SUZUKI

250 BURGMAN	98 > 03	•
250 SKY WAVE TYPE II	98 >	•
400 BURGMAN	99 > 00	•



**07039.CC**

70.9 x 36.1 x 9.2

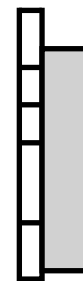
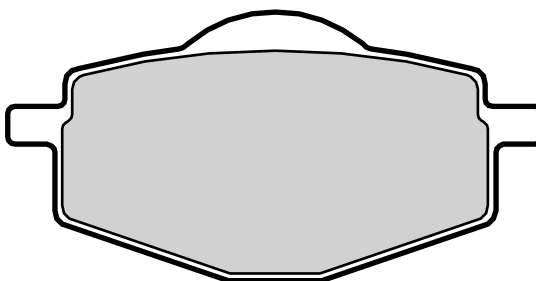
**AXY**

125 GULP	07 >	•
125 SLURP	08 > 11	•
125 YUK	07 >	•
150 GULP	08 > 11	•
150 SLURP	08 > 11	•
150 YUK	07 >	•
200 GULP	07 >	•
200 YUK	07 >	•

GARELLI

XO ELETTRIC	12 >	•
125 XO	12 >	•
150 XO	12 >	•
200 XO	12 >	•

MBK

125 FLAME R	95 > 03	•
125 NEW FLAME	99 >	•
150 VERTEX	97 >	•

MALAGUTI

125 CENTRO IE	08 >	•
160 CENTRO IE	08 >	•

YAMAHA

50 CYGNUS	96 >	•
105 CRYPTON	98 >	•
125 CYGNUS	96 > 10	•
125 CYGNUS F	00 >	•
150 FLY ONE	92 >	•
150 FLY ONE R	98 >	•

**07040.CC**

93.6 x 35.8 x 10.1

07040.XS

“ “ “

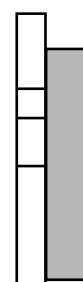
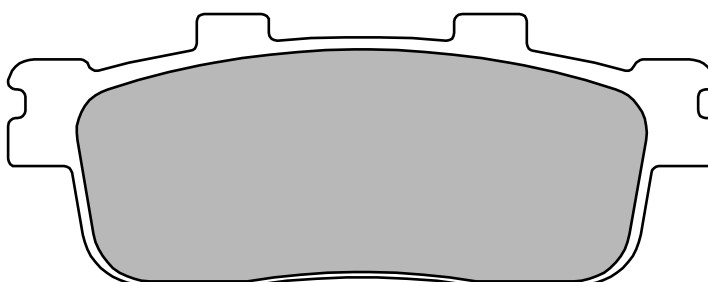
**PEUGEOT**

125 LXR	10 >	•
200 LXR	10 >	•

SYM

125 EVO	14 >	•
125 HD EVO DT	10 >	•

125 JOYRIDE EVO	10 >	•
125 JOYRIDE S	16 >	•
200 HD EVO	07 >	•
200 JOYRIDE S	16 >	•
250 GTS	07 >	•
250 JOYMAX	07 >	•
250 RV EFI	10 >	•
300 GTS EVO	11 >	•

300 JOY MAX EVO	10 >	•
300 JOYRIDE EVO	10 >	•

TGB

125 X-LARGE	11 >	•
125 X-MOTION	08 >	•
250 X-MOTION	08 >	•
300 X-MOTION	11 >	•



07041.CC

61 x 27 x 7.3

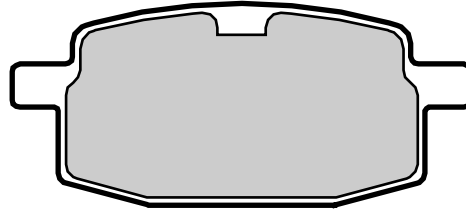

ADLY

50	CAT	01 >	•
50	COSY	01 >	•
50	FOX	00 >	•
50	FOX PLUS	01 >	•
50	JET	96 >	•
50	PISTA	96 >	•
50	ROAD TRACER	02 >	•
50	SILVER FOX	00 > 05	•
70	FOX PLUS	01 >	•
70	PISTA	01 >	•
80	COSY	01 >	•
90	ROAD TRACER	02 >	•
100	CAT	01 >	•
100	JET	96 >	•
100	ROAD TRACER	02 >	•
100	SILVER FOX	01 > 05	•
125	CAT	01 >	•

BENELLI

50	KB-X RACE	95 >	•
----	-----------	------	---

CAGIVA

50	CITY	08 >	•
----	------	------	---

FANTIC MOTOR

50	BIG WHEEL	93 >	•
50	FLYING TIGER	96 >	•
50	GRINTA	95 >	•
50	LEADER	95 >	•
50	QUEENIE	95 >	•
50	SPIKE	96 >	•

GARELLI

50	BIG WHEEL	93 >	•
50	BIP-RACING	94 >	•
50	FX	02 >	•
50	PONY SR	95 >	•
50	RALLY PMX	00 >	•
125	XO' I	10 > 11	•
150	XO' I	10 > 11	•
200	XO' I	10 > 11	•

ITALJET

50	BAZOOKA	92 >	•
50	PISTA	93 >	•
50	SCOOP	93 >	•
50	YANKEE	93 >	• •

KL

50	KRX	98 >	•
50	KRYPTON	99 >	•
50	XR7	98 >	•
125	NOX	00 >	•
125	PROXY	01 >	•
125	PULSAR	00 >	•
150	NOX	00 >	•
150	PROXY	01 >	•
150	PULSAR	00 >	•

LEM

50	FLASH	93 >	•
----	-------	------	---

MBK

50	TARGET	92 >	•
100	BOOSTER	01 >	•

MZ

50	MOSKITO MUZ	99 > 99	•
125	MOSKITO MUZ	99 >	•

PETERSON

50	HURRICANE	95 >	•
50	SR	95 >	•
80	80 SR	95 >	•
80	HURRICANE	95 >	•

PEUGEOT

50	V-CLIC	08 >	•
----	--------	------	---

PGO

50	BIG MAX	95 > 02	•
50	BIG MAX SPORT	96 >	•

50	COMET	93 >	•
50	EPS	96 >	•
50	HOT	97 >	•
50	MEGA	96 >	•
50	PMX	97 > 00	•
50	TORNADO	96 >	•
80	BIG MAX	94 >	•
90	BIG MAX	97 >	•
90	TORNADO	00 >	•
100	BIG MAX	97 >	•
110	PMX	00 >	•
125	KUNG FU	70 >	•
125	TORNADO	96 >	•

SHE-LUNG

50	FALCON	97 >	•
125	MARS	97 >	•

SIAMOTO

50	BIRDIE	98 >	•
50	TOP RACING	98 >	•
125	FAVOURITE	00 >	•
150	FAVOURITE	00 >	•

SULA

50	CITY BIRD	99 >	•
----	-----------	------	---

TGB

250	DYNASTY	06 >	•
-----	---------	------	---

YAMAHA

50	CHAMPS RS	88 >	•
50	CRZ	92 > 95	•
50	TARGET	91 >	•
80	TZR	92 >	•
90	AXIS	94 >	•
90	JOG-Z	90 >	•
90	TARGET	91 >	•



07042.CC

94 x 40.7 x 10

07042.XS

“ “ “

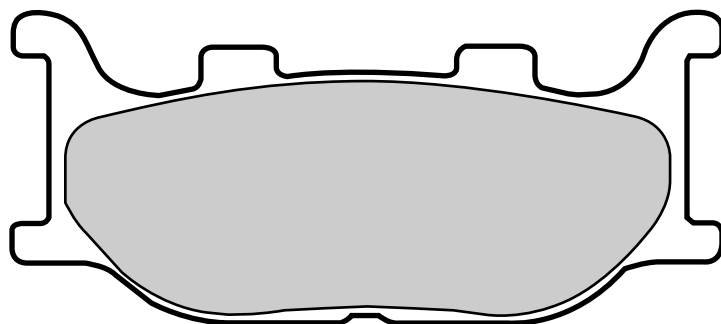

3



ITALJET

125 JUPITER	02 >	•
150 JUPITER	02 >	•
250 JUPITER	00 >	•

LINHAI

125 MONARCH	06 >	•
150 MONARCH	06 >	•

300 MAIN STREET	06 >	•
-----------------	------	---

MBK

250 SKYLINER	00 >	•
400 SKYLINER	04 >	•

YAMAHA

250 MAJESTY	96 >	•
-------------	------	---

250 MAJESTY ABS	98 > 05	•
250 MAJESTY DX	98 > 99	•
250 MAJESTY DX ABS	98 >	•
400 MAJESTY	05 > 06	•
500 T MAX	04 > 07	•
500 T MAX ABS	06 > 07	•
500 T MAX BLACK MAX	06 > 07	•



07043.CC

99.6 x 31 x 9

07043.XS

“ “ “

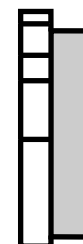
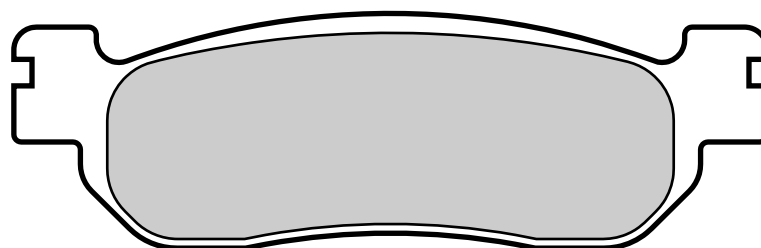

LINHAI

125 MONARCH	06 >	•
150 MONARCH	06 >	•
300 MAIN STREET	06 >	•

MBK

250 SKYLINER	00 >	•
--------------	------	---

YAMAHA

125 X MAX ABS/ BUSINESS ABS	11 >	•
125 X MAX IRON MAX	16 >	•
125 X MAX MOMODESIGN	15 >	•
250 MAJESTY DX	98 > 99	•
250 MAJESTY DX ABS	98 >	•

250 X MAX	06 > 09	•
250 X MAX	10 > 13	•
250 X MAX ABS	11 > 13	•
250 X MAX IRON MAX	16 >	•
250 X MAX MOMODESIGN	16 >	•
250 X-CITY	08 >	•
400 X MAX	13 > 14	•
400 X MAX ABS	13 > 14	•

**07044.CC**

35.7 x 45.4 x 6

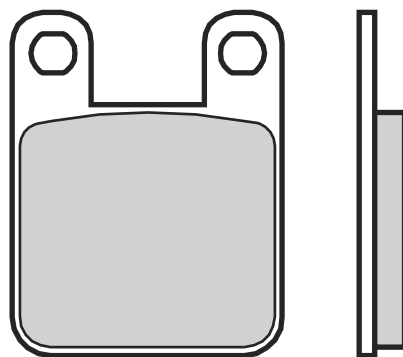

3

**APRILIA**

50 RS	06 >	•
50 RX	06 >	•

BETA

150 EIKON	99 > 03	• •
-----------	---------	-----

CAGIVA

50 MANTIS	98 > 01	•
50 PROGRESS	98 > 01	•

DAELIM

50 HISTORY	01 >	•
50 VARIANT SPORT - R	01 >	•

DERBI

50 ATLANTIS	99 >	•
50 ATLANTIS 4-STROKE	04 >	•
50 ATLANTIS BULLET	04 >	•
50 ATLANTIS CITY	06 >	•
50 ATLANTIS H2O	01 >	•
50 ATLANTIS H2O WAVE	01 >	•
50 ATLANTIS TO CHIC	05 >	• •
50 ATLANTIS WAVE	01 >	•
50 AVENTURA	96 >	•
50 BOULEVARD	09 >	•
50 DS	88 >	•
50 FURAX	96 >	• •
50 GP1	01 > 04	• •
50 GP1	05 >	•
50 HUNTER	96 > 97	•
50 MANHATTAN	99 >	• •
50 PADDOCK	97 >	•
50 PREDATOR	97 > 00	• •
50 RAMBLA	06 >	• •
50 STINGER	96 >	•
50 VAMOS (AJP CALIPER)	95 > 97	•
50 VARIANT SPORT - R	01 >	•
100 ATLANTIS 4-STROKE	04 >	•
100 ATLANTIS H2O	01 >	•
200 BOULEVARD	06 >	•
250 GP1	05 >	•

GARELLI

50 SAHEL	91 >	•
50 XO	12 >	•

GILERA

125 SURFER	00 >	• •
------------	------	-----

HYOSUNG

50 WRS	98 >	•
--------	------	---

ITALJET

50 DRAGSTER	97 > 98	• •
50 FORMULA AIR	99 >	•
50 FORMULA LC	98 >	• •
50 JET SET	02 >	•
50 NEW TORPEDO	00 >	•
50 TORPEDO	97 >	•
50 TORPEDO 4T	01 >	•
125 DRAGSTER (AJP CAL.)	97 >	• •
125 FORMULA (AJP CAL.)	95 >	• •
125 JET SET	02 >	•
125 JUPITER	02 >	•
125 TORPEDO 4T	99 >	•
125 TWIN	98 >	• •
150 JET SET	02 >	•
150 JUPITER	02 >	•
150 TORPEDO 4T	99 >	•
180 DRAGSTER (AJP CAL.)	99 >	• •

MALAGUTI

50 FIFTY	04 >	•
----------	------	---

MBK

50 X LIMIT	04 >	• •
50 X POWER	04 >	•

PEUGEOT

50 BLASTER	09 >	•
50 BLASTER FURIOS	11 >	• •
50 BLASTER RS12	09 >	• •
50 ELYSEO (AJP CALIPER)	99 > 01	• •
50 ELYSTAR	03 >	•
50 JET C-TECH DARKSIDE	10 >	• •
50 JET C-TECH ICE BLADE	10 >	• •
50 JET FORCE	03 >	• •
50 JET FORCE C-TECH	05 >	• •
50 LUDIX	04 >	•
50 LUDIX CLASSIC	04 >	•
50 LUDIX ELEGANCE	04 >	•
50 LUDIX SNAKE	04 >	•

50 LUDIX TREND	04 >	•
50 METAL X	01 >	•
50 SPEEDAKE (AJP CAL.)	95 > 97	•
50 SPEEDFIGHT (AJP CAL.)	99 >	•
50 SPEEDFIGHT LEMANS	11 >	• •
50 SQUAB (AJP CALIPER)	96 >	•
50 TKR	96 >	•
50 TKR FURIOUS	05 >	•
50 TKR STREET ZONE	03 >	•
50 TKR WRC	05 >	•
50 TREKKER	99 >	•
50 TREKKER STREETBOARD	00 >	•
50 TREKKER URBAN BLACK	00 >	•
50 TSDI	04 >	• •
50 VIVACITY	99 > 07	•
50 VIVACITY COMPACT	03 >	•
50 VIVACITY X RACE	03 >	•
50 ZENITH LN/LS	97 >	•
100 ELYSEO	00 >	• •
100 ELYSEO (AJP CALIPER)	98 > 99	•
100 LOOXOR	02 >	•
100 SPEEDFIGHT (AJP CAL.)	98 >	• •
100 SPEEDFIGHT 2 206 WRC	03 >	• •
100 SPEEDFIGHT 2 FURIORS	03 >	• •
100 TREKKER	99 >	• •
100 VIVACITY	99 > 07	•
100 X-FIGHT	00 >	• •
125 ELYSEO	00 >	•
125 LOOXOR	02 >	•
125 LUDIX	04 >	•
125 SATELIS	04 > 05	•
125 XPS CT	06 >	• •
150 LOOXOR	06 >	•

PIAGGIO

50 DIESIS	02 >	•
100 DIESIS	02 >	•

RIEJU

50 FIRST	97 >	•
50 TANGO	08 >	•
50 WINDY	97 >	•





SACHS

50 MADASS 05 > •

SUZUKI

50 KATANA LC 97 > •

50 KATANA RX 98 > •

50 UF ESTELETE 00 > •

50 UX ZILLION 99 > •

50 W, WR 00 > •

TGB

50 HAWK 09 > •

YAMAHA

50 TZR 03 > •

3



07045.CC 117.4 x 38.7 x 8.3

07045.XS “ “ “

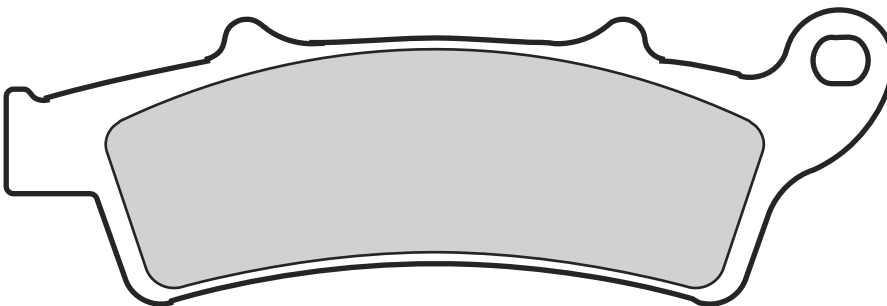
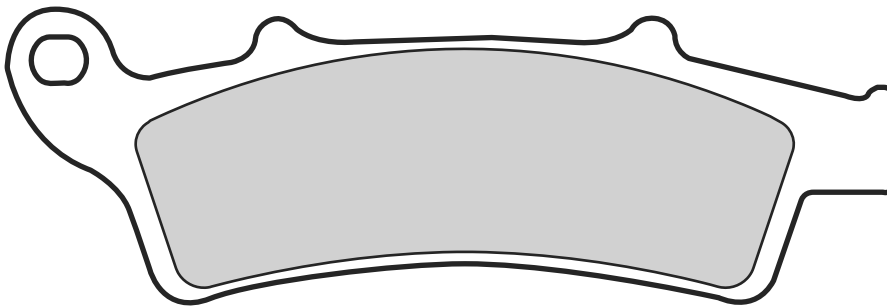

APRILIA

125 ATLANTIC 03 > •

125 SCARABEO GT 04 > •

125 SCARABEO I.E. 08 > •

150 SCARABEO GT 04 > •

200 ATLANTIC 03 > •

200 SCARABEO 07 > •

200 SCARABEO CLASSIC 10 > •

200 SCARABEO I.E. 12 > •

250 ATLANTIC 04 > •

250 SCARABEO 04 > 05 •

250 SCARABEO I.E. 06 > •

300 ATLANTIC 10 > •

300 SCARABEO SPECIAL 10 > •

400 ATLANTIC SPRINT 06 > •

500 ATLANTIC SPRINT 06 > •

KYMCO

125 DOWNTOWN I ABS 16 > •

125 KXCTI 14 > •

125 PEOPLE GTI 10 > 11 •

125 PEOPLE GTI 12 > •

125 XTOWN I ABS 16 > •

200 PEOPLE GTI 12 > •

300 K-XCTI 12 > •

300 PEOPLE GTI 12 > •

300 XTOWN I ABS 16 > •

MALAGUTI

250 MADISON 99 > •

400 MADISON 02 > •

PEUGEOT

100 LOOXOR 02 > •

125 LOOXOR 02 > •

150 LOOXOR 02 > 05 •

PIAGGIO

350 BEVERLY SPORT 12 > •

TOURING IE



07046.CC

77 x 47.7 x 7.1

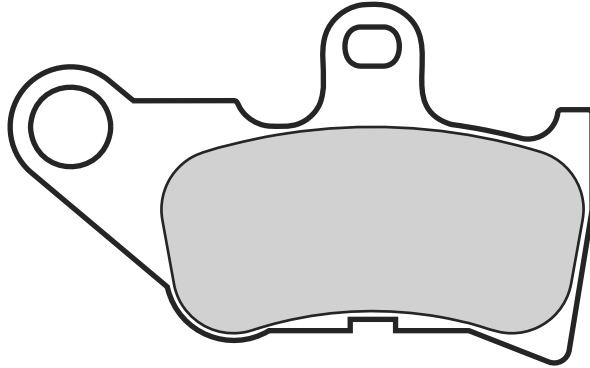

3

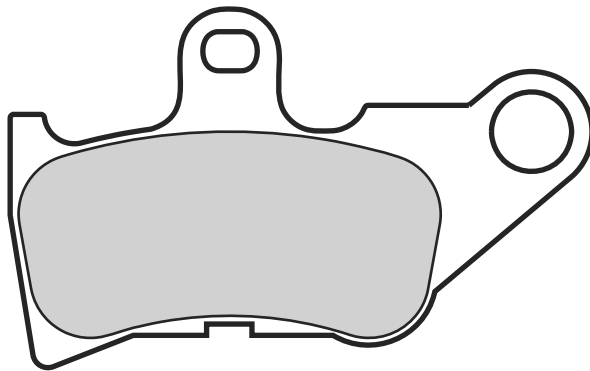

YAMAHA

50	JOG	01 >	•
50	JOG ZR	01 >	•



07047.CC

55.4 x 49.4 x 7

07047.XS

“ “ “

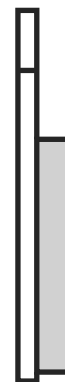
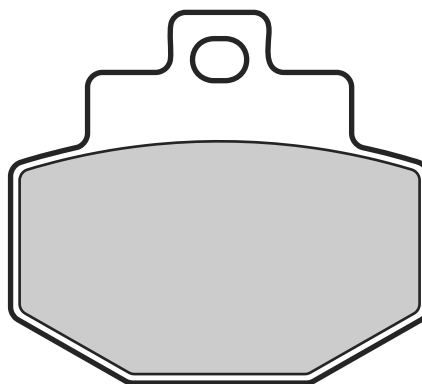

3



BENELLI

125	ADIVA	00 >	•
150	ADIVA	00 >	•

GILERA

125	RUNNER ST	08 > 11	•
125	RUNNER VX 4T (GRIMECA CALIPER)	01 >	•
125	RUNNER VX 4T (HENG TONG CALIPER)	01 >	•
200	RUNNER	03 >	•
200	RUNNER ST	08 >	•

PIAGGIO

125	946	14 >	•
125	SKIPPER LX	99 >	•
125	SUPERHEXAGON	01 >	•

125	SUPERHEXAGON (HENG TONG CALIPER)	04 >	•
125	VESPA 946 EMPORIO ARMANI	16 >	•
125	VESPA GRANTURISMO L	04 >	•
125	VESPA GTS	07 >	•
125	VESPA GTS SUPER	10 > 13	•
125	VESPA GTS SUPER	15 >	•
125	VESPA GTS SUPERSPORT	13 >	•
125	VESPA GTV	08 >	•
150	SUPERHEXAGON	01 >	•
180	SUPER HEXAGON GTX 12"	01 > 03	•
180	SUPERHEXAGON	01 >	•
180	SUPERHEXAGON (HENG TONG CALIPER)	00 >	•

200	VESPA GT L	04 >	•
250	SUPERHEXAGON	99 > 01	•
250	VESPA GT 60 EURO3	06 >	•
250	VESPA GTS ABS	06 >	•
250	VESPA GTV	08 >	•
300	VESPA GTS IE	12 >	•
300	VESPA GTS SUPER	09 >	•
300	VESPA GTS SUPER SPORT	11 >	•
300	VESPA GTS TOURING	11 > 12	•
300	VESPA GTV I.E.	11 >	•
300	VESPA SEI GIORNI	18 >	•
300	VESPA YACHT CLUB	18 >	•

YAMAHA

250	F	18 >	•
-----	---	------	---





07048.CC

49.9 x 47.1 x 7

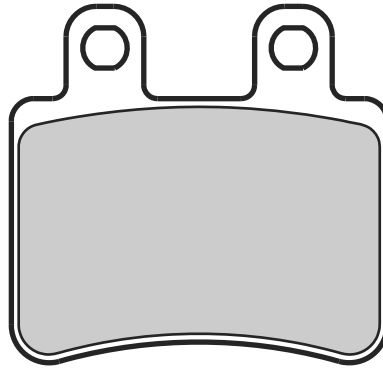

3



DERBI

125 BOULEVARD S	04 > 08	•
125 SENDA BAJA	06 >	•
150 BOULEVARD	04 >	•

ITALJET

100 MILLENIUM	01 >	•
125 MILLENIUM	01 >	•
150 MILLENIUM	01 >	•

PEUGEOT

50 ELYSTAR	03 >	•
------------	------	---

50 JET C-TECH	05 > 08	•
125 ELYSEO	98 > 99	•
125 ELYSTAR	03 >	•
125 ELYSTAR ABS	03 >	•
125 GEOPOLIS	06 >	•
125 GEOPOLIS RS	10 >	•
125 JET FORCE	03 >	•
125 JET FORCE COMPRESSOR	05 >	•
125 SATELIS	04 > 05	•
125 SATELIS	06 >	•
125 SATELIS ABS	04 >	•
150 ELYSEO	00 > 02	•
150 ELYSTAR	03 >	•

250 SATELIS	06 >	•
600 SATELIS ABS	04 >	•

SCORPA

250 T-RIDE	08 >	•
------------	------	---

SHERCO

125 SE 1.25 F	10 >	•
---------------	------	---

YAMAHA

50 DT R	04 > 11	•
50 DT X SUPERMOTARD	04 > 11	•



**07049.CC**

76.5 x 41.9 x 7.3

94.4 x 42.1 x 7.3

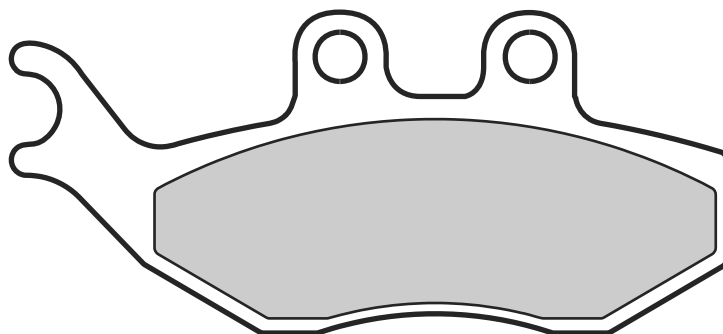
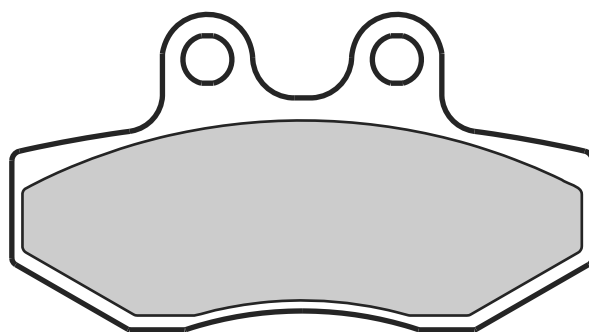

3

**APRILIA**

50 TUONO 04 > •

BETA

50 RR ENDURO 10 > •

50 RR SUPERMOTARD 08 > •

125 ALP 4-STROKE 06 > •

125 ALP 4-STROKE (EBE) 06 > •

125 ENDURO 10 > •

125 M4 06 > •

125 M4 (EBE) 06 > •

125 RR ENDURO 10 > •

125 RR SUPERMOTARD 08 > •

125 URBAN 10 > •

200 ALP 4-STROKE 06 > •

200 ALP 4-STROKE (EBE) 06 > •

200 URBAN 10 > •

350 ALP 4.0 04 > 05 •

350 ALP 4.0 06 > •

350 ALP 4.0 (EBE) 06 > •

DERBI

50 BLACK DEVIL 04 > •

50 DRD RACING R 05 > •

50 DRD RACING R LIMITED EDITION 05 > •

50 DRD RACING SM 05 > •

50 DRD RACING SM LIMITED EDITION 05 > •

50 SENDA SM DRD BLACK ED. 03 > •

125 MULHACEN 07 > 07 •

125 SENDA 4-STROKE 04 > •

125 SENDA BAJA 06 > •

125 SENDA R 4-STROKE 05 > •

125 SENDA X-TREME SM 04 > •

FANTIC MOTOR

50 MX REGOLARITÀ CASA 08 > •

50 SUPERSEI MOTARD 08 > •

125 CABALLERO MOTARD AIRCOOLED 10 > •

125 MX REGOLARITÀ CASA 08 > •

125 SUPERSEI MOTARD 08 > •

GAS GAS

50 EC ROOKIE 05 > •

125 PAMPERA 04 > •

250 PAMPERA 02 > •

280 PAMPERA 04 > •

HM

50 CRE 06 > •

KEEWAY

125 ENDURO 07 > •

125 X-RAY 07 > •

MALAGUTI

50 FIFTY 04 > •

50 NKD 04 > •

125 MADISON 3 08 > •

125 PHANTOM MAX 04 > •

200 PHANTOM MAX 04 > •

250 MADISON 3 08 > •

250 MADISON RS 05 > •

250 PASSWORD 06 > •

250 PHANTOM MAX 05 > •

MBK

50 X POWER 04 > •

PEUGEOT

50 XPS6 SUPERMOTARD 04 > 05 •

125 ELYSEO 00 > •

125 ELYSTAR 03 > •

125 ELYSTAR ABS 03 > •

125 JET FORCE 03 > •

125 JET FORCE COMPRESSOR 05 > •

125 SATELIS 06 > •

150 ELYSEO 00 > 02 •

150 ELYSTAR 03 > •

250 SATELIS 06 > •

SHERCO

50 ENDURO 07 > •

50 SUPERMOTARD 07 > •

125 SE 1.25 F 10 > •

YAMAHA

50 DT X SUPERMOTARD 04 > 11 •

50 TZR 90 > 92 •

50 TZR 93 > 02 •

50 TZR 03 > •





07050.CC

44.6 x 50.7 x 7

07050.XS

“ “ “

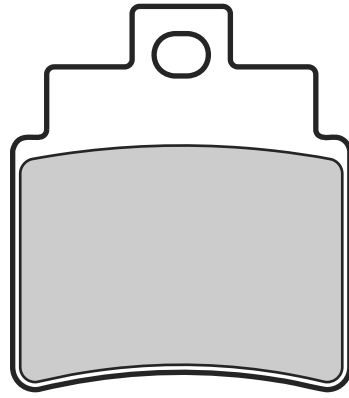

3



KYMCO

250 GRAND DINK 00 > •

SYM

125 VOYAGER 05 > •

250 JOYMAX 07 > •

250 RV EFI 10 > •

250 VOYAGER 05 > •



07051.CC

55.3 x 46 x 7

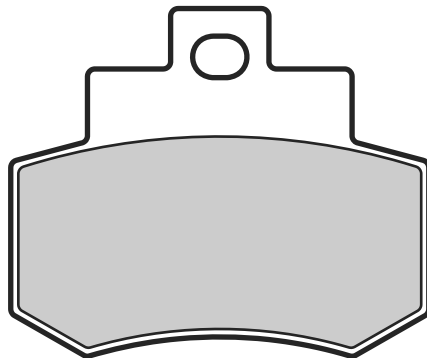

KYMCO

250 GRAND DINK 00 > •



07052.CC

99.6 x 38.2 x 12

07052.XS

“ “ “

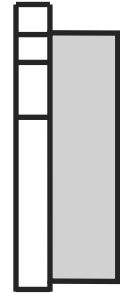
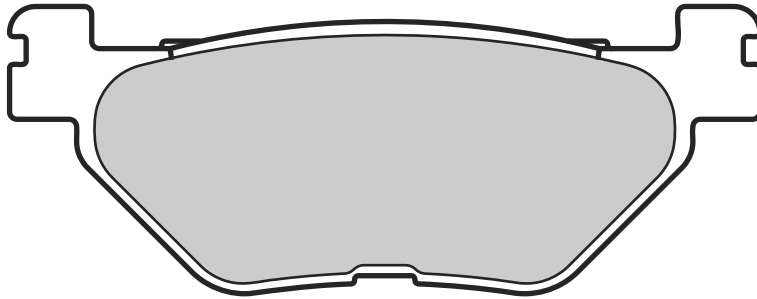

3



MBK

400 SKYLINER 04 > •

YAMAHA

500 T MAX 01 > 03 •
530 T MAX 12 > 16 •
530 T MAX DX 17 > •

530 T MAX IRON MAX 15 > 16 •
530 T MAX LUX MAX 16 > •
530 T MAX SX 17 > •



07053.CC

85.7 x 40 x 8.9

07053.XS

“ “ “

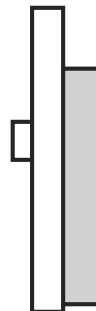
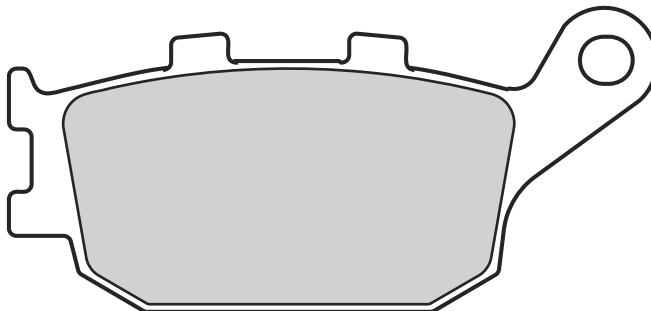
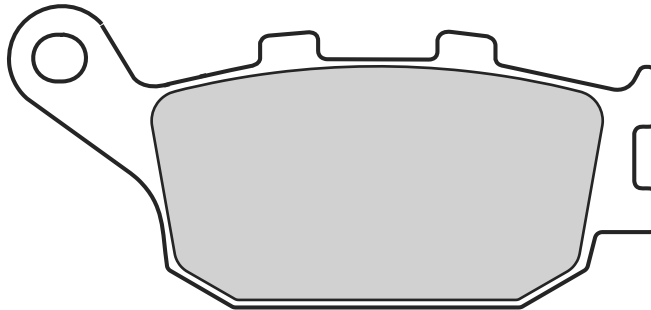

HONDA

250 FORESIGHT 97 > 99 •
250 FORZA 00 > 04 •
250 NSS JAZZ 00 > 04 •



07054.CC

76.7 x 41.9 x 7.3

94.4 x 42.1 x 7.3

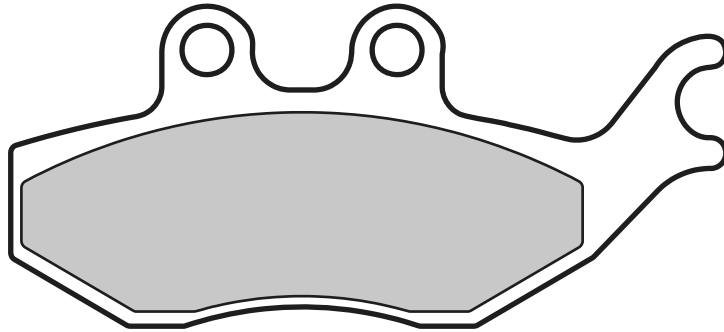
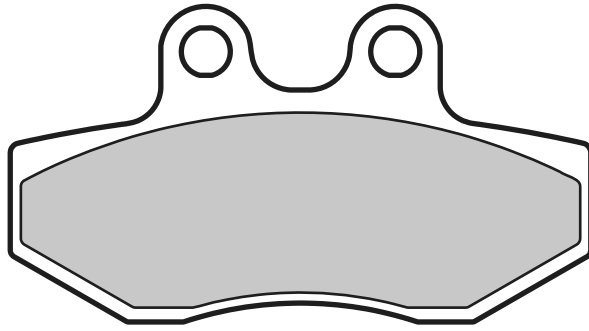

ITALJET

100	MILLENIU	01 >	•
125	MILLENIU	01 >	•
150	MILLENIU	01 >	•
250	JUPITER	00 >	•

KEEWAY

50	SMTX	10 >	•
125	SMTX	10 >	•

RIEJU

50	MATRIX	03 >	•
50	NKD	04 >	•



07055.CC

80.9 x 41.7 x 8.3

07055.XS

“ “ “

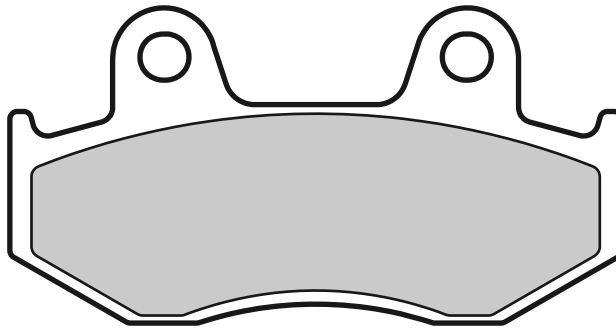

KAWASAKI

250	SC EPSILON	02 >	•
-----	------------	------	---

PIAGGIO

125	VESPA GTS SUPERSPORT	13 >	•
-----	-------------------------	------	---

SUZUKI

250	BURGMAN	04 > 06	•
400	BURGMAN	01 > 06	•





07056.CC

76.7 x 41.9 x 9

96.6 x 41.9 x 9

07056.XS

“ “ “

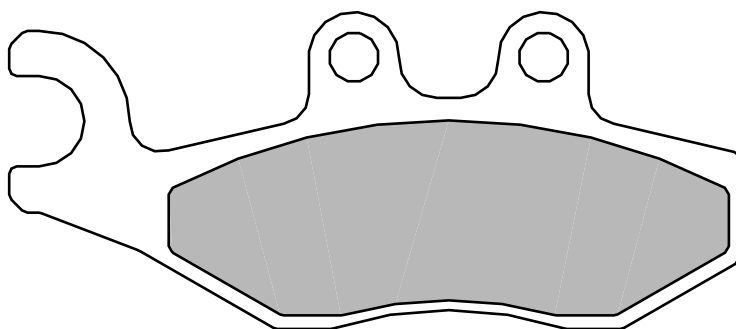
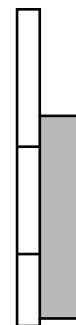
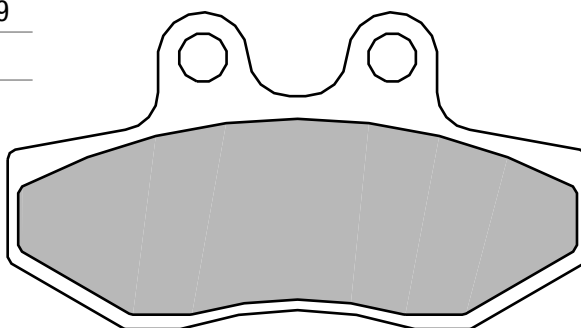

3



APRILIA

50	SPORTCITY ONE	09 > 12	•
125	MAX	12 >	• •
125	SPORTCITY ONE	12 >	•
125	SR MAX	12 > 14	• •
300	MAX	12 >	• •
850	SRV	12 > 16	•

GILERA

50	RUNNER PURE JET	06 >	•
50	RUNNER SP	06 >	•
125	NEXUS	09 >	• •
125	RUNNER FX (HENGTONG CALIPER)	00 >	•
125	RUNNER FX SP (HENGTONG CALIPER)	00 >	•
125	RUNNER ST	08 > 11	•
125	RUNNER ST	12 >	•
125	RUNNER VX 4T (HENGTONG CALIPER)	01 >	•
180	RUNNER FXR (HENGTONG CALIPER)	00 >	•
180	RUNNER FXR SP (HENGTONG CALIPER)	00 >	•
180	RUNNER VXR	01 >	•
180	RUNNER VXR 4T (HENGTONG CALIPER)	00 >	•
200	RUNNER ST	08 >	•

200	RUNNER VXR 4T (HENGTONG CALIPER)	01 >	•
250	NEXUS	06 > 08	• •
300	NEXUS	11 >	• •
500	FUOCO I.E.	08 >	•
800	GP 800	07 >	•

PEUGEOT

50	CITYSTAR	14 > 15	•
125	ACTIVE	13 >	•
125	CITYSTAR	11 >	•
125	GEOPOLIS	06 >	•
125	GEOPOLIS RS	10 >	•
200	CITYSTAR	13 >	•
400	GEOPOLIS	08 >	•

PIAGGIO

50	FLY	05 >	•
50	LIBERTY 4T	16 >	•
50	TPH 2T	11 >	•
50	VESPA PRIMAVERA	14 >	•
100	FLY	07 >	•
100	ZIP	07 >	•
125	946	14 >	•
125	BEVERLY	02 >	• •
125	BEVERLY EURO3	07 > 08	• •
125	CARNABY	07 >	• •
125	FLY 2T	05 >	•
125	FLY 4T	05 >	•
125	SPRINT S	16 >	•

125	SPRINT SPORT	17 >	•
125	SUPERHEXAGON (HENGTONG CALIPER)	04 >	•
125	VESPA 70 PRIMAVERA	16 >	•
125	VESPA 946 EMPORIO ARMANI	16 >	•
125	VESPA GRANTURISMO L	04 >	•
125	VESPA GTS	07 >	•
125	VESPA GTS SUPER	10 > 13	•
125	VESPA GTS SUPER	15 >	•
125	VESPA GTV	08 >	•
125	VESPA PRIMAVERA	14 >	•
125	X10 EXECUTIVE left/rear	13 >	•
125	X7	08 >	• •
125	X7 EURO3	08 > 09	• •
125	X8	04 > 04	•
125	X8	05 >	•
125	X9 left caliper	04 > 05	•
125	X9 left caliper	06 >	•
125	X9 PREMIUM EURO2	06 > 07	•
125	XEVO	08 >	•
150	FLY	05 > 07	•
150	FLY 2T	05 >	•
150	FLY 4T	05 >	•
150	FLY EURO3	08 > 10	•
150	VESPA 70 PRIMAVERA	16 >	•
150	VESPA PRIMAVERA	14 >	•
180	SUPERHEXAGON (HENGTONG CALIPER)	00 >	•
200	BEVERLY	01 >	• •
200	CARNABY	07 >	• •



200	VESPA GT L	04 >	•
200	X8	04 > 04	•
200	X8	05 >	•
250	BEVERLY	06 >	•
250	BEVERLY S	06 >	•
250	VESPA GT 60 EURO3	06 >	•
250	VESPA GTS ABS	06 >	•
250	VESPA GTV	08 >	•
250	X EVO	08 >	•
250	X7	08 >	•
250	X8 I.E.	06 >	•
250	X9 EVOLUTION left caliper	05 >	•
300	BEVERLY I.E.	11 >	•
300	CARNABY CRUISER	10 >	• •
300	VESPA GTS IE	12 >	•

300	VESPA GTS SUPER	09 >	•
300	VESPA GTS SUPER SPORT	11 >	•
300	VESPA GTS TOURING	11 > 12	•
300	VESPA GTS TOURING ABS	17 >	•
300	VESPA GTV I.E.	11 >	•
300	VESPA SEI GIORNI	18 >	•
300	VESPA YACHT CLUB	18 >	•
300	X7 EVO I.E.	11 >	•
350	BEVERLY S	14 >	•
350	BEVERLY SPORT TOURING IE ABS	12 >	•
350	X10 EXECUTIVE left/rear	13 >	•
400	BEVERLY I.E.	06 >	•

400	X EVO	08 >	• •
400	X8 ie right caliper	06 >	• •
500	MP3 LT TOURING BUSINESS ABS	14 >	•
500	MP3 LT TOURING SPORT ABS	14 >	•
500	X10 EXECUTIVE left/rear	13 >	•

TRIUMPH

1700	THUNDERBIRD COMMANDER	14 >	•
1700	THUNDERBIRD LT	14 >	•

YAMAHA

250	F	18 >	•
-----	---	------	---



07057.CC

78.9 x 46.9 x 7.3

07057.XS

“ “ “

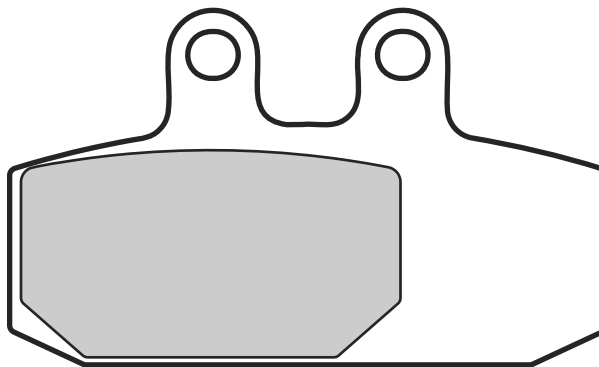
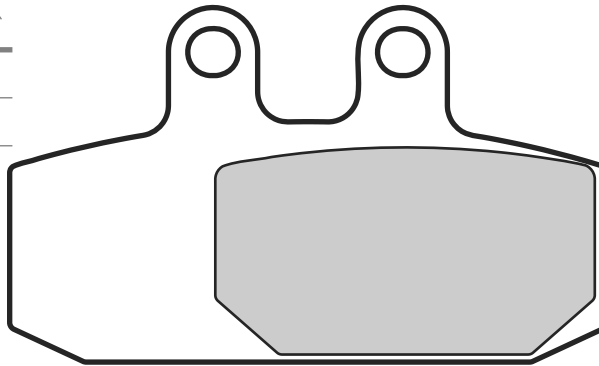

APRILIA

400	SCARABEO I.E.	06 >	•
500	ATLANTIC	02 > 05	•
500	SCARABEO GT ABS left caliper	06 >	•
500	SCARABEO ie left caliper	06 >	•
500	SCARABEO left caliper	04 > 05	•



07058.CC

88.2 x 46.1 x 8.4

07058.XS

“ “ “

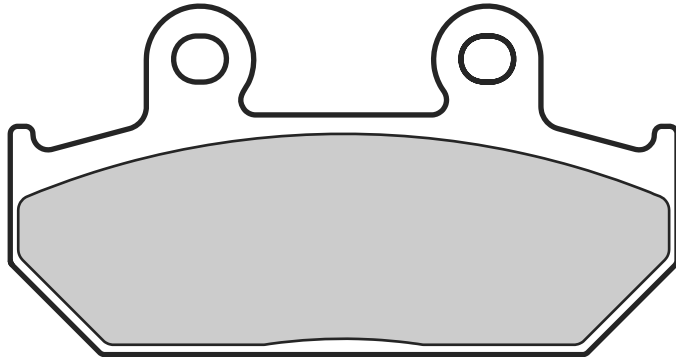

3



SUZUKI

400	BURGMAN	07 >	•
650	BURGMAN	02 >	•
650	BURGMAN EXECUTIVE	04 >	•



07059.CC

96.6 x 37.1 x 11.8

07059.XS

“ “ “

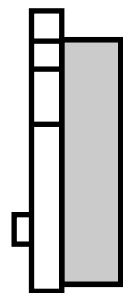
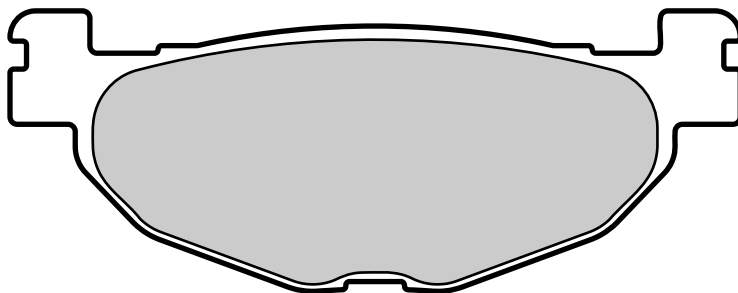

YAMAHA

400	MAJESTY	04 > 04	•
400	MAJESTY	05 > 06	•
500	T MAX	04 > 07	•
500	T MAX	08 > 11	•
500	T MAX ABS	06 > 07	•
500	T MAX BLACK MAX	06 > 07	•



07060.CC

76.7 x 41.9 x 9

96.6 x 41.9 x 9

07060.XS

“ “ “

3

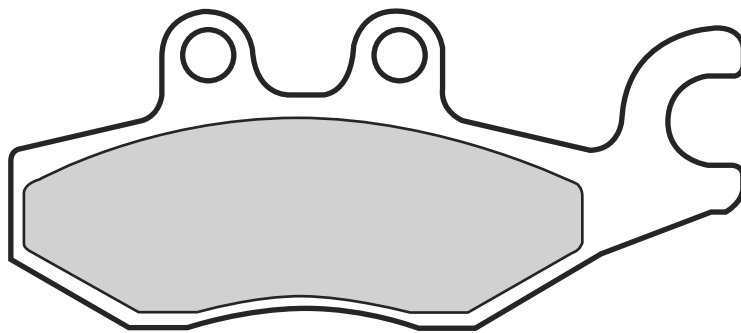
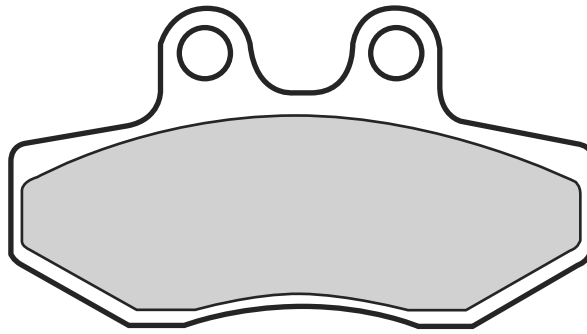

PIAGGIO

125	MEDLEY	16 >	•
125	MEDLEY S	17 >	•
125	MP3 HYBRID	10 >	•
125	X10 EXECUTIVE left/rear	13 >	•
125	X10 EXECUTIVE right	13 >	•
125	X9 PREMIUM EURO2	06 > 07	•
125	X9 right caliper	04 > 05	•
125	X9 right caliper	06 >	•
125	XEVO	08 >	•
150	MEDLEY	16 >	•

250	X EVO	08 >	•
250	X7	08 >	•
250	X9 EVOLUTION right caliper	05 >	•
300	BEVERLY I.E.	11 >	•
300	MP3 LT I.E.	10 >	•
300	MP3 LT ie ABS	14 >	•
300	MP3 LT SPORT ABS	14 >	•
300	MP3 YOURBAN	15 >	•
300	X7 EVO I.E.	11 >	•
350	BEVERLY S	14 >	•

350	BEVERLY SPORT TOURING IE	12 >	•
350	BEVERLY SPORT TOURING IE ABS	12 >	•
350	MP3	14 >	•
350	X10 EXECUTIVE left/rear	13 >	•
350	X10 EXECUTIVE right	13 >	•
400	X EVO	08 >	•
400	X8 ie left caliper	06 >	•
500	MP3 SPORT	10 >	•
500	X10 EXECUTIVE left/rear	13 >	•
500	X10 EXECUTIVE right	13 >	•

**07061.CC**

55.1 x 54.1 x 7.7

07061.XS

" " "

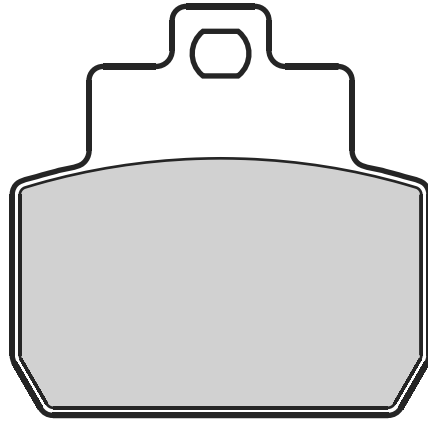
**PIAGGIO**

125 MP3	06 > 08	•
125 MP3	09 >	•
125 MP3 IE	08 > 08	•
125 MP3 IE	09 > 09	•
125 X8	05 >	•

125 X9 left caliper	06 >	•
125 X9 PREMIUM EURO2	06 > 07	•
200 X8	05 >	•
250 BEVERLY	06 >	•
250 BEVERLY S	06 >	•
250 MP3	06 >	•

250 X8 I.E.	06 >	•
250 X9 EVOLUTION right caliper	05 >	•
400 MP3	07 >	•
400 MP3 LT	09 >	•
500 BEVERLY	05 >	•

**07062.CC**

70.2 x 42 x 8.1

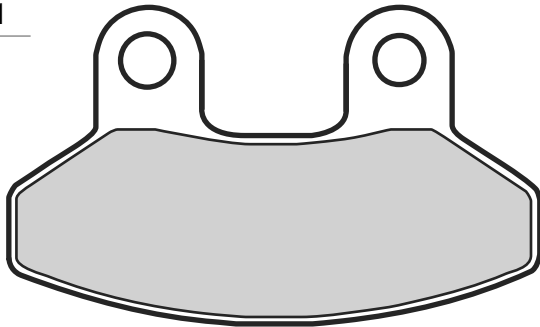
**LAVERDA**

125 PHOENIX	01 >	•
150 PHOENIX	01 >	•
200 PHOENIX	01 >	•

RIEJU

125 RS2 PRO	08 >	•
-------------	------	---

SYM

50 RS	05 >	•
50 RS 21	02 >	•
50 SUPER FANCY	98 >	•
125 EURO MX	03 >	•
125 JOYRIDE	01 >	•
125 JOYRIDE EVO	10 >	•
125 JOYRIDE S	16 >	•

125 RS	05 >	•
125 RS 21, R	02 >	•
125 VS	06 >	•
150 EURO MX	03 >	•
150 JOYRIDE	01 >	•
150 RS	05 >	•
150 VS	06 >	•
200 JOYRIDE	01 >	•
200 JOYRIDE S	16 >	•



07063.CC 117.6 x 44.9 x 8.8

07063.XS “ “ “

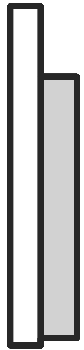
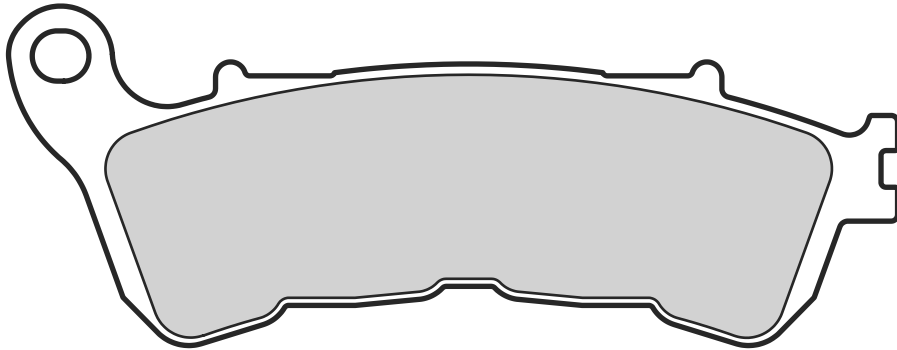

3

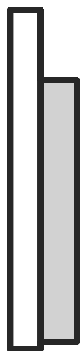
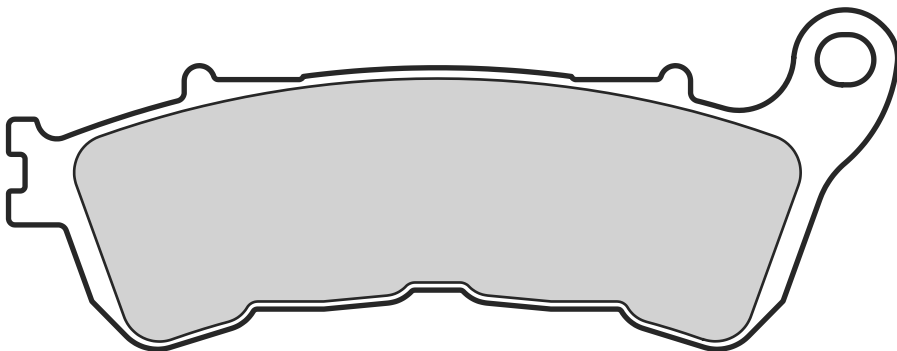

HONDA

125 SH MODE	09 > 12	•
125 SILVERWING	08 >	•
150 SH	09 >	•
150 SILVERWING	08 >	•
250 FORZA	05 > 07	•
250 NSS JAZZ	05 >	•

300 FORZA ABS	14 >	•
300 SH I	07 >	•
400 SILVER WING	09 >	•
600 SW-T	11 >	•

KYMCO

50 VITALITY	04 >	•
-------------	------	---

SUZUKI

125 BURGMAN	07 >	•
125 SIXTEEN	08 >	•
150 SIXTEEN	08 >	•
200 BURGMAN	07 >	•



07064.CC

81.3 x 37.2 x 9

07064.XS

“ “ “

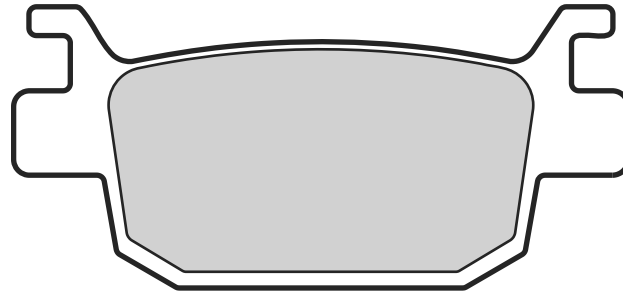

3



HONDA

125 FORZA	15 >	•	150 SH	09 >	•	300 FORZA ABS	14 >	•
125 SH MODE	09 > 12	•	150 SH ABS	14 >	•	300 SH 30 ANNI	15 >	•
125 SH MODE	13 >	•	150 SILVER WING	08 >	•	300 SH I	07 >	•
			250 FORZA	05 > 07	•	300 SH I ABS	16 >	•
			250 NSS JAZZ	05 >	•			



07065.CC

93.7 x 39.8 x 7.4

07065.XS

“ “ “

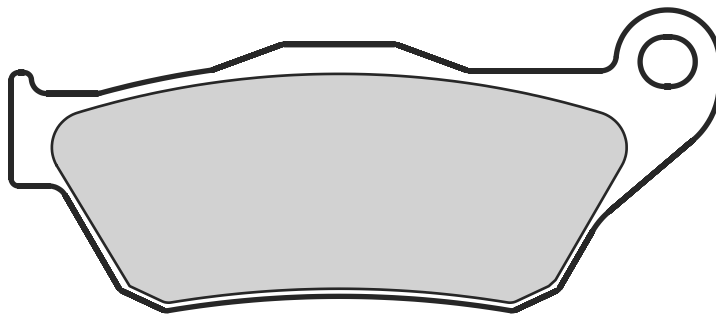
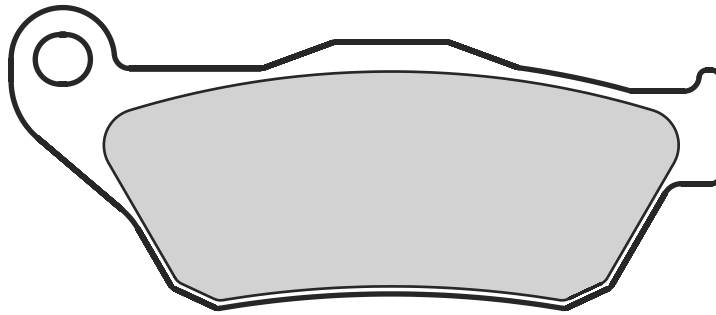

3



MBK

125 SKYCRUISER 06 > •

YAMAHA

125 X CITY 08 > 15 •

125 X MAX 06 > 09 •

250 X MAX 06 > 09 •



07066.CC

45.2 x 52.5 x 6.3

07066.18

GENUINE

“ “ “

07066.23

GENUINE

“ “ “

07066.XS

“ “ “

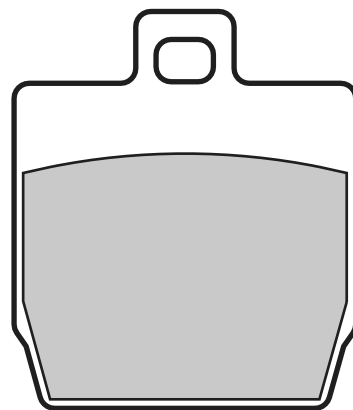

MBK

50 NITRO 97 > •

50 STUNT 00 > •

100 NITRO 00 > •

YAMAHA

50 AEROX 97 > 12 •

50 AEROX 13 > •

50 AEROX REPLICA 97 > 06 •

50 AEROX ROSSI 04 > 06 •

50 SLIDER 00 > •



07067.CC

35.3 x 48.8 x 6.2

07067.XS

“ “ “

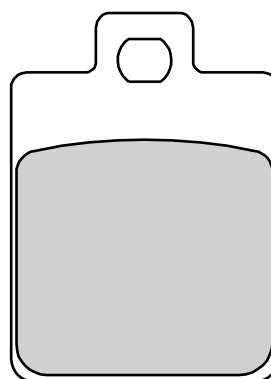

3



GILERA

50	DT STALKER	97 >	•
50	RUNNER PURE JET	98 > 05	•
50	RUNNER PURE JET	06 >	•
50	RUNNER SP	98 > 05	•
50	RUNNER SP	06 >	•
50	STALKER	97 >	•
125	RUNNER FX (GRIMECA CALIPER)	00 >	•
125	RUNNER FX (HENGTONG CALIPER)	00 >	•
125	RUNNER FX SP (GRIMECA CALIPER)	00 >	•
125	RUNNER FX SP (HENGTONG CALIPER)	00 >	•
125	RUNNER ST	12 >	•
180	RUNNER FXR (GRIMECA CALIPER)	00 >	•
180	RUNNER FXR (HENGTONG CALIPER)	00 >	•
180	RUNNER FXR SP (GRIMECA CALIPER)	00 >	•
180	RUNNER FXR SP (HENGTONG CALIPER)	00 >	•
200	RUNNER FX SP	98 >	•
200	STALKER	97 >	•
500	FUOCO I.E.	08 >	•

PEUGEOT

50	TWEET	10 > 12	•
50	TWEET PARIS	16 >	•
50	TWEET RS	10 > 12	•
125	TWEET PARIS	16 >	•
125	TWEET RS	10 > 12	•
150	TWEET PARIS	16 >	•
150	TWEET RS	10 > 12	•

PIAGGIO

50	LIBERTY	97 >	•
50	LIBERTY 4T	00 > 15	•
50	VESPA ET2	97 >	•
50	VESPA ET4	00 >	•
50	VESPA LX 2T	05 >	•
50	VESPA LX 4T-4V	05 >	•
50	VESPA S 4T-4V	09 >	•
50	ZIP DISCO	96 >	•
50	ZIP FAST RIDER	96 >	•
50	ZIP SPORT H2O SP	96 >	•
50	ZIP SPORT RST	98 > 99	•
125	LIBERTY	99 > 17	•
125	LIBERTY 4T	06 > 07	•
125	LIBERTY 4T EURO3	07 > 08	•
125	MP3	06 > 08	•
125	MP3 IE	08 > 08	•
125	SFERA	95 >	•

125	SKIPPER 4T	07 >	•
125	VESPA 70 PX	16 >	•
125	VESPA ET4	96 >	•
125	VESPA LX 4T	05 >	•
125	VESPA PX	02 > 07	•
125	VESPA PX 30 ANNI	07 > 07	•
125	ZIP 4T	00 >	•
150	LIBERTY	99 >	•
150	VESPA 70 PX	16 >	•
150	VESPA ET4	02 >	•
150	VESPA PX	02 > 07	•
200	LIBERTY	06 >	•
200	LIBERTY S	06 >	•
200	VESPA PX	02 > 07	•
250	MP3	06 >	•
250	VESPA LX 60	06 >	•
300	MP3 YOURBAN	15 >	•
400	MP3	07 >	•
400	MP3 LT	09 >	•

SYM

125	JET 14	17 >	•
183	N TRAZER	18 >	•
200	SYMPHONY ST	18 >	•
300	CRUISYM	17 >	•
600	MAXSYM SPORT	18 >	•



07068.CC

76.7 x 41.9 x 9.5

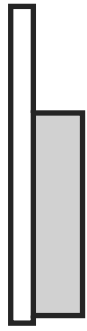
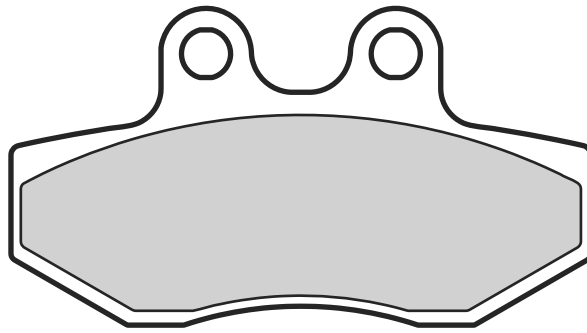

3



MBK

125 FLAME X 05 > •

YAMAHA

125 CYGNUS X 05 > 09 •



07069.CC

93.6 x 35.8 x 10.1

07069.XS

“ “ “

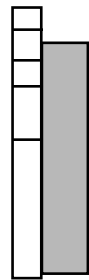
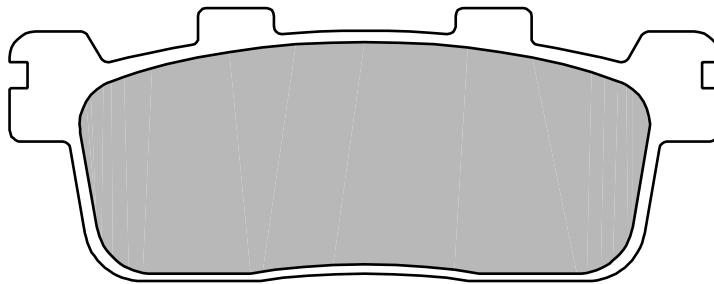

DAELIM

250 ST SECTOR QUAD 05 > 06 •

E-TON

150 RXL VIPER 07 > •

250 ST VECTOR 06 > •

250 VXL VECTOR 06 > •

300 ST VORTEX 07 > •

300 VTX VORTEX 07 > •

300 VXL VECTOR, ST VECTOR 07 > •

KYMCO

125 G-DINK 12 > •

125 KXCTI 14 > •

125 PEOPLE GTI 10 > 11 •

125 PEOPLE S 06 > •

200 PEOPLE S 05 > •

250 PEOPLE S left caliper 06 > •

250 XCITING 05 > •

300 G-DINK 12 > •

300 K-XCTI 12 > •

300 PEOPLE GTI 10 > 11 •

300 PEOPLE S 08 > 10 •

300 PEOPLE SI left caliper 08 > •

300 XCITING R 08 > 11 •

300 XCITING RI 08 > •

SYM

125 SB WOLF 11 > •

250 QUADLANDER 06 > •

300 CITY MAX 06 > •

YAMAHA

400 X MAX 15 > 16 •

400 X MAX ABS 15 > 16 •

400 X MAX IRON MAX 16 > •



07070.CC

62 x 40.7 x 9.5
82.2 x 40.7 x 9.5

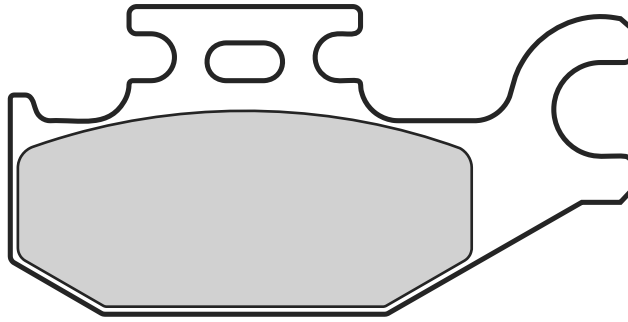
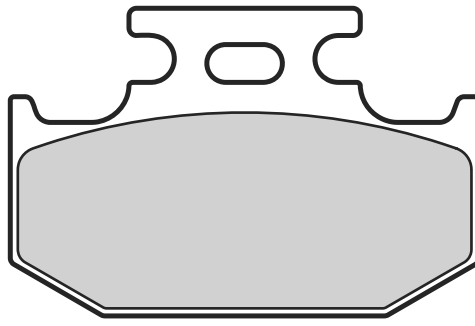

3



SUZUKI

125	BURGMAN	07 >	•
125	SIXTEEN	08 >	•
150	SIXTEEN	08 >	•
200	BURGMAN	07 >	•
200	BURGMAN ABS	14 >	•



07071.CC

76.9 x 41.9 x 8

96.6 x 41.9 x 8

07071.XS

“ “ “

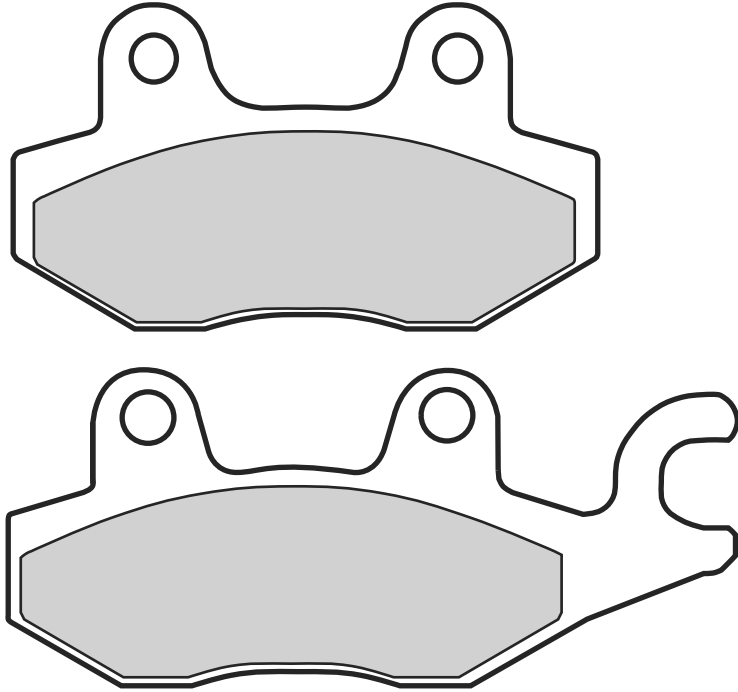

3



SUZUKI

200 BURGMAN ABS 14 > •

400 BURGMAN (right caliper) 07 > •



07072.CC

115 x 40.1 x 8.3

07072.XS

“ “ “

3

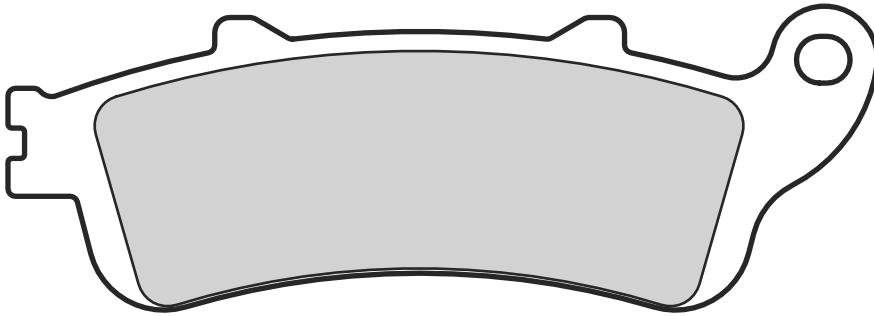
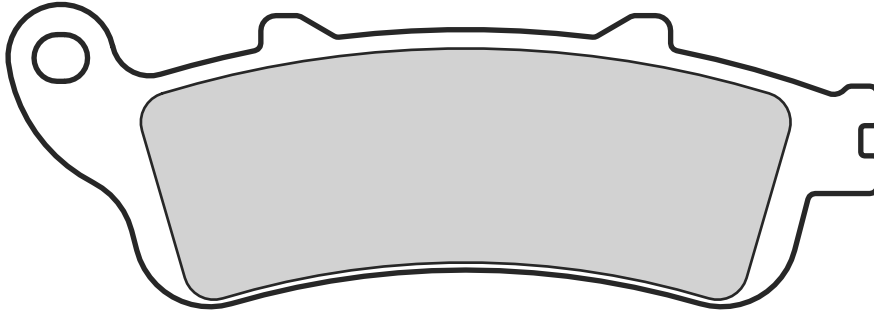

HONDA

400	SILVER WING	06 > 08	•
600	SILVER WING	00 >	•
600	SILVER WING ABS	03 >	•

PEUGEOT

50	CITYSTAR	14 > 15	•
----	----------	---------	---



07073.CC

102 x 40.4 x 10

07073.XS

“ “ “

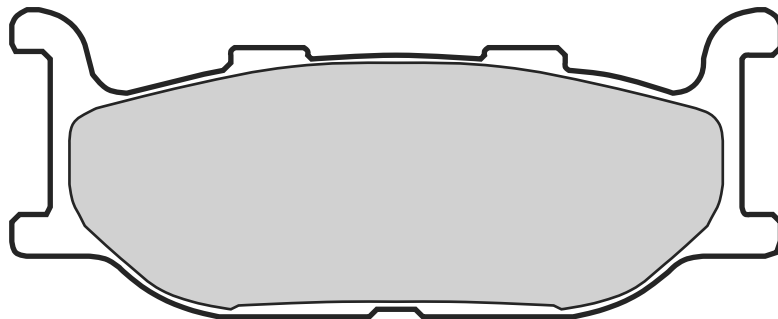

YAMAHA

400	MAJESTY	04 > 04	•
500	T MAX	01 > 03	•



07074.CC 102.1 x 38.9 x 8.1

07074.XS “ “ “

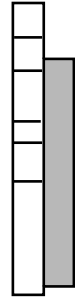
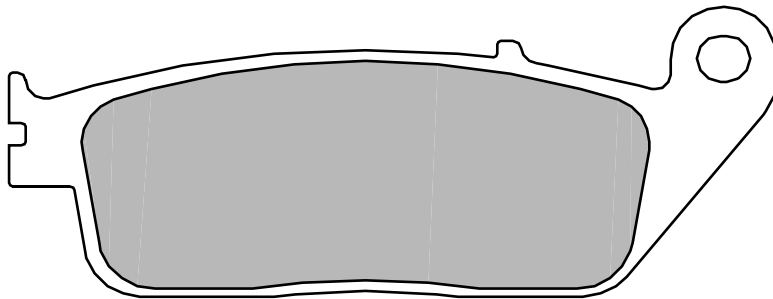
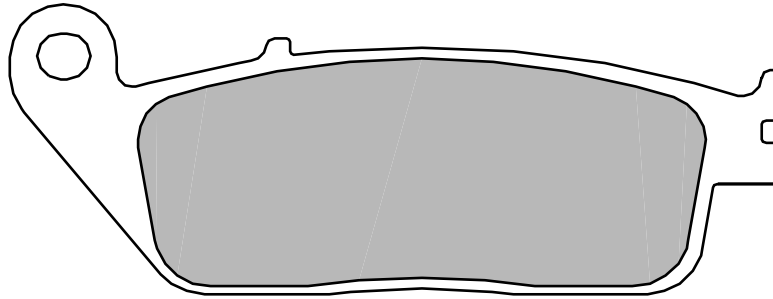

3



BMW

600 C 600 SPORT	11 > 15	• •
650 C 650 GT	12 >	• •
650 C 650 SPORT	15 >	• •

HONDA

125 FORZA	15 >	•
250 CN HELIX	93 >	•
300 SH 30 ANNI	15 >	•
300 SH I ABS	16 >	•

HYOSUNG

125 V2	99 >	•
--------	------	---

KAWASAKI

125 J125	16 >	•
300 J	14 >	•

KYMCO

125 DOWNTOWN	10 >	•
125 G-DINK	12 >	•
200 DOWNTOWN	10 >	•
250 XCITING	05 >	•
300 DOWNTOWN I	10 > 16	•
300 DOWNTOWN I ABS	10 > 12	•
300 G-DINK	12 >	•
300 PEOPLE GTI	10 > 11	•
300 XCITING R	08 > 11	•
300 XCITING RI	08 >	•

PEUGEOT

50 DJANGO HERITAGE	14 > 14	•
125 DJANGO HERITAGE	14 > 16	•
125 SATELIS ABS	04 >	•
150 DJANGO HERITAGE	14 > 16	•
250 SATELIS RS	11 >	•
300 GEOPOLIS GT	14 >	•

GEOPOLIS PREMIUM

300 (nissin caliper)	10 >	•
400 GEOPOLIS	08 >	•
400 GEOPOLIS GT	14 >	•
400 GEOPOLIS RS	08 >	•
400 SATELIS	07 >	•
400 SATELIS RS	07 >	•
500 GEOPOLIS	08 >	•
500 GEOPOLIS RS	08 >	•
500 SATELIS	06 >	• •
500 SATELIS RS	07 >	•
600 SATELIS ABS	04 >	•

SUZUKI

650 BURGMAN	02 >	•
650 BURGMAN EXECUTIVE	04 >	•

YAMAHA

300 XC VERSITY	05 >	•
----------------	------	---





07075.XS

102.1 x 38.9 x 8.9

3

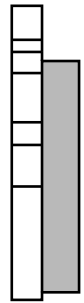
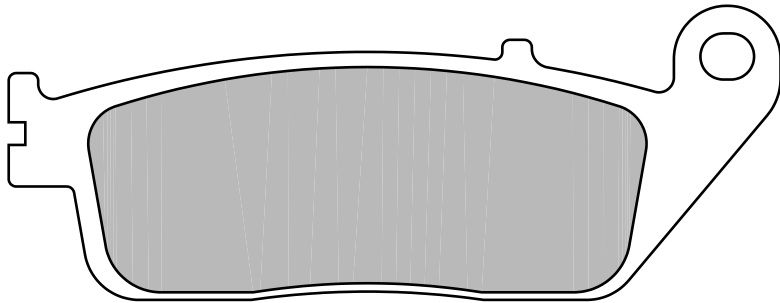
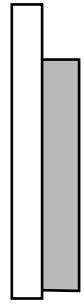
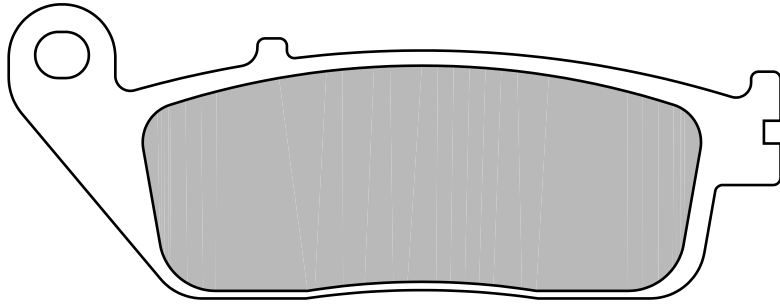

HONDA

400	SILVER WING	06 > 08	•
400	SILVER WING	09 >	•
600	SILVER WING	00 >	•
600	SILVER WING ABS	03 >	•
600	SW-T	11 >	•

KYMCO

500	XCITING	05 > 08	•
500	XCITING AF1 ABS	06 >	• •
500	XCITING I EVO ABS	11 >	•
500	XCITING R ABS	09 >	•
700	MY ROAD	09 >	•
700	XCITING R	09 >	• •



07076.CC

76.9 x 41.9 x 8

96.6 x 41.9 x 8

07076.XS

“ “ “

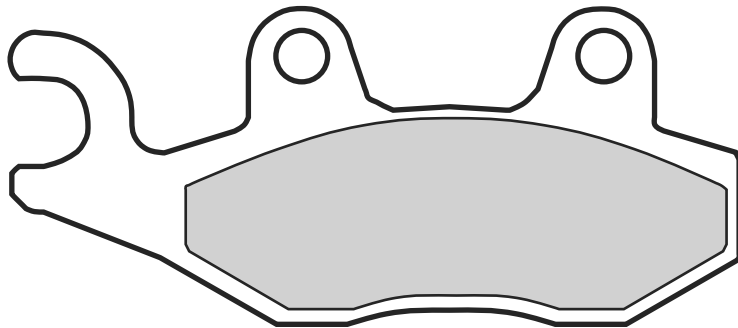
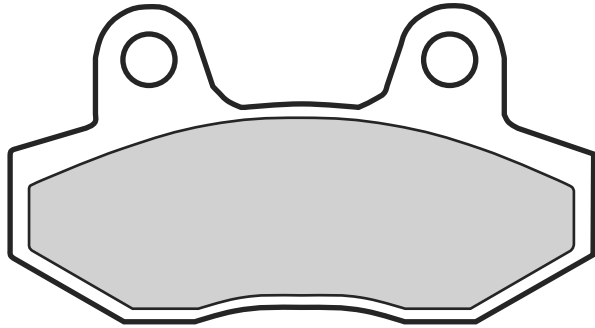

3



APRILIA

50 SX 14 > •

BENELLI

125 MACIS 10 > 15 • •

150 MACIS 10 > 15 • •

GARELLI

200 XO 12 > •

PEUGEOT

50 DJANGO HERITAGE 14 > 16 •

125 DJANGO HERITAGE 14 > 16 •

125 GEO RS 08 > • •

125 SATELIS SPORT 11 > • •

125 VIVACITY 10 > •

150 DJANGO HERITAGE 14 > 15 •

250 GEO RS 08 > • •

300 GEOPOLIS GT 14 > •

300 GEOPOLIS PREMIUM (nissin caliper) 10 > •

300 GEOPOLIS RS 13 > • •

300 GEOPOLIS RS (NISSIN CAL.) 10 > • •

300 GEOSTYLE 10 > • •

300 SATELIS 13 > • •

400 GEOPOLIS GT 14 > •

400 GEOPOLIS RS 08 > •

400 SATELIS 07 > •

400 SATELIS RS 07 > • •

500 GEOPOLIS 08 > •

500 GEOPOLIS RS 08 > •

500 SATELIS RS 07 > •

SUZUKI

400 BURGMAN (left caliper) 07 > •





07077.CC 69.2 x 51.3 x 8.8
07077.XS “ “ “

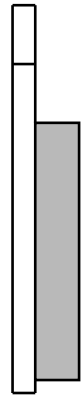
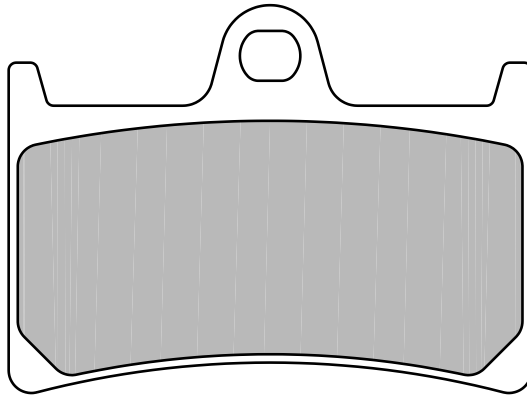

YAMAHA

500 T MAX	08 > 11	•
530 T MAX	12 > 16	•
530 T MAX DX	17 >	•
530 T MAX IRON MAX	15 > 16	•
530 T MAX LUX MAX	16 >	•
530 T MAX SX	17 >	•



07078.CC 80.9 x 41.7 x 7.3
07078.XS “ “ “

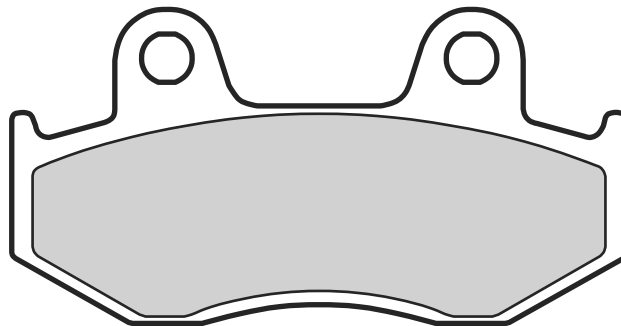

HONDA

110 NHX	10 >	•
125 CH SPACY	94 >	•
150 SH	01 > 08	•
250 CH SPACY	85 >	•

**07080.CC**

76.9 x 41.9 x 7.5

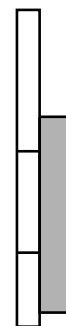
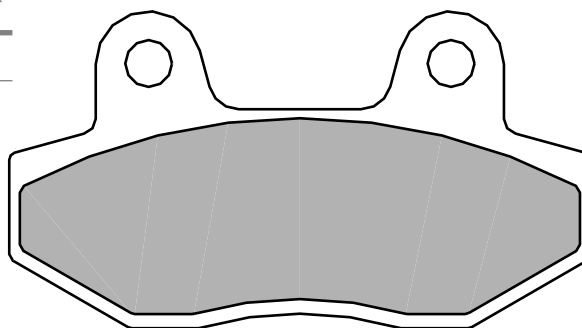
**3****GARELLI**

X0 ELETTRIC	12 >	•
125 FLEXI	12 >	•
125 X0	12 >	•
150 X0	12 >	•

KEEWAY

50 RY 8	10 >	•
---------	------	---

KYMCO

50 NEXXON	08 >	• •
125 NEXXON	08 >	• •
150 STRAIGHT	08 >	• •

PEUGEOT

50 SPEEDFIGHT 3	10 >	•
SPEEDFIGHT 3 LC, LC RS	10 >	•
50 SPEEDFIGHT TOTAL SPORT	16 >	•

**07081.35**
GENUINE

39.8 x 56.2 x 6.8

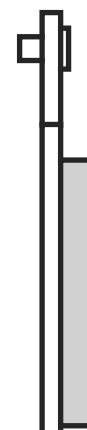
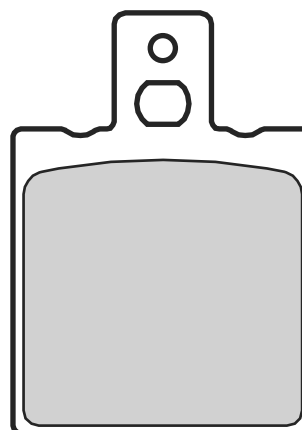
**BETA**

50 CHRONO 502	97 >	•
50 QUADRA	97 >	•

50 NUVOLA	00 > 02	•
125 CUCCILO	00 >	•
125 NUVOLA	00 > 02	•

PGO

50 G-MAX DOPPLER	06 >	•
------------------	------	---

CAGIVA

50 COCIS	88 > 88	•
50 CUCCILO	97 > 99	•

DERBI

50 EASY	96 >	•
---------	------	---

SIMSON

50 STAR	99 >	•
---------	------	---





07082.25
GENUINE

77.9 x 41.2 x 9

07082.30
GENUINE

“ “ “

07082.35
GENUINE

“ “ “

3

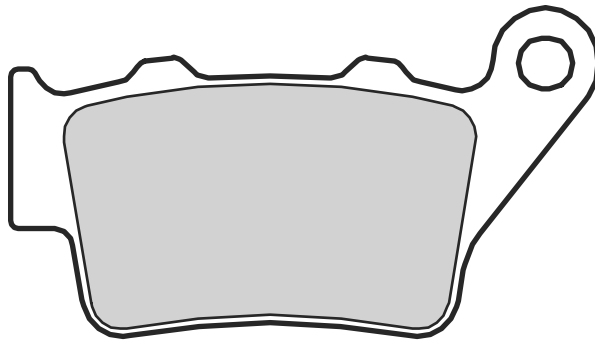
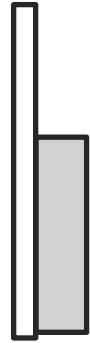
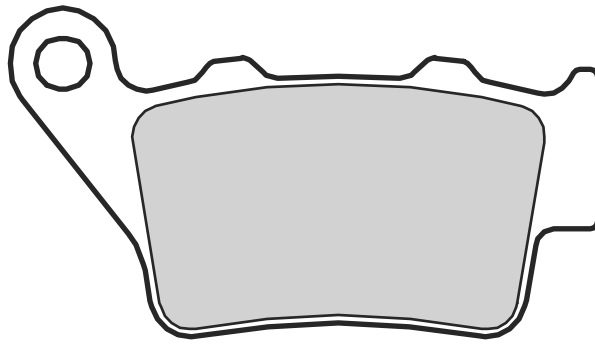

BMW

125 C 1	99 > 02	•
125 C 1 EXECUTIVE	00 >	•
125 C 1 FRIENDS	01 >	•
200 C 1	01 >	•
200 C 1 EXECUTIVE	01 >	•
200 C 1 FRIENDS	01 >	•



07083.35
GENUINE

108.5 x 40.1 x 7.6

07083.59
GENUINE

“ “ “

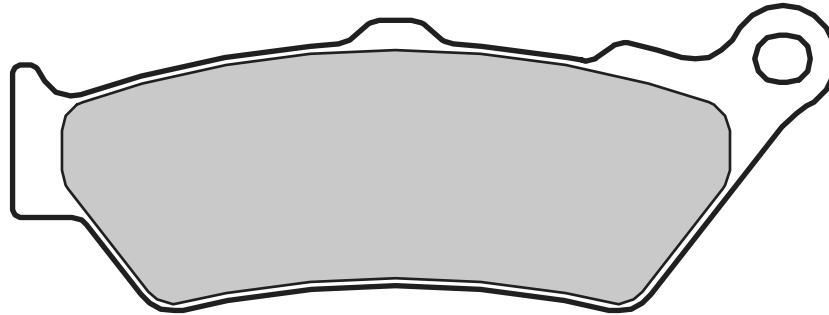
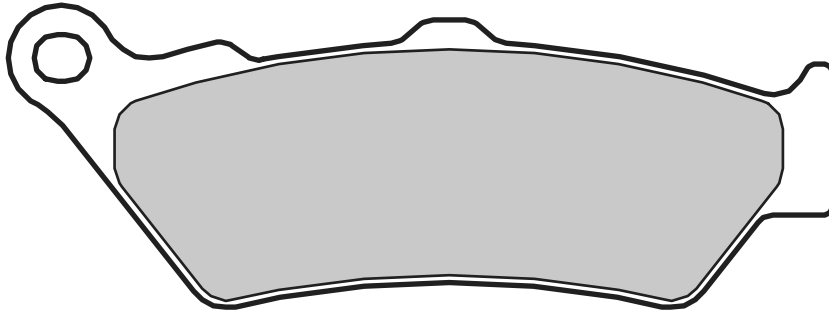

3



BMW

125 C 1	99 > 02	•
125 C 1 EXECUTIVE	00 >	•
125 C 1 FRIENDS	01 >	•
200 C 1	01 >	•
200 C 1 EXECUTIVE	01 >	•
200 C 1 FRIENDS	01 >	•



07084.24
GENUINE

35.8 x 51.6 x 5.9

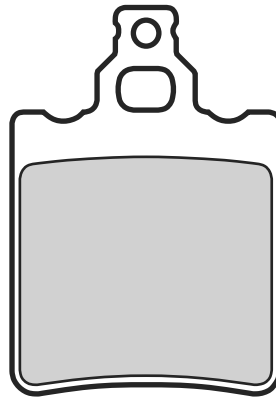

APRILIA

125 LEONARDO 96 > 96 •

CAGIVA

50 COCIS 88 > 88 •

KYMCO

125 FREEWAY 93 > 95 •



07085.CC

90 x 33.3 x 9.8

07085.XS

“ “ “

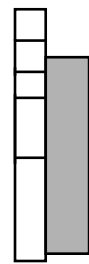
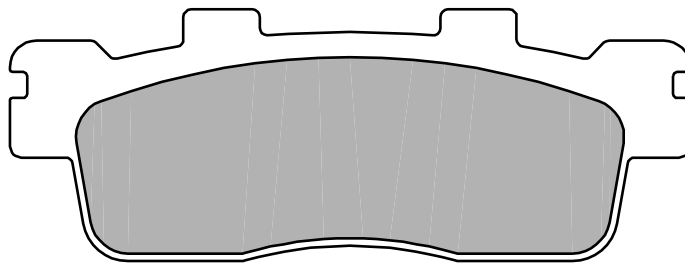

KAWASAKI

125 J125 16 > •
300 J 14 > •

KYMCO

125 DOWNTOWN 10 > •
125 DOWNTOWN I ABS 16 > •
125 PEOPLE GTI 12 > •
125 SUPER DINK 10 > • •
125 XTOWN I ABS 16 > •

200 DOWNTOWN 10 > •
200 PEOPLE GTI 12 > •
300 DOWNTOWN I 10 > 16 •
300 DOWNTOWN I ABS 10 > 12 •
300 PEOPLE GTI 12 > •
300 XTOWN I ABS 16 > •



07086.CC

39.7 x 54 x 6.6

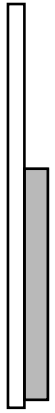
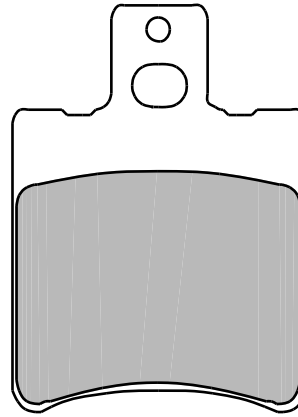

3



APRILIA

50	SR EUROPA	93 >	•
50	SR URBAN KID	93 >	•

50	FIZZ	93 >	•
50	FORTE	94 >	•
50	OVETTO	97 >	•
80	EVOLIS	94 >	•

SUZUKI

50	AP	95 > 97	•
50	KATANA -AY	96 >	•

ATALA

50	BYTE	97 > 00	•
50	BYTE AT 10	97 >	•
50	SKEGGIA	98 >	•

PGO

50	RODO SHOW	01 >	•
90	RODO SHOW	02 >	•

YAMAHA

50	AEROX	13 >	•
50	BREEZE	94 > 97	•
50	JOG-Z	90 >	•
50	YE ZEST	92 >	•
50	YH	98 >	•
80	YE ZEST	93 >	•

MBK

50	BOOSTER N.G.	97 >	•
50	EQUALIS	96 >	•
50	EVOLIS	92 >	•

PIAGGIO

50	ZIP & ZIP	94 >	•
----	-----------	------	---

SHE-LUNG

50	RACER	96 >	•
----	-------	------	---



07087.CC

39.6 x 56.2 x 7.7

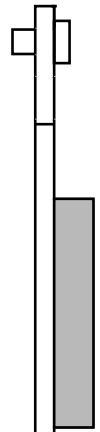
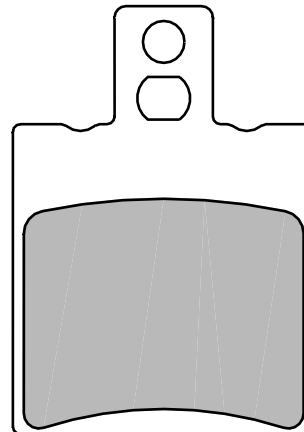

APRILIA

50	SR NETSCAPER	97 >	•
50	SR WWW	97 >	•
125	LEONARDO	97 > 98	•
150	LEONARDO	97 > 98	•





07088.CC

39.9 x 56.2 x 7

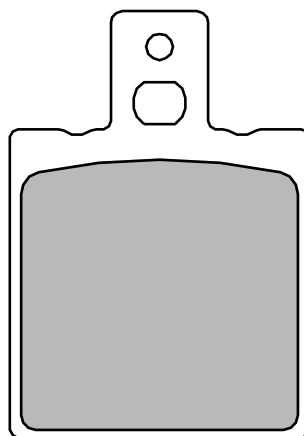

3



BENELLI

125	VELVET	99 > 04	•
125	VELVET TOURING	01 > 03	•
150	VELVET	00 > 04	•
150	VELVET TOURING	01 > 03	•
250	VELVET	99 > 01	•
250	VELVET TOURING	01 > 03	•



07089.CC

76.7 x 41.9 x 7.3

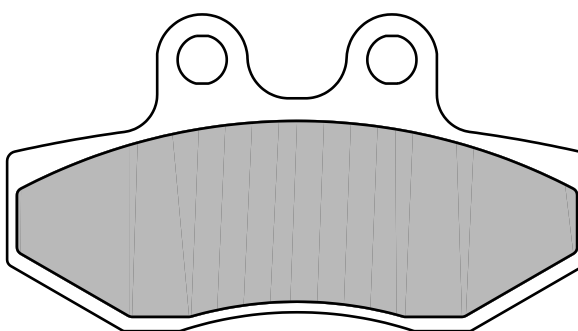

APRILIA

50	RX	06 >	•
50	SX	06 > 13	•



07090.CC

109.1 x 41.1 x 8

111.1 x 44.3 x 8

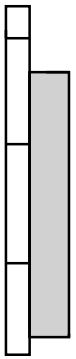
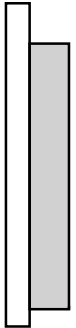
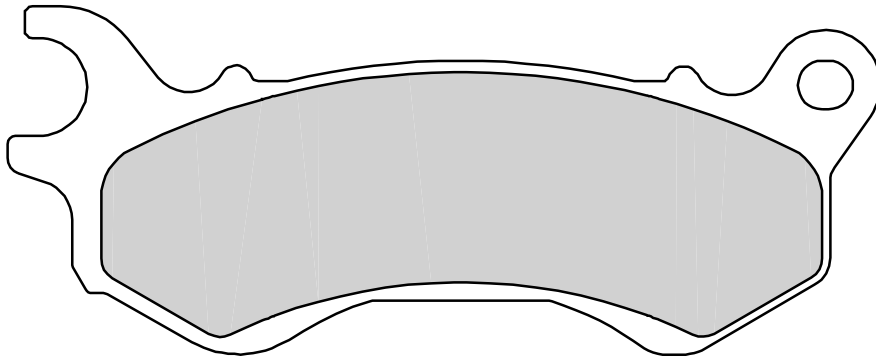
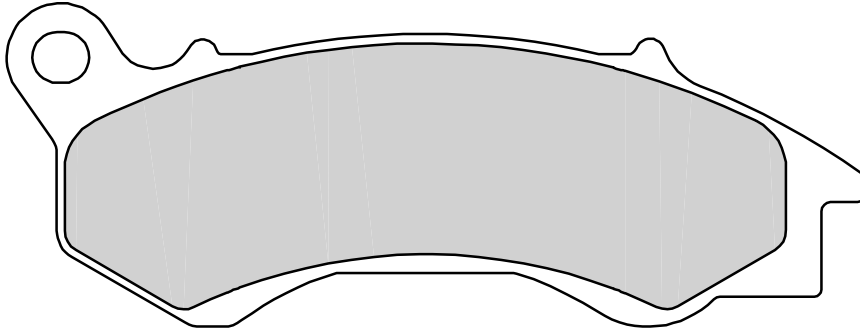

3



HONDA

50	NSC	10 >	•
110	LEAD	10 > 11	•
110	NSC	10 >	•
125	PCX	09 >	•

PEUGEOT

125	SATELIS BLACK EDITION	17 >	•
-----	-----------------------	------	---



07091.CC

76.5 x 40.1 x 9
98.9 x 40.5 x 8.1

3

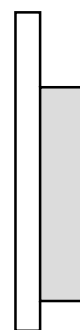
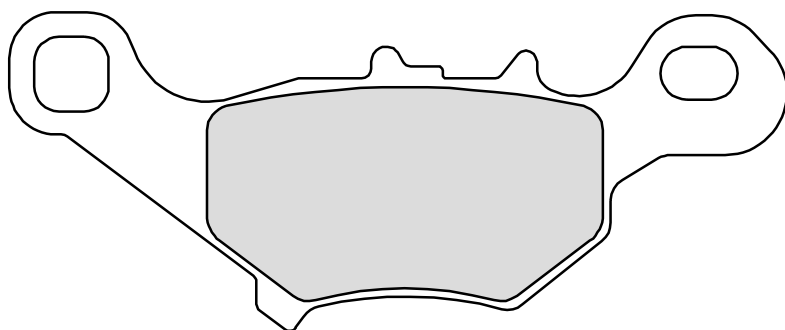
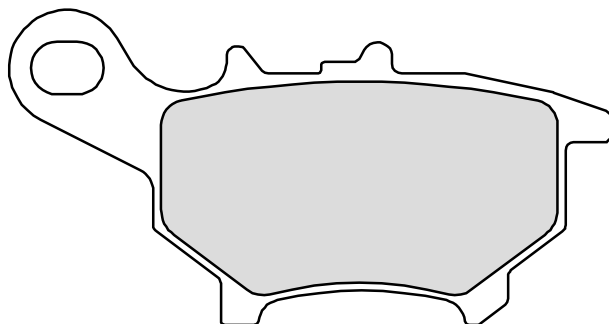

YAMAHA

50 CV A/R JOG

03 > 08 •



07092.CC

90 x 39 x 10.3

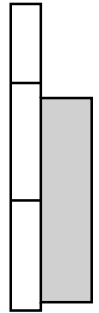
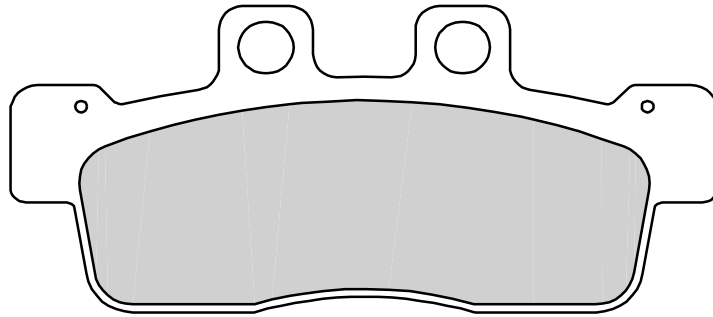

3



YAMAHA

125 CYGNUS	11 >	•
125 CYGNUS NXC	10 >	•



07093.CC

108.9 x 50.6 x 9.8

113 x 41.4 x 9

3

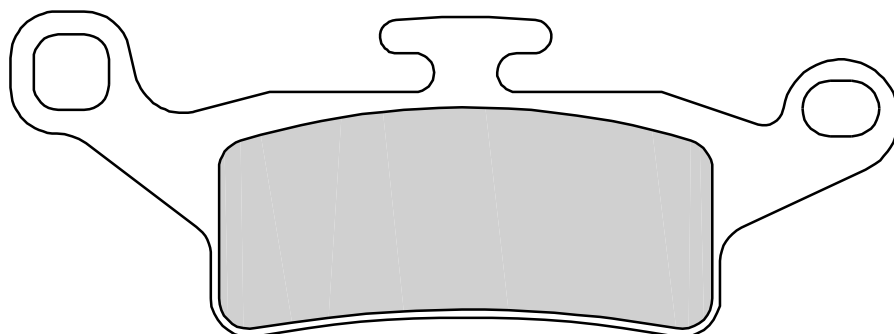
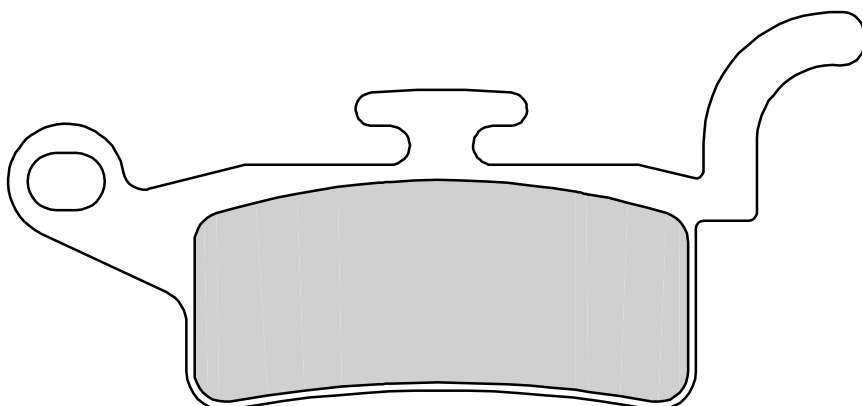

HONDA

250 RECON

97 > •

MBK

125 YW Z

10 > •

YAMAHA

125 BWS

10 > •

125 XENTER

12 > •

125 YW

10 > •

125 YW Z

10 > •

150 XENTER

12 > •





07094.CC

40.9 x 42.8 x 5.3

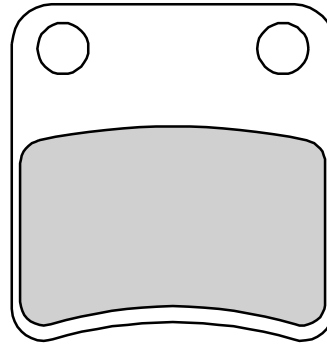

3



APRILIA

850 SRV PARKING BRAKE 12 > 16 •

800 GP800 (PARKING BRAKE)

09 > •

300 MP3 LT I.E. PARKING BRAKE 10 > •

BMW

560 C 650 GT PARKING BRAKE 12 > •

HONDA

400 SILVER WING (PARKING BRAKE) 06 > •

300 MP3 YOURBAN ie parking brake 15 > •

600 C 600 SPORT PARKING BRAKE 11 > 15 •

600 SILVER WING (PARKING BRAKE) 00 > •

350 X10 EXECUTIVE (PARKING BRAKE) 13 > •

650 C 650 SPORT PARKING BRAKE 16 > •

750 INTEGRA DCT/DCTS parking brake 14 > •

400 MP3 LT PARKING BRAKE 09 > •

400 MP3 PARKING BRAKE 07 > •

500 MP3 SPORT PARKING BRAKE 10 > •

500 X10 12 > •

500 X10 EXECUTIVE (PARKING BRAKE) 13 > •

GILERA

500 FUOCO I.E. (PARKING BRAKE) 08 > •

PIAGGIO

125 MP3 (PARKING BRAKE) 06 > 08 •

250 MP3 (PARKING BRAKE) 06 > •



07095.CC

76.9 x 41.9 x 9.3

116.3 x 41.9 x 9.3

07095.XS

“ “ “

3

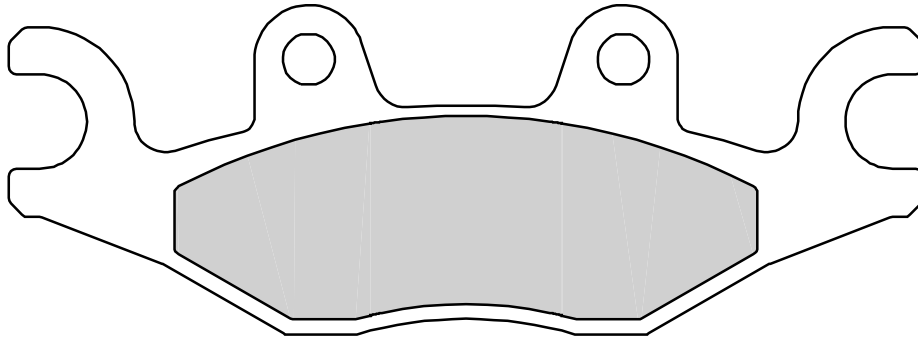
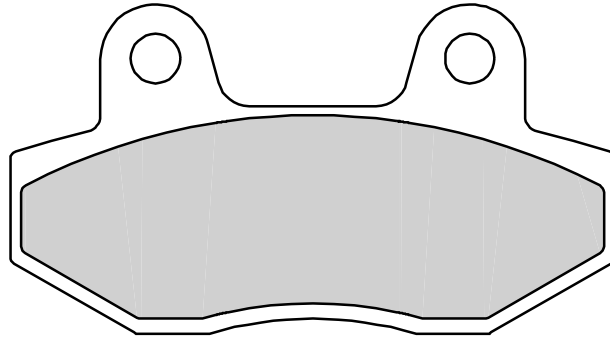

TGB

125 X-LARGE	11 >	•
125 X-MOTION	08 >	•
250 X-MOTION	08 >	•
300 X-MOTION	11 >	•



07096.CC 102.1 x 38.9 x 10.4

07096.XS “ “ “

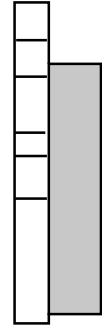
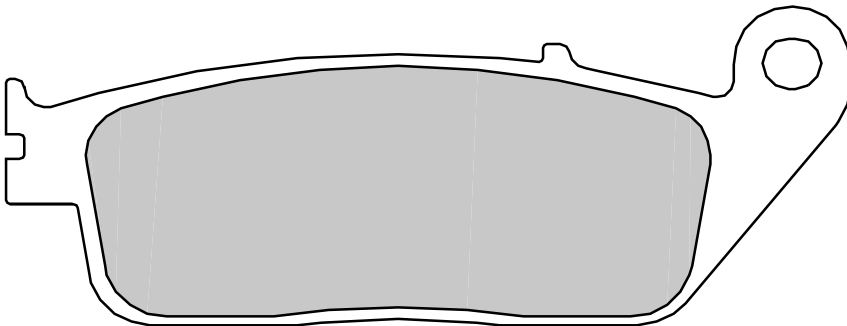
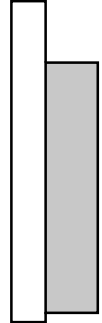
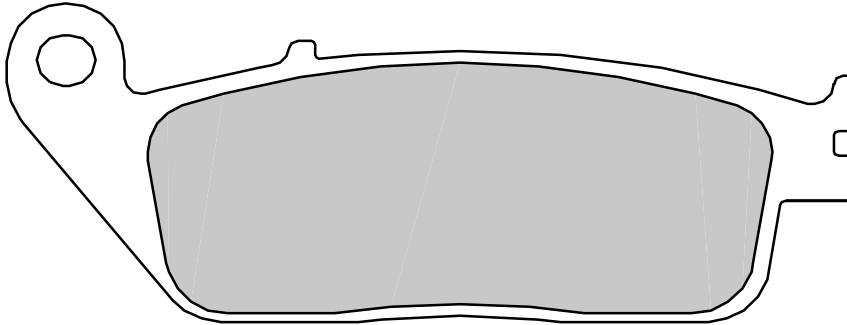

3



HONDA

125 SH MODE	13 >	•
150 SH ABS	14 >	•

YAMAHA

125 X MAX	10 > 13	•
-----------	---------	---

125 X MAX ABS/ BUSINESS ABS	11 >	•
125 X MAX IRON MAX	16 >	•
125 X MAX MOMODESIGN	15 >	•
125 X MAX SPORT EDITION	11 >	•
250 X MAX	10 > 13	•
250 X MAX	14 >	•
250 X MAX ABS	11 > 13	•

250 X MAX IRON MAX	16 >	•
250 X MAX MOMODESIGN	16 >	•
250 X-CITY	08 >	•
400 X MAX	13 > 14	•
400 X MAX	15 > 16	•
400 X MAX ABS	13 > 14	•
400 X MAX ABS	15 > 16	•
400 X MAX IRON MAX	16 >	•



07097.CC

57.7 x 33.2 x 6.1

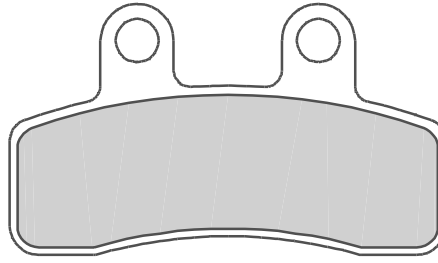

GENERIC

50	SM MINI TRIGGER	08 >	• •
50	X MINI TRIGGER	08 >	• •

ITALJET

50	PIT JET	07 >	• •
125	PIT JET	07 >	• •

LAMBRETTA

50	PATO	08 >	•
----	------	------	---

LIFAN

125	LF OFF ROAD	07 >	•
-----	-------------	------	---

MOTO MORINI

50	SPASSO	07 >	•
----	--------	------	---



07098.CC

102.1 x 38.9 x 8.5

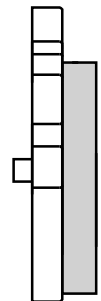
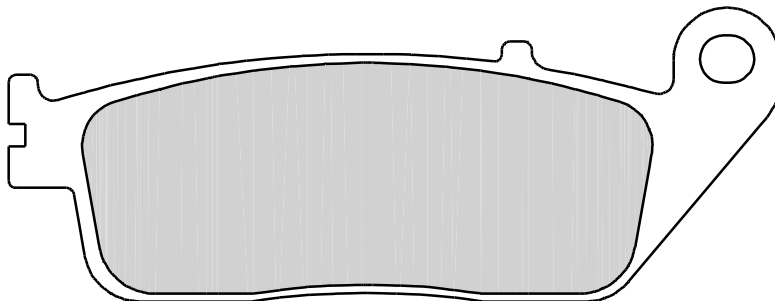
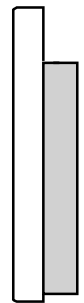
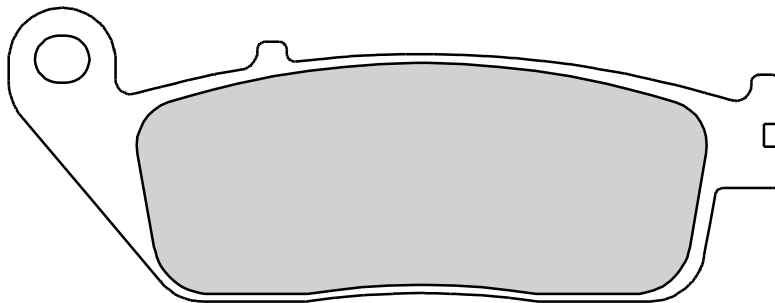

KYMCO

400	XCITING	12 >	•
-----	---------	------	---

400	XCITING 400I ABS	16 >	•
400	XCITING I	12 >	•
500	XCITING	05 > 08	•

500	XCITING I EVO ABS	11 >	•
500	XCITING R ABS	09 >	•
700	MY ROAD	09 >	•



07099.CC

73.7 x 36.2 x 7
37.6 x 31.7 x 9

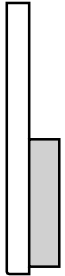
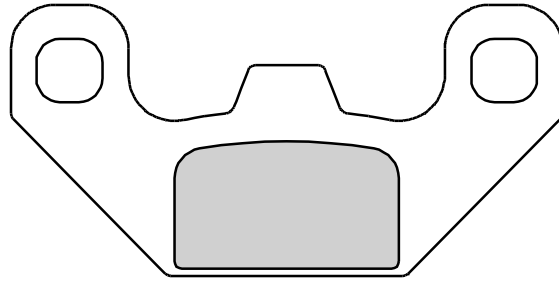

3

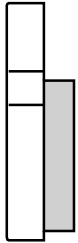
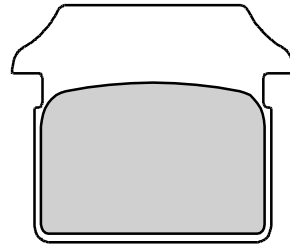

LIFAN

125 LF OFF ROAD 07 > •



07100.CC

68.3 x 55.3 x 9.2

07100.XS

“ “ “

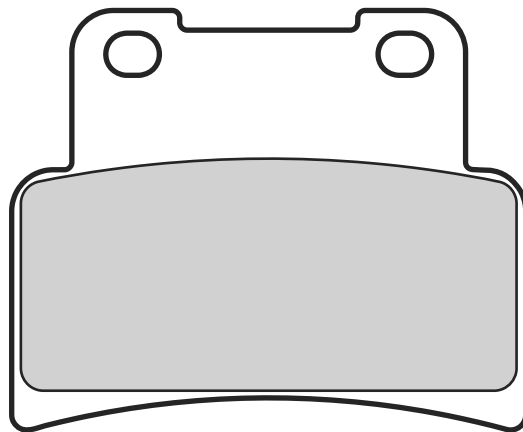

KYMCO

400 XCITING 12 > •
400 XCITING 400I ABS 16 > •
400 XCITING I 12 > •

SYM

400 MAXSYM I 11 > •



07101.CC

72.4 x 53.1 x 8

07101.XS

“ “ “

3

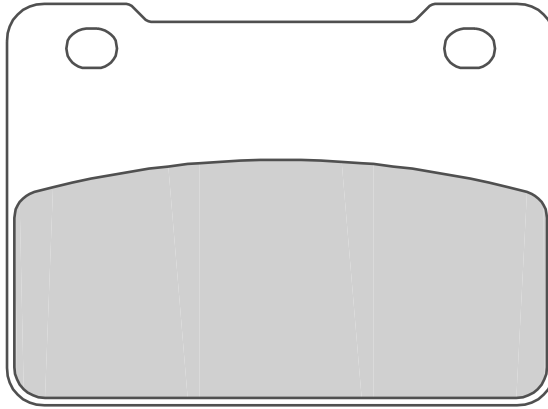

SYM

250 SB	14 >	•
250 SB NI	14 >	•
300 CRUISYM	17 >	•
300 SB CAFE' RACER	16 >	•
600 I MAXSYM SPORT	18 >	•



07102.CC

84.9 x 44.1 x 7
74.5 x 40.9 x 7

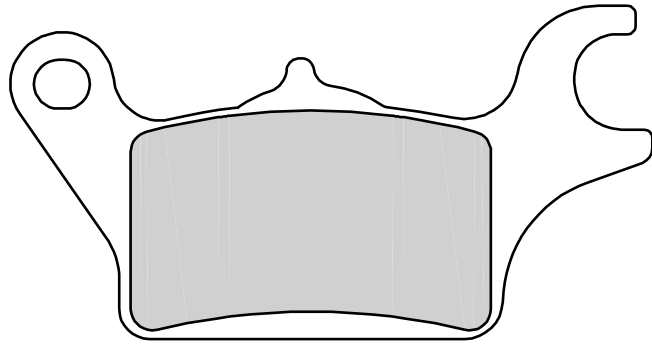

3

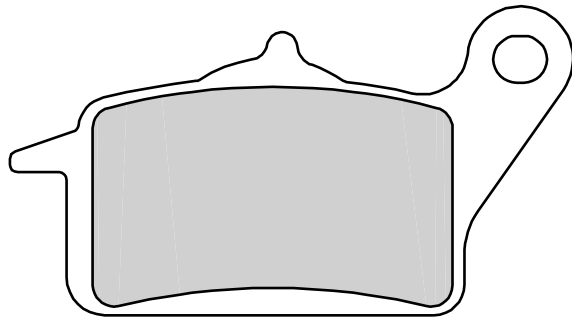

HONDA

110 WAVE

12 > •



07103.CC

82.8 x 47.4 x 11.8

07103.XS

“ “ “

3

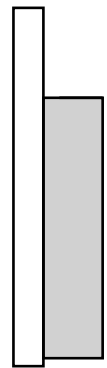
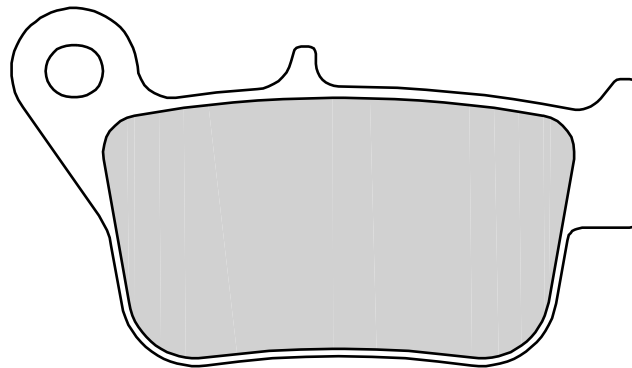
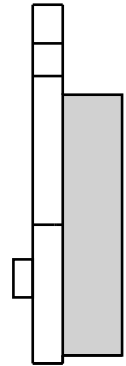
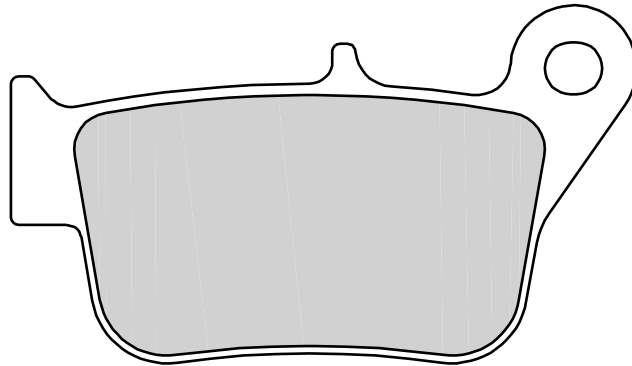

SYM

400 MAXSYM I

11 >



07104.XS

97 x 39.6 x 7

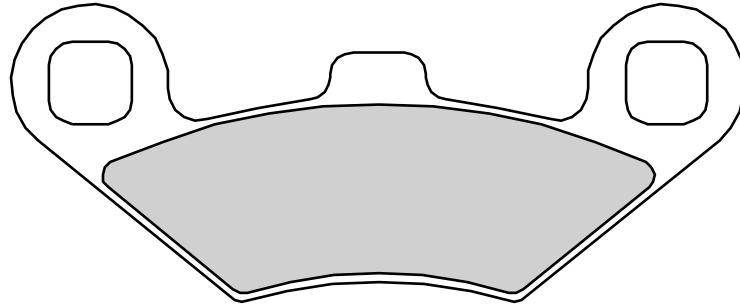

3



PEUGEOT

400	METROPOLIS	15 >	• •
400	METROPOLIS RS	16 >	• •



07106.CC

59.7 x 43.7 x 9.5

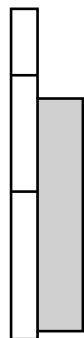
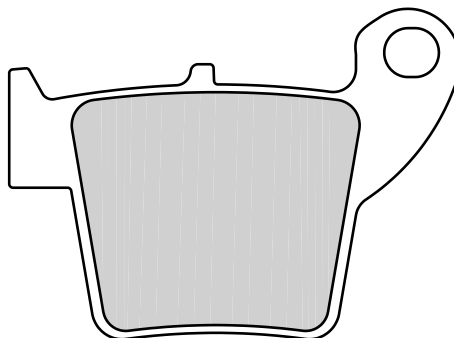
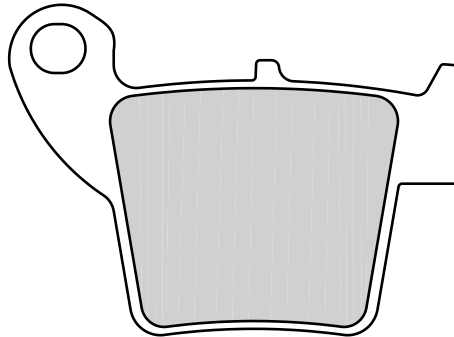

FANTIC MOTOR

50	CABALLERO MOTARD	10 >	•
50	CABALLERO REGOLARITA'	10 >	•



07108.CC

55.4 x 49.4 x 6.6

07108.XS

“ “ “

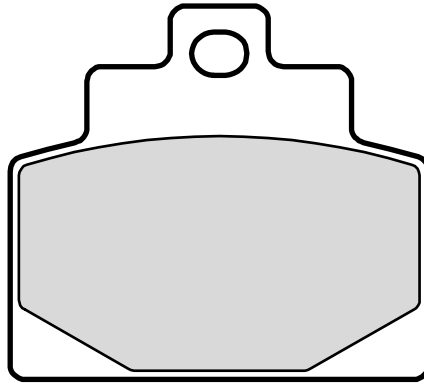

3



PIAGGIO

300	MP3 LT IE ABS	14 >	•
300	MP3 LT SPORT ABS	14 >	•
350	MP3	14 >	•
500	MP3 LT TOURING BUSINESS ABS	14 >	•
500	MP3 LT TOURING SPORT ABS	14 >	•



07109.CC

79.9 x 43.7 x 8.4

07109.XS

“ “ “

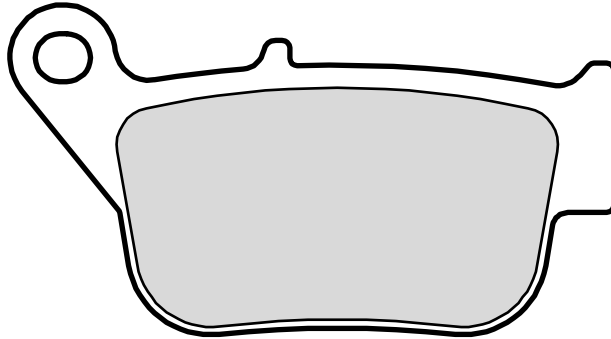

3

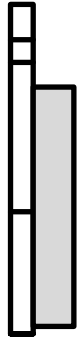
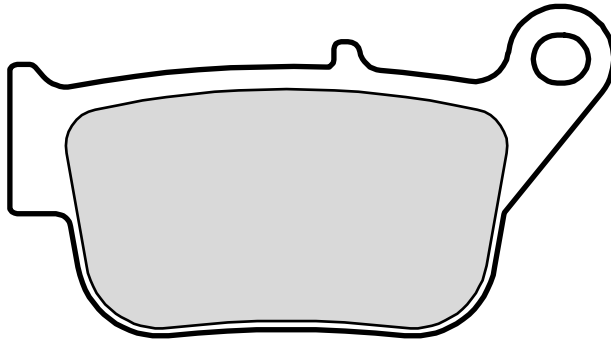

YAMAHA

250 X MAX

14 >





07110.CC

106.7 x 42.4 x 10

91.4 x 39.8 x 10

3

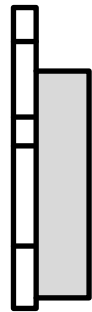
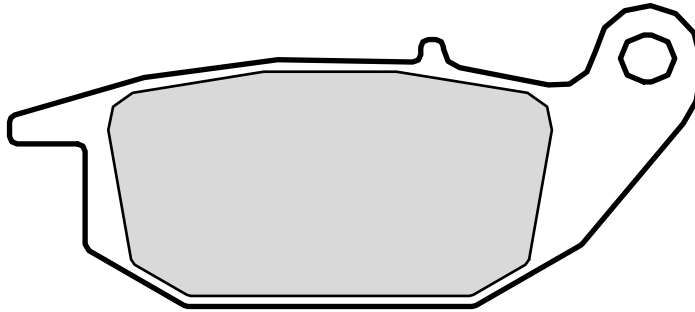
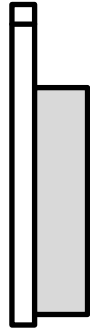
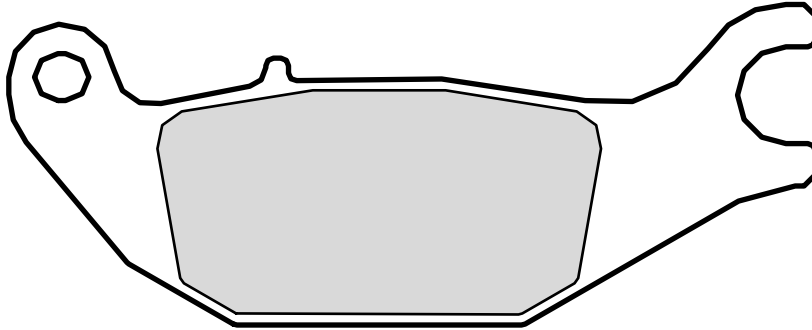

YAMAHA

125	TRICITY LEFT	14 >	•
125	TRICITY RIGHT	14 >	•
155	TRICITY LEFT	17 >	•
155	TRICITY RIGHT	14 >	•



07111.CC

84.9 x 44.1 x 9

74.2 x 40.6 x 9

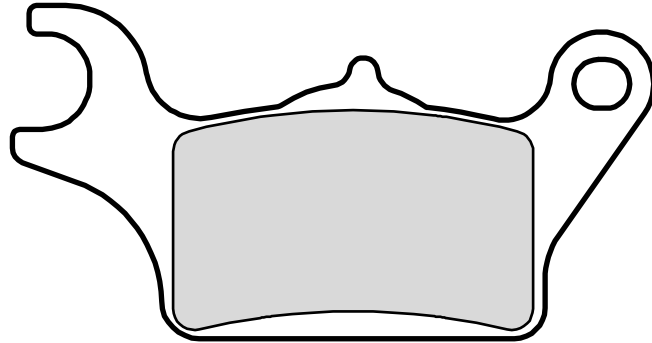

3

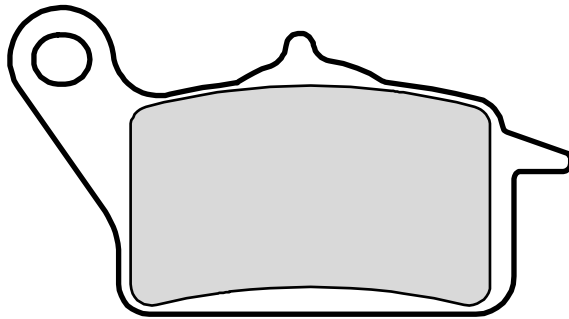

YAMAHA

125	TRICITY RIGHT	14 >	•
155	TRICITY RIGHT	14 >	•



07112.CC

84.9 x 44.1 x 9

74.2 x 40.6 x 9

3

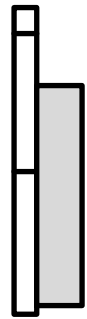
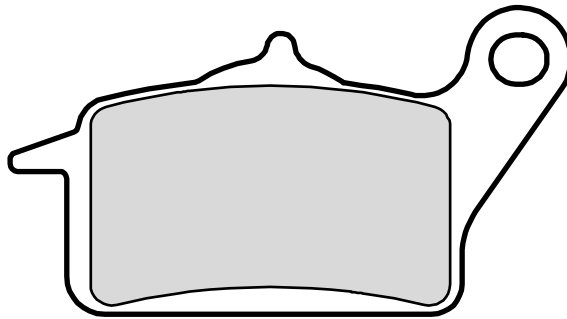
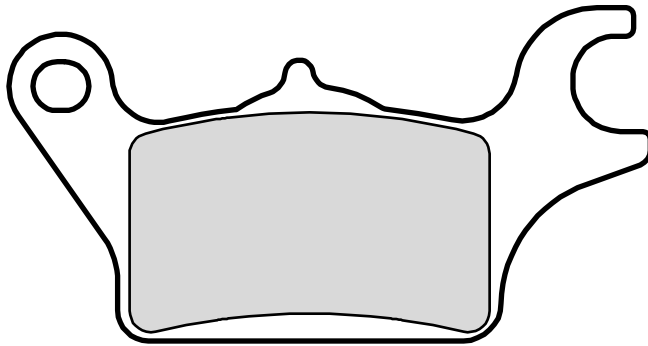

YAMAHA

125 TRICITY LEFT	14 >	•
155 TRICITY LEFT	17 >	•



07113.CC

84.6 x 38.5 x 7.5
98 x 48.5 x 7.5

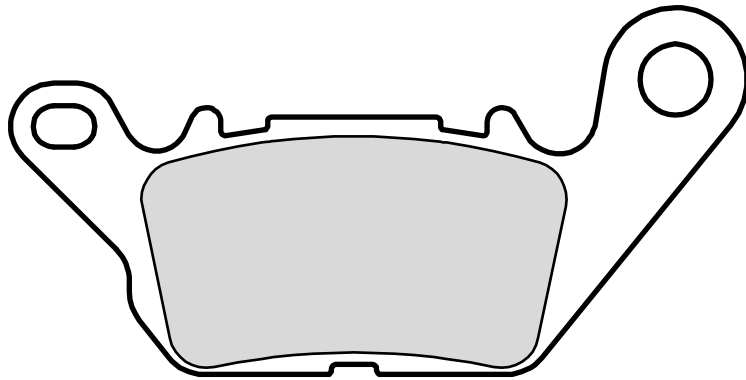

3

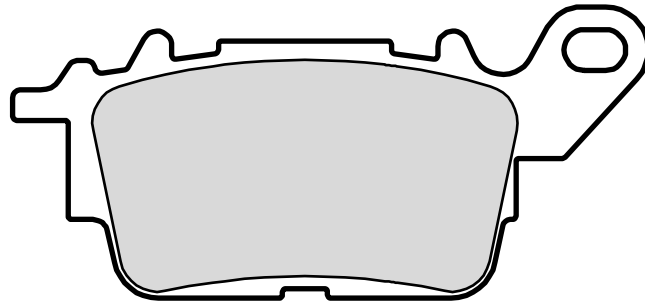

YAMAHA

125 N-MAX	15 >	•
150 N-MAX	15 >	•



07114.CC

95.2 x 36.9 x 8.2

109.8 x 51 x 8.2

3

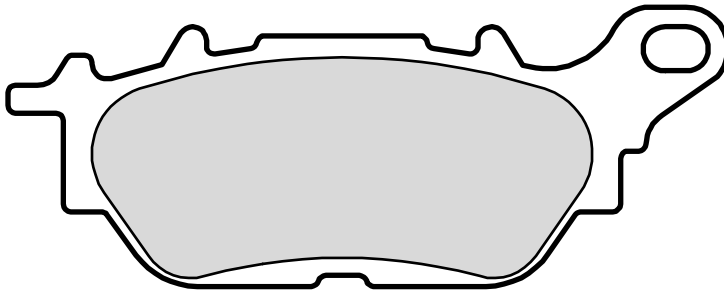
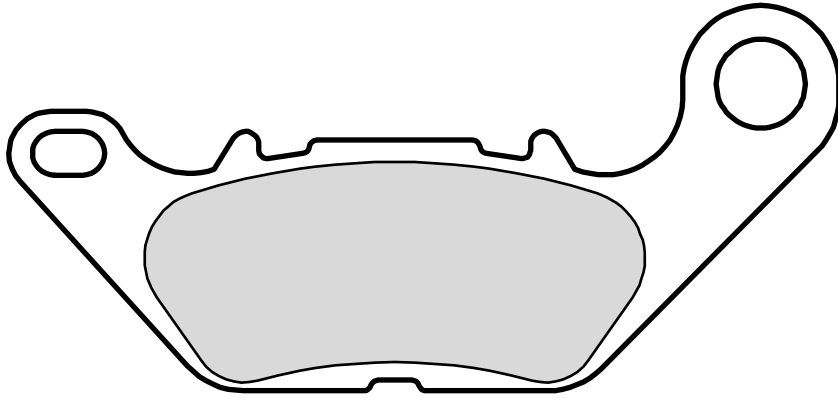

YAMAHA

125 N-MAX	15 >	•
150 N-MAX	15 >	•