



EDIZIONE_04
4 th EDITION
REV. 1



SCOOTER

SCOOTER

CATALOGO
CATALOGUE
SCOOTER

0008.92.00-1

COVER BEPPE DIENA



TOMMASELLI

CATALOGO
CATALOGUE
SCOOTER

EDIZIONE_04 | 4 th EDITION | REV. 1 | LUGLIO/JULY 2018

TOMMASELLI S.R.L.
23896 SIRTORI | LC | ITALY
VIA LECCO 2
PH. +39 039 9211414 - FAX +39 039 9211416
domino@domino-group.com
www.domino-group.com
www.tommaselli.com



FOLLOW US



AFTERMARKET



TOMMASELLI





Una garanzia di serietà e professionalità per le più prestigiose case motociclistiche

La Domino S.r.l. è l'azienda leader a livello europeo nella progettazione e realizzazione di leve freno e frizione, portaleva, comandi gas, dispositivi elettrici e manubri. I suoi prodotti, frutto delle più avanzate ricerche sul campo, sono adatti ad ogni tipo di moto, ciclomotore, scooter e macchina agricola. Il patrimonio di conoscenze tecnologiche accumulato in oltre 50 anni di attività, unito alla severa applicazione di un sistema di qualità aziendale certificato a norme UNI EN ISO 9001:2015, fanno della Domino S.r.l. una garanzia di serietà e professionalità per le più prestigiose case motociclistiche.

A guarantee of solidity and reliability for the most prestigious motorcycle manufactures

Domino S.r.l. is the European leading company in the design and production of brake and clutch levers, lever assembly, throttle controls, electric switches and handlebars. Its products, being the result of the most advanced field research, are suitable for any kind of motorcycle, moped, scooter and agricultural machine. The technological expertise and know how built up in 50 years of activity, together with the strict application of the certified company quality system UNI EN ISO 9001:2015, make of Domino S.r.l. a guarantee of solidity and reliability for the most prestigious motorcycle manufacturers.



Una leadership rafforzata dalla collaborazione con Domino.

Il marchio Tommaselli è da più di ottant'anni sinonimo di affidabilità e sicurezza nella componentistica del settore due ruote. Oggi Tommaselli è un'azienda affermata nell'aftermarket distribuendo in esclusiva il marchio Domino.

A leadership strengthened by the cooperation with Domino.

For more than 80 years Tommaselli brand has meant reliability and safety in the two-wheel components field. Today Tommaselli is a well-established company in the aftermarket field with the exclusive distribution of Domino brand.



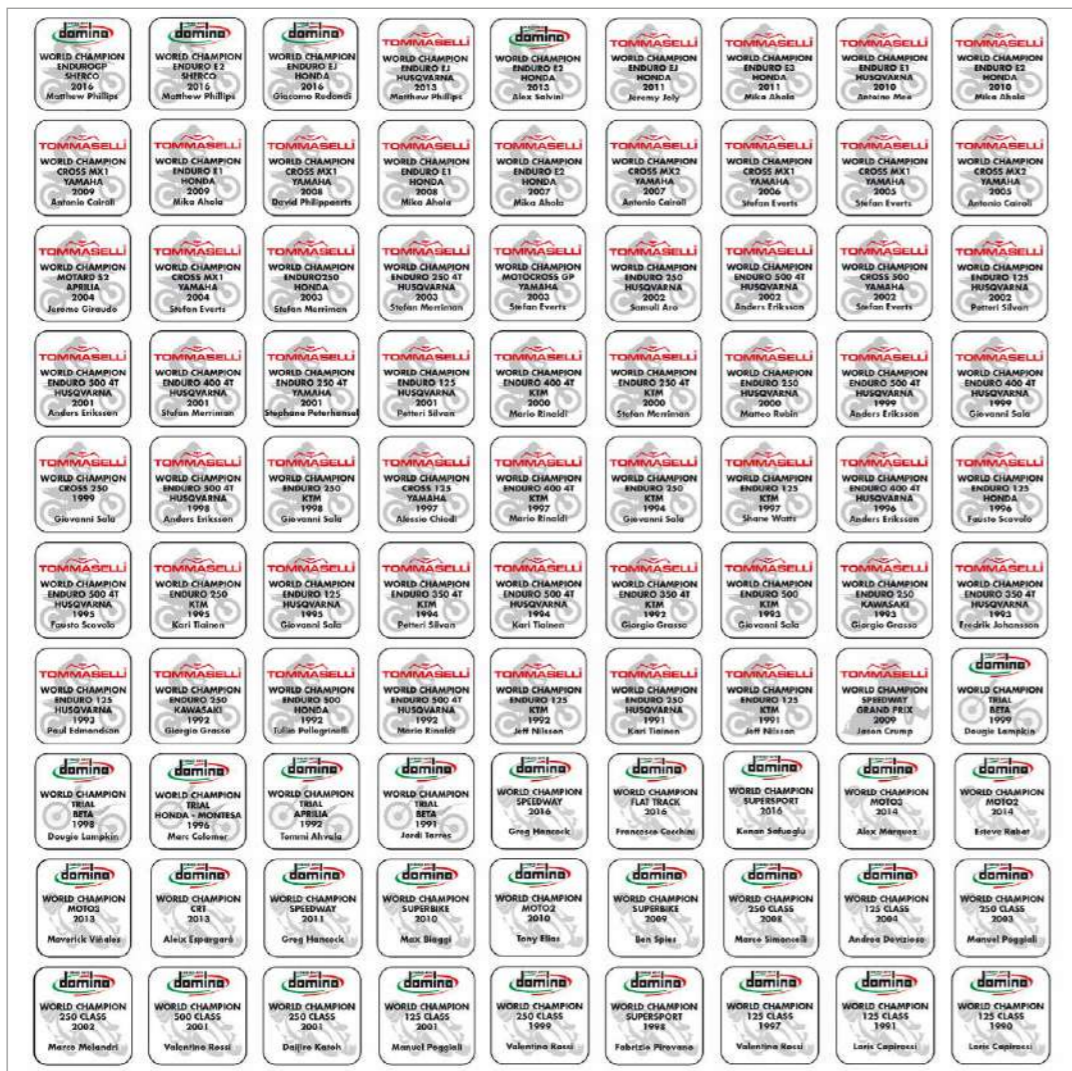

www.domino-group.com

www.tommaselli.com

Note Tutti i comandi illustrati nel presente catalogo sono adatti per manubri di diametro 22 mm., salvo particolari modelli per i quali è specificato il diametro diverso. Tutti i comandi sono verniciati in nero. Ci riserviamo di sostituire o modificare in qualsiasi momento gli articoli evidenziati in questo catalogo sostituendoli con altri di caratteristiche e prestazioni analoghe. Per poter garantire il buon funzionamento dei prodotti illustrati, è assolutamente necessario che l'attività di assemblaggio sul veicolo, venga svolta da un operatore specializzato che possa garantire la corretta applicazione del prodotto. Domino e Tommaselli non rispondono di eventuali conseguenze derivanti da un non corretto assemblaggio del prodotto, in modo particolare laddove detta attività non sia certificata da un operatore specializzato. Per il buon funzionamento dei comandi gas illustrati, si consiglia di usare cavi con filo flessibile di diametro 1,3 a 49 capi. La lunghezza delle manopole indicate nel presente catalogo si riferisce all'oggetto non assemblato sul manubrio. La stessa può variare con una tolleranza di ± 2 mm. Tutte le illustrazioni e le descrizioni tecniche riportate nel presente catalogo devono intendersi indicative. Per ogni e qualunque chiarimento od

approfondimento potrete rivolgervi al nostro ufficio tecnico. I colori riportati nelle tabelle potranno subire variazioni e potranno essere del pari sostituiti con altri pur di gradazioni diverse. Rammentiamo che alcuni articoli sono protetti da brevetto ornamentale o di utilità: per tale ragione l'utilizzatore è diffidato dal porre in essere attività di contraffazione che sarà perseguibile a termine di legge. **Avvertenza:** I prodotti evidenziati in questo catalogo possono essere utilizzati per un uso normale del prodotto e del mezzo al quale vengono assemblati. Domino e Tommaselli non assumono alcuna responsabilità per il malfunzionamento o difettosità che possano evidenziare i prodotti di cui al catalogo, laddove gli stessi siano utilizzati in modo non corretto o assemblati tramite operatori non specializzati o a tal fine autorizzati, o comunque laddove si concretizzi un uso non normale, estremo, od in condizioni diverse da quelle della normale fruibilità. Il nostro ufficio tecnico è a disposizione per ogni e qualunque approfondimento o consiglio, sia per quanto riguarda l'attività di assemblaggio del pezzo, sia per i necessari accorgimenti da adottare in caso di un uso particolare o diverso dal normale dei prodotti. Domino e Tommaselli

non hanno alcun collegamento con i marchi di case fabbricanti di moto, scooter, ciclomotori o con i loro distributori pur indicati nel catalogo. Domino e Tommaselli non saranno responsabili per danni diretti, indiretti o di carattere punitivo, o per ogni perdita, costo o spesa, che per qualsivoglia ragione, direttamente o indirettamente, possa essere sopportata dall'utilizzatore del prodotto, laddove le conseguenze di cui sopra siano imputabili a negligenza o colpa per quanto attiene la scelta del prodotto, il suo assemblaggio e l'uso. In ogni caso la responsabilità di Domino e Tommaselli sarà limitata al valore del pezzo o, in alternativa, a discrezione di Domino e Tommaselli, alla sua sostituzione. Per ogni ulteriore informazioni riguardante i termini e le condizioni di vendita del prodotto, anche per quanto attiene garanzia e responsabilità di Domino e Tommaselli, vorrete fare riferimento alle condizioni generali di fornitura riportate nel nostro sito: www.domino-group.com e www.tommaselli.com, i cui termini si intenderanno accettati dal momento della consegna del prodotto da voi ordinato. **Notes** All controls shown in this catalogue are suitable for handlebars with 22 mm diameter, special models excepted for which the different diameter is specified. All

controls are black painted. We reserve the right to replace or modify at any time the items shown in this catalogue with others having similar performance and features. For the good working of the shown products, it is absolutely necessary that the assembly on the vehicle is carried out by a qualified operator to assure the right product application. Domino and Tommaselli are not responsible for any consequence arisen from an incorrect product assembly, in particular where this activity is not certified by a skilled operator. For the good working of the shown throttle controls, it is advisable to use cables with flexible wire having 1,3 diameter and 49 strands. The grips length specified in this catalogue refers to the grips non-assembled on the handlebar. It can change with a tolerance of ± 2 mm. All pictures and technical descriptions included in this catalogue are provided just for information. For any further explanations, you can apply to our Technical Department. The colours specified in this catalogue can be changed and replaced with others having also different shades. Some items are patented. Therefore, Domino and Tommaselli warn the end user against reproducing them in order to avoid the company taking legal actions.

Note: The products shown in this catalogue can be used for a normal application of the product itself or the vehicle on which they are assembled. Domino and Tommaselli are not responsible for the malfunctioning or the defects of the products included in this catalogue, where these products are wrongly used or assembled by unskilled or unqualified operators or in any case the product is used in an uncommon or extreme way or under conditions different from the normal use. Our Technical Department is at your disposal for any further explanation or advice either for all the activities related to the product assembly or for all the tricks necessary for a special or unusual use of the products. Domino and Tommaselli have no kind of association with the brands of the manufacturers or distributors of motorcycles, mopeds and scooter even if mentioned in this catalogue. Domino and Tommaselli are not responsible for any direct, indirect or punitive damages or further loss, cost and expenses, which for whatever reason, directly or indirectly, can be borne by the product end user, where the

above mentioned consequences are the result of malpractice or fault in the product choice, assembly or use. In any case, Domino and Tommaselli responsibility is limited to the value of the product or, as an alternative, at Domino and Tommaselli discretion, to its replacement. For any further information related to the product sale terms and conditions, also for what Domino and Tommaselli warranty and liability are concerned, you can refer to the general supply conditions specified on our website www.domino-group.com and www.tommaselli.com, whose terms are considered as accepted once the ordered product is delivered.

Information Alle Gasgriffe, die im vorliegenden Katalog dargestellt werden sind für Lenker mit Durchmesser 22mm konzipiert. Ausgenommen sind gewisse Modelle, bei denen ein anderer Durchmesser angegeben ist. Alle Gasgriffe sind schwarz lackiert. Wir behalten uns vor die in diesem Katalog dargestellten Artikel jederzeit zu verändern oder auszutauschen mit anderen Artikeln, die ähnliche Eigenschaften und Charakteristiken haben. Um die gute Funktion der dargestellten Produkte garantieren zu können, ist es absolut notwendig, dass Montagearbeiten am Fahrzeug von einem spezialisierten Mechaniker durchgeführt werden, um die korrekte Anwendung des Produktes garantieren zu können. Domino und Tommaselli können nicht für eventuelle Ansprüche haftbar gemacht werden, die aus einer fehlerhaften Montage der Artikel entstehen, besonders dort, wo die Montage nicht durch einen spezialisierten Mechaniker erfolgt. Für die gute Funktion der dargestellten Gasgriffe, empfehlen wir Seilzüge mit flexiblem Draht von 1,3 mm Durchmesser und 49 Einzeldrähten. Die bei den Griffgummis angegebenen Längen beziehen sich auf die Länge der Griffgummis in nicht auf dem Lenker montiertem Zustand. Diese Längen können mit einer Toleranz von ± 2 mm abweichen. Alle Abbildungen und technischen Beschreibungen im vorliegenden Katalog verstehen sich als ungefähre Richtwerte. Für jede genauere Abklärung oder Definition, wenden Sie sich bitte an unser technisches Büro. Die tabellarisch dargestellten Farben können Schwankungen haben und können durch andere ersetzt werden. Wir weisen darauf hin, dass einige der dargestellten Artikel durch Patente und

Gebrauchsmuster geschützt sind: aus diesem Grunde wird der Verwender darauf hingewiesen, dass für den Fall der Nachahmung rechtliche Schritte eingeleitet werden.

Hinweis: Die in diesem Katalog dargestellten Produkte können für einen normalen Gebrauch der Produkte auf dem Fahrzeug auf dem sie montiert werden verwendet werden. Domino und Tommaselli lehnen jegliche Verantwortung für eine Fehlfunktion oder Fehlerhaftigkeit der Produkte oder Auswirkungen derselben ab, wo diese Produkte nicht ordnungsgemäß verwendet werden, und/oder nicht von einem spezialisiertem Mechaniker montiert wurden oder dazu autorisiert waren, oder wo ein nicht ordnungsgemäßer Gebrauch festgestellt wird, oder extremer Gebrauch, oder unter nicht normalen Bedingungen. Unser technisches Büro steht für jegliche benötigte Abklärung oder Ratschläge zur Verfügung, dies sowohl für die Art der Montage der Artikel, als auch für notwendige Anpassungen bei einer speziellen Anwendung oder bei einer abweichenden Verwendung vom Normalgebrauch. Domino und Tommaselli haben keinerlei Verbindung mit den Marken bzw. Herstellern von Motorrädern, Rollern oder Scootern oder mit Ihren Vertrieben, die in diesem Katalog erwähnt werden. Domino und Tommaselli kann nicht für direkte Schäden, indirekte Schäden sowie Strafen, Verluste, Kosten oder Ausgaben etc. verantwortlich gemacht werden, die aus irgendeinem Grund direkt oder indirekt der Anwender zu tragen hat, dort wo die Konsequenzen des oben angeführten auf Nachlässigkeit zurückzuführen sind oder auf eine falsche Auswahl des Produktes zurückzuführen sind, dies in Hinblick auf das die Montage und die Verwendung. Auf jeden Fall ist die Verantwortung von Domino und Tommaselli auf den Wert des Produktes, oder, andernfalls, nach Domino und Tommaselli Wahl, auf seinen Ersatz beschränkt. Für jegliche weitere Information bezüglich unserer Verkaufskonditionen der Produkte, auch im Hinblick auf Garantie und Verantwortung von Domino und Tommaselli, informieren Sie sich bei unseren Allgemeinen Bedingungen auf unserer Internetseite: www.domino-group.com und www.tommaselli.com. Diese Bedingungen gelten als akzeptiert, sobald das von Ihnen bestellte Produkt geliefert wird.

TUTTI I DIRITTI RISERVATI. NESSUNA PARTE DI QUESTO CATALOGO PUÒ ESSERE RIPRODOTTA O UTILIZZATA IN ALCUNA FORMA O CON QUALSIASI MEZZO, ELETTRONICO O MECCANICO, COMPRESA LA FOTOCOPIATURA, LA REGISTRAZIONE O QUALUNQUE ALTRO SISTEMA PER ARCHIVIARE O TRATTENERE DELLE INFORMAZIONI SENZA IL PERMESSO SCRITTO DELLA DOMINO S.R.L. E DELLA TOMMASELLI S.R.L.

ALL RIGHTS RESERVED. NO PART OF THIS CATALOGUE CAN BE REPRODUCED OR USED IN ANY FORM OR BY ANY MEANS, ELECTRONIC OR MECHANICAL, INCLUDING PHOTOCOPYING, RECORDING OR BY ANY SYSTEM TO FILE OR KEEP INFORMATION WITHOUT DOMINO S.R.L. AND TOMMASELLI S.R.L. WRITTEN PERMISSION.

ALLE RECHTE VORBEHALTEN. KEINE TEILE DIESES KATALOGS KANN NACHGEDRÜCKT ODER KEINESWEGS UND MIT KEINEN MITTEL, OB ELEKTRONISCH ODER MECHANISCH, BENUTZT WERDEN. DIE FOTOKOPIERUNG, DIE REGISTRIERUNG UND JEDER ANDERE MITTEL, UM INFORMATIONEN OHNE DOMINO S.R.L. UND TOMMASELLI S.R.L. SCHRIFTLICHE GENEHMIGUNG ABZULEGEN ODER ZU BEHALTEN, SIND VERBOTEN.

ScOOTer



domino[®]
TOMMASELLI[®]

MANUBRI - HANDLEBARS

Scooter



COD. 0445.32
Manubrio scooter naked
Scooter naked handlebar

ACCESSORI - ACCESSORIES



COD. 1100.84
Barra di rinforzo
per manubri senza traversino
Lunghezza - length 200 mm
Reinforcement bar
for handlebars without cross bar

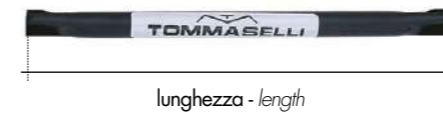

COD. 0240.84
Traversino - cross bar
Lunghezza - length 240 mm

COD. 0295.84
Traversino - cross bar
Lunghezza - length 295 mm



COD. 0002.91
Kit morsetti - Kit of clamps

Alluminio autotemperante - Self-hardening aluminium

| COD. COD. | UTILIZZO USE | COLORE COLOUR | A A | B B | C C | D D |
|--------------|---------------------------|------------------------|--------|--------|--------|--------|
| 0438.32 | SCOOTER NAKED MBK Booster | Antracite - Anthracite | 651 | 83 | 138 | 93 |
| 0445.32 | SCOOTER NAKED MBK Slider | Antracite - Anthracite | 680 | 110 | 132 | 94 |

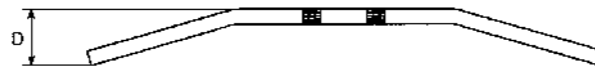
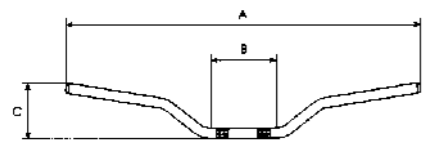

Le quote indicate sono espresse in mm - The specified dimensions are given in mm

MANOPOLE - GRIPS

Scooter



MANOPOLE A350 TURISMO

A350 TURISMO GRIPS



Cod. A35041C4270C7-0
Manopole bicolore A350 TURISMO
in gomma termoplastica

A350 TURISMO two-colour grips in rubber compound

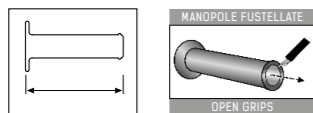

| COD. COD. | COLORE COLOUR |
|--------------|------------------|
|--------------|------------------|

- A35041C4042 **Rosso/nero** - Red/black
- A35041C4044 **Verde/nero** - Green/black
- A35041C4048 **Blu/nero** - Blue/black
- A35041C4063 **Marrone/nero** - Brown/black
- A35041C4070 **Antracite/nero** - Anthracite/black
- A35041C4270 **Antracite/rosso** - Anthracite/red
- A35041C4470 **Antracite/verde** - Anthracite/green
- A35041C4570 **Antracite/arancio** - Anthracite/orange
- A35041C4770 **Antracite/giallo** - Anthracite/yellow
- A35041C4870 **Antracite/blu** - Anthracite/blue
- A35041C5270 **Antracite/grigio** - Anthracite/grey
- A35041C6459 **Argento/marrone** - Silver/brown
- A35041C6564 **Marrone/grigio** - Brown/grey
- A35041C7059 **Argento/antracite** - Silver/anthracite



BICOLORE - TWO-COLOUR GRIPS



Cod. A25041C4240B7-0
Manopole XM2 double super soft
in gomma termoplastica
XM2 double super soft grips in rubber compound

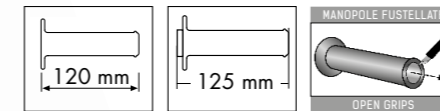

| COD. COD. | COLORE COLOUR |
|--------------|------------------|
|--------------|------------------|

- A25041C4052 **Grigio/nero** - Grey/black
- A25041C4240 **Nero/rosso** - Black/red
- A25041C4340 **Nero/fucsia** - Black/fuchsia
- A25041C4440 **Nero/verde** - Black/green
- A25041C4540 **Nero/arancio** - Black/orange
- A25041C4643 **Fucsia/bianco** - Fuchsia/white
- A25041C4648 **Blu/bianco** - Blue/white
- A25041C4740 **Nero/giallo** - Black/yellow
- A25041C4840 **Nero/blu** - Black/blue
- A25041C5240 **Nero/grigio** - Black/grey



Cod. A02041C4540A7-1
Manopole bicolore Cross in gomma termoplastica
Cross two - colour grips in rubber compound

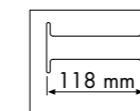

| COD. COD. | COLORE COLOUR |
|--------------|------------------|
|--------------|------------------|

- A02041C4240 **Nero/rosso** - Black/red
- A02041C4440 **Nero/verde** - Black/green
- A02041C4540 **Nero/arancio** - Black/orange
- A02041C4552 **Grigio/arancio** - Grey/orange
- A02041C4648 **Blu/bianco** - Blue/white
- A02041C4740 **Nero/giallo** - Black/yellow
- A02041C7170 **Nero/grigio** - Black/grey



MONOCOLORE - MONOCHROME GRIPS



Cod. 0280.82.40.06-0
Manopole monocolore in PVC
Monochrome grips in PVC

NEW COD. 0280.82

Mod. Honda
Colore nero
Black colour
per - for
Honda SH 300

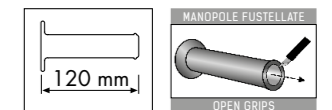

NEW COD. 0282.82

Mod. Honda
Colore nero - Black colour
Versione chiusa - Closed end



Cod. 0300.82.40.06-0
Manopole monocolore in gomma termoplastica
Monochrome grips in rubber compound

COD. 0300.82
Mod. Yamaha
Colore nero
Black colour

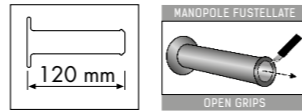

Cod. 1150.82.40.06
Manopole monocolore Cross/Enduro
in gomma termoplastica
Cross/Enduro monochrome grips
in rubber compound

COD. 1150.82
Colori: nero, rosso, blu,
giallo fluo, grigio
Colours: black, red, blue,
yellow fluo, grey

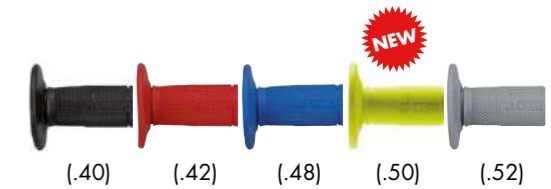
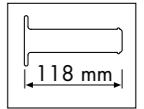

Cod. 1152.82.40.06
Manopole monocolore in gomma termoplastica
Monochrome grips in rubber compound

COD. 1152.82
Mod. Suzuki
Colore nero
Black colour

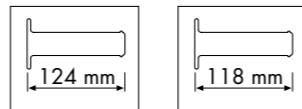

sinistra - left destra - right

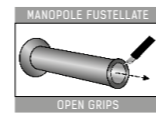

Cod. 3393.82.40.04
Manopole monocolore in PVC
Monochrome grips in PVC

COD. 3393.82
Colore nero
Black colour

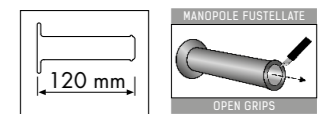

Cod. 3720.82.40.06-0
Manopole monocolore in gomma termoplastica
Monochrome grips in rubber compound

COD. 3720.82
Colore nero
Black colour

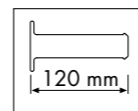

COD. 3721.82
Colore nero
Black colour

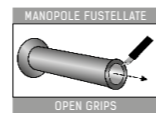

Cod. 3394.82.54.06-1
Manopole monocolore in gomma termoplastica
Monochrome grips in rubber compound

COD. 3394.82
Mod. Retró
Colori: marrone, para
Colours: brown,
para rubber colour

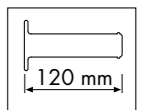

Cod. 3205.82.40.06
Manopole monocolore in gomma termoplastica
Monochrome grips in rubber compound

COD. 3205.82
Colore nero
Black colour

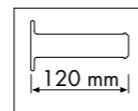

COD. 5519.82

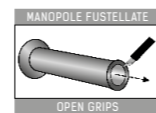

Cod. 3208.82.40.06
Manopole monocolore Scooter in gomma termoplastica
Scooter monochrome grips in rubber compound

COD. 3208.82
Colore nero
Black colour

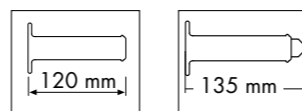

Cod. 1127.82.40.06
Manopole monocolore in gomma termoplastica
Monochrome grips in rubber compound

COD. 1127.82
Colore nero - Black colour

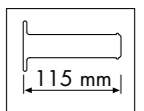

COD. 1129.82
per - for Honda
SH 125/150 <2012

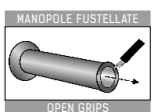

MANOPOLE PIAGGIO - PIAGGIO GRIPS

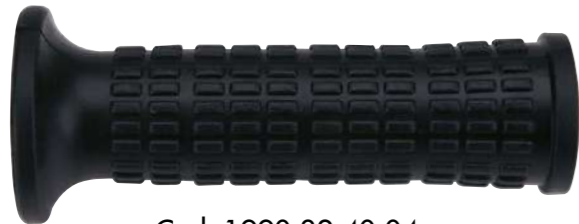

Cod. 1990.82.40.04
Manopole monocolori ciclomotore in PVC
Moped monochrome grips in PVC

COD. 1990.82
Colore nero
Colour black

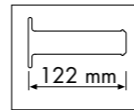

Cod.1934.82.40.04
Manopole monocolori Ottagonale in PVC
Ottagonale monochrome grips in PVC

COD. 1934.82
Colore nero
Black colour

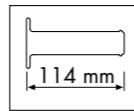

Cod. 2166.82.40.04
Manopole monocolori in PVC
Monochrome grips in PVC

COD. 2166.82
Colore nero
Black colour

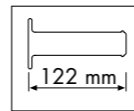

COD. 3031.82.40.04
Mod. TYPHOON
PVC
Colore nero - black colour

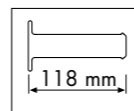

COD. 3040.82.40.04
Mod. VESPA Ø 22
sinistra /destra - left / right
PVC
Colore nero - black colour
per - for Piaggio VESPA FL2 HP 50 1991-1997

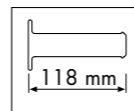

COD. 5243.82.40.04
Mod. SCOOTER
PVC
Colore nero - Black colour

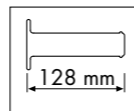

COD. 5239.82.40.04
Mod. SCOOTER
PVC
Colore nero - Black colour

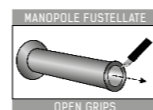

COMANDI GAS THROTTLE CONTROLS Scooter



CAVO AVVOLGENTE - WINDING CABLE

COD. 1708.03

Monocavo - One cable
Rapidità - Quickness 3,8 °/mm
Max corsa - stroke 45 mm
Derbi VAMOS 50
Peugeot SPEEDAKE 50, SV 50/125,
ZENITH 50

COD. 2456.03

Senza manopola - Without grip
Monocavo - One cable
Rapidità - Quickness 3,8 °/mm
Max corsa - stroke 45 mm
Piaggio DIESIS 50/100
Yamaha NEO'S 50
Aprilia SONIC 50, SR W W 50,
LEONARDO 125/150/250
Derbi ATLANTIS 50
Italjet TORPEDO 50
Mbk OVETTO 50

COD. 1689.03

Monocavo - One cable
Rapidità - Quickness 3,8 °/mm
Max corsa - stroke 45 mm
Aprilia AMICO 50 SPORT/LK/LX/GL/GLE,
AMICO YUNGER 50, SR 50 1996, SR 50
REPLICA/URBAN KID/VIPER



COD. 3020.03

Mod. Scooter
Monocavo - One cable
Derbi SENDA SR 125 4T - SM - R 2006
Rieju ENDURO SMX - SMX PRO > 2006,
MRX - MRX PRO 2006, RR 2006,
SMX/MRX < 2006, SPIKE 2006

COD. 1695.03

Monocavo - One cable
Rapidità - Quickness 3,8 °/mm
Max corsa - stroke 30 mm
Mbk BOOSTER R SPIRIT 50, EVOLIS 50,
FIZZ 50, FORTE 50
Yamaha AXIS 50, BREEZE 50

COD. 2755.03

Mod. Scooter
Senza manopola - Without grip
Monocavo - One cable
Mbk BOOSTER NEXT G 50 2000,
BOOSTER R 50 2004, BOOSTER SPIRIT 50 2000,
STUNT 50
Yamaha BW'S 50 2000, BW'S N.G. 50 2000,
SLIDER 50
Rieju RS2 MATRIX PRO 2007, RS2 NKD 2007



COD. 2111.03

Senza manopola - Without grip
Monocavo - One cable
Aprilia SCARABEO 50 1997/2003,
SCARABEO 100 4T < 2000,
RALLY 1996 H2O 50
Betamotor ARK 50, EIKON 125/150
Cagiva CORSA 50, PROGRESS 50
Derbi AVENTURA, FURAX, HUNTER,
HUNTER/PADDOK, PREDATOR 50 2000
Italjet FORMULA 50/125
Motorhispania BLACK LINE 2006,
RYZ PRO RACING 2006, URBAN BIKE 2006

GAS PIAGGIO SCOOTER - PIAGGIO SCOOTER THROTTLE CONTROLS



COD. 3746.03

Universale - Universal
con manopola chiusa - with closed end grip
cod. 3031.82
2 cavi - 2 cables

COD. 3983.03

Universale - Universal
senza manopola - without grip
2 cavi - 2 cables

COD. 5186.03

Universale - Universal
con manopola chiusa - with closed end grip
cod. 5243.82
2 cavi - 2 cables

COD. 3042.03

Universale - Universal
con manopola fustellata - with open end grip
cod. 5239.82
2 cavi - 2 cables

COD. 3984.03

Universale - Universal
senza manopola - without grip
2 cavi - 2 cables



COD. 2151.03

Monocavo - One cable
Piaggio NRG 50 1997,
TYPHOON 50 1997
codice leva - lever cod. 2327.71

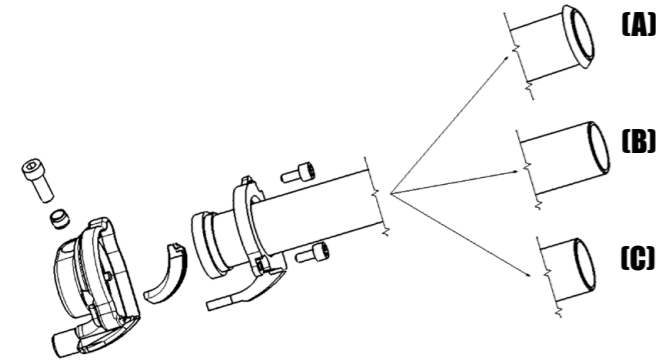

COD. 3745.03 (A)

Universale - Universal
Lunghezza tubo - Tube length 124 mm
Gilera RUNNER 180 VXR 4T,
RUNNER 200 VXR < 2005
Piaggio MP3 125 < 2007,
VESPA GTS 125 < 2006, X7 125 i.e. < 2008,
X8 125 PREMIUM EURO 3 < 2006,
X8 200/250 < 2005, X9 200 < 2003,
X9 EVOLUTION 125 < 2005,
X9 EVOLUTION 250 < 2006,
XEVO 125 < 2007, LIBERTY 150 4T < 2008,
VESPA GTS 200 < 2006,
BEVERLY 250 2004/2005,
BEVERLY 250 EURO 3 2006/2007

COD. 3747.03 (B)

Universale - Universal
Lunghezza tubo - Tube length 119 mm
Piaggio CARNABY 125/200 < 2007,
BEVERLY 125 < 2004,
BEVERLY 125 TOURER EURO 3 < 2008,
FLY 125 2005/2007, LIBERTY 50 2T < 2005,
LIBERTY 50 4T < 2005,
LIBERTY 125 4T 2004/2008,
LIBERTY ST 200 < 2004,
LIBERTY 4T 200 < 2007,
NRG 50 < 2002, NRG 50 < 2006,
TYPHOON 50 < 2005, VESPA ET2 50 < 1997,
VESPA ET4 125 < 1996

COD. 3748.03 (C)

Universale - Universal
Lunghezza tubo - Tube length 112 mm
Gilera STALKER 50 < 2004
Piaggio FLY 50 4T < 2006, FLY 100 4T < 2006,
SKIPPER 50, SKIPPER 125/150 < 2000,
QUARZ 50, VESPA LX 4T 50 < 2005,
VESPA S 2T 50 < 2007,
VESPA S-LX 2T 50 < 2005,
VESPA S-LX 4T 125 < 2005,
VESPA S-LX 150 < 2005,
VESPA 50 4T 4V < 2008, ZIP FAST RIDER 50,
ZIP FAST RIDER 50 1995,
ZIP RST 50 1998/1999

GAS CICLOMOTORE CON CORSOIO - MOPED THROTTLE CONTROLS WITH SLIDER



COD. 0181.03

Con leva in acciaio - With steel lever
Bimotor CIAK 3 KS, V 1 T KS
codice leva - lever cod. 0491.63



COD. 3082.03

Con leva in resina acetilica, senza attacco per dispositivo elettrico, con impianto stop
With acetal resin lever, stop system and without facility for electric switch fitment
1 cavo - 1 cable
codice leva - lever cod. 3833.73



COD. 3084.03

Con leva in resina acetilica, attacco per dispositivo elettrico, impianto stop
With acetal resin lever, stop system and facility for electric switch fitment
1 cavo - 1 cable
codice leva - lever cod. 3833.73

GAS PIAGGIO CON CORSOIO - PIAGGIO THROTTLE CONTROLS WITH SLIDER



COD. 0663.03
 Piaggio BOXER 49, BRAVO 49,
 CIAO 49 > 1988, SI 49 > 1988
 codice leva - lever cod. 0799.73



COD. 1242.03
 Gilera TREND 50
 Piaggio CIAO 50 1989/1992,
 SI 50 1990/1991
 codice leva - lever cod. 1292.71



COD. 1867.03
 Gilera TYPHOON 50 > 1997
 STORM 50 > 1997
 codice leva - lever cod. 2338.71



COD. 0219.03
 Piaggio CIAO SC
 codice leva - lever cod. 0491.63



COD. 2069.03
 Con leva in plastica
 With plastic lever
 Piaggio ZIP 50 1995
 codice leva - lever cod. 2133.73

COD. 2047.03
 Con leva in alluminio
 With aluminium lever
 Gilera TYPHOON MARTINI 50,
 TYPHOON STREET 50
 Piaggio NTT 50, NRG 50
 codice leva - lever cod. 2338.71

COD. 2072.03
 Con leva in alluminio - With aluminium lever
 Piaggio FREE 50 1998/1999, FREE F1 50 1997
 codice leva - lever cod. 2338.71

VARI - OTHERS



COD. 0519.03
 Mod Moped
 Monocavo - One cable
 Rapidità - Quickness 4,3 °/mm
 Max corsa - stroke 43 mm
 Escluso mercato Usa - Usa market excepted



COD. 0629.03
 Mod. Commandos
 Monocavo - One cable
 Rapidità - Quickness 2,2 °/mm
 Max corsa - stroke 42 mm

COD. 0550.03
 Mod. Commandos
 Senza manopola - Without grip
 Monocavo - One cable
 Rapidità - Quickness 2,2 °/mm
 Max corsa - stroke 42 mm



COD. 0500.03
 Mod. Formula
 Monocavo - One cable
 Rapidità - Quickness 2,0 °/mm
 Max corsa - stroke 48 mm

COD. 0506.03
 Senza manopola - Without grip
 Monocavo - One cable
 Rapidità - Quickness 2,0 °/mm
 Max corsa - stroke 48 mm



COD. 0514.03
 Mod HF
 Monocavo - One cable
 Rapidità - Quickness 2,3 °/mm
 Max corsa - stroke 46 mm

COD. 0515.03
 Versione lucida - Polished version
 Monocavo - One cable
 Rapidità - Quickness 2,3 °/mm
 Max corsa - stroke 46 mm



COD. 0394.03
 Mod Ghepard
 Monocavo - One cable
 Rapidità - Quickness 2,3 °/mm
 Max corsa - stroke 45 mm



COD. 2287.03
 Monocavo - One cable
 Rapidità - Quickness 4 °/mm
 Max corsa - stroke 46 mm



COD. 2384.03
 Monocavo - One cable
 Rapidità - Quickness 3,6 °/mm
 Max corsa - stroke 74 mm

COD. 0721.03
 Senza manopola - Without grip
 Monocavo - One cable
 Rapidità - Quickness 3,6 °/mm
 Max corsa - stroke 74 mm



COD. 0723.03
 Mod. Moto
 con movimento orizzontale - with horizontal run
 Monocavo - One cable
 Rapidità - Quickness 3,6 °/mm
 Max corsa - stroke 74 mm

ALTRE APPLICAZIONI - OTHER APPLICATIONS



COD. 2172.86
 Comando choke anulare
 Anular choke control

INTERRUTTORI STOP - STOP SWITCHES



COD. 2218.20
 Interruttore stop
 normalmente chiuso
 Stop switch
 normally closed



COD. 3151.20
 Interruttore stop
 normalmente chiuso
 (microswitch)
 Stop switch normally
 closed (microswitch)

ACCESSORI - ACCESSORIES



COD. 1777.91
 Moltiplicatore di corsa
 Stroke multiplier
 rapporto moltiplicatore
 multiplication ratio 1 : 1.33



COD. 0182.86
 Sdoppiatore con
 foro entrata guaina
 Splitter with cable protective
 covering inlet hole Ø 6,25
 corsa - stroke mm 36
 colore nero - black colour

COD. 1068.86
 Sdoppiatore con
 foro entrata guaina
 Splitter with cable protective
 covering inlet hole Ø 6,8
 corsa - stroke mm 36
 colore grigio - grey colour

COD. 1628.86
 Sdoppiatore con
 foro entrata guaina
 Splitter with cable protective
 covering inlet hole Ø 6,8
 corsa - stroke mm 41
 colore rosso - red colour

COD. 2135.86
 Sdoppiatore con
 foro entrata guaina
 Splitter with cable protective
 covering inlet hole Ø 6,8
 corsa - stroke mm 36
 colore marrone - brown colour

ACCESSORI - ACCESSORIES



COD. 0403.91
 Gruppo vite fissaggio
 leva freno e frizione
 Brake and clutch lever
 tightening screw



COD. 0800.02.693
 Molla per leva nylon
 Nylon lever spring



COD. 0101.02.031
 Morsetto guidafilo
 Cable nipple



COD. 1572.02.1846
 Molla - spring
 per leve - for levers cod.
 3060.61 - 2014.61 - 2332.61



COD. 0101.02.199
 Morsetto guidafilo
 Cable nipple



COD. 1335.91
 Corsoio con vite per gas
 tubo plastica
 Slider with screw for
 plastic throttle tube



COD. 0110.02.073
 Regolatore M5
 M5 adjusting screw



COD. 0500.02.2093
 Carrucola per comando gas
 Pulley for throttle
 controls cod.
 0500.03/0506.03



COD. 0510.02.640
 Regolatore
 per freno e frizione M6
 M6 adjusting screw for brake
 and clutch levers



COD. 0500.02.2096
 Coperchietto per comandi gas
 Cap for throttle controls
 cod. 0500.03/0506.03



COD. 0670.02.842
 Regolatore M6
 M6 adjusting screw



COD. 0514.02.2092
 Coperchietto per
 comandi gas
 Cap for throttle controls
 cod.0514.03/0515.03



COD. 0922.02.910
 Regolatore M6
 M6 adjusting screw



COD. 0519.02.2094
 Coperchietto
 Cap



COD. 0101.02.002
 Nottolino - Nipple



COD. 0550.02.506
 Coperchietto per
 comandi gas
 Cap for throttle controls
 cod. 0629.03/0550.03



COD. 0291.02.363
 Nottolino - Nipple



COD. 0618.02.725
 Nottolino per leva nylon
 Nylon lever nipple

GOMMINI - RUBBER CAPS



COD. 0077.02.4197
 Soffietto per pulsante
 interruttore stop
 Stop switch cap

COMANDI PORTALEVA LEVER ASSEMBLY

Scooter



SCOOTER CICLOMOTORE - MOPED

COD. 1587.04
Sinistro con leva lunga
Left with long lever
fulcro leva - lever fulcrum mm 24,5
lunghezza leva - lever length mm 154
codice leva - lever cod. 1357.61
Aprilia AMICO 50 SPORT/LK/LX/GL/GLE 50,
AMICO YOUNGER 50,
SR50 REPLICIA/URBAN KID/VIPER 50
Peugeot SV 50, SV 125 < 1993

COD. 2485.04
Sinistro - Left
fulcro leva - lever fulcrum mm 24
lunghezza leva - lever length mm 138
codice leva - lever cod. 3463.61
Mbk BOOSTER NEXT G 2000, MbK BOOSTER
SPIRIT 2000, Yamaha BW'S 2000, Yamaha
BW'S N.G. 2000



COD. 2117.04
Sinistro con leva lucida
Left with polished lever
fulcro leva - lever fulcrum mm 24,5
lunghezza leva - lever length mm 154
codice leva - lever cod. 2879.61
Aprilia HABANA 50, SR 50 1996, SR 50 W W

COD. 2522.04
Sinistro con leva lucida
Left with polished lever
fulcro leva - lever fulcrum mm 24,5
lunghezza leva - lever length mm 152
codice leva - lever cod. 3277.61
Mbk Ovetto 50, Yamaha Neo's 50



COD. 1497.04
Sinistro con leva in plastica e levetta choke
Left with plastic lever and choke lever
fulcro leva - lever fulcrum mm 24
lunghezza leva - lever length mm 135
codice leva - lever cod. 0778.63
Mbk BOOSTER 50



COD. 1954.04
Sinistro con leva in alluminio e levetta choke
Left with aluminium lever and choke lever
fulcro leva - lever fulcrum mm 24
lunghezza leva - lever length mm 135
codice leva - lever cod. 2515.61
Mbk BOOSTER R SPIRIT 50



COD. 2728.04
Sinistro con levetta choke
Left with choke lever
fulcro leva - lever fulcrum mm 24
lunghezza leva - lever length mm 140
codice leva - lever cod. 2071.61
Mbk STUNT 50, BOOSTER R 50 2004
Yamaha SLIDER 50



COD. 2980.04

Sinistro - Left
 fulcro leva - lever fulcrum mm 28,5
 lunghezza leva - lever length mm 159
 codice leva - lever cod. 0976.61
 Bultaco LOBITO 50
 Derbi SENDA R 50, SENDA SUPER MOT. 125

COD. 2104.04

Sinistro - Left
 fulcro leva - lever fulcrum mm 24
 lunghezza leva - lever length mm 140
 codice leva - lever cod. 2071.61
 Derbi FENIX, SENDA R DRD - X-TREM -
 RACER 50, XRACE - 50SM 2006,
 X-TREM 50R - 50M 2006
 Gilera RCR - SMT 50 2003

COD. 3027.04

Sinistro con dispositivo stop
 Left with stop switch
 fulcro leva - lever fulcrum mm 24
 lunghezza leva - lever length mm 140
 codice leva - lever cod. 2071.61
 MbK MACH G 50
 Yamaha JOG R 50 2002



COD. 3029.04

Sinistro con leva lucida
 Left with polished lever
 fulcro leva - lever fulcrum mm 24,5
 lunghezza leva - lever length mm 147
 codice leva - lever cod. 3938.61
 Aprilia SCARABEO 50 < 2005,
 SCARABEO 50 4T < 2005,
 SCARABEO 100 4T 2005



COD. 2770.04

Sinistro con registro freno
 Left with brake adjusting screw
 fulcro leva - lever fulcrum mm 24
 lunghezza leva - lever length mm 140
 codice leva - lever cod. 2071.61
 Derbi GPR 50 2001
 Motorhispania RX SUPER RACING
 Peugeot XR6 50 2002/2003
 Rieju RS1 50 2001, RS2 50



COD. 1934.04

Sinistro con levetta choke
 Left with choke lever
 fulcro leva - lever fulcrum mm 24,5
 lunghezza leva - lever length mm 154
 codice leva - lever cod. 0778.63
 Aprilia SCARABEO 50 1993/1996/2003

COD. 2264.04

Sinistro con leva lucida e levetta choke
 Left with polished lever and choke lever
 fulcro leva - lever fulcrum mm 24,5
 lunghezza leva - lever length mm 154
 codice leva - lever cod. 3177.61
 Aprilia SCARABEO 50 1993/1996/2003



COD. 0715.04

Destro - Right
 fulcro leva - lever fulcrum mm 24
 lunghezza leva - lever length mm 154
 codice leva - lever cod. 0810.71

COD. 0738.04

Sinistro - Left
 fulcro leva - lever fulcrum mm 24
 lunghezza leva - lever length mm 154
 codice leva - lever cod. 0811.61



COD. 2426.04

Sinistro con levetta starter
 Left with start lever
 fulcro leva - lever fulcrum mm 24
 lunghezza leva - lever length mm 140
 codice leva - lever cod. 2071.61
 Italjet TORPEDO 50



COD. 2808.04

Destro con registro freno e pulsante stop
 Right with brake adjusting screw
 and stop switch
 fulcro leva - lever fulcrum mm 24
 lunghezza leva - lever length mm 140
 codice leva - lever cod. 2719.71



COD. 1112.04

Sinistro con leva in plastica,
 basetta rettangolare
 Left with plastic lever and rectangular
 emplacement
 fulcro leva - lever fulcrum mm 24
 lunghezza leva - lever length mm 135
 codice leva - lever cod. 0778.63
 Benelli CITY BIKE, S 50/SCOOTY 50,
 SCOOTY 50
 Betamotor ANDY
 Fantic Motor ISSIMO KS 50, JOY MK
 Garelli KATIA, TEAM 3 V 50, TEAM KS 50
 Lem Motor MAX PIEGHEVOLE
 Malaguti DRIBBLING 50
 Rizzato ATALA MASTER LF FIRE 50
 Yamaha YAMY



COD. 1709.06
 Sinistro con 2 leve in plastica,
 bassetta ovale
*Left with 2 plastic levers and oval
 emplacement*
 fulcro leva - lever fulcrum mm 24
 lunghezza leva - lever length mm 135
 codice leva - lever cod. 0778.63



COD. 0186.04
 Sinistro con leva in acciaio
Left with steel lever
 fulcro leva - lever fulcrum mm 24
 lunghezza leva - lever length mm 135
 codice leva - lever cod. 0491.63
 Bimotor CITY

DECOMPRESSORI - DEKOS



COD. 0511.07
 Decompressore in alluminio
 con registro
*Aluminium deko with
 adjusting screw*



COD. 0371.07
 Decompressore in nylon con registro
Nylon deko with adjusting screw

COD. 0362.07
 Decompressore in nylon
Nylon deko

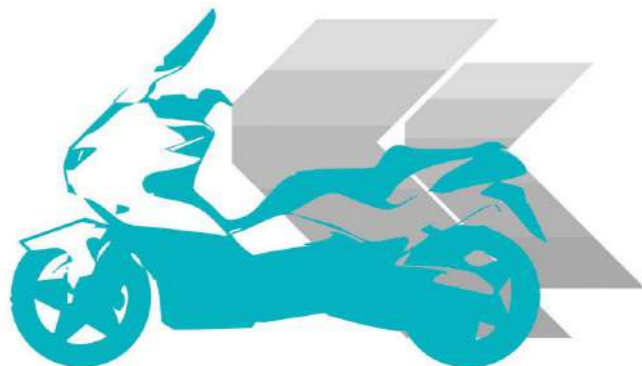

PIAGGIO SCOOTER / CICLOMOTORE - PIAGGIO MOPED



COD. 1671.04
 Sinistro - Left
 fulcro leva - lever fulcrum mm 29
 lunghezza leva - lever length mm 158
 codice leva - lever cod. 2014.61
 Piaggio QUARZ 50, SKIPPER 50,
 SKIPPER 125/150 < 2000,
 ZIP FAST RIDER 50

COD. 2070.04
 Sinistro - Left
 fulcro leva - lever fulcrum mm 29
 lunghezza leva - lever length mm 158
 codice leva - lever cod. 2014.61
 Piaggio ZIP FAST RIDER 50 1995

COD. 2037.04
 Sinistro con leva lucida
Left with polished lever
 fulcro leva - lever fulcrum mm 29
 lunghezza leva - lever length mm 158
 Piaggio ZIP RST 50 1998/1999



COD. 2953.04
 Sinistro con leva lucida
Left with polished lever
 fulcro leva - lever fulcrum mm 29
 lunghezza leva - lever length mm 172
 codice leva - lever cod. 3060.61
 Piaggio FLY 4T 50 < 2006, FLY 4T 100 < 2004,
 FLY 125 2005/2008, FLY 150 < 2005,
 LIBERTY 2T 50 < 2005, LIBERTY 4T 50 < 2005,
 LIBERTY 4T 125 2004/2008,
 LIBERTY 4T 150 < 2008, LIBERTY 4T 200 < 2007,
 LIBERTY ST 200 < 2004, NRG 50 < 2002,
 TYPHOON 50 < 2005, VESPA LX 4T 50 < 2005,
 VESPA 4T 4V 50 < 2008, VESPA LX 4T 50 < 2005,
 VESPA S 2T 50 < 2007, VESPA S-LX 2T 50 < 2005,
 VESPA S-LX 150 < 2005,
 VESPA S 4T 150 < 2008



COD. 2091.04
 Sinistro - Left
 fulcro leva - lever fulcrum mm 29
 lunghezza leva - lever length mm 158
 codice leva - lever cod. 2332.61
 Piaggio TYPHOON 50 1997,
 NRG 50 1997



COD. 1868.04

Sinistro - *Left*
 fulcro leva - *lever fulcrum mm 29*
 lunghezza leva - *lever length mm 158*
 codice leva - *lever cod. 2014.61*
 Gilera STORM 50 > 1997,
 TYPHOON 50 > 1997

COD. 2046.04

Sinistro - *Left*
 fulcro leva - *lever fulcrum mm 29*
 lunghezza leva - *lever length mm 158*
 codice leva - *lever cod. 2014.61*
 Piaggio NTT 50, TYPHOON MARTINI 50,
 TYPHOON STREET 50, NRG 50

COD. 2073.04

Sinistro - *Left*
 fulcro leva - *lever fulcrum mm 29*
 lunghezza leva - *lever length mm 158*
 codice leva - *lever cod. 2014.61*
 Piaggio FREE 50 1998/1999,
 FREE F1 50 1997



COD. 1659.04

Sinistro con leva in alluminio
 pressofuso - grigio scuro
Left with die-cast aluminium lever - dark grey
 fulcro leva - *lever fulcrum mm 24,5*
 lunghezza leva - *lever length mm 154*
 codice leva - *lever cod. 1938.61*
 Piaggio BRAVO 49 1992, SI 49 1992

COD. 1885.04

Sinistro con leva in plastica - nero
Left with plastic lever - black
 fulcro leva - *lever fulcrum mm 24,5*
 lunghezza leva - *lever length mm 149*
 codice leva - *lever cod. 2309.63*
 Piaggio SI 49 1994



COD. 1247.04

Sinistro - *Left*
 fulcro leva - *lever fulcrum mm 24,5*
 lunghezza leva - *lever length mm 154*
 codice leva - *lever cod. 1291.61*
 Gilera TREND 50
 Piaggio CIAO 49 1989/1992,
 SI 49 1990/1991



COD. 0664.06

Sinistro - *Left*
 fulcro leva - *lever fulcrum mm 24*
 lunghezza leva - *lever length mm 136*
 codice leva - *lever cod. 0798.63*
 Piaggio BOXER 49, BRAVO 49,
 CIAO 49 > 1988, SI 49 > 1988



COD. 0220.06

Sinistro con leve in acciaio
Left with steel levers
 fulcro leva - *lever fulcrum mm 24*
 lunghezza leva - *lever length mm 135*
 codice leva - *lever cod. 0491.63*
 Piaggio CIAO SC



COD. 2760.04

Sinistro - *Left*
 fulcro leva - *lever fulcrum mm 29*
 lunghezza leva - *lever length mm 158*
 codice leva - *lever cod. 2938.61*
 Piaggio LIBERTY 50, VESPA ET2 50 < 1997,
 VESPA ET4 125 < 1996



ACCESSORI - ACCESSORIES



COD. 97.1662
Bussola con rondella
Sleeve with washer



COD. 0967.02.381
Leva decompressore in
resina
Resin deko lever



COD. 0101.02.002
Nottolino - Nipple



COD. 2268.02.3180
Leva choke - Choke lever



COD. 0291.02.363
Nottolino per leva cross
Cross lever nipple



COD. 0800.02.693
Molla per leva nylon
Nylon lever spring



COD. 0618.02.725
Nottolino per leva nylon
Nylon lever nipple



COD. 1388.02.1568
Molla per leva
Spring lever
per - for Vespa/Cosa



COD. 0110.02.073
Regolatore M5
M5 adjusting screw



COD. 0403.91
Gruppo vite fissaggio
leva freno e frizione
Brake and clutch lever
tightening screw



COD. 0152.02.028
Regolatore M8
M8 adjusting screw



COD. 2218.20
Interruttore stop
normalmente chiuso
Stop switch normally
closed



COD. 0270.02.258
Regolatore M6
M6 adjusting screw



COD.3151.20
Interruttore stop
normalmente chiuso
(microswitch)
Stop switch normally
closed (microswitch)



COD. 0922.02.910
Regolatore M6
M6 adjusting screw

GOMMINI - RUBBER CAPS



COD. 0077.02.4197
Soffietto per pulsante
interruttore stop
Stop switch cap



COD. 0619.02.697
Leva decompressore
in resina
Resin deko lever



LEVE RICAMBIO SPARE LEVERS

Scooter

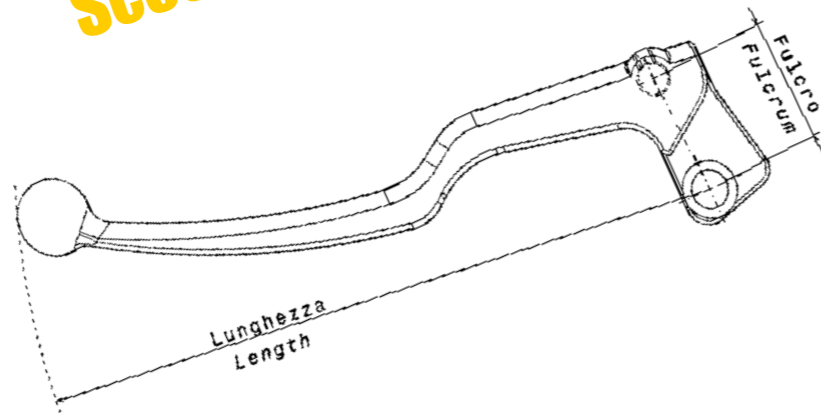

SCOOTER CICLOMOTORE - MOPED LEVE IN ALLUMINIO PRESSOFUSO - DIE-CAST ALUMINIUM LEVERS



COD. 0811.61

Leva freno sinistra con impronte
Left brake lever with finger rest
fulcro - fulcrum mm 24
lunghezza - length mm 154
codice portaleva - lever assembly
cod. 0738.04 - 0754.04
Betamotor FOUR XP
Garelli SUPER VIP, SUPER VIP 4, VIP 3
Malaguti FIFTY HF 50
Peugeot 103 SPX 50
Tunturi HOPPER

COD. 0810.71

Leva freno destra con impronte
Right brake lever with finger rest
fulcro - fulcrum mm 24
lunghezza - length mm 154
codice portaleva - lever assembly cod. 0715.04
Betamotor FOUR XP
Garelli SUPER VIP, SUPER VIP 4, VIP 3
Malaguti FIFTY HF 50
Peugeot 103 SPX 50
Tunturi HOPPER



COD. 2076.61

Leva freno sinistra
Left brake lever
fulcro - fulcrum mm 24
lunghezza - length mm 140
codice portaleva - lever assembly cod. 1699.04
Derbi VAMOS, ATLANTIS 50
Piaggio DIESIS 50/100
Rizzato SCOOTER VAMOS 50



COD. 2719.71

Leva freno destra lucida
Polished right brake lever
fulcro - fulcrum mm 24 - lunghezza - length mm 140
codice comando gas - throttle control
cod. 2106.03 - 3379.03
codice portaleva - lever assembly
cod. 2808.04
Derbi URBAN, VARIANT 1997

COD. 2071.61

Leva freno sinistra nera
Black left brake lever
fulcro - fulcrum mm 24, 5
lunghezza - length mm 140
codice portaleva - lever assembly
cod. 2104.04 - 2240.04 - 2348.04 -
2426.04 - 2690.04 - 2728.04 -
2770.04 - 3027.04
Betamotor CRONO/QUADRA, TEMPO 50
Cagiva CORSA 50, PROGRESS 50
Derbi AVENTURA, FENIX, HUNTER,
HUNTER/PADDOK, URBAN,
VARIANT 1997, GPR 50 2001,
SENDA R DRD - X-TREM - RACER 50,
SENDA SR 125 4T - SM - R 2006,
X-RACE - 50SM 2006, XTREM 50R - 50M 2006
Gilera RCR - SMT 50 2003

Italjet TORPEDO 50
Ktm GO 50, CHRONO 125
Mbk BOOSTER R 50 2004, MACH G 50,
STUNT 50
Motorhispania BLACK LINE 2006,
RX SUPER RACING, RYZ PRO RACING 2006,
URBAN BIKE 2006
Peugeot 50 XP6 2003, 50 XR6 2002, 50 XR6 2003
Rieju ENDURO SMX - SMX PRO 2006,
MRX - MRX PRO 2006, RR 2006,
SMX/MRX > 2006, SPIKE 2006, RS1 50,
RS1 50 2001, RS2 50
Rizzato HACKER 50
Yamaha JOG R 2002, SLIDER 50



COD. 2515.61

Leva freno sinistra nera - Black left brake lever
fulcro - fulcrum mm 24 - lunghezza - length mm 135
codice portaleva - lever assembly
cod. 1942.04 - 1954.04
Mbk BOOSTER R SPIRIT 50, FIZZ 50, FORTE 50
Yamaha AXIS 50

COD. 3402.61

Leva freno sinistra lucida con puntolino stop
Polished left brake lever with stop pin
fulcro - fulcrum mm 23
lunghezza - length mm 136
Mbk FLIPPER 50
Yamaha WHY 50



COD. 0976.61

Leva frizione nera
 Black clutch lever
 fulcro - fulcrum mm 28,5
 lunghezza - length mm 159
 codice portaleva - lever assembly cod.
 2980.04

Aprilia PEGASO 50, RS EXTREMA 50, RX 50,
 RX 50 1995/1996, TUAREG RALLY 50, AF1 50
 Betamotor BAD, FOUR AE, FOUR TWIN,
 SUPERMOTARD, KR 50, MX 50, RK6 50,
 RR 50 2000, RR RACING 50 2001,
 KR 7 AFRICA 125/250
 Bultaco LOBITO 50
 Cagiva PRIMA
 Derbi FDS SAVANNAH, GPR 50 > 1999, SENDA 50,
 SENDA R 50, SENDA SUPER MOT. 125,
 Fantic Motor FAST, KOALA, OASIS,
 CABALLERO RS/RC 50 2006 >
 Garelli FORMUNO RAID, SAHEL 50 ES., SUPER
 CICLONE, URKA,
 Gilera RC/SIOUX 50, BULLIT 50, CANNIBAL 50,
 GSM 50, H@K 50, 503

Lem Motor CONTACT, ENDURO XR,
 FORMULA T4
 Malaguti ENDURO DUNE ES / KS, ENDURO MRX,
 RST AE / SPECIAL 50
 Montesa EVASION 310
 Motorhispania FURIA CROSS, FURIA SUPERMOTO
 Motron COMPACT RZ1, COMPACT tutti i tipi,
 GL4, GTO - GTO FLASH, OREGON, RANGER,
 XLE
 Peripoli OXFORD HIT, OXFORD HR, OXFORD RED
 Peugeot XP6 50 2000
 Rieju DRAC/SUPERMOT, RR/SPIKE 50
 Rizzato ATALA MASTER HYDRO 50,
 ATALA MASTER TRE LD 50
 Suzuki RMX 50
 Tunturi TIGER AQUA



COD. 2896.71

Leva freno destra
 Right brake lever
 fulcro - fulcrum mm 25
 lunghezza - length mm 150
 Mbk BOOSTER R SPIRIT 50, FIZZ 50,
 FORTE 50
 Yamaha AXIS 50



COD. 3177.61

Leva freno sinistra - Left brake lever
 fulcro - fulcrum mm 24,5
 lunghezza - length mm 154
 codice portaleva - lever assembly
 cod. 2264.04 - 2699.04
 Aprilia SCARABEO 50 2003,
 SCARABEO 100 2000/2004



COD. 3390.61

Leva freno sinistra - Left brake lever
 fulcro - fulcrum mm 23
 lunghezza - length mm 146
 codice portaleva - lever assembly cod.
 2924.04
 Mbk SKYLINER 125 2000
 Yamaha MAJESTY 125 1998/2008



COD. 3749.61

Leva freno sinistra - Left brake lever
 fulcro - fulcrum mm 24,5
 lunghezza - length mm 147
 Peugeot ELISEO 50,
 ELISEO 100/125 < 1998,
 SPEEDFIGHT 50 2003

COD. 3883.61

Leva freno sinistra senza puntolino stop
 Left brake lever without stop pin
 fulcro - fulcrum mm 24,5
 lunghezza - length mm 147
 codice portaleva - lever assembly cod. 2954.04



COD. 0200.61

Leva sinistra - Left lever
 fulcro leva - lever fulcrum mm 22
 lunghezza leva - lever length mm 182
 Yamaha XP 530 T-MAX > 2012, XP 530
 T-MAX ABS > 2012, XP 500 T-MAX ABS
 2008/2011, XP 500 T-MAX 2008/2011,
 YP MAJESTY ABS 400 > 2009, YP MAJESTY
 400 > 2009



COD. 0201.71

Leva destra - Right lever
 fulcro leva - lever fulcrum mm 22
 lunghezza leva - lever length mm 182
 Yamaha XP 530 T-MAX > 2012, XP 530
 T-MAX ABS > 2012, XP 500 T-MAX ABS
 2008/2011, XP 500 T-MAX 2008/2011,
 YP MAJESTY ABS 400 > 2009, YP MAJESTY
 400 > 2009



COD. 0202.61

Leva sinistra - Left lever
 fulcro leva - lever fulcrum mm 22
 lunghezza leva - lever length mm 169
 Yamaha VP X-CITY 125 > 2008, VP X-CITY
 250 > 2007, YP R BLACK X-MAX 250 >
 2009, YP R X-MAX 125 ABS BUSINESS >
 2010, YP R X-MAX 125 ABS > 2010, YP
 R X-MAX 125 > 2006, YP R X-MAX 250
 SPORT > 2010, YP R X-MAX 250 > 2005

COD. 0203.71

Leva destra - Right lever
 fulcro leva - lever fulcrum mm 22
 lunghezza leva - lever length mm 169
 Yamaha VP X-CITY 125 > 2008, VP X-CITY 250 > 2007, YP R BLACK X-MAX 250 > 2009, YP R X-MAX 125 ABS BUSINESS > 2010, YP R X-MAX 125 ABS > 2010, YP R X-MAX 125 > 2006, YP R X-MAX 250 SPORT > 2010, YP R X-MAX 250 > 2005



COD. 0204.61

Leva sinistra - Left lever
 fulcro leva - lever fulcrum mm 24,5
 lunghezza leva - lever length mm 174
 Honda SH 300 ABS > 2007, SH 300 > 2007, SH SCOOPY 125I SPORT > 2010, SH SCOOPY 125I TOPBOX > 2010, SH SCOOPY 125I > 2009, SH SCOOPY 150I SPORT > 2010, SH SCOOPY 150I TOPBOX > 2010, SH SCOOPY 150I > 2009



COD. 0205.71

Leva destra - Right lever
 fulcro leva - lever fulcrum mm 25
 lunghezza leva - lever length mm 175
 Honda SH 300 ABS 2007, SH 300 2007, SH SCOOPY 125I SPORT 2010, SH SCOOPY 125I TOPBOX 2010, SH SCOOPY 125I 2009, SH SCOOPY 150I 2009/2012



COD. 0206.61

Leva sinistra - Left lever
 fulcro leva - lever fulcrum mm 25
 lunghezza leva - lever length mm 186
 Yamaha XP 500 T-MAX ABS 2005/2007, XP 500 T-MAX 2001/2007, YP MAJESTY ABS 400 2007/2008, YP MAJESTY 400 2004/2008



COD. 0207.71

Leva destra - Right lever
 fulcro leva - lever fulcrum mm 25,5
 lunghezza leva - lever length mm 185
 Yamaha XP 500 T-MAX ABS 2005/2007, XP 500 T-MAX 2001/2007, YP MAJESTY ABS 400 2007/2008, YP MAJESTY 400 2004/2008



LEVE IN RESINA ACETALICA - ACETAL RESIN LEVERS



COD. 0779.73

Leva freno destra - Right brake lever
 fulcro - fulcrum mm 24
 lunghezza - length mm 136
 codice comando gas - throttle control cod. 0996.03 - 1712.03 - 1682.03 - 1271.03 - 1290.03 - 1496.03
 Benelli CITY BIKE, COSI' MX, E3, G 2 ELLE LASER, S 50/SCOOTY, SCOOTY 50
 Betamotor ANDY
 Derbi VARIANT SPORT R, DS 50 START
 Di Blasi VARIANT SPORT W.CH/BOX/CLASSIC
 Fantic Motor ISSIMO 3V RAIDER, ISSIMO KS, JOY MK
 Garelli BASIC 1/2, GARY 1/2, KATIA, TEAM 3 V, TEAM KS, VELOMOSQUITO
 Lem Motor MALIBU', MAX PIEGHEVOLE
 Malaguti DRIBBLING 50
 Mbk BOOSTER 50
 Motron TAXI
 Peripoli VAI
 Rizzato ATALA GIRL 50, ATALA GREEN 50
 ATALA IDEA LL 50, ATALA MASTER HYDRO 50, ATALA MASTER LF FIRE 50, ATALA MASTER LL 50, ATALAUNO RK SL 50, CALIFFONE PIU' / SC 50
 Suzuki MAXI - Yamaha YAMY

COD. 0778.63

Leva sinistra - Left lever
 fulcro - fulcrum mm 24
 lunghezza - length mm 135
 codice portaleva - lever assembly cod. 0859.04 - 0863.04 - 0926.06 - 1112.04 - 1497.04 - 1709.06 - 1710.06 - 1740.04
 Benelli CITY BIKE, COSI' MX, E3, G 2 ELLE LASER, S 50/SCOOTY, SCOOTY 50
 Betamotor ANDY
 Derbi VARIANT SPORT R, DS 50 START
 Di Blasi VARIANT SPORT W.CH/BOX/CLASSIC
 Fantic Motor ISSIMO KS, ISSIMO 3V RAIDER, JOY MK
 Garelli BASIC 1/2, GARY 1/2, KATIA, TEAM 3 V, TEAM KS, VELOMOSQUITO
 Lem Motor MALIBU', MAX PIEGHEVOLE
 Malaguti DRIBBLING 50
 Mbk BOOSTER 50, EVOLIS 50
 Motron TAXI
 Peripoli VAI
 Rizzato ATALA GIRL 50, ATALA GREEN 50
 ATALA IDEA LL 50, ATALA MASTER LF FIRE 50, ATALA MASTER LL 50, ATALAUNO RK SL 50, CALIFFONE PIU' / SC 50
 Suzuki MAXI
 Yamaha YAMY, BREEZE 50

LEVE IN ACCIAIO - STEEL LEVERS



COD. 0491.63

Leva sinistra - Left lever
 fulcro - fulcrum mm 24
 lunghezza - length mm 135
 codice comando gas - throttle control cod. 0181.03
 codice portaleva - lever assembly cod. 0186.04 - 0220.06 - 0330.06
 Betamotor TRASPORTO
 Bimotor CIAK 3 KS, CITY, V 1 T KS
 Piaggio CIAO SC 49

PIAGGIO SCOOTER / CICLOMOTORE - PIAGGIO MOPED
LEVE IN ALLUMINIO PRESSOFUSO - DIE-CAST ALUMINIUM LEVERS



COD. 1292.71
 Leva freno destra con impronte
Right brake lever with finger rest
 fulcro - fulcrum mm 24,5
 lunghezza - length mm 154
 codice comando gas - throttle control cod. 1242.03
 Gilera TREND 50
 Piaggio CIAO 49 1989/1992,
 SI 49 1990/1991

COD. 1291.61
 Leva freno sinistra con impronte
Left brake lever with finger rest
 fulcro - fulcrum mm 24,5
 lunghezza - length mm 154
 codice portaleva - lever assembly cod. 1247.04 - 1299.06
 Gilera TREND 50
 Piaggio CIAO 49 1989/1992,
 SI 49 1990/1991



COD. 1357.61
 Leva freno sinistra
Left brake lever
 fulcro - fulcrum mm 24,5
 lunghezza - length mm 154
 codice portaleva - lever assembly cod. 1587.04
 Aprilia AMICO SPORT/LK/LX/GL/GLE 50,
 AMICO YOUNGER 50, SR REPLICA/URBAN
 KID/VIPER 50
 Peugeot BUXY 50, SPEEDAKE 50, SQUAB 50,
 SV 50, TREKKER 50, VIVACITY 50, X-FIGHT 50,
 ZENIT 50, TREKKER 100 < 1998,
 VIVACITY 100 < 1998, SV 125 < 1993

COD. 1353.71
 Leva freno destra
Right brake lever
 fulcro - fulcrum mm 24,5
 lunghezza - length mm 154
 codice portaleva - lever assembly cod. 1588.04



COD. 1689.71
 Leva freno destra grigio scuro
Dark grey right brake lever
 fulcro - fulcrum mm 19,5
 lunghezza - length mm 154
 Piaggio VESPA FL2 50 < 1990,
 VESPA FL2 AUTOMATICA 50 < 1990,
 VESPA FL2 125 < 1991



COD. 3060.61
 Leva freno sinistra lucida
Polished left brake lever
 fulcro - fulcrum mm 29
 lunghezza - length mm 172
 codice portaleva - lever assembly cod. 2953.04 - 2536.04
 Gilera RUNNER SP-ST 50 < 2005,
 RUNNER 4T 125/180



COD. 2332.61
 Leva freno sinistra
Left brake lever
 fulcro - fulcrum mm 29
 lunghezza - length mm 158
 codice comando gas - throttle control cod. 2091.04
 Gilera TYPHOON 50 1997
 Piaggio NRG 50 1997

COD. 2327.71
 Leva freno destra
Right brake lever - fulcro - fulcrum mm 23,5 - lunghezza - length mm 154
 codice comando gas - throttle control cod. 2151.03
 Gilera TYPHOON 50 1997 - Piaggio NRG 50 1997



COD. 3602.61
 Leva frizione
Clutch lever
 fulcro - fulcrum mm 30
 lunghezza - length mm 184
 codice portaleva - lever assembly cod. 2587.04
 Aprilia HABANA CUSTOM 50/125



COD. 2014.61
 Leva freno sinistra
Left brake lever
 fulcro - fulcrum mm 29
 lunghezza - length mm 158
 codice portaleva - lever assembly cod. 1671.04 - 1868.04 - 2046.04 - 2070.04 - 2073.04
 Gilera TYPHOON 50 > 1997,
 STORM 50 > 1997, TYPHOON MARTINI 50,
 TYPHOON STREET 50
 Piaggio FREE F1 50 1997 - 1998 - 1999,
 NRG 50, NTT 50, QUARZ 50, ZIP FAST RIDER 50,
 SKIPPER 50, SKIPPER 125/150 < 2000

COD. 1935.71
 Leva freno destra grigio scuro
Dark grey right brake lever
 fulcro - fulcrum mm 24,5
 lunghezza - length mm 154
 Piaggio BRAVO 49 1992, SI 49 1992

COD. 1938.61
 Leva freno sinistra grigio scuro
Dark grey left brake lever
 fulcro - fulcrum mm 24,5
 lunghezza - length mm 154
 codice portaleva - lever assembly cod. 1659.04 - 1661.04
 Piaggio BRAVO 49 1992, SI 49 1992





COD. 0208.79

Leva destra/sinistra - Right/left lever
 fulcro leva - lever fulcrum mm 22
 lunghezza leva - lever length mm 172
 Piaggio BEVERLY (BREMBO) 125 2007,
 BEVERLY (BREMBO) 250/400 2006/2007,
 BEVERLY (BREMBO) 500 2005/2007,
 BEVERLY (HENG TONG) 400 2006/2007,
 500 2005/2007,
 BEVERLY SPORT (BREMBO) 125 2007, 250
 2006, BEVERLY TOURER 300I.E. 2009,
 BEVERLY TOURER 125/250/400 2008,
 BEVERLY 500 2002/2004,
 Yamaha MAJESTY 180, YP MAJESTY 125,
 YP MAJESTY 150



COD. 0211.79

Leva destra/sinistra - Right/left lever
 fulcro - fulcrum mm 23,5
 lunghezza - length mm 155
 LML STAR 125, 150, 200,
 Piaggio VESPA PX 30 ANNI 125 2007 -
 2008, VESPA PX EURO2 125 2001 - 2007,
 VESPA PX T5 125 1985 - 1989, VESPA PX
 125 1998 - 2001, VESPA PX 125/150
 2011/2013, VESPA PXE ARCOBALENO
 125 1981 - 1997

LEVE IN RESINA ACETALICA - ACETAL RESIN LEVERS



COD. 0209.79

Leva destra/sinistra - Right/left lever
 fulcro leva - lever fulcrum mm 23
 lunghezza leva - lever length mm 173
 Piaggio BEVERLY (HENG TONG) 125 2007,
 BEVERLY (HENG TONG) 200 2006/2007,
 BEVERLY (HENG TONG) 400 2006/2007,
 BEVERLY (HENG TONG) 500 2005/2007,
 BEVERLY 125EI/300IE < 2010, BEVERLY
 RST (HENG TONG) 125 2006, BEVERLY
 RST (HENG TONG) 250 2004/2005,
 BEVERLY RST 125 2004/2005, BEVERLY
 SPORT (BREMBO) 125 2007, BEVERLY
 SPORT (HENG TONG) 125/250, BEVERLY
 TOURER 300I.E. 2009, BEVERLY TOURER
 125/250/400 < 2008



COD. 0798.63

Leva freno sinistra - Left brake lever
 fulcro - fulcrum mm 24
 lunghezza - length mm 136
 codice portaleva - lever assembly
 cod. 0664.06 - 1399.06
 Moto Vespa DELTA
 Piaggio BRAVO 49, CIAO 49 > 1988,
 SI 49 > 1988

COD. 0799.73

Leva freno destra - Right brake lever
 fulcro - fulcrum mm 24 - lunghezza - length mm 136
 codice comando gas - throttle control cod. 0663.03
 Moto Vespa DELTA
 Piaggio BRAVO 49, CIAO 49 > 1988, SI 49 > 1988, BOXER 49



COD. 2306.73

Leva destra grigia - Grey right lever
 fulcro - fulcrum mm 24,5 - lunghezza - length mm 149
 codice comando gas - throttle control cod. 1823.03
 Piaggio FL3 SI 50

COD. 2307.63

Leva sinistra grigia - Grey left lever
 fulcro - fulcrum mm 24,5 - lunghezza - length mm 149
 codice portaleva - lever assembly cod. 1824.04
 Piaggio FL3 SI 50

COD. 2309.63

Leva sinistra nera - Black left lever
 fulcro - fulcrum mm 24,5 - lunghezza - length mm 149
 codice portaleva - lever assembly cod. 1885.04
 Piaggio FL3 SI 50

COD. 2308.73

Leva destra nera - Black right lever
 fulcro - fulcrum mm 24,5 - lunghezza - length mm 149
 codice portaleva - lever assembly cod. 1885.04
 Piaggio FL3 SI 50



COD. 0210.79

Leva destra/sinistra - Right/left lever
 fulcro leva - lever fulcrum mm 20
 lunghezza leva - lever length mm 164
 Piaggio 50, LIBERTY 2T SPORT 50
 2006/2007, LIBERTY 4T (GRIMECA)
 125 2006/2009, LIBERTY 4T (HENG
 TONG) 200 2006, LIBERTY 4T RST
 (GRIMECA) 50 2006/2008, LIBERTY
 4T RST PTT 125 2005/2006, LIBERTY
 4T RST SPORT (GRIMECA) 50
 2006/2008, LIBERTY 4T SPORT 125
 2006/2009
 NRG POWER DT (GRIMECA) 50
 2005/2008, VESPA GTS ABS 250 2005
 >, VESPA LX (GRIMECA) 125 2005/2009,
 VESPA LX (GRIMECA) 150 2006/2007



COD. 2131.63

Leva freno sinistra - Left brake lever
 fulcro - fulcrum mm 29
 lunghezza - length mm 144
 codice portaleva - lever assembly
 cod. 2034.04 - 2066.04
 Piaggio FREE 50, FREE FCS 2T 50 1996,
 ZIP 50

COD. 2133.73

Leva freno destra - Right brake lever
 fulcro - fulcrum mm 23,5 - lunghezza - length mm 140
 codice comando gas - throttle control cod. 2069.03
 Piaggio FREE 50, ZIP 50

DISPOSITIVI ELETTRICI ELECTRIC SWITCHES Scooter

DISPOSITIVI ELETTRICI CON CABLAGGIO - ELECTRIC SWITCHES WITH WIRING - 9B



COD. 0214AB.9B
Funzioni: clacson,
con connettore
*Functions: clacson,
with connector*



COD. 0250AB.9B
Funzioni:
arresto motore,
con connettore
*Functions: engine
stop, with connector*



COD. 0254AB.9B
Funzioni:
avviamento motore,
con connettore
*Functions: engine
start, with connector*



COD. 0271AB.9B
Funzioni: mode
computer, con
connettore
*Functions: mode
computer, with
connector*

DISPOSITIVI ELETTRICI CON CABLAGGIO - ELECTRIC SWITCHES WITH WIRING - 2B



COD. 0051AA.2B
Sinistro
Funzioni: clacson, deviatore luci abbagliante/anabbagliante,
indicatori di direzione, con connettore
*Left
Functions: horn, high/low, turn, with connector*

INTERRUTTORI STOP - STOP SWITCHES



COD. 2806.20
Interruttore stop
normalmente aperto
Stop switch normally open



COD. 2218.20
Interruttore stop
normalmente chiuso
Stop switch normally closed

COD. 2489.20
Interruttore stop
normalmente chiuso
(inserimento a scatto)
*Stop switch normally
closed - (trigger action)*



COD. 3151.20
Interruttore stop
normalmente chiuso
(microswitch)
*Stop switch normally
closed (microswitch)*

ACCESSORI - ACCESSORIES

Calotte posteriori per dispositivi sinistri serie 2A-8A - *Rear cases for left switches series 2A-8A*



COD. 2124.04
Universale con levetta choke
Universal with choke lever

COD. 2112.04
Universale senza levetta choke
Universal without choke lever

COD. 2718.04
Con cavallotto di fissaggio
*With fixing clamp
per - for scooter YAMAHA, MBK*

Calotte posteriori per dispositivi sinistri serie 2B - *Rear cases for left switches series 2B*



COD. 97.4522

