

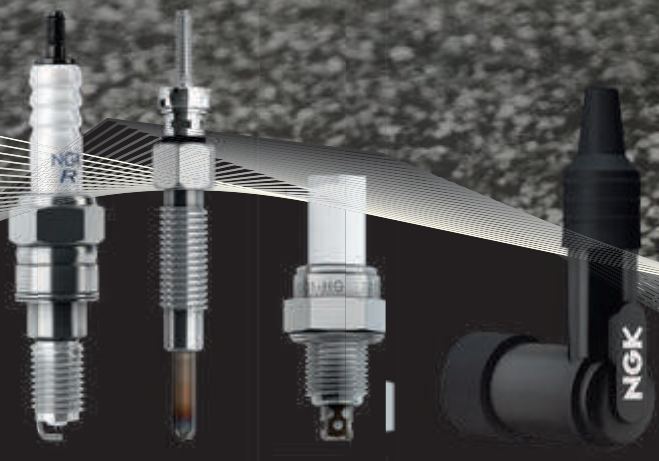

-
-
-
-



2016 - 2017



IGNITION
PARTS



VEHICLE
ELECTRONICS

NGK | NTK

ON *YOUTUBE*



KNOW HOW & KNOW WHERE:
// NGK | NTK ON YOUTUBE

Visit our YouTube channel for any relevant information about our products as well as practical tips and tricks around installation. Everything in one place – available in many different languages.

Find our YouTube channel here:
[youtube.com/NGKsparkplugEurope](https://www.youtube.com/NGKsparkplugEurope)























Or scan the QR code with your mobile device to be redirected to the channel.



IGNITION
PARTS



VEHICLE
ELECTRONICS

 	_____	i 2 – 27
  	_____	i 28 – 40
Racing 	_____	1 – 11
Series 	_____	12 – 23
 → <i>IRIDIUM IX</i> / <i>IRIDIUM IX</i> → 	_____	24
Info 	_____	25 – 28
 	_____	29 – 139
 	_____	140 – 162
 	_____	163 – 166
 	_____	167 – 209
	_____	210 – 224
 λ	_____	225 – 231
Cross   → NGK	_____	232 – 320
Discontinued Spark Plugs	_____	321 – 326

Symbols used on spark plugs

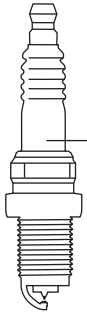

B P R 5 E S - 11

Unit : mm

B			P		R		5		E		S		-11		
	Thread size	Hex size	Structure		Resistor		Heat rating		Thread length		Design features		Spark gap		
A	∅ 18.0	Hex 25.4	P	Projected insulator type	R	Resistor	2	<p>Hot type</p> <p>Cold type</p>	E	19.0	B	Integral terminal (CR8EB)	None	Motorcycle :	0.7~0.8
B	∅ 14.0	Hex 20.8			Z	Inductive resistor type	4		EH	17.5	CM	Slant ground electrode Compact type (Exposed insulator length: 18.5)		Car :	0.8~0.9
BC	∅ 14.0	Hex 16.0	M	Small spark plug		5	EH			19.0 half-thread	CS	Slant ground electrode	-8	0.8	
BK	∅ 14.0	Hex 16.0				U			Surface gap, Semi-surface discharge gap or Supplementary gap			6	H	12.7	G,GV
C	∅ 10.0	Hex 16.0	8				7				L	11.2		I	
D	∅ 12.0	Hex 18.0				9				8		None	Tapered seat type A(P)-F : 10.9 B(P)-F : 11.2 BM(P)-F : 7.8		IX
DC	∅ 12.0	Hex 16.0	10							9	Small type plug B(P)M- : 9.5 B-LM : 9.5 CM- : 9.5 CM-6 : 8.6 C-50 : 8.5			J	
E	∅ 8.0	Hex 13.0								10		K	2-ground-electrodes		-15
*Exception B(P)M-A, Y : ∅ 14.0, Hex 19.0 P(P)-(E)F : ∅ 14.0, Hex 16.0 CM-6 : ∅ 10.0, Hex 14.0 BC : Old JIS standard size The length from gasket circuit to terminal contact is 53.0mm. BK : ISO / JIS standard size The length from gasket circuit to terminal contact is 50.5mm.															
											-LM	Compact type (Insulator length: 14.5)			
											N	Special ground electrode	-S	Special gasket	
											P	Platinum spark plug Single ground electrode : Double platinum	-E	Special resistance	
													IX-P	Iridium MAX plug	
												Multi-ground electrode : Single platinum in central electrode	LPG 1-8	LaserLine spark plug range for gas engine use	
													Q	4-ground-electrodes	
											S	Standard type			
											T	3-ground-electrodes			
											U	Semi-surface discharge gap			
											Y	V-grooved center electrode			
											Z	Special design			

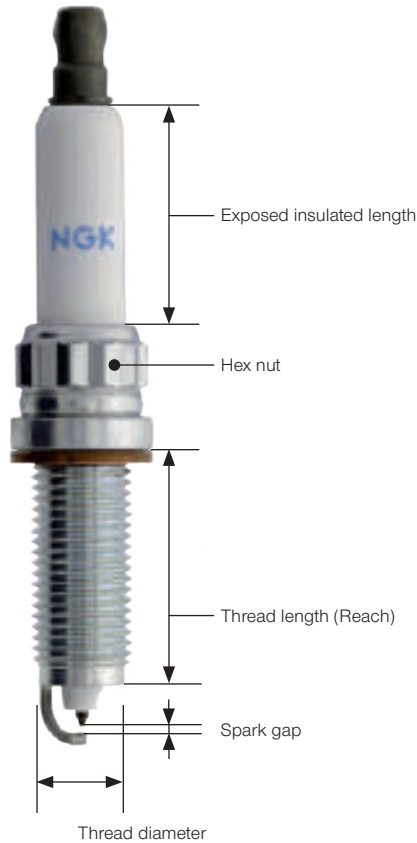

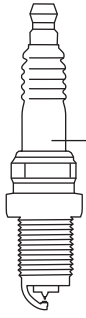

Symbols used on spark plugs



P F R 5 A - 11

Unit : mm

P		F				R		5		A		-11							
Plug type		Thread diameter	Thread length	Seat configuration	Hex size	Resistor		Heat rating		Design		Spark gap							
DI	High ignitability plug: Double fine electrodes	F	φ 14.0	19.0	Gasket	Hex 16.0	R	Resistor	2	Hot type	A,B,C... Suffix code		None	Motorcycle : 0.7~0.8					
		FE	φ 14.0	19.0	Gasket	Hex 16.0			4		Car : 0.8~0.9								
I	Double iridium spark plug	G	φ 14.0	19.0	Gasket	Hex 20.8			5		Cold type	I	Iridium central electrode	-7	0.7				
L	Long thread reach plug	J	φ 12.0	19.0	Gasket	Hex 18.0			6				-9	0.9					
P	Double platinum spark plug	K	φ 12.0	19.0	Gasket	Hex 16.0			7				-10	1.0					
S	High ignitability plug : thin square tip type	KA	φ 12.0	19.0	Gasket	Hex 14.0			8				-11	1.1					
Z	Projected firing end								KB				φ 12.0	19.0	Gasket	Bi-Hex 14.0 (Bi-hexagonal *)	9	-13	1.3
Above alphabets are occasionally used in combination <Example>ILFR..., PLZFR..., When „L“ is included, priority is given to „L“ (long reach)* in thread length. <Example> *Gasket type FR5AP : Thread length 19.0mm ↓ LFR5AP-11 : Thread length 26.5mm *Tapered seat type PTR5C-13 : Thread length 17.5mm ↓ PLTR6A-10G : Thread length 25.0mm		KE	φ 12.0	19.0	Gasket	Hex 16.0			10				-15	1.5	P		Platinum central electrode	-15	1.5
		KF	φ 12.0	19.0	Gasket	Hex 14.0			*When there is „I“ or „P“ at the beginning of part number („I“ or „P“ after heat rating becomes suffix code.) <Example> IZFR6P8 is Iridium spark plug I : Iridium P : Suffix code * <Exception> ZFR6P-G is nickel spark plug				*Non gasket		-A	Non gasket			
		KG	φ 12.0	19.0	Gasket	Bi-Hex 14.0 (Bi-hexagonal *)							*Metal shell : nickel plating		-D	Metal shell : nickel plating			
		L	φ 10.0	12.7	Gasket	Hex 16.0	*Special resistance						-E	Special resistance					
		M	φ 10.0	19.0	Gasket	Hex 16.0	*Copper cored ground electrode						-G	Copper cored ground electrode					
		MA	φ 10.0	19.0	Gasket	Hex 14.0	*Special thread shape				-H	Special thread shape							
		MF	φ 10.0	19.0	Gasket	Hex 14.0	*2 ground-electrode				-J	2 ground-electrode							
		NA	φ 12.0	17.5	Tapered seat	Hex 14.0	*Vibration-resistance ground electrode				-K	Vibration-resistance ground electrode							
		T	φ 14.0	17.5	Tapered seat	Hex 16.0	*Special ground electrode				-N	Special ground electrode							
		U	φ 14.0	11.2	Tapered seat	Hex 16.0	*4-ground-electrode				-Q	4-ground-electrode							
W	φ 18.0	10.9	Tapered seat	Hex 20.8	*Special gasket		-S	Special gasket											
X	φ 14.0	9.5	Gasket	Hex 20.8	*3-ground-electrode		-T	3-ground-electrode											
Y	φ 14.0	11.2	Tapered seat	Hex 16.0	*Semi-surface discharge type		-U	Semi-surface discharge type											
*Exception TR5A-10, TR5A-13, TR5B-13, TR6B-10, TR6B-13, PTR5A-10, PTR5A-13 : Thread length 25.0mm *Bi-hexagonal socket is necessary. *FE, KE, KF, KG, MF : Longer exposed insulator length type					Bi-hexagonal  Hexagonal 		IX-P		Iridium IX spark plug	-13	1.3								
								LPG 1-8		LaserLine spark plugs range for gas engines									

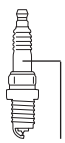

RE 7 C - L

RE		7		C		-L			
Plug type		Heat rating		Design		Spark gap			
RE	Plug for rotary engines	5	Hot type	A,B,C...-Suffix code		-L		Leading side	
SD	Plug for rotary engines (Semi-surface discharge gap)	6		Cold type			-T		Trailing side
		7							
		8							
		9							
		10							
11									

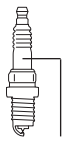

HB 6 A IX - 11 P

HB		6		A				IX		-11		P	
Plug type		Heat rating		Thread diameter	Thread length	Seat configuration	Hex size			Spark gap			
HB	HYBD (3-ground-electrode hybrid type)	4	Hot type	A	φ 14.0	20.5	Gasket	Hex 16.0	IX		-8	0.8	
		5		B	φ 14.0	19.0	Gasket	Hex 16.0			-9	0.9	
		6		-10	1.0								
		7		-11	1.1								
		8	Cold type			-13	1.3						

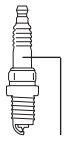

DF 6 H - 11 A

DF		6		H				-11		A			
Plug type		Heat rating		Thread diameter	Thread length	Seat configuration	Hex size			Spark gap			
DF	High ignitability plug (Double fine electrodes)	4	Hot type	A	φ 14.0	19.0	Gasket	Hex 16.0			-8	0.8	A,B,C... Suffix code
		5		B	φ 14.0	26.5	Gasket	Hex 16.0			-9	0.9	
DFH	High ignitability plug (DF + Hybrid type)	6		C	φ 12.0	26.5	Gasket	Hex 14.0			-10	1.0	
		7		*DF6H-11A : Thread length 28.0mm		-11	1.1						
		8	-13	1.3									
		9	Cold type			-15	1.5						

Markierungszeichen Zündkerzen

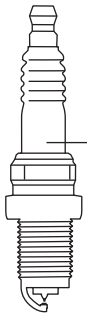

B P R 5 E S - 11

Einheit: mm

B		P		R		5		E		S		-11		
Gewindedurchmesser	Sechskant	Struktur		Entstörwiderstand		Wärmewert		Gewindelänge		Konstruktionsmerkmale		Elektrodenabstand		
A	∅ 18,0	Hex 25,4	P	vorgeschobene Isolatorspitze	R	Widerstand	2	 warme Type kalte Type	E	19,0	B	feste SAE-Anschlussmutter (CR8EB)	leer	Motorrad : 0,7-0,8
B	∅ 14,0	Hex 20,8			Z	induktiver Widerstand	4		EF	17,5	CM	Schräge Masseelektrode Kompaktbauart (Freiliegende Isolatorlänge: 18,5)		Auto : 0,8-0,9
BC	∅ 14,0	Hex 16,0	M	Kompaktkerze			5		EH	19,0 zur Hälfte ausgeführt				
BK	∅ 14,0	Hex 16,0					6		H	12,7	CS	Schräge Masseelektrode	-8	0,8
C	∅ 10,0	Hex 16,0	U	Gleitfunktentyp oder Zusatzfunktentrecke			7		L	11,2	G,GV	Rennzündkerze	-9	0,9
D	∅ 12,0	Hex 18,0					8				I	Mittelelektrode, Iridium	-10	1,0
DC	∅ 12,0	Hex 16,0					9		leer	Kegeldichtsitz A(P)-F : 10,9 B(P)-F : 11,2 BM(P)-F : 7,8	IX	Iridium-Zündkerze	-11	1,1
E	∅ 8,0	Hex 13,0					10			Zündkerze, klein B(P)M- : 9,5 B-LM : 9,5 CM : 9,5 CM-6 : 8,6 C-50 : 8,5	J	2 überstehende Masseelektroden	-13	1,3
* Ausnahme B(P)M-A, Y : ∅ 14,0, Hex 19,0 P(P)-(E)F : ∅ 14,0, Hex 16,0 CM-6 : ∅ 10,0, Hex 14,0 BC : Alte JIS-Standardgröße Die Länge zwischen dem Dichtungsring und der Anschlussklemme beträgt 53,0 mm. BK : ISO-/JIS-Standardgröße Die Länge zwischen dem Dichtungsring und der Anschlussklemme beträgt 50,5 mm.														
											K	2 Masseelektroden	-15	1,5
										-LM	Kompakt-Type (Isolatorlänge: 14,5)			
										N	spezielle Masse-Elektrode	-S	spezieller Dichtring	
										P	Platinelektrode Einzel-Masseelektrode: Mehrfach-Masseelektrode Doppelplatin: Einzelplatin in Mittelelektrode	-E	spezieller Widerstand	
												IX-P	Iridium MAX Kerze	
												LPG 1-8	LaserLine-Zündkerzenserie für gasbetriebene Motoren	
										Q	4 Masseelektroden			
										S	Standard Type			
										T	3 Masseelektroden			
										U	Halbleitfunktentyp			
										Y	Mittelelektrode mit V-Einkerbung			
										Z	spezielle Konstruktion			



Markierungszeichen Zündkerzen

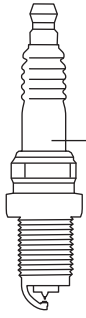

P F R 5 A - 11

Einheit: mm

P		F				R	5		A		-11				
Zündkerzentyp		Gewinde- durchmesser	Gewinde- länge	Sitz- konstruktion	Sechskant	Entstörwiderstand	Wärmewert		Konstruktion		Elektrodenabstand				
DI	besonders hohe Zündfähigkeit, doppel ausgeführte, feine Elektroden	F	∅ 14,0	19,0	Dichtring	Hex 16,0	R	Widerstand	2		A,B,C... Suffix code	leer	Motorrad : 0,7-0,8 Auto : 0,8-0,9		
		FE	∅ 14,0	19,0	Dichtring	Hex 16,0			4						
I	Zündkerze, Doppeliridium	G	∅ 14,0	19,0	Dichtring	Hex 20,8			5				-7	0,7	
L	besonders langes Gewinde	J	∅ 12,0	19,0	Dichtring	Hex 18,0			6				-9	0,9	
P	Zündkerze, Doppelplatin	K	∅ 12,0	19,0	Dichtring	Hex 16,0			7			I	Mittelelektrode, Iridium	-10	1,0
S	Zündkerze mit hoher Zündwilligkeit: dünn, mit quadratischer Spitze	KA	∅ 12,0	19,0	Dichtring	Hex 14,0			8			IX	Iridium-Zündkerze	-11	1,1
Z	Vorgezogene Funkenlage	KB	∅ 12,0	19,0	Dichtring	Bi-Hex 14,0 (Doppel-sechskant *)			9			P	Mittelelektrode, Platin	-13	1,3
Oben angeführte Kennzeichen können kombiniert auftreten <Beispiel>LFR..., PLZFR... Ist „L“ in der Markierung enthalten, erhält „L“ (lange Passlänge)“. Priorität bei der Gewindelänge. <Beispiel> * Kerze mit Dichtring FR5AP : Gewindelänge 19,0mm ↓ LFR5AP-11 : Gewindelänge 26,5mm * Kerze mit Kegeldichtsitz PTR5C-13 : Gewindelänge 17,5mm ↓ PLTR6A-10G : Gewindelänge 25,0mm		KE	∅ 12,0	19,0	Dichtring	Hex 16,0					10				
		KF	∅ 12,0	19,0	Dichtring	Hex 14,0									
		KG	∅ 12,0	19,0	Dichtring	Bi-Hex 14,0 (Doppel-sechskant *)									
		L	∅ 10,0	12,7	Dichtring	Hex 16,0									
		M	∅ 10,0	19,0	Dichtring	Hex 16,0									
		MA	∅ 10,0	19,0	Dichtring	Hex 14,0									
		MF	∅ 10,0	19,0	Dichtring	Hex 14,0									
		NA	∅ 12,0	17,5	Kegeldichtsitz	Hex 14,0									
		T	∅ 14,0	17,5	Kegeldichtsitz	Hex 16,0									
		U	∅ 14,0	11,2	Kegeldichtsitz	Hex 16,0									
		W	∅ 18,0	10,9	Kegeldichtsitz	Hex 20,8									
		X	∅ 14,0	9,5	Dichtring	Hex 20,8									
		Y	∅ 14,0	11,2	Kegeldichtsitz	Hex 16,0									
		* Ausnahme TR5A-10, TR5A-13, TR5B-13, TR6B-10, TR6B-13, PTR5A-10, PTR5A-13: Gewindelänge 25,0 mm * Doppel-Innensechskant erforderlich. * FFE, KE, KF, KG, MF: Bauart mit längerem freiliegenden Isolator				Doppelsechskant 									
						Sechskant 									
								* Wenn am Anfang der Teilenummer „I“ oder „P“ steht („I“ oder „P“ nach dem Temperaturwert wird zum nachgestellten Zusatzcode.) <Beispiel> IZFR6P8 bedeutet Iridium-Zündkerze I: Iridium P: Zusatzcode * <Ausnahme> ZFR0P-G bedeutet Nickel-Zündkerze							
												-A	kein Dichtring		
												-E	Metallhülse: Nickel-beschichtet		
												-D	spezieller Widerstand		
												-G	Masselektrode mit Kupferkern		
												-H	spezielles Gewinde		
												-J	2 Massen-Elektroden		
												-K	schwingungsfeste Masselektrode		
												-N	spezielle Massen-Elektrode		
												-Q	4 Massen-Elektrode		
												-S	spezieller Dichtring		
												-T	3 Massen-Elektrode		
												-U	Halbleitfunktentyp		
												IX-P	Iridium MAX Kerze		
												LPG 1-8	LaserLine-Zündkerzenseerie für gasbetriebene Motoren		

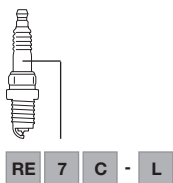

RE 7 C - L

RE		7	C				-L		
Zündkerzentyp		Wärmewert	Konstruktion				Elektrodenabstand		
RE	Zündkerze für Wankelmotor	5		A,B,C... Suffix code				-L	oberer Totpunkt
SD	Zündkerze für Wankelmotor (Halbleitfunktentyp)	6							
		7							
		8							
		9							
		10							
		11							
							-T	unterer Totpunkt	

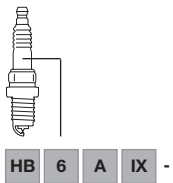

HB 6 A IX - 11 P

HB		6	A				IX	-11		P	
Zündkerzentyp		Wärmewert	Gewinde- durchmesser	Gewinde- länge	Sitzkonstruktion	Sechskant	Elektroden- abstand				
HB	HYBD (3 Masselektroden, Hybridbauart)	4		A	∅ 14,0	20,5	Dichtring	Hex 16,0	IX	-8	0,8
		5		B	∅ 14,0	19,0	Dichtring	Hex 16,0		-9	0,9
		6								-10	1,0
		7								-11	1,1
		8							-13	1,3	

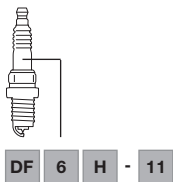

DF 6 H A - 11 A

DF		6	H				-11		A		
Zündkerzentyp		Wärmewert	Gewinde- durchmesser	Gewinde- länge	Sitzkonstruktion	Sechskant	Elektroden- abstand				
DF	Zündkerze mit hoher Zündwilligkeit (Doppel-elektrode, dünn)	4		A	∅ 14,0	19,0	Dichtring	Hex 16,0	-8	0,8	A,B,C... Suffix code
		5		B	∅ 14,0	26,5	Dichtring	Hex 16,0	-9	0,9	
DFH	Zündkerze mit hoher Zündwilligkeit (DF + Hybrid)	6		C	∅ 12,0	26,5	Dichtring	Hex 14,0	-10	1,0	
		7		* DF6H-11A : Gewindelänge 28,0mm				-11	1,1		
		8							-13	1,3	
		9						-15	1,5		

Repères Bougies d'allumage

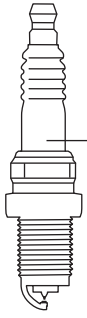

B P R 5 E S - 11

Unité : mm

B		P		R		5		E		S		-11		
Diamètre de filetage		Structure		Résistance antiparasitage		Indice thermique		Longueur du filetage		Caractéristiques de conception		Ecartement		
A	∅ 18,0	Hex 25,4	P	Isolant proéminent	R	Résistance	2	<p>Type chaud</p> <p>Type froid</p>	E	19,0	B	Olive SAE monbloque (CR8EB)	vide	Moto : 0,7-0,8
B	∅ 14,0	Hex 20,8	M	Bougie compacte	Z	Inductance intégrée	4		EF	17,5	CM	Électrode de masse inclinée Type compact (Longueur d'isolant exposé : 18,5)		Automobile : 0,8-0,9
BC	∅ 14,0	Hex 16,0	U	Décharge superficielle ou à étincelle semi-surfacique			5		EH	19,0 semi-filetage Culot 19 mm Filetage 12,7	CS	Électrode de masse inclinée	-8	0,8
BK	∅ 14,0	Hex 16,0					6		H	12,7	G,GV	Bougie d'allumage de course	-9	0,9
C	∅ 10,0	Hex 16,0					7		L	11,2	I	Électrode centrale en iridium	-10	1,0
D	∅ 12,0	Hex 18,0					8		vide	Siège conique A(P)-F : 10,9 B(P)-F : 11,2 BM(P)-F : 7,8	IX	Gamme Iridium IX	-11	1,1
DC	∅ 12,0	Hex 16,0					9				J	2 électrodes de masse à projection	-13	1,3
E	∅ 8,0	Hex 13,0					10		K	2 électrodes de masse	-15	1,5		
* Exception B(P)M-A,Y : ∅ 14,0, Hex 19,0 P(P)-(E)F : ∅ 14,0, Hex 16,0 CM-6 : ∅ 10,0, Hex 14,0		BC : Ancienne taille standard JIS La longueur entre le circuit du joint et le contact de la borne est de 53 mm.							-LM	Type compact (longueur isolant : 14,5 mm)	N	Electrode de masse spéciale	-S	Joint spécifique
BK : Taille standard ISO/JIS La longueur entre le circuit du joint et le contact de la borne est de 50,5 mm.											P	Electrode centrale en Platine Électrode de masse simple : Double platine Électrode à masses multiples : Platine simple dans l'électrode centrale	-E	Résistance spéciale
												IX-P	Bougie Iridium MAX	
												LPG 1-8	Gamme de bougies d'allumage LaserLine pour utilisation sur moteur à gaz	
										Q	4 électrodes de masse			
										S	Electrode centrale en cuivre			
										T	3 électrodes de masse			
										U	à décharge semi-surfacique			
										Y	Electrode centrale à gorge en V - Proéminence sup. à 1mm			
										Z	Conception spéciale			



Repères Bougies d'allumage

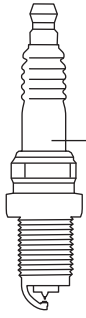

P F R 5 A - 11

Unité : mm

P		F				R		5		A		-11						
Type		Diamètre de filetage	Longueur du filetage	Configuration du siège	Hexagone	Résistance antiparasitage		Indice thermique		Conception		Distance entre les électrodes						
DI	Haute capacité d'allumage : technologie DFE	F	∅ 14,0	19,0	Joint	Hex 16,0	R	Résistance	2	Type chaud	A,B,C... code suffixe		leer	Moto : 0,7-0,8				
		FE	∅ 14,0	19,0	Joint	Hex 16,0					4					Automobile : 0,8-0,9		
I	Bougie d'allumage double à l'iridium	G	∅ 14,0	19,0	Joint	Hex 20,8					5					-7	0,7	
L	Filetage extra-long de 26,5mm	J	∅ 12,0	19,0	Joint	Hex 18,0					6					-9	0,9	
P	Bougie d'allumage double à la platine	K	∅ 12,0	19,0	Joint	Hex 16,0					7			I	Électrode centrale en iridium	-10	1,0	
S	Bougie haute sensibilité à l'allumage : type à pointe carrée fine	KA	∅ 12,0	19,0	Joint	Hex 14,0					8					-11	1,1	
Z	Extrémité d'allumage projetée	KB	∅ 12,0	19,0	Siège conique	Bi-Hex 14,0 (Bi-hexagonal *)					9			IX	Gamme Iridium IX	-13	1,3	
		KE	∅ 12,0	19,0	Joint	Hex 16,0					10					P	Électrode centrale en platine	-15
Les caractéristiques citées ci-dessus peuvent être combinées, <Exemple>ILFR..., PLZFR... Quand « L » est inclus, la priorité est donnée au « L » (longue portée) pour la longueur de filetage. <Exemple> *Bougie avec joint d'étanchéité		KF	∅ 12,0	19,0	Joint	Hex 14,0									* Quand il y a « I » ou « P » au début du numéro de pièce (« I » ou « P » après la valeur thermique devient un code de suffixe.)		-A	Sans joint d'étanchéité
FR5AP : longueur de filetage 19,0mm		KG	∅ 12,0	19,0	Joint	Bi-Hex 14,0 (Bi-hexagonal *)									<Exemple> IZFR6P8 est une bougie à l'iridium I : Iridium P : Code de suffixe		-D	Corps métallique : nickelé
LFR5AP-11 : longueur de filetage 26,5mm		L	∅ 10,0	12,7	Joint	Hex 16,0					* <Exception> ZFR6P-G est une bougie d'allumage au nickel		-E	Résistance spéciale				
*Bougie à siège conique		M	∅ 10,0	19,0	Joint	Hex 16,0						-G	Électrode de masse à cœur en cuivre					
PTR5C-13 : longueur de filetage 17,5mm		MA	∅ 10,0	19,0	Joint	Hex 14,0						-H	Filetage spécial					
PLTR6A-10G : longueur de filetage 25,0mm		MF	∅ 10,0	19,0	Joint	Hex 14,0						-J	2 électrodes de masse					
		NA	∅ 12,0	17,5	Siège conique	Hex 14,0						-K	Électrode de masse résistante aux vibrations					
		T	∅ 14,0	17,5	Siège conique	Hex 16,0						-N	Electrode de masse spéciale					
		U	∅ 14,0	11,2	Siège conique	Hex 16,0						-Q	4 électrodes de masse					
		W	∅ 18,0	10,9	Siège conique	Hex 20,8						-S	Joint spécifique					
		X	∅ 14,0	9,5	Joint	Hex 20,8						-T	3 électrodes de masse					
		Y	∅ 14,0	11,2	Siège conique	Hex 16,0						-U	Type à décharge sur demi-surface					
		*Exception TR5A-10, TR5A-13, TR5B-13, TR6B-10, TR6B-13, PTR5A-10, PTR5A-13 : Longueur de filetage 25 mm				Bi-hexagonal							IX-P	Bougie Iridium MAX				
		*Une douille bi-hexagonale est nécessaire.				Hexagonal							LPG 1-8	Gamme de bougies d'allumage LaserLine pour moteurs à gaz				
		*FE, KE, KF, KG, MF : Type à longueur d'isolant exposé plus longue																

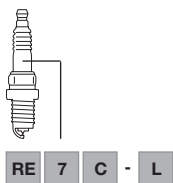

RE 7 C - L

RE		7		C		-L	
Type		Indice thermique		Conception		Distance entre les électrodes	
RE	Bougie pour moteurs rotatifs	5	Type chaud	A,B,C... code suffixe		-L	Face avant
SD	Bougie pour moteurs rotatifs (écartement des électrodes à décharge sur demi-surface)	6				-T	Face arrière
		7					
		8					
		9					
		10					
		11	Type froid				

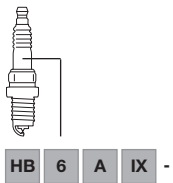

HB 6 A IX - 11 P

HB		6		A				IX		-11		P	
Type		Indice thermique		Diamètre de filetage	Longueur du filetage	Configuration du siège	Hexagone			Distance entre les électrodes			
HB	HYBD (type hybride à 3 électrodes de masse)	4	Type chaud	A	∅ 14,0	20,5	Joint	Hex 16,0	IX	-8	0,8		
		5		B	∅ 14,0	19,0	Joint	Hex 16,0		-9	0,9		
		6						-10		1,0			
		7						-11		1,1			
		8		Type froid				-13		1,3			

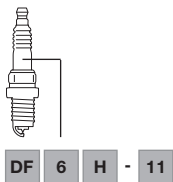

DF 6 H - 11 A

DF		6		H				-11		A	
Type		Indice thermique		Diamètre de filetage	Longueur du filetage	Configuration du siège	Hexagone	Distance entre les électrodes			
DF	Bougie haute sensibilité à l'allumage	4	Type chaud	A	∅ 14,0	19,0	Joint	Hex 16,0	-8	0,8	A,B,C... code suffixe
		5		B	∅ 14,0	26,5	Joint	Hex 16,0	-9	0,9	
DFH	Bougie haute sensibilité à l'allumage (DF + type hybride)	6		C	∅ 12,0	26,5	Joint	Hex 14,0	-10	1,0	
		7		*DF6H-11A : Longueur du filetage 28,0 mm				-11	1,1		
		8					-13	1,3			
		9	Type froid					-15	1,5		

Marcature delle candele

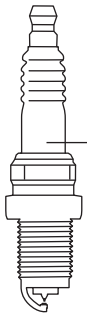

B P R 5 E S - 11

Unità: mm

B		P		R		5		E		S		-11		
Diametro filettatura	esagono	Struttura	Resistore	Grado termico	Lunghezza filettatura	Caratteristiche costruttive		Gap						
A	∅ 18,0	Hex 25,4	P	punta isolatore prominente	R	Candela resistiva	2	candela calda	E	19,0	B	terminale SAE fisso (CR8EB)	leer	Motociclo : 0,7-0,8
B	∅ 14,0	Hex 20,8	M	Candela compatta del tipo Bantam	Z	resistenza induttiva	4		EF	17,5	CM	Elettrodo inclinato di messa a terra Tipo compatto (lunghezza isolante visibile: 18,5)	-8	0,8
BC	∅ 14,0	Hex 16,0			5	EH	19,0 parzialmente filettata							
BK	∅ 14,0	Hex 16,0	U	Candela a scarica superficiale o semisuperficiale		6	H		12,7	G,GV	Candela Racing	-9	0,9	
C	∅ 10,0	Hex 16,0				7	L		11,2	I	Elettrodo centrale in iridio	-10	1,0	
D	∅ 12,0	Hex 18,0	8	vuoto		Sede conica A(P)-F : 10,9 B(P)-F : 11,2 BM(P)-F : 7,8	9		IX	Candela Iridium IX	-11	1,1		
DC	∅ 12,0	Hex 16,0	10				candela fredda						Candela del tipo piccolo B(P)M- : 9,5 B-LM : 9,5 CM- : 9,5 CM-6 : 8,6 C-50 : 8,5	J
E	∅ 8,0	Hex 13,0	<p>* Eccezione B(P)M-A, Y : ∅ 14,0, Hex 19,0 P(P)-(E)F : ∅ 14,0, Hex 16,0 CM-6 : ∅ 10,0, Hex 14,0</p> <p>BC : Misura standard JIS precedente La lunghezza dalla guarnizione del circuito al terminale è di 53 mm.</p> <p>BK : Misura standard ISO / JIS La lunghezza dalla guarnizione del circuito al terminale è di 50,5 mm.</p>	K		2 elettrodi di messa a terra	-15		1,5					
				-LM		Tipi compatti (lunghezza isolatore: 14,5)	N		elettrodo di massa irrobustito	-S	guarnizione anulare speciale			
				P		elettrodo al platino Elettrodo di messa a terra singolo: Platino doppio	Elettrodo con messa a terra multipla: Elettrodo centrale singolo in platino		-E	Resistenza speciale				
				Q		4 elettrodi di messa a terra			IX-P	Candela all'iridio MAX				
				S		Tipo standard	LPG 1-8	Gamma di candele LaserLine per motori a gas						
				T		3 elettrodi di messa a terra								
				U	Tipo a scarica semi-superficiale									
				Y	Elettrodo centrale scanalato a V - V grooved -									
				Z	struttura speciale									



Marcature delle candele

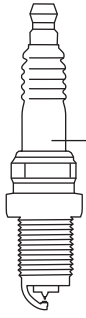

P F R 5 A - 11

Unità: mm

P		F			R	5		A		-11								
Tipo candela		Diametro filettatura	Lunghezza filettatura	Configurazione della sede	esagono	Resistore		Grado termico		Costruzione		Gap						
DI	candela ad elevatissima accendibilità tipo DFE (Double Fine electrodes)	F ø 14,0	19,0	Guarnizione anulare	Hex 16,0	R	Resistenza	2		A,B,C... Suffix code		vuoto	Motociclo: 0,7-0,8					
		FE ø 14,0	19,0	Guarnizione anulare	Hex 16,0					4			Auto : 0,8-0,9					
I	Candele al doppio iridio	G ø 14,0	19,0	Guarnizione anulare	Hex 20,8			5					-7	0,7				
L	candela a filettatura estesa	J ø 12,0	19,0	Guarnizione anulare	Hex 18,0			6					-9	0,9				
P	Candele al doppio platino	K ø 12,0	19,0	Guarnizione anulare	Hex 16,0			7			I	Elettrodo centrale in iridio		-10	1,0			
S	Alta accendibilità della candela; punta del tipo sottile quadrangolare	KA ø 12,0	19,0	Guarnizione anulare	Hex 14,0			8					Elettrodo centrale in iridio		-11	1,1		
		KB ø 12,0	19,0	Guarnizione anulare	Bi-Hex 14,0 (Bi-esagonale *)			9			IX	Candela Iridium IX		-13	1,3			
Z	Elettrodo prominente	KE ø 12,0	19,0	Guarnizione anulare	Hex 16,0			10			P	Elettrodo centrale in platino		-15	1,5			
I codici sopraindicati possono presentarsi in varie combinazioni, <Esempio>ILFR..., PLZFR..., Quando è inclusa una „L“, la priorità viene data alla „L“ (braccio lungo)* per la lunghezza della filettatura.		KF ø 12,0	19,0	Guarnizione anulare	Hex 14,0						* Quando è presente una „I“ o una „P“ all'inizio del numero del pezzo („I“ o „P“ dopo il grado termico diventa il codice suffisso.) <Esempio> IZFR6P8 è una candela all'iridio I: Iridio P: Codice suffisso * <Eccezione> ZFR6P-G è una candela al nichel							
* Candela con guarnizione anulare		KG ø 12,0	19,0	Guarnizione anulare	Bi-Hex 14,0 (Esagonale*)													-A
FR5AP : lunghezza filettatura 19,0mm		L ø 10,0	12,7	Guarnizione anulare	Hex 16,0												-D	Supporto in metallo: nichelatura
LFR5AP-11 : lunghezza filettatura 26,5mm		M ø 10,0	19,0	Guarnizione anulare	Hex 16,0												-E	resistenza speciale
*Candela con sede conica		MA ø 10,0	19,0	Guarnizione anulare	Hex 14,0												-G	Elettrodo di terra con nucleo in rame
PTR5C-13 : lunghezza filettatura 17,5mm		MF ø 10,0	19,0	Guarnizione anulare	Hex 14,0												-H	Filettatura speciale
PLTR6A-10G : lunghezza filettatura 25,0mm		NA ø 12,0	17,5	Sede conica	Hex 14,0												-J	2 elettrodi di massa
		T ø 14,0	17,5	Sede conica	Hex 16,0												-K	Elettrodo di terra resistente alle vibrazioni
		U ø 14,0	11,2	Sede conica	Hex 16,0												-N	Elettrodo di massa speciale
		W ø 18,0	10,9	Sede conica	Hex 20,8												-Q	4 elettrodi di massa
		X ø 14,0	9,5	Guarnizione anulare	Hex 20,8							-S	Guarnizione anulare speciale					
		Y ø 14,0	11,2	Sede conica	Hex 16,0							-T	3 elettrodi di massa					
												-U	Tipa a scarica semi-superficiale					
												IX-P	Candela all'iridio MAX					
												LPG 1-8	Gamma di candele LaserLine per motori a gas					

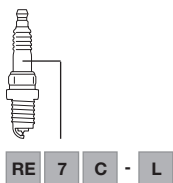

RE 7 C - L

RE		7		C		-L	
Tipo candela		Grado termico		Costruzione		Gap	
RE	Candela per motori rotativi	5		A,B,C... Suffix code		-L	Leading side
SD	Candela per motori rotativi (distanza tra gli elettrodi a scarica semi-superficiale)	6				-T	Trading side
		7					
		8					
		9					
		10					
11							

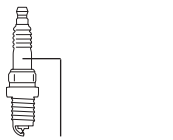

HB 6 A IX - 11 P

HB		6		A				IX	-11		P
Tipo candela		Grado termico		Diametro filettatura	Lunghezza filettatura	Configurazione della sede	esagono	Gap			
HB	HYBD (tipo ibrido con 3 elettrodi di messa a terra)	4		A ø 14,0	20,5	Guarnizione anulare	Hex 16,0	IX	-8	0,8	
		5		B ø 14,0	19,0	Guarnizione anulare	Hex 16,0		-9	0,9	
		6							-10	1,0	
		7							-11	1,1	
		8						-13	1,3		

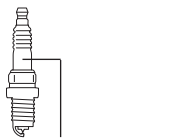

DF 6 H - 11 A

DF		6		H				-11		A		
Tipo candela		Grado termico		Diametro filettatura	Lunghezza filettatura	Configurazione della sede	esagono	Gap				
DF	Candela ad alta accendibilità (elettrodi sottili doppi)	4		A ø 14,0	19,0	Guarnizione anulare	Hex 16,0	-11	-8	0,8	A,B,C... Suffix code	
		5		B ø 14,0	26,5	Guarnizione anulare	Hex 16,0		-9	0,9		
DFH	Candela ad alta accendibilità (DF + tipo ibrido)	6		C ø 12,0	26,5	Guarnizione anulare	Hex 14,0		-10	1,0		
		7		* DF6H-11A : Lunghezza filettatura 28,0mm					-11	1,1		
		8							-13	1,3		
		9						-15	1,5			

Símbolos de diseño Bujías de encendido

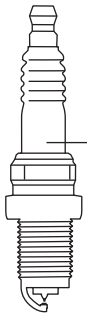

B P R 5 E S - 11

Unidad: mm

B		P		R		5		E		S		-11				
	Diámetro de la rosca	Tamaño del Hexágono	Estructura		Construcción / Características		Grado térmico		Longitud de la rosca		Características constructivas		Galga (mm), Nada: Galga convencional			
A	∅ 18,0	Hex 25,4	P	Tipo aislador proyectado	R	Tipo Resistencia	2		E	19,0	B	Tuerca terminal SAE fija (CR8EB)	vacio	Motocicleta: 0,7 - 0,8 mm		
B	∅ 14,0	Hex 20,8			Z	Tipo Resistencia inductiva	4		EF	17,5	CM	Electrodo de masa inclinado Tipo compacto (longitud de aislador expuesto: 18,5)			Automóvil: 0,8 - 0,9 mm	
BC	∅ 14,0	Hex 16,0	M	Tipo Compacto (Bantam)		5	EH		Media rosca, Total: 19,00 mm, Rosca I: 12,7 mm	CS	Electrodo de masa inclinado	-8	0,8			
BK	∅ 14,0	Hex 16,0				6	H		12,7	G,GV	Bujía de competición	-9	0,9			
C	∅ 10,0	Hex 16,0	U	Tipo descarga superficial o semi-superficial		7	L		11,2	I	Electrodo central de iridio	-10	1,0			
D	∅ 12,0	Hex 18,0				8	IX		Electrodo de iridio IX	-11	1,1					
DC	∅ 12,0	Hex 16,0	9	vacio		Asiento cónico A(P)-F: 10,9 B(P)-F: 11,2 BM(P)-F: 7,8	J		2 electrodos de masa prominentes	-13	1,3					
E	∅ 8,0	Hex 13,0	10			Frío	Bujía de tipo pequeño B(P)M-: 9,5 B-LM: 9,5 CM-: 9,5 CM-6: 8,6 C-50: 8,5		K	2 electrodos de masa	-15	1,5				
*Excepción B(P)M-A,Y: ∅ 14,0, Hex 19,0 P(P)-(E)F: ∅ 14,0, Hex 16,0 CM-6: ∅ 10,0, Hex 14,0 BC: Altura JIS estándar antigua La longitud desde el asiento a la parte superior del terminal es de 53,0 mm. BK: Altura estándar ISO/JIS La longitud desde el asiento a la parte superior del terminal es de 50,5 mm.																
													-LM	Tipo compacto (longitud del aislante: 14,5 mm)		
												N	Electrodo especial de masa	-S	Junta especial	
												P	Electrodo de platino Un solo electrodo de masa: doble platino Varios electrodos de masa: platino sencillo en el electrodo central	-E	Resistencia especial	
											Q	4 electrodos de masa	IX-P	Bujía Iridium MAX		
											S	Tipo estándar	LPG 1-8	Gama de bujías LaserLine para motores de gas		
											T	3 electrodos de masa				
											U	Tipo descarga semi superficial				
											Y	Electrodo central con ranurado en V				
											Z	Fabricación especial				

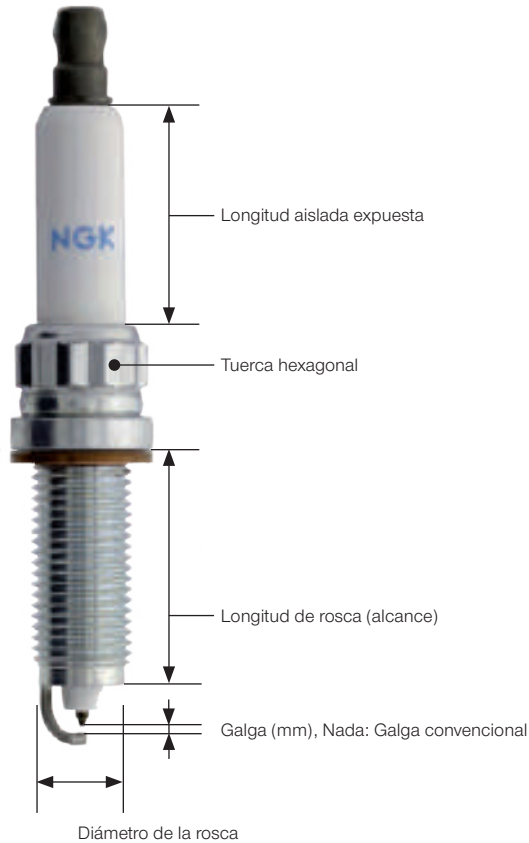

Símbolos de diseño Bujías de encendido

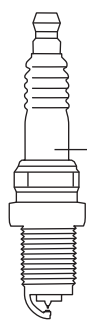

P F R 5 A - 11

Unidad: mm

P		F				R	5		A		-11					
Tipo de bujía		Diámetro de la rosca	longitud de rosca	Configuración de asiento	Tamaño del Hexágono	Resistencia		Grado térmico		Construcción		Galga (mm), Nada: Galga convenciona				
DI	Gran capacidad de inflamación :electrodo extra fino	F	∅ 14,0	19,0	Con Junta	Hex 16,0	R Resistencia	2	Caliente	A,B,C... Código de sufijo		vacio	Motocicleta: 0,7-0,8			
		FE	∅ 14,0	19,0	Con Junta	Hex 16,0				4				-7	0,7	
I	Bujía de doble iridio	G	∅ 14,0	19,0	Con Junta	Hex 20,8				5				-9	0,9	
L	Rosca extralarga	J	∅ 12,0	19,0	Con Junta	Hex 18,0				6				-10	1,0	
P	Bujía de doble platino	K	∅ 12,0	19,0	Con Junta	Hex 16,0				7			I	Electrodo central de iridio	-11	1,1
S	Bujía de alta inflamabilidad: tipo de punta cuadrada fina	KA	∅ 12,0	19,0	Con Junta	Hex 14,0				8			IX	Electrodo de iridio IX	-13	1,3
Z	Extremo de encendido protuberante	KB	∅ 12,0	19,0	Con Junta	Bi-Hex 14,0 (Bi-hexagonal *)				9			P	Electrodo central de platino	-15	1,5
Las características arriba nombrada pueden aparecer combinadas, <Ejemplo>ILFR..., PLZFR... Cuando se incluye „L“, se da prioridad a „L“ (alcance largo) en longitud de rosca. <Ejemplo> * Bujía con junta FR5AP-11; longitud de rosca ↓ 19,0 mm LFR5AP-11; longitud de rosca 26,5mm * Bujía con asiento cónico PTR5C-13; longitud de rosca ↓ 17,5 mm PLTR6A-10G; longitud de rosca 25,0 mm		KE	∅ 12,0	19,0	Con Junta	Hex 16,0				10			* Cuando hay una „I“ o una „P“ al principio de un número de pieza („I“ o „P“ después del grado térmico se convierte en sufijo). <Ejemplo> IZFR6P8 es una bujía de Iridio I: Iridio P: Sufijo * <Excepción> ZFR0P-G es una bujía de níquel		-A	Sin junta
		KF	∅ 12,0	19,0	Con Junta	Hex 14,0						-D	Carcasa de metal: chapada en níquel			
		KG	∅ 12,0	19,0	Con Junta	Hex 14,0 (Bi-hexagonal*)						-E	Resistencia especial			
		L	∅ 10,0	12,7	Con Junta	Hex 16,0			-G	Electrodo de masa con núcleo de cobre						
		M	∅ 10,0	19,0	Con Junta	Hex 16,0			-H	Rosca especial						
		MA	∅ 10,0	19,0	Con Junta	Hex 14,0			-J	2 electrodos de masa						
MF	∅ 10,0	19,0	Con Junta	Hex 14,0			-K	Electrodo de masa resistente a las vibraciones								
NA	∅ 12,0	17,5	Asiento cónico	Hex 14,0			-N	Electrodo de masa especial								
T	∅ 14,0	17,5	Asiento cónico	Hex 16,0			-Q	4 electrodos de masa								
U	∅ 14,0	11,2	Asiento cónico	Hex 16,0			-S	Junta especial								
W	∅ 18,0	10,9	Asiento cónico	Hex 20,8			-T	3 electrodos de masa								
X	∅ 14,0	9,5	Dichtring	Hex 20,8			-U	Tipo de descarga semi-superficial								
Y	∅ 14,0	11,2	Asiento cónico	Hex 16,0			-J	Bujía Iridium MAX								
		*Excepción TR5A-10, TR5A-13,TR5B-13, TR6B-10, TR6B-13,PTR5A-10, PT-R5A-13: Longitud de la rosca 25,0 mm				Bi-hexagonal						LPG 1-8	Gama de bujías LaserLine para motores de gas			
		* Se necesita una llave de vaso bi-hexagonal.				Hexagonal										
		* FE, KE, KF, KG, MF: Tipo de longitud de aislador expuesto mayor				Hexagonal										

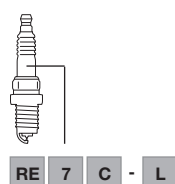

RE		7	C		-L		
Tipo de bujía		Grado térmico		Construcción		Galga (mm), Nada: Galga convenciona	
RE	Bujía para motores rotativos	5	Caliente	A,B,C... Código de sufijo		-L	Lado avanzado
SD	Bujía para motores rotativos (separación entre electrodos de descarga semi-superficial)	6				-T	Lado retrasado
		7					
		8					
		9					
		10					
		11	Frío				

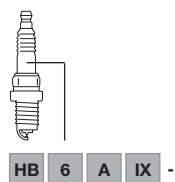

HB		6	A				IX	-11		P	
Tipo de bujía		Grado térmico		Diámetro de la rosca	longitud de rosca	Configuración de asiento	Tamaño del Hexágono	Galga (mm), Nada: Galga convenciona			
HB	HYBD (3 electrodos de masa tipo híbrido)	4	Caliente	A	∅ 14,0	20,5	Con Junta	Hex 16,0	IX	-8	0,8
		5		B	∅ 14,0	19,0	Con Junta	Hex 16,0		-9	0,9
		6								-10	1,0
		7								-11	1,1
		8	Frío						-13	1,3	

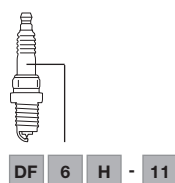

DF		6	H				-11		A		
Tipo de bujía		Grado térmico		Diámetro de la rosca	longitud de rosca	Configuración de asiento	Tamaño del Hexágono	Galga (mm), Nada: Galga convenciona			
DF	Bujía de alta inflamabilidad (electrodos finos dobles)	4	Caliente	A	∅ 14,0	19,0	Con Junta	Hex 16,0	-8	0,8	A,B,C... Código de sufijo
		5		B	∅ 14,0	26,5	Con Junta	Hex 16,0	-9	0,9	
DFH	Bujía de alta inflamabilidad (DF + tipo híbrido)	6		C	∅ 12,0	26,5	Con Junta	Hex 14,0	-10	1,0	
		7		* DF6H-11A : Longitud de la rosca 28,0 mm				-11	1,1		
		8						-13	1,3		
		9	Frío				-15	1,5			

Markeringstekens bougies



B P R 5 E S - 11

Eenheid: mm

B		P		R		5		E		S		-11		
Schroefdraaddiameter	Zeskant	Structuur	Ontstoringweerstand	Warmtewaarde		Schroefdraadlengte		Constructiekenmerken		Elektrodeafstand				
A	∅ 18,0	Hex 25,4	P	R	Weerstand	2		E	19,0	B	aste SAE-aansluitmoer (CR8EB)	Leeg	Motorrijwiel : 0,7-0,8	
B	∅ 14,0	Hex 20,8		Z	Inductieve weerstand	4		EF	17,5	CM	Schuine massa-elektrode Compact type (Onbeschermd isolatorlengte: 18,5)		Auto : 0,8-0,9	
BC	∅ 14,0	Hex 16,0	M			5		EH	19,0 voor de helft uitgevoerd	CS	Schuine massa-elektrode	-8	0,8	
BK	∅ 14,0	Hex 16,0				6		H	12,7	G,GV	Racebougie	-9	0,9	
C	∅ 10,0	Hex 16,0	U			7		L	11,2	I	Middenelektrode van iridium	-10	1,0	
D	∅ 12,0	Hex 18,0				8				IX	Iridium bougie	-11	1,1	
DC	∅ 12,0	Hex 16,0				9		Leeg	Conische zitting A(P)F : 10,9 B(P)F : 11,2 BM(P)F : 7,8	J	2-projecterende-massa-elektrodes	-13	1,3	
E	∅ 8,0	Hex 13,0				10			Kleine bougie B(P)M- : 9,5 B-LM : 9,5 CM- : 9,5 CM-6 : 8,6 C-50 : 8,5	K	2-massa-elektrodes	-15	1,5	
*Uitzondering B(P)M-A,Y : ∅ 14,0, Hex 19,0 P(P)-(E)F : ∅ 14,0, Hex 16,0 CM-6 : ∅ 10,0, Hex 14,0										-LM	Compact type (isolatorlengte: 14,5mm)			
BC : Oude JIS-standaardgrootte De lengte van pakkingcircuit naar eindcontact bedraagt 53,0 mm.										N	Speciale massa-elektrode	-S	Speciale dichtring	
BK : ISO / JIS standaardgrootte De lengte van pakkingcircuit naar eindcontact bedraagt 50,5 mm.									P	Platina elektrode Enkele massa-elektrode Meerdere massa-elektrodes van dubbel platina: Enkel platina in middenelektrode	-E	Speciale weerstand		
											IX-P	Iridium MAX-bougie		
											LPG 1-8	LaserLine bougieassortiment voor gebruik in gasmotoren		
									Q	4-massa-elektrodes				
									S	Standaard type				
									T	3-massa-elektrodes				
									U	Type halfglijvonk				
									Y	Middenelektrode met V-inkepin				
									Z	Speciale constructie				



Markeringstekens bougies

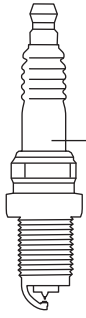

P F R 5 A - 11

Eenheid: mm

P		F				R		5		A		-11		
Bougie Type		Schroefdraad-diameter	Schroef-draadlengte	Zitting-configuratie	Zeskant	Ontstortingsweerstand		Warmtewaarde		Constructie		Elektrodeafstand		
DI	Extreme ontbrandbaarheid, dubbel uitgevoerde, fijne elektroden	F ϕ 14,0	19,0	Dichtring	Hex 16,0	R	Résistance	2		A,B,C... Suffix code		leer	Motorrijwiel : 0,7-0,8	
		FE ϕ 14,0	19,0	Dichtring	Hex 16,0			4					-7	0,7
I	Dubbel iridium bougie	G ϕ 14,0	19,0	Dichtring	Hex 20,8			5					-9	0,9
L	Bijzonder lange schroefdraad 26,5mm	J ϕ 12,0	19,0	Dichtring	Hex 18,0			6					-10	1,0
P	Dubbel platina bougie	K ϕ 12,0	19,0	Dichtring	Hex 16,0			7			I	Middenelektrode van iridium	-11	1,1
S	Hoog ontvlambare bougie: type dun vierkant uiteinde	KA ϕ 12,0	19,0	Dichtring	Hex 14,0			8			IX	Iridium bougie	-13	1,3
Z	Uitstekende elektrode	KB ϕ 12,0	19,0	Conische zitting	Bi-Hex 14,0 (Dubbele zeskant *)			9			P	Middenelektrode van platina	-15	1,5
	Hierboven genoemde kenmerken kunnen gecombineerd optreden, <Voorbeeld>ILFR..., PLZFR...	KE ϕ 12,0	19,0	Dichtring	Hex 16,0			10			*Wanneer „I“ of „P“ aan het begin van het onderdeelnummer staat („I“ of „P“ na warmtegraad wordt suffixcode.)		-A	Geen dichtring
	Wanneer „L“ is inbegrepen, wordt in de draadlengte prioriteit aan „L“ (lang bereik) gegeven.	KF ϕ 12,0	19,0	Dichtring	Hex 14,0						<Voorbeeld> IZFR6P8 is iridium bougie I: Iridium P: Suffixcode		-D	Metalen behuizing: vernikkeld
	<Voorbeeld> *Bougie met dichtring	KG ϕ 12,0	19,0	Dichtring	Hex 14,0 (Dubbele zeskant *)						* <Uitzondering> ZFR6P-G is bougie van nikkel		-E	Speciale weerstand
	FR5AP : draadlengte 19,0mm	L ϕ 10,0	12,7	Dichtring	Hex 16,0							-G	Massa-elektrode met koperen kern	
	LFR5AP-11 : draadlengte 26,5mm	M ϕ 10,0	19,0	Dichtring	Hex 16,0							-H	Speciale schroefdraad	
	*Bougie met conische zitting	MA ϕ 10,0	19,0	Dichtring	Hex 14,0							-J	2 massa-elektroden	
	PTR5C-13 : draadlengte 17,5mm	MF ϕ 10,0	19,0	Dichtring	Hex 14,0							-K	Trilbestendige massa-elektrode	
	PLTR6A-10G : draadlengte 25,0mm	NA ϕ 12,0	17,5	Conische zitting	Hex 14,0							-N	Speciale massa-elektrode	
		T ϕ 14,0	17,5	Conische zitting	Hex 16,0							-Q	4 massa-elektroden	
		U ϕ 14,0	11,2	Conische zitting	Hex 16,0							-S	Speciale dichtring	
		W ϕ 18,0	10,9	Conische zitting	Hex 20,8							-T	3 massa-elektroden	
		X ϕ 14,0	9,5	Dichtring	Hex 20,8							-U	Type halfglijvonkонтстeking	
		Y ϕ 14,0	11,2	Conische zitting	Hex 16,0							IX-P	Iridium MAX-bougie	
												LPG 1-8	LaserLine bougieassortiment voor gasmotoren	

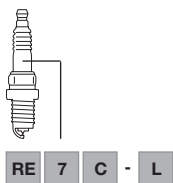

RE 7 C - L

RE		7		C		-L	
Bougie Type		Warmtewaarde		Constructie		Elektrodeafstand	
RE	Bougie voor rotatiemotoren	5		A,B,C... Suffix code		-L	Geleidende zijde
SD	Bougie voor rotatiemotoren (Opening halfglijvonkонтsteking)	6				-T	Uitwisellende zijde
		7					
		8					
		9					
		10					
		11					

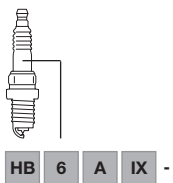

HB 6 A IX - 11 P

HB		6		A				IX		-11		P	
Bougie Type		Warmtewaarde		Schroefdraad-diameter	Schroefdraad-lengte	Zitting-configuratie	Zeskant			Elektrodeafstand			
HB	HYBD (3-massa-elektrode hybride type)	4		A ϕ 14,0	20,5	Joint	Hex 16,0	IX	-8	0,8			
		5		B ϕ 14,0	19,0	Joint	Hex 16,0		-9	0,9			
		6							-10	1,0			
		7							-11	1,1			
		8							-13	1,3			

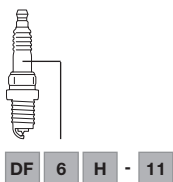

DF 6 H - 11 A

DF		6		H				-11		A	
Bougie Type		Warmtewaarde		Schroefdraad-diameter	Schroefdraad-lengte	Zitting-configuratie	Zeskant	Elektrodeafstand			
DF	Hoog ontvlambare bougie (Dubbele fijne elektrodes)	4		A ϕ 14,0	19,0	Joint	Hex 16,0	-8	0,8	A,B,C... Suffix code	
		5		B ϕ 14,0	26,5	Joint	Hex 16,0	-9	0,9		
DFH	Hoog ontvlambare bougie (DF + hybride type)	6		C ϕ 12,0	26,5	Joint	Hex 14,0	-10	1,0		
		7		*DF6H-11A : Schroefdraadlengte 28,0 mm				-11	1,1		
		8						-13	1,3		
		9					-15	1,5			

Símbolos de identificação Velas de ignição

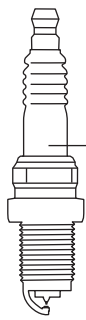

B P R 5 E S - 11

Unidade : mm

B		P		R		5	E		S		-11			
Tamanho da rosca	Tamanho do hexágono	Estrutura		Construçã		Número de potência térmica	Alcance da rosca		Características construtivas		Espaço da vela (mm)			
A	∅ 18,0	Hex 25,4	P	Isolador projetado	R	Resistência	2		E	19,0	B	Porca SAE fixa (CR8EB)	Vazio	Mota: 0,7 - 0,8 mm
B	∅ 14,0	Hex 20,8			Z	Resistência indutiva	4		EF	17,5		CM		Eléctrodo de terra oblíquo Tipo compacto (Comprimento do isolador exposto: 18,5)
BC	∅ 14,0	Hex 16,0	M	Vela compacta (Bantam)	5	EH	19,0 executado até à metade		CS	Eléctrodo de terra oblíquo	-8		0,8	
BK	∅ 14,0	Hex 16,0			U	Descarga superficial ou semi-surface	6			H	12,7	G,GV	Vela de competição	-9
C	∅ 10,0	Hex 16,0	7	L			11,2		I	Eléctrodo central de irídio	IX		Vela de irídio	-10
D	∅ 12,0	Hex 18,0	8	Vazio	Assento cónico A(P):F : 10,9 B(P):F : 11,2 BM(P):F : 7,8	9	J		2 eléctrodos de terra projetores	-11		1,1		
DC	∅ 12,0	Hex 16,0	10			K			2 eléctrodos de terra	-13	1,3			
E	∅ 8,0	Hex 13,0	* Exceção B(P)M-A,Y : ∅ 14,0, Hex 19,0 P(P)-(E)F : ∅ 14,0, Hex 16,0 CM-6 : ∅ 10,0, Hex 14,0		Ficha de tipo pequeno B(P)M- : 9,5 B-LM : 9,5 CM- : 9,5 CM-6 : 8,6 C-50 : 8,5		-LM		Tipo compacto (Comprimento isolador: 14,5mm)	-15	1,5			
BC : Antigo JIS tamanho padrão O comprimento do circuito da junta ao contacto terminal é de 53,0 mm.		BK : ISO / JIS tamanho padrão O comprimento do circuito da junta ao contacto terminal é de 50,5mm.							N	Eléctrodo de massa especial	-S	Anel de vedação especial		
										P	Eléctrodo de platina Eléctrodo de terra simples: Dupla platina	-E	Resistência especial	
								Q	4 eléctrodos de terra		IX-P	Ficha MAX de Iridio		
									S	Tipo padrão	LPG 1-8	L Gama de vela de ignição LaserLine para uso em motor a gás		
								T		3 eléctrodos de terra				
									U	Tipo faísca semi-deslizante				
								Y		Eléctrodo central com corte em V				
									Z	Construção especial				



Símbolos de identificação Velas de ignição

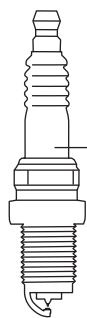

P F R 5 A - 11

Unidade : mm

P		F				R		5		A		-11			
Tipo de vela		Tamanho da rosca	Tamanho da rosca	Configuração do assento	Tamanho do hexágono	Construção		Número de potência térmica		Construção		Espaço da vela			
DI	Ignibilidade especialmente alta, eléctrodos finos de execução dupla	F	∅ 14,0	19,0	Junta circular	Hex 16,0	R	Resistência	2	Mais quente	A,B,C... Código sufixo	vacio	Mota: 0,7-0,8 Carro: 0,8-0,9		
I	Vela de ignição de irídio duplo	FE	∅ 14,0	19,0	Junta circular	Hex 16,0			4			-7	0,7		
L	Rosca especialmente longa	G	∅ 14,0	19,0	Junta circular	Hex 20,8			5			-9	0,9		
P	Vela de ignição de platina dupla	J	∅ 12,0	19,0	Junta circular	Hex 18,0			6			-10	1,0		
S	Ficha de alta inflamabilidade: tipo ponta quadrada fina	K	∅ 12,0	19,0	Junta circular	Hex 16,0			7			-11	1,1		
Z	Ponta de ignição projetada	KA	∅ 12,0	19,0	Junta circular	Hex 14,0			8			IX	Vela de irídio	-13	1,3
		KB	∅ 12,0	19,0	Junta circular	Bi-Hex 14,0 (Bi-sextavado *)			9			P	Eléctrodo central de platina	-15	1,5
		KE	∅ 12,0	19,0	Junta circular	Hex 16,0			10		Mais frio				
		KF	∅ 12,0	19,0	Junta circular	Hex 14,0									
		KG	∅ 12,0	19,0	Junta circular	Bi-Hex 14,0 (Bi-sextavado*)									
		L	∅ 10,0	12,7	Junta circular	Hex 16,0									
		M	∅ 10,0	19,0	Junta circular	Hex 16,0									
		MA	∅ 10,0	19,0	Junta circular	Hex 14,0									
		MF	∅ 10,0	19,0	Junta circular	Hex 14,0									
		NA	∅ 12,0	17,5	Assento cónico	Hex 14,0									
		T	∅ 14,0	17,5	Assento cónico	Hex 16,0									
		U	∅ 14,0	11,2	Assento cónico	Hex 16,0									
		W	∅ 18,0	10,9	Assento cónico	Hex 20,8									
		X	∅ 14,0	9,5	Junta circular	Hex 20,8									
		Y	∅ 14,0	11,2	Assento cónico	Hex 16,0									
						Bi-sextavado									
						Sextavado									

Os códigos acima indicados podem aparecer em combinação, <Exemplo>ILFR..., PLZFR...
Quando „L“ é incluído, a prioridade é dada a „L“ (longo alcance)* em comprimento do fio.
<Exemplo>
*Vela com junta circular
FR5AP-11; comprimento da rosca 19,0 mm
LFR5AP-11; comprimento da rosca 26,5mm
*Vela com assento cónico
PTR5C-13; comprimento da rosca 17,5 mm
PLTR6A-10G; comprimento da rosca 25,0 mm

*Exceção TR5A-10, TR5A-13, TR5B-13, TR6B-10, TR6B-13, PTR5A-10, PTR5A-13: Comprimento do fio de 25,0 mm
*O perno bi-sextavado é necessário.
*FE, KE, KF, KG, MF : Tipo de comprimento de isolador mais tempo exposto

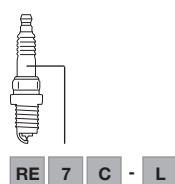

RE 7 C - L

RE		7		C				-L	
Tipo de vela		Número de potência térmica		Construção				Espaço da vela	
RE	Vela para motores rotativos	5	Mais quente	A,B,C... Código sufixo				-L	Lado de liderança
SD	Vela para motores rotativos (Espaço de descarga de semi-superfície)	6						-T	Lado de mudança
		7							
		8							
		9							
		10							
		11	Mais frio						

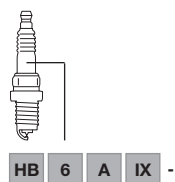

HB 6 A IX - 11 P

HB		6		A				IX		-11		P	
Tipo de vela		Número de potência térmica		Tamanho da rosca	Tamanho da rosca	Configuração do assento	Tamanho do hexágono			Espaço da vela			
HB	HYBD (3 eléctrodos de terra tipo híbrido)	4	Mais quente	A	∅ 14,0	20,5	Con Junta	Hex 16,0	IX	-8	0,8		
		5		B	∅ 14,0	19,0	Con Junta	Hex 16,0		-9	0,9		
		6							-10	1,0			
		7							-11	1,1			
		8		Mais frio						-13	1,3		

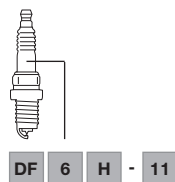

DF 6 H - 11 A

DF		6		H				-11		A	
Tipo de vela		Número de potência térmica		Tamanho da rosca	Tamanho da rosca	Configuração do assento	Tamanho do hexágono	Espaço da vela			
DF	Vela de alta inflamabilidade (eléctrodos finos duplos)	4	Mais quente	A	∅ 14,0	19,0	Con Junta	Hex 16,0	-8	0,8	A,B,C...
		5		B	∅ 14,0	26,5	Con Junta	Hex 16,0	-9	0,9	Código sufixo
DFH	Vela de alta inflamabilidade (DF + Tipo híbrido)	6							-10	1,0	
		7							-11	1,1	
		8							-13	1,3	
		9		Mais frio						-15	1,5

*DF6H-11A : Tamanho da rosca 28,0 mm

Σήμα μαρκαρίσματος μπουζί

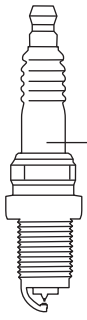

B P R 5 E S - 11

Μονάδα: mm

B		P		R		5		E		S		-11	
Διάμετρος σπειρώματος	εξάγωνο	Δομή	Αντιπαρασπαστική αντίσταση	Τιμή θερμότητας	Μήκος σπειρώματος	Χαρακτηριστικά κατασκευής	Διάκενο ηλεκτροδίου						
A	∅ 18,0	Hex 25,4	P προωθημένο άκρο μονωτήρα	R Αντίσταση	2 θερμός τύπος	E 19,0	B σταθερό παξιμάδι σύνδεσης SAE (CR8EB)	κενό	Μοτοσυκλέτα: 0,7-0,8				
B	∅ 14,0	Hex 20,8	M Συμπαγές μπουζί	Z επαγωγική αντίσταση	4	EF 17,5	CM Ηλεκτρόδιο γείωσης Συμπαγούς τύπου (Μήκος εκτεθειμένου μονωτή: 18,5)	κενό	Αυτοκίνητο: 0,8-0,9				
BC	∅ 14,0	Hex 16,0		5	EH 19,0 μισή εκτέλεση								
BK	∅ 14,0	Hex 16,0	U Τύπος ολισθαίνοντα σπινθήρα ή πρόσθετης διαδρομής σπινθήρα		6	H 12,7	CS Ηλεκτρόδιο γείωσης	-8	0,8				
C	∅ 10,0	Hex 16,0			7	L 11,2	G, GV Αγωγιστικό μπουζί	-9	0,9				
D	∅ 12,0	Hex 18,0			8	κενό Κωνική στεγανή εφαρμογή A(P)-F : 10,9 B(P)-F : 11,2 BM(P)-F : 7,8	I Κεντρικό ηλεκτρόδιο ιριδίου	-10	1,0				
DC	∅ 12,0	Hex 16,0			9		ψυχροί τύποι	IX Μπουζί ιριδίου	-11	1,1			
E	∅ 8,0	Hex 13,0			10			J Ηλεκτρόδια που προεξέχουν από το έδαφος	-13	1,3			
* Εξαιρέση B(P)M-A, Y : ∅ 14,0, Hex 19,0 P(P)-(E)F : ∅ 14,0, Hex 16,0 CM-6 : ∅ 10,0, Hex 14,0								K 2 ηλεκτρόδια γείωσης	-15	1,5			
BC : Παλιό JIS κανονικό μέγεθος Το μήκος από το κύκλωμα φλάντζας ως την επαφή θερματικού είναι 53,0mm.								-LM Συμπαγείς τύποι(Μήκος μονωτήρα: 14,5 mm)	-S	ειδικός στεγανοποιητικός δακτύλιος			
BK : ISO / JIS κανονικό μέγεθος 50,5mm. Το μήκος από το κύκλωμα φλάντζας ως την επαφή θερματικού είναι 50,5mm.						N ειδικό ηλεκτρόδιο γείωσης	-E	ειδική αντίσταση					
						P Ηλεκτρόδιο πλατίνας Απλό ηλεκτρόδιο γείωσης: Διπλή πλατίνα Πολλαπλό ηλεκτρόδιο γείωσης: Μονή πλατίνα σε κεντρικό ηλεκτρόδιο	IX-P	Μπουζί MAX ιριδίου					
						Q Τετραπλά ηλεκτρόδια γείωσης	LPG 1-8	LaserLine σειρά μπουζί για βενζινοκινητήρες					
						S Στάνταρ τύπος							
						T Τριπλά ηλεκτρόδια γείωσης							
						U Τύπος σπινθήρα μισής ολίσθησης							
						Y Μεσαίο ηλεκτρόδιο με εγκοπή V							
						Z ειδική κατασκευή							



Oznakowania świec zapłonowych

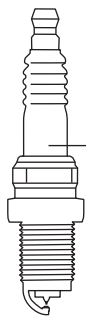

B P R 5 E S - 11

Jednostka:mm

B			P		R		5		E		S		-11				
	Średnica gwintu	rozwartość klucza sześciokątnego	Struktura		Opornik przeciwzakłóceńowy		Wartość ciepła		Długość gwintu		Właściwości konstrukcyjne		Odstęp elektrod				
A	∅ 18,0	Hex 25,4	P	Wysunięta końcówka izolatora	R	Opornik	2	<p>Ciepła</p> <p>Zimna</p>	E	19,0	B	Stała nakrętka SAE (CR8EB)		puste	Motocykl: 0,7-0,8		
B	∅ 14,0	Hex 20,8			Z	Oporność indukcyjna	4		EH	17,5		CM	Skośna elektroda, uziemiona Typ kompaktowy (długość otwartego izolatora: 18,5)		Samochód: 0,8-0,9		
BC	∅ 14,0	Hex 16,0	M	Świeca kompaktowa		5	EH		19,0 wykonany w połowie	H	12,7		CS	Skośna elektroda, uziemiona		-8	0,8
BK	∅ 14,0	Hex 16,0				6	L		11,2	G,GV	Świece zapłonowe wyścigowe:			-9	0,9		
C	∅ 10,0	Hex 16,0	U	Iskra ślizgowa bądź półślizgowa		7	puste		Szczelne gniazdo stożkowe A(P)-F : 10,9 B(P)-F : 11,2 BM(P)-F : 7,8		I	19,0	I	Irydowa elektroda centralna		-10	1,0
D	∅ 12,0	Hex 18,0				8			Świeca małego typu B(P)M- : 9,5 B-LM : 9,5 CM- : 9,5 CM-6 : 8,6 C-50 : 8,5	9	N	Specjalna elektroda masowa		-11	1,1	-S	Specjalny pierścień uszczelniający
DC	∅ 12,0	Hex 16,0	10	P		Elektroda platynowa Pojedyncza elektroda, uziemiona: Podwójna platynowa				elektroda z wielokrotnym uziemieniem: Pojedyncza platyna w elektrodzie centralnej:		-E	Specjalny opornik				
E	∅ 8,0	Hex 13,0	Q			4 elektrody, uziemione			S		Typ standardowy		IX-P	Świeca irydowa MAX			
*Wyjątek B(P)M-A,Y : ∅ 14,0, Hex 19,0 P(P)-(E)F : ∅ 14,0, Hex 16,0 CM-6 : ∅ 10,0, Hex 14,0				T		3 elektrody, uziemione				Y	Elektroda środkowa z nacięciem V			LPG 1-8	Oferta świec zapłonowych LaserLine do silników benzynowych		
BC : Stary rozmiar wg normy JIS Długość od obwodu uszczelki do styku zacisku wynosi 53,0 mm.			U			Iskra półślizgowa			Z		Specjalna konstrukcja						
BK : Rozmiar wg normy ISO/JIS Długość od obwodu uszczelki do styku zacisku wynosi 50,5 mm.																	



Oznakowania świec zapłonowych

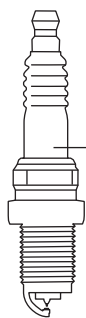

P F R 5 A - 11

Jednostka: mm

P		F				R		5		A		-11			
Typ świecy		Średnica gwintu	Długość gwintu	Konfiguracja gniazda	rozwartość klucza sześciokątnego	Opornik przeciwzakłóceniuowy		Wartość cieplna		Konstrukcja		Odstęp elektrod			
DI	Wysoka zdolność zapłonu, Podwójne, cienkie elektrody	F	∅ 14,0	19,0	Pierścień uszczelniający	Hex 16,0	R	Opornik	2		A,B,C... kod przyrostka		Ie		Motocykl: 0,7-0,8
		FE	∅ 14,0	19,0	Pierścień uszczelniający	Hex 16,0			4				Samochód: 0,8-0,9		
I	Podwójna irydowa świeca zapłonowa	G	∅ 14,0	19,0	Pierścień uszczelniający	Hex 20,8	5	-7	0,7						
L	Długi gwint	J	∅ 12,0	19,0	Pierścień uszczelniający	Hex 18,0	6	-9	0,9						
P	Podwójna platynowa świeca zapłonowa	K	∅ 12,0	19,0	Pierścień uszczelniający	Hex 16,0	7	I	Irydowa elektroda centralna				-10	1,0	
S	Świeca o dużej zapłonowości: typ z wąską końcówką kwadratową	KA	∅ 12,0	19,0	Pierścień uszczelniający	Hex 14,0	8	IX	Elektroda irydowa - typ IX				-11	1,1	
Z	Wysunięta końcówka z elektrodami	KB	∅ 12,0	19,0	Pierścień uszczelniający	Bi-Hex 14,0 (Dwunastokątne *)	9	P	Platynowa elektroda centralna				-13	1,3	
Powyższe oznaczenia mogą być łączone <Przykład>ILFR..., PLZFR..., Jeśli dodano „L”, priorytet ma długość Gwintu „L” (długi zasięg). <Przykład> * świeca z pierścieniem uszczelniającym FR5AP : długość gwintu 19,0mm ↓ LFR5AP-11 : długość gwintu 26,5mm * świeca ze szczelnym gniazdem stożkowym PTR5C-13 : długość gwintu 17,5mm ↓ PLTR6A-10G : długość gwintu 25,0mm		KE	∅ 12,0	19,0	Pierścień uszczelniający	Hex 16,0	10	* Jeśli numer części zaczyna się od liter „I” lub „P” (litery „I” lub „P” po oznaczeniu wartości temperatury są kodem sufiksu). <Przykład> IZFR6P8 jest irydową świecą zapłonową I: Iryd P: Kod sufiksu * <Wyjatek> ZFR0P-G jest niklową świecą zapłonową					-A	brak pierścienia uszczelniającego	
		KF	∅ 12,0	19,0	Pierścień uszczelniający	Hex 14,0	-E						Metalowa osłona: powłoka niklowa		
		KG	∅ 12,0	19,0	Pierścień uszczelniający	Bi-Hex 14,0 (Dwunastokątne *)	-D						Specjalny opornik		
		L	∅ 10,0	12,7	Pierścień uszczelniający	Hex 16,0	-G			Elektroda z rdzeniem miedzianym, uziemiona					
		M	∅ 10,0	19,0	Pierścień uszczelniający	Hex 16,0	-H			Gwint specjalny					
		MA	∅ 10,0	19,0	Pierścień uszczelniający	Hex 14,0	-J			2 elektrody masy					
		MF	∅ 10,0	19,0	Pierścień uszczelniający	Hex 14,0	-K			Elektroda odporna na wibracje, uziemiona					
		NA	∅ 12,0	17,5	Szczelne gniazdo stożkowe	Hex 14,0	-N			Specjalna elektroda masy					
		T	∅ 14,0	17,5	Szczelne gniazdo stożkowe	Hex 16,0	-Q			4 elektrody masowe					
		U	∅ 14,0	11,2	Szczelne gniazdo stożkowe	Hex 16,0	-S			Specjalny pierścień uszczelniający					
W	∅ 18,0	10,9	Szczelne gniazdo stożkowe	Hex 20,8	-T	3 elektrody masy									
X	∅ 14,0	9,5	Pierścień uszczelniający	Hex 20,8	-U	Półpowierzchniowy rodzaj wyładowania									
Y	∅ 14,0	11,2	Szczelne gniazdo stożkowe	Hex 16,0	IX-P	Świeca irydowa MAX									
		*Wyjatek TR5A-10, TR5A-13, TR5B-13, TR6B-10, TR6B-13, PTR5A-10, PTR5A-13: Długość gwintu 25,0mm				Dwunastokątne				LPG 1-8	Oferta świec zapłonowych LaserLine do silników benzynowych				
		*Wymaga gniazda dwunastokątnego.				Sześciokątne									

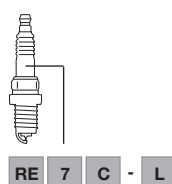

RE 7 C - L

RE		7		C		-L		
Typ świecy		Wartość cieplna		Konstruktion		Odstęp elektrod		
RE	Świeca do silników rotacyjnych	5		A,B,C... kod przyrostka		-L		Dolna strona
SD	Świeca do silników rotacyjnych (przerwa wyładowania półpowierzchniowego)	6				-T	Górna strona	
		7						
		8						
		9						
		10						
		11						

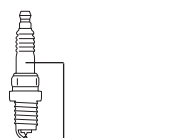

HB 6 A IX - 11 P

HB		6		A		IX		-11		P	
Typ świecy		Wartość cieplna		Średnica gwintu	Długość gwintu	Konfiguracja gniazda	rozwartość klucza sześciokątnego	Odstęp elektrod			
HB	HYBD (typ hybrydowy z 3 elektrodami uziemionymi)	4		A	∅ 14,0	20,5	Pierścień uszczelniający	Hex 16,0	IX	-8	0,8
		5		B	∅ 14,0	19,0	Pierścień uszczelniający	Hex 16,0	-9	0,9	
		6				-10	1,0				
		7				-11	1,1				
		8			-13	1,3					

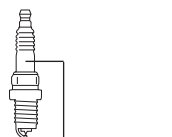

DF 6 H - 11 A

DF		6		H			-11		A		
Typ świecy		Wartość cieplna		Średnica gwintu	Długość gwintu	Konfiguracja gniazda	Sechskant	Odstęp elektrod			
DF	Świeca o dużej zapłonowości (podwójne, cienkie elektrody)	4		A	∅ 14,0	19,0	Pierścień uszczelniający	Hex 16,0	-8	0,8	A,B,C... kod przyrostka
		5		B	∅ 14,0	26,5	Pierścień uszczelniający	Hex 16,0	-9	0,9	
DFH	Świeca o dużej zapłonowości (Typ DF + hybrydowy)	6		C	∅ 12,0	26,5	Pierścień uszczelniający	Hex 14,0	-10	1,0	
		7				-11	1,1				
		8				-13	1,3				
		9			-15	1,5					

Označení zapalovacích svíček

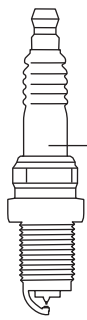

B P R 5 E S - 11

Jednotky: mm

B		P		R		5		E		S		-11				
	Průměr	Šestihran	Struktura	Odrušovací odpor		Teplotná hodnota		Délka závitu		Konstrukční vlastnosti		Vzdálenost elektrod				
A	∅ 18,0	Hex 25,4	P předsunutá špička izolátoru	R	Odpor	2	 teplé typy	E	19,0	B	pevná přípojná matice SAE (CR8EB)	prázdné	Motocykl : 0,7-0,8 Auto : 0,8-0,9			
B	∅ 14,0	Hex 20,8		Z	Induktivní odpor	4		EF	17,5	CM	Šikmé provedení zemnicí elektrody Kompaktní typ (Délka izolátoru: 18,5)					
BC	∅ 14,0	Hex 16,0	M Kompaktní svíčka		5	EH		19,0 provedení do poloviny	H	12,7	CS	Šikmé provedení zemnicí elektrody	-8	0,8		
BK	∅ 14,0	Hex 16,0			6	L		11,2	I		G,GV	Závodní zapalovací svíčka	-9	0,9		
C	∅ 10,0	Hex 16,0			U Typ s klouzavou jiskrou nebo přidavnou dráhou jiskry	7		prázdné Kuželové těsnící sedlo A(P)-F : 10,9 B(P)-F : 11,2 BM(P)-F : 7,8	8	Malý typ svíčky B(P)M- : 9,5 B-LM : 9,5 CM- : 9,5 CM-6 : 8,6 C-50 : 8,5	J	2 zemnicí elektrody (speciální tvar)	-10	1,0		
D	∅ 12,0	Hex 18,0				9			K		2 zemnicí elektrody	-11	1,1			
DC	∅ 12,0	Hex 16,0				10			-LM		Kompaktní typy (délka izolátoru: 14,5mm)	-13	1,3			
E	∅ 8,0	Hex 13,0	N			speciální zemnicí elektroda			-S		speciální těsnící kroužek					
*Výjimka B(P)M-A,Y : ∅ 14,0, Hex 19,0 P(P)-(E)F : ∅ 14,0, Hex 16,0 CM-6 : ∅ 10,0, Hex 14,0 BC : Stará standardní velikost JIS Délka od kroužku těsnění ke koncovému kontaktu je 53,0 mm. BK : Standardní velikost ISO/JIS Délka od kroužku těsnění ke koncovému kontaktu je 50,5 mm.																
											P	Platinová elektroda 1 zemnicí elektroda: Dvojitá platinová	-E	speciální odpor		
											Více zemnicích elektrod: Jedna platinová ve střední elektrodě		IX-P	Iridiová svíčka MAX		
											Q	4 zemnicí elektrody	LPG 1-8	Zapalovací svíčka LaserLine s prodlouženým dosahem pro benzínové motory		
											S	Standardní typy				
											T	3 zemnicí elektrody				
										U	Typ s poloviční klouzavou jiskrou					
										Y	Střední elektroda se zářezem V					
										Z	speciální konstrukce					

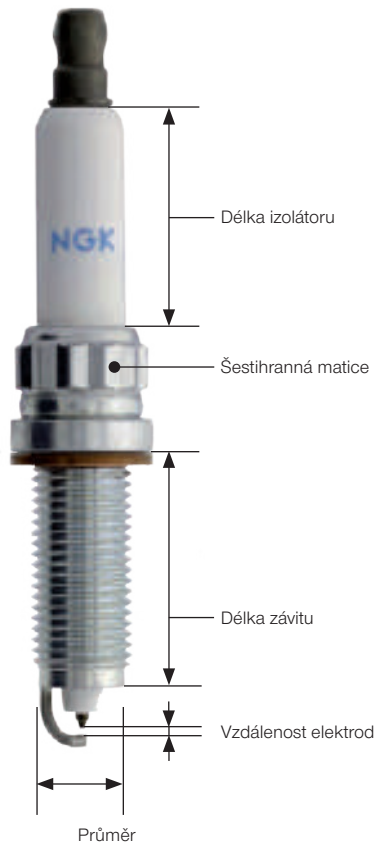

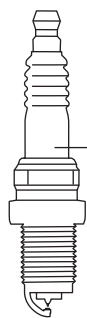

Označení zapalovacích svíček



P F R 5 A - 11

Jednotky: mm

P		F				R		5		A		-11									
Zapalovací typ		Průměr	Délka závitů	Nastavení objímky	šestihran	Odrůsovací odpor		Teplotná hodnota		Konstrukce		Vzdálenost elektrod									
DI	mimořádně vysoká schopnost zapálení, dvojitě provedené, jemné elektrody	F	∅ 14,0	19,0	Těsnicí kroužek	Hex 16,0	R	Odpor	2	teplé typy	A,B,C... kód přípony	prázdné	Motocykl: 0,7-0,8								
	FE	∅ 14,0	19,0	Těsnicí kroužek	Hex 16,0	4			Auto: 0,8-0,9												
I	Dvojitá iridiová zapalovací svíčka	G	∅ 14,0	19,0	Těsnicí kroužek	Hex 20,8			5			studené typy	I	Iridiová centrální elektroda	-7	0,7					
L	mimořádně dlouhý závit	J	∅ 12,0	19,0	Těsnicí kroužek	Hex 18,0			6						-9	0,9					
P	Dvojitá platínová zapalovací svíčka	K	∅ 12,0	19,0	Těsnicí kroužek	Hex 16,0			7						-10	1,0					
S	Svíčka s mimořádně vysokou schopností zapálení: čtvercový platínový čip	KA	∅ 12,0	19,0	Těsnicí kroužek	Hex 14,0			8						IX	Iridiová zapalovací svíčka	-11	1,1			
		KB	∅ 12,0	19,0	Těsnicí kroužek	Bi-Hex 14,0 (Dvojitý šestihřanný *)			9								-13	1,3			
Z	Předsunutě jiskřiště	KE	∅ 12,0	19,0	Těsnicí kroužek	Hex 16,0			10								P	Platínová centrální elektroda	-15	1,5	
Výše uvedená označení se mohou vyskytovat kombinovaně, <Příklad>ILFR..., PLZFR..., pokud je v kódu „L“, pro mimořádně dlouhý závit stojí „L“ před všemi ostatními písmeny délkového označení. <Příklad> * svíčka s těsnicím kroužkem FR5AP : délka závitů ↓ 19,0mm LFR5AP-11 : délka závitů ↓ 26,5mm * svíčka s kuželovým těsnicím sedlem PTR5C-13 : délka závitů ↓ 17,5mm PLTR6A-10G : délka závitů ↓ 25,0mm * Kromě TR5A-10, TR5A-13, TR5B-13, TR6B-10, TR6B-13, PTR5A-10, PTR5A-13: Délka závitů 25,0mm * Je potřeba dvojitá šestihřanná patice * FE, KE, KF, KG, MF: Typ s prodlouženou délkou izolátoru	KF	∅ 12,0	19,0	Těsnicí kroužek	Hex 14,0	Dvojitý šestihřanný 			Odrůsovací odpor								Teplotná hodnota	Konstrukce	Vzdálenost elektrod	-A	bez těsnicího kroužku
	KG	∅ 12,0	19,0	Těsnicí kroužek	Bi-Hex 14,0 (Dvojitý šestihřanný *)															Sestihřanný 	-D
	L	∅ 10,0	12,7	Těsnicí kroužek	Hex 16,0		-E	speciální odpor													
	M	∅ 10,0	19,0	Těsnicí kroužek	Hex 16,0		-G	Zemnicí elektroda s měděným jádrem													
	MA	∅ 10,0	19,0	Těsnicí kroužek	Hex 14,0		-H	speciální závit													
	MF	∅ 10,0	19,0	Těsnicí kroužek	Hex 14,0		-J	2 zemnicí elektrody													
	NA	∅ 12,0	17,5	Kuželové těsnicí sedlo	Hex 14,0		-K	Zemnicí elektroda chráněná proti vibracím													
	T	∅ 14,0	17,5	Kuželové těsnicí sedlo	Hex 16,0		-N	speciální zemnicí elektroda													
	U	∅ 14,0	11,2	Kuželové těsnicí sedlo	Hex 16,0		-Q	4 zemnicí elektrody													
	W	∅ 18,0	10,9	Kuželové těsnicí sedlo	Hex 20,8		-S	speciální těsnicí kroužek													
	X	∅ 14,0	9,5	Těsnicí kroužek	Hex 20,8		-T	3 zemnicí elektrody													
	Y	∅ 14,0	11,2	Kuželové těsnicí sedlo	Hex 16,0		-U	Typ s poloviční klouzavou jiskrou													
							IX-P	Iridiová svíčka MAX													
					LPG 1-8	Zapalovací svíčka LaserLine s prodlouženým dosahem pro benzínové motory															

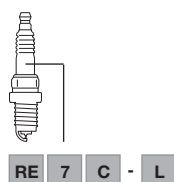

RE 7 C - L

RE		7		C		-L		
Zapalovací typ		Teplotná hodnota		Konstrukce		Vzdálenost elektrod		
RE	Svíčka pro rotační motory	5	teplé typy	A,B,C... kód přípony		-L	Strana předstihu	
SD	Svíčka pro rotační motory (Poloviční s klouzavou jiskrou)	6				studené typy	-T	Pracovní strana
		7						
		8						
		9						
		10						
		11						

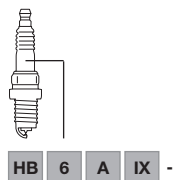

HB 6 A IX - 11 P

HB		6		A				IX		-11		P	
Zapalovací typ		Teplotná hodnota		Průměr	Délka závitů	Nastavení objímky	šestihran	Vzdálenost elektrod					
HB	HYBD (hybridní typ s 3 zemnicími elektrodami)	4	teplé typy	A	∅ 14,0	20,5	Těsnicí kroužek	Hex 16,0	IX	-8	0,8		
		5		B	∅ 14,0	19,0	Těsnicí kroužek	Hex 16,0		-9	0,9		
		6		-10	1,0								
		7		-11	1,1								
		8		-13	1,3								

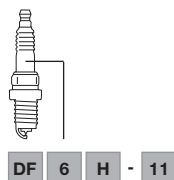

DF 6 H - 11 A

DF		6		H				-11		A			
Zapalovací typ		Teplotná hodnota		Průměr	Délka závitů	Nastavení objímky	šestihran	Vzdálenost elektrod					
DF	Svíčka s mimořádně vysokou schopností zapálení (Dvojitá přesná elektroda)	4	teplé typy	A	∅ 14,0	19,0	Těsnicí kroužek	Hex 16,0		-8	0,8	A,B,C... kód přípony	
		5		B	∅ 14,0	26,5	Těsnicí kroužek	Hex 16,0		-9	0,9		
		6		C	∅ 12,0	26,5	Těsnicí kroužek	Hex 14,0		-10	1,0		
		7		* DF6H-11A : Délka závitů 28,0mm		-11	1,1						
		8		-13	1,3								
		9	studené typy	-15	1,5								

Gyújtógyertyák jelzései

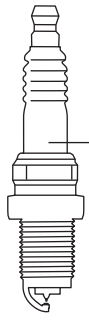

B P R 5 E S - 11

Egység: mm

B		P		R		5		E		S		-11				
Menet átmérő	hatlap	Struktúra	Zavarszűrő ellenállás	Hőérték	Menethossz	Konstrukciós jellemzők		Elektrodahézag								
A	∅ 18,0	Hex 25,4	P	előretölt szigetelőcsúcs	R	Ellenállás	2	meleg típus	E	19,0	B	rögzített SAE csatlakozó anya (CR8EB)	üres	Motorkerékpár: 0,7-0,8		
B	∅ 14,0	Hex 20,8	M	Kompakt gyertya	Z	induktív ellenállás	4		EF	17,5	CM	Ferde testelektródaKompakt kivitel (Kített szigetelés hossz: 18,5)		Autó: 0,8-0,9		
BC	∅ 14,0	Hex 16,0	U	Siklószikrás típus vagy kiegészítő szikraút			5		EH	19,0 félig kivezetett	H	12,7	CS	Ferde testelektróda	-8	0,8
BK	∅ 14,0	Hex 16,0					6		L	11,2	G,GV	Versenygyertya	-9	0,9		
C	∅ 10,0	Hex 16,0	7	Kúpos tömítő ülék A(P)-F : 10,9 B(P)-F : 11,2 BM(P)-F : 7,8 Kis dugó típus B(P)M- : 9,5 B-LM : 9,5 CM- : 9,5 CM-6 : 8,6 C-50 : 8,5	8	üres	Küpos tömítő ülék A(P)-F : 10,9 B(P)-F : 11,2 BM(P)-F : 7,8		I	Irídium középelektróda	-10	1,0				
D	∅ 12,0	Hex 18,0	9		IX	irídium gyújtógyertya	-11		1,1							
DC	∅ 12,0	Hex 16,0	10		hideg típus	hideg típus	J		2 vetített testelektróda	-13	1,3					
E	∅ 8,0	Hex 13,0				K	2 testelektróda		-15	1,5						
*Kivétel B(P)M-A,Y : ∅ 14,0, Hex 19,0 P(P)-(E)F : ∅ 14,0, Hex 16,0 CM-6 : ∅ 10,0, Hex 14,0									-LM	Kompakt típus (szigetelőhossz: 14,5 mm)	-S	speciális tömítőgyűrű				
BC : Régi JIS szabvány méret A tömítés és a csatlakozás közötti távolság 53,0mm.									N	speciális testelektróda	-E	speciális ellenállás				
BK : ISO / JIS szabvány méret A tömítés és a csatlakozás közötti távolság 50,5mm.									P	platina elektróda Egyetlen testelektróda Dupla platina	IX-P	Irídium MAX gyertya				
										Multi testelektróda: Egyetlen platina középelektróda	LPG 1-8	Laserline gyújtógyertya tartomány gázmotor használatra				
								Q	4 testelektróda							
								S	Normál típus							
								T	3 testelektróda							
								U	Félig siklószikrás típus							
								Y	középelektróda V horonnyal							
								Z	speciális kialakítás							

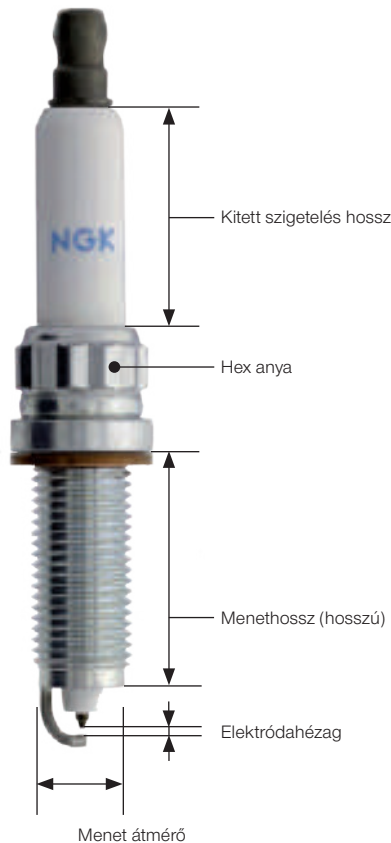

Gyújtógyertyák jelzései

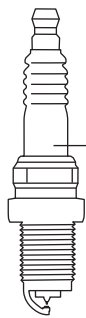

P F R 5 A - 11

Egység: mm

P		F				R		5		A		-11					
Gyertyatípus		Menet átmérő	Menethossz	Fenek konfiguráció	hatlap	Zavarszűrő ellenállás		Hőérték		Konstrukció		Elektródahézag					
DI	különösen magas gyújtóképesség, duplán kivezetett, finom elektródák	F	∅ 14,0	19,0	Tömítés	Hex 16,0	R	Ellenállás	2	meleg típus	A,B,C... Suffix code		üres	Motorkerékpár: 0,7-0,8			
		FE	∅ 14,0	19,0	Tömítés	Hex 16,0			4		Autó: 0,8-0,9						
I	Dupla iridium gyújtógyertya	G	∅ 14,0	19,0	Tömítés	Hex 20,8			5			6	Iridium közélektroda	-7	0,7		
L	különösen hosszú menet	J	∅ 12,0	19,0	Tömítés	Hex 18,0			7			-9		0,9			
P	Dupla platina gyújtógyertya	K	∅ 12,0	19,0	Tömítés	Hex 16,0			8			-10		1,0			
S	Magas hőértékű gyertya: vékony négyzetes hegy típus	KA	∅ 12,0	19,0	Tömítés	Hex 14,0			9			-11		1,1			
Z	Tervezett gyújtógyertya vég	KB	∅ 12,0	19,0	Tömítés	Bi-Hex 14,0 (Kettős hatszögletű *)			10			hideg típus		IX	iridium gyújtógyertya	-13	1,3
A fent felsorolt jelölések kombinációként is előfordulhatnak, <Példa>ILFR..., PLZFR..., Amikor „L” szerepel, prioritást kap az „L” (hosszú menet) a menethosszban. <Példa> *gyertya tömítéssel FR5AP : menethossz ↓ 19,0mm LFR5AP-11 : menethossz 26,5mm *gyertya kúpos tömítő üléssel PTR5C-13 : menethossz ↓ 17,5mm PLTR6A-10G : menethossz 25,0mm		KE	∅ 12,0	19,0	Tömítés	Hex 16,0			* Ha az alkatrész szám előtt áll egy „I” vagy egy „P” (az „I” vagy a „P” a hőszabályozás suffix kódjának van). <Példa> Az IZFR6P8 egy iridium gyújtógyertya I : Iridium P : Suffix kód * <Kivétel> A ZFR0P-G egy nikkell gyújtógyertya			-A		nincs tömítőgyűrű			
		KF	∅ 12,0	19,0	Tömítés	Hex 14,0						-D		Fém persely: galvanizált			
		KG	∅ 12,0	19,0	Tömítés	Bi-Hex 14,0 (Kettős hatszögletű *)						-E		speciális ellenállás			
		L	∅ 10,0	12,7	Tömítés	Hex 16,0	-G	Rézmagos testelettroda									
		M	∅ 10,0	19,0	Tömítés	Hex 16,0	-H	speciális menet									
		MA	∅ 10,0	19,0	Tömítés	Hex 14,0	-J	2 testelettroda									
		MF	∅ 10,0	19,0	Tömítés	Hex 14,0	-K	Testelettroda rezgéssel szembeni ellenállása									
		NA	∅ 12,0	17,5	Kúpos tömítő ülék	Hex 14,0	-N	speciális testelettroda									
		T	∅ 14,0	17,5	Kúpos tömítő ülék	Hex 16,0	-Q	4 testelettroda									
		U	∅ 14,0	11,2	Kúpos tömítő ülék	Hex 16,0	-S	speciális tömítőgyűrű									
W	∅ 18,0	10,9	Kúpos tömítő ülék	Hex 20,8	-T	3 testelettroda											
X	∅ 14,0	9,5	Tömítés	Hex 20,8	-U	Fél kúpszószikrás típus											
Y	∅ 14,0	11,2	Kúpos tömítő ülék	Hex 16,0	-J	Iridium MAX gyertya											
		* Kivétel TR5A-10, TR5A-13, TR5B-13, TR6B-10, TR6B-13, PTR5A-10, PTR5A-13 : Menethossz 25,0mm ** Kettős hatszögletű aljzat szükséges. * FE, KE, KF, KG, MF : Hosszabban kitett szigetelés hossz típus				 Kettős hatszögletű Hatszögletű		IX-P	Iridium MAX gyertya	LPG 1-8	Laserline gyújtógyertya tartomány gázmotor használatra						

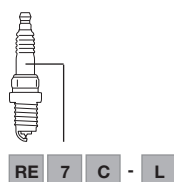

RE		7		C		-L	
Gyertyatípus		Hőérték		Konstrukció		Elektródahézag	
RE	Forgódugattyús motor gyertya	5	meleg típus	A,B,C... Suffix code		-L	Leading oldal
SD	Forgódugattyús motor gyertya (Fél kúpszószikrás hézag)	6					
		7					
		8					
		9					
		10					
		11	hideg típus			-T	Trading oldal

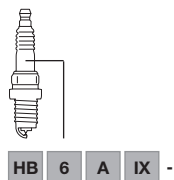

HB		6		A				IX		-11		P	
Gyertyatípus		Hőérték		Menet átmérő	Menethossz	Fenek konfiguráció	hatlap			Elektrodahézag			
HB	HYBD (3 testelettroda hibrid típus)	4	meleg típus	A	∅ 14,0	20,5	Tömítés	Hex 16,0	IX	-8	0,8		
		5		B	∅ 14,0	19,0	Tömítés	Hex 16,0		-9	0,9		
		6								-10	1,0		
		7								-11	1,1		
		8	hideg típus							-13	1,3		

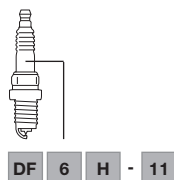

DF		6		H				-11		A			
Gyertyatípus		Hőérték		Menet átmérő	Menethossz	Fenek konfiguráció	hatlap			Elektrodahézag			
DF	Nagy hőértékű gyertya (dupla finom elektródák)	4	meleg típus	A	∅ 14,0	19,0	Tömítés	Hex 16,0		-8	0,8	A,B,C... Suffix code	
		5		B	∅ 14,0	26,5	Tömítés	Hex 16,0		-9	0,9		
DFH	Nagy hőértékű gyertya (DF + hibrid típus)	6		C	∅ 12,0	26,5	Tömítés	Hex 14,0		-10	1,0		
		7		*DF6H-11A : Menethossz 28,0mm				-11		1,1			
		8						-13		1,3			
		9		hideg típus									

Маркировка свечей зажигания

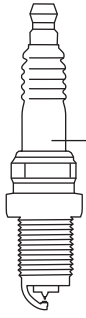

R **F** **5** **A** - **11**

Единица измерения : мм

P		F				R	5		A		-11	
Типы свечей зажигания		Диаметр резьбы	Длина резьбы	Тип основания	Длина резьбы	Помехоподавляющий резистор	Калильное число		Конструкция		Межэлектродный зазор	
DI	Свеча с повышенной надёжностью зажигания, с особо тонким электродом	F	φ 14,0	19,0	Уплотнительное кольцо	R с резистором	2	горячие	A, B, C... Suffix код	пустой	Мотоцикл: 0,7-0,8	
		FE	φ 14,0	19,0	Уплотнительное кольцо						Hex 16,0	Автомобиль: 0,8-0,9
I	Двойная иридиевая свеча зажигания	G	φ 14,0	19,0	Уплотнительное кольцо	R с резистором	4	горячие	A, B, C... Suffix код	пустой	Мотоцикл: 0,7-0,8	
		J	φ 12,0	19,0	Уплотнительное кольцо						Hex 18,0	Автомобиль: 0,8-0,9
L	Удлиненная резьбовая часть	K	φ 12,0	19,0	Уплотнительное кольцо	R с резистором	5	горячие	A, B, C... Suffix код	пустой	Мотоцикл: 0,7-0,8	
P	Двойная платиновая свеча зажигания	KA	φ 12,0	19,0	Уплотнительное кольцо						Hex 16,0	Автомобиль: 0,8-0,9
S	Свеча с повышенной надёжностью зажигания : тонкая квадратная платиновая вставка	KB	φ 12,0	19,0	Уплотнительное кольцо	R с резистором	6	горячие	A, B, C... Suffix код	пустой	Мотоцикл: 0,7-0,8	
		KE	φ 12,0	19,0	Уплотнительное кольцо						Hex 14,0	Автомобиль: 0,8-0,9
Z	выступающий запальный конец	KF	φ 12,0	19,0	Уплотнительное кольцо	R с резистором	7	горячие	A, B, C... Suffix код	пустой	Мотоцикл: 0,7-0,8	
U	Указанные выше обозначения могут быть комбинированными, <Пример>ILFR..., PLZFR..., При наличии индекса «L», приоритетным в определении длины резьбы является индекс «L» (длинная резьбовая часть). <Пример> * Свеча с уплотнительным кольцом	KG	φ 12,0	19,0	Уплотнительное кольцо						R с резистором	8
		L	φ 10,0	12,7	Уплотнительное кольцо	Hex 16,0	Автомобиль: 0,8-0,9					
R5AP	↓ длина резьбы 19,0мм	M	φ 10,0	19,0	Уплотнительное кольцо	R с резистором	9	горячие	A, B, C... Suffix код	пустой	Мотоцикл: 0,7-0,8	
		MF	φ 10,0	19,0	Уплотнительное кольцо						Hex 14,0	Автомобиль: 0,8-0,9
LFR5AP-11	↓ длина резьбы 26,5мм	NA	φ 12,0	17,5	Коническая плотная посадка	R с резистором	10	горячие	A, B, C... Suffix код	пустой	Мотоцикл: 0,7-0,8	
		T	φ 14,0	17,5	Коническая плотная посадка						Hex 16,0	Автомобиль: 0,8-0,9
PTR5C-13	↓ длина резьбы 17,5мм	U	φ 14,0	11,2	Коническая плотная посадка	R с резистором	10	горячие	A, B, C... Suffix код	пустой	Мотоцикл: 0,7-0,8	
		W	φ 18,0	10,9	Коническая плотная посадка						Hex 20,8	Автомобиль: 0,8-0,9
PLTR6A-10G	↓ длина резьбы 25,0мм	X	φ 14,0	9,5	Уплотнительное кольцо	R с резистором	10	горячие	A, B, C... Suffix код	пустой	Мотоцикл: 0,7-0,8	
		Y	φ 14,0	11,2	Коническая плотная посадка						Hex 16,0	Автомобиль: 0,8-0,9
* Исключения TR5A-10, TR5A-13, TR5B-13, TR6B-10, TR6B-13, PTR5A-10, PTR5A-13 : Длина резьбы 25,0mm					Двойной шестигранник							
* Необходима головка с двойным шестигранником.					Шестигранник							
* FE, KE, KF, KG, MF : Увеличенная длина выступающего изолятора												
										-A	без уплотнительного кольца	
										-D	Никелевое покрытие металлического корпуса	
										-E	Специальное сопротивление	
										-G	Боковой электрод с медным сердечником	
										-H	Специальная резьба	
										-J	2 боковых электрода	
										-K	Вибростойкий боковой электрод	
										-N	Специальный боковой электрод	
										-Q	4 боковых электрода	
										-S	Специальное уплотнительное кольцо	
										-T	3 боковых электрода	
										-U	Тип с полуповерхностным разрядом	
										IX-P	Свеча Iridium MAX	
										LPG 1-8	Свечи зажигания LaserLine для газовых двигателей for gas engines	

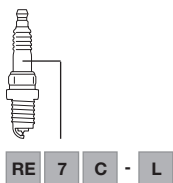

R **E** **7** **C** - **L**

RE		7	C		-L			
Типы свечей зажигания		Калильное число		Конструкция		Межэлектродный зазор		
RE	Свеча для роторных двигателей	5	горячие		A, B, C... Suffix код		-L Ведущая сторона	
SD	Свеча для роторных двигателей (полуповерхностный разряд и дополнительный зазор)	6	горячие				-T Ведомая сторона	
		7	горячие					
		8	горячие					
		9	горячие					
		10	горячие					
		11	холодные					

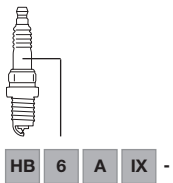

N **B** **6** **A** **I** **X** - **11** **P**

NB		6		A				IX	-11		P	
Типы свечей зажигания		Калильное число		Диаметр резьбы	Длина резьбы	Тип основания	Шестигранник		Межэлектродный зазор			
NB	НУВД (гибридный тип с 3 боковыми электродами)	4	горячие		A	φ 14,0	20,5	Уплотнительное кольцо	Hex 16,0	IX	-8	0,8
		5	горячие		B	φ 14,0	19,0	Уплотнительное кольцо	Hex 16,0		-9	0,9
		6	горячие								-10	1,0
		7	горячие								-11	1,1
		8	холодные							-13	1,3	

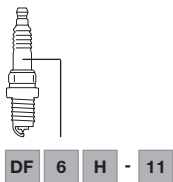

D **F** **6** **H** - **11** **A**

DF		6		H				-11		A		
Типы свечей зажигания		Калильное число		Диаметр резьбы	Длина резьбы	Тип основания	Шестигранник	Межэлектродный зазор				
DF	Свеча с повышенной надёжностью зажигания (двойные тонкие электроды)	4	горячие		A	φ 14,0	19,0	Уплотнительное кольцо	Hex 16,0	-8	0,8	
		5	горячие		B	φ 14,0	26,5	Уплотнительное кольцо	Hex 16,0	-9	0,9	
DFH	Свеча с повышенной надёжностью зажигания (DF + гибридный тип)	6	горячие		C	φ 12,0	26,5	Уплотнительное кольцо	Hex 14,0	-10	1,0	
		7	горячие		* DF6H-11A : Длина резьбы 28,0mm						-11	1,1
		8	горячие								-13	1,3
		9	холодные								-15	1,5

Tightening torques for spark plugs

Torques

A torque wrench is required for the professional installation of a spark plug. Even for professionals the estimation of the tightening torque is nearly impossible.

That is because a torque can be calculated from two sizes which are multiplied by one another: the force which is applied to the respective centre of rotation and the length of the handle.

Most spark plug failures can be traced back to an incorrect tightening torque. If it is set too low, there is a risk of compression losses and overheating. A break of the insulator or middle electrode as a result of vibrations is also feasible.

If the tightening torque is set too high, the spark plug can snap off. The casing can also expand or warp. Heat dissipation zones are disrupted, overheating and melting of the electrodes or even engine damage can occur.

Cylinder head material	Spark plug with flat seat (with gasket)				Spark plug with conical seat	
	18 mm	14 mm	12 mm	10 mm	18 mm	14 mm
Cast iron head	35-45 Nm	25-35 Nm	15-25 Nm	10-15 Nm	20-30 Nm	15-25 Nm
Aluminium head	35-40 Nm	25-30 Nm	15-20 Nm	10-12 Nm	20-30 Nm	10-20 Nm

The torques depend on the cylinder head material and the thread diameter.

Tightening torques for glow plugs

The correct torque

For the professional installation of a glow plug, the use of a torque wrench is recommended. Even for professionals the estimation of the tightening torque is nearly impossible.

That is because a torque can be calculated from two sizes which are multiplied by one another: the

force which is applied to the respective centre of rotation and the length of the handle.

If the incorrect torque is applied to a glow plug, a compression loss can result. Based on the vibrations, it is also possible in the case of ceramic glow plugs that the ceramic will break.

The application of a tightening torque which is too great, in particular, can lead to the contraction of the annular gap between the metal case and glow tube. In this case the glow plug overheats and fails.

! Please follow the instruction if specified tightening torque or angle is mentioned on the package !!!

Metal Glow Plug					Ceramic Glow Plug	
Thread diameter					Thread diameter	
M8	M9	M10	M12	M14	M8	M10
8,5 Nm	11 Nm	15 Nm	23 Nm	23 Nm	10 Nm	18 Nm
+/- 10	+/- 10	+/- 10	+/- 10	+/- 10	+/- 10	+/- 10

Tightening torque for the connecting nuts	
Thread diameter	Tightening torque
4 mm (M4)	0,8-1,5 Nm
5 mm (M5)	3,0-4,0 Nm

Glow plugs will only function faultlessly when they are screwed in with the correct torques.

Drehmomente Zündkerzen

Das richtige Drehmoment für Zündkerzen

Für die fachgerechte Montage einer Zündkerze ist ein Drehmomentschlüssel erforderlich. Denn selbst für Werkstattprofis ist das "Schätzen" des Anzugsdrehmomentes nahezu unmöglich.

Das liegt daran, dass sich ein Drehmoment aus zwei Größen errechnet, die miteinander multipliziert werden: der Kraft, die auf den jeweiligen Drehpunkt einwirkt, und der Länge des Hebels.

Die meisten Zündkerzenausfälle gehen auf ein falsches Anzugsdrehmoment zurück. Wird es zu niedrig gewählt, drohen Kompressionsverluste und Überhitzung. Auch ein Bruch von Isolator oder Mittelelektrode infolge von Vibrationen ist denkbar.

Wird das Drehmoment zu hoch gewählt, kann es zum Abreißen der Zündkerze führen. Auch kann das Gehäuse sich dehnen oder verdrehen. Die Wärmeabflusszonen werden gestört, es drohen Überhitzung und Verschmelzung der Elektroden bis hin zum Motorschaden.

Zylinderkopf-Material	Zündkerze mit flachem Sitz (mit Dichtung)				Zündkerze mit konischem Sitz	
	Gewindedurchmesser				Gewindedurchmesser	
	18 mm	14 mm	12 mm	10 mm	18 mm	14 mm
Gusseisenkopf	35-45 Nm	25-35 Nm	15-25 Nm	10-15 Nm	20-30 Nm	15-25 Nm
Aluminiumkopf	35-40 Nm	25-30 Nm	15-20 Nm	10-12 Nm	20-30 Nm	10-20 Nm

Die Drehmomente sind vom Zylinderkopfmateriale und dem Gewindedurchmesser abhängig.

Drehmomente Glühkerzen

Das richtige Drehmoment für den Einbau von Glühkerzen

Für die fachgerechte Montage einer Glühkerze empfiehlt sich die Verwendung eines Drehmomentschlüssels. Denn selbst für Werkstattprofis ist das „Schätzen“ des Anzugsdrehmomentes nahezu unmöglich.

Das liegt daran, dass sich ein Drehmoment aus zwei Größen errechnet, die miteinander

multipliziert werden: der Kraft, die auf den jeweiligen Drehpunkt einwirkt, und der Länge des Hebels.

Wird bei einer Glühkerze ein falsches Drehmoment angewendet, kann es zu Kompressionsverlusten kommen. Aufgrund von Vibrationen ist bei keramischen Glühkerzen außerdem ein Bruch der Keramik möglich.

Auch kann insbesondere die Verwendung eines zu großen Anzugsdrehmoments zum Zusammenziehen des Ringspalts zwischen Metallgehäuse und Glührohr führen. In diesem Fall überhitzt die Glühkerze und fällt aus.

! Bitte beachten Sie die Anzugsdrehmomente oder -Winkel, wenn diese auf der Verpackung angegeben sind!

Metallstabglühkerze					Keramische Glühkerze	
Gewindedurchmesser					Gewindedurchmesser	
M8	M9	M10	M12	M14	M8	M10
8,5 Nm	11 Nm	15 Nm	23 Nm	23 Nm	10 Nm	18 Nm
+/- 10	+/- 10	+/- 10	+/- 10	+/- 10	+/- 10	+/- 10

Anzugsdrehmomente von Anschlussmuttern	
Gewindedurchmesser	Anzugsdrehmoment
4 mm (M4)	0,8–1,5 Nm
5 mm (M5)	3,0–4,0 Nm

Nur wenn Glühkerzen mit den richtigen Drehmomenten eingeschraubt werden funktionieren diese einwandfrei

Couples de serrage Bougies d'allumage

Couples de serrage

Une clé dynamométrique est obligatoire pour monter correctement une bougie d'allumage. Même pour un réparateur confirmé, il est pratiquement impossible d'estimer précisément un couple de serrage.

Le couple de serrage est à deux composantes : La force au point de rotation et la longueur du levier. Ce qui rend son estimation difficile.

La majorité des pannes liées aux bougies d'allumage sont dues à un couple de serrage incorrect.

S'il est choisi faible, la perte de compression peut générer une surchauffe et les vibrations peuvent créer une rupture de l'isolant ou de l'électrode centrale.

A contrario, S'il est trop élevé, il peut résulter un arrachage du

filetage de la bougie d'allumage. Le culot peut également se serrer dans la culasse. Les zones d'évacuation de chaleur peuvent se détruire, ce qui peut provoquer une surchauffe et une fonte des électrodes voire même une panne du moteur.

Matériau de culasse	Bougie d'allumage à siège plat (avec joint d'étanchéité)				Bougie d'allumage à siège conique	
	Diamètre de filet				Diamètre de filet	
	18 mm	14 mm	12 mm	10 mm	18 mm	14 mm
Culasse en fonte de fer	35-45 Nm	25-35 Nm	15-25 Nm	10-15 Nm	20-30 Nm	15-25 Nm
Culasse en aluminium	35-40 Nm	25-30 Nm	15-20 Nm	10-12 Nm	20-30 Nm	10-20 Nm

Le couple de serrage dépend du matériau de la culasse et du diamètre de filetage du culot de la bougie.

Couples de serrage Bougies de préchauffage

Le bon couple de serrage

Pour monter correctement une bougie de préchauffage, il est recommandé d'utiliser une clé dynamométrique. Car même pour les mécaniciens il est presque impossible d'estimer le couple de serrage.

Ceci vient du fait qu'un couple de serrage est composé de deux valeurs qui sont à multiplier

ensemble : la force qui agit sur le point de rotation respectif et la longueur du levier.

Si on applique un couple de serrage erroné à une bougie de préchauffage, ceci peut entraîner des pertes de compression. Pour les bougies de préchauffage en céramique, une rupture de la céramique est possible en raison des vibrations.

De même, l'application d'un couple de serrage trop important peut conduire à une rétractation de la fente du segment entre le culot et le tube de préchauffage. Dans ce cas de figure, la bougie de préchauffage surchauffe et grille.

! Veuillez suivre les instructions si un couple ou un angle de serrage est spécifié sur l'emballage !!

Bougie de préchauffage en métal					Bougie de préchauffage en céramique	
Diamètre de filet					Diamètre de filet	
M8	M9	M10	M12	M14	M8	M10
8,5 Nm	11 Nm	15 Nm	23 Nm	23 Nm	10 Nm	18 Nm
+/- 10	+/- 10	+/- 10	+/- 10	+/- 10	+/- 10	+/- 10

Couples de serrage des écrous de raccord	
Diamètre de filet	Couple de serrage
4 mm (M4)	0,8-1,5 Nm
5 mm (M5)	3,0-4,0 Nm

Pour que les bougies de préchauffage fonctionnent parfaitement, elles doivent être vissées avec le bon couple de serrage

Coppie di serraggio candele

Coppie di serraggio

Per installare a regola d'arte una candela di accensione è necessario utilizzare una chiave dinamometrica.

La coppia di serraggio è data dal prodotto tra la forza applicata per il serraggio e la lunghezza del braccio della chiave (leva).

Molti degli inconvenienti riscontrabili sulle candele sono riconducibili ad una coppia di serraggio errata. Se la coppia risulta troppo bassa potrebbero

verificarsi perdite di compressione e surriscaldamenti. Si può anche incorrere ad una rottura dell'isolatore o dell'elettrodo centrale in conseguenza delle vibrazioni.

Se la coppia di serraggio risulta troppo elevata, il corpo metallico

della candela potrebbe subire deformazioni a tal punto da compromettere l'efficienza dello scambio termico della candela. Naturale conseguenza sono fenomeni di surriscaldamento e danni al motore.

Materiale testata	Candela con sede piatta (con guarnizione)				Candele con sede conica	
	Diametro filettatura				Diametro filettatura	
	18 mm	14 mm	12 mm	10 mm	18 mm	14 mm
Testata in ghisa	35-45 Nm	25-35 Nm	15-25 Nm	10-15 Nm	20-30 Nm	15-25 Nm
Testata in alluminio	35-40 Nm	25-30 Nm	15-20 Nm	10-12 Nm	20-30 Nm	10-20 Nm

Le coppie di serraggio dipendono dal materiale della testata e dal diametro della filettatura

Coppie di serraggio candelette

La coppia corretta

Per il montaggio a regola d'arte di una candeletta si consiglia l'uso di una chiave dinamometrica.

Persino per i professionisti dell'officina, infatti, è praticamente impossibile valutare la coppia di serraggio senza lo strumento adatto.

La coppia è data dal prodotto tra la forza applicata per il serraggio e la lunghezza del braccio della chiave (leva).

Se ad una candeletta viene applicata una coppia errata, possono verificarsi perdite di compressione. A causa delle vibrazioni, inoltre, nelle candelette

con bulbo ceramico potrebbe verificarsi una rottura della ceramica.

L'applicazione di una coppia di serraggio eccessivo può anche causare una deformazione del corpo metallico. In questo caso la candeletta può anche surriscaldarsi e guastarsi.

! Se sulla confezione è indicato un angolo o una coppia di serraggio specifico, attenersi alle indicazioni !!!

Candele metallica					Candele ceramica	
Diametro filettatura					Diametro filettatura	
M8	M9	M10	M12	M14	M8	M10
8,5 Nm	11 Nm	15 Nm	23 Nm	23 Nm	10 Nm	18 Nm
+/- 10	+/- 10	+/- 10	+/- 10	+/- 10	+/- 10	+/- 10

Coppia di serraggio dei dadi di collegamento	
Diametro filettatura	Coppia di serraggio
4 mm (M4)	0,8-1,5 Nm
5 mm (M5)	3,0-4,0 Nm

Le candelette funzionano correttamente solo se vengono avitate con le coppie giuste

Pares de apriete Bujías de encendido

Pares de apriete

Para montar correctamente una bujía se necesita una llave dinamométrica, puesto que incluso para los técnicos profesionales de los talleres resulta casi imposible calcular el par de apriete correcto.

Esto se debe a que los pares de apriete se calculan multiplicando dos dimensiones: la fuerza que se aplica sobre el punto de giro correspondiente y la longitud de la palanca.

La mayoría de los fallos que se producen en las bujías se deben a que el par de apriete es incorrecto. Si es demasiado bajo, las pérdidas de compresión podrían provocar un sobrecalentamiento. También se podría romper el aislador o el electrodo central a consecuencia de las vibraciones.

Si el par de apriete es demasiado alto, la bujía se podría romper. También la caja podría expandirse o torcerse. Las zonas de salida del calor se estropearían, los electrodos podrían sufrir sobrecalentamiento o fundirse y provocar una avería en el motor.

Material de la culata	Bujía de encendido con base plana (con junta)				Bujía de encendido con base cónica	
	Diámetro de la rosca				Diámetro de la rosca	
	18 mm	14 mm	12 mm	10 mm	18 mm	14 mm
Culata de fundición	35-45 Nm	25-35 Nm	15-25 Nm	10-15 Nm	20-30 Nm	15-25 Nm
Culata de aluminio	35-40 Nm	25-30 Nm	15-20 Nm	10-12 Nm	20-30 Nm	10-20 Nm

Los pares de apriete dependen del material de la culata y del diámetro de la rosca

Pares de apriete Bujías de incandescencia

El par de apriete correcto

Para garantizar el montaje correcto de un calentador se recomienda utilizar una llave dinamométrica, puesto que incluso para los técnicos profesionales de los talleres resulta casi imposible calcular el par de apriete correcto.

Esto se debe a que los pares de apriete se calculan a partir de dos

valores que se multiplican entre sí: la fuerza que se aplica sobre el punto de giro correspondiente y la longitud de la palanca.

Si se aplica un par de apriete incorrecto a una bujía se pueden producir pérdidas de la compresión. La parte cerámica de los calentadores de cerámica además podría romperse por efecto de las vibraciones.

Sobre todo, si se aplica un par de apriete demasiado grande podría reducirse el espacio anular entre la caja metálica y el tubo de incandescencia, provocando el sobrecalentamiento del calentador, que dejaría de funcionar.

!!!Siga las instrucciones del embalaje si se especifica un par o un ángulo de apriete en concreto!!!

Calentador metálico					Calentador de cerámica	
Diámetro de la rosca					Diámetro de la rosca	
M8	M9	M10	M12	M14	M8	M10
8,5 Nm	11 Nm	15 Nm	23 Nm	23 Nm	10 Nm	18 Nm
+/- 10	+/- 10	+/- 10	+/- 10	+/- 10	+/- 10	+/- 10

Pares de apriete de las tuercas de conexión	
Diámetro de la rosca	Par de apriete
4 mm (M4)	0,8-1,5 Nm
5 mm (M5)	3,0-4,0 Nm

Sólo cuando los calentadores están atornillados con el par de apriete correcto pueden funcionar correctamente

Aandraaimomenten bougies

Aandraaimomenten

Voor de vakkundige montage van een bougie is een draaimomentsleutel noodzakelijk. Want zelfs voor vakmensen uit een garage is het vrijwel onmogelijk om het aandraaimoment te schatten.

Dat komt doordat een aandraaimoment berekend wordt door twee grootheden met elkaar te vermenigvuldigen: de kracht, die op het betreffende draaipunt inwerkt en de lengte van de hendel.

Als een bougie uitvalt, is een verkeerd aandraaimoment meestal de oorzaak hiervan. Als het aandraaimoment te laag is, bestaat gevaar voor compressieverlies en oververhitting. Ook is een breuk van de isolator of de midden-elektrode denkbaar als gevolg van trillingen.

Als het aandraaimoment te hoog is, kan de bougie afbreken. Ook kan de behuizing uitzetten of zich verdraaien. De zones voor de warmteafleiding worden vernield, er bestaat gevaar voor oververhitting, samensmelten van de elektroden en zelfs motorschade.

Cilinderkop- materiaal	Bougie met vlakke zitting (met dichting)				Bougie met conische zitting	
	Schroefdraaddiameter				Schroefdraaddiameter	
	18 mm	14 mm	12 mm	10 mm	18 mm	14 mm
Gietijzeren kop	35-45 Nm	25-35 Nm	15-25 Nm	10-15 Nm	20-30 Nm	15-25 Nm
Aluminium kop	35-40 Nm	25-30 Nm	15-20 Nm	10-12 Nm	20-30 Nm	10-20 Nm

De aandraaimomenten zijn afhankelijk van het cilinderkopmateriaal en de schroefdraaddiameter

Aandraaimomenten gloeibougies

Aandraaimomenten

Om een gloeibougie vakkundig te kunnen monteren, is het raadzaam om gebruik te maken van een draaimomentsleutel. Want zelfs voor vakmensen uit een garage is het vrijwel onmogelijk om het aandraaimoment te schatten.

Das komt doordat een aandraaimoment berekend wordt door twee grootheden met elkaar

te vermenigvuldigen: de kracht, die op het betreffende draaipunt inwerkt en de lengte van de hendel. Als een gloeibougie met een verkeerd aandraaimoment vastgedraaid wordt, kan compressieverlies ontstaan. Bij keramische gloeibougies is het bovendien ook mogelijk dat er

door trillingen een breuk in de keramiek ontstaat. Ook kan vooral het gebruik van een te groot aandraaimoment ertoe leiden dat de ringopening tussen de metalen behuizing en de gloebuis samentrekt. In dit geval raakt de gloeibougie oververhit en valt uit.

! Volg deze instructie indien een specifiek aandraaimoment of een specifieke hoek op de verpakking wordt vermeld !!!

Metalen bougie					Keramische bougie	
Schroefdraaddiameter					Schroefdraaddiameter	
M8	M9	M10	M12	M14	M8	M10
8,5 Nm	11 Nm	15 Nm	23 Nm	23 Nm	10 Nm	18 Nm
+/- 10	+/- 10	+/- 10	+/- 10	+/- 10	+/- 10	+/- 10

Aandraaimoment van de aansluitmoeren	
Schroefdraad-diameter	Aandraai-moment
4 mm (M4)	0,8-1,5 Nm
5 mm (M5)	3,0-4,0 Nm

Alleen als de gloeibougies met het juiste aandraaimoment ingeschroefd worden, functioneren ze optimaal.

Binários Velas de ignição

O torque de aperto correcto para velas de ignição

Para a montagem correcta de uma vela de ignição é necessário usar uma chave dinamométrica. Porque mesmo o mecânico mais experiente é incapaz de "estimar" o torque de aperto.

Isto se explica pelo facto de o binário ser calculado a partir de dois valores que são multiplicados: A força, que actua no respectivo ponto rotativo, e o comprimento da alavanca.

A maior parte das falhas das velas de ignição resultam de um torque de aperto errado. Se este for demasiado baixo, existe o risco de perdas de compressão e de sobreaquecimento. Também é possível que aconteça uma quebra do isolador ou do eléctrodo central por causa das vibrações.

Por outro lado, ao escolher um binário demasiado alto, isto pode levar à ruptura da vela de ignição. A carcaça além disso pode ficar dilatada ou distorcida. As zonas de dissipação de calor ficam danificadas, existe o risco de fundição dos eléctrodos e, inclusive, de gripar o motor.

Material da colaça	Vela de ignição com assento plano (com junta)				Vela de ignição com assento cónico	
	Diâmetro da rosca				Diâmetro da rosca	
	18 mm	14 mm	12 mm	10 mm	18 mm	14 mm
Cabeça de ferro fundido	35-45 Nm	25-35 Nm	15-25 Nm	10-15 Nm	20-30 Nm	15-25 Nm
Cabeça de alumínio	35-40 Nm	25-30 Nm	15-20 Nm	10-12 Nm	20-30 Nm	10-20 Nm

O torque de aperto depende do material da colaça e do diâmetro da rosca

Binários Velas de incandescência

O torque de aperto correcto para a montagem de velas incandescentes

Para a montagem correcta de uma vela incandescente é recomendável usar uma chave dinamométrica. Porque mesmo o mecânico mais experiente é incapaz de "estimar" o torque de aperto.

Isto se explica pelo facto de o binário ser calculado a partir de dois valores que são multiplicados: A força, que actua no respectivo ponto rotativo, e o comprimento da alavanca.

Se a vela de incandescência for apertada com um torque de aperto errado podem surgir perdas de compressão. Por causa

das vibrações ainda é possível que aconteça uma quebra da cerâmica.

Um torque de aperto excessivo ainda pode provocar a compressão da folga do anel entre a carcaça metálica e o tubo incandescente. Neste caso, a vela de incandescência sobreaquece e avaria.

! Siga as instruções caso o par de aperto ou ângulo especificados sejam mencionados na embalagem!!!

Vela de Incandescência Metálica					Vela de Incandescência em Cerâmica	
Diâmetro da rosca					Diâmetro da rosca	
M8	M9	M10	M12	M14	M8	M10
8,5 Nm	11 Nm	15 Nm	23 Nm	23 Nm	10 Nm	18 Nm
+/- 10	+/- 10	+/- 10	+/- 10	+/- 10	+/- 10	+/- 10

Torque de aperto das porcas	
Diâmetro da rosca	Torque de aperto
4 mm (M4)	0,8-1,5 Nm
5 mm (M5)	3,0-4,0 Nm

As velas de incandescência só funcionam impecavelmente se forem apertadas com o torque de aperto correcto.

Ροπές σύσφιξης μπουζί

Η σωστή ροπή σύσφιξης των μπουζί

Για την τοποθέτηση ενός μπουζί σύμφωνα με τους κανόνες, απαιτείται η χρήση ενός ροπόκλειδου. Ακόμη και για τους επαγγελματίες των συνεργείων η "εκτίμηση" της ορθής ροπής σύσφιξης είναι σχεδόν αδύνατη. Αυτό έγκειται στο ότι η ροπή σύσφιξης υπολογίζεται από δύο μεγέθη, τα οποία πολλαπλασιάζονται μεταξύ τους: από τη δύναμη, η οποία επενεργεί στο αντίστοιχο σημείο περιστροφής και το μήκος του μοχλού.

Οι περισσότερες δυσλειτουργίες των μπουζί οφείλονται στη λανθασμένη ροπή σύσφιξης. Εάν επιλεγεί πολύ μικρή, υπάρχει ο κίνδυνος απώλειας συμπίεσης και υπερθέρμανσης. Είναι πιθανή, ακόμη και η ρήξη του μονωτήρα ή του κεντρικού ηλεκτροδίου, λόγω των κραδασμών.

Εφόσον η ροπή σύσφιξης επιλεγεί πολύ ψηλή, μπορεί να προκληθεί αποκοπή του μπουζί. Ακόμη ενδέχεται να διασταλεί το περίβλημα ή να συστραφεί. Οι ζώνες απαγωγής θερμότητας διαταράσσονται, παρουσιάζεται η απειλή υπερθέρμανσης και τήξης των ηλεκτροδίων, μέχρι και η πρόκληση ζημιάς στον κινητήρα.

Υλικό κυλινδροκεφαλής	Μπουζί με επίπεδη εφαρμογή (με στεγανοποίηση)				Μπουζί με κωνική εφαρμογή	
	Διάμετρος σπειρώματος				Διάμετρος σπειρώματος	
Κεφαλή από χυτοσίδηρο	18 mm	14 mm	12 mm	10 mm	18 mm	14 mm
Κεφαλή από αλουμίνιο	35-45 Nm	25-35 Nm	15-25 Nm	10-15 Nm	20-30 Nm	15-25 Nm
	35-40 Nm	25-30 Nm	15-20 Nm	10-12 Nm	20-30 Nm	10-20 Nm

Οι τιμές της ροπής σύσφιξης, εξαρτώνται από το υλικό της κυλινδροκεφαλής και τη διάμετρο σπειρώματος.

Ροπές σύσφιξης προθερμαντήρες

Η σωστή ροπή σύσφιξης για την τοποθέτηση των προθερμαντήρων

Για τη σύμφωνη με τις προδιαγραφές τοποθέτηση ενός προθερμαντήρα απαιτείται η χρήση ενός ροπόκλειδου. Ακόμη και για τους επαγγελματίες των συνεργείων η εκτίμηση της ορθής ροπής σύσφιξης είναι σχεδόν αδύνατη. Αυτό έγκειται στο ότι η ροπή σύσφιξης υπολογίζεται από δύο μεγέθη, τα οποία

πολλαπλασιάζονται μεταξύ τους: από τη δύναμη, η οποία επενεργεί στο αντίστοιχο σημείο περιστροφής και το μήκος του μοχλού. Εφόσον εφαρμοστεί στον προθερμαντήρα μία λάθος ροπή σύσφιξης, μπορεί να προκληθούν απώλειες συμπίεσης. Είναι πιθανό επίσης λόγω των ταλαντώσεων να σπάσει το κεραμικό υλικό στην περίπτωση των κεραμικών προθερμαντήρων

Επίσης μπορεί ιδιαίτερα με τη χρήση μίας πολύ μεγάλης ροπής σύσφιξης να προκληθεί το κλείσιμο της σχισμής δακτυλίου μεταξύ του μεταλλικού περιβλήματος και του σωλήνα πυράκτωσης. Σε αυτήν την περίπτωση υπερθερμαίνεται ο προθερμαντήρας και παύει να λειτουργεί.

! Εάν στη συσκευασία αναφέρεται συγκεκριμένη ροπή ή γωνία σύσφιξης, ακολουθήστε τις οδηγίες!

Μεταλλικός προθερμαντήρας					Κεραμικός προθερμαντήρας	
Διάμετρος σπειρώματος					Διάμετρος σπειρώματος	
M8	M9	M10	M12	M14	M8	M10
8,5 Nm	11 Nm	15 Nm	23 Nm	23 Nm	10 Nm	18 Nm
+/- 10	+/- 10	+/- 10	+/- 10	+/- 10	+/- 10	+/- 10

Ροπές σύσφιξης των παξιμαδιών σύνδεσης	
Διάμετρος σπειρώματος	Ροπή σύσφιξης
4 mm (M4)	0,8-1,5 Nm
5 mm (M5)	3,0-4,0 Nm

Μόνο εφόσον βιδωθούν προθερμαντήρες με τη σωστή ροπή σύσφιξης, αυτοί λειτουργούν απρόσκοπτα

Buji torkları

Torklar

Bir bujinin usule uygun montajı için ayarlı tork anahtarı gereklidir. Çünkü usta oto servisçiler için bile sıkma torkunu tahmin etmek neredeyse imkansızdır. Bunun nedeni, sıkma torkunun birbirleriyle çarpılan iki parametreden hesaplanmasıdır: ilgili döndürme noktasına etki eden kuvvet ve manivela kolunun uzunluğu.

Buji arızalarının çoğu yanlış sıkma torkundan kaynaklanır. Sıkma torku fazla küçük seçilirse sıkışma kayıpları ve aşırı hararet tehlikesi vardır. Ayrıca titreşimler sonucunda izolatorün ya da orta elektrodun kırılması da akla gelebilecek ihtimallerdir.

Sıkma torku fazla büyük seçilirse, bu durum bujinin kopmasına yol açabilir. Ayrıca gövde genleşebilir ya da burulabilir. Isı iletim bölgeleri zedelenir, aşırı hararet ve elektrotların erimesi ve hatta motorun hasar görmesi tehlikesi vardır.

Silindir kapağı malzemesi	Basık tabanlı buji (sızdırmazlık elemanlı)				Konik tabanlı buji	
	Diş çapı					
Dökme demir kapak	18 mm	14 mm	12 mm	10 mm	18 mm	14 mm
Alüminyum kapak	35-45 Nm	25-35 Nm	15-25 Nm	10-15 Nm	20-30 Nm	15-25 Nm
	35-40 Nm	25-30 Nm	15-20 Nm	10-12 Nm	20-30 Nm	10-20 Nm

Sıkma torkları silindir kapağının yapıldığı malzemeye ve vida diş çapına bağlıdır

Akkor buji torkları

Doğru sıkma torku

Bir kızdırma bujisinin usule uygun montajı için ayarlı tork anahtarı kullanılması tavsiye edilir. Çünkü usta oto servisçiler için bile sıkma torkunu tahmin etmek neredeyse imkansızdır.

Bunun nedeni, sıkma torkunun birbirleriyle çarpılan iki parametreden hesaplanmasıdır:

ilgili döndürme noktasına etki eden kuvvet ve manivela kolunun uzunluğu.

Bir kızdırma bujisinde yanlış sıkma torku uygulanırsa, sıkıştırma kayıpları meydana gelebilir. Titreşimler nedeniyle ayrıca seramik kızdırma bujilerinde seramiğin kırılması mümkündür.

Fazla büyük bir sıkma torkunun kullanılması ayrıca metal muhafaza ile kızdırma borusu arasındaki halka aralığın büzülmesine yol açabilir. Bu durumda kızdırma bujisi aşırı ısınır ve devre dışı kalır.

! Belirtilen sıkma torku veya açılı ambalajın üzerinde gösterilmişse lütfen talimatları izleyin !!!

Metal Tip Kızdırma Bujisi					Seramik Tip Kızdırma Bujisi	
Vida diş çapı					Vida diş çapı	
M8	M9	M10	M12	M14	M8	M10
8,5 Nm	11 Nm	15 Nm	23 Nm	23 Nm	10 Nm	18 Nm
+/- 10	+/- 10	+/- 10	+/- 10	+/- 10	+/- 10	+/- 10

Bağlantı somunlarının sıkma torkları	
Vida diş çapı	Sıkma torku
4 mm (M4)	0,8-1,5 Nm
5 mm (M5)	3,0-4,0 Nm

Kızdırma bujileri yalnızca doğru sıkma torklarıyla vidalanırsa, sorunsuz çalışırlar

Momenty dokręcenia świec zapłonowych

Momenty dokręcenia

Do fachowego montażu świecy zapłonowej konieczny jest klucz dynamometryczny. Ponieważ sami fachowcy warsztatowi nie są w stanie dokładnie ocenić momentu dokręcenia.

Wynika to z tego, że moment dokręcenia oblicza się na podstawie dwóch wielkości, które wzajemnie mnoży się: siły, która działa w danym punkcie obrotu oraz długości dźwigni.

Większość awarii świec zapłonowych spowodowanych jest błędnym momentem dokręcenia. Jeśli moment dokręcenia wybierze się za mały, może nastąpić utrata sprężenia i przegrzanie. Możliwe jest również pęknięcie izolatora lub elektrody środkowej na skutek drgań.

Jeśli moment dokręcenia wybierze się za duży, może dojść do zerwania świecy zapłonowej. Także korpus nie będzie mógł się rozciągnąć ani przekręcić. Strefy odpływu ciepła będą zakłócone, istnieje niebezpieczeństwo przegrzania i stopienia elektrod aż do uszkodzenia silnika.

Material głowicy silnika	Świeca zapłonowa z płaskim gniazdem (z uszczelką)				Świeca zapłonowa ze stożkowym gniazdem	
	Średnica gwintu				Średnica gwintu	
	18 mm	14 mm	12 mm	10 mm	18 mm	14 mm
Głowica żeliwna	35-45 Nm	25-35 Nm	15-25 Nm	10-15 Nm	20-30 Nm	15-25 Nm
Głowica aluminiowa	35-40 Nm	25-30 Nm	15-20 Nm	10-12 Nm	20-30 Nm	10-20 Nm

Momenty dokręcenia zależą od materiału głowicy silnika i średnicy gwintu

Momenty dokręcenia świec żarowych

Właściwy moment obrotowy

Do fachowego montażu świecy żarowej zaleca się stosowanie klucza dynamometrycznego.

Ponieważ sami fachowcy warsztatowi nie są w stanie dokładnie ocenić momentu dokręcenia.

Wynika to z tego, że moment dokręcenia oblicza się na podstawie dwóch wielkości, które

wzajemnie mnoży się: siły, która działa w danym punkcie obrotu oraz długości dźwigni.

Jeśli świecę żarową dokręci się niewłaściwym momentem obrotowym, może nastąpić utrata kompresji. Ze względu na drgania w przypadku ceramicznych świec żarowych możliwe jest również pęknięcie ceramiki.

Także szczególnie użycie zbyt dużego momentu dokręcenia może spowodować zmniejszenie się szczeliny pierścieniowej pomiędzy metalową obudową i rurką żarzenia. W takim przypadku nastąpi przegrzanie świecy żarowej i jej uszkodzenie.

! Stosować się do instrukcji, jeśli na opakowaniu podano moment dokręcania lub kąt!!!

Metalowa świeca żarowa					Ceramiczna świeca żarowa	
Średnica gwintu					Średnica gwintu	
M8	M9	M10	M12	M14	M8	M10
8,5 Nm	11 Nm	15 Nm	23 Nm	23 Nm	10 Nm	18 Nm
+/- 10	+/- 10	+/- 10	+/- 10	+/- 10	+/- 10	+/- 10

Moment dokręcenia nakrętek	
Średnica gwintu	Moment dokręcenia
4 mm (M4)	0,8–1,5 Nm
5 mm (M5)	3,0–4,0 Nm

Tylko wtedy, gdy świece żarowe dokręcone są właściwym momentem obrotowym, działają bez zarzutu.

Utahovací momenty zapalovacích svíček

Správný utahovací moment pro zapalovací svíčky

Pro správnou montáž zapalovací svíčky je potřebný momentový klíč. Dokonce i pro profesionála ze servisu je totiž téměř nemožný "odhad" utahovacího momentu.

Většina výpadků zapalovacích svíček má příčinu ve špatném utahovacím momentu. Pokud je příliš malý, hrozí ztráty komprese a přehřátí. V důsledku vibrací může dojít i k prasknutí izolátoru nebo střední elektrody.

Pokud je utahovací moment příliš velký, může dojít k vytržení zapalovací svíčky. Také může dojít k protažení nebo deformaci těla. Negativně jsou ovlivněny zóny odvodu tepla, hrozí přehřátí a roztavení elektrod až poškození motoru.

To je dáno tím, že utahovací moment se vypočítá ze dvou veličin, které se vzájemně násobí: síly, která v daném bodu otáčení působí, a délky páky.

Materiál hlavy válce	Zapalovací svíčka s plochým sedlem (s těsněním)				Zapalovací svíčka s kónickým sedlem	
	Průměr závitu					
	18 mm	14 mm	12 mm	10 mm	18 mm	14 mm
Litinová hlava	35-45 Nm	25-35 Nm	15-25 Nm	10-15 Nm	20-30 Nm	15-25 Nm
Hliníková hlava	35-40 Nm	25-30 Nm	15-20 Nm	10-12 Nm	20-30 Nm	10-20 Nm

Utahovací momenty jsou závislé na materiálu hlavy válce a průměru závitu

Utahovací momenty žhavicích svíček

Správný utahovací moment pro montáž žhavicích svíček

Pro správnou montáž žhavicí svíčky se doporučuje použití momentového klíče. Dokonce i pro profesionála ze servisu je totiž téměř nemožný odhad utahovacího momentu.

síly, která v daném bodu otáčení působí, a délky páky. Pokud se u žhavicí svíčky použije špatný utahovací moment, může to vést ke ztrátě komprese. Kvůli vibracím je u keramických žhavicích svíček navíc riziko prasknutí keramiky.

Zvláště také vynaložení příliš velkého utahovacího momentu vede ke stažení kruhové mezery mezi kovovým tělesem a žhavicí trubicí. V takovém případě se žhavicí svíčka přehřívá a dojde k jejímu výpadku.

To je dáno tím, že utahovací moment se vypočítá ze dvou veličin, které se vzájemně násobí:

! Prosím, následujte instrukce pokud je specifikována utahovací moment nebo úhel je uvedeno na obalu !!!

Kovových žhavicích svíček					Keramických žhavicích svíček	
Průměr závitu					Průměr závitu	
M8	M9	M10	M12	M14	M8	M10
8,5 Nm	11 Nm	15 Nm	23 Nm	23 Nm	10 Nm	18 Nm
+/- 10	+/- 10	+/- 10	+/- 10	+/- 10	+/- 10	+/- 10

Utahovací momenty přípojních matic	
Průměr závitu	Utahovací moment
4 mm (M4)	0,8-1,5 Nm
5 mm (M5)	3,0-4,0 Nm

Pouze žhavicí svíčky zašroubované se správným utahovacím momentem fungují bezchybně

Gyújtógyertyák nyomatékai

A gyújtógyertya szakszerű beszereléséhez ajánlott a nyomatékkulcs használata. A meghúzási nyomaték megbecsülése még a profi szerelők számára is közel lehetetlen.

Ez abból adódik, hogy a nyomaték két mennyiség szorzataként adódik: a mindenkori forgásponton ható erő és az erőkar hossza.

A legtöbb gyújtógyertya meghibásodást a hibás meghúzási nyomaték okozza. Ha túl alacsony, kompresszió veszteség és túlhevülés léphet fel. Előfordulhat a szigetelő vagy a középelektroda rezgés okozta törése is.

Ha túl magas, a gyertya elszakadhat. A ház is megnyúlhat ill. elcsavarodhat. Zavar keletkezik a hőelvezetés útjaiban, túlmelegedés és az elektródák leolvadása fenyeget, ami motorhibát okozhat.

Hengerfej anyaga	Gyújtógyertya sík ülékkel (tömítéssel)				Gyújtógyertya kúpos ülékkel	
	Menet átmérő					
	18 mm	14 mm	12 mm	10 mm	18 mm	14 mm
Öntöttvas fej	35-45 Nm	25-35 Nm	15-25 Nm	10-15 Nm	20-30 Nm	15-25 Nm
Alumínium fej	35-40 Nm	25-30 Nm	15-20 Nm	10-12 Nm	20-30 Nm	10-20 Nm

A meghúzási nyomaték függ a hengerfej anyagától és a menet átmérőjétől

Izzítógyertyák nyomatékai

Az izzítógyertya szakszerű beszereléséhez ajánlott a nyomatékkulcs használata. A meghúzási nyomaték megbecsülése még a profi szerelők számára is közel lehetetlen.

Ez abból adódik, hogy a nyomaték két mennyiség szorzataként adódik: a mindenkori forgásponton ható erő és az erőkar hossza.

A nem megfelelő nyomatékkal meghúzott izzítógyertyánál kompresszióvesztés léphet fel. A fellépő rezgések miatt, a kerámia gyertyáknál a törés veszélye is fennáll.

A túl nagy nyomatékkal történt meghúzás esetén a fém ház és az izzítócső közötti, kör alakú rész is összehúzódhat. Ez esetben a gyertya túlmelegszik és tönkremegy.

! Kérjük, kövesse az utasításokat, ha megadott nyomaték, vagy szög szerepel a csomagoláson!!!

Fém izzítógyertya					Kerámia izzítógyertya	
Menet átmérő					Menet átmérő	
M8	M9	M10	M12	M14	M8	M10
8,5 Nm	11 Nm	15 Nm	23 Nm	23 Nm	10 Nm	18 Nm
+/- 10	+/- 10	+/- 10	+/- 10	+/- 10	+/- 10	+/- 10

A csatlakozó anyák meghúzási nyomatéka	
Menet átmérő	Meghúzási nyomaték
4 mm (M4)	0,8–1,5 Nm
5 mm (M5)	3,0–4,0 Nm

Csak a megfelelő meghúzási nyomatékkal szerelt izzítógyertya működik kifogástalanul.

Моменты затяжки свечей зажигания

Крутящие моменты

Для компетентного монтажа свечи зажигания требуется динамометрический ключ. Поскольку даже для специалистов почти невозможно оценить момент затяжки.

Это связано с тем, что крутящий момент состоит из двух величин, умножаемых друг на друга: силы, воздействующей на соответствующий центр вращения и длины рукоятки.

Большинство поломок свечей зажигания происходит из-за неправильного момента затяжки. Если он будет слишком низким, возникнут потери компрессии и перегрев. Из-за вибрации может также сломаться изолятор или средний электрод.

Если крутящий момент будет слишком высоким, свеча зажигания может оторваться. Также может расширяться или деформироваться корпус. Нарушаются зоны теплоотведения, что чревато перегревом и оплавлением электродов, вплоть до поломки двигателя.

Материал головки цилиндра	Свеча зажигания с плоской посадкой (с уплотнением)				Свеча зажигания с конической посадкой	
	Диаметр резьбы				Диаметр резьбы	
	18 мм	14 мм	12 мм	10 мм	18 мм	14 мм
Чугунная головка	35-45 Нм	25-35 Нм	15-25 Нм	10-15 Нм	20-30 Нм	15-25 Нм
Алюминиевая головка	35-40 Нм	25-30 Нм	15-20 Нм	10-12 Нм	20-30 Нм	10-20 Нм

Крутящие моменты зависят от материала головки цилиндра и диаметра резьбы

Моменты затяжки свечей накаливания

Правильный крутящий момент

Для надлежащего монтажа свечи накаливания рекомендуется использовать динамометрический ключ. Поскольку даже для специалистов почти невозможно оценить момент затяжки.

Это связано с тем, что крутящий момент состоит из двух величин, умножаемых друг на друга: силы, воздействующей на соответствующий центр вращения и длины рукоятки.

Если свеча накаливания уста навливается посредством неправильного крутящего момента, это может привести к потере компрессии. Из-за

вибрации в керамических свечах накаливания может лопнуть керамика.

Применение слишком высокого момента затяжки может повлечь за собой сужение кольцевого зазора между металлическим корпусом и калильной трубкой. В этом случае свеча накаливания перегревается и выходит из строя.

⚠ Пожалуйста, следуйте инструкциям, если момент затяжки или угол поворота указаны на упаковке!!!

Металлическая свеча накаливания					Керамическая свеча накаливания	
Диаметр резьбы					Диаметр резьбы	
M8	M9	M10	M12	M14	M8	M10
8,5 Нм	11 Нм	15 Нм	23 Нм	23 Нм	10 Нм	18 Нм
+/- 10	+/- 10	+/- 10	+/- 10	+/- 10	+/- 10	+/- 10

Моменты затяжки контактных гаек	
Диаметр резьбы	Момент затяжки
4 мм (M4)	0,8–1,5 Нм
5 мм (M5)	3,0–4,0 Нм

Только при правильном крутящем моменте свечи накаливания действуют исправно



2015-2016
NGK
RACING SPARK PLUGS



Choosing a racing plug

1 Choose the right spark plug for your engine based on heat range and electrode design, engine tuning, and racing conditions.

▶ Heat range

Normal Spark plugs with a higher heat-range number have superior cooling characteristics. **High performance**

▶ Electrode design

- Engine tuning
- Torturous racing conditions
- Avoid problems due to extremes of temperature

High response **High performance**

•Low-speed performance

Racing plugs for both two- and four-wheel vehicles have been developed and designed for use in engines that have been fine-tuned to achieve maximum power under specific racing conditions. Racing plugs differ from standard plugs, both in appearance and performance, and often sacrifice plug life, and efficiency at low-speeds for optimum performance and durability under torturous racing conditions. Racing plugs do not improve output.

2 What to look for when choosing a racing plug

<p>CAUTION 1 Shell design – To determine what kind of shell design fits in your engine, check the serial number of regulation plugs or the plugs you are currently using to verify the thread diameter, pitch, thread length and shell seat.</p>	<p>CAUTION 2 Firing End design – Refer to the section below on electrode design to determine which type is best for your needs.</p>
<p>CAUTION 3 Heat range – It's important to choose a racing plug with a heat range that keeps the electrode at an optimum temperature under even the most torturous racing conditions. And remember: A higher heat-range number does not improve engine performance, it increases the plug's ability to dissipate heat.</p>	<p>CAUTION 4 Resistors – Due to advances in ignition-system technology, there is little if any difference in performance between plugs with resistors and those without. However there are still some variations of some models that require plugs with resistors to avoid engine trouble.</p>

3 Choosing a firing end design

Although a good rule of thumb is that the more an electrode projects into the cylinder, the better ignition it provides, it's also true that longer projections are more susceptible to the wear and tear of extreme temperatures. High-power, high-performance engines, of course, not only run hotter, they also vibrate more, which is why we recommend choosing a firing end design that reduces exposure of the electrode and insulator as much as possible.

<p>Projected type</p> <p>Quite similar to a standard spark plug electrode, these plugs give good overall performance in lightly tuned and naturally aspirated engines, as well as good performance in the low to medium torque range in turbo engines.</p>	<p>Angled ground strap type</p> <p>These provide superior performance in turbocharged engines with power boosts of 50% or more. The short ground electrode is also highly durable against mechanical shock.</p>	<p>Semi-surface discharge</p> <p>In a sense, this is the ultimate plug configuration. Nearly all insulator cracking and electrode melting can be prevented with this type. Nevertheless, service life and low-speed performance may suffer slightly.</p>
---	--	---

NOTICE

Please choose racing plugs with the appropriate heat range and electrode design according to the tune-up level of the engine and the running conditions of the vehicle. NGK is not responsible for an engine or spark plugs troubles caused by a failure to choose the appropriate spark plug for your engine.

Spark Plug Maintenance

▶ How to correctly install spark plugs

You must take great care when installing spark plugs. In particular, you have to watch the torque. If you use too much or too little torque when installing spark plugs you can cause damage to the spark plugs and the engine, so be sure you abide by the following.

▶ Be sure to use the correct spark plug wrench.

Some engines have narrow spark plug holes thereby preventing the spark plugs from being tightened correctly with a plug wrench that does not perfectly fit the hexagonal portion of the plug. So, please use the appropriate spark plug wrench for your engine.

▶ Be sure to tighten the spark plug to the correct torque.

Screw in the spark plug and then use a torque wrench to tighten the spark plug to the standard torque noted in the chart on the right. If you do not have access to a torque wrench screw in the plug with your fingertips and then tighten to the rotation angle noted below (corresponds to the tightening torque in the chart on the right) using a spark plug wrench once the spark plug comes in contact with the spark plug tube gasket mount.

⚠ CAUTION

If any lubricants, such as grease, or seizure prevention agents are used on the threads there is a danger of over tightening the spark plug past the standard torque. Therefore, do not use lubricants or seizure prevention agents on these parts.



Standard Torque



Plug thread size	Tightening torque
φ18mm	35~40N·m (3.5~4.0kgm)
φ14mm	25~30N·m (2.5~3.0kgm)
φ12mm	15~20N·m (1.5~2.0kgm)
φ10mm	10~12N·m (1.0~1.2kgm)
φ8mm	8~10N·m (0.8~1.0kgm)

Conical seat type (without gasket)

Tightening torque	10~20N·m (1.0~2.0kgm)
-------------------	-----------------------

▶ Tightening angles

Thread size	New gasket	Used gasket
φ14mm	$\frac{1}{2} \sim \frac{2}{3}$ of a turn (180°~240°)	$\frac{1}{12}$ of a turn (30°)
φ12mm (except ▼)	$\frac{1}{2}$ of a turn (180°)	$\frac{1}{12}$ of a turn (30°)
▼ R2556B-  R2558A- 	$\frac{1}{4}$ of a turn (90°)	$\frac{1}{8}$ of a turn (45°)

Thread size	New gasket	Used gasket
φ10mm (except ▼)	$\frac{1}{2}$ of a turn (180°)	$\frac{1}{12}$ of a turn (30°)
R0409B-  ▼ R0451B-  R0465B- 	$\frac{1}{6}$ of a turn (60°)	$\frac{1}{12}$ of a turn (30°)
φ8mm	$\frac{1}{3}$ of a turn (120°)	$\frac{1}{12}$ of a turn (30°)
Copper gasket type	$\frac{1}{12}$ of a turn (30°)	$\frac{1}{24}$ of a turn (15°)

▶ Plugs with gaskets that had a thread diameter of φ18mm or φ14mm

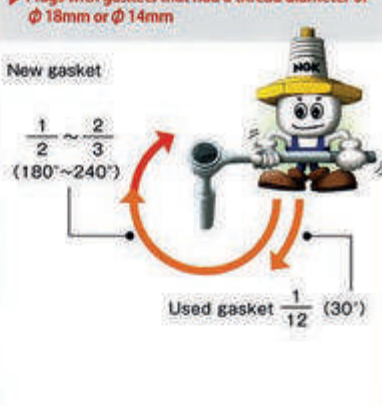

New gasket: $\frac{1}{2} \sim \frac{2}{3}$ (180°~240°)

Used gasket: $\frac{1}{12}$ (30°)

▶ Plugs with gaskets that had a thread diameter of φ12mm

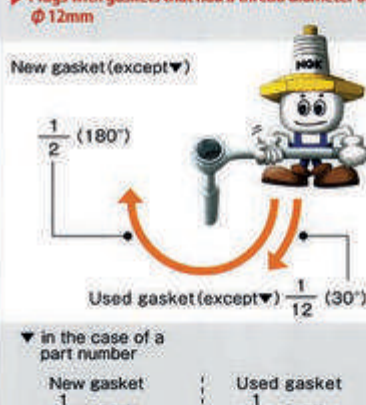

New gasket (except ▼): $\frac{1}{2}$ (180°)

Used gasket (except ▼): $\frac{1}{12}$ (30°)

▼ in the case of a part number

New gasket	Used gasket
$\frac{1}{4}$ (90°)	$\frac{1}{8}$ (45°)

▶ Plugs with gaskets that had a thread diameter of φ10mm

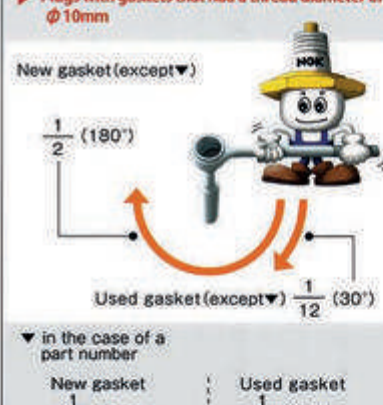

New gasket (except ▼): $\frac{1}{2}$ (180°)

Used gasket (except ▼): $\frac{1}{12}$ (30°)

▼ in the case of a part number

New gasket	Used gasket
$\frac{1}{6}$ (60°)	$\frac{1}{12}$ (30°)

▶ Plugs with gaskets that had a thread diameter of φ8mm

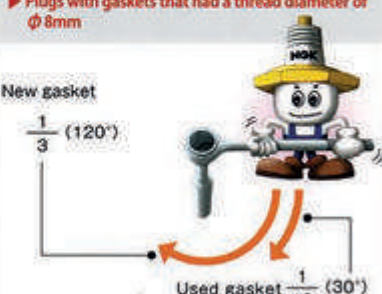

New gasket: $\frac{1}{3}$ (120°)

Used gasket: $\frac{1}{12}$ (30°)

▶ Conical seat type without gaskets



New and Used gasket: $\frac{1}{16}$ (22.5°)

▶ Plugs with copper gaskets

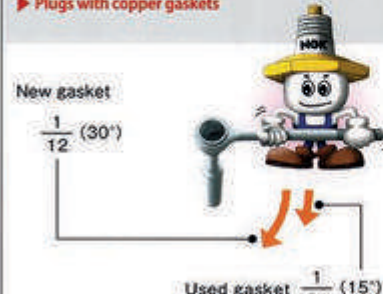

New gasket: $\frac{1}{12}$ (30°)

Used gasket: $\frac{1}{24}$ (15°)

Red color indicates non resistor plugs.

▶ $\phi 14 \times 19\text{mm}(20.8\text{Hex})$



R4304A-

Heat range	8	9	10
Spark plug type	BP-E		
Terminal type	⌚		
Electrode material	Center	Gold Palladium	
	Ground	Nickel	



R6918B-

Heat range	7	8	9
Spark plug type	B-E		
Terminal type	⌚		
Electrode material	Center	Platinum	
	Ground	Nickel	



R7376-

Heat range	7	8	9	10
Spark plug type	B-E			
Terminal type	⌚			
Electrode material	Center	Iridium		
	Ground	Platinum		



R6712-

Heat range	8	10
Spark plug type	B-E	
Terminal type	⌚	
Electrode material	Center	Nickel
	Ground	-



▶ $\phi 14 \times 22\text{mm}(20.8\text{Hex})$



Short
R6179C-PA

Heat range	105
Spark plug type	-
Terminal type	⌚
Electrode material	Center: Platinum
	Ground: Platinum



R7376B-

Heat range	9	10
Spark plug type	-	
Terminal type	⌚	
Electrode material	Center	Iridium
	Ground	Platinum



▶ $\phi 14 \times 22\text{mm}(16.0\text{Hex})$



Short
R7282A-

Heat range	10	105	11
Spark plug type	-		
Terminal type	⌚		
Electrode material	Center	Iridium	
	Ground	Platinum	





- ① 1) It's necessary to use special plug caps(Please refer to page 8)
- ② 2) The length from gasket to terminal of ISO/JIS type spark plugs is 50.5mm which is 2.5mm shorter than old JIS type spark plugs
- ③ 3) Resistor spark plugs are recommended for cars originally equipped with resistor spark plugs. When non resistor spark plugs are installed in such cars, there is some possibility that the electric devices in the car, such as the audio system or the engine management system, would be affected by noise
- ④ 4) Heat range number enters

NOTICE) ⌚ = Solid post terminal ⌚ = Thread terminal with nut ⌚ = Thread terminal

φ14×19mm(16.0Hex)

Please be aware that some plugs cannot be replaced despite having the same thread size and length

Short
R7282- 





Heat range	9	10	105	11
Spark plug type	—			
Terminal type				
Electrode material	Center	Iridium		
	Ground	Platinum		

Short
R7282M- 





Heat range	11	115	—	
Spark plug type	—			
Terminal type				
Electrode material	Center	Iridium		
	Ground	Platinum		

R7433- 



50.5mm

Heat range	8	9	10	—	
Spark plug type	BK-E (ISO/JIS) ^{※2}				
Terminal type					
Electrode material	Center	Iridium			
	Ground	Nickel			

R7434- 



50.5mm

Heat range	8	9	10	—	
Spark plug type	BK-E (ISO/JIS) ^{※2}				
Terminal type					
Electrode material	Center	Iridium			
	Ground	Platinum			

R6601- 



50.5mm

Heat range	8	9	10	11	—	
Spark plug type	BK-E (ISO/JIS) ^{※2}					
Terminal type						
Electrode material	Center	Nickel				
	Ground	—				

R7435- 



53.0mm

Heat range	8	9	10	—		
Spark plug type	BCP-E (old JIS)					
Terminal type						
Electrode material	Center	Iridium				
	Ground	Nickel				

R7436- 



53.0mm

Heat range	8	9	10	—		
Spark plug type	BC-E (old JIS)					
Terminal type						
Electrode material	Center	Iridium				
	Ground	Platinum				

R6690- 



53.0mm

Heat range	9	10	11	—		
Spark plug type	BC-E (old JIS)					
Terminal type						
Electrode material	Center	Nickel				
	Ground	—				

Red color indicates non resistor plugs.

▶ $\phi 14 \times 26.5\text{mm}$ (16.0Hex)

long reach
R7437-

Heat range	8	9	10
Spark plug type	LFR		
Terminal type			
Electrode material	Center	Iridium	
	Ground	Nickel	

long reach
R7438-

Heat range	8	9	10
Spark plug type	LFR		
Terminal type			
Electrode material	Center	Iridium	
	Ground	Platinum	

▶ $\phi 14 \times 12.7\text{mm}$ (20.8Hex)

R5525-

Heat range	8	9	10	11
Spark plug type	B-H			
Terminal type				
Electrode material	Center	Gold Palladium		
	Ground	Nickel		

▶ $\phi 14 \times 21.5\text{mm}$ (20.8Hex)

R6725-

Heat range	9	10	105	11	115
Spark plug type	Rotary Engine RX-7				
Terminal type					
Electrode material	Center	Platinum			
	Ground	Platinum			

R7420-

Heat range	9	10	105	11
Spark plug type	Rotary Engine RX-7			
Terminal type				
Electrode material	Center	Iridium		
	Ground	Platinum		

▶ $\phi 14 \times 21\text{mm}$ (20.8Hex)

R7440A-L

Heat range	9	10
Spark plug type	Rotary Engine RX-8 Lside	
Terminal type		
Electrode material	Center	Iridium
	Ground	Platinum

▶ $\phi 14 \times 19\text{mm}$ (20.8Hex)

R7440B-T

Heat range	10	11
Spark plug type	Rotary Engine RX-8 Tside	
Terminal type		
Electrode material	Center	Iridium
	Ground	Platinum

▶ $\phi 12 \times 26.5\text{mm}$ (16.0Hex)

long reach
R2556B-

Heat range	8	9	10
Spark plug type	LKR		
Terminal type			
Electrode material	Center	Iridium	
	Ground	Platinum	

▶ $\phi 12 \times 26.5\text{mm}$ (14.0Hex)

long reach
R2558A-

Heat range	8	9	10
Spark plug type	LKAR		
Terminal type			
Electrode material	Center	Iridium	
	Ground	Platinum	

φ12×19mm(16.0Hex)



R2349-

Heat range	9	10	11
Spark plug type	DC-E		
Terminal type			
Electrode material	Center	Nickel	
	Ground	-	



R2525-

Heat range	9	10
Spark plug type	DC-E	
Terminal type		
Electrode material	Center	Platinum
	Ground	Nickel



φ10×26.5mm(16.0Hex)



long reach
R0452A-

Heat range	10
Spark plug type	LMR
Terminal type	
Electrode material	Center Nickel
	Ground -



φ10×26.5mm(14.0Hex)



long reach
R0465B-

Heat range	10
Spark plug type	LMAR
Terminal type	
Electrode material	Center Nickel
	Ground -



long reach
R0451B-

Heat range	8
Spark plug type	LMAR
Terminal type	
Electrode material	Center Iridium
	Ground Nickel



long reach
R0451C-

Heat range	10
Spark plug type	LMAR
Terminal type	
Electrode material	Center Iridium
	Ground Nickel



③) Resistor spark plugs are recommended for cars originally equipped with resistor spark plugs. When non resistor spark plugs are installed in such cars, there is some possibility that the electric devices in the car, such as the audio system or the engine management system, would be affected by noise.
④) Heat range number enters

NOTICE) = Solid post terminal = Thread terminal with nut = Thread terminal

Red color indicates non resistor plugs.

▶ $\phi 10 \times 19 \text{mm} (16.0 \text{Hex})$

R0373A-

Heat range	8	9	10	11
Spark plug type	C-E			
Terminal type				
Electrode material	Center	Iridium		
	Ground	Platinum		

GAP1 4
R0045G-

Heat range	10	11
Spark plug type	C-E	
Terminal type		
Electrode material	Center	Nickel
	Ground	-

GAP1 1
R0045J-

Heat range	9	10	11
Spark plug type	C-E		
Terminal type			
Electrode material	Center	Nickel	
	Ground	-	

GAP1 1
R0045Q-

Heat range	10	11
Spark plug type	C-E	
Terminal type		
Electrode material	Center	Nickel
	Ground	-

▶ $\phi 10 \times 19 \text{mm} (16.0 \text{Hex})$ Half thread

R0409B-

Heat range	8	9	10
Spark plug type	C-EH		
Terminal type			
Electrode material	Center	Iridium	
	Ground	Nickel	

R0459A-

Heat range	10
Spark plug type	C-EH
Terminal type	
Electrode material	Center Nickel
	Ground -

▶ $\phi 10 \times 12.7 \text{mm} (16.0 \text{Hex})$

R0161-

Heat range	9	10	11
Spark plug type	C-H		
Terminal type			
Electrode material	Center	Nickel	
	Ground	Nickel	

▶ $\phi 8 \times 19 \text{mm} (13.0 \text{Hex})$ Half thread

R847-

Heat range	10	11
Spark plug type	E-EH	
Terminal type		
Electrode material	Center	Nickel
	Ground	-











































































※ 3) Resistor spark plugs are recommended for cars originally equipped with resistor spark plugs. When non resistor spark plugs are installed in such cars, there is some possibility that the electric devices in the car, such as the audio system or the engine management system, would be affected by noise

※ 4) Heat range number enters

NOTICE) = Solid post terminal = Thread terminal with nut = Thread terminal





▶ Discontinued plug types

Red color indicates non resistor plugs. Heat range number enters.

Old part number	New part number	Old part number	New part number
R016-  , R017- 	→ R0373A- 	R6205-  , R6241- 	→ R7433-  or R7434- 
R216-  , R217- 	→ R2525- 	R6206-  , R6242- 	→ R7434- 
R2270-  , R2430- 	→ R2349- 	R5400-  , R5400F-  , R6337- 	→ R7435- 
R5530- 	→ R5525- 	R5686- 	→ R7435-  or R7436- 
R5649- 	→ R6712- 	R5830-  , R5687- 	→ R7436- 
R6711- 	→ R6601- 	R7112-  , R7113- 	→ R7433- 
R5883- 	→ R6690- 	R7114-  , R7115- 	→ R7433-  or R7434- 
R4630A-  , R6385-  P	→ R7376- 	R7116-  , R7117- 	→ R7434- 
R6120- 	→ R7282- 	R7118-  , R7119- 	→ R7434- 
R6120A- 	→ R7282A- 	R7232-  , R7233- 	→ R7435- 
R6120M- 	→ R7282M- 	R7234-  , R7235- 	→ R7435-  or R7436- 
R6179A- 	→ R7282- 	R7236-  , R7237- 	→ R7436- 
R6255-  , R6255F-  , R6326- 	→ R7433- 	R7238-  , R7239- 	→ R7436- 

▶ Racing plug caps

Heat range number enters.

Plug cap number(color)	Plugs and cables
 TRS1225-B (Blue) @ for HONDA RACE	R7282-  , R7282A-  , R7282M-  φ8mm Cable
 TRS1233A-R (Red) TRS1233B-Y (Yellow) TRS1233C-G (Green)	R7282-  , R7282A-  , R7282M-  φ7mm Cable

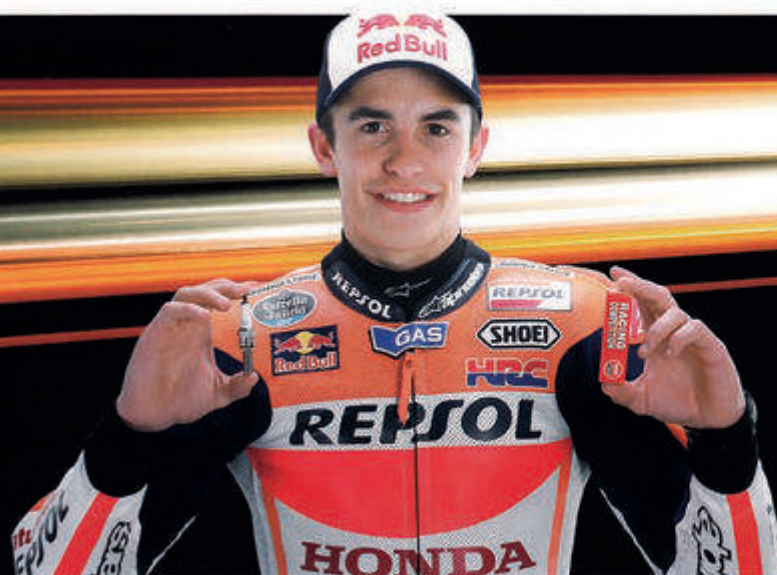







































NOTICE

Choose appropriate heat range and firing end of racing spark plugs according to engine modification or driving condition.
(Please refer to the first page.)

Motorcycles

Heat range number enters

Manufacturer	Model	Spark plug Number	Racing spark plug IX spark plug	other applicable plug number
▶ HONDA				
Road	CBR1000RR	IMR9E-9HES	R0409B-  ,R0459A- 	
	CBR600RR	IMR9E-9HES	R0409B-	p7
	CBR400RR	CR8EH-9	CR-  EHIX-9,R0409B- 	
	CBR250R	SIMR8A9	CR-  EIX,R0373A-	p7
	NSR250R-SP/SE	BR9ECM	BR-  ECMIX	
Race	NSR50	BR8ES	BR-  EIX,R7376-	p3
Motocross	NSF250R	R0452A-10	R0452A-  ,R0451C- 	p6
	CRF450R('09~)	SILMAR9A9S	-	
	CRF250R('10~)	R0451B-8	R0451B- 	p6
	CRF250R('04~'09)	R0409B-8	R0409B-	
	CRF150R/R II	CR8EH-9	CR-  EHIX-9,R0409B- 	p7
	CRF125F	CPR6EA-9	CPR6EAIX-9S	p7
	CRF50F	CR6HSA	CR-  HIX	p7
	CR125R	BR9EG	BR-  EIX,R7376-	
	CR85R/R II	BR10EG	BR-  EIX,R7376- 	p3
	CR80R/R II	BR10EG	BR-  EIX,R7376-	
▶ KAWASAKI				
Road	Ninja ZX-10R	CR9EIA-9	R0373A-  ,R0045Q- 	
	Ninja ZX-6R/RR	CR9E	R0373A-  ,R0045Q-	p7
	Ninja 400	CR9EIA-9	R0373A-  ,R0045Q- 	
	Ninja 250	CR8E	CR-  EIX,R0373A-	
	Ninja 250SL	MR8CI-8	CR-  EIX,R0373A- 	
Motocross	KX450F	CPR8EB-9	-	
	KX250F('11~)	CPR8EB-9	-	
	KX250F('06~'11)	CR8E	CR-  EIX,R0373A-	p7
	KX250('05~)	BR8ECMVX	BR-  ECMIX	
	KX125('06~)	BR9ECMVX	BR-  ECMIX	
	KX85/II	R6252K-10S	R7376- 	
	KX65	BR10EG	BR-  EIX,R7376-	p3
	KLX450R	CPR8EB-9	-	
	KLX250	CR8E	CR-  EIX,R0373A-	p7
	KLX125	CR7HSA	CR-  HIX	p7
KLX110L	CR6HSA	CR-  HIX		
▶ SUZUKI				
Road	GSX-R1000('07~)	CR9EIA-9	R0373A-  ,R0045Q- 	p7
	GSX-R600('08~)	CR9EIA-9	R0373A-  ,R0045Q-	
Motocross	RM-Z450('07~)	DIMR8A10	-	
	RM-Z250('13~)	CR8EIB-10	-	
	RM-Z250('07~'13)	CR8EIA-10	-	
	RM250('02~)	BR8EG	BR-  EIX,R7376-	
	RM125('97~)	R6918B-8	R6918B- 	p3
	RM85/85L	BR10ES	BR-  EIX,R7376-	



Heat range number enters

Manufacturer	Model	Spark plug Number	Racing spark plug IX spark plug	other applicable plug number
▶ YAMAHA				
Road	YZF-R1/R1M('09~)	LMAR9E-J	R0465B-	p6
	YZF-R1('04~'08)	CR9EK	R0373A-, R0045Q-	p7
	YZF-R6('98~)	CR10EK	R0373A-, R0045Q-	
	YZF-R3/R25	CR9E	CR-EIX, R0373A-	
Motocross	YZ450F	CR8E	CR-EIX, R0373A-	p7
	YZ250F('14~)	LMAR8G	-	p7
	YZ250F(~'13)	CR8E	CR-EIX, R0373A-	
	YZ250	BR8EG	BR-EIX, R7376-	p3
	YZ125	BR9EVX	BR-EIX, R7376-	
	YZ85/LW	BR10EG	BR-EIX, R7376-	
	WR250R/X	CR9EK	CR-EIX, R0373A-	p7
▶ APRILIA				
Road	RSV4	CR9EKB	R0373A-※2, R0045Q-※2	p7
	RS4 125	CR9EB	CR-EIX※2, R0373A-※2	
▶ BMW				
Road	S1000RR	LMAR9D-J	R0465B-※2	p6
▶ DUCATI				
Road	1199 Panigale S/R	MAR9A-J	-	
	1198/S/R	MAR10A-J	-	
	1098/S/R	MAR10A-J	-	
	899 Panigale	MAR9A-J	-	
▶ KTM				
Road	1190 RC8/R	LKAR9B19, LMAR7A-9※3	-	
Motocross	450SX-F('13~)	LKAR8AI-9	-	p7
	450SX-F('07~'12)	CR9EKB	R0373A-※2	
	350SX-F('11~)	LMAR9AI-8	-	p6
	250SX-F('13~)	LMAR9AI-8	-	
	250SX-F('06~'12)	CR9EKB	R0373A-※2	p7
	125SX('02~'08)	BR9EVX	BR-EIX, R7376-	p3
	65SX('09~)	LR8B	-	p7
	50SX('09~)	CR8H5A	CR-HIX	

※1: The thread length is longer than the normal type due to setting the detonation counter.

※2: You need terminal nut.

※3: There are two product numbers for twin spark engines.

SERIES OF NGK SPARK PLUGS

NGK ZÜNDKERZENSERIEN

SÉRIES DES BOUGIES NGK

SERIES DE BUJÍAS DE ENCENDIDO NGK TYPBETECKNINGAR FÖR NGK TÄNDSTIFT

STANDARD TYPES

STANDARD AUSFÜHRUNGEN
TIPOS ESTANDARES

TYPES STANDARDS
STANDARDTYPER

	NON-RESISTOR NON-RÉSISTANCE ICKERESISTOR	OHNE WIDERSTAND NO-RESISTOR	RESISTOR RÉSISTANCE RESISTOR	MIT WIDERSTAND RESISTOR	
ϕ 14mm \times 9.5mm Hex 20.8mm Fig. ①a	B-2 B-4 B6S B7S B8S		BR6S		
	Fig. ①c	BP-4 BP5S BP6S			
ϕ 14mm \times 19.0mm Hex 20.8mm Fig. ②a	B4ES B5ES B6ES,-11 B7ES,-11 B8ES B9ES B10ES		BR4ES BR5ES BR6ES,-11 BR7ES BR8ES,-11 BR9ES BR10ES		
	Fig. ②b		BR6EB-L-11		
	Fig. ②h		BR8EYA BR9EYA BR10EYA		
	Fig. ②c	BP2ES, BP-2E BP4ES,-11 BP5ES,-11,-13 BP6ES,-11 BP7ES,-11 BP8ES BP9ES	BP5ESZ BP6ESZ	BPR2ES, BPR-2E BPR4ES,-11,-13 BPR5ES,-11,-13 BPR6ES,-5,-11 BPR7ES,-11 BPR8ES,-6 BPR9ES	
	Fig. ③e			BPR6EKN BPR7EKN	
	Fig. ②f	BP4EY,-11 BP5EY,-11 BP6EY,-11 BP7EY		BPR4EY,-11 BPR5EY,-11 BPR6EY,-11 BPR7EY,-11	
	Fig. ②j	BP5E BP6E		BPR4E,-11 BPR5E,-11 BPR6E,-11 BPR7E	
	Fig. ④g	BP5ET,-10 BP6ET BP7ET			
	Fig. ⑤i			BPR5EJ	
ϕ 14mm \times 19.0mm Hex 16.0mm Fig. ⑥c	BCP4ES,-11 BCP5ES,-11 BCP6ES,-11 BCP7ES,-11		BCPR5ES,-11 BCPR6ES,-11 BCPR7ES,-11 BCPR9ES,-11		
	Fig. ⑧g ISO	BCP5ET BCP6ET BCP7ET	BCPR5ET BCPR6ET BCPR7ET		
	Fig. ⑥a	BC6ES	BCR8ES		
	Fig. ⑦c ISO	BK5ES	BK5ESZ	BKR4ES,-11 BKR5ES,-11 BKR6ES,-11 BKR7ES,-11	

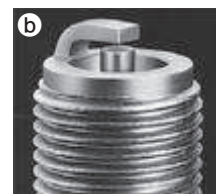
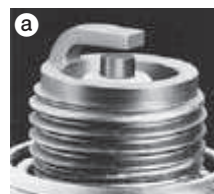
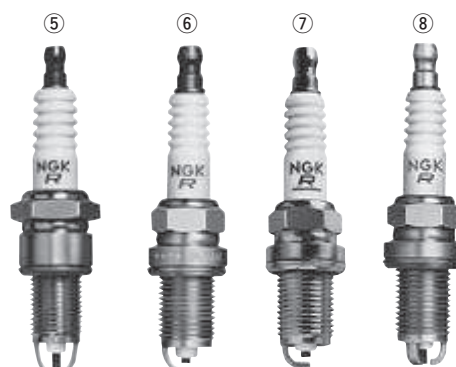
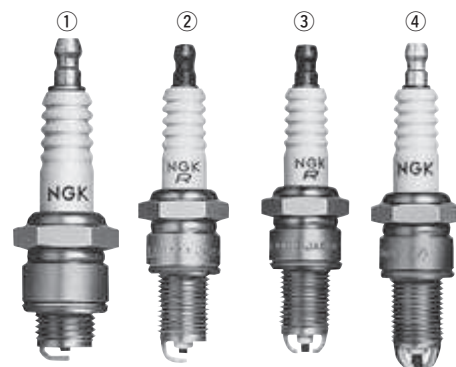



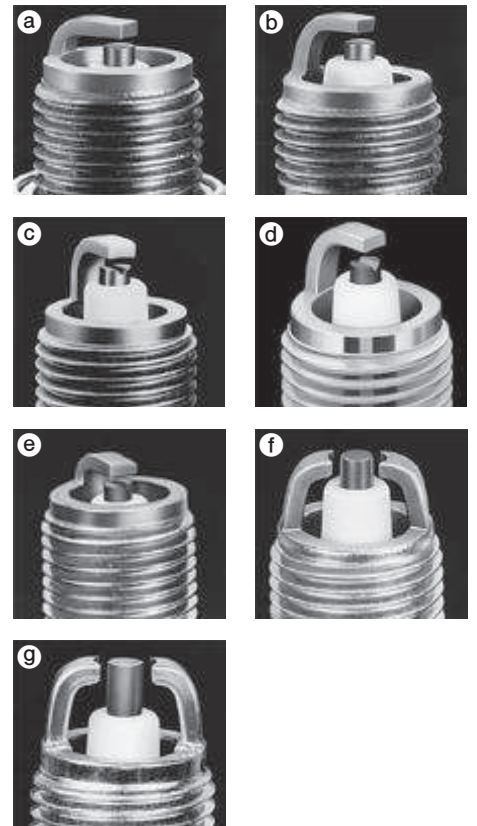
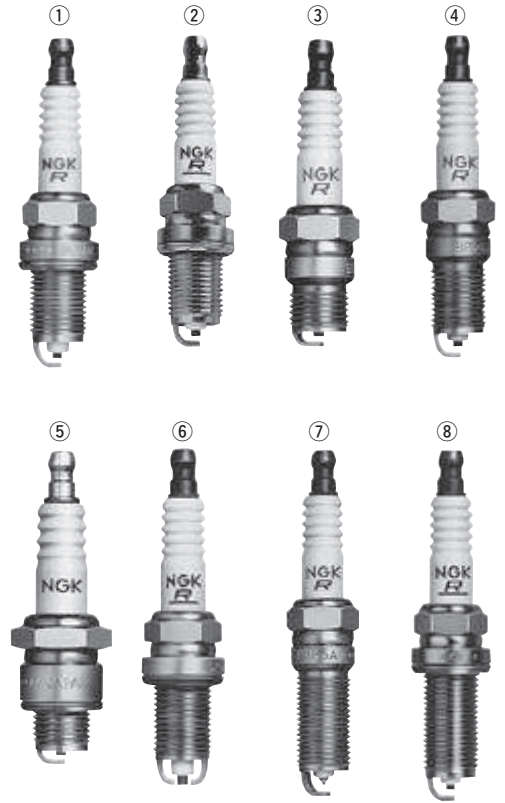

	NON-RESISTOR OHNE WIDERSTAND NON-RÉSISTANCE NO-RESISTOR ICKERESISTOR	RESISTOR MIT WIDERSTAND RÉSISTANCE RESISTOR RESISTOR	
ϕ 14mm × 19.0mm Hex 16.0mm Fig. ① ③		BCPR4EY,-11 BCPR5EY,-11 BCPR6EY,-11,-N-11 BCPR7EY,-11,-N-11	
	Fig. ② ③ ISO	BKR4EY,-11 BKR5EY,-11 BKR5EYA,-11 BKR6EY,-11 BKR6EYA,-11 BKR7EY	
	Fig. ① ④	BCPR5E,-11 BCPR6E,-11 BCPR7E,-11	
	Fig. ② ④ ISO	BKR4E,-11 BKR5E,-11,-N,-N-11 BKR5EZ BKR6E,-11,-E,-N,-N-11 BKR6EZ BKR7E,-11,-N-11 BKR8E,-11 FR6F-11DK FR6F-11K	
	Fig. ⑥ ⑦ ISO	BKR5EK BKR6EK	
	Fig. ⑥ ⑧ ISO	BKR5EKB,-11 BKR6EKB,-11 BKR5EKC BKR6EKC,-N-11 BKR6EKE BKR7EKC,-N,-N-11	
ϕ 14mm × 26.5mm Hex 16.0mm Fig. ⑧ ④		LFR4A,-11 LFR4A-E LFR5A,-11 LFR6A,-11 LFR7A	
ϕ 14mm × 11.2mm Conical seat Hex 16.0mm Fig. ③ ①	B7FS	BR5FS BR6FS,-15	
	Fig. ③ ②	BP4FS BP5FS BP6FS BP7FS	BPR4FS,-11,-15 BPR5FS,-11,-15 BPR6FS
	Fig. ③ ④	BP5F BP6F	
ϕ 14mm × 17.5mm Conical seat Hex 16.0mm Fig. ④ ①	B8EFS B9EFS	BR7EFS	
	Fig. ④ ⑤		BR6EF BR7EF
	Fig. ④ ②	BP5EFS,-13 BP6EFS,-13 BP7EFS	BPR5EFS,-13 BPR6EFS,-13,-15 BPR7EFS-15
	Fig. ④ ④	BP6EF	BPR6EF,-11,-13
ϕ 14mm × 25.0mm Conical seat Hex 16.0mm Fig. ⑦ ②		TR5A-13 TR5B-13 TR6B-10	
ϕ 14mm × 11.2mm Hex 20.8mm Fig. ⑤ ①	B-4L B-6L B6LY(Fig. ⑤ ⑤)		

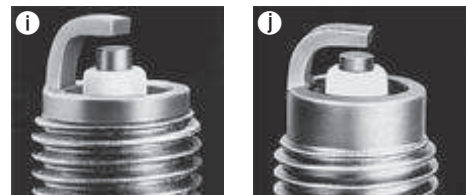
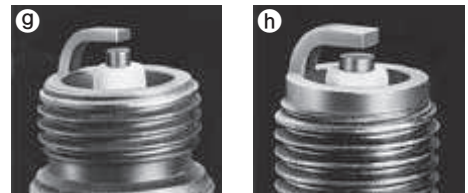
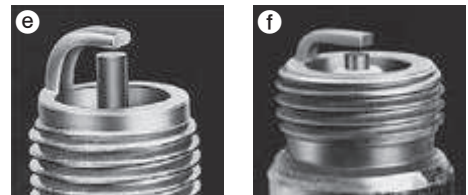
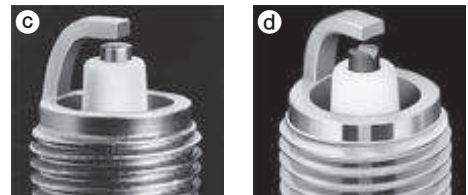
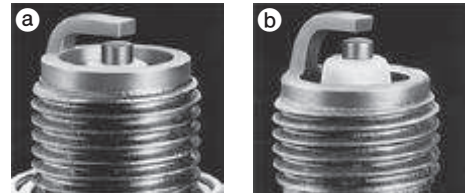





	NON-RESISTOR NON-RÉSISTANCE ICKERESISTOR	OHNE WIDERSTAND NO-RESISTOR	RESISTOR RÉSISTANCE RESISTOR	MIT WIDERSTAND RESISTOR	
ϕ 14mm \times 12.7mm Hex 20.8mm Fig. ①(a)	B-2H B-4H,-10 B5HS B6HS,-10 B7HS,-10 B8HS,-10 B9HS B10HS		BR4HS BR5HS BR6HS,-10 BR7HS,-10 BR8HS,-10 BR9HS,-10 BZ7HS-10		
	Fig. ①(b)	BP2HS BP4HS,-10 BP5HS,-10 BP6HS,-10 BP7HS,-10 BP8HS,-10,-15	BP-2H BP-4H BP6H BP7H	BPR2HS BPR4HS,-10 BPR5HS BPR6HS,-10 BPR7HS,-10 BPR8HS,-10	BPR4HSA BPR-4H BPR6HSA BPZ8H-N-10 BPR8HSA BPZ8HS-10,-15
	Fig. ①(c)	BP4HA			
	Fig. ①(e)	B6HSA B8HSA		BR4HSA BR6HSA,-9 BR8HSA,-9	
ϕ 18mm \times 12.0mm Hex 20.8mm Fig. ⑤(f)	AB-2 AB-6 AB-7 AB-8				
ϕ 18mm \times 16.0mm Hex 25.4mm			R8102B-10		
ϕ 12mm \times 19.0mm Hex 18.0mm Fig. ⑥(h)	D6EA D7EA D8EA D9EA D10EA		DR7EA DR7EB DR8EA DR8EB DR9EA		
	Fig. ⑥(i)	DP6EA-9 DP7EA-9 DP8EA-9 DP9EA-9	DPR5EA-9 DPR6EA-9 DPR6EB-9 DPR7EA-9 DPR8EA-9 DPR9EA-9		
	Fig. ⑥(h)	J9A	JR8B JR9B JR10B		
	Fig. ⑥(k)		JR8C JR9C		
ϕ 12mm \times 21.0mm Hex 18.0mm Fig. ⑦(i)	DP8Z		DPR7Z DPR8Z DPR9Z		
ϕ 12mm \times 19.0mm Hex 16.0mm Fig. ⑧(i)	DCP6E DCP7E		DCPR6E DCPR7E,-N DCPR8E,-N DCPR9E	KR6A-10 KR8C-G KR9C-G	
	Fig. ⑧(m)		DCPR8EKC		
ϕ 12mm \times 20.5mm Hex 16.0mm			KER7A-8DEG		
ϕ 12mm \times 26.5mm Hex 16.0mm Fig. ⑨(b)			LKR6C LKR6E LKR6F-10 LKR7E		
ϕ 12mm \times 25.0mm Hex 14.0mm			LNAR7A-9G		
ϕ 12mm \times 26.5mm Hex 14.0mm Fig. ⑨(b)			LZKAR6C-9 LZKAR7D-9,-9D LKAR8A-9,-9S		

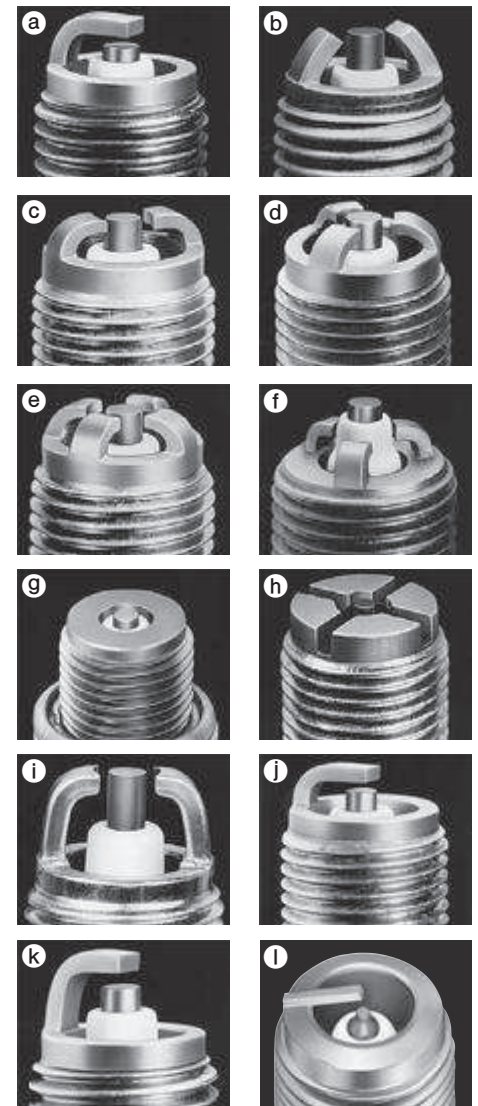
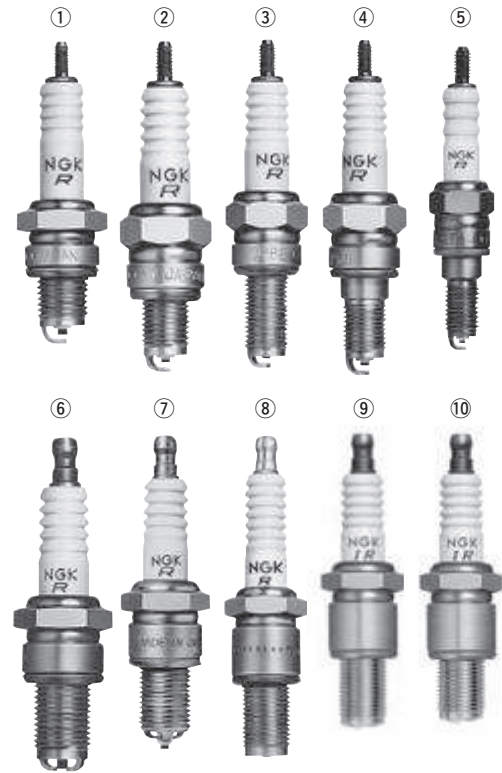

	NON-RESISTOR OHNE WIDERSTAND NON-RÉSISTANCE NO-RESISTOR ICKERESISTOR	RESISTOR MIT WIDERSTAND RÉSISTANCE RESISTOR RESISTOR
ϕ 12mm \times 12.7mm Hex 18.0mm Fig. ①②	D6HA D8HA	DR4HS DR5HS DR6HS DR8HS
ϕ 10mm \times 12.7mm Hex 16.0mm Fig. ②③	C2H C5HSA C6HSA C7HSA C8HSA	C4HSB C5HSB CR4HSA CR4HSB LR4C-E CR5HSA CR5HSB CR6HSA LR6E CR7HSA LR7D CR8HSA CMR8H LR8A LR8B
ϕ 10mm \times 19.0mm Hex 16.0mm Fig. ③④	C7E C8E C9E	CR6E CR6EB CR7EK CR7EB CR8EK CR8EB CR9EK CR9EB CR10E
		D CPR6EA-9S CPR7EA-9 CPR8E
ϕ 10mm \times 19.0mm Hex 16.0mm Fig. ④⑤	C8EH-9 C9EH-9	CR5EH-9 MR7C-9N MR7E-9 MR7F CR8EH-9 MR8C-9N MR8D-9 MR8E-9 MR8F CR9EH-9 MR9C-9N
ϕ 10mm \times 19.0mm Hex 16.0mm Fig. ③⑥		CR7EKB CR7EKB CR8EKB CR8EKB CR9EKB CR9EKB CR10EK
		CR7EKC
ϕ 10mm \times 19.0mm Hex 14.0mm Fig. ⑥		MAR8B-JDS MAR9A-J MAR9B-JDS MAR10A-J
ϕ 10mm \times 26.5mm Hex 14.0mm Fig. ⑦		LMAR6A-9 LMAR6C-9 LMAR7A-9 LMAR7H-9DS LMAR8A-7,9,9S LMAR8F-9 LMAR8G
		LMAR9D-J
ϕ 8mm \times 19.0mm Hex 13.0mm Fig. ⑤⑧		ER8EH, -N ER9EH, -N, -6N ER10EH



FOR ROTARY ENGINE
FÜR WANKELMOTOR **POUR MOTEUR ROTATIF**
PARA MOTOR ROTATIVO **TÄNDSTIFT FÜR WANKELMOTORER**

	NON-RESISTOR OHNE WIDERSTAND NON-RÉSISTANCE NO-RESISTOR ICKERESISTOR	RESISTOR MIT WIDERSTAND RÉSISTANCE RESISTOR RESISTOR
ϕ 14mm \times 19.5mm Hex 20.8mm Fig. ⑥③	B7EM	BR8EM
		BR7ET BR8ET BR9ET BR10ET
		BR8EQ,-14 BR9EQ,-14
ϕ 14mm \times 21.5mm Hex 20.8mm Fig. ⑧⑨		SD10A SD11A
		BUR6EQ BUR7EQ BUR7EQP BUR8EQ BUR8EQP BUR9EQ BUR9EQP
ϕ 14mm \times 21.0mm Hex 20.8mm Fig. ⑨		RE6C-L RE7C-L RE8C-L
ϕ 14mm \times 19.0mm Hex 20.8mm Fig. ⑩⑪		RE9B-T

SEMI SURFACE DISCHARGE TYPES AND SUPPLEMENTARY GAP TYPE

HALBGLEITFUNKENTYPEN UND ZUSÄTZLICHER ABSTANDSTYP
 TYPE À DÉCHARGE SEMI-SURFACIQUE ET TYPE À ÉCARTEMENT SUPPLÉMENTAIRE
 TIPO DE DESCARGA DE MEDIA SUPERFICIE Y TIPO DE GALGA SUPLEMENTARIA
 STIFT MED SEMI-YTGNISTGAP OCH STIFT AV SUPPLEMENTÄR TYP

	NON-RESISTOR NON-RÉSISTANCE ICKERESISTOR	OHNE WIDERSTAND NO-RESISTOR	RESISTOR RÉSISTANCE RESISTOR	MIT WIDERSTAND RESISTOR
ϕ 14mm \times 12.7mm Hex 20.8mm Fig. ①②	BU8H		BUZ8H	
ϕ 14mm \times 19.0mm Hex 20.8mm Fig. ②③			BUR5EA-11 BUR6EA-11 BUR7EA-11	
ϕ 14mm \times 19.0mm Hex 20.8mm Fig. ②④			BUR4EB-11 BUR5EB-11 BUR6EB-11 BUR7EB-11	
	Fig. ②⑤		BUR5ET,-10 BUR6ET	
ϕ 14mm \times 19.0mm Hex 20.8mm Fig. ③⑥			BPR6EK-A	
	Fig. ③⑦		BPR5EKU	
ϕ 14mm \times 17.5mm Conical seat Hex 16.0mm Fig. ④⑧	BU6EFSZ		BUR6EFSZ	
ϕ 14mm \times 19.0mm Hex 16.0mm Fig. ⑥⑨ ISO			BKUR6EK,-9 BKUR7EK	
	Fig. ⑤⑩ ISO		BKUR5ET,-10 BKUR5ETZ,-10 BKUR6ET,-10 BKUR6ETB BKUR7ET	
	Fig. ⑥⑪ ISO		BKR5EKU BKR6EKU BKR7EKU	
			BKR6EKUE	
	Fig. ⑥⑫ ISO		BKR6EKUB	
ϕ 14mm \times 22.0mm Hex 16.0mm Fig. ⑦⑬			BKR5EKUC BKR6EKUC	
ϕ 14mm \times 19.0mm Hex 16.0mm Fig. ⑥⑭			BKR6EQUA	

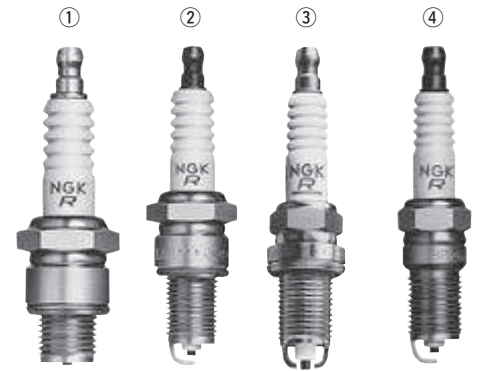

PROJECTED GAP TYPES

ZUNDKERZEN MIT VORSPRINGENDER FUNKENSTRECK

TYPE À ÉCARTEMENT EN SAILLIE

TIPOS DE ABERTURA DE CHISPA PROYECTADA

STIFT MED FÖRLÄNGDA ELEKTRODER

	NON-RESISTOR NON-RÉSISTANCE ICKERESISTOR	OHNE WIDERSTAND NO-RESISTOR	RESISTOR RÉSISTANCE RESISTOR	MIT WIDERSTAND RESISTOR
ϕ 14mm × 19.0mm Hex 20.8mm Fig. ①(a) Fig. ②(b)	BE529Y-11		BRE527Y-11 BRE529Y,-11	
			ZGR4A ZGR5A	
ϕ 14mm × 20.5mm Hex 20.8mm Fig. ②(b)			ZGR5B,-11 ZGR6B-11	
ϕ 14mm × 22.0mm Hex 20.8mm Fig. ②(c)			ZGR5C	
ϕ 14mm × 19.0mm Hex 16.0mm Fig. ③(b)	ZF6A-11		ZFR5A-11 ZFR6A-11	
	Fig. ④(b) ISO		ZFR4F-11 ZFR5F,-11 ZFR6F-11,G ZFR7F-11	ZFR5J-11 ZFR6J-11 ZFR7J-11
	Fig. ③(a)		BCRE527Y	
ϕ 14mm × 20.5mm Hex 16.0mm Fig. ③(e)			ZFR6K-9E,-11S	
			ZFR5G ZFR6G	
ϕ 14mm × 22.5mm Hex 16.0mm Fig. ③(c)			ZFR4E-11 ZFR5E-11 ZFR6E-11	
	Fig. ③(d)		ZFR5D-11	
ϕ 14mm × 25.0mm Conical seat Hex 16.0mm Fig. ⑤(b)			LZTR4A-11 LZTR5A-13	
ϕ 12mm × 19.0mm Hex 16.0mm			ZKR7A-10	
ϕ 12mm × 21.5mm Hex 16.0mm			ZKER6A-10DEG,-10EG	
ϕ 12mm × 26.5mm Hex 16.0mm			LZKR6B-10E	
ϕ 12mm × 26.5mm Hex 14.0mm			LZKAR6C-11	
ϕ 12mm × 26.3mm Bi-Hex 14.0mm			ZKBR7A-HTU	

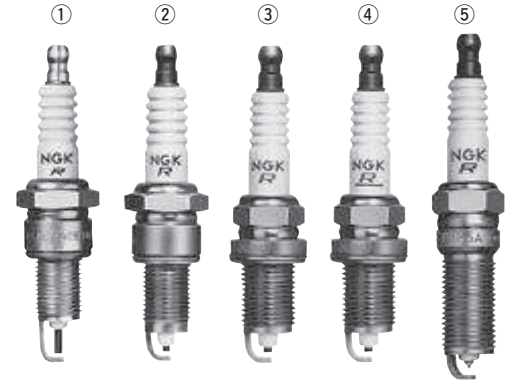

SLANT GROUND ELECTRODE TYPE

SCHRÄGER MASSENELEKTRODENTYP

TYPE À ÉLECTRODE DE MASSE À INCLINAISON

TIPO DE ELECTRODO DE MASA INCLINADO

STIFT MED VINKLAD SIDOELEKTROD

ϕ 14mm × 12.7mm Hex 20.8mm Fig. ⑥(f)	B7HCS B8HCS B9HCS	BR8HCS-10
ϕ 14mm × 19.0mm Hex 20.8mm Fig. ⑦(f)	B7ECS B8ECS B9ECS	BR8ECS BR9ECS BR10ECS
	Fig. ⑧(f)	BR8ECM BR9ECM BR10ECM

	RESISTOR MIT WIDERSTAND RÉSISTANCE RESISTOR RESISTOR
ϕ 14mm \times 17.5mm conical seat Hex 16.0mm Fig. ⑨①	PTR4B-15 PTR5C-13 ITR4A15 ITR6F13
ϕ 14mm \times 17.5mm conical seat Hex 16.0mm Fig. ③④⑤ Fig. ⑨⑨	ITR5H13 PTR5D-10,-13 TR5AI-13 TR5AP-13 ITR6G9 PTR6D-13,-13G ITR7J9D PZTR5A-15
ϕ 14mm \times 20.5mm Hex 16.0mm Fig. ③④⑤	IZFR6K11,11E,13 IZFR6K-11S,IZFR6K11NS PZFR7G-G
ϕ 14mm \times 21.5mm Hex 16.0mm Fig. ④	PZFR5N-11T
ϕ 14mm \times 22.0mm Hex 16.0mm Fig.	PZFR6J-11
ϕ 14mm \times 26.5mm Hex 16.0mm Fig. ⑪	PLFR4A-11 PLFR5A-9,-11 ILFR5T11 ILFR5B11 DILFR5A11 DILFR5C11 DILFR5E11 DF5B-8A DILFR5L11 ILZFR5E8D LZFR5CI-11 PLFR6A-9,-11 ILFR6T11 ILFR6K8 ILFR6G,-E SILFR6A11 DILFR6D11D DILFR6L11 PLFR7A-9 DILFR7K9G ILFR7A8EG SILZFR7A9G PLZFR6A-11S ILZFR6A11 DILFR7B10G 155CX 156CX
ϕ 14mm \times 28.0mm Hex 16.0mm Fig. ⑪	LZFR5BI-11 LZFR5DI-11 LZFR6AI
ϕ 14mm \times 29.5mm Hex 16.0mm Fig. ⑪⑫	LZFR5AQP
ϕ 14mm \times 25.0mm conical seat Hex 16.0mm	PLZTR4A-13 PLZTR5A-13 ILTR5A-13G ILTR5P11D LTR5BI-13 LTR6AP-11 ILTR6A-8G,-13G ILTR6J13 ILTR6M9G LTR6AI-8 LTR6BI-13 LTR6BI-9 LTR6DI-8 LTR6DP13 ILTR7E9D ILTR7J8 ILTR7N8 ILTR7Q9 LTR7CP13
ϕ 12mm \times 19.0mm Hex 18.0mm Fig. ⑤⑥	PJR6A PJR7A IJR7A9 PJR8A
ϕ 12mm \times 19.0mm Hex 16.0mm	IKR6G8 IKR7H8 IZKR8C10D SIKR8B7G IKR9H8 IKR9J8 147CX
ϕ 12mm \times 19.0mm Hex 16.0mm Fig. ⑦⑧	PKR7A PKR9B KR7AI KR8AI KR9CI IKR6G11 IKR9F8
ϕ 12mm \times 19.0mm Hex 16.0mm Fig. ⑦⑧	DCPR8EKP
ϕ 12mm \times 20.5mm Hex 16.0mm	IKER7A8EGS ZKR7BI-10 PKER7A8EGS PKER7A8DES
ϕ 12mm \times 21.5mm Hex 16.0mm	PZKER7B8EGS
ϕ 12mm \times 22.0mm Hex 16.0mm	IZKR7A
ϕ 12mm \times 26.5mm Hex 16.0mm	ILKR6F11 ILZKR6F11 SILKR6C10E SILKR6D10G ILKR7D8 ILKR7J8 ILKR7K8 ILKR7L8G ILZKR7D8 ILZKR7E10DG LKR7F1-8 SILKR7C8DE SILZKR7E11 SILZKR7E8EG SILZKR7E9 SILZKR7E9G SILZKR7G8DE ILKR8M5D ILKR8P8 SILZKR8E8D SILZKR8E8G ILKR9G8 ILKR9H8 HKS-G40XL
Fig. ⑩	DILKR7E11
Fig.	
ϕ 12mm \times 28.0mm Hex 16.0mm	DILZKR7B11G ILZKR7G7G
ϕ 12mm \times 29.0mm Hex 16.0mm	SILZKKER8A8E
ϕ 12mm \times 25.0mm Hex 14.0mm	SILZNAR6D9 SILNAR7B7 SILNAR7C7DG ILNAR8B7G ILZNAR8B7G SILNAR8A7
ϕ 12mm \times 26.5mm Hex 14.0mm	ILKAR7L11 ILKAR7L11D ILKAR7M10 ILZKAR7D11 LKAR7CI-8 ILKAR8H6 LKAR8CI-8 SILKAR8C6DG SILKAR8C6DS SILKAR8D6 SILKAR8E4DG SILKAR8F8 SILZKAR8D4D SILZKFR8B7S SILZNAR8C7H HKS-M50HL
Fig. ⑬⑭	LKAR8AP7JD LKAR8AP7JDS
Fig. ⑬⑮	DILKAR7B8 DILKAR7G11DS DILKAR7H11GS DILKAR7M8 DILZKAR7B11 DILKAR8J9G DILKAR8K8D DILKAR8L8D
Fig. ⑬	

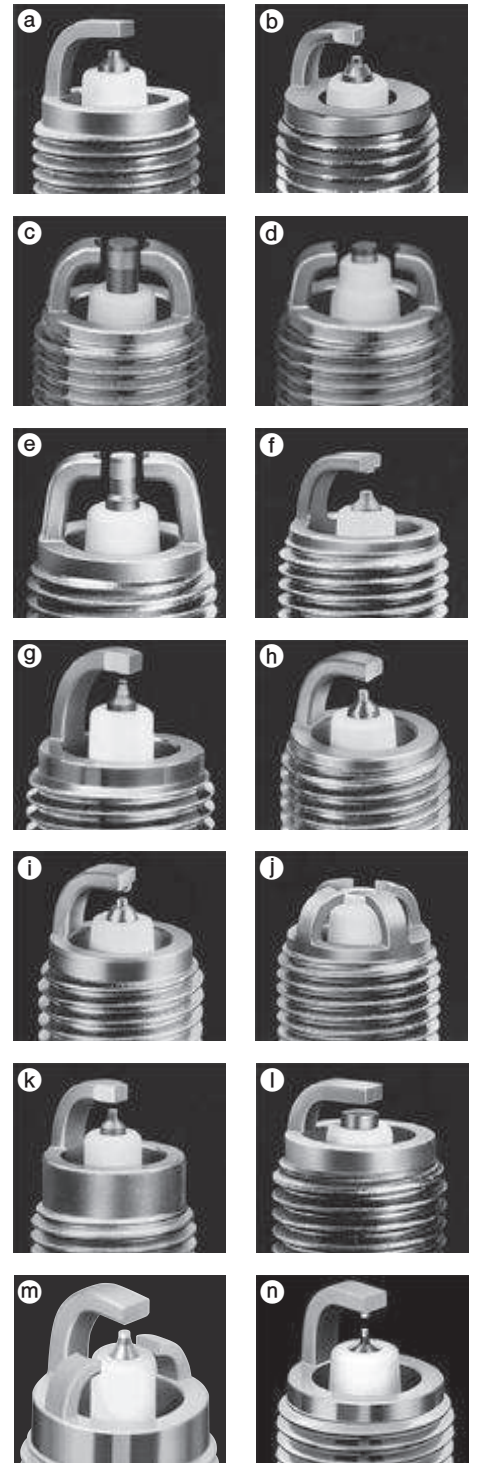

	RESISTOR MIT WIDERSTAND RÉSISTANCE RESISTOR RESISTOR
ϕ 12mm \times 27.0mm Hex 14.0mm	SILZKFR8C7S SILZKFR8D7S
ϕ 12mm \times 27.5mm Hex 14.0mm	SILZKFR8E7S
ϕ 12mm \times 28.0mm Hex 14.0mm Fig. (k)	DILZKAR7C11S ILZKAR7E11S ILZKAR8F8S ILZKAR8G8 ILZKAR8H8S ILZKAR8J8SY ILZKAR8A7G SILZKAR8F7S
ϕ 12mm \times 28.5mm Hex 14.0mm Fig. (n)	DILKA7E9HS
ϕ 10mm \times 19.0mm Hex 16.0mm Fig. (8i)	CR9EBI-9
Fig. (8)	MR8CI-8 SIMR7B9DS
Fig. (8c)	MR8BI-8
ϕ 10mm \times 19.0mm Hex 16.0mm Fig. (12)	
ϕ 10mm \times 22.0mm Hex 16.0mm	MR8BP8HJS
ϕ 10mm \times 26.5mm Hex 14.0mm Fig. (14)	ILMAR7B8 LMAR7CI-8 SILMAR7D9DS ILMAR8C9D LMAR8AI-8E LMAR8BI-9 SILMAR8C9 SILMFR8A8G SILMAR9B9
ϕ 10mm \times 26.5mm Hex 14.0mm Fig. (d)	LMAR9AP8JS
ϕ 12mm \times 26.5mm Bi-Hex 14.0mm	ILZKBR7B8DG PLZKBR7B8DG SILZKBR8B8HG SILKGR9A7EG
ϕ 12mm \times 27.5mm Bi-Hex 14.0mm	SILZKBR8D8S SILZKBR8E8S SILZKGR8A8S SILZKGR8B8S
ϕ 12mm \times 28.0mm Bi-Hex 14.0mm	SILZKG8D7E
ϕ 12mm \times 28.5mm Bi-Hex 14.0mm	SILZKBR8F8S SILZKGR8C8S

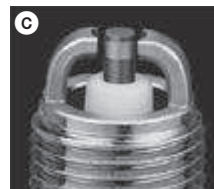

COMPACT TYPES

KOMPAKT STIFT
TIPOS COMPACTOS

TYPES COMPACTES
KOMPAKTE TYPEN

	NON-RESISTOR NON-RÉSISTANCE ICKERESISTOR	OHNE WIDERSTAND NO-RESISTOR	RESISTOR RÉSISTANCE RESISTOR	MIT WIDERSTAND RESISTOR
ϕ 18mm × 16mm Hex 25.4mm	R8160B-10			
ϕ 14mm × 9.5mm Hex 19.0mm Fig. ①(a)	BM4A	B2-LM * B4-LM *	BMR2A,-10 BMR4A BMR6A BMR7A	BR2-LM * BR4-LM * * Hex.20.8mm
	BM6A BM7A	BM6 * BM7 * * Hex.20.8mm	BPMR4A,-10 BPMR6A,-10 BPMR7A,-9	
ϕ 14mm × 12.7mm Hex 20.8mm Fig. ①(b)	BPM4A BPM6A,-10 BPM7A			
ϕ 14mm × 12.7mm Hex 20.8mm Fig. ②(a)	BL-6H			
ϕ 14mm × 7.8mm Conical seat Hex 16.0mm Fig. ③(a)	BM6F BM7F	BM6FY	BMR6F	
	BPM6F BPM7F		BPMR6F	
ϕ 10mm × 8.6mm Hex 14.0mm Fig. ④(a)	CM-6			
ϕ 10mm × 9.5mm Hex 16.0mm Fig. ⑧(a)	CMR6A CMR7A			
ϕ 10mm × 12.7mm Hex 16.0mm Fig. ⑧(e)	CMR5H CMR6H CMR7H			
ϕ 14mm × 9.5mm Hex 19.0mm Fig. ①(c)	BPM6Y BPM7Y BPM8Y		BPMR6Y BPMR7Y BPMR8Y	



FARM EQUIPMENT TYPES

LANDMASCHINEN TYPEN TYPES MACHINES AGRICOLES
TIPOS MÁQUINAS AGRÍCOLAS FÖR JORDBRUKS-MASKINER

PF1/2" × 22.5mm Hex 23.8mm Fig. ⑤(d)	G-27 G-2Z
--	----------------------------

SURFACE DISCHARGE TYPES

GLEITFUNKENTYPEN TYPE À DÉCHARGE SUPERFICIELLE
TIPO DESCARGA EN SUPERFICIE TÄNDSTIFT MED YTGNIISTGAP

ϕ 14mm × 12.7mm Hex 20.8mm Fig. ⑥(f)	BUHX(Series gap) BUHXW-1(Series gap)	
	BUH	
	BUHW BUHW-2	BUZHW BUZHW-2
ϕ 14mm × 19.0mm Hex 20.8mm Fig. ⑦(f)	BUE	

RACING TYPES

RENN-TYPEN TYPES COURS
TIPOS DE CARRERAS RACERSTIFT

	Nickel electrode Nickel Elektrode Electrodo de nickel Electrodo de niquel Nickel elektrod	Precious metal electrode Elektrode mit sonde-redel metall Electrode en metal precieux Electrodo de metal precioso Ädelmetall elektrod	Platinum electrode Platinel Elektrode Electrode de platine Electrodo de platino Platina elektrod
ϕ 14mm × 19.0mm Hex 20.8mm	(Fig. ⑨(g) B8EGV BR8EG* B9EGV BR9EG* B10EGP BR10EG* B11EG	(Fig. ⑨(g) B8EGV B85EGV B9EGV B95EGV B10EGV B105EGV B11EGV	(Fig. ⑨(h) B10EGP

*Resistor Type

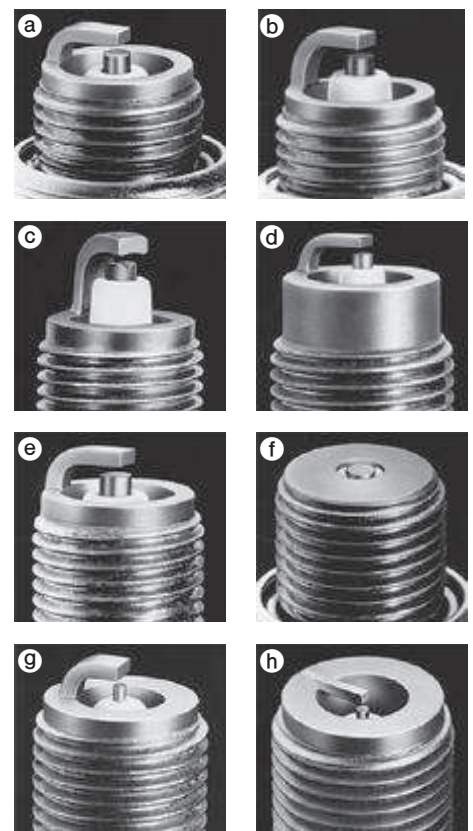

IX TYPES

IX TYPEN TYPES IX
TIPOS IX IX-STIFT

	RESISTOR RÉSISTANCE RESISTOR	MIT WIDERSTAND RESISTOR	
ϕ 18mm \times 10.9mm Hex 20.8mm Fig. ①(a)	WR5IX		
ϕ 14mm \times 19.0mm Hex 20.8mm Fig. ②(b)	GR4IX GR5IX		
	BPR5IX , -11 BPR6IX , -11 BPR7IX BPR8IX BPR9IX BPR10IX		
	Fig. ②(c)	BR7IX BR8IX BR9IX BR10IX	
	Fig. ②(d)	BR8ECSIX BR9ECSIX , -5	
ϕ 14mm \times 12.7mm Hex 20.8mm Fig. ④(b)	BPR6HIX BPR7HIX BPR8HIX		
	Fig. ④(c)	BR6HIX BR7HIX BR8HIX BR9HIX BR10HIX	
ϕ 14mm \times 9.5mm Hex 20.8mm Fig. ⑤(a)	XR4IX XR5IX XR45IX		
ϕ 14mm \times 19.0mm Hex 16.0mm Fig. ⑥(b)	BCPR7EDIX		
	Fig. ⑦(b)	BCPR5IX , -11 BCPR6IX , -11 BCPR7IX , -11	
	Fig. ⑧(b)	BKR4IX BKR5IX , -11 BKR6IX , -11 BKR7IX , -11 BKR8IX BKR9IX	
Fig. ⑧(e)	ZFR5FIX -11 ZFR6FIX -11		
ϕ 14mm \times 26.5mm Hex 16.0mm Fig. ⑨(b)	LFR5AIX -11 LFR6AIX -11 LFR7AIX	LKR6AIX LKR7AIX	LKR6AIX -P LKR6CIX
ϕ 14mm \times 17.5mm Conical seat Hex 16.0mm Fig. ⑩(b)	BPR6EFIX -10, -15		
	Fig. ⑩(a)	TR4IX TR5IX TR6IX TR7IX TR8IX	TR55IX TR65IX TR75IX TR85IX
ϕ 14mm \times 20.5mm Conical seat Hex 16.0mm Fig. ⑪(e)	TR5 -11X	TR45 -11X TR55 -11X	
ϕ 14mm \times 11.2mm Conical seat Hex 16.0mm Fig. ⑫(c)	YR5IX YR55IX		
	Fig. ⑫(c)	BR6FIX	
Fig. ⑫(a)	UR4IX UR5IX UR6IX	UR45IX UR55IX	
ϕ 14mm \times 25.0mm Conical seat Hex 16.0mm Fig. ⑬(b)	LTR5IX -11 LTR6IX -11 LTR7IX -11		
	Fig. ⑬(e)	LZTR4AIX -11 LZTR5AIX -13 LZTR6AIX -13 LZTR7AIX -13	

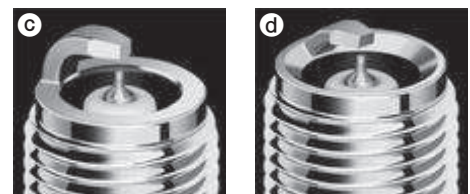
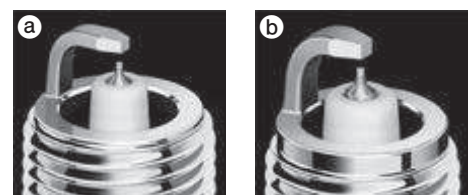
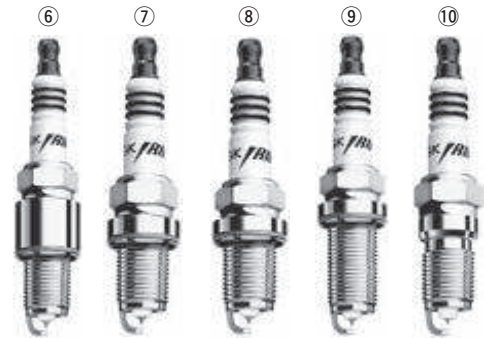



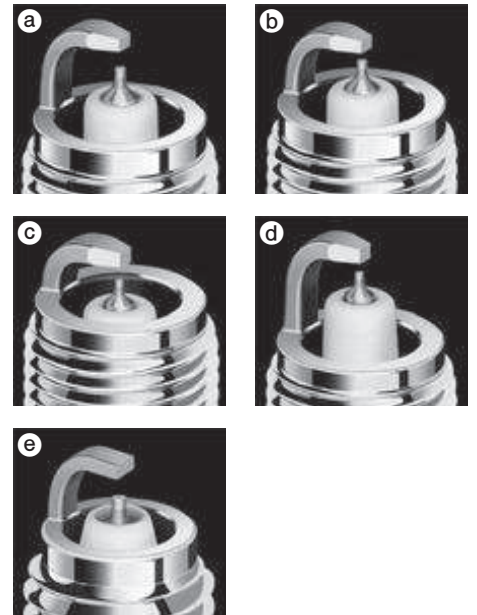

IX TYPES

IX TYPEN TYPES IX
TIPOS IX IX-STIFT

	RESISTOR RÉSISTANCE RESISTOR	MIT WIDERSTAND RESISTOR
ϕ 12mm × 19.0mm Hex 16.0mm Fig. ①(a)	DCPR6EIX DCPR7EIX DCPR8EIX DCPR9EIX	
	Fig. ①(b)	DCR7EIX DCR8EIX DCR9EIX
ϕ 12mm × 19.0mm Hex 18.0mm Fig. ②(a)	DPR7EIX-9 DPR8EIX-9 DPR9EIX-9	
	Fig. ②(b)	DR7EIX DR8EIX DR9EIX
ϕ 12mm × 21.0mm Hex 18.0mm Fig. ③(a)		DPR8ZIX
ϕ 12mm × 26.5mm Conical seat Hex 14.0mm Fig. ④(d)		ZNAR7AIX ZNAR6AIX-11
ϕ 12mm × 26.5mm Hex 14.0mm		LZKR6AIX
ϕ 10mm × 19.0mm Hex 16.0mm Fig. ⑤(a)		CPR6EAIX-9S CPR7EAIX-9 CPR9EAIX-9
	Fig. ⑤(c)	CR7EIX CR8EIX CR9EIX CR10EIX
	Fig. ⑥(b)	CR8EHIX-9 CR9EHIX-9
ϕ 10mm × 12.7mm Hex 16.0mm Fig. ⑦(b)		CR5HIX CR6HIX CR7HIX CR8HIX CR9HIX
ϕ 8mm × 19.0mm Hex 13.0mm Fig. ⑧(e)		ER8EHIX ER9EHIX



Standard 			Iridium 		
Standard	Iridium	Order N°	Standard	Iridium	Order N°
BR6HS	BR6HIX	3419	C6HSA	CR6HIX	7274
BPR6ES	BPR6EIX	6637	CR9EK	CR9EIX	3521
BR9ES	BR9EIX	3981	BPR7ES	BPR7EIX	4055
BR9EYA	BR9EIX	3981	CR8HS	CR8HIX	7669
BPR9ES	BPR9EIX	6853	C7HSA	CR7HIX	7544
DCPR7E	DCPR7EIX	6046	BKR5E-11	BKR5EIX-11	5464
CR9E	CR9EIX	3521	DR8ES	DR8EIX	6681
B8HS	BR8HIX	7001	DP8EA-9	DPR8EIX-9	2202
B7HS	BR7HIX	7067	DR7ES	DR7EIX	5686
B8ES	BR8EIX	5044	BKR6ES	BKR6EIX	6418
B9ES	BR9EIX	3981	DP7EA-9	DPR7EIX-9	7803
BR8ES	BR8EIX	5044	BPR6HS	BPR6HIX	4085
B10ES	BR10EIX	6801	BP6ES	BPR6EIX	6637
BR10ES	BR10EIX	6801	BP5ES	BPR5EIX	6597
DCPR8E	DCPR8EIX	6546	BP7ES	BPR7EIX	4055
B6HS	BR6HIX	3419	BPR8HS	BPR8HIX	6742
B7ES	BR7EIX	6664	BR9ECM	BR9ECMIX	2707
BKR7E	BKR7EIX	2667	C7E	CR7EIX	7385
BR7ES	BR7EIX	6664	BKR6EKC	BKR6EIX	6418
BR8HS	BR8HIX	7001	DPR9EA-9	DPR9EIX-9	5545
BR7HS	BR7HIX	7067	B9HS	BR9HIX	5687
CR9EKB	CR9EIX	3521	CR8EK	CR8EIX	4218
CR8E	CR8EIX	4218	CR8EH-9	CR8EHIX-9	3797
CR9EB	CR9EIX	3521	C8EH-9	CR8EHIX-9	3797
CR7E	CR7EIX	7385	CR9EH-9	CR9EHIX-9	6216
CR8EB	CR8EIX	4218	BR9HS	BR9HIX	5687
BPR5ES	BPR5EIX	6597	BR8ECM	BR8ECMIX	3520
D7EA	DR7EIX	5686	DP9EA-9	DPR9EIX-9	5545
DPR7EA-9	DPR7EIX-9	7803	BPR5ES-11	BPR5EIX-11	2115
BKR5E	BKR5EIX	6341	ER8EH-N	ER8EHIX	8201
BKR6E	BKR6EIX	6418	CR7HSA-9	CR7HIX	7544
DR8EA	DR8EIX	6681	BR6HSA	BPR6HIX	4085
DPR8EA-9	DPR8EIX-9	2202	BPR6HSA	BPR6HIX	4085
CPR7EA-9	CPR7EAIX-9	9198	ER9EH	ER9EHIX	96652
BR8HSA	BPR8HIX	6742	DCPR6E	DCPR6EIX	8196
BP7HS	BPR7HIX	5944	C8E	CR8EIX	4218
BPR7HS	BPR7HIX	5944	DR9EA	DR9EIX	4772
CR7HSA	CR7HIX	7544	D9EA	DR9EIX	4772
DR8ES-L	DR8EIX	6681	BP6HSA	BPR6HIX	4085
CR7HS	CR7HIX	7544	BP8HS	BPR8HIX	6742
CR8HSA	CR8HIX	7669	BP8ES	BPR8EIX	6684
CR6HSA	CR6HIX	7274	BCPR6ES	BCPR6EIX-11	4919
D8EA	DR8EIX	6681	BPR8ES	BPR8EIX	6684
DR7EA	DR7EIX	5686	BCPR6ET	BKR6EIX	6418
BP6HS	BPR6HIX	4085	CR7EK	CR7EIX	7385

Iridium 		Standard 	
Iridium	Standard		
BCPR6EIX-11	BCPR6ES		
BKR5EIX	BKR5E		
BKR5EIX-11	BKR5E-11		
BKR6EIX	BKR6E, BKR6ES, BKR6EKC, BCPR6ET		
BKR7EIX	BKR7E		
BPR5EIX	BPR5ES, BP5ES		
BPR5EIX-11	BPR5ES-11		
BPR6EIX	BPR6ES, BP6ES		
BPR6HIX	BP6HS, BPR6HS, BR6HSA, BPR6HSA, BP6HSA		
BPR7EIX	BPR7ES, BP7ES		
BPR7HIX	BP7HS, BPR7HS		
BPR8EIX	BP8ES, BPR8ES		
BPR8HIX	BR8HSA, BPR8HS, BP8HS		
BPR9EIX	BPR9ES		
BR10EIX	B10ES, BR10ES		
BR6HIX	BR6HS, B6HS		
BR7EIX	B7ES, BR7ES		
BR7HIX	B7HS, BR7HS		
BR8ECMIX	BR8ECM		
BR8EIX	B8ES, BR8ES		
BR8HIX	B8HS, BR8HS		
BR9ECMIX	BR9ECM		
BR9EIX	BR9ES, BR9EYA, B9ES		
BR9HIX	B9HS, BR9HS		
CPR7EAIX-9	CPR7EA-9		
CR6HIX	CR6HSA, C6HSA		
CR7EIX	CR7E, C7E, CR7EK		
CR7HIX	CR7HSA, CR7HS, C7HSA, CR7HSA-9		
CR8EHIX-9	CR8EH-9, C8EH-9		
CR8EIX	CR8E, CR8EB, CR8EK, C8E		
CR8HIX	CR8HSA, CR8HS		
CR9EHIX-9	CR9EH-9		
CR9EIX	CR9E, CR9EKB, CR9EB, CR9EK		
DCPR6EIX	DCPR6E		
DCPR7EIX	DCPR7E		
DCPR8EIX	DCPR8E		
DPR7EIX-9	DPR7EA-9, DP7EA-9		
DPR8EIX-9	DPR8EA-9, DP8EA-9		
DPR9EIX-9	DPR9EA-9, DP9EA-9		
DR7EIX	D7EA, DR7EA, DR7ES		
DR8EIX	DR8EA, DR8ES-L, D8EA, DR8ES		
DR9EIX	DR9EA, D9EA		
ER8EHIX	ER8EH-N, ER9EH		

GB

This catalogue supersedes all previous catalogs. NGK Spark Plug Europe GmbH has made its best effort to ensure an accurate information, based on information available at the time of the compilation of the catalog. This catalog is made for information only. NGK Spark Plug Europe GmbH will not accept liability for any inaccuracy. Product linkage to vehicles or tools applications from this publication are considered under normal condition of use, fitted by a professional and for vehicles registered in Europe. For all different usage or post equipment, the responsibility of NGK cannot be engaged. All ordered products are subject to valid terms and conditions supplied by NGK Spark Plug Europe GmbH. Pictures, diagrams and drawings in this publication are not contractual. The property of the pictures, diagrams, drawings and other graphic elements and data belong to NGK Spark Plug Europe GmbH exclusively. Reproduction of this publication, partial or total, is strictly prohibited without a prior written authorization of NGK Spark Plug Europe GmbH.

D

Mit Veröffentlichung dieser Ausgabe verlieren alle vorhergehenden Ausgaben ihre Gültigkeit. Dieser Katalog wurde, basierend auf den zum Zeitpunkt der Erstellung des Katalogs verfügbaren Informationen, von der NGK Spark Plug Europe GmbH nach bestmöglichem Wissen erstellt. Dieser Katalog dient ausschließlich zu Informationszwecken. Die NGK Spark Plug Europe GmbH übernimmt keine Haftung für Druckfehler, Irrtümer oder sonstige fehlerhafte Informationen. Alle in diesem Katalog erwähnten Produkt-Zuordnungen zu Fahrzeugen oder Werkzeugen gelten für einen Einsatz unter normalen Bedingungen, den Einbau durch einen Fachmann sowie Fahrzeuge, die innerhalb der EU zugelassen sind. Die NGK Spark Plug Europe GmbH kann nicht für andere Nutzungszwecke oder Nachrüstungen jedweder Art haftbar gemacht werden. Alle bestellten Produkte unterliegen den geltenden Geschäftsbedingungen der NGK Spark Plug Europe GmbH. Die in diesem Katalog abgebildeten Bilder, Diagramme und Zeichnungen sind nicht Vertragsbestandteil. Alle Bilder, Diagramme, Zeichnungen sowie andere graphische Elemente und Daten sind exklusives Eigentum der NGK Spark Plug Europe GmbH. Jedwede Vervielfältigung dieses Katalogs, auch auszugsweise, ohne vorherige schriftliche Genehmigung durch die NGK Spark Plug Europe GmbH ist strengstens untersagt.

F

Ce catalogue remplace tous les catalogues précédents. NGK Spark Plug Europe GmbH a réalisé tous les efforts nécessaires pour assurer l'exactitude des informations sur la base des informations disponibles au moment de la compilation du catalogue. Ce catalogue a été élaboré à titre informatif uniquement. NGK Spark Plug Europe GmbH n'acceptera aucune responsabilité en cas d'inexactitude. Les liens de produits avec des véhicules ou des outils dans cette publication sont considérés dans des conditions normales d'utilisation, installés par un professionnel et pour les véhicules immatriculés en Europe. Pour toute utilisation différente ou équipement de conversion, la responsabilité de NGK ne peut pas être engagée. Tous les produits commandés sont soumis à des termes et conditions valides fournis par NGK Spark Plug Europe GmbH. Les images, diagrammes et dessins de cette publication ne sont pas contractuels. Les images, les diagrammes, les dessins et autres éléments graphiques et données appartiennent à NGK Spark Plug Europe GmbH exclusivement. La reproduction de cette publication, partielle ou totale, est strictement interdite sans autorisation écrite préalable de NGK Spark Plug Europe GmbH.

I

Il presente catalogo sostituisce tutti i precedenti. NGK Spark Plug Europe GmbH ha posto la massima attenzione per offrire informazioni accurate, basate sui dati disponibili al momento della compilazione del catalogo. Il presente catalogo ha esclusivamente scopo informativo. NGK Spark Plug Europe GmbH non si assume nessuna responsabilità per eventuali imprecisioni. Si considera che i veicoli a cui si riferisce questa pubblicazione si trovino in condizioni di utilizzo normali, siano stati montati da un professionista e su veicoli immatricolati in Europa. Per qualsiasi utilizzo o per attrezzature montate successivamente, NGK non si assume nessuna responsabilità. Tutti i prodotti ordinati sono soggetti ai termini e alle condizioni forniti da NGK Spark Plug Europe GmbH. Le immagini, i grafici e i disegni presenti in questa pubblicazione non sono contrattuali. Le immagini, dei grafici, i disegni e gli altri elementi e dati sono di proprietà esclusiva di NGK Spark Plug Europe GmbH. La riproduzione della presente pubblicazione, parziale o totale, è strettamente proibita senza la preventiva autorizzazione scritta di NGK Spark Plug Europe GmbH.

E

Este catálogo reemplaza a todos los catálogos anteriores. NGK Spark Plug Europe GmbH ha hecho todo lo posible para garantizar que la información sea correcta, basándose en la información disponible en el momento de la redacción del catálogo.

Este catálogo se ha hecho con propósitos meramente informativos. NGK Spark Plug Europe GmbH no acepta ninguna responsabilidad por los posibles errores. Se considera que la utilización de los productos en vehículos o aplicaciones de herramientas de esta publicación se realiza en condiciones de uso normales, montados por un profesional y en vehículos matriculados en Europa. Para todos los otros usos o equipamiento a posteriori, NGK no puede considerarse responsable. Todos los productos pedidos están sujetos a los términos y condiciones válidos de NGK Spark Plug Europe GmbH. Las imágenes, los diagramas y los dibujos de esta publicación no tienen valor contractual. Las imágenes, los diagramas, los dibujos, los otros elementos gráficos y los datos son propiedad exclusiva de NGK Spark Plug Europe GmbH. La reproducción total o parcial de esta publicación está estrictamente prohibida sin una autorización previa por escrito de NGK Spark Plug Europe GmbH.

NL

Deze catalogus vervangt alle eerdere catalogi. NGK Spark Plug Europe GmbH heeft alles in het werk gesteld om voor nauwkeurige informatie te zorgen, op basis van de informatie die voorhanden was op het moment dat de catalogus werd samengesteld. Deze catalogus dient slechts ter informatie. NGK Spark Plug Europe GmbH aanvaardt geen aansprakelijkheid voor eventuele onnauwkeurigheden. Producten die in verband worden gebracht met voertuigen of gereedschaptoepassingen van deze publicatie worden beschouwd onder normale gebruiksomstandigheden, geïnstalleerd door een professional en voor voertuigen die in Europa zijn geregistreerd. Voor alle andere gebruik of retrofitting aanvaardt NGK geen aansprakelijkheid. Alle bestelde producten vallen onder de geldige algemene voorwaarden van NGK Spark Plug Europe GmbH. Afbeeldingen, schema's en tekeningen in deze publicatie zijn niet bindend. Afbeeldingen, schema's, tekeningen en andere grafische elementen en gegevens zijn exclusief eigendom van NGK Spark Plug Europe GmbH. Gedeeltelijke of volledige reproductie van deze publicatie is ten strengste verboden zonder schriftelijke toestemming vooraf van NGK Spark Plug Europe GmbH.

P

Este catálogo substitui todos os catálogos anteriores. NGK Spark Plug Europe GmbH emvidou os seus melhores esforços para assegurar uma informação precisa, com base nas informações disponíveis no momento da compilação do catálogo. Este catálogo é elaborado apenas para efeitos informativos. NGK Spark Plug Europe GmbH não aceita qualquer responsabilidade por qualquer imprecisão. A ligação do produto a aplicações de veículos ou ferramentas desta publicação é considerada sob condições normais de uso, montado por um profissional e para veículos matriculados na Europa. Para todos os usos diferentes ou pós-equipamento, a responsabilidade de NGK não pode se comprometer. Todos os produtos encomendados estão sujeitos a termos e condições válidos fornecidos pela NGK Spark Plug Europe GmbH. As fotos, diagramas e desenhos nesta publicação não são contratuais. A propriedade das fotos, diagramas, desenhos e outros elementos gráficos e dados pertencem exclusivamente a NGK Spark Plug Europe GmbH. A reprodução desta publicação, parcial ou integral, é estritamente proibida sem uma autorização prévia por escrito da NGK Spark Plug Europe GmbH.

GR

Αυτός ο κατάλογος αντικαθιστά όλους τους προηγούμενους καταλόγους. Η NGK Spark Plug Europe GmbH έχει κάνει κάθε δυνατή προσπάθεια για να εξασφαλίζεται η ακριβής πληροφόρηση, βάσει των διαθέσιμων πληροφοριών κατά το χρόνο της κατάρτισης του καταλόγου. Αυτός ο κατάλογος έχει στόχο μόνο την πληροφόρηση. Η NGK Spark Plug Europe GmbH δεν αναλαμβάνει καμία ευθύνη για οποιαδήποτε ανακρίβεια. Η σύνδεση του προϊόντος σε οχήματα ή εφαρμογές εργαλείων του παρόντος καταλόγου θεωρείται ότι γίνονται υπό κανονικές συνθήκες χρήσης, με εγκατάσταση από επαγγελματία και για τα οχήματα που έχουν ταξινομηθεί στην Ευρώπη. Για όλες τις άλλες περιπτώσεις διαφορετικής χρήσης ή προσθήκης εξοπλισμού, δεν φέρει ευθύνη η NGK. Όλα τα παραγγελθέντα προϊόντα υπόκεινται σε έγκυρους όρους και προϋποθέσεις που παρέχονται από την NGK Spark Plug Europe GmbH. Εικόνες, διαγράμματα και σχέδια σε αυτήν την έκδοση δεν αποτελούν μέρος σύμβασης. Οι εικόνες, διαγράμματα, σχέδια και άλλα γραφικά στοιχεία και δεδομένα αποτελούν αποκλειστική ιδιοκτησία της NGK Spark Plug Europe GmbH. Απαγορεύεται αυστηρά η ολική ή μερική αναπαραγωγή της δημοσίευσης χωρίς την προηγούμενη γραπτή άδεια της Spark Plug NGK Europe GmbH.

TR

Bu katalog önceki tüm katalogların yerini alır. NGK Spark Plug Europe GmbH, bu katalogun hazırlanma aşamasında mevcut olan bilgilere dayanarak doğru bilgiler vermek için elinden geleni yapmıştır. Bu katalog yalnızca bilgi amaçlı hazırlanmıştır. NGK Spark Plug Europe GmbH, herhangi bir hata için sorumluluk kabul etmez. Bu yayındaki taşıt ve araç uygulamalarına atıfta bulunan ürün bağlantıları verilirken normal kullanım koşulları, bir uzmanca takılmış olması göz önünde bulundurulmuştur ve Avrupa'da tescillenmiş taşıtlar içindir. Farklı herhangi bir kullanım veya sonradan takılan ekipmanlar için NGK sorumlu tutulamaz. Sipariş edilen tüm ürünler, NGK Spark Plug Europe GmbH tarafından sağlanan geçerli şartlara ve koşullara tabidir. Bu yayındaki resimler, şemalar ve çizimler taahhüt değildir. Resimlerin, çizimlerin ve diğer grafik öğelerin mülkiyeti yalnızca NGK Spark Plug Europe GmbH'ye aittir. Bu yayının NGK Spark Plug Europe GmbH'den önceden yazılı izin almadan kısmi veya tam olarak yeniden çoğaltılması kesinlikle yasaktır.

PL

Niniejszy katalog zastępuje wszystkie poprzednie katalogi. Firma NGK Spark Plug Europe GmbH dołożyła najlepszych starań, aby upewnić się, że katalog zawiera precyzyjne informacje opierające się na danych dostępnych w czasie opracowania katalogu. Niniejszy katalog ma charakter wyłącznie informacyjny. Firma NGK Spark Plug Europe GmbH nie ponosi żadnej odpowiedzialności za jakiegokolwiek nieprecyzyjne dane. Przystosowanie produktów do pojazdów lub narzędzi wymienionych w niniejszej publikacji zakłada normalne warunki stosowania, montaż przez profesjonalistów oraz pojazdy zarejestrowane w Europie. Firma NGK nie ponosi żadnej odpowiedzialności za jakiegokolwiek przypadki innych zastosowań lub stosowanie w sprzęcie innego rodzaju. Wszystkie zamówione produkty podlegają odpowiednim warunkom i postanowieniom określonym przez firmę NGK Spark Plug Europe GmbH. Ilustracje, schematy i rysunki zawarte w niniejszej publikacji nie mają mocy umownej. Ilustracje, schematy, rysunki i inne elementy graficzne oraz dane należą wyłącznie do firmy NGK Spark Plug Europe GmbH. Reprodukacja niniejszej publikacji w części lub w całości jest surowo zabroniona bez uzyskania wcześniejszego pisemnego upoważnienia ze strony firmy NGK Spark Plug Europe GmbH.

CZ

Tento katalog nahrazuje všechny předchozí katalogy. NGK Spark Plug Europe GmbH vyvinul co největší úsilí, aby poskytl nejpřesnější informace, založených na informacích dostupných v okamžiku sestavení katalogu. Tento katalog je jen pro informační účely. NGK Spark Plug Europe GmbH nepřebírá žádnou zodpovědnost na případné nepřesnosti. Propojení jednotlivých produktů s vozidly nebo použití s náradím z této publikace se počítají za normálních podmínek užívání, nastavených odborníky pro vozidla registrovaná v Evropě. NGK se nezavazuje k odpovědnosti za jiné užití nebo pro následné vybavení. Všechny objednaných výrobků se týkají platné podmínky a dohody dodávek NGK Spark Plug Europe GmbH. Obrázky, diagramy a kresby v této publikaci nejsou závazné. Vlastnictví obrázků, diagramů, kreseb a dalších grafických prvků a dat jsou výhradním majetkem NGK Spark Plug Europe GmbH. Jakákoliv reprodukce této publikace, ať části nebo v celku je přísně zakázána bez písemné autorizace NGK Spark Plug Europe GmbH.

H

Ez a katalógus hatályon kívül helyez minden korábbi katalógust. NGK Spark Plug Europe GmbH mindent megtett annak érdekében, hogy a katalógus összeállításakor rendelkezésre álló információkon alapuló pontos tájékoztatást biztosítson. Ez a katalógus csak tájékoztató jellegű. NGK Spark Plug Europe GmbH nem vállal felelősséget az esetleges pontatlanságokért. A jelen katalógusban szereplő járműhöz kapcsolódó elemek, vagy alkalmazási eszközök használatára szokásos alkalmazási feltételek mellett értendő, és azokat szakembernek kell az Európában bejegyzett járművekbe szerelni. Minden ettől eltérő használatért, vagy utólagos beszerelésért az NGK semmiféle felelősséget nem vállal. Valamennyi megrendelt termékre az NGK Spark Plug Europe GmbH által meghatározott feltételek vonatkoznak. A kiadványban szereplő ábrák, diagramok és rajzok nem szerződéses jellegűek. A kiadványban szereplő ábrák, diagramok, rajzok és egyéb grafikus elemek és adatok kizárólag az NGK Spark Plug Europe GmbH tulajdonát képezik. A kiadvány részleges vagy teljes reprodukciója kizárólag az NGK Spark Plug Europe GmbH előzetes és írásos engedélyezésével történhet.

RUS

Данный каталог заменяет все ранее изданные каталоги. Компания NGK Spark Plug Europe GmbH предприняла все возможные усилия, чтобы обеспечить точность данных, подготовленных на основе доступной на момент составления каталога информации.

Данный каталог предназначен только для информационных целей. NGK Spark Plug Europe GmbH не несет ответственность за какие-либо неточности. Примеры установки продуктов в транспортные средства или использования инструментов в данном издании рассматриваются для случаев нормального режима эксплуатации, профессионального монтажа и транспортных средств, зарегистрированных в Европе. При любых других условиях ответственность за последствия использования оборудования NGK не несет. На все заказанные продукты распространяются действующие условия и положения NGK Spark Plug Europe GmbH. Изображения, графики и рисунки в данном издании не являются договорными. Права на изображения, графики, рисунки и прочие графические элементы и данные принадлежат исключительно NGK Spark Plug Europe GmbH. Воспроизведение данного издания, частично или полностью, строго запрещается без предварительного письменного разрешения NGK Spark Plug Europe GmbH.

C
Y
L

0201



Stock-№

Quick-№



Stock-№ IX

A.J.S

Chipmunk 50	50		2003-	0,6	BP4HS	3611	-	-	-
DD50 Regal Raptor	50		2003-	0,7	CR7HS	7223	-	CR7HIX	7544
JSM 50 Motard	50		2011-	0,6	BR8ES	5422	Q207	BR8EIX	5044
Coyote 80	80		2003-	0,6	BP6HS	4511	-	BPR6HIX	4085
Cougar 100 (Jincheng)	100		2003-	0,6	BP7HS	5111	-	BPR7HIX	5944
DD100 Regal Raptor	100		2003-	0,7	CR7HS	7223	-	CR7HIX	7544
CR3-125 Super Sports	125		-	0,6	DR8EA	7162	-	DR8EIX	6681
JS125Y Tiger	125		2003-	0,7	DR8ES	5423	Q217	DR8EIX	6681
JSM125 Motard	125		-	0,6	CR6HSA	2983	-	CR6HIX	7274
JSM125 Trail	125		-	0,6	CR6HSA	2983	-	CR6HIX	7274

ADLY

Citybird, Crosser, Fox, Jet, X1, Pista, Predator	50		1997-	0,6	BPR7HS	6422	Q215	BPR7HIX	5944
Cat, Predator, Jet, X1	100		1997-	0,6	BPR7HS	6422	Q215	BPR7HIX	5944
Activator 125	125		1999-	0,5	CR7HSA	4549	-	CR7HIX	7544
AJP 125 PR4	125		2003-	0,9	DPR7EA-9	5129	Q220	DPR7EIX-9	7803
Cat 125	125		1997-	0,5	CR7HSA	4549	-	CR7HIX	7544

AJP

Enduro	125	1	2003-	0,8	DR8ES	5423	Q217	DR8EIX	6681
PR3	125		-	*	-	-	-	DR8EIX	6681
PR4 Limited Edition	125		2011-	*	-	-	-	DR8EIX	6681
Supermoto	125	1	2003-	0,8	DR8ES	5423	Q217	DR8EIX	6681
Enduro	200	1	2003-	0,8	DR8ES	5423	Q217	DR8EIX	6681
PR4 Limited Edition	200		2011-	*	-	-	-	DR8EIX	6681
SM-PR3	200		-	*	-	-	-	DR8EIX	6681
SM-PR4	200		2011-	*	-	-	-	DR8EIX	6681
SM-PR4 Pro	200		2011-	*	-	-	-	DR8EIX	6681
Supermoto	200	1	2003-	0,8	DR8ES	5423	Q217	DR8EIX	6681
P 250 Cross	250	1	2004-	0,6	CR8EB	7784	-	CR8EIX	4218
PR5 SuperMoto	250		-	*	-	-	-	DR8EIX	6681

ALFER

GR 30, TX 30	50	1	-	0,6	BR8HS	4322	Q212	BR8HIX	7001
MC	80	1	-	0,5	B9EGV	5827	-	-	-
GR-ISDE	125	1	-	0,5	B8EGV	5627	-	-	-
MC	125	1	-	0,5	B9EGV	5827	-	-	-
Trail	125	1	2000-	0,7	CR9EB	6955	-	CR9EIX	3521
VRE-4 Stroke	125	1	-	0,7	CR9E	6263	Q227	CR9EIX	3521
VRE-No Limit 4 temps	125	1	-	0,7	CR9E	6263	Q227	CR9EIX	3521
EGR-Agua / Air	250	1	-	0,5	B8ES	2411	Q201	BR8EIX	5044
MC	250	1	-	0,5	B9EGV	5827	-	-	-
VR-Enduro	250	1	2000-	0,6	BR8ES	5422	Q207	BR8EIX	5044
VR-Super Motard	250	1	2000-	0,6	BR8ES	5422	Q207	BR8EIX	5044
AR-1	300	1	-	0,5	B8ES	2411	Q201	BR8EIX	5044
GR-Agua	300	1	-	0,5	B8ES	2411	Q201	BR8EIX	5044
TX	300	1	-	0,5	B8ES	2411	Q201	BR8EIX	5044
MC-500	490	1	-	0,5	B9EGV	5827	-	-	-

* Bitte Elektrodenabstand nach Angaben des Herstellers justieren

* Please adjust the groundelectrode gap

* Veuillez vérifier l' écartement

* Por favor, ajustar distancia entre electrodos

* regolare il gap

C
y
l

0201



Stock-Nr

Quick-Nr



Stock-Nr IX

APRILIA

Amico 25	25	1	1996-	0,5	BR7HS	4122	Q211	BR7HIX	7067
AF1 (RV3-4 & AM3 Eng.)	50	1	1986-1993	0,5	B9ES	2611	Q202	BR9EIX	3981
Amico 50	50	1	1990-2001	0,5	BR7HS	4122	Q211	BR7HIX	7067
Area 51 Superbike, Tetsuya	50	1	1999-2003	0,5	BR8HS	4322	Q212	BR8HIX	7001
Classic (Eng: AM3/5 H2O AUTOMIX)	50	1	1995-1997	0,5	B9ES	2611	Q202	BR9EIX	3981
Classic (Eng: AM5 H2O AUTOMIX)	50	1	1997-2002	0,5	BR8ES	5422	Q207	BR8EIX	5044
Extrema 50	50	1	1993-	0,5	B8ES	2411	Q201	BR8EIX	5044
Gulliver AC	50	1	1995-2001	0,5	BR7HS	4122	Q211	BR7HIX	7067
Gulliver LC	50	1	1996-2001	0,5	BR8HS	4322	Q212	BR8HIX	7001
Habana	50	1	1999-2002	0,6	BPR8HS	3725	-	BPR8HIX	6742
Mojito Custom 50	50	1	2002-2003	0,6	BPR8HS	3725	-	BPR8HIX	6742
Mojito Custom 50	50	1	2005-	0,7	BR9ES	5722	Q208	BR9EIX	3981
Mojito Custom 50 (Piaggio Eng)	50	1	2004-	0,6	BR10ES	4832	-	BR10EIX	6801
MX-(Eng: AM6)	50	1	2002-2004	0,7	BR9ES	5722	Q208	BR9EIX	3981
Quasar	50	1	2002-2003	0,7	BPR7HS	6422	Q215	BPR7HIX	5944
Rally	50	1	1987-1990	0,5	B9ES	2611	Q202	BR9EIX	3981
Rally AC	50	1	1995-2003	0,5	BR7HS	4122	Q211	BR7HIX	7067
Rally LC	50	1	1997-2003	0,5	BR8HS	4322	Q212	BR8HIX	7001
RC	50	1	1979-1982	0,6	B6ES	7310	-	-	-
Red Rose (Eng: RV3)	50	1	1987-1991	0,5	B9ES	2611	Q202	BR9EIX	3981
Red Rose 50 (Eng: AM3 H2O AUTOMIX)	50	1	1992-1994	0,5	B8ES	2411	Q201	BR8EIX	5044
RS-(Eng: AM5 H2O AUTOMIX)	50	1	1993-1996	0,5	B8ES	2411	Q201	BR8EIX	5044
RS-(Eng: AM6)	50	1	1997-2005	0,8	BR8ES	5422	Q207	BR8EIX	5044
RS-(Eng: Piaggio)	50	1	2006-	0,6	BR9ES	5722	Q208	BR9EIX	3981
RS4	50	1	2011-	0,8	BR8ES	5422	Q207	BR8EIX	5044
RX-(Eng: AM3) / (Eng. AM5)	50	1	1988-1996	0,5	B9ES	2611	Q202	BR9EIX	3981
RX-(Eng: AM6)	50	1	1997-2005	0,5	BR8ES	5422	Q207	BR8EIX	5044
RX-(Eng: Minarelli)	50	1	2003-2004	0,6	BR9ES	5722	Q208	BR9EIX	3981
RX-(Eng: Piaggio)	50	1	2006-2006	0,6	BR9ES	5722	Q208	BR9EIX	3981
Scarabeo 50 2 Stroke	50	1	1993-2005	0,5	BR7HS	4122	Q211	BR7HIX	7067
Scarabeo 50 2 Stroke (Eng. C421M)	50	1	2004-2006	0,6	BR9ES	5722	Q208	BR9EIX	3981
Scarabeo 50 4 Stroke	50	1	2001-2003	0,7	CR8EB	7784	-	CR8EIX	4218
Scarabeo 50 4 Stroke	50	1	2004-2006	0,7	CR9EB	6955	-	CR9EIX	3521
Scarabeo 50 4 Stroke (Eng: C376M)	50	1	2006-	0,7	PMR7A	4259	-	-	-
Scarabeo 50 Di Tech (Injection)	50	1	2000-2004	0,8	CPR8E	7411	-	-	-
Scarabeo 50 ie	50	1	2001-2003	0,6	CPR8E	7411	-	-	-
Scarabeo 50 Street 2 Stroke	50	1	2005-	0,8	BR9ES	5722	Q208	BR9EIX	3981
Sonic 50 AC	50	1	1998-2003	0,5	BR7HS	4122	Q211	BR7HIX	7067
Sonic 50 Euro 2	50	1	2003-	0,6	BR8HS	4322	Q212	BR8HIX	7001
Sonic 50 LC	50	1	1998-2003	0,6	BR8HS	4322	Q212	BR8HIX	7001
Sonic FT 50 2 Stroke (Ref. Air)	50	1	1998-2001	0,5	BR8HS	4322	Q212	BR8HIX	7001
Sonic GP 50 2 Stroke (Ref. Liquid)	50	1	1998-2005	0,5	BR8HS	4322	Q212	BR8HIX	7001
Sportcity One 50 2 Stroke Street	50	1	2008-	0,6	BR9ES	5722	Q208	BR9EIX	3981
Sportcity One 50 4 Stroke	50	1	2008-	0,7	PMR7A	4259	-	-	-
SR	50	1	1992-1995	0,5	BR7HS	4122	Q211	BR7HIX	7067
SR- Replica SBK	50	1	2008-	0,6	BR9ES	5722	Q208	BR9EIX	3981
SR-Carb	50	1	2004-	0,6	BR9ES	5722	Q208	BR9EIX	3981
SR-Di Tech (ref. liquid)	50	1	2000-2005	0,6	CPR8E	7411	-	-	-
SR-Di Tech (ref. liquid)	50	1	2006-	0,6	ZMR7AP	6914	-	-	-
SR-Engine Aprilia L02 (ref. liquid)	50	1	2000-2003	0,6	BPR8HS	3725	-	BPR8HIX	6742
SR-Engine Minarelli ref. air	50	1	1993-2001	0,5	BR7HS	4122	Q211	BR7HIX	7067
SR-Engine Minarelli ref. Liquid	50	1	1994-2001	0,6	BR8HS	4322	Q212	BR8HIX	7001

* Bitte Elektrodenabstand nach Angaben des Herstellers justieren

* Please adjust the groundelectrode gap

* Veuillez vérifier L' écartement

* Por favor, ajustar distancia entre electrodos

* regolare il gap

C
Y
L

Stock-No

Quick-No



Stock-No IX

APRILIA

SR-Factory Replica SBK (Eng: Piaggio Pure jet)	50	1	2008-	0,6	CPR8E	7411	-	-	-
SR-i.e. Factory (Eng: Piaggio pure jet)	50	1	2005-	0,6	CPR8E	7411	-	-	-
SR-LC	50	1	1996-	0,7	BR7HS	4122	Q211	BR7HIX	7067
SR-Motard	50	1	2012-	*	BR8ES	5422	Q207	BR8EIX	5044
SR-Motard 50 2 Stroke	50	1	2012-	0,5	BR9ES	5722	Q208	BR9EIX	3981
SR-R (Eng: Piaggio)	50	1	2004-	0,8	BR9ES	5722	Q208	BR9EIX	3981
SR-Racing	50	1	1996-	0,7	BR7HS	4122	Q211	BR7HIX	7067
SR-Racing & Sport (ref. liquid)	50	1	2000-	0,7	BPR7HS	6422	Q215	BPR7HIX	5944
SR-Ref.liquid - other models	50	1	1996-1999	0,6	BR8HS	4322	Q212	BR8HIX	7001
SR-Stealth	50	1	1996-	0,7	BR7HS	4122	Q211	BR7HIX	7067
SR-Street (Eng: Piaggio)	50	1	2004-	0,8	BR9ES	5722	Q208	BR9EIX	3981
SR-WWW	50	1	2001-2002	0,6	BR7HS	4122	Q211	BR7HIX	7067
SX	50	1	2006-	0,6	BR9ES	5722	Q208	BR9EIX	3981
SX-Eng. Piaggio	50	1	2008-	0,6	BR9ES	5722	Q208	BR9EIX	3981
Tuareg	50	1	1987-1990	0,5	B9ES	2611	Q202	BR9EIX	3981
Tuono (Eng: AM6)	50	1	2003-2004	0,6	BR9ES	5722	Q208	BR9EIX	3981
Wind	50	1	1987-1990	0,5	B9ES	2611	Q202	BR9EIX	3981
Quasar	100	1	2002-2003	0,7	BPR7HS	6422	Q215	BPR7HIX	5944
Scarabeo 2 Stroke	100	1	2000-2002	0,6	BR8HS	4322	Q212	BR8HIX	7001
Scarabeo 4 Stroke	100	1	2000-	0,7	CR9EB	6955	-	CR9EIX	3521
AF1-Futura	125	1	1990-1992	0,5	BR10EG	3830	-	-	-
AF1-Futura SP	125	1	1990-1992	0,5	BR10EG	3830	-	-	-
AF1-Replica	125	1	1988-1990	0,5	B10EG	3630	-	-	-
AF1-Replica	125	1	1990-1992	0,5	BR10EG	3830	-	-	-
AF1-Rotax Engine 127V	125	1	1987-1988	0,5	B10EG	3630	-	-	-
AF1-Sintesi	125	1	1988-1990	0,5	B10EG	3630	-	-	-
AF1-Sport	125	1	1988-1990	0,5	B10EG	3630	-	-	-
AS-R	125	1	1985-1987	0,5	B9ES	2611	Q202	BR9EIX	3981
Atlantic	125	1	2003-	0,7	CR8EB	7784	-	CR8EIX	4218
Classic (15ch)	125	1	1996-2002	0,5	BR8ES	5422	Q207	BR8EIX	5044
Classic (Full Power)	125	1	1996-2002	0,5	BR10EG	3830	-	-	-
ETX	125	1	1984-1998	0,5	B9ES	2611	Q202	BR9EIX	3981
ETX-15 ch	125	1	1998-	0,5	BR8ES	5422	Q207	BR8EIX	5044
ETX-Full Power	125	1	1998-	0,5	BR10EG	3830	-	-	-
ETX-Rotax Engine	125	1	1999-2002	0,8	BR8ES	5422	Q207	BR8EIX	5044
Europa	125	1	1990-1991	0,5	B10EG	3630	-	-	-
Europa, Extrema	125	1	-	0,5	BR10EG	3830	-	-	-
Habana & Custom	125	1	1999-2001	0,6	CR8E	1275	Q226	CR8EIX	4218
Leonardo 125	125	1	1995-2001	0,6	CR8E	1275	Q226	CR8EIX	4218
Leonardo 125 ST	125	1	1996-	0,6	CR8E	1275	Q226	CR8EIX	4218
Leonardo 125 ST	125	1	2002-2006	0,6	CR8EB	7784	-	CR8EIX	4218
Mojito	125	1	2002-2004	0,6	CR8E	1275	Q226	CR8EIX	4218
Mojito Custom	125	1	2002-	0,8	CR7EB	4663	-	CR7EIX	7385
Mojito Custom	125	1	2005-	0,7	CR9E	6263	Q227	CR9EIX	3521
MX	125	1	2003-2006	0,8	BR8ES	5422	Q207	BR8EIX	5044
Pegaso	125	1	-	0,5	BR10EG	3830	-	-	-
Quasar	125	1	2002-2003	0,7	CR8HSA	2086	-	CR8HIX	7669
Rally 125	125	1	1989-1990	0,5	B10EG	3630	-	-	-
Red Rose	125	1	1988-	0,5	BR10EG	3830	-	-	-
RS-15 ch	125	1	1996-	0,5	BR8ES	5422	Q207	BR8EIX	5044
RS4	125	1	2011-	0,5	CR9EB	6955	-	CR9EIX	3521
RS-Extrema	125	1	1993-	0,5	BR10EG	3830	-	-	-

* Bitte Elektrodenabstand nach Angaben des Herstellers justieren

* Please adjust the groundelectrode gap

* Veuillez vérifier L' écartement

* Por favor, ajustar distancia entre electrodos

* regolare il gap

C
y
l

0201



Stock-№

Quick-№



Stock-№ IX

APRILIA

RS-Full Power	125	1	1996-	0,5	BR10EG	3830	-	-	-
RS-other models	125	1	1992-1997	0,5	BR10EG	3830	-	-	-
RS-R Extrema 12 ch	125	1	1993-	0,5	BR8ES	5422	Q207	BR8EIX	5044
RS-Replica	125	1	1993-	0,5	BR10EG	3830	-	-	-
RS-Tuono	125	1	2003-2004	0,6	BR8ES	5422	Q207	BR8EIX	5044
RX	125	1	1990-2002	0,5	B10EG	3630	-	-	-
RX-15 ch	125	1	2008-	0,5	BR8ES	5422	Q207	BR8EIX	5044
RX-Full Power	125	1	2008-	0,5	BR10EG	3830	-	-	-
Scarabeo	125	1	1999-2009	0,6	CR8EB	7784	-	CR8EIX	4218
Scarabeo 125 i.e	125	1	2009-	0,7	PMR9B	4717	-	-	-
Scarabeo GT	125	1	1999-	0,6	CR8E	1275	Q226	CR8EIX	4218
Scarabeo Light	125	1	1999-	0,6	CR8E	1275	Q226	CR8EIX	4218
Scarabeo Street	125	1	2006-	0,7	CR9EB	6955	-	CR9EIX	3521
Sport City 125	125	1	2004-2008	0,6	CR8E	1275	Q226	CR8EIX	4218
Sport City Cube	125	1	2008-	0,8	CR8EB	7784	-	CR8EIX	4218
Sport City One	125	1	2008-	0,8	CR7EB	4663	-	CR7EIX	7385
Sport Pro 125	125		-	0,5	BR10EG	3830	-	-	-
SR	125	1	1999-2002	0,5	BR8ES	5422	Q207	BR8EIX	5044
SR-MAX	125	1	2011-	0,7	CR8EKB	4374	-	CR8EIX	4218
SR-Motard	125	1	2012-	0,7	CR7EB	4663	-	CR7EIX	7385
ST	125	1	1982-1984	0,5	B9EG	3530	-	-	-
STX	125	1	1984-1985	0,5	B9EG	3530	-	-	-
SX-15 ch	125	1	2008-	0,5	BR8ES	5422	Q207	BR8EIX	5044
SX-Full Power 34.6ch	125	1	2008-	0,7	BR10EG	3830	-	-	-
Touareg	125	1	1986-1987	0,5	B9ES	2611	Q202	BR9EIX	3981
Touareg Rallye	125	1	1990-1994	0,5	B10EG	3630	-	-	-
Touareg Wind	125	1	1987-1989	0,5	B9ES	2611	Q202	BR9EIX	3981
Tuono 15 ch	125	1	2003-2004	0,8	BR8ES	5422	Q207	BR8EIX	5044
Leonardo	150	1	1995-2001	0,6	CR8E	1275	Q226	CR8EIX	4218
Leonardo 150 ST	150		2002-2006	0,8	CR8EB	7784	-	CR8EIX	4218
Mojito 150	150	1	2002-2006	0,7	CR7EB	4663	-	CR7EIX	7385
Scarabeo 150 (4-Stroke)	150		1999-2003	0,6	CR8E	1275	Q226	CR8EIX	4218
SR	150	1	1999-2002	0,6	BR9ES	5722	Q208	BR9EIX	3981
Quasar	180	1	2002-2004	0,7	CR8HSA	2086	-	CR8HIX	7669
Atlantic	200	1	2002-2005	0,7	CR8EB	7784	-	CR8EIX	4218
Scarabeo	200	1	2000-2009	0,8	CR8EB	7784	-	CR8EIX	4218
Scarabeo i.e.	200	1	2009-	0,7	PMR9B	4717	-	-	-
Scarabeo Street	200	1	2006-	0,7	CR9EB	6955	-	CR9EIX	3521
Sportcity 200	200	1	2004-2008	0,6	CR7EB	4663	-	CR7EIX	7385
Sportcity 200	200	1	2008-	0,8	CR8EB	7784	-	CR8EIX	4218
Atlantic 250	250	1	2004-2006	0,7	CR8EB	7784	-	CR8EIX	4218
Atlantic 250 i.e.	250	1	2004-2009	0,7	PMR8B	6378	-	-	-
Leonardo	250	1	1999-	0,6	DR8EA	7162	-	DR8EIX	6681
RS	250	1	1995-2003	0,5	BR9ECM	3252	-	BR9ECMIX	2707
RX	250	1	1985-1986	0,5	B10EG	3630	-	-	-
Scarabeo 250	250	1	2004-2006	0,7	PMR8B	6378	-	-	-
Scarabeo ie	250	1	2006-	0,7	PMR8A	5851	-	-	-
Scarabeo ie	250	1	2006-2008	0,7	CR8EB	7784	-	CR8EIX	4218
Sport City Cube	250	1	2008-	0,8	CR8EB	7784	-	CR8EIX	4218
Sportcity 250 i.e.	250	1	2006-	0,7	PMR8B	6378	-	-	-
Touareg Rallye	250	1	1985-1987	0,5	B10EG	3630	-	-	-
Climber	276	1	1989-1992	0,7	BP5ES	6511	-	BPR5EIX	6597

* Bitte Elektrodenabstand nach Angaben des Herstellers justieren

* Please adjust the groundelectrode gap

* Veuillez vérifier L' écartement

* Por favor, ajustar distancia entre electrodos

* regolare il gap

C
Y
L

Stock-No

Quick-No



Stock-No IX

APRILIA

TX-300	276	1	-1984	0,7	BP5ES	6511	-	BPR5EIX	6597
TX-311M	276	1	-1984	0,7	BP5ES	6511	-	BPR5EIX	6597
TXR-312 M	276	1	-1986	0,5	BP5ES	6511	-	BPR5EIX	6597
Atlantic	300	1	2009-	0,7	CR8EKB	4374	-	CR8EIX	4218
Leonardo	300	1	2004-2007	0,6	DR7EA	7839	-	DR7EIX	5686
Leonardo (PD) (SV)	300	1	1998-2000	0,6	DR7EA	7839	-	DR7EIX	5686
Leonardo ST	300	1	2005-	0,6	DR8EA	7162	-	DR8EIX	6681
Scarabeo	300	1	2009-	0,7	CR8EKB	4374	-	CR8EIX	4218
Scarabeo Special	300	1	-	0,5	BP5ES	6511	-	BPR5EIX	6597
Scarabeo Special	300	1	-	0,7	CR8EKB	4374	-	CR8EIX	4218
Sport City Cube 300	300	1	2008-	0,7	CR8EKB	4374	-	CR8EIX	4218
SR-MAX	300	1	2011-	0,7	CR8EKB	4374	-	CR8EIX	4218
TL	320	1	1980-1984	0,5	BP5ES	6511	-	BPR5EIX	6597
ETX	350	1	1985-1989	0,5	D8EA	2120	Q216	DR8EIX	6681
Tuareg	350	1	1987-1991	0,5	D8EA	2120	Q216	DR8EIX	6681
Tuareg Wind	350	1	1987-1991	0,5	D8EA	2120	Q216	DR8EIX	6681
Atlantic Sprint	400	1	2006-	0,7	CR7EKB	4455	-	CR7EIX	7385
Scarabeo ie	400	1	2007-	0,7	CR7EKB	4455	-	CR7EIX	7385
MXV-4.5	450	2	2009-	0,7	CR8EKB	4374	-	CR8EIX	4218
RXV-4.5	450	2	2006-	0,7	CR8EB	7784	-	CR8EIX	4218
RXV-4.5	450	2	2007-	0,7	CR8EKB	4374	-	CR8EIX	4218
SXV-4.5	450	2	2006-	0,7	CR8EB	7784	-	CR8EIX	4218
SXV-4.5	450	2	2007-	0,7	CR8EKB	4374	-	CR8EIX	4218
Atlantic	500	1	2002-2004	0,7	CR7EKB	4455	-	CR7EIX	7385
Atlantic Sprint	500	1	2002-2008	0,8	CR7EKB	4455	-	CR7EIX	7385
Scarabeo	500	1	2002-	0,7	CR7EKB	4455	-	CR7EIX	7385
Scarabeo ABS	500	1	2004-2006	0,7	CR7EKB	4455	-	CR7EIX	7385
RXV-5.5	550	2	2006-2008	0,7	CR8EB	7784	-	CR8EIX	4218
RXV-5.5	550	2	2009-	0,7	CR8EKB	4374	-	CR8EIX	4218
SXV-5.5	550	2	2006-2008	0,7	CR8EB	7784	-	CR8EIX	4218
SXV-5.5	550	2	2009-	0,7	CR8EKB	4374	-	CR8EIX	4218
Pegaso	600	1	1990-	0,6	D8EA	2120	Q216	DR8EIX	6681
Touareg	600	1	1988-1993	0,6	D8EA	2120	Q216	DR8EIX	6681
Moto 6.5	650	1	1995-2002	0,6	DR8EA	7162	-	DR8EIX	6681
Pegaso	650	1	1992-2000	0,6	DR8EA	7162	-	DR8EIX	6681
Pegaso Cube	650	1	1996-2000	0,7	DR8EA	7162	-	DR8EIX	6681
Pegaso i.e.	650	1	2001-2005	0,6	DR8EB	4855	-	DR8EIX	6681
Pegaso ie Factory	650	1	2007-2009	0,6	CR7E	4578	Q225	CR7EIX	7385
Pegaso ie Strada	650	1	2005-	0,6	CR7E	4578	Q225	CR7EIX	7385
Pegaso ie Trail	650	1	2006-2009	0,6	CR7E	4578	Q225	CR7EIX	7385
Dorsoduro Factory	750	2	2010-	0,7	CR7EKB	4455	-	CR7EIX	7385
Shiver	750	2	2007-	*	CR7EKB	4455	-	CR7EIX	7385
Shiver GT	750	2	2009-	*	CR7EKB	4455	-	CR7EIX	7385
SL-Shiver	750	2	2007-	0,7	CR7EKB	4455	-	CR7EIX	7385
SMV-Dorsoduro	750	2	2008-	0,7	CR7EKB	4455	-	CR7EIX	7385
Mana GT ABS (Twin Spark)	850	2	2009-	0,8	CR7EKB	4455	-	CR7EIX	7385
NA-Mana	850	2	2008-	0,6	CR7EKB	4455	-	CR7EIX	7385
SRV	850	2	2012-	0,8	CR7EKB	4455	-	CR7EIX	7385
ETV-Caponord	1000	2	2001-2008	0,6	DCPR9E	2641	-	DCPR9EIX	2316
RST-Futura	1000	2	2001-2004	0,6	DCPR9E	2641	-	DCPR9EIX	2316
RSV4-APRC R	1000	4	2011-	0,7	CR9EB	6955	-	CR9EIX	3521
RSV4-APRC R Factory	1000	4	2011-	0,7	CR9EB	6955	-	CR9EIX	3521

* Bitte Elektrodenabstand nach Angaben des Herstellers justieren

* Please adjust the groundelectrode gap

* Veuillez vérifier L' écartement

* Por favor, ajustar distancia entre electrodos

* regolare il gap

C
y
l

0201



Stock-№

Quick-№



Stock-№ IX

APRILIA

RSV4-Factory	1000	4	2009-	0,7	CR9EB	6955	-	CR9EIX	3521
RSV4-Factory SPRC SE	1000	4	2010-	0,7	CR9EB	6955	-	CR9EIX	3521
RSV4-R	1000	4	2010-	0,7	CR9EB	6955	-	CR9EIX	3521
RSV4-R-Factory	1000	4	2009-	0,7	CR9EB	6955	-	CR9EIX	3521
RSV-Mille	1000	2	1998-2000	0,6	DCPR8E	4339	-	DCPR8EIX	6546
RSV-Mille	1000	2	2001-2003	0,6	DCPR9E	2641	-	DCPR9EIX	2316
RSV-Mille Factory	1000	2	2004-2005	0,6	DCPR9E	2641	-	DCPR9EIX	2316
RSV-Mille R	1000	2	1999-2001	0,6	DCPR8E	4339	-	DCPR8EIX	6546
RSV-Mille R	1000	2	2002-2005	0,6	DCPR9E	2641	-	DCPR9EIX	2316
RSV-Mille SP	1000	2	2000-	1,1	R0045J-10	7400	-	-	-
RSV-Mille Tuono	1000	2	2002-2003	0,6	DCPR9E	2641	-	DCPR9EIX	2316
RSV-Mille Tuono Fighter	1000	2	2003-	0,6	DCPR9E	2641	-	DCPR9EIX	2316
RSV-Mille Tuono R	1000	2	2002-2003	0,6	DCPR9E	2641	-	DCPR9EIX	2316
RSV-Mille Tuono Racing	1000	2	2003-	0,6	DCPR9E	2641	-	DCPR9EIX	2316
RSV-R	1000	2	2000-2004	0,6	DCPR9E	2641	-	DCPR9EIX	2316
RSV-R-Factory	1000	2	2005-2009	0,6	DCPR9E	2641	-	DCPR9EIX	2316
RSV-R-NERA	1000	2	2004-	0,6	DCPR9E	2641	-	DCPR9EIX	2316
RSV-SP	1000	2	1999-2000	1,1	R0045J-10	7400	-	-	-
RSV-Tuono V4R	1000	2	2011-	0,7	CR9EKB	2305	-	CR9EIX	3521
RSV-Tuono R	1000	2	2002-	0,6	DCPR9E	2641	-	DCPR9EIX	2316
RSV-Tuono V4	1000	2	2011-	0,7	CR9EKB	2305	-	CR9EIX	3521
SL-Falco	1000	2	1999-2004	0,6	DCPR9E	2641	-	DCPR9EIX	2316
Tuono 1000	1000	4	2002-	0,7	DCPR9E	2641	-	DCPR9EIX	2316
Tuono 1000 R	1000	2	2005-	0,6	DCPR9E	2641	-	DCPR9EIX	2316
Tuono Factory	1000	2	2006-	0,6	DCPR9E	2641	-	DCPR9EIX	2316
Tuono R Factory	1000	2	2006-	0,6	DCPR9E	2641	-	DCPR9EIX	2316
Caponord (Twin Spark)	1200	2	2012-	0,7	CR8EKB	4374	-	CR8EIX	4218
Dorsoduro	1200	2	2010-	0,7	CR9EKB	2305	-	CR9EIX	3521
Dorsoduro	1200	2	2011-	0,7	CR8EKB	4374	-	CR8EIX	4218

ATALA

Byte	50		1997-1998	0,5	B7HS	5110	Q204	BR7HIX	7067
Byte 25	50		1996-	0,6	BPR6HS	7022	Q214	BPR6HIX	4085
Byte 50	50		1996-	0,6	BPR6HS	7022	Q214	BPR6HIX	4085
Carosello	50		-	0,5	B7HS	5110	Q204	BR7HIX	7067
Hacker AT 12, Hacker Racing	50		1997-1998	0,6	BPR6HS	7022	Q214	BPR6HIX	4085
Master	50		1998-1999	0,6	B6HS	4510	Q203	BR6HIX	3419
Skeggia	50		1999-2000	0,6	BPR6HS	7022	Q214	BPR6HIX	4085

ATK

Mini Cross	50	1	1999-2001	0,5	B7HS	5110	Q204	BR7HIX	7067
MX	50	1	1999-2003	0,5	B7HS	5110	Q204	BR7HIX	7067
Enduro Liquid Cooled	125	1	2003-	0,7	D8EA	2120	Q216	DR8EIX	6681
Liquid Cooled	125	1	1999-2003	0,5	B10ES	7928	-	BR10EIX	6801
Air Cooled	250	1	1988-1996	0,5	B8ES	2411	Q201	BR8EIX	5044
Liquid Cooled	250	1	1995-2003	0,5	B8ES	2411	Q201	BR8EIX	5044
Liquid Cooled	260	1	1995-2002	0,5	B8ES	2411	Q201	BR8EIX	5044
Cross	350	1	1991-1999	0,7	D8EA	2120	Q216	DR8EIX	6681
Cross Country	350	1	1991-1999	0,7	D8EA	2120	Q216	DR8EIX	6681
Enduro	350	1	1991-2002	0,7	D8EA	2120	Q216	DR8EIX	6681

* Bitte Elektrodenabstand nach Angaben des Herstellers justieren

* Please adjust the groundelectrode gap

* Veuillez vérifier L' écartement

* Por favor, ajustar distancia entre electrodos

* regolare il gap

C
Y
L

Stock-No

Quick-No



Stock-No IX

ATK									
406	400	1	1988-1999	0,5	B8ES	2411	Q201	BR8EIX	5044
4(Air Cooled)	450	1	2003-2003	0,5	B8ES	2411	Q201	BR8EIX	5044
500 Dirt Track	490	1	1999-2003	0,7	D8EA	2120	Q216	DR8EIX	6681
500 Enduro	500	1	1998-2003	0,7	D8EA	2120	Q216	DR8EIX	6681
Supermotard	500	1	2001-2002	0,7	D8EA	2120	Q216	DR8EIX	6681
604	560	1	1988-1993	0,7	D8EA	2120	Q216	DR8EIX	6681
600 Dirt Track (Air Cooled)	600	1	1998-2003	0,7	D8EA	2120	Q216	DR8EIX	6681
605 Cross Country	600	1	1993-2000	0,7	D8EA	2120	Q216	DR8EIX	6681
605 Dirt Track	600	1	1998-2003	0,7	D8EA	2120	Q216	DR8EIX	6681
605 Enduro	600	1	1993-2000	0,7	D8EA	2120	Q216	DR8EIX	6681
605 Enduro (Air Cooled)	600	1	1993-2003	0,7	D8EA	2120	Q216	DR8EIX	6681
Supermotard	600	1	2001-2002	0,7	D8EA	2120	Q216	DR8EIX	6681
Supermotard	600	1	2003-2003	0,8	CR9EK	4548	Q230	CR9EIX	3521

BAJAJ									
Bonnie 50	50		1993-	0,5	B6HS	4510	Q203	BR6HIX	3419
Sprit	50	1	1999-	0,5	B6HS	4510	Q203	BR6HIX	3419
Sunny	50	1	1996-	0,5	B6HS	4510	Q203	BR6HIX	3419
KB100	100		1993-	0,5	B8ES	2411	Q201	BR8EIX	5044
Chetak	125	1	1996-	0,5	BP6HS	4511	-	BPR6HIX	4085
Vespa	125		1993-	0,5	B6HS	4510	Q203	BR6HIX	3419
Chetak 150	150		2001-	0,7	BPR5HS	6222	-	-	-
Classic	150	1	2000-	0,6	BPR5HS	6222	-	-	-

BAOTIAN									
BT49QT-11	50	1	2004-	0,6	CR7HSA	4549	-	CR7HIX	7544
BT49QT-12	50	1	2004-	0,6	CR7HSA	4549	-	CR7HIX	7544
BT49QT-2	50	1	-	0,6	CR7HSA	4549	-	CR7HIX	7544
BT49QT-7	50	1	-	0,6	CR7HSA	4549	-	CR7HIX	7544
BT49QT-9	50	1	2004-	0,6	CR7HSA	4549	-	CR7HIX	7544
BT110-2	110	1	2004-	0,6	CR7HSA	4549	-	CR7HIX	7544
BT125QT-2B	125	1	-	0,6	CR7HSA	4549	-	CR7HIX	7544
BT125T-12	125	1	-	0,6	CR7HSA	4549	-	CR7HIX	7544
BT125T-2	125	1	-	0,6	CR7HSA	4549	-	CR7HIX	7544
BT125T-7	125	1	-	0,6	CR7HSA	4549	-	CR7HIX	7544
BT125T-9	125	1	-	0,6	CR7HSA	4549	-	CR7HIX	7544
Citybike	125	1	2004-	0,6	CR7HSA	4549	-	CR7HIX	7544
Monza	125		-	0,6	CR7HSA	4549	-	CR7HIX	7544
Tanco	125	1	2004-	0,6	CR7HSA	4549	-	CR7HIX	7544

BASHAN									
BS 110 GY	110	1	2001-	0,6	C7HSA	4629	-	CR7HIX	7544
BS 125 GY	125	1	2001-	0,6	D8EA	2120	Q216	DR8EIX	6681
BS 200 GY	200	1	2001-	0,6	D8EA	2120	Q216	DR8EIX	6681
Vixen VX250	250		2006-	0,7	DR8EA	7162	-	DR8EIX	6681

BATAVUS									
G50, Mosquito, M40, TS49	50	1	-	0,5	B6HS	4510	Q203	BR6HIX	3419
Go-Go2,-V,-S	50	1	-	0,5	B6HS	4510	Q203	BR6HIX	3419
Mondial	50	1	-	0,4	B6HS	4510	Q203	BR6HIX	3419
Stargoi	50	1	-	0,5	B7HS	5110	Q204	BR7HIX	7067

* Bitte Elektrodenabstand nach Angaben des Herstellers justieren

* Please adjust the groundelectrode gap

* Veuillez vérifier L' écartement

* Por favor, ajustar distancia entre electrodos

* regolare il gap

C
y
l

0201



Stock-Nr

Quick-Nr



Stock-Nr IX

BATAVUS

TS 49 S	50	1	-	0,5	B8HS	5510	Q205	BR8HIX	7001
---------	----	---	---	-----	------	------	------	--------	------

BENELLI

3G2	50		-	0,5	B6ES	7310	-	-	-
491-GT - Air Cool.	50	1	1997-	0,6	BR8ES	5422	Q207	BR8EIX	5044
491-LC - Sport, Racing, SBK, Army	50	1	1997-	0,6	BR8ES	5422	Q207	BR8EIX	5044
491-LC cat. Racing & Sport	50	1	1999-	0,6	BR8HS	4322	Q212	BR8HIX	7001
49X Quattro Nove	50	1	2008-	0,6	BR8HSA	5539	-	BR8HIX	7001
49X Road	50	1	2008-	0,6	BR8HSA	5539	-	BR8HIX	7001
49X Trek	50	1	2008-	0,6	BR8HSA	5539	-	BR8HIX	7001
AI	50	1	-	0,6	B6HS	4510	Q203	BR6HIX	3419
Cross	50		-	0,5	B6ES	7310	-	-	-
Gentleman, Magnum 5V	50	1	-	0,5	B5ES	6410	-	-	-
K2-Namur AC	50	1	1998-	0,6	BR7HS	4122	Q211	BR7HIX	7067
K2-Namur LC	50	1	1999-	0,6	BR8HS	4322	Q212	BR8HIX	7001
LX	50	1	1999-	0,6	BR8HS	4322	Q212	BR8HIX	7001
Magnum 3V	50	1	-	0,5	B7ES	1111	-	BR7EIX	6664
Motorella	50		-	0,5	B6ES	7310	-	-	-
Naked	50	1	-	0,6	BR8HS	4322	Q212	BR8HIX	7001
Pepe Cat.	50	1	1999-	0,6	BR8HS	4322	Q212	BR8HIX	7001
Pepe Classic	50	1	2010-	0,6	BR7HS	4122	Q211	BR7HIX	7067
Scoothy	50	1	-	0,6	B6HS	4510	Q203	BR6HIX	3419
Spring	50	1	-	0,5	B8ES	2411	Q201	BR8EIX	5044
Stilo	50	1	-	0,6	B6HS	4510	Q203	BR6HIX	3419
X-Offroad	50	1	2008-	0,8	BR8HS	4322	Q212	BR8HIX	7001
X-Quattronove X 50	50	1	2008-	0,8	BR8HS	4322	Q212	BR8HIX	7001
K2	100	1	2001-	0,6	BR8HS	4322	Q212	BR8HIX	7001
2C Twin	125	2	-	0,5	B7ES	1111	-	BR7EIX	6664
Adiva	125	1	2001-	0,7	CR9EB	6955	-	CR9EIX	3521
Cross	125		-	0,5	B7ES	1111	-	BR7EIX	6664
Jarno	125	1	-	0,5	B8ES	2411	Q201	BR8EIX	5044
Macis	125	1	2010-	0,6	CR8E	1275	Q226	CR8EIX	4218
Roadster	125		-	0,5	B7ES	1111	-	BR7EIX	6664
Scooter S	125	1	-	0,5	B7HS	5110	Q204	BR7HIX	7067
Velvet	125	1	2001-	0,6	CR8E	1275	Q226	CR8EIX	4218
Adiva	150	1	2001-	0,7	CR9EB	6955	-	CR9EIX	3521
Macis	150	1	2010-	0,6	CR8E	1275	Q226	CR8EIX	4218
Velvet	150	1	2001-	0,6	CR8E	1275	Q226	CR8EIX	4218
304	230	1	1982-	0,6	B7HS	5110	Q204	BR7HIX	7067
250 (4-cyl.)	250	4	-	0,5	C7HSA	4629	-	CR7HIX	7544
2C, 2CE, Sport spéciale	250		-	0,5	B7ES	1111	-	BR7EIX	6664
Adiva	250		-	0,8	CR8EB	7784	-	CR8EIX	4218
Cafenero 250	250	1	2012-	0,6	CR8E	1275	Q226	CR8EIX	4218
Caffè Nero	250	1	2008-	0,9	DPR8EA-9	4929	Q221	DPR8EIX-9	2202
Super	250		-	0,5	B8ES	2411	Q201	BR8EIX	5044
Velvet	250		2000-2007	0,6	CR8E	1275	Q226	CR8EIX	4218
Velvet	250	1	2001-	0,6	DR8EA	7162	-	DR8EIX	6681
Velvet MY08	250	1	2008-	0,9	DPR8EA-9	4929	Q221	DPR8EIX-9	2202
Dusk	400		2005-	0,7	CR9E	6263	Q227	CR9EIX	3521
Velvet 400	400		2003-2004	0,7	CR9E	6263	Q227	CR9EIX	3521
LS, Quattro, 504 Sport	500	1	-	0,5	D8EA	2120	Q216	DR8EIX	6681

* Bitte Elektrodenabstand nach Angaben des Herstellers justieren

* Please adjust the groundelectrode gap

* Veuillez vérifier l' écartement

* Por favor, ajustar distancia entre electrodos

* regolare il gap

C
Y
L

0201



Stock-No

Quick-No



Stock-No IX

BENELLI

654 Sport, 4C	650	1	-	0,5	D8EA	2120	Q216	DR8EIX	6681
S / SV-Tornado	650	1	-	0,5	B8ES	2411	Q201	BR8EIX	5044
Sei	750	6	-	0,5	D8EA	2120	Q216	DR8EIX	6681
Century Racer	900	3	2010-	0,7	CR9E	6263	Q227	CR9EIX	3521
TNT-899	900	3	2007-	0,7	CR9E	6263	Q227	CR9EIX	3521
TNT-899 Cafe Racer	900	3	2009-	0,7	CR9E	6263	Q227	CR9EIX	3521
TNT-899 Sport	900	3	2007-	0,7	CR9E	6263	Q227	CR9EIX	3521
TNT-899 S-Tornado Naked Tre	900		2008-	0,7	CR9E	6263	Q227	CR9EIX	3521
Tornado	900		2000-	0,7	CR9E	6263	Q227	CR9EIX	3521
Tornado LE	900	3	2005-	0,6	C7E	5096	-	CR7EIX	7385
Tornado Limited Edition	900		2000-	0,7	CR9E	6263	Q227	CR9EIX	3521
Tornado RS	900	3	2005-	0,6	C7E	5096	-	CR7EIX	7385
Tornado TRE	900	3	2005-	0,6	C7E	5096	-	CR7EIX	7385
Tornado Tre 903	900	3	2008-	0,7	CR9E	6263	Q227	CR9EIX	3521
Tre-K 899	900		2009-	0,7	CR9EB	6955	-	CR9EIX	3521
VN-Sei	900	6	-	0,5	D8EA	2120	Q216	DR8EIX	6681
VT-Sei	900	6	-	0,5	D8EA	2120	Q216	DR8EIX	6681
Tre-K	998	3	2007-	0,7	CR9E	6263	Q227	CR9EIX	3521
Century Racer	1130	3	2010-	0,7	CR9E	6263	Q227	CR9EIX	3521
TNT	1130	3	2004-	0,7	CR9E	6263	Q227	CR9EIX	3521
TNT-Cafe Racer	1130	3	-	0,7	CR9E	6263	Q227	CR9EIX	3521
TNT-K	1130		2004-	0,7	CR9E	6263	Q227	CR9EIX	3521
TNT-R160	1130	3	2009-	0,7	CR9E	6263	Q227	CR9EIX	3521
TNT-Sport Evo	1130	3	-	0,7	CR9E	6263	Q227	CR9EIX	3521
TNT-Titanium	1130		2006-	0,8	CR9E	6263	Q227	CR9EIX	3521
Tornado Tre 163ch	1130	3	-	0,7	CR9E	6263	Q227	CR9EIX	3521
Tornado Tre K	1130		2006-	0,7	CR9E	6263	Q227	CR9EIX	3521
Tre K Amazonas	1130		2007-	0,7	CR9E	6263	Q227	CR9EIX	3521
Tre-K	1130	3	2006-	0,7	CR9E	6263	Q227	CR9EIX	3521

BETA / BETAMOTOR

ALP	50	1	1995-	0,5	B8ES	2411	Q201	BR8EIX	5044
Ark - ref. Liquid, LC serie K	50	1	1997-	0,5	BR8HS	4322	Q212	BR8HIX	7001
Ark 2 tps - ref.air	50	1	-	0,6	BR7HS	4122	Q211	BR7HIX	7067
Ark 2 tps - ref liquid	50	1	-	0,6	BR7HS	4122	Q211	BR7HIX	7067
Ark AC	50	1	2009-	0,5	BR8HS	4322	Q212	BR8HIX	7001
Ark Air	50	1	1997-	0,5	BR7HS	4122	Q211	BR7HIX	7067
Ark LC	50	1	2009-	0,5	BR8HS	4322	Q212	BR8HIX	7001
Ark RR	50	1	-	0,6	BR8HS	4322	Q212	BR8HIX	7001
Ark Skull	50	1	2009-	0,6	BR8HS	4322	Q212	BR8HIX	7001
Ark X Type	50	1	-	0,6	BR8HS	4322	Q212	BR8HIX	7001
Bad	50	1	-	0,5	B9ES	2611	Q202	BR9EIX	3981
Chrono, 502	50	1	1995-	0,5	BR7HS	4122	Q211	BR7HIX	7067
Eikon	50	1	1999-	0,5	BR8HS	4322	Q212	BR8HIX	7001
KR	50	1	-	0,5	B6ES	7310	-	-	-
Minicross 10"x10" & 12"x15"	50	1	1999-	0,5	B7HS	5110	Q204	BR7HIX	7067
Minitrial	50	1	1995-	0,5	B7HS	5110	Q204	BR7HIX	7067
MX	50	1	1993-	0,5	B9ES	2611	Q202	BR9EIX	3981
Quadra	50	1	1995-	0,5	BR7HS	4122	Q211	BR7HIX	7067
R10, R12	50	1	-	0,5	B7HS	5110	Q204	BR7HIX	7067
REV	50	1	2004-	0,5	B9ES	2611	Q202	BR9EIX	3981

* Bitte Elektrodenabstand nach Angaben des Herstellers justieren

* Please adjust the groundelectrode gap

* Veuillez vérifier L' écartement

* Por favor, ajustar distancia entre electrodos

* regolare il gap

C
Y
L

Stock-№

Quick-№



Stock-№ IX

BETA / BETAMOTOR

RK-6-50	50	1	-	0,5	B8ES	2411	Q201	BR8EIX	5044
RR-Enduro	50	1	-	0,5	BR9ES	5722	Q208	BR9EIX	3981
RR-Enduro	50	1	1997-	0,5	B9ES	2611	Q202	BR9EIX	3981
RR-Enduro, Racing 50 (Euro 2)	50		2004-	0,6	BR9ES	5722	Q208	BR9EIX	3981
RR-Euro2 (Motard 50/ Racing/ Alu)	50	1	-	0,6	BR9ES	5722	Q208	BR9EIX	3981
RR-Motard	50	1	-	0,5	BR9ES	5722	Q208	BR9EIX	3981
RR-Motard	50	1	2009-	0,5	BR9ES	5722	Q208	BR9EIX	3981
RR-Motard Track	50	1	2009-	0,5	BR9ES	5722	Q208	BR9EIX	3981
RR-Racing	50	1	-	0,5	BR9ES	5722	Q208	BR9EIX	3981
RR-Racing	50	1	2009-	0,5	BR9ES	5722	Q208	BR9EIX	3981
RR-Super Motard	50	1	1997-	0,5	B9ES	2611	Q202	BR9EIX	3981
RR-Tempo 50	50	1	-	0,5	BR7HS	4122	Q211	BR7HIX	7067
Super Trial	50	1	1994-	0,5	B8ES	2411	Q201	BR8EIX	5044
Supermotard	50	1	-	0,5	B10ES	7928	-	BR10EIX	6801
Tempo	50	1	1995-	0,5	BR7HS	4122	Q211	BR7HIX	7067
Zero, Zero Mini	50	1	1994-1995	0,5	B9ES	2611	Q202	BR9EIX	3981
EVO-80	80	1	2008-	0,6	BR8ES	5422	Q207	BR8EIX	5044
EVO-80 Junior	80	1	2008-	0,6	BR8ES	5422	Q207	BR8EIX	5044
M4 4-Stroke	80	1	-	0,8	CR9EK	4548	Q230	CR9EIX	3521
REV-Zero	80	1	2004-	0,5	B9ES	2611	Q202	BR9EIX	3981
REV-Zero Mini	80	1	2004-	0,5	B9ES	2611	Q202	BR9EIX	3981
R107-4 Stroke	107		-	0,7	C7HSA	4629	-	CR7HIX	7544
Dougie Lampkin Replica	124	1	-	0,5	B8ES	2411	Q201	BR8EIX	5044
Alp 2 Stroke	125	1	1998-1999	0,5	BP7ES	2412	Q206	BPR7EIX	4055
Alp 4 Stroke	125	1	-	0,6	CR7HSA	4549	-	CR7HIX	7544
Alp 4 Stroke	125	1	2000-	0,7	DR8EA	7162	-	DR8EIX	6681
E6G	125		-	0,5	B7HS	5110	Q204	BR7HIX	7067
Eikon	125	1	1999-	0,6	DR8EA	7162	-	DR8EIX	6681
Enduro	125		-	0,5	B7HS	5110	Q204	BR7HIX	7067
Euro Cruiser	125	1	-	0,7	DR8EA	7162	-	DR8EIX	6681
EVO-Engine 2 Stroke	125	1	2008-	0,5	BR7ES	5122	-	BR7EIX	6664
Jonathan	125	1	2000-	0,7	DR8EA	7162	-	DR8EIX	6681
Minicross R 125 4 Stroke	125		-	0,7	C7HSA	4629	-	CR7HIX	7544
R -4 Stroke	125	1	-	0,6	C7HSA	4629	-	CR7HIX	7544
RE-4 Stroke	125	1	2006-	0,6	CR7HSA	4549	-	CR7HIX	7544
REV-3	125	1	2000-	0,6	BP6ES	7811	-	BPR6EIX	6637
REV-3	125	1	2000-2006	0,6	BP6ES	7811	-	BPR6EIX	6637
REV-3	125	1	2006-	0,5	BP7ES	2412	Q206	BPR7EIX	4055
REV-3 Trials	125	1	2006-	0,5	BP7ES	2412	Q206	BPR7EIX	4055
RR-Enduro	125		2006-	0,6	CR7HSA	4549	-	CR7HIX	7544
RR-Enduro	125		2010-	0,6	CR8E	1275	Q226	CR8EIX	4218
RR-LC - Engine Minarelli 4-Stroke liquid	125	1	2010-	0,6	CR8E	1275	Q226	CR8EIX	4218
RR-Motard	125		2006-	0,6	CR7HSA	4549	-	CR7HIX	7544
Synt	125	1	1994-	0,5	B8ES	2411	Q201	BR8EIX	5044
Techno	125	1	1995-	0,5	BR8ES	5422	Q207	BR8EIX	5044
TR-32	125	1	-	0,5	B8ES	2411	Q201	BR8EIX	5044
TR-34	125	1	-	0,5	B8ES	2411	Q201	BR8EIX	5044
TR-35	125	1	-	0,5	B8ES	2411	Q201	BR8EIX	5044
Trial	125		-	0,5	B6ES	7310	-	-	-
Urban 125	125	1	2008-	0,6	CR7HSA	4549	-	CR7HIX	7544
Urban 125 Spécial	125	1	-	0,6	CR7HSA	4549	-	CR7HIX	7544
Zero	125	1	1994-	0,5	B8ES	2411	Q201	BR8EIX	5044

* Bitte Elektrodenabstand nach Angaben des Herstellers justieren

* Please adjust the groundelectrode gap

* Veuillez vérifier L' écartement

* Por favor, ajustar distancia entre electrodos

* regolare il gap

C
Y
L

0201



Stock-No

Quick-No



Stock-No IX

BETA / BETAMOTOR

Eikon	150	1	1999-	0,9	DPR7EA-9	5129	Q220	DPR7EIX-9	7803
Alp 4 Stroke - Eng. Suzuki	200	1	2001-	0,7	DR8EA	7162	-	DR8EIX	6681
EVO-Engine 2 Stroke	200	1	2008-	0,6	BR7ES	5122	-	BR7EIX	6664
REV-3	200	1	-	0,6	BP6ES	7811	-	BPR6EIX	6637
REV-3 Trials	200		2000-2007	0,6	BP7ES	2412	Q206	BPR7EIX	4055
REV-3 Trials	200	1	2008-	0,5	BR7ES	5122	-	BR7EIX	6664
Techno 200 Trial	200		-1996	0,6	BR8ES	5422	Q207	BR8EIX	5044
Techno 200 Trial	200		1996-	0,6	BP7ES	2412	Q206	BPR7EIX	4055
Urban	200	1	2008-	0,6	DR8EA	7162	-	DR8EIX	6681
Urban Special	200	1	2009-	0,6	DR8EA	7162	-	DR8EIX	6681
Alp	240	1	1995-	0,5	B8ES	2411	Q201	BR8EIX	5044
Super Trail	240	1	1994-	0,5	B8ES	2411	Q201	BR8EIX	5044
TR-33	240	1	-	0,5	B6ES	7310	-	-	-
Trial	240		-	0,5	B6ES	7310	-	-	-
Dougie Lampkin Replica	247	1	-	0,5	BP7ES	2412	Q206	BPR7EIX	4055
Alp	250	1	-	0,5	B8ES	2411	Q201	BR8EIX	5044
Alp LC	250	1	1995-	0,5	BP7ES	2412	Q206	BPR7EIX	4055
Eikon	250	1	1999-	0,9	DPR7EA-9	5129	Q220	DPR7EIX-9	7803
Enduro	250		-	0,5	B7HS	5110	Q204	BR7HIX	7067
EVO-Engine 2 Stroke	250	1	2008-	0,6	BR7ES	5122	-	BR7EIX	6664
EVO-Engine 4 Stroke	250	1	2008-	0,8	CR7EB	4663	-	CR7EIX	7385
REV-3	250	1	2000-	0,5	BP7ES	2412	Q206	BPR7EIX	4055
REV-3 2 Stroke Trials	250	1	2000-2007	0,6	BP7ES	2412	Q206	BPR7EIX	4055
REV-3 2 Stroke Trials	250	1	2008-	0,5	BR7ES	5122	-	BR7EIX	6664
REV-4 Stroke Trials	250		2007-	0,6	CR7EB	4663	-	CR7EIX	7385
RR-4 Stroke	250	1	-	0,8	DCPR8E	4339	-	DCPR8EIX	6546
Techno	250	1	-	0,5	BP7ES	2412	Q206	BPR7EIX	4055
Techno	250	1	1996-1999	0,5	BR8ES	5422	Q207	BR8EIX	5044
TR32, Super Trail	250	1	-	0,5	B8ES	2411	Q201	BR8EIX	5044
Trial	250	1	-	0,5	BP7ES	2412	Q206	BPR7EIX	4055
Alp, Super Trail	260	1	-	0,5	B8ES	2411	Q201	BR8EIX	5044
Synt	260	1	1994-	0,5	B8ES	2411	Q201	BR8EIX	5044
TR-34	260	1	-	0,5	B8ES	2411	Q201	BR8EIX	5044
TR-35 Campionato	260	1	-	0,5	B8ES	2411	Q201	BR8EIX	5044
Zero	260	1	-	0,5	B8ES	2411	Q201	BR8EIX	5044
Zero Gara	260	1	1994-	0,5	B8ES	2411	Q201	BR8EIX	5044
REV-3	270	1	2006-	0,5	BR7ES	5122	-	BR7EIX	6664
Techno 270 Trial	270		-1996	0,6	BR8ES	5422	Q207	BR8EIX	5044
Techno 270 Trial	270		1996-	0,6	BP7ES	2412	Q206	BPR7EIX	4055
REV 3 270	275	1	-	0,6	BP6ES	7811	-	BPR6EIX	6637
EVO-Engine 2 Stroke	290	1	-	0,5	BR7ES	5122	-	BR7EIX	6664
EVO-Engine 4 Stroke	300	1	2009-	0,8	CR7EB	4663	-	CR7EIX	7385
RR-2 temps	300	1	2012-	0,6	BR7ES	5122	-	BR7EIX	6664
Alp 4.0 (Suzuki engine)	350		-	0,7	CR9EK	4548	Q230	CR9EIX	3521
Alp M4 - Eng. Suzuki	350	1	-	0,6	CR9EK	4548	Q230	CR9EIX	3521
Euro	350	1	1999-	0,9	DPR8EA-9	4929	Q221	DPR8EIX-9	2202
Jonathan	350	1	-	0,7	CR9EK	4548	Q230	CR9EIX	3521
M4T	350	1	2011-	0,7	CR9EK	4548	Q230	CR9EIX	3521
Motard 4.0 4 Stroke	350	1	2003-	0,7	CR9EK	4548	Q230	CR9EIX	3521
RR-Racing	350		2013-	0,9	LKAR8A-9	4786	-	-	-
Alp 4.0	400	1	2004-	0,7	CR9EK	4548	Q230	CR9EIX	3521
RR-4 Stroke	400	1	-	0,8	DCPR8E	4339	-	DCPR8EIX	6546

* Bitte Elektrodenabstand nach Angaben des Herstellers justieren

* Please adjust the groundelectrode gap

* Veuillez vérifier l' écartement

* Por favor, ajustar distancia entre electrodos

* regolare il gap

C
y
l

0201



Stock-№

Quick-№



Stock-№ IX

BETA / BETAMOTOR

RR-4 Stroke	400	1	2010-	0,9	LKAR8A-9	4786	-	LKAR8AI-9	6706
RR-4 Stroke	450	1	-	0,8	DCPR8E	4339	-	DCPR8EIX	6546
RR-4 Stroke	450	1	2010-	0,9	LKAR8A-9	4786	-	LKAR8AI-9	6706
RR-4 Stroke	500	1	2010-	0,9	LKAR8A-9	4786	-	LKAR8AI-9	6706
RR-498 Enduro 4 Stroke	500	1	2013-	0,9	LKAR8A-9	4786	-	-	-
RR-4 Stroke	520	1	2010-	0,9	LKAR8A-9	4786	-	LKAR8AI-9	6706
RR-4 Stroke	525	1	-	0,8	DCPR8E	4339	-	DCPR8EIX	6546

BIMOTA

V-Due	500	2	1997-	0,7	BR8ES	5422	Q207	BR8EIX	5044
V-Due Evoluzione	500	2	2000-	0,7	-	-	-	DR8EIX	6681
YB-9-Bellaria	600	4	1990-1993	0,7	CR9E	6263	Q227	CR9EIX	3521
YB-9-SR, Sri	600	4	1994-1996	0,7	CR9E	6263	Q227	CR9EIX	3521
BB-1-Supermono, Biposto	650	1	1995-1996	0,7	D8EA	2120	Q216	DR8EIX	6681
SB-7-(Suzuki)	750	4	1994-1996	0,7	CR9EK	4548	Q230	CR9EIX	3521
DB-2-(Ducati)	900	2	1993-1995	0,9	DPR8EA-9	4929	Q221	DPR8EIX-9	2202
DB-2-SR, Half Fairing, Full Fairing	900	2	1994-1996	0,9	DPR8EA-9	4929	Q221	DPR8EIX-9	2202
DB-3-Mantra	900	2	1995-1998	0,9	DPR8EA-9	4929	Q221	DPR8EIX-9	2202
DB-4	900	2	1998-	0,9	DPR8EA-9	4929	Q221	DPR8EIX-9	2202
DB-4-Injection	900	2	2000-	0,9	DCPR8E	4339	-	DCPR8EIX	6546
DB-3-Mantra (Ducati)	904	2	1995-1998	0,9	DPR8EA-9	4929	Q221	DPR8EIX-9	2202
DB-1-Tesi 1 D ES, SR	906	2	1994-	0,6	-	-	-	DR9EIX	4772
DB-5	992	2	2005-	0,8	DCPR8E	4339	-	DCPR8EIX	6546
SB-8-R	1000	2	1998-1999	0,7	CR9EK	4548	Q230	CR9EIX	3521
SB-8-R Spécial	1000	2	-	0,7	CR9EK	4548	Q230	CR9EIX	3521
YB-10-Biposto	1000		1995-	0,7	DR8EA	7162	-	DR8EIX	6681
YB-11-Superlaggera	1000	4	1996-1998	0,7	DR8EA	7162	-	DR8EIX	6681
YB-6	1000	4	1988-1990	0,7	DR8ES-L	2923	Q218	DR8EIX	6681
YB-8-E Paioli, Evolution, E Ohlins, EXUP	1000	4	1995-	0,7	DR8ES-L	2923	Q218	DR8EIX	6681
DB-5-R,S	1078	2	2010-	0,8	DCPR8E	4339	-	DCPR8EIX	6546
DB-6-R Delirio	1078	2	2008-	0,9	DCPR8E	4339	-	DCPR8EIX	6546
DB-6-R,S	1078	2	2010-	0,8	DCPR8E	4339	-	DCPR8EIX	6546
Tesi 3 D	1078	2	2010-	0,8	DCPR8E	4339	-	DCPR8EIX	6546
DB-5	1100	2	2005-2006	0,9	DCPR8E	4339	-	DCPR8EIX	6546
DB-6	1100	2	2007-	0,8	DCPR8E	4339	-	DCPR8EIX	6546
DB-7	1100		2009-	0,8	MAR10A-J	4706	-	-	-
SB-6-(Suzuki)	1100	4	1994-1996	0,7	CR9E	6263	Q227	CR9EIX	3521
SB-6-R	1100	4	1997-1998	0,7	CR9E	6263	Q227	CR9EIX	3521

BLATA

Elite 13	40	1	-	0,8	B9ES	2611	Q202	BR9EIX	3981
Elite 13S	40	1	-	0,5	B9EGV	5827	-	-	-
Elite 13W	40	1	-	0,8	B9ES	2611	Q202	BR9EIX	3981
Elite 13WR / R	40	1	-	0,5	B9EGV	5827	-	-	-
Elite 13WRS	40	1	-	0,5	B9EGV	5827	-	-	-
Pocket bike Réplica	49	1	-	0,7	BR6HS	3922	Q209	BR6HIX	3419

BMW

C1-C1N Scooter	125	1	2000-2003	0,7	CR8EB	7784	-	CR8EIX	4218
C1-C1N Scooter	200	1	2000-2003	0,7	CR8EB	7784	-	CR8EIX	4218

* Bitte Elektrodenabstand nach Angaben des Herstellers justieren

* Please adjust the groundelectrode gap

* Veuillez vérifier L' écartement

* Por favor, ajustar distancia entre electrodos

* regolare il gap

C
Y
L

0201



Stock-No

Quick-No



Stock-No IX

BMW

G-X K16	450	1	2007-2010	0,7	CR9EKB	2305	-	CR9EIX	3521
R-50 & 51 Series - Long Base	500		-	0,5	B8ES	2411	Q201	BR8EIX	5044
R-50 & 51 Series - Short Base	500		-	0,5	B7HS	5110	Q204	BR7HIX	7067
C-Sport K18	600	2	2012-	0,8	LMAR8D-J	93444	-	-	-
R-60 & 69 Series - Long Base	600		-	0,5	B8ES	2411	Q201	BR8EIX	5044
R-60 & 69 Series - Short Base	600		-	0,5	B8HS	5510	Q205	BR8HIX	7001
BMS-C II-F 650 TwinSpark	650	1	2004-	0,6	DR8EB	4855	-	DR8EIX	6681
C-GT K19	650	2	2012-	0,8	LMAR8D-J	93444	-	-	-
F-CS K14 02	650	1	2000-2003	0,6	DR8EB	4855	-	DR8EIX	6681
F-CS K14 04	650	1	2003-2005	0,6	DR8EB	4855	-	DR8EIX	6681
F-CS Scarver	650	1	2001-	0,7	D8EA	2120	Q216	DR8EIX	6681
F-E169 94	650	1	1993-1996	0,7	D8EA	2120	Q216	DR8EIX	6681
F-E169 97	650	1	1996-2003	0,7	D8EA	2120	Q216	DR8EIX	6681
F-GS Dakar R13 00	650	1	1999-2003	0,7	D8EA	2120	Q216	DR8EIX	6681
F-GS Dakar R13 04	650	1	2003-2007	0,6	DR8EB	4855	-	DR8EIX	6681
F-GS K72	650	1	2006-2012	0,9	DCPR8E	4339	-	DCPR8EIX	6546
F-GS R13 00	650	1	1999-2003	0,6	D8EA	2120	Q216	DR8EIX	6681
F-GS R13 04	650	1	2003-2007	0,6	DR8EB	4855	-	DR8EIX	6681
F-GS Sertão R13	650	2	2010-	0,6	DR8EB	4855	-	DR8EIX	6681
F-ST E169 97	650	1	1996-2000	0,7	D8EA	2120	Q216	DR8EIX	6681
G-GS R131 09	650	1	2008-2010	0,6	DR8EB	4855	-	DR8EIX	6681
G-GS R131 11	650	1	2010-	0,6	DR8EB	4855	-	DR8EIX	6681
G-Xchallenge K15	650	1	2006-2009	0,6	DR8EB	4855	-	DR8EIX	6681
G-Xcountry K15 07	650	1	2006-2007	0,6	DR8EB	4855	-	DR8EIX	6681
G-Xcountry K15 08	650	1	2007-2009	0,6	DR8EB	4855	-	DR8EIX	6681
G-Xmoto K15	650	1	2006-2007	0,6	DR8EB	4855	-	DR8EIX	6681
R-65 LS	650	2	1978-	0,6	BP7ES	2412	Q206	BPR7EIX	4055
F-GS K70	700	2	2011-	0,9	DCPR8E	4339	-	DCPR8EIX	6546
75 RT K569	750	3	1989-1997	0,6	D7EA	7912	-	DR7EIX	5686
75 S K569	750	3	1985-1996	0,6	D7EA	7912	-	DR7EIX	5686
F-650 GS	800	2	2008-	0,9	DCPR8E	4339	-	DCPR8EIX	6546
F-GS Adventure K75	800	2	2012-	0,8	DCPR8E	4339	-	DCPR8EIX	6546
F-GS K72 08	800	2	2008-2012	0,9	DCPR8E	4339	-	DCPR8EIX	6546
F-GS K72 13	800	2	2013-	0,8	DCPR8E	4339	-	DCPR8EIX	6546
F-GT K71	800	2	2013-	0,8	DCPR8E	4339	-	DCPR8EIX	6546
F-R Chris Pfeiffer Replica	800	2	2009-	0,8	DCPR8E	4339	-	DCPR8EIX	6546
F-R K73	800	2	2009-	0,8	DCPR8E	4339	-	DCPR8EIX	6546
F-S K71	800	2	2006-	0,8	DCPR8E	4339	-	DCPR8EIX	6546
F-ST K71	800	2	2004-2012	0,8	DCPR8E	4339	-	DCPR8EIX	6546
R	850	2	1994-1995	0,8	BCPR7ET	2164	-	BCPR7EIX	5690
R	850	2	1995-1999	0,8	BKR7EKC	7354	-	BKR7EIX	2667
R 259R 94	850	2	1994-2002	0,8	BKR7EKC	7354	-	BKR7EIX	2667
R R28 02	850	2	1999-2007	*	BKR7EKC	7354	-	BKR7EIX	2667
R-C 59C1 99	850	2	1998-2000	0,8	BKR7EKC	7354	-	BKR7EIX	2667
R-GS 259E 95	850	2	1994-2000	0,8	BKR7EKC	7354	-	BKR7EIX	2667
RT R22 02	850	2	2000-2006	0,8	BKR7EKC	7354	-	BKR7EIX	2667
RT K26 05 SF	900	2	2005-2009	0,8	DCPR8EKC	7168	-	DCPR8EIX	6546
RT K26 10 SF	900	2	2009-	0,8	DCPR8EKC	7168	-	DCPR8EIX	6546
K-100 RS 16 V	1000	4	1989-	0,6	DR7EA	7839	-	DR7EIX	5686
R-100	1000	2	-	0,6	BP7ES	2412	Q206	BPR7EIX	4055
R-100 GS 47E1	1000	2	1986-1995	0,6	BP6ES	7811	-	BPR6EIX	6637
R-100 Mystik 94 2473	1000	2	1993-1996	0,6	BP6ES	7811	-	BPR6EIX	6637

* Bitte Elektrodenabstand nach Angaben des Herstellers justieren

* Please adjust the groundelectrode gap

* Veuillez vérifier L' écartement

* Por favor, ajustar distancia entre electrodos

* regolare il gap

C
Y
L

0201



Stock-№

Quick-№



Stock-№ IX

BMW

R-100 RT	1000	2	-	0,6	BP7ES	2412	Q206	BPR7EIX	4055
R-100 RT 2478	1000	2	1987-1996	0,6	BP6ES	7811	-	BPR6EIX	6637
S-RR HP4 K42	1000	4	2011-	0,8	LMAR9D-J	1633	-	-	-
S-RR K46 10	1000	4	2008-2011	0,8	LMAR9D-J	1633	-	-	-
S-RR K46 12	1000	4	2010-	0,8	LMAR9D-J	1633	-	-	-
K-LT	1100	4	1991-1999	0,5	DCPR7E	3932	-	DCPR7EIX	6046
K-LT Special Edition	1100	4	1992-1999	0,5	DR7EA	7839	-	DR7EIX	5686
R 259R 94	1100	2	1993-2001	0,8	BCPR7ET	2164	-	BCPR7EIX	5690
R-GS 259E 94	1100	2	1993-2000	0,8	BCPR7ET	2164	-	BCPR7EIX	5690
RS 259S 93	1100	2	1992-2001	0,8	BCPR7ET	2164	-	BCPR7EIX	5690
R-S 259S 98	1100	2	1996-2002	0,8	BKR6EKC	2848	-	BKR6EIX	6418
R-S 259S 98 (Twin Spark)	1100	2	2003-2005	0,8; 0,8	BKR7EKC; DCPR8EKC	7354; 7168	-	BKR7EIX; DCPR8EIX	2667; 6546
R-S 72kW (non Twin Spark)	1100	2	1998-2003	0,8	BKR7EKC	7354	-	BKR7EIX	2667
R-S Boxer Cup (non Twin Spark)	1100	2	2002-2003	0,8	BKR7EKC	7354	-	BKR7EIX	2667
RS K589 89V2	1100	4	1992-1997	0,6	DCPR7E	3932	-	DCPR7EIX	6046
RT	1100	2	1995-2000	0,8	BKR6EKC	2848	-	BKR6EIX	6418
R R28 01	1150	2	1999-2002	0,8	BKR7EKC	7354	-	BKR7EIX	2667
R R28 01 (Twin Spark)	1150	2	2002-2006	0,8; 0,8	BKR7EKC; DCPR8EKC	7354; 7168	-	BKR7EIX; DCPR8EIX	2667; 6546
R Rockster R28 (Twin Spark)	1150	2	2002-2005	0,8; 0,8	BKR7EKC; DCPR8EKC	7354; 7168	-	BKR7EIX; DCPR8EIX	2667; 6546
R-GS Adventure R21A	1150	2	2002-2003	0,8	BKR7EKC	7354	-	BKR7EIX	2667
R-GS Adventure R21A (Twin Spark)	1150	2	2003-2005	0,8; 0,8	BKR7EKC; DCPR8EKC	7354; 7168	-	BKR7EIX; DCPR8EIX	2667; 6546
R-GS R21 00	1150	2	1999-2002	0,8	BKR7EKC	7354	-	BKR7EIX	2667
R-GS R21 00 (Twin Spark)	1150	2	2003-	0,8; 0,8	BKR7EKC; DCPR8EKC	7354; 7168	-	BKR7EIX; DCPR8EIX	2667; 6546
RS R22 01	1150	2	2000-2002	0,8	BKR7EKC	7354	-	BKR7EIX	2667
RS R22 01 (Twin Spark)	1150	2	2003-2004	0,8; 0,8	BKR7EKC; DCPR8EKC	7354; 7168	-	BKR7EIX; DCPR8EIX	2667; 6546
RT R22 00	1150	2	2001-2003	0,8	BKR7EKC	7354	-	BKR7EIX	2667
RT R22 00 (Twin Spark)	1150	2	2003-2006	0,8; 0,8	BKR7EKC; DCPR8EKC	7354; 7168	-	BKR7EIX; DCPR8EIX	2667; 6546
R-GS (LC)	1170	2	2013-	*	LMAR8D-J	93444	-	-	-
GT K41 01	1200	4	2003-2005	0,6	DCPR7E	3932	-	DCPR7EIX	6046
GT K44	1200	4	2006-2008	0,8	KR9CI	7795	-	-	-
HP2- (Twin Spark)	1200	2	2005-	0,8; 0,8	BKR7EKC; DCPR8EKC	7354; 7168	-	BKR7EIX; DCPR8EIX	2667; 6546
HP2-Enduro K25	1200	2	2004-2006	0,8	DCPR8EKC	7168	-	DCPR8EIX	6546
HP2-Megamoto K25	1200	2	2006-2008	0,9	DCPR8EKC	7168	-	DCPR8EIX	6546
HP2-Sport K29	1200	2	2007-2010	0,8	MAR9B-JDS	1316	-	-	-
K-R Twinspark	1200	4	2005-	0,9	DCPR8EKC	7168	-	DCPR8EIX	6546
LT K589 89V3 99	1200	4	1997-2004	0,6	DCPR7E	3932	-	DCPR7EIX	6046
R K27 06	1200	2	2007-2010	0,9	DCPR8EKC	7168	-	DCPR8EIX	6546
R K27 11	1200	2	2010-	0,8	MAR8B-JDS	8765	-	-	-
R K43	1200	4	2004-2008	0,8	KR9CI	7795	-	-	-
R Sport K43	1200	4	2005-2007	0,8	KR9CI	7795	-	-	-
R-C 259C 59C1 03 (Twin Spark)	1200	2	2003-2009	0,8; 0,8	BKR7EKC; DCPR8EKC	7354; 7168	-	BKR7EIX; DCPR8EIX	2667; 6546
R-C 259C 59C1 97	1200	4	1996-2003	0,8	BKR6EKC	2848	-	BKR6EIX	6418
R-C Independent 259C 59C3 00	1200	4	2000-2003	0,8	BKR6EKC	2848	-	BKR6EIX	6418

* Bitte Elektrodenabstand nach Angaben des Herstellers justieren

* Please adjust the groundelectrode gap

* Veuillez vérifier L' écartement

* Por favor, ajustar distancia entre electrodos

* regolare il gap

C
Y
L

Stock-No

Quick-No



Stock-No IX

BMW

R-C Montauk 259C 59C2 03 (Twin Spark)	1200	4	2002-2004	0,8; 0,8	BKR7EKC; DCPR8EKC	7354; 7168	-	BKR7EIX; DCPR8EIX	2667; 6546
R-CL K30	1200	4	2001-2003	0,8	BKR7EKC	7354	-	BKR7EIX	2667
R-CL K30 (Twin Spark)	1200	4	2003-2004	0,8; 0,8	BKR7EKC; DCPR8EKC	7354; 7168	-	BKR7EIX; DCPR8EIX	2667; 6546
R-GS Adventure K25 06	1200	2	2005-2007	0,8	DCPR8EKC	7168	-	DCPR8EIX	6546
R-GS Adventure K25 08	1200	2	2006-2009	0,8	DCPR8EKC	7168	-	DCPR8EIX	6546
R-GS Adventure K25 10	1200	2	2008-2013	0,8	MAR8B-JDS	8765	-	-	-
R-GS DOHC Twinspark 110kW	1200	2	2010-	0,8	MAR8B-JDS	8765	-	-	-
R-GS K25 04	1200	2	2002-2007	0,8	DCPR8EKC	7168	-	DCPR8EIX	6546
R-GS K25 08	1200	2	2004-2009	0,8	DCPR8EKC	7168	-	DCPR8EIX	6546
R-GS K25 10	1200	2	2010-2013	0,8	MAR8B-JDS	8765	-	-	-
R-GS K50	1200	2	2011-	0,8	LMAR8D-J	93444	-	-	-
R-GS Rallye	1200	4	2012-	0,8	MAR8B-JDS	8765	-	-	-
R-S K29	1200	2	2004-2007	0,8	DCPR8EKC	7168	-	DCPR8EIX	6546
RS K589 89V3 97	1200	4	1996-2001	0,6	DCPR7E	3932	-	DCPR7EIX	6046
R-ST K28	1200	2	2003-2007	0,8	DCPR8EKC	7168	-	DCPR8EIX	6546
RT DOHC Twinspark 110kW	1200	2	2010-	0,8	MAR8B-JDS	8765	-	-	-
RT K26 05	1200	2	2005-2009	0,8	DCPR8EKC	7168	-	DCPR8EIX	6546
RT K26 10	1200	2	2008-	0,8	MAR8B-JDS	8765	-	-	-
S K	1200	4	2005-	0,9	DCPR8EKC	7168	-	DCPR8EIX	6546
S K40	1200	4	2003-2008	0,8	KR9CI	7795	-	-	-
GT K44	1300	4	2007-2010	0,8	KR9CI	7795	-	-	-
K-S Pack HP	1300	4	2012-	0,8	KR9CI	7795	-	-	-
R K43	1300	4	2007-	0,8	KR9CI	7795	-	-	-
S K40	1300	4	2007-	0,8	KR9CI	7795	-	-	-
GT K48	1600	6	2010-	0,8	LMAR8AI-8	92288	-	-	-
GTL K48	1600	6	2010-	0,8	LMAR8AI-8	92288	-	-	-

BOOM TRIKE

Classic Trike Chopper VW-(Carburetor with power increase)	1600	4	-	0,6	B7HS	5110	Q204	BR7HIX	7067
Classic Trike Chopper VW-(Carburetor w/o power increase)	1600	4	-	0,6	B6HS	4510	Q203	BR6HIX	3419
Classic Trike Chopper VW-inj. with power increase	1600	4	-	0,8	BP5ES-A	2285	-	BPR5EIX	6597
Classic Trike Family VW-(Carburetor with power increase)	1600	4	-	0,6	B7HS	5110	Q204	BR7HIX	7067
Classic Trike Family VW-(Carburetor w/o power increase)	1600	4	-	0,6	B6HS	4510	Q203	BR6HIX	3419
Classic Trike Family VW-inj. with power increase	1600	4	-	0,8	BP5ES-A	2285	-	BPR5EIX	6597
Classic Trike Low Rider VW-(Carburetor with power increase)	1600	4	-	0,6	B7HS	5110	Q204	BR7HIX	7067
Classic Trike Low Rider VW-(Carburetor w/o power increase)	1600	4	-	0,6	B6HS	4510	Q203	BR6HIX	3419
Classic Trike Low Rider VW-inj. with power increase	1600	4	-	0,8	BP5ES-A	2285	-	BPR5EIX	6597
Fighter Automatic FORD Engine	1600	4	-	1,3	PTR5A-13	2467	-	-	-
Fighter Automatic FORD Engine	2000	4	-	1,3	PTR5A-13	2467	-	-	-

BRUDELI

Leanster 654L	690		2009-	0,9	LKAR8AI-9	6706	-	-	-
---------------	-----	--	-------	-----	------------------	-------------	---	---	---

BS VILLA

Giomo	50	1	-	0,6	BR8HSA	5539	-	BR8HIX	7001
GP Dio	50	1	1990-	0,6	BPR8HS	3725	-	BPR8HIX	6742
SP Dio	50	1	-	0,6	BPR7HS	6422	Q215	BPR7HIX	5944
Z5	50	1	1993-	0,6	BR8HSA	5539	-	BR8HIX	7001

* Bitte Elektrodenabstand nach Angaben des Herstellers justieren

* Please adjust the groundelectrode gap

* Veuillez vérifier L' écartement

* Por favor, ajustar distancia entre electrodos

* regolare il gap

C
y
l

0201



Stock-№

Quick-№



Stock-№ IX

BS VILLA

ZX	50	1	1993-	0,6	BR8HSA	5539	-	BR8HIX	7001
----	----	---	-------	-----	--------	------	---	--------	------

BSM (BIKER STREET MOTORS)

City	50	1	1999-2001	0,7	BPR7HS	6422	Q215	BPR7HIX	5944
Off Road	50	1	1999-2001	0,7	BPR7HS	6422	Q215	BPR7HIX	5944
Thunderbike	50	1	1999-	0,7	BPR7HS	6422	Q215	BPR7HIX	5944
Winner	50	1	1999-	0,7	BPR7HS	6422	Q215	BPR7HIX	5944
Thunderbike 2 Stroke	100	1	1999-	0,7	BPR7HS	6422	Q215	BPR7HIX	5944
FT	125	1	1999-	0,6	DR8EA	7162	-	DR8EIX	6681
Thunderbike 4 Stroke	125	1	1999-	0,7	CR7HSA	4549	-	CR7HIX	7544

BUELL

XB-9R-Firebolt	984	2	2002-	0,9	DPR9EA-9	5329	Q222	DPR9EIX-9	5545
XB-9R-Lightning	984	2	2002-	0,9	DPR9EA-9	5329	Q222	DPR9EIX-9	5545
XB-9S-Firebolt	984	2	2002-	0,9	DPR9EA-9	5329	Q222	DPR9EIX-9	5545
XB-9S-Lightning	984	2	2002-	0,9	DPR9EA-9	5329	Q222	DPR9EIX-9	5545
XB9-SX-Lightning CityX	984		2005-	0,9	DCPR9E	2641	-	DCPR9EIX	2316
XB9X -City X	984		2009-	0,9	DCPR9E	2641	-	DCPR9EIX	2316
RR	1000	2	1987-1988	1,0	DCPR7E	3932	-	DCPR7EIX	6046
XB9R	1000	2	2001-2007	0,9	DCPR9E	2641	-	DCPR9EIX	2316
XB9S	1000	2	2003-2007	0,9	DCPR9E	2641	-	DCPR9EIX	2316
XB9SX	1000	2	2005-2007	0,9	DCPR9E	2641	-	DCPR9EIX	2316
Café Racer	1125	2	2008-	0,7	CR9EKB	2305	-	CR9EIX	3521
R	1125	2	2008-	0,7	CR9EKB	2305	-	CR9EIX	3521
M2-Cyclone	1200	2	1997-2003	0,9	DCPR8E	4339	-	DCPR8EIX	6546
RSS	1200	2	1989-1994	1,0	DCPR8E	4339	-	DCPR8EIX	6546
S1-Lightning	1200	2	1996-1997	0,9	DCPR8E	4340	-	DCPR8EIX	6546
S1-W White Lightning	1200	2	1998-2009	0,9	DCPR8E	4341	-	DCPR8EIX	6546
S2-Thunderbolt	1200	2	1995-1996	1,0	DCPR8E	4342	-	DPR9EIX-9	2202
S3-Thunderbolt, Touring	1200	2	1997-2010	0,9	DCPR8E	4343	-	DCPR8EIX	6546
X1-Lightning	1200	2	1999-2003	0,9	DCPR8E	4344	-	DCPR8EIX	6546
XB-12R-Firebolt	1200	2	1999-2010	0,9	DCPR9E	2641	-	DCPR9EIX	2316
XB-12S	1200	2	2004-2007	0,9	DCPR9E	2641	-	DCPR9EIX	2316
XB-12SCG-Lightning	1200	2	2007-2010	0,9	DCPR9E	2641	-	DCPR9EIX	2316
XB-12SS-Lightning	1200	2	2006-2007	0,9	DCPR9E	2641	-	DCPR9EIX	2316
XB-12STT-Lightning	1200		2007-	0,9	DCPR9E	2641	-	DCPR9EIX	2316
XB-12SX -Lightning City X	1200	2	-	0,6	DCPR9E	2641	-	DCPR9EIX	2316
XB-12XT	1200	2	2008-2010	0,9	DCPR9E	2641	-	DCPR9EIX	2316
XB-12X-Ulysse	1200	2	2006-2007	0,9	DCPR9E	2641	-	DCPR9EIX	2316

BULTACO

49	50	1	-	0,5	B5HS	4210	-	-	-
Astro	50	1	1998-	0,5	B9ES	2611	Q202	BR9EIX	3981
Astro Supermotard	50	1	2000-	0,6	B9ES	2611	Q202	BR9EIX	3981
Chispa	50	1	-	0,5	B5HS	4210	-	-	-
GT	50	1	-	0,5	B5HS	4210	-	-	-
Lobito	50	1	1998-	0,5	B9ES	2611	Q202	BR9EIX	3981
Lobito Enduro	50	1	1999-	0,6	B9ES	2611	Q202	BR9EIX	3981
Tiron	50	1	-	0,5	B5HS	4210	-	-	-

* Bitte Elektrodenabstand nach Angaben des Herstellers justieren

* Please adjust the groundelectrode gap

* Veuillez vérifier L' écartement

* Por favor, ajustar distancia entre electrodos

* regolare il gap

C
Y
L

0201



Stock-No

Quick-No



Stock-No IX

BULTACO

Brinco	75	1	-	0,5	B7HS	5110	Q204	BR7HIX	7067
Frontera	75	1	-	0,5	B8HS	5510	Q205	BR8HIX	7001
Junior GT2	75	1	-	0,5	B7HS	5110	Q204	BR7HIX	7067
Lobito	75	1	-	0,5	B6HS	4510	Q203	BR6HIX	3419
Sherpa T	75	1	-	0,5	B6HS	4510	Q203	BR6HIX	3419
Streaker	75	1	-	0,5	B6HS	4510	Q203	BR6HIX	3419
Junior	100	1	-	0,5	B6HS	4510	Q203	BR6HIX	3419
Lobito	100	1	-	0,5	B6HS	4510	Q203	BR6HIX	3419
Lobito K	100	1	-	0,5	B9HS	5810	-	BR9HIX	5687
Sherpa S	100	1	-	0,5	B9HS	5810	-	BR9HIX	5687
Tiron	100	1	-	0,5	B6HS	4510	Q203	BR6HIX	3419
Alpina	125	1	-	0,5	BP5ES	6511	-	BPR5EIX	6597
Frontera	125	1	-	0,5	B6HS	4510	Q203	BR6HIX	3419
Junior	125	1	-	0,5	B6HS	4510	Q203	BR6HIX	3419
Lobito MK3	125	1	-	0,5	BP5ES	6511	-	BPR5EIX	6597
Lobito MK6	125	1	-	0,5	BP5ES	6511	-	BPR5EIX	6597
Lobito MK7	125	1	-	0,5	B6HS	4510	Q203	BR6HIX	3419
Mercurio	125	1	-	0,5	B6HS	4510	Q203	BR6HIX	3419
Pursang MK5	125	1	-	0,5	B10EG	3630	-	-	-
Pursang MK6	125	1	-	0,5	B9EG	3530	-	-	-
Sherco	125	1	2000-	0,6	BPR5ES	7422	-	BPR5EIX	6597
Sherpa S	125	1	-	0,5	B9EG	3530	-	-	-
Sherpa T	125	1	-	0,5	B6HS	4510	Q203	BR6HIX	3419
Streaker	125	1	-	0,5	B6HS	4510	Q203	BR6HIX	3419
Tralla	125	1	-	0,5	B6HS	4510	Q203	BR6HIX	3419
Campera	150	1	-	0,5	B6HS	4510	Q203	BR6HIX	3419
Mercurio	150	1	-	0,5	B6HS	4510	Q203	BR6HIX	3419
Mercurio GT	150	1	-	0,5	B6HS	4510	Q203	BR6HIX	3419
Tralla	150	1	-	0,5	B6HS	4510	Q203	BR6HIX	3419
Alpina	175	1	-	0,5	BP5ES	6511	-	BPR5EIX	6597
Campera MK2	175	1	-	0,5	B5ES	6410	-	-	-
Lobito MK6	175	1	-	0,5	BP5ES	6511	-	BPR5EIX	6597
Lobito MK7	175	1	-	0,5	B5ES	6410	-	-	-
Mercurio	175	1	-	0,5	B6HS	4510	Q203	BR6HIX	3419
Mercurio GT	175	1	-	0,5	BP5ES	6511	-	BPR5EIX	6597
Pursang MK5	175	1	-	0,5	B9EG	3530	-	-	-
Sherpa MK3	175	1	-	0,5	B9EG	3530	-	-	-
El Tigre	200	1	-	0,5	B8ES	2411	Q201	BR8EIX	5044
Go Kart	200	1	-	0,5	B9EG	3530	-	-	-
Mercurio	200	1	-	0,5	B8ES	2411	Q201	BR8EIX	5044
Metise	200	1	-	0,5	B8ES	2411	Q201	BR8EIX	5044
Pursang MK5	200	1	-	0,5	B9EG	3530	-	-	-
Senior	200	1	-	0,5	B8ES	2411	Q201	BR8EIX	5044
Sherco	200	1	2000-	0,6	BPR5ES	7422	-	BPR5EIX	6597
Sherpa MK3	200	1	-	0,5	B9EG	3530	-	-	-
Sherpa S	200	1	-	0,5	B7ES	1111	-	BR7EIX	6664
Alpina	250	1	-	0,5	BP5ES	6511	-	BPR5EIX	6597
Astro	250	1	-	0,5	B9EG	3530	-	-	-
Frontera	250	1	-	0,5	B8ES	2411	Q201	BR8EIX	5044
Matador 250	250	1	-	0,5	BP5ES	6511	-	BPR5EIX	6597
Matador 250 SD	250	1	-	0,5	BP5ES	6511	-	BPR5EIX	6597
Matador MK2	250	1	-	0,5	B8ES	2411	Q201	BR8EIX	5044

* Bitte Elektrodenabstand nach Angaben des Herstellers justieren

* Please adjust the groundelectrode gap

* Veuillez vérifier L' écartement

* Por favor, ajustar distancia entre electrodos

* regolare il gap

C
y
l

0201



Stock-Nº

Quick-Nº



Stock-Nº IX

BULTACO

Matador MK3	250	1	-	0,5	B8ES	2411	Q201	BR8EIX	5044
Matador MK4	250	1	-	0,5	BP6ES	7811	-	BPR6EIX	6637
Metralla GT	250	1	-	0,5	B8ES	2411	Q201	BR8EIX	5044
Metralla GTS	250	1	-	0,5	BP5ES	6511	-	BPR5EIX	6597
Metralla MK2	250	1	-	0,5	B8ES	2411	Q201	BR8EIX	5044
Metralla MK250	250	1	-	0,5	B8ES	2411	Q201	BR8EIX	5044
Pursang MK4/MK5 lado admis.	250	1	-	0,5	B8ES	2411	Q201	BR8EIX	5044
Pursang MK4/MK5 lado escape	250	1	-	0,5	B9EG	3530	-	-	-
Pursang MK6/MK7 lado admis.	250	1	-	0,5	B8ES	2411	Q201	BR8EIX	5044
Pursang MK6/MK7 lado escape	250	1	-	0,5	B9EG	3530	-	-	-
Sherco	250	1	1999-	0,6	BPR5ES	7422	-	BPR5EIX	6597
Sherpa S	250	1	-	0,5	B9EG	3530	-	-	-
Sherpa T	250	1	-	0,5	BP5ES	6511	-	BPR5EIX	6597
Sherco	290	1	2000-	0,6	BPR5ES	7422	-	BPR5EIX	6597
Alpina	350	1	-	0,5	BP5ES	6511	-	BPR5EIX	6597
Matador MK10	350	1	-	0,5	BP5ES	6511	-	BPR5EIX	6597
Matador MK9	350	1	-	0,5	BP5ES	6511	-	BPR5EIX	6597
Pursang MK5/MK6 lado admis.	350	1	-	0,5	B8ES	2411	Q201	BR8EIX	5044
Pursang MK5/MK6 lado escape	350	1	-	0,5	B9EG	3530	-	-	-
Sherpa T	350	1	-	0,5	BP5ES	6511	-	BPR5EIX	6597
Astro lado admision	360	1	-	0,5	B8ES	2411	Q201	BR8EIX	5044
Astro lado escape	360	1	-	0,5	B9EG	3530	-	-	-
El Bandito MK2 lado admis.	360	1	-	0,5	B8ES	2411	Q201	BR8EIX	5044
El Bandito MK2 lado escape	360	1	-	0,5	B9EG	3530	-	-	-
Frontera	360	1	-	0,5	B8ES	2411	Q201	BR8EIX	5044
Pursang lado admision	360	1	-	0,5	B8ES	2411	Q201	BR8EIX	5044
Pursang lado escape	360	1	-	0,5	B9EG	3530	-	-	-
Frontera MK11	370	1	-	0,5	B8ES	2411	Q201	BR8EIX	5044
Pursang lado admision	370	1	-	0,5	B8ES	2411	Q201	BR8EIX	5044
Pursang lado escape	370	1	-	0,5	B9EG	3530	-	-	-
Pursang MK15	450	1	-	0,5	B8ES	2411	Q201	BR8EIX	5044

CAGIVA

City	50	1	1993-1993	0,5	B7HS	5110	Q204	BR7HIX	7067
City	50	1	1994-1997	0,6	BPR8HS	3725	-	BPR8HIX	6742
City	50	1	1998-	0,5	BR8HSA	5539	-	BR8HIX	7001
City L.E.	50	1	1993-	0,5	B7HS	5110	Q204	BR7HIX	7067
Cocis	50	1	-	0,5	B8ES	2411	Q201	BR8EIX	5044
Cucciolo	50	1	-	0,6	B8HS	5510	Q205	BR8HIX	7001
K3	50	1	-	0,5	B8ES	2411	Q201	BR8EIX	5044
Mantis	50	1	1999-	0,5	B9ES	2611	Q202	BR9EIX	3981
Mito	50	1	-	0,5	B10ES	7928	-	BR10EIX	6801
Passing	50	1	-	0,6	BP6HS	4511	-	BPR6HIX	4085
Prima	50	1	-	0,5	B8ES	2411	Q201	BR8EIX	5044
Progress 50	50	1	-	0,6	B8HS	5510	Q205	BR8HIX	7001

* Bitte Elektrodenabstand nach Angaben des Herstellers justieren

* Please adjust the groundelectrode gap

* Veuillez vérifier L' écartement

* Por favor, ajustar distancia entre electrodos

* regolare il gap

C
Y
L

Stock-No

Quick-No



Stock-No IX

CAGIVA

Progress Corsa	50	1	-	0,6	B9ES	2611	Q202	BR9EIX	3981
Scooter	50	1	-	0,7	BR8HSA	5539	-	BR8HIX	7001
Supercity	50	1	-	0,5	B8ES	2411	Q201	BR8EIX	5044
W4	50	1	-	0,5	B8ES	2411	Q201	BR8EIX	5044
Cocis	75	1	-	0,5	B8ES	2411	Q201	BR8EIX	5044
Prima 80	75		1992-	0,5	B8ES	2411	Q201	BR8EIX	5044
Supercity 80	75		1992-	0,5	B8ES	2411	Q201	BR8EIX	5044
W4 80	75		1992-	0,5	B8ES	2411	Q201	BR8EIX	5044
A8 Trail	125	1	-	0,5	B9ES	2611	Q202	BR9EIX	3981
Aletta Electra, Oro	125	1	1984-	0,5	B9ES	2611	Q202	BR9EIX	3981
Aletta Oro 125 S1/S2	125	1	1985-1985	0,5	B9EG	3530	-	-	-
Aletta Rossa	125	1	-	0,5	B9EG	3530	-	-	-
Blues	125	1	-	0,5	B9ES	2611	Q202	BR9EIX	3981
Blues, C10, Cruiser	125	1	1987-	0,5	B9ES	2611	Q202	BR9EIX	3981
Cucciolo	125	1	2000-	0,7	CR9EB	6955	-	CR9EIX	3521
Dakar	125	1	-	0,5	B9EG	3530	-	-	-
Elefant 2	125	1	-	0,5	B9EG	3530	-	-	-
Elefant 3	125	1	1987-	0,5	B9ES	2611	Q202	BR9EIX	3981
Freccia Series	125	1	1987-	0,6	B9ES	2611	Q202	BR9EIX	3981
K7	125	1	-	0,5	B95EGV	2145	-	-	-
Mito 125	125		1991-	0,6	BR9EG	3230	-	-	-
Mito E.V.	125	1	1998-	0,5	BR9EG	3230	-	-	-
Mito Racing	125	1	-	0,5	B95EGV	2145	-	-	-
Mito SP525	125	1	2008-	0,5	BR9EG	3230	-	-	-
Mito, Mito E.V.	125	1	1995-	0,5	B95EGV	2145	-	-	-
N-90	125	1	1990-	0,5	B9ES	2611	Q202	BR9EIX	3981
Nuvola	125	1	-	0,7	CR7E	4578	Q225	CR7EIX	7385
Passing	125	1	1994-1995	0,6	BP6HS	4511	-	BPR6HIX	4085
Planet	125	1	1998-2003	0,5	BR9EG	3230	-	-	-
Raptor 125	125	1	2004-	0,5	BR9EG	3230	-	-	-
RL, SS, SX	125	1	-	0,5	B8ES	2411	Q201	BR8EIX	5044
Roadster, Roadster 521	125	1	-	0,5	B9ES	2611	Q202	BR9EIX	3981
RX, WRX, WSXT	125	1	1982-1983	0,5	B9EG	3530	-	-	-
Supercity	125	1	1999-	0,5	BR9EG	3230	-	-	-
W8-R, Supermotard	125	1	1996-	0,5	B9ES	2611	Q202	BR9EIX	3981
RX-Rally	250	1	1979-1983	0,5	B9EG	3530	-	-	-
WMX	250		-	0,5	B9ES	2611	Q202	BR9EIX	3981
Ala Blu 350	350	1	-	0,5	B8ES	2411	Q201	BR8EIX	5044
Ala Verde 350	350	1	-	0,5	B8ES	2411	Q201	BR8EIX	5044
Elefant 350	350	1	-	0,5	BP7HS	5111	-	BPR7HIX	5944
Indiana 350	350		-	0,5	BP7HS	5111	-	BPR7HIX	5944
Lucky 350	350	1	-	0,9	DP8EA-9	5829	-	DPR8EIX-9	2202
SST 350	350	1	-	0,5	B8ES	2411	Q201	BR8EIX	5044
T4 500 E, R	450	1	-	0,9	DP8EA-9	5829	-	DPR8EIX-9	2202
Canyon	500	1	-	0,6	DCPR8E	4339	-	DCPR8EIX	6546
Canyon 500 12mm	500	1	-	0,8	DCPR7E	3932	-	DCPR7EIX	6046
Mito	500	1	2007-	0,7	CR8EB	7784	-	CR8EIX	4218
MXR	500	1	-	0,5	B95EGV	2145	-	-	-
River 500	500		1999-	0,6	DCPR8E	4179	-	DCPR8EIX	6546
Canyon 600	600	1	1998-	0,8	BCP7ES	5030	-	BCPR7EIX	5690
Canyon, Canyon L.W.	600		1996-1997	0,7	-	-	-	BKR7EIX	2667

* Bitte Elektrodenabstand nach Angaben des Herstellers justieren

* Please adjust the groundelectrode gap

* Veuillez vérifier L' écartement

* Por favor, ajustar distancia entre electrodos

* regolare il gap

C
Y
L

0201



Stock-№

Quick-№



Stock-№ IX

CAGIVA

River	600		1995-	0,7	C7E	5096	-	CR7EIX	7385
W16	600	1	1994-	0,7	-	-	-	BKR7EIX	2667
Ala Assura	650		1994-	0,6	BP7HS	5111	-	BPR7HIX	5944
Elefant	650		1985-1988	0,5	BP7HS	5111	-	BPR7HIX	5944
Indiana	650		-	0,5	BP7HS	5111	-	BPR7HIX	5944
Raptor	650	2	2000-	0,7	CR8E	1275	Q226	CR8EIX	4218
V-Raptor	650	2	2000-	0,7	CR8E	1275	Q226	CR8EIX	4218
Elefant	750	2	1994-1997	0,9	DPR8EA-9	4929	Q221	DPR8EIX-9	2202
Elefant 750 Lucky	750	2	1987-1990	0,9	DPR8EA-9	4929	Q221	DPR8EIX-9	2202
Indiana	750		-	0,5	BP7HS	5111	-	BPR7HIX	5944
Elefant 900 AC	900	2	1993-1997	0,9	DPR9EA-9	5329	Q222	DPR9EIX-9	5545
Elefant, ie, GT	900	2	1990-1996	0,9	DPR9EA-9	5329	Q222	DPR9EIX-9	5545
Gran Canyon	900	2	1998-2000	0,6	DCPR8E	4339	-	DCPR8EIX	6546
Navigator	1000	2	1999-	0,7	CR8EK	3478	-	CR8EIX	4218
Navigator T	1000	2	2000-	0,7	CR8EK	3478	-	CR8EIX	4218
Raptor	1000	2	1999-	0,7	CR8EK	3478	-	CR8EIX	4218
V-Raptor	1000	2	2000-	0,7	CR8EK	3478	-	CR8EIX	4218
V-Raptor Xtra	1000	2	2003-	0,7	CR8EK	3478	-	CR8EIX	4218

CAN-AM

GP	250	1	-1982	0,5	B9ES	2611	Q202	BR9EIX	3981
MX	250	1	-1982	0,5	B9ES	2611	Q202	BR9EIX	3981
Qualifier	250	1	-1982	0,5	B9ES	2611	Q202	BR9EIX	3981
TNT	250	1	-1982	0,5	B9ES	2611	Q202	BR9EIX	3981
MX-4	370	1	-	0,5	B9ES	2611	Q202	BR9EIX	3981
MX-5	370	1	-	0,5	B9ES	2611	Q202	BR9EIX	3981
Qualifier	370	1	-	0,5	B9ES	2611	Q202	BR9EIX	3981
MX400	400	1	-	0,5	B9ES	2611	Q202	BR9EIX	3981
MX6	400	1	-	0,5	B9ES	2611	Q202	BR9EIX	3981
Qualifier	400	1	-	0,5	B9ES	2611	Q202	BR9EIX	3981
500 Sonic	500	1	-	0,5	D8EA	2120	Q216	DR8EIX	6681
Sonic MX	500	1	-	0,5	D8EA	2120	Q216	DR8EIX	6681
Spyder	1000	2	2008-	0,7	DCPR9E	2641	-	DCPR9EIX	2316
Spyder Roadster	1000	2	2008-	0,6	DCPR9E	2641	-	DCPR9EIX	2316

CARABELA

Carrera	50	1	-	0,5	BP5HS	4111	-	-	-
Super De Luxe	50	1	-	0,5	BP5HS	4111	-	-	-
Super SP	50	1	-	0,5	BP5HS	4111	-	-	-
Ciclo Motor Ciao	60	1	-	0,5	B6HS	4510	Q203	BR6HIX	3419
Merida, Mototic, Motopony	60	1	-	0,5	B6HS	4510	Q203	BR6HIX	3419
Coyote Enduro	100	1	-	0,5	B6ES	7310	-	-	-
Coyote MX	100	1	-	0,6	B7ES	1111	-	BR7EIX	6664
Enduro , MX	100	1	-	0,5	B6HS	4510	Q203	BR6HIX	3419
Marquesa MX	100	1	-	0,6	B8ES	2411	Q201	BR8EIX	5044
Mini Moto	100	1	-	0,5	B6ES	7310	-	-	-
Panthera	100	1	-	0,5	B6HS	4510	Q203	BR6HIX	3419
Panthera100,Sprint 100, TS-3 100	100	1	-	0,5	B6ES	7310	-	-	-
Torero Flat Track	100	1	-	0,6	B8ES	2411	Q201	BR8EIX	5044
Coyote Enduro	125	1	-	0,5	B6ES	7310	-	-	-
Coyote MX	125	1	-	0,6	B7ES	1111	-	BR7EIX	6664
Marquesa	125	1	-	0,6	B8ES	2411	Q201	BR8EIX	5044

* Bitte Elektrodenabstand nach Angaben des Herstellers justieren

* Please adjust the groundelectrode gap

* Veuillez vérifier L' écartement

* Por favor, ajustar distancia entre electrodos

* regolare il gap

C
Y
L

0201



Stock-No

Quick-No



Stock-No IX

CARABELA

Torero Flat Track	125	1	-	0,6	B8ES	2411	Q201	BR8EIX	5044
Marquesa	175	1	-	0,6	B8ES	2411	Q201	BR8EIX	5044
Strada	175	1	-	0,5	B6ES	7310	-	-	-
Centauro MX-III	360	1	-	0,6	B8ES	2411	Q201	BR8EIX	5044
MX	400	1	-	0,6	B8ES	2411	Q201	BR8EIX	5044
Centauro MX-II	450	1	-	0,6	B8ES	2411	Q201	BR8EIX	5044
Torero Flat Track	450	1	-	0,6	B7ES	1111	-	BR7EIX	6664

CARREFOUR

Web-Gap	50	1	2000-	0,7	B7HS	5110	Q204	BR7HIX	7067
VSX-PFM	125	1	2000-	0,6	DR8EA	7162	-	DR8EIX	6681

CASAL

Super Boss RE	50	1	1999-	0,7	B9HS	5810	-	BR9HIX	5687
---------------	----	---	-------	-----	------	------	---	--------	------

CCM

240 CMT Trails	240	1	-	0,7	BP5ES	6511	-	BPR5EIX	6597
250 CMT Trails	250	1	-	0,7	BP5ES	6511	-	BPR5EIX	6597
310 CMT Trails	310	1	-	0,7	BP5ES	6511	-	BPR5EIX	6597
320 CMT Trails	320	1	-	0,7	BP5ES	6511	-	BPR5EIX	6597
350 CMT Trails	350	1	-	0,7	BP5ES	6511	-	BPR5EIX	6597
404 DS	400		2003-	0,7	CR8E	1275	Q226	CR8EIX	4218
404 E	400		2003-	0,7	CR8E	1275	Q226	CR8EIX	4218
404XC-Trail	400		-	0,7	CR8E	1275	Q226	CR8EIX	4218
FT35	400		2005-	0,7	CR8E	1275	Q226	CR8EIX	4218
R35	400		2006-	0,7	CR8E	1275	Q226	CR8EIX	4218
SR40	400		2007-	0,7	CR8E	1275	Q226	CR8EIX	4218
R35 Factory Big Bore Conversion	434		2006-	0,7	CR8E	1275	Q226	CR8EIX	4218
490 CMX	490	1	-	0,5	B9EG	3530	-	-	-
500 MTT	500	1	-	0,7	DR8EA	7162	-	DR8EIX	6681
560 CCM 2-Stroke	560	1	-	0,7	DR8EA	7162	-	DR8EIX	6681
560 CCM 4-Stroke	560	1	-	0,7	DR8EA	7162	-	DR8EIX	6681
CMX-4 Stroke	560		-	0,5	D8EA	2120	Q216	DR8EIX	6681
604 R	600	1	-	0,7	DR8EA	7162	-	DR8EIX	6681
604 R30	600	1	-	0,7	DR8EA	7162	-	DR8EIX	6681
604 Roadster RS	600	1	2001-	0,7	DR8EA	7162	-	DR8EIX	6681
604 RS	600	1	-	0,7	DR8EA	7162	-	DR8EIX	6681
604 Supermoto Dual Sport	600	1	2001-	0,7	DR8EA	7162	-	DR8EIX	6681
604 Trail Dual Sport	600	1	2001-	0,7	DR8EA	7162	-	DR8EIX	6681
RS	604	1	2000-	0,5	D8EA	2120	Q216	DR8EIX	6681
640 RS	640	1	-	0,7	DR8EA	7162	-	DR8EIX	6681
Dual Sport Trail	644		2000-	0,5	D8EA	2120	Q216	DR8EIX	6681
Dual Supermoto	644		2000-	0,5	D8EA	2120	Q216	DR8EIX	6681
Engine Suzuki	644		2002-	0,7	CR10E	6264	-	CR10EIX	6482
R30	644		2005-	0,7	CR10E	6264	-	CR10EIX	6482
R30 Supermotard	644		2002-	0,5	D8EA	2120	Q216	DR8EIX	6681
644	650	1	2002-	0,7	CR10EK	2360	-	CR10EIX	6482
R30 Supermotard	650	1	2002-	0,7	CR9EK	4548	Q230	CR9EIX	3521
R30 Engine Suzuki	710		2005-	0,7	CR10E	6264	-	CR10EIX	6482

* Bitte Elektrodenabstand nach Angaben des Herstellers justieren

* Please adjust the groundelectrode gap

* Veuillez vérifier l' écartement

* Por favor, ajustar distancia entre electrodos

* regolare il gap

C
y
l

0201



Stock-№

Quick-№



Stock-№ IX

CF

Explorer W 125	125	1	-	0,9	DPR7EA-9	5129	Q220	DPR7EIX-9	7803
Glory 125	125	1	-	0,9	DPR7EA-9	5129	Q220	DPR7EIX-9	7803
Ride Glory 125	125	1	-	0,9	DPR7EA-9	5129	Q220	DPR7EIX-9	7803
Ride W 125	125	1	-	0,9	DPR7EA-9	5129	Q220	DPR7EIX-9	7803
Wallstreet 125	125	1	-	0,9	DPR7EA-9	5129	Q220	DPR7EIX-9	7803

CLIPIC

CJ-E Trial	50	1	2000-	0,5	B10ES	7928	-	BR10EIX	6801
CJ-Trial	50	1	2000-	0,6	B7HS	5110	Q204	BR7HIX	7067
CJ-R Trial	80	1	2000-	0,5	B9ES	2611	Q202	BR9EIX	3981

CPI

Aragon 50	50	1	2006-	0,7	BR7ES	5122	-	BR7EIX	6664
Aragon Mofa	50	1	2007-	0,5	BP7HS	5111	-	BPR7HIX	5944
Bingo FL	50	1	2002-2002	0,6	BR8HSA	5539	-	BR8HIX	7001
Formula R (Euro 1)	50	1	-	0,7	BR7HS	4122	Q211	BR7HIX	7067
Formula R (Euro 2)	50	1	2006-	0,7	BR7ES	5122	-	BR7EIX	6664
GTR	50	1	2003-	0,7	BR7HS	4122	Q211	BR7HIX	7067
GTR	50	1	2005-	0,6	BR10EG	3830	-	-	-
GTS	50	1	2003-	0,7	BR7HS	4122	Q211	BR7HIX	7067
GTS	50	1	2005-	0,6	BR10EG	3830	-	-	-
Hussar SL,FL	50	1	2002-	0,6	BR8HSA	5539	-	BR8HIX	7001
Oliver	50	1	2000-	0,7	BR7ES	5122	-	BR7EIX	6664
Popcorn	50	1	2000-	0,6	BR8HSA	5539	-	BR8HIX	7001
Aragon 125	125	1	2006-	0,6	CR7HSA	4549	-	CR7HIX	7544
GTS	125	1	2003-	0,8	BR7ES	5122	-	BR7EIX	6664
Hussar JU	125	1	2004-	0,6	CR7HSA	4549	-	CR7HIX	7544
X-Large	125	1	2003-	0,8	BR7ES	5122	-	BR7EIX	6664

DAELIM

Cordi	50	1	2004-	0,6	BPR6HS	7022	Q214	BPR6HIX	4085
E-Five	50	1	2003-	0,7	BR8HSA	5539	-	BR8HIX	7001
Message 49	50	1	1998-	0,7	BR8HSA	5539	-	BR8HIX	7001
Message II	50	1	1999-	0,6	BR8HSA	5539	-	BR8HIX	7001
S-Five	50	1	2002-	0,6	BR8HSA	5539	-	BR8HIX	7001
Tapo	50	1	1998-	0,6	BR8HSA	5539	-	BR8HIX	7001
Altino "A.S"	100	1	1998-	0,9	CR8EH-9	5666	Q228	CR8EHIX-9	3797
Delpino 100	100	1	1999-	0,7	B8HS	5510	Q205	BR8HIX	7001
Citi Ace 110	110	1	2003-	0,7	C7HSA	4629	-	CR7HIX	7544
Advance	125	1	1997-	0,9	CR8EH-9	5666	Q228	CR8EHIX-9	3797
Besbi	125	1	2008-	0,7	CR7HSA	4549	-	CR7HIX	7544
Classic	125	1	2000-	0,9	CR8EH-9	5666	Q228	CR8EHIX-9	3797
Daystar	125	1	2000-	0,9	C8EH-9	7473	-	CR8EHIX-9	3797
Evolution	125	1	1997-	0,9	CR8EH-9	5666	Q228	CR8EHIX-9	3797
Evolution VS	125	1	2002-2002	0,9	C8EH-9	7473	-	CR8EHIX-9	3797
Fellow	125	1	1998-1999	0,9	CR8EH-9	5666	Q228	CR8EHIX-9	3797
Freewing 125	125	1	2005-	0,9	CR8EH-9	5666	Q228	CR8EHIX-9	3797
Freewing 125 Fi (Injection)	125	1	2007-	0,9	CR8EH-9	5666	Q228	CR8EHIX-9	3797
History	125	1	2004-	0,9	CR8EH-9	5666	Q228	CR8EHIX-9	3797
NF-Altino 125 ES	125	1	2002-	0,9	C8EH-9	7473	-	CR8EHIX-9	3797

* Bitte Elektrodenabstand nach Angaben des Herstellers justieren

* Please adjust the groundelectrode gap

* Veuillez vérifier L' écartement

* Por favor, ajustar distancia entre electrodos

* regolare il gap

C
Y
L

0201



Stock-No

Quick-No



Stock-No IX

DAELIM

NS	125	1	2008-	0,7	CR7HSA	4549	-	CR7HIX	7544
NS-Fellow	125	1	1998-2000	0,9	CR8EH-9	5666	Q228	CR8EHIX-9	3797
NS-Fellow II	125	1	1998-2000	0,9	CR8EH-9	5666	Q228	CR8EHIX-9	3797
NS-II DLX	125	1	2001-	0,9	CR8EH-9	5666	Q228	CR8EHIX-9	3797
NS-Trans Eagle	125	1	1998-	0,9	CR8EH-9	5666	Q228	CR8EHIX-9	3797
Otello	125	1	2004-	0,9	CR8EH-9	5666	Q228	CR8EHIX-9	3797
Otello 125 Fi Injection	125	1	2007-	0,9	CR8EH-9	5666	Q228	CR8EHIX-9	3797
Othello	125	1	1998-	0,9	CR8EH-9	5666	Q228	CR8EHIX-9	3797
Roadwin	125	1	-	0,9	CR8EH-9	5666	Q228	CR8EHIX-9	3797
Roadwin 125 R	125	1	2007-	0,9	CR9EH-9	7502	Q229	CR9EHIX-9	6216
S2	125	1	2005-2006	0,9	CR8EH-9	5666	Q228	CR8EHIX-9	3797
S2 Freewing	125	1	2005-2006	0,9	CR8EH-9	5666	Q228	CR8EHIX-9	3797
SL-History 125	125	1	-	0,9	CR8EH-9	5666	Q228	CR8EHIX-9	3797
VC-Advance	125	1	1995-	0,9	C8EH-9	7473	-	CR8EHIX-9	3797
VEE	125	1	-	0,9	CR8EH-9	5666	Q228	CR8EHIX-9	3797
VJ-Roadwin	125	1	2003-2004	0,9	CR8EH-9	5666	Q228	CR8EHIX-9	3797
VL-Daystar	125	1	2000-	0,9	CR8EH-9	5666	Q228	CR8EHIX-9	3797
VL-Daystar Classic	125	1	2000-	0,9	CR8EH-9	5666	Q228	CR8EHIX-9	3797
VL-L Daystar	125	1	2002-2002	0,9	C8EH-9	7473	-	CR8EHIX-9	3797
VS-Advance	125	1	1997-1998	0,9	CR8EH-9	5666	Q228	CR8EHIX-9	3797
VS-Evolution	125	1	1999-	0,9	CR8EH-9	5666	Q228	CR8EHIX-9	3797
VT-Evolution	125	1	1998-	0,9	CR8EH-9	5666	Q228	CR8EHIX-9	3797

DAFIER

DFE-QT-5	50	1	-	0,6	CR7HSA	4549	-	CR7HIX	7544
DFE-QT-6	50	1	-	0,6	CR7HSA	4549	-	CR7HIX	7544
DFE-QT-8	50	1	-	0,6	CR7HSA	4549	-	CR7HIX	7544
DFE-T-10A	125	1	-	0,7	DR8EA	7162	-	DR8EIX	6681
DFE-T-10D	125	1	-	0,7	DR8EA	7162	-	DR8EIX	6681
DFE-T-10E	125	1	-	0,7	DR8EA	7162	-	DR8EIX	6681
DFE-T-8A	125	1	-	0,7	DR8EA	7162	-	DR8EIX	6681

DERBI

Aceno	50	1	1998-	0,6	B8HS	5510	Q205	BR8HIX	7001
Antorcha, Coppa, Diablo	50	1	-1991	0,6	B7HS	5110	Q204	BR7HIX	7067
Atlantis 2 Stroke	50	1	2003-	0,6	BR9ES	5722	Q208	BR9EIX	3981
Atlantis 4 Stroke	50		2004-	0,7	CR8EB	7784	-	CR8EIX	4218
Atlantis 4 Stroke	50	1	2007-	0,7	PMR7A	4259	-	-	-
Atlantis Bullet	50	1	2003-	0,6	BR9ES	5722	Q208	BR9EIX	3981
Atlantis City	50	1	2003-	0,6	BR9ES	5722	Q208	BR9EIX	3981
Atlantis LC	50	1	1999-	0,6	B9ES	2611	Q202	BR9EIX	3981
Atlantis O2	50	1	1999-	0,6	B8HS	5510	Q205	BR8HIX	7001
Atlantis Red Bullet	50	1	1999-	0,6	B9ES	2611	Q202	BR9EIX	3981
Aventura 50	50	1	1995-	0,6	B8HS	5510	Q205	BR8HIX	7001
Black Devil	50		2003-	0,6	B8ES	2411	Q201	BR8EIX	5044
Black Edition	50		2002-	0,6	B8ES	2411	Q201	BR8EIX	5044
Black Mini	50		2003-	0,6	CR9E	6263	Q227	CR9EIX	3521
Boulevard 2 Stroke	50	1	2009-	0,6	BR9ES	5722	Q208	BR9EIX	3981
Dirt Boy 10/10	50	1	2003-	0,7	CR9E	6263	Q227	CR9EIX	3521
Dirt Kid 10/12	50	1	2003-	0,7	CR9E	6263	Q227	CR9EIX	3521
DRD 50 Supermoto	50		2002-	0,5	B8ES	2411	Q201	BR8EIX	5044

* Bitte Elektrodenabstand nach Angaben des Herstellers justieren

* Please adjust the groundelectrode gap

* Veuillez vérifier L' écartement

* Por favor, ajustar distancia entre electrodos

* regolare il gap

C
Y
L

0201



Stock-№

Quick-№



Stock-№ IX

DERBI

FDS Super, Start DS	50	1	1992-	0,6	B8HS	5510	Q205	BR8HIX	7001
FDS, GTS, RD-2	50	1	-1991	0,6	B7HS	5110	Q204	BR7HIX	7067
Fenix	50	1	1996-	0,6	B8HS	5510	Q205	BR8HIX	7001
Furax	50	1	1996-	0,6	B8HS	5510	Q205	BR8HIX	7001
GP1	50	1	2003-	0,7	BR10ES	4832	-	BR10EIX	6801
GPR	50	1	2002-	0,5	B8ES	2411	Q201	BR8EIX	5044
GPR	50	1	2009-	0,6	BR8ES	5422	Q207	BR8EIX	5044
GPR-Full power	50	1	2002-	0,6	B9ES	2611	Q202	BR9EIX	3981
GPR-Naked	50	1	2004-	0,7	B8ES	2411	Q201	BR8EIX	5044
GPR-Nude	50	1	-	0,5	B8ES	2411	Q201	BR8EIX	5044
GPR-R, Racing	50	1	2002-	0,5	B8ES	2411	Q201	BR8EIX	5044
GPR-R, Réplica	50	1	1997-	0,6	B10HS	2399	-	BR10HIX	6692
GPR-Replica	50	1	2003-	0,5	B8ES	2411	Q201	BR8EIX	5044
Hunter (D+A)	50	1	1995-	0,6	BP7HS	5111	-	BPR7HIX	5944
Hunter (Spain)	50	1	1995-	0,6	B8HS	5510	Q205	BR8HIX	7001
Manhattan	50	1	-	0,6	B8HS	5510	Q205	BR8HIX	7001
MXR	50	1	1996-	0,6	B8HS	5510	Q205	BR8HIX	7001
Olimpica, Savannah, Start	50	1	-1991	0,6	B7HS	5110	Q204	BR7HIX	7067
Paddock	50	1	1997-	0,6	B8HS	5510	Q205	BR8HIX	7001
Paddock LC	50	1	1998-	0,6	B9ES	2611	Q202	BR9EIX	3981
Predator LC	50	1	1998-	0,6	B9ES	2611	Q202	BR9EIX	3981
Predator O2	50	1	1998-	0,6	B9ES	2611	Q202	BR9EIX	3981
R DRD	50	1	2002-	0,5	B8ES	2411	Q201	BR8EIX	5044
R Racer	50	1	2002-	0,5	B8ES	2411	Q201	BR8EIX	5044
R X-treme	50	1	2002-	0,5	B8ES	2411	Q201	BR8EIX	5044
Racing Replica	50	1	2002-	0,6	BR9ES	5722	Q208	BR9EIX	3981
Rambla 50	50	1	-	0,6	BR9ES	5722	Q208	BR9EIX	3981
RD-2 Country	50	1	1992-	0,6	B8HS	5510	Q205	BR8HIX	7001
RD-2 Country	50	1	1992-	0,6	B8HS	5510	Q205	BR8HIX	7001
Red Bullet	50	1	2003-	0,6	BR9ES	5722	Q208	BR9EIX	3981
Senda (Liquid cooled)	50	1	-	0,6	B8ES	2411	Q201	BR8EIX	5044
Senda DRD EVO 50 SM	50	1	-	0,6	BR8ES	5422	Q207	BR8EIX	5044
Senda DRD EVO 50 SM Limited Edition	50	1	2009-	0,6	BR8ES	5422	Q207	BR8EIX	5044
Senda DRD PRO R	50	1	2009-	0,6	BR8ES	5422	Q207	BR8EIX	5044
Senda DRD PRO SM	50	1	2009-	0,6	BR8ES	5422	Q207	BR8EIX	5044
Senda DRD Racing 50	50	1	-	0,6	BR8ES	5422	Q207	BR8EIX	5044
Senda DRD Racing 50 SM	50	1	-	0,6	BR8ES	5422	Q207	BR8EIX	5044
Senda L, R, SM	50	1	1995-1999	0,6	B9ES	2611	Q202	BR9EIX	3981
Senda R & SM 00	50	1	2000-	0,6	B9ES	2611	Q202	BR9EIX	3981
Senda R X-Race	50	1	-	0,6	BR8ES	5422	Q207	BR8EIX	5044
Senda R X-Treme	50	1	-	0,6	BR8ES	5422	Q207	BR8EIX	5044
Senda X Race 50 R	50	1	-	0,6	BR8ES	5422	Q207	BR8EIX	5044
Senda X Race 50 SM	50	1	-	0,6	BR8ES	5422	Q207	BR8EIX	5044
Senda X Treme 50 SM	50	1	-	0,6	BR8ES	5422	Q207	BR8EIX	5044
Senda X-Treme 50 R	50	1	-	0,6	BR8ES	5422	Q207	BR8EIX	5044
SM DRD	50	1	-	0,6	B9ES	2611	Q202	BR9EIX	3981
SM Racer	50	1	2002-	0,6	B9ES	2611	Q202	BR9EIX	3981
SM X-treme	50	1	2002-	0,6	B9ES	2611	Q202	BR9EIX	3981
Sonar 50 2 Stroke	50	1	2010-	0,7	BR9ES	5722	Q208	BR9EIX	3981
Sport, Variant, Yumbo	50	1	-1991	0,6	B7HS	5110	Q204	BR7HIX	7067
Urban	50	1	1995-	0,6	B8HS	5510	Q205	BR8HIX	7001
Vamos FL	50	1	1994-	0,6	BR8HS	4322	Q212	BR8HIX	7001

* Bitte Elektrodenabstand nach Angaben des Herstellers justieren

* Please adjust the groundelectrode gap

* Veuillez vérifier L' écartement

* Por favor, ajustar distancia entre electrodos

* regolare il gap

C
Y
L

0201



Stock-No

Quick-No



Stock-No IX

DERBI

Vamos L	50	1	1994-	0,6	BR8HS	4322	Q212	BR8HIX	7001
Variant AIR	50	1	2003-	0,5	B8HS	5510	Q205	BR8HIX	7001
Variant Box, Sport R, Top	50	1	1992-	0,6	B8HS	5510	Q205	BR8HIX	7001
Variant Revolution	50	1	2003-	0,6	B8HS	5510	Q205	BR8HIX	7001
X-Race, Race R, Treme	50	1	-	0,5	B8ES	2411	Q201	BR8EIX	5044
1001, Extra Sport Coppa	75	1	-	0,5	B8ES	2411	Q201	BR8EIX	5044
CR 74	75	1	-	0,5	B10EGV	5927	-	-	-
Europa RD15, Scoot 74	75	1	-	0,5	B8ES	2411	Q201	BR8EIX	5044
GPR-75, Sport-75	75	1	-	0,5	B10ES	7928	-	BR10EIX	6801
Gran Prix 74	75	1	-	0,5	B6HS	4510	Q203	BR6HIX	3419
Vivo-75	75	1	-	0,6	BP5HS	4111	-	-	-
BI 3	80	1	1995-	0,6	B8ES	2411	Q201	BR8EIX	5044
Senda 100	85		1997-	0,6	B9ES	2611	Q202	BR9EIX	3981
R-Atlantis	100	1	2000-	0,6	B9ES	2611	Q202	BR9EIX	3981
Boulevard 4 Stroke	125		2003-	0,6	CR7EB	4663	-	CR7EIX	7385
Boulevard 4 Stroke - Piaggio ref.air	125	1	2008-	0,8	CR7EB	4663	-	CR7EIX	7385
Boulevard 4 Stroke AC	125	1	2003-	0,7	CR9E	6263	Q227	CR9EIX	3521
Cross City 125	125	1	2007-	0,7	DR8EA	7162	-	DR8EIX	6681
CRS, RC	125	1	-	0,5	B10EGV	5927	-	-	-
DRD-Senda R	125	1	2009-	0,6	CR8EB	7784	-	CR8EIX	4218
DRD-Senda SM	125	1	2009-	0,6	CR8EB	7784	-	CR8EIX	4218
Enduro, RS125TT, Karmathan	125	1	-	0,5	B9EGV	5827	-	-	-
GP1	125	1	2007-	0,7	CR9EB	6955	-	CR9EIX	3521
GPR 125 4V	125	1	2009-	0,8	CR8EB	7784	-	CR8EIX	4218
GPR-Nude	125	1	2004-	0,8	BR8ES	5422	Q207	BR8EIX	5044
GPR-Racing	125	1	2004-	0,8	BR8ES	5422	Q207	BR8EIX	5044
HDR Cabriolet	125		2000-	0,5	CR7E	4578	Q225	CR7EIX	7385
Mulhacen	125	1	2007-	0,6	CR8EB	7784	-	CR8EIX	4218
Mulhacen Café	125	1	2007-	0,6	CR8EB	7784	-	CR8EIX	4218
Rambla	125	1	-	0,6	BR9ES	5722	Q208	BR9EIX	3981
Rambla 4 Stroke	125	1	-	0,8	CR8EB	7784	-	CR8EIX	4218
Senda R 4 Stroke	125	1	2002-2008	0,9	DPR8EA-9	4929	Q221	DPR8EIX-9	2202
Senda SM	125	1	2002-2008	0,9	DPR8EA-9	4929	Q221	DPR8EIX-9	2202
Sport Coppa, TTS9	125	1	-	0,5	B9ES	2611	Q202	BR9EIX	3981
Terra	125	1	2008-	0,6	CR8EB	7784	-	CR8EIX	4218
Terra Adventure	125	1	2007-	0,6	CR8EB	7784	-	CR8EIX	4218
TW-Cross City 125	125	1	2007-	0,8	D8EA	2120	Q216	DR8EIX	6681
TW-Senda Baja (,R)125	125	1	2007-	0,8	D8EA	2120	Q216	DR8EIX	6681
Boulevard 4 Stroke	150		2003-	0,7	CR9E	6263	Q227	CR9EIX	3521
2002, Gran Prix, 6V	200	1	-	0,5	B9ES	2611	Q202	BR9EIX	3981
CRX, RC, Enduro	250	1	-	0,5	B10EGV	5927	-	-	-
GP1	250	1	2006-	0,7	CR9EB	6955	-	CR9EIX	3521
GP1	250	1	2007-	0,7	PMR8B	6378	-	-	-
GP1 Racing	250	1	2007-	0,7	PMR8B	6378	-	-	-
Rambla 250	250	1	-	0,7	PMR8B	6378	-	-	-
Turismo 250	250	1	-	0,5	B9ES	2611	Q202	BR9EIX	3981
Rambla 300i	300	1	2010-	0,7	CR8EKB	4374	-	CR8EIX	4218
Mulhacen 659	660	1	2005-	0,6	CR7E	4578	Q225	CR7EIX	7385
Mulhacen 659 Café	660	1	2005-	0,6	CR7E	4578	Q225	CR7EIX	7385

* Bitte Elektrodenabstand nach Angaben des Herstellers justieren

* Please adjust the groundelectrode gap

* Veuillez vérifier l' écartement

* Por favor, ajustar distancia entre electrodos

* regolare il gap

C
Y
L

0201



Stock-№

Quick-№



Stock-№ IX

DUCATI

100 Sport	100	1	1958-1960	0,6	B7HS	5110	Q204	BR7HIX	7067
160 Monza	160	1	-	0,6	B7HS	5110	Q204	BR7HIX	7067
Desmo	350		-	0,5	B7HS	5110	Q204	BR7HIX	7067
Forza	350	2	-	0,5	B6HS	4510	Q203	BR6HIX	3419
Junior	350	1	1992-1992	0,6	BP7HS	5111	-	BPR7HIX	5944
MK III D	350	2	-	0,5	B6HS	4510	Q203	BR6HIX	3419
Sport	350		1992-	0,6	B7HS	5110	Q204	BR7HIX	7067
Monster	400		-2005	0,7	DCPR8E	4339	-	DCPR8EIX	6546
Supersport Junior	400	2	1991-1992	0,6	BPR7HS	6422	Q215	BPR7HIX	5944
Desmo	500		-	0,5	B7HS	5110	Q204	BR7HIX	7067
SL Pantah	500	2	-	0,6	BPR7HS	6422	Q215	BPR7HIX	5944
M-Monster	600	2	1994-2001	0,6	DCPR8E	4339	-	DCPR8EIX	6546
M-Monstro , Monstro Dark	600	2	-1998	0,6	DCPR8E	4339	-	DCPR8EIX	6546
SS	600	2	1994-1997	0,7	-	-	-	DCR8EIX	3606
Super Sport	600		1994-	0,6	DCPR8E	4339	-	DCPR8EIX	6546
M-i.E.	620	2	2002-2006	0,6	DCPR8E	4339	-	DCPR8EIX	6546
Monster Dark SD et DD	620	2	2004-	0,6	DCPR8E	4339	-	DCPR8EIX	6546
Multistrada	620	2	2005-2007	0,6	DCPR8E	4339	-	DCPR8EIX	6546
S-Sport	620	2	2002-	0,6	DCPR8E	4339	-	DCPR8EIX	6546
650 Indiana	650	2	1987-	0,6	BP7HS	5111	-	BPR7HIX	5944
Monster 695	695	2	2006-2007	0,9	DCPR8E	4339	-	DCPR8EIX	6546
Monster 696 (80PS)	700	2	2008-	0,9	DCPR8E	4339	-	DCPR8EIX	6546
R	748	2	1999-	0,6	-	-	-	DCR9EIX	6650
R	748	2	2000-2004	0,6	R2349-10	6839	-	-	-
SP	748	2	1995-2003	0,6	-	-	-	DCR9EIX	6650
SPS	748	2	1995-2003	0,6	-	-	-	DCR9EIX	6650
Strada, Biposto	748	2	1995-	0,6	-	-	-	DCR9EIX	6650
R	749	2	2003-	0,7	CR9EB	6955	-	CR9EIX	3521
S	749	2	2003-	0,7	CR9EB	6955	-	CR9EIX	3521
F1	750	2	1985-	0,7	-	-	-	DCR8EIX	3606
F1 LS	750	2	1985-	0,7	-	-	-	DCR8EIX	3606
Indiana	750	2	1987-	0,6	BPR7HS	6422	Q215	BPR7HIX	5944
M-Monster	750	2	1997-2002	0,6	-	-	-	DCPR8EIX	6546
Monster 750	750	2	1996-1997	0,7	-	-	-	DCR8EIX	3606
Paso	750	2	1986-	0,9	DPR8EA-9	4929	Q221	DPR8EIX-9	2202
Sport	750	2	1988-2000	0,9	DPR8EA-9	4929	Q221	DPR8EIX-9	2202
SS	750	2	1991-1993	0,9	-	-	-	DPR8EIX-9	2202
SS-HF I.E.	750	2	-	0,7	-	-	-	DCR8EIX	3606
SS-Sport & Supersport ie	750	2	2000-	0,9	-	-	-	DPR7EIX-9	7803
SS-SuperSport	750	2	1994-2000	0,6	-	-	-	DCR9EIX	6650
Hypermotard	800	2	2013-	0,7	DCPR8E	4339	-	DCPR8EIX	6546
Hypermotard 796	800	2	2009-2012	0,8	MAR9A-J	6869	-	-	-
Monster Standart	800	2	2004-	0,6	DCPR8E	4339	-	DCPR8EIX	6546
S2R-Monster	800	2	2005-2007	0,6	DCPR8E	4339	-	DCPR8EIX	6546
S-Monster i.E	800	2	2003-	0,6	-	-	-	DCPR8EIX	6546
SS-Sport & Supersport ie	800	2	2003-	0,6	-	-	-	DCPR8EIX	6546
Monster 796	803	2	2010-	0,9	DCPR8E	4339	-	DCPR8EIX	6546
Monster, Hypermotard 796	803	2	2009-2012	0,6	DCPR8E	4339	-	DCPR8EIX	6546
Dark	848		2007-	0,8	MAR10A-J	4706	-	-	-
Evo	848		2011-	0,8	MAR10A-J	4706	-	-	-
Evo Corse	848		2012-	0,8	MAR10A-J	4706	-	-	-

* Bitte Elektrodenabstand nach Angaben des Herstellers justieren

* Please adjust the groundelectrode gap

* Veuillez vérifier L' écartement

* Por favor, ajustar distancia entre electrodos

* regolare il gap

C
Y
I

0201



Stock-No

Quick-No



Stock-No IX

DUCATI

Streetfighter	848	2	2012-	0,8	MAR10A-J	4706	-	-	-
848	850	2	2007-	0,8	MAR10A-J	4706	-	-	-
i.E.	851	2	-	0,6	-	-	-	DCR9EIX	6650
Superbike Racing	851	2	-	0,6	-	-	-	DCR9EIX	6650
Desmo SS	860	2	-	0,5	B6HS	4510	Q203	BR6HIX	3419
851 S.P.,II,III,IV	888	2	-	0,6	-	-	-	DR9EIX	4772
SP1	888	2	-	0,6	-	-	-	DCR9EIX	6650
SP5	888	2	1993-	0,5	R2349-9	4418	-	-	-
SP5 Racing	888	2	-	0,6	-	-	-	DCR9EIX	6650
Strada	888	2	1993-	0,6	R2525-9	4735	-	-	-
Darmah	900	2	-	0,6	BP6HS	4511	-	BPR6HIX	4085
Mhe	900	2	2002-	0,6	DCPR8E	4339	-	DCPR8EIX	6546
MH-Evoluzione	900	2	2000-	0,6	DCPR8E	4339	-	DCPR8EIX	6546
M-Monster S ie	900	2	2000-	0,6	DCPR8E	4339	-	DCPR8EIX	6546
M-Monster	900	2	-1999	0,6	DCPR8E	4339	-	DCPR8EIX	6546
SL	900	2	1991-	0,9	DPR9EA-9	5329	Q222	DPR9EIX-9	5545
SS	900	2	1991-	0,9	DPR9EA-9	5329	Q222	DPR9EIX-9	5545
SS-I.E.	900	2	1991-1998	*	-	-	-	DCR8EIX	3606
SS-Sport & Supersport ie	900	2	1999-	0,9	DCPR8E	4339	-	DCPR8EIX	6546
Superlight	900	2	1992-	0,6	DCPR8E	4339	-	DCPR8EIX	6546
Supersport Final Edition	900	2	1998-	0,6	DCPR8E	4339	-	DCPR8EIX	6546
Paso	906	2	-	0,6	DCPR8E	4339	-	DCPR8EIX	6546
i.E.	907	2	-	0,6	DCPR8E	4339	-	DCPR8EIX	6546
M-Monster S4	916	2	2001-2003	0,5	-	-	-	DCR9EIX	6650
SP, SPS	916	2	1994-1997	0,6	R2349-10	6839	-	-	-
ST4	916	2	1998-2003	0,6	-	-	-	DCR9EIX	6650
Strada, Biposto, Senna	916	2	1994-1997	0,5	-	-	-	DCR9EIX	6650
ST2	944	2	1997-2003	0,6	-	-	-	DCPR8EIX	6546
Mille	972	2	-	0,6	BP7HS	5111	-	BPR7HIX	5944
Desmosedici RR	989	4	2008-	0,8	MAR10A-J	4706	-	-	-
DESMO 16RR	990	4	2007-	0,6	MAR10A-J	4706	-	-	-
GT	992	2	2006-2010	0,6	DCPR8E	4339	-	DCPR8EIX	6546
Multistrada	992	2	2004-	0,6	DCPR8E	4339	-	DCPR8EIX	6546
Sport S	992	2	2006-2010	0,6	DCPR8E	4339	-	DCPR8EIX	6546
ST3	992	2	2004-	0,6	CR9EB	6955	-	CR9EIX	3521
Touring	992	2	2006-2010	0,6	DCPR8E	4339	-	DCPR8EIX	6546
916 SP	996	2	1998-	0,5	R2349-9	4418	-	-	-
916 SPS	996	2	1998-	0,5	R2349-9	4418	-	-	-
996 SP	996	2	1998-	0,6	R2349-9	4418	-	-	-
996 SPS	996	2	1998-	0,6	R2349-9	4418	-	-	-
Monster S4R	996	2	2004-2005	0,8	-	-	-	DCR9EIX	6650
R	996	2	2001-	0,6	R2349-10	6839	-	-	-
S4R-Monster	996	2	2004-	0,6	-	-	-	DCR9EIX	6650
SP / SPS / SPS Factory	996	2	1998-	0,5	-	-	-	DCR9EIX	6650
SPS Racing	996	2	1999-2000	0,6	R2349-10	6839	-	-	-
ST4 S	996	2	2003-2005	0,5	-	-	-	DCR9EIX	6650
ST4S-ABS	996	2	2003-2005	0,6	-	-	-	DCR9EIX	6650
Strada, Biposto	996	2	1998-	0,5	-	-	-	DCR9EIX	6650
999 R	998	2	2002-2006	0,6	CR9EB	6955	-	CR9EIX	3521
999 S	998	2	2002-2006	0,6	CR9EB	6955	-	CR9EIX	3521
R	998	2	2001-	0,6	R2349-10	6839	-	-	-
S4R-Monster	998	2	2007-	0,8	MAR10A-J	4706	-	-	-

* Bitte Elektrodenabstand nach Angaben des Herstellers justieren

* Please adjust the groundelectrode gap

* Veuillez vérifier L' écartement

* Por favor, ajustar distancia entre electrodos

* regolare il gap

C
y
l

Stock-№

Quick-№



Stock-№ IX

DUCATI

S4RS-Monster	998	2	2006-2008	0,6	CR9EB	6955	-	CR9EIX	3521
Classic Sport 1000	1000	2	2006-2009	0,9	DCPR8E	4339	-	DCPR8EIX	6546
DS-Monster	1000	2	2003-2005	*	-	-	-	DCR8EIX	3606
DS-Monster	1000	2	2006-	0,9	DCPR8E	4339	-	DCPR8EIX	6546
Monster 1000 i.e.	1000	2	2003-2005	0,7	-	-	-	DCR8EIX	3606
Monster Standart	1000	2	2004-	0,6	DCPR8E	4339	-	DCPR8EIX	6546
Multistrada	1000	2	2002-2005	*	-	-	-	DCR8EIX	3606
Multistrada	1000	2	2006-	0,9	DCPR8E	4339	-	DCPR8EIX	6546
Multistrada/ S / DS	1000	2	2006-	0,9	DCPR8E	4339	-	DCPR8EIX	6546
Multistrada/S/DS	1000	2	2004-2006	*	-	-	-	DCR8EIX	3606
Paul Smart	1000	2	2006-	0,6	DCPR8E	4339	-	DCPR8EIX	6546
S2R-Monster	1000	2	2006-2008	0,9	DCPR8E	4339	-	DCPR8EIX	6546
Sport Naked	1000	2	2007-	0,6	DCPR8E	4339	-	DCPR8EIX	6546
SS-DS	1000	2	2003-	0,6	DCPR8E	4339	-	DCPR8EIX	6546
S-Sport	1000	2	2007-	0,6	DCPR8E	4339	-	DCPR8EIX	6546
SS-Sport & Supersport ie	1000	2	2003-	*	-	-	-	DCR8EIX	3606
ST3	1000	2	2004-2008	0,6	CR9EB	6955	-	CR9EIX	3521
Hypermotard	1078	2	2007-	0,9	DCPR8E	4339	-	DCPR8EIX	6546
1098 / 1098S/ Tricolore	1098	2	2007-	0,8	MAR10A-J	4706	-	-	-
1098 R	1098	2	2008-2009	0,8	MAR10A-J	4706	-	-	-
Hypermotard / Hypermotard S	1100	2	2007-2009	0,6	DCPR8E	4339	-	DCPR8EIX	6546
Hypermotard Evo / Evo S	1100	2	2010-	0,6	DCPR8E	4339	-	DCPR8EIX	6546
Hypermotard Evo SP Corse Edition	1100	2	2012-	0,7	DCPR8E	4179	-	DCPR8EIX	6546
Monster / S / Evo	1100	2	2009-2010	0,7	DCPR8E	4339	-	DCPR8EIX	6546
Multistrada 1100 /S	1100	2	2008-2010	0,9	DCPR8E	4339	-	DCPR8EIX	6546
Streetfighter / S	1100	2	2009-	0,8	MAR10A-J	4706	-	-	-
1198 / S	1198	2	2008-	0,8	MAR10A-J	4706	-	-	-
1198 R	1198	2	2009-	0,8	MAR10A-J	4706	-	-	-
Diavel	1198	2	2010-	0,8	MAR9A-J	6869	-	-	-
Diavel AMG	1198	2	2013-	0,8	MAR9A-J	6869	-	-	-
Diavel Cromo	1198	2	2011-	0,8	MAR9A-J	6869	-	-	-
Multistrada 1200 / 1200 S	1198	2	2010-	0,8	MAR9A-J	6869	-	-	-
Panigale (S)	1198	2	2012-	0,8	MAR9A-J	6869	-	-	-
S&R Corse / SP	1198	2	2010-	0,8	MAR10A-J	4706	-	-	-
Multistrada	1200	2	2013-	0,8	MAR9A-J	6869	-	-	-
Multistrada Granturismo	1200	2	2013-	0,8	MAR10A-J	4706	-	-	-

ENDRESS

EMR	50	1	-	0,6	BR8HSA	5539	-	BR8HIX	7001
EMR DJ	50	1	1997-	0,6	BR8HSA	5539	-	BR8HIX	7001
EMR Ergon	50	1	1997-	0,6	BP6HS	4511	-	BPR6HIX	4085

EPPELLA

JC50Q-7-Monkey Edition	50	1	2007-	0,7	CR6HSA	2983	-	CR6HIX	7274
RT 50	50	1	2007-	0,7	BPR7HS	6422	Q215	BPR7HIX	5944
Chopper 2Z	125	1	2007-	0,6	CR7HSA	4549	-	CR7HIX	7544
G-Max PGO	125	1	2007-	0,6	CR7HSA	4549	-	CR7HIX	7544

* Bitte Elektrodenabstand nach Angaben des Herstellers justieren

* Please adjust the groundelectrode gap

* Veuillez vérifier L' écartement

* Por favor, ajustar distancia entre electrodos

* regolare il gap

C
Y
L

0201



Stock-No

Quick-No



Stock-No IX

FANTIC

Big Wheel	50	1	1994-	0,5	B8HS	5510	Q205	BR8HIX	7001
Grinta	50	1	1995-	0,6	B7HS	5110	Q204	BR7HIX	7067
Issimo	50	1	-	0,5	B5HS	4210	-	-	-
Issimo Convert/Kick	50	1	-	0,5	B5HS	4210	-	-	-
Junior,Tender To	50	1	-	0,5	B5HS	4210	-	-	-
Queenie	50	1	-	0,6	BP7HS	5111	-	BPR7HIX	5944
Trial	50	1	-	0,5	B7HS	5110	Q204	BR7HIX	7067
Koala	75	1	-	0,5	B8ES	2411	Q201	BR8EIX	5044
Oasis	75	1	-	0,5	B8ES	2411	Q201	BR8EIX	5044
Trial	75	1	-	0,5	B8HS	5510	Q205	BR8HIX	7001
Caballero	80	1	-	0,5	B9ES	2611	Q202	BR9EIX	3981
Caballero RC80	80	1	-	0,6	B10EG	3630	-	-	-
Enduro	80	1	-	0,5	B8EG	3430	-	-	-
RSX	80	1	-	0,5	B8EG	3430	-	-	-
Section	80		1995-1997	0,5	BCP7ES	5030	-	BCPR7EIX	5690
Caballero	125	1	-	0,5	B9EG	3530	-	-	-
Cross	125	1	-	0,5	B9EG	3530	-	-	-
Professional	125	1	-	0,5	B6HS	4510	Q203	BR6HIX	3419
RSX	125	1	-	0,5	B9EG	3530	-	-	-
Trial	125	1	-	0,5	B6HS	4510	Q203	BR6HIX	3419
Trial / Competicion	125	1	-	0,5	B7HS	5110	Q204	BR7HIX	7067
TX	160	1	-	0,5	B8EG	3430	-	-	-
Enduro	175	1	-	0,5	B8EG	3430	-	-	-
Trial	200	1	-	0,5	B6HS	4510	Q203	BR6HIX	3419
Trial 240	240	1	-	0,5	B6HS	4510	Q203	BR6HIX	3419
Coach	250		-	0,5	B8ES	2411	Q201	BR8EIX	5044
K-Roo	250	2	-	0,5	B8ES	2411	Q201	BR8EIX	5044
Section	250	1	1995-1997	0,5	BCP7ES	5030	-	BCPR7EIX	5690
Trial 301 Competition	250	1	-	0,5	BP5ES	6511	-	BPR5EIX	6597
Trial 301/305/307	250	1	-	0,5	B8ES	2411	Q201	BR8EIX	5044
TX	250	1	-	0,5	B8EG	3430	-	-	-
TX	260		-	0,5	B8EG	3430	-	-	-
Professional	300	1	-	0,5	B8EG	3430	-	-	-
TX	330		-	0,5	B8EG	3430	-	-	-

GARELLI

Astro 50 2001	50	1	2001-	0,6	BR9HS	4522	-	BR9HIX	5687
Big Whell	50	1	1993-	0,6	BPR7HS	6422	Q215	BPR7HIX	5944
Flo 50	50	1	-	0,6	BPR7HS	6422	Q215	BPR7HIX	5944
Formuno, Noi Matic,TL,2V	50	1	-	0,5	B6HS	4510	Q203	BR6HIX	3419
FX 50	50	1	-	0,6	BR9HS	4522	-	BR9HIX	5687
Grinta 50	50	1	1993-	0,6	BP7HS	5111	-	BPR7HIX	5944
KRC 50	50	1	-	0,6	BR9HS	4522	-	BR9HIX	5687
KRS 50	50	1	-	0,6	BR9HS	4522	-	BR9HIX	5687
PMX	50	1	-	0,6	BPR7HS	6422	Q215	BPR7HIX	5944
Queenie 50	50	1	1992-	0,6	BP7HS	5111	-	BPR7HIX	5944
Racing	50	1	-1993	0,6	BP7HS	5111	-	BPR7HIX	5944
Racing SR	50	1	-1993	0,6	BP7HS	5111	-	BPR7HIX	5944
Hussar 125	125	1	2001-	0,6	CR7HSA	4549	-	CR7HIX	7544
Joker 125	125	1	2003-	0,7	CR7HSA	4549	-	CR7HIX	7544
T-Rex 150	150	1	2001-	0,6	CR7HSA	4549	-	CR7HIX	7544

* Bitte Elektrodenabstand nach Angaben des Herstellers justieren

* Please adjust the groundelectrode gap

* Veuillez vérifier L' écartement

* Por favor, ajustar distancia entre electrodos

* regolare il gap

C
Y
L

0201



Stock-Nr

Quick-Nr



Stock-Nr IX

GAS GAS

Contact, Enducross	50	1	-	0,6	B8HS	5510	Q205	BR8HIX	7001
EC-Boy	50	1	2000-	0,5	B8HS	5510	Q205	BR8HIX	7001
EC-Rookies	50	1	2001-	0,6	BR9ES	5722	Q208	BR9EIX	3981
Endurocross BOY	50	1	-	0,6	BPR5ES	7422	-	BPR5EIX	6597
SM-Supermotard	50		2004-	0,6	B9ES	2611	Q202	BR9EIX	3981
TXT-Boy	50	1	2000-	0,6	BPR5ES	7422	-	BPR5EIX	6597
TXT-Boy Alu. Cyl. Head	50	1	2004-	0,6	BR8ECM	3035	-	BR8ECMIX	3520
MC65	65		2006-	0,7	BR10ES	4832	-	BR10EIX	6801
Husqvarna (TM)	75		-	0,5	B10EG	3630	-	-	-
TXT	80		-	0,5	BPR5ES	7422	-	BPR5EIX	6597
EC-2 Stroke	125	1	2004-	0,6	BR9EG	3230	-	-	-
EC-Enducross	125	1	1995-	0,5	B10EGV	5927	-	-	-
EC-Enducross	125	1	1997-	0,6	B9EG	3530	-	-	-
EC-Racing, SIX	125		2010-	0,7	BR9EG	3230	-	-	-
Enduro	125	1	2002-	0,6	BR8EG	3130	-	-	-
GT-12	125	1	1994-	0,5	BP5ES	6511	-	BPR5EIX	6597
Husqvarna (TM)	125		-	0,5	B10EG	3630	-	-	-
JT-12 Contact	125	1	1994-	0,5	BP5ES	6511	-	BPR5EIX	6597
MC	125	1	2004-	0,6	BR9EG	3230	-	-	-
PP-Pampera	125	1	1997-	0,6	BPR6ES	7822	-	BPR6EIX	6637
PP-Pampera 4 Stroke	125	1	2010-	0,8	BPR6ES	7822	-	BPR6EIX	6637
SM-Supermotard	125		-	0,7	BR9EG	3230	-	-	-
Trial 125	125	1	-	0,5	BP5ES	6511	-	BPR5EIX	6597
TT	125	1	-	0,6	BR8EG	3130	-	-	-
TT-Cross	125	1	-	0,5	B10EGV	5927	-	-	-
TT-Enducross	125	1	1994-	0,5	B10EGV	5927	-	-	-
TX	125	1	1997-1998	0,6	BPR5ES	7422	-	BPR5EIX	6597
TXT-Pro	125	1	2004-	0,6	BPR5ES	7422	-	BPR5EIX	6597
TXT-Trial	125	1	1999-	0,6	BPR5ES	7422	-	BPR5EIX	6597
Contact T 16	143	1	1994-	0,5	BP5ES	6511	-	BPR5EIX	6597
GT16 (Ref. liquid)	160		-	0,5	BP5ES	6511	-	BPR5EIX	6597
JT-16 Contact	160	1	1995-	0,5	BP5ES	6511	-	BPR5EIX	6597
EC-Endurocross	200	1	1999-	0,6	B10EGV	5927	-	-	-
EC-Endurocross	200		2002-	0,5	BR8EG	3130	-	-	-
EC-Endurocross	200	1	2004-	0,6	BR8EG	3130	-	-	-
Enduro	200	1	2002-	0,6	BR8EG	3130	-	-	-
Pampera	200	1	-	0,8	BPR6ES	7822	-	BPR6EIX	6637
TT	200	1	-	0,6	BR8EG	3130	-	-	-
TX	200	1	1997-1998	0,6	BPR5ES	7422	-	BPR5EIX	6597
TXT-Trial	200	1	1999-	0,6	BPR5ES	7422	-	BPR5EIX	6597
GT-25	240	1	1994-	0,5	BP5ES	6511	-	BPR5EIX	6597
JT-Contact 25	240	1	1994-1996	0,5	BP5ES	6511	-	BPR5EIX	6597
TX / TXT-Trial	249	1	1999-	0,6	BPR5ES	7422	-	BPR5EIX	6597
Cross 250	250	1	-	0,6	BR8EG	3130	-	-	-
Delta 25 GT	250	1	-	0,5	BP5ES	6511	-	BPR5EIX	6597
EC-EC 2 Stroke	250	1	2004-	0,6	BR8EG	3130	-	-	-
EC-Enducross	250	1	1997-	0,6	BR8EG	3130	-	-	-
ECF-4T, SIX 4 Stroke	250		2010-2011	0,7	CR8E	1275	Q226	CR8EIX	4218
ECF-4T, SIX 4 Stroke	250		2012-	0,6	CR9E	6263	Q227	CR9EIX	3521
EC-Racing,SIX (Incl. Replica) 2 Stroke	250		2010-	0,7	BR8EG	3130	-	-	-

* Bitte Elektrodenabstand nach Angaben des Herstellers justieren

* Please adjust the groundelectrode gap

* Veuillez vérifier L' écartement

* Por favor, ajustar distancia entre electrodos

* regolare il gap

C
Y
L

0201



Stock-No

Quick-No



Stock-No IX

GAS GAS

Enducross	250	1	-	0,5	B10EGV	5927	-	-	-
Enduro	250	1	2002-	0,6	BR8EG	3130	-	-	-
Husqvarna (TM)	250		-	0,5	B10EG	3630	-	-	-
MC-MC	250	1	2004-	0,6	BR8EG	3130	-	-	-
Piri-A 6 Magnum	250	1	-	0,5	BP5ES	6511	-	BPR5EIX	6597
PP-Pampera	250	1	1997-2003	0,6	BPR6ES	7822	-	BPR6EIX	6637
PP-Pampera	250	1	2004-	0,5	BPR5ES	7422	-	BPR5EIX	6597
SM-Supermotard	250		-	0,5	BR8EG	3130	-	-	-
Trial 250 (water + air)	250	1	-	0,5	BP5ES	6511	-	BPR5EIX	6597
TT	250	1	-	0,6	BR8EG	3130	-	-	-
TT-Enducross	250	1	-	0,5	B10EGV	5927	-	-	-
TX	250	1	1997-1998	0,6	BPR5ES	7422	-	BPR5EIX	6597
TXT	250	1	-	0,6	BPR5ES	7422	-	BPR5EIX	6597
TXT-Pro	250	1	2001-	0,6	BPR5ES	7422	-	BPR5EIX	6597
TXT-Raga Replica	250		2011-	0,6	BPR5ES	7422	-	BPR5EIX	6597
TX	270	1	1997-1998	0,6	BPR5ES	7422	-	BPR5EIX	6597
TXT-Trial	270	1	1999-	0,6	BPR5ES	7422	-	BPR5EIX	6597
Pampera	280		-	0,5	BPR5ES	7422	-	BPR5EIX	6597
TXT	280	1	2000-	0,5	BP5ES	6511	-	BPR5EIX	6597
TXT-Pro	280	1	2004-	0,6	BPR5ES	7422	-	BPR5EIX	6597
TXT-Racing, Raga Replica	280		2011-	0,6	BPR5ES	7422	-	BPR5EIX	6597
TXT-Trial	280	1	2000-	0,6	BPR5ES	7422	-	BPR5EIX	6597
EC-Enducross	300	1	1999-	0,6	BR8EG	3130	-	-	-
EC-Enducross	300	1	2004-	0,6	BR8EG	3130	-	-	-
EC-Racing, SIX (Incl. Replica) 2 Stroke	300		2010-	0,7	BR8EG	3130	-	-	-
Enduro	300	1	2002-	0,6	BR8EG	3130	-	-	-
Trial	300		-	0,5	BP5ES	6511	-	BPR5EIX	6597
TT	300	1	-	0,6	BR8EG	3130	-	-	-
TXT- Pro, Racing, Raga Replica	300		2011-	0,6	BPR5ES	7422	-	BPR5EIX	6597
JT-Contact	320	1	1995-	0,5	BP5ES	6511	-	BPR5EIX	6597
Pampera	320	1	-	0,8	BPR6ES	7822	-	BPR6EIX	6637
TX	320	1	1997-1998	0,6	BPR5ES	7422	-	BPR5EIX	6597
TXT-Trial	321	1	1999-	0,6	BPR5ES	7422	-	BPR5EIX	6597
Trial Halley PXC	325		-	0,5	B9ES	2611	Q202	BR9EIX	3981
Delta 32 GT	330	1	-	0,5	BP5ES	6511	-	BPR5EIX	6597
Trial	330	1	-	0,5	BP5ES	6511	-	BPR5EIX	6597
JTR	370	1	-	0,5	BPR5ES	7422	-	BPR5EIX	6597
PP-Pampera	370	1	1997-	0,6	BPR6ES	7822	-	BPR6EIX	6637
EC-FSE	400	1	2002-	0,7	CR8E	1275	Q226	CR8EIX	4218
SM	400	1	-	0,7	CR8E	1275	Q226	CR8EIX	4218
EC-4 Stroke	450	1	2005-	0,6	CR8E	1275	Q226	CR8EIX	4218
FSE	450	1	2004-	0,6	CR8E	1275	Q226	CR8EIX	4218
Pampera	450	1	2007-	0,7	CR8E	1275	Q226	CR8EIX	4218
SM	450		2004-	0,7	CR8E	1275	Q226	CR8EIX	4218
EC-FSR	492		2008-2010	0,7	CR8E	1275	Q226	CR8EIX	4218
Normada 500	500	1	-	0,5	D8EA	2120	Q216	DR8EIX	6681
SM	515		2008-2010	0,7	CR8E	1275	Q226	CR8EIX	4218

GENERIC

50.com	50	1	-	0,7	BR7ES	5122	-	BR7EIX	6664
Atura K50	50	1	-	0,5	BR8HSA	5539	-	BR8HIX	7001

* Bitte Elektrodenabstand nach Angaben des Herstellers justieren

* Please adjust the groundelectrode gap

* Veuillez vérifier L' écartement

* Por favor, ajustar distancia entre electrodos

* regolare il gap

C
Y
L

0201



Stock-№

Quick-№



Stock-№ IX

GENERIC

Cracker 50	50	1	2007-	0,7	BR7ES	5122	-	BR7EIX	6664
Epico 50	50	1	-	0,5	BR8HSA	5539	-	BR8HIX	7001
Evolution 50	50	1	2007-	0,7	BR7ES	5122	-	BR7EIX	6664
Explorer Cracker 50	50	1	-	0,7	BR7ES	5122	-	BR7EIX	6664
Explorer Kallio 50	50	1	-	0,5	BR8HSA	5539	-	BR8HIX	7001
Explorer Race 50	50	1	-	0,7	BR7ES	5122	-	BR7EIX	6664
Explorer Spin 50	50	1	-	0,7	BR7ES	5122	-	BR7EIX	6664
Explorer Twister 50	50	1	-	0,7	BR7ES	5122	-	BR7EIX	6664
G-Ride 50.com	50	1	-	0,7	BR7ES	5122	-	BR7EIX	6664
G-Ride Evolution 50	50	1	-	0,7	BR7ES	5122	-	BR7EIX	6664
Ideo 50	50	1	2007-	0,7	BR7ES	5122	-	BR7EIX	6664
Kallio 50	50	1	-	0,5	BR8HSA	5539	-	BR8HIX	7001
Limited 50	50	1	-	0,7	BR7ES	5122	-	BR7EIX	6664
Omen 50	50	1	-	0,7	BR7ES	5122	-	BR7EIX	6664
Onyx 50	50	1	-	0,5	BR8HSA	5539	-	BR8HIX	7001
Race 50	50	1	-	0,7	BR7ES	5122	-	BR7EIX	6664
Race 50	50		2011-	0,7	BR8HSA	5539	-	BR8HIX	7001
Ride 50.com	50	1	-	0,7	BR7ES	5122	-	BR7EIX	6664
Ride Cracker 50	50	1	-	0,7	BR7ES	5122	-	BR7EIX	6664
Ride Evolution 50	50	1	-	0,7	BR7ES	5122	-	BR7EIX	6664
Ride Kallio 50	50	1	-	0,5	BR8HSA	5539	-	BR8HIX	7001
Ride Omen 50	50	1	-	0,7	BR7ES	5122	-	BR7EIX	6664
Ride Race 50	50	1	-	0,7	BR7ES	5122	-	BR7EIX	6664
Ride Slash 50	50	1	-	0,7	BR7ES	5122	-	BR7EIX	6664
Ride Topic 50	50	1	-	0,7	BR7ES	5122	-	BR7EIX	6664
Ride Twister 50	50	1	-	0,7	BR7ES	5122	-	BR7EIX	6664
Ride Vendetta 50	50	1	-	0,5	BR8HSA	5539	-	BR8HIX	7001
Roc 50	50	1	-	0,7	BR7ES	5122	-	BR7EIX	6664
Toxic 50	50	1	-	0,7	BR7ES	5122	-	BR7EIX	6664
Trigger SM / X50	50	1	2007-	0,7	BR7ES	5122	-	BR7EIX	6664
Trigger SM/X Competition Full Power	50		-	0,7	BR9ES	5722	Q208	BR9EIX	3981
Twister 50	50	1	-	0,7	BR7ES	5122	-	BR7EIX	6664
Vendetta 50	50	1	-	0,5	BR8HSA	5539	-	BR8HIX	7001
XOR 50	50	1	-	0,7	BR7ES	5122	-	BR7EIX	6664
Explorer Race 125	125	1	-	0,7	CR8E	1275	Q226	CR8EIX	4218
Race 125	125	1	-	0,7	CR8E	1275	Q226	CR8EIX	4218
Ride Sarrio 125	125	1	-	0,7	CR8E	1275	Q226	CR8EIX	4218
Soho 125	125	1	-	0,7	CR8E	1275	Q226	CR8EIX	4218
XOR 125	125	1	-	0,5	CR7HSA	4549	-	CR7HIX	7544
Zion125	125	1	-	0,7	CR8E	1275	Q226	CR8EIX	4218
Soho 150	150	1	-	0,7	CR8E	1275	Q226	CR8EIX	4218

GILERA

50 TS	50	1	1979-1982	0,5	B7ES	1111	-	BR7EIX	6664
CB1 4V	50	1	-	0,5	B6ES	7310	-	-	-
CBA, SS, SSV	50	1	-	0,5	B6HS	4510	Q203	BR6HIX	3419
DD-Runner	50	1	1997-	0,6	B9EG	3530	-	-	-
DD-Stalker	50	1	1997-	0,6	B9ES	2611	Q202	BR9EIX	3981
DNA	50	1	2000-	0,5	B9ES	2611	Q202	BR9EIX	3981
Eaglet 50	50	1	-	0,5	B9ES	2611	Q202	BR9EIX	3981
Easy Mooving	50	1	1995-	0,5	B9ES	2611	Q202	BR9EIX	3981

* Bitte Elektrodenabstand nach Angaben des Herstellers justieren

* Please adjust the groundelectrode gap

* Veuillez vérifier L' écartement

* Por favor, ajustar distancia entre electrodos

* regolare il gap

C
Y
L

Stock-No

Quick-No



Stock-No IX

GILERA

EC 1	50	1	1992-	0,5	B5HS	4210	-	-	-
ECO	50	1	1979-	0,5	B6HS	4510	Q203	BR6HIX	3419
GP	50	1	2002-	0,6	B9EG	3530	-	-	-
GR 2	50	1	1977-1982	0,5	B6ES	7310	-	-	-
GR 2 (Export)	50	1	-	0,5	B7ES	1111	-	BR7EIX	6664
Grande	50	1	-	0,5	B6HS	4510	Q203	BR6HIX	3419
GSA	50	1	1982-	0,5	B6HS	4510	Q203	BR6HIX	3419
GSM-Gilera 2 Stroke	50		2000-	0,7	BR9ES	5722	Q208	BR9EIX	3981
H@K-Gilera 2 Stroke	50		2000-	0,7	BR9ES	5722	Q208	BR9EIX	3981
Ice	50	1	2002-	0,6	B9ES	2611	Q202	BR9EIX	3981
Jetrunner	50		2003-	0,8	CPR8E	7411	-	-	-
Pure Jet 50 Direct Injection 2 Stroke	50		2004-	0,8	CPR8E	7411	-	-	-
RCR-4 Stroke	50	1	2006-	0,7	PMR7A	4259	-	-	-
RCR-Engine Derbi 2 Stroke	50		2004-	0,5	BR9ES	5722	Q208	BR9EIX	3981
RK	50	1	-	0,5	B9ES	2611	Q202	BR9EIX	3981
RS	50	1	1975-1980	0,5	B6ES	7310	-	-	-
Runner	50	1	1997-	0,6	B9EG	3530	-	-	-
Runner 2P 2D	50	1	1997-	0,6	B9ES	2611	Q202	BR9EIX	3981
Runner 50 2 Stroke	50		1997-	0,6	BR9ES	5722	Q208	BR9EIX	3981
Runner 50 4 Stroke	50		2004-	0,8	CPR8E	7411	-	-	-
Runner FX 125	50	1	1997-	0,6	B9ES	2611	Q202	BR9EIX	3981
Runner PJ	50	1	2005-	0,6	CPR8E	7411	-	-	-
Runner Pure Jet Injection	50	1	2003-2007	0,6	CPR8E	7411	-	-	-
Runner Racing Replica	50	1	2004-	0,6	BR9ES	5722	Q208	BR9EIX	3981
Runner RST 50	50	1	2005-	0,5	B9ES	2611	Q202	BR9EIX	3981
Runner SP	50	1	2000-	0,6	BR9ES	5722	Q208	BR9EIX	3981
SKP	50		1997-	0,5	BR9ES	5722	Q208	BR9EIX	3981
SMT	50		2005-	0,6	BR9ES	5722	Q208	BR9EIX	3981
SMT-4 Stroke	50	1	2006-	0,7	PMR7A	4259	-	-	-
SP-Runner	50	1	1997-	0,6	B9EG	3530	-	-	-
Stalker	50	1	1997-1999	0,6	B9ES	2611	Q202	BR9EIX	3981
Stalker	50	1	2000-	0,6	BR9ES	5722	Q208	BR9EIX	3981
Storm	50	1	1994-1999	0,6	B9ES	2611	Q202	BR9EIX	3981
Storm	50	1	2000-	0,6	BR9ES	5722	Q208	BR9EIX	3981
Super RE, RL	50	1	-	0,5	B6ES	7310	-	-	-
Touring	50	1	1973-1981	0,5	B7ES	1111	-	BR7EIX	6664
Trend 50	50	1	-	0,6	B5HS	4210	-	-	-
Trial	50	1	-	0,5	B7ES	1111	-	BR7EIX	6664
TS	50	1	1979-1982	0,5	B6ES	7310	-	-	-
Typhoon 50	50	1	1993-	0,6	B9ES	2611	Q202	BR9EIX	3981
Typhoon 50 Martini Racing	50	1	1995-	0,6	B9ES	2611	Q202	BR9EIX	3981
Typhoon Benetton F1	50	1	1996-	0,6	B9ES	2611	Q202	BR9EIX	3981
Zulu Trail	50	1	2001-	0,6	B9ES	2611	Q202	BR9EIX	3981
80 TG 2, 3	80	1	1982-1982	0,5	B9ES	2611	Q202	BR9EIX	3981
Jubilee	90	1	-	0,5	B7ES	1111	-	BR7EIX	6664
Giubileo 4 Stroke, SS	98	1	-	0,5	B8ES	2411	Q201	BR8EIX	5044
5V Regolarità	125	1	-	0,5	B10EGV	5927	-	-	-
Arcore, Export	125	1	1972-1980	0,5	B8ES	2411	Q201	BR8EIX	5044
Arizona	125	1	-	0,5	B8ES	2411	Q201	BR8EIX	5044
C1	125	1	-	0,5	B105EGV	2171	-	-	-
C3	125	1	-	0,5	B10EGV	5927	-	-	-

* Bitte Elektrodenabstand nach Angaben des Herstellers justieren

* Please adjust the groundelectrode gap

* Veuillez vérifier L' écartement

* Por favor, ajustar distancia entre electrodos

* regolare il gap

C
y
l

0201



Stock-№

Quick-№



Stock-№ IX

GILERA

Cougar	125	1	2000-	0,9	DPR8EA-9	4929	Q221	DPR8EIX-9	2202
Crono	125		-	0,6	B10EG	3630	-	-	-
Cross Competition	125	1	-	0,5	B105EGV	2171	-	-	-
CX-Apache	125		-	0,6	B10EG	3630	-	-	-
DD-Runner	125	1	1997-2000	0,5	B9EG	3530	-	-	-
DNA-4 Stroke	125	1	2000-	0,7	CR9EB	6955	-	CR9EIX	3521
E1	125	1	-	0,5	B105EGV	2171	-	-	-
E1 Competition	125	1	2001-	0,5	B105EGV	2171	-	-	-
Endurance	125	1	-	0,5	B9ES	2611	Q202	BR9EIX	3981
Enduro	125	1	-	0,5	B105EGV	2171	-	-	-
ER	125	1	1987-1988	0,5	B9ES	2611	Q202	BR9EIX	3981
Fast Bike	125	1	1987-1988	0,5	B9ES	2611	Q202	BR9EIX	3981
Freestyle 2 Stroke	125		-	0,6	B10EG	3630	-	-	-
FX-Runner	125	1	1997-2000	0,5	B9EG	3530	-	-	-
GFR	125		-	0,6	-	-	-	BR10EIX	6801
GR1	125	1	1976-1981	0,5	B7ES	1111	-	BR7EIX	6664
Hawk	125	1	1985-1986	0,5	B9ES	2611	Q202	BR9EIX	3981
HX	125	1	-	0,5	B10EGV	5927	-	-	-
KK	125	1	1986-1987	0,5	B9ES	2611	Q202	BR9EIX	3981
KZ	125	1	1986-1989	0,5	B9ES	2611	Q202	BR9EIX	3981
Nexus ie	125	1	2007-	0,6	CR8EB	7784	-	CR8EIX	4218
R1 S	125	1	1989-	0,5	B9EG	3530	-	-	-
RC Rally	125	1	-	0,5	B9ES	2611	Q202	BR9EIX	3981
RTT Nebraska	125	1	1986-1988	0,5	B9ES	2611	Q202	BR9EIX	3981
RTX	125	1	1986-1986	0,5	B9EG	3530	-	-	-
Runner RST	125	1	2005-	0,7	CR8EB	7784	-	CR8EIX	4218
Runner ST	125	1	2005-	0,7	CR8EB	7784	-	CR8EIX	4218
Runner VX	125	1	2006-	0,7	CR8EB	7784	-	CR8EIX	4218
Runner VX 4 Stroke	125	1	2001-	0,7	CR9EB	6955	-	CR9EIX	3521
RV	125	1	1984-1986	0,5	B9EG	3530	-	-	-
RX	125	1	1984-1985	0,5	B9EG	3530	-	-	-
SC-2 Stroke	125		2006-	0,7	BR8ES	5422	Q207	BR8EIX	5044
SC-Engine Yamaha 4 Stroke	125		2007-	0,7	BR8ES	5422	Q207	BR8EIX	5044
SP-Runner 2 Stroke	125	1	1997-2000	0,5	B9EG	3530	-	-	-
SV Regolarità	125	1	-	0,5	B95EGV	2145	-	-	-
TG1	125	1	-	0,5	B7ES	1111	-	BR7EIX	6664
TG2	125	1	1976-1981	0,5	B7ES	1111	-	BR7EIX	6664
TG3	125	1	1981-1983	0,5	B8ES	2411	Q201	BR8EIX	5044
Top Rally RC	125	1	1990-	0,5	B10EG	3630	-	-	-
Typhoon	125	1	1995-	0,6	B9ES	2611	Q202	BR9EIX	3981
XR 2	125	1	1989-	0,5	B9EG	3530	-	-	-
XRI	125	1	-	0,5	B9EG	3530	-	-	-
150 Arcore, Export	150	1	1982-1980	0,5	B8ES	2411	Q201	BR8EIX	5044
Runner	150	1	1998-	0,6	BR9ES	5722	Q208	BR9EIX	3981
DNA-Leader 4 Stroke	180	1	2000-	0,7	CR9EB	6955	-	CR9EIX	3521
Runner FXR 2 Stroke	180	1	1998-	0,6	BR9ES	5722	Q208	BR9EIX	3981
Runner VXR 4 Stroke	180	1	2001-	0,7	CR9EB	6955	-	CR9EIX	3521
200 T4	200	1	1982-1984	0,5	B8ES	2411	Q201	BR8EIX	5044
Arizona	200	1	1985-1986	0,5	B9EG	3530	-	-	-
RTX	200	1	1986-1986	0,5	B9EG	3530	-	-	-
Runner ST	200	1	2008-	0,7	CR8EB	7784	-	CR8EIX	4218
Runner VXR 4 Stroke	200	1	2002-2008	0,6	CR8EB	7784	-	CR8EIX	4218

* Bitte Elektrodenabstand nach Angaben des Herstellers justieren

* Please adjust the groundelectrode gap

* Veuillez vérifier L' écartement

* Por favor, ajustar distancia entre electrodos

* regolare il gap

C
Y
L

Stock-No

Quick-No



Stock-No IX

GILERA

RV 200 LC	200	1	1985-1986	0,5	B9EG	3530	-	-	-
RX 200 LC	200	1	1985-1986	0,5	B9EG	3530	-	-	-
Nexus ie	250	1	2007-	0,7	PMR8B	6378	-	-	-
Nexus SP	250	1	2006-	0,6	CR8EB	7784	-	CR8EIX	4218
Nexus	300	1	2009-	0,7	CR8EKB	4374	-	CR8EIX	4218
Dakota (4-Stroke)	350	1	-	0,9	DP9EA-9	6629	-	DPR8EIX-9	2202
Saturno (4-Stroke)	350	1	1990-	0,6	DPR8EA-9	4929	Q221	DPR8EIX-9	2202
Dakota (4-Stroke)	500	1	-	0,9	DP9EA-9	6629	-	DPR9EIX-9	5545
Fuoco ie	500	1	2007-	0,6	CR7EKB	4455	-	CR7EIX	7385
Nexus ie - Eng. Piaggio	500	1	2004-2005	0,6	CR7EKB	4455	-	CR7EIX	7385
Saturno	500	1	-	0,9	DP9EA-9	6629	-	DPR9EIX-9	5545
FB-Nordcape	600		1992-	0,8	D8EA	2120	Q216	DR8EIX	6681
Nordwest	600	1	-	0,7	DCPR8E	4339	-	DCPR8EIX	6546
RC-C	600		1992-	0,8	D8EA	2120	Q216	DR8EIX	6681
Supersport	600		2002-	0,6	CR9E	6263	Q227	CR9EIX	3521
GP-800	800	2	2007-	0,7	CR7EKB	4455	-	CR7EIX	7385

HARLEY DAVIDSON

Sportster	883	2	1995-2003	0,9	DPR7EA-9	5129	Q220	DPR7EIX-9	7803
Sportster	883	2	2004-	1,0	DCPR7E	3932	-	DCPR7EIX	6046
Sportster Deluxe	883	2	1986-1989	0,9	DPR7EA-9	5129	Q220	DPR7EIX-9	7803
Sportster Iron	883	2	2009-	0,9	DCPR7EA-9	6651	-	-	-
Sportster Low	883	2	2004-	0,9	DCPR7EA-9	6651	-	-	-
Sportster R	883	2	2002-2004	0,9	DPR7EA-9	5129	Q220	DPR7EIX-9	7803
All Models	883	2	1985-1985	0,9	DCPR7E	3932	-	DCPR7EIX	6046
XL-C / L / R Sporster / Custom	883	2	2007-	1,0	DCPR7E	3932	-	DCPR7EIX	6046
XL-R Sports	883	2	2002-	0,9	DCPR7E	3932	-	DCPR7EIX	6046
XL	1000	2	-1978	0,7	B-6L	3212	-	-	-
XL	1000	2	1979-1985	1,0	BPR6HS-10	2633	-	-	-
Evolution	1100	2	1986-1988	0,9	DPR7EA-9	5129	Q220	DPR7EIX-9	7803
Sportster	1100		1986-1987	1,0	DCPR7E	3932	-	DCPR7EIX	6046
VRSCA-Night-Rod	1130	2	2006-	0,6	DCPR9E	2641	-	DCPR9EIX	2316
VRSCA-V-Rod	1130	2	2002-2009	0,9	DPR9EA-9	5329	Q222	DPR9EIX-9	5545
VRSCDX-Night Rod Special	1130	2	2007-	1,0	DCPR7E	3932	-	DCPR7EIX	6046
VRSC-V-Rod, Night Rod, Street Rod	1130	2	2002-	0,9	DCPR8E	4339	-	DCPR8EIX	6546
VRSCX	1130	2	2007-	1,0	DCPR7E	3932	-	DCPR7EIX	6046
Evolution	1200	2	1988-	0,9	DPR7EA-9	5129	Q220	DPR7EIX-9	7803
FL Panhead	1200	2	1948-1965	0,7	XR5	3332	-	XR5IX	7355
FL Shovel Head	1200	2	1966-1974	0,7	XR5	3332	-	XR5IX	7355
FL Shovel Head	1200	2	1975-1981	1,1	BPR5ES-11	4424	-	BPR5EIX-11	2115
FLH, FLHR, FX, FXE, FXEF, FXS	1200		1975-1981	1,0	BPR5ES-11	4424	-	BPR5EIX-11	2115
FX Panhead	1200	2	1948-1965	0,7	XR5	3332	-	XR5IX	7355
FX Shovel Head	1200	2	1966-1974	0,7	XR5	3332	-	XR5IX	7355
FX Shovel Head	1200	2	1975-1981	1,1	BPR5ES-11	4424	-	BPR5EIX-11	2115
Sporster Custom	1200	2	2004-	1,0	DCPR7E	3932	-	DCPR7EIX	6046
Sportster 1200 Nightster	1200	2	2008-	1,0	DCPR8E	4339	-	DCPR8EIX	6546
VRSC- V-Rod	1200	2	2008-	1,0	DCPR8E	4339	-	DCPR8EIX	6546
XL-C Sportster / Custom	1200	2	2007-	1,0	DCPR7E	3932	-	DCPR7EIX	6046
XL-C Sportster Custom	1200	2	1996-	1,0	DCPR7E	3932	-	DCPR7EIX	6046
XLH-Sportster	1200	2	1992-1999	1,0	DCPR7E	3932	-	DCPR7EIX	6046
XL-L Sportster / Low	1200	2	2007-	1,0	DCPR7E	3932	-	DCPR7EIX	6046
XL-R Sportster	1200	2	2007-	1,0	DCPR7E	3932	-	DCPR7EIX	6046

* Bitte Elektrodenabstand nach Angaben des Herstellers justieren

* Please adjust the groundelectrode gap

* Veuillez vérifier l' écartement

* Por favor, ajustar distancia entre electrodos

* regolare il gap

C
Y
L

0201



Stock-№

Quick-№



Stock-№ IX

HARLEY DAVIDSON

XL-S Sportster Sport	1200	2	1996-	1,0	DCPR7E	3932	-	DCPR7EIX	6046
XR	1200	2	2007-2008	1,0	DCPR7E	3932	-	DCPR7EIX	6046
XR	1200	2	2008-2009	0,9	DCPR8E	4339	-	DCPR8EIX	6546
XR-X	1200	2	2010-	0,9	DCPR8E	4339	-	DCPR8EIX	6546
VRSC-E-Screamin' Eagle V-Rod	1250	2	2004-	0,6	DCPR9E	2641	-	DCPR9EIX	2316
VRSC-Nighth Rod Special	1250	2	2008-	0,9	DCPR8E	4339	-	DCPR8EIX	6546
VRSC-V-Rod Muscle, 10th Anniversary	1250	2	2010-	0,9	DCPR8E	4339	-	DCPR8EIX	6546
Evolution	1340	2	1984-2000	1,1	BPR5ES-11	4424	-	BPR5EIX-11	2115
FKDWG-Dyna Wide Glide	1340	2	-	0,8	BPR5ES	7422	-	BPR5EIX	6597
FLHRCI-Road King Classic inj.	1340	2	1996-	1,1	BPR5ES-11	4424	-	BPR5EIX-11	2115
FLHRCI-Road King Classic side car	1340	2	-	0,8	BPR5ES	7422	-	BPR5EIX	6597
FLHR-Electra Glide Road King	1340	2	1994-	0,8	BPR5ES	7422	-	BPR5EIX	6597
FLHR-Electra Glide Road King Inj.	1340	2	1996-	1,1	BPR5ES-11	4424	-	BPR5EIX-11	2115
FLHTC-Electra Glide Classic	1340	2	-	0,8	BPR5ES	7422	-	BPR5EIX	6597
FLHTCI-Electra Glide Classic inj.	1340	2	1996-	1,1	BPR5ES-11	4424	-	BPR5EIX-11	2115
FLHTCU-Electra Glide Ultra Classic	1340	2	-	0,8	BPR5ES	7422	-	BPR5EIX	6597
FLHTCUI-Electra Glide Ultra Classic Inj.	1340	2	1996-	1,1	BPR5ES-11	4424	-	BPR5EIX-11	2115
FLHT-Electra Glide Standard	1340	2	-	0,8	BPR5ES	7422	-	BPR5EIX	6597
FLSTC-Heritage Softail Classic	1340	2	-	0,8	BPR5ES	7422	-	BPR5EIX	6597
FLSTF-Fat Boy	1340	2	-	0,8	BPR5ES	7422	-	BPR5EIX	6597
FLSTS-Heritage Softail Springer	1340	2	-	0,8	BPR5ES	7422	-	BPR5EIX	6597
FXD-Dyna Super Glide	1340	2	-	0,8	BPR5ES	7422	-	BPR5EIX	6597
FXDL-Dyna Low Rider	1340	2	-	0,8	BPR5ES	7422	-	BPR5EIX	6597
FXDS-Conv Dyna Convertible	1340	2	-	0,8	BPR5ES	7422	-	BPR5EIX	6597
FXE-Shovel Head	1340	2	1984-	1,0	ZGR5C	6334	-	-	-
FXSB-Shovel Head	1340	2	1984-	1,0	ZGR5C	6334	-	-	-
FXST-Softail Custom	1340	2	-	0,8	BPR5ES	7422	-	BPR5EIX	6597
FXSTS-Softail Springer	1340	2	-	0,8	BPR5ES	7422	-	BPR5EIX	6597
FX-V-2 Evolution	1340	2	1984-2000	1,1	BPR5ES-11	4424	-	BPR5EIX-11	2115
FXWG-Shovel Head	1340	2	1984-	1,0	ZGR5C	6334	-	-	-
TXSTSB-Bad Boy	1340	2	-	0,8	BPR5ES	7422	-	BPR5EIX	6597
FLHRCi-Road King Classic side car	1450	2	1999-2003	1,0	DCPR7E	3932	-	DCPR7EIX	6046
FLHR-Electra Glide Road King	1450	2	1999-2003	1,0	DCPR7E	3932	-	DCPR7EIX	6046
FLHRCi-Electra Glide Road King Classic Inj.	1450	2	1999-2003	1,0	DCPR7E	3932	-	DCPR7EIX	6046
FLHTCUI-Electra Glide Ultra Classic Inj.	1450	2	1999-2003	1,0	DCPR7E	3932	-	DCPR7EIX	6046
FLHT-Electra Glide Standard	1450	2	1999-2003	1,0	DCPR7E	3932	-	DCPR7EIX	6046
FLSTC-Héritage Softail Classic	1450	2	1999-2003	1,0	DCPR7E	3932	-	DCPR7EIX	6046
FLSTCi-Héritage Softail Classic inj.	1450	2	1999-2003	1,0	DCPR7E	3932	-	DCPR7EIX	6046
FLSTS-Fat Boy	1450	2	1999-2003	1,0	DCPR7E	3932	-	DCPR7EIX	6046
FLSTSi-Fat Boy inj.	1450	2	1999-2003	1,0	DCPR7E	3932	-	DCPR7EIX	6046
FL-TC88	1450		1998-2007	0,8	DCPR7E	3932	-	DCPR7EIX	6046
FXD-Dyna Super Glide	1450	2	1999-2003	1,0	DCPR7E	3932	-	DCPR7EIX	6046
FXDL-Dyna Low Rider	1450	2	1999-2003	1,0	DCPR7E	3932	-	DCPR7EIX	6046
FXDWG-Dyna Wide Glide	1450	2	1999-2003	1,0	DCPR7E	3932	-	DCPR7EIX	6046
FXDX-Dyna Super Glide Sport	1450	2	1999-2003	1,0	DCPR7E	3932	-	DCPR7EIX	6046
FXDXT-Dyna Super Glide Touring Sport	1450	2	1999-2003	1,0	DCPR7E	3932	-	DCPR7EIX	6046
FXSTB-Night Train	1450	2	1999-2003	1,0	DCPR7E	3932	-	DCPR7EIX	6046
FXSTDi-Softail Deuce inj.	1450	2	1999-2003	1,0	DCPR7E	3932	-	DCPR7EIX	6046
FXSTD-Softail Deuce	1450	2	1999-2003	1,0	DCPR7E	3932	-	DCPR7EIX	6046
FXST-Softail	1450	2	1999-2003	1,0	DCPR7E	3932	-	DCPR7EIX	6046
FXSTS-Softail Springer	1450	2	1999-2003	1,0	DCPR7E	3932	-	DCPR7EIX	6046
FX-TC88	1450		1998-2007	0,8	DCPR7E	3932	-	DCPR7EIX	6046

* Bitte Elektrodenabstand nach Angaben des Herstellers justieren

* Please adjust the groundelectrode gap

* Veuillez vérifier L' écartement

* Por favor, ajustar distancia entre electrodos

* regolare il gap

C
Y
L

Stock-No

Quick-No



Stock-No IX

HARLEY DAVIDSON

Blackline	1584		2011-	0,9	DCPR8E	4339	-	DCPR8EIX	6546
CVO Fat Bob	1584	2	2009-	0,9	DCPR8E	4339	-	DCPR8EIX	6546
Dyna Wide Glide	1584	2	2009-	0,8	DCPR8E	4339	-	DCPR8EIX	6546
FLHRC-Road King Classic	1584	2	2007-	1,0	DCPR7E	3932	-	DCPR7EIX	6046
FLHR-Road King	1584	2	2008-	1,0	DCPR8E	4339	-	DCPR8EIX	6546
FLHRS-Road King Custom	1584	2	2007-	1,0	DCPR7E	3932	-	DCPR7EIX	6046
FLHTCU-Ultra Classic Electra Glide	1584	2	2007-	1,0	DCPR7E	3932	-	DCPR7EIX	6046
FLHT-Electra Glide Standard	1584	2	2007-	1,0	DCPR7E	3932	-	DCPR7EIX	6046
FLHX-Street Glide	1584	2	2007-	1,0	DCPR7E	3932	-	DCPR7EIX	6046
FLSTC-Heritage Softail	1584	2	2007-	1,0	DCPR7E	3932	-	DCPR7EIX	6046
FLSTF-Fat Boy	1584	2	2007-	1,0	DCPR7E	3932	-	DCPR7EIX	6046
FLSTN-Softail Deluxe	1584	2	2007-	1,0	DCPR7E	3932	-	DCPR7EIX	6046
FLSTSB-Cross Bones	1584	2	2008-	0,9	DCPR8E	4339	-	DCPR8EIX	6546
FLSTSC-Softail Springer Classic	1584	2	2007-	1,0	DCPR7E	3932	-	DCPR7EIX	6046
FXDB-Dyna Street	1584	2	2007-	1,0	DCPR7E	3932	-	DCPR7EIX	6046
FXDC-Dyna Super Glide Custom	1584	2	2007-	1,0	DCPR7E	3932	-	DCPR7EIX	6046
FXDL-Dyna Low Rider	1584	2	2007-	1,0	DCPR7E	3932	-	DCPR7EIX	6046
FXDWG -Dyna Wide Glide	1584	2	2007-	1,0	DCPR7E	3932	-	DCPR7EIX	6046
FXSTB-Night Train	1584	2	2007-	1,0	DCPR7E	3932	-	DCPR7EIX	6046
FXSTC-Softail Custom	1584	2	2007-	1,0	DCPR7E	3932	-	DCPR7EIX	6046
Softail Deuce	1584	2	2007-	1,0	DCPR8E	4339	-	DCPR8EIX	6546
Softail Fatboy Lo	1584	2	2007-2010	1,0	DCPR8E	4339	-	DCPR8EIX	6546
Softail Rocker	1584	2	2008-	0,9	DCPR8E	4339	-	DCPR8EIX	6546
Touring Road Glide	1584	2	2007-2010	1,0	DCPR8E	4339	-	DCPR8EIX	6546
Touring Road Glide Custom	1584	2	2010-	1,0	DCPR8E	4339	-	DCPR8EIX	6546
Touring Road King	1584	2	2007-2010	1,0	DCPR8E	4339	-	DCPR8EIX	6546
Touring Tri Glide Ultra Classic	1584	2	2009-	1,0	DCPR8E	4339	-	DCPR8EIX	6546
Twin Cam 96B Models	1584		2006-	0,9	DCPR8E	4339	-	DCPR8EIX	6546
E-Glide Ultra Limited	1690	2	2010-	0,9	DCPR8E	4339	-	DCPR8EIX	6546
CVO / Street / Fat Bob	1800	2	2009-	0,9	DCPR8E	4339	-	DCPR8EIX	6546
LTRSE-CVO	1800	2	2009-	0,9	DCPR8E	4339	-	DCPR8EIX	6546

HERKULES

BT 50 (Engine 4 Stroke Baotian)	50		2005-	0,7	C7HSA	4629	-	CR7HIX	7544
TB 50 Race	50		2005-	0,6	BPR7HS	6422	Q215	BPR7HIX	5944

HERO-PUCH

Blinker, Stark, Turbo Sport	50		1994-	0,5	BP5ES	6511	-	BPR5EIX	6597
-----------------------------	----	--	-------	-----	-------	------	---	---------	------

HIGHLAND

450 MX	450	1	2007-	0,6	CR8E	1275	Q226	CR8EIX	4218
Outback	450	1	2003-	0,6	CR8E	1275	Q226	CR8EIX	4218
Allroad	950	2	2004-	0,6	CR8E	1275	Q226	CR8EIX	4218
Dessert Strom	950	2	2006-	0,6	CR8E	1275	Q226	CR8EIX	4218
Dirt Trac	950	2	2007-	0,6	CR8E	1275	Q226	CR8EIX	4218
Super Motard	950	1	2007-	0,6	CR8E	1275	Q226	CR8EIX	4218

HM RACING

CRX-CRX Racing Junior & Senior	50	1	2001-	0,5	B8HS	5510	Q205	BR8HIX	7001
CRX-Junior & Senior	50	1	2001-	0,6	B8HS	5510	Q205	BR8HIX	7001

* Bitte Elektrodenabstand nach Angaben des Herstellers justieren

* Please adjust the groundelectrode gap

* Veuillez vérifier l' écartement

* Por favor, ajustar distancia entre electrodos

* regolare il gap

C
y
l

0201



Stock-№

Quick-№



Stock-№ IX

HM RACING

MX-Junior & Senior	50	1	2001-	0,6	B8HS	5510	Q205	BR8HIX	7001
Six, Baja, Derapage	50	1	1997-	0,6	B8ES	2411	Q201	BR8EIX	5044

HMZ

Cab SB50	50	1	1996-	0,6	BP6HS	4511	-	BPR6HIX	4085
Cruise 125	125	1	1996-	0,6	D8EA	2120	Q216	DR8EIX	6681

HONDA

C50	50	1	-	0,7	C7HSA	4629	-	CR7HIX	7544
C50C	50	1	-	0,7	CR7HS	7223	-	CR7HIX	7544
CB-V Dream 50	50	1	1998-	0,9	CR8EH-9	5666	Q228	CR8EHIX-9	3797
CRF-F	50	1	2004-	0,7	CR6HSA	2983	-	CR6HIX	7274
DIO 50	50	1	2004-	0,7	ER8EH-N	5606	-	ER8EHIX	8201
NH-Lead F	50	1	1985-1988	0,7	BPR6HS	7022	Q214	BPR6HIX	4085
NH-Lead H	50	1	1987-1988	0,7	BPR6HS	7022	Q214	BPR6HIX	4085
NH-Lead J	50	1	1987-1988	0,7	BPR6HS	7022	Q214	BPR6HIX	4085
NH-M	50	1	1993-	0,7	BPR6HS	7022	Q214	BPR6HIX	4085
NH-MS Lead	50	1	1985-1987	0,7	BPR6HS	7022	Q214	BPR6HIX	4085
NSC-Vision	50	1	2012-	0,9	CR7HSA-9	5147	-	CR7HIX	7544
NS-R	50	1	-	0,8	B8ES	2411	Q201	BR8EIX	5044
NSR-A K	50	1	1989-	0,7	BR9ES	5722	Q208	BR9EIX	3981
PK-Wallaro	50	1	1990-	0,6	BR6HSA	4296	Q210	BR6HIX	3419
PX	50	1	1989-1990	0,6	BPR5HS	6222	-	-	-
PXR	50	1	1987-	0,7	BPR5HS	6222	-	-	-
PX-S	50	1	1987-	0,7	BPR5HS	6222	-	-	-
RTL-SF	50	1	1987-	0,8	B8ES	2411	Q201	BR8EIX	5044
SFX-S>1	50	1	1995-2000	0,7	BR6HSA	4296	Q210	BR6HIX	3419
SGX-Sky (V/W)	50	1	1997-1998	0,7	BR6HSA	4296	Q210	BR6HIX	3419
SH-H	50	1	1987-	0,7	BPR6HS	7022	Q214	BPR6HIX	4085
SH-New	50	1	1997-	0,6	BPR6HS	7022	Q214	BPR6HIX	4085
SH-P - Scoopy	50	1	1993-1995	0,7	BPR6HSA	4632	-	BPR6HIX	4085
SH-R - Scoopy	50	1	1993-	0,7	BPR6HS	7022	Q214	BPR6HIX	4085
SH-T - Scoopy	50	1	1996-	0,7	BR6HSA	4296	Q210	BR6HIX	3419
SJ-Baly (P>Y)	50	1	1993-	0,7	BR6HSA	4296	Q210	BR6HIX	3419
SRX-Shadow (W/X)	50	1	1997-1999	0,7	BR6HSA	4296	Q210	BR6HIX	3419
SRX-T - Joker	50	1	1997-1999	0,5	BR6HSA	4296	Q210	BR6HIX	3419
SXR-W	50	1	1998-	0,6	BR6HSA	4296	Q210	BR6HIX	3419
SZX-S (X8R-S Super Sport) (W>1)	50	1	1998-	0,7	BR6HSA	4296	Q210	BR6HIX	3419
SZX-X (X8R-X Cross Sport) (W>1)	50	1	1998-	0,7	BR6HSA	4296	Q210	BR6HIX	3419
TLM-F (High Speed)	50	1	1985-	0,8	BR9ES	5422	Q208	BR8EIX	5044
TLM-F Cold	50	1	1985-	0,8	BR7ES	5422	-	BR8EIX	5044
TLM-F Standard	50	1	1985-	0,8	BR8ES	5422	Q207	BR8EIX	5044
XR	50	1	1993-2002	0,7	CR6HSA	2983	-	CR6HIX	7274
XR-R	50	1	2000-	0,7	CR6HSA	2983	-	CR6HIX	7274
ZB-J	50	1	1988-	0,7	CR6HSA	2983	-	CR6HIX	7274
Z-JJ M	50	1	1991-	0,7	CR6HS	7023	Q223	CR6HIX	7274
Z-Monkey	50	1	1971-1986	0,7	CR6HS	7023	Q223	CR6HIX	7274
Zoomer	50	1	2005-	0,7	ER8EH-N	5606	-	ER8EHIX	8201
CRF-F	70	1	2004-	0,7	CR6HSA	2983	-	CR6HIX	7274
CT	70	1	1980-1992	0,7	CR6HSA	2983	-	CR6HIX	7274
ST-Dax (L>T)	70	1	1990-1996	0,7	CR6HSA	2983	-	CR6HIX	7274
XR-R (V>1)	70	1	1997-2000	0,7	CR6HSA	2983	-	CR6HIX	7274

* Bitte Elektrodenabstand nach Angaben des Herstellers justieren

* Please adjust the groundelectrode gap

* Veuillez vérifier L' écartement

* Por favor, ajustar distancia entre electrodos

* regolare il gap

C
Y
L

Stock-No

Quick-No



Stock-No IX

HONDA

CR-R	80	1	1996-2002	0,6	BR10EG	3830	-	-	-
CR-R & RB (G>1)	80	1	1986-1995	0,6	BR10EG	3830	-	-	-
MBX-SWD, SW2D,SWDD	80	1	1982-1987	0,8	BR9ES	5722	Q208	BR9EIX	3981
MT	80	1	1985-	0,7	BR9HS	4522	-	BR9HIX	5687
NH-MD/H-P	80	1	1982-1996	0,7	BPR6HS	7022	Q214	BPR6HIX	4085
NH-MS (N/P/R)	80	1	1992-	0,7	BPR6HS	7022	Q214	BPR6HIX	4085
XR-R (M/P/R/S)	80	1	1992-1995	0,7	CR7HSA	4549	-	CR7HIX	7544
CR-RB	85	1	2005-2008	0,6	BR10EG	3830	-	-	-
EZ-Cub (M)	90	1	1991-	0,7	BR7HS	4122	Q211	BR7HIX	7067
SRX-Shadow (W/X)	90	1	1998-1999	0,7	BR6HSA	4296	Q210	BR6HIX	3419
CRF-F	100	1	2004-2007	0,9	CR7HSA	4549	-	CR7HIX	7544
CRF-F	100	1	2008-	0,7	CR7HSA	4549	-	CR7HIX	7544
SCV-Lead	100	1	2003-	0,7	CR6HSA	2983	-	CR6HIX	7274
SCV-Lead	100	1	2008-	0,9	CR8EH-9	5666	Q228	CR8EHIX-9	3797
SH-T - Scoopy	100	1	1996-	0,7	BR6HSA	4296	Q210	BR6HIX	3419
SJ-EX Baly (T>Y)	100	1	1996-	0,7	BR6HSA	4296	Q210	BR6HIX	3419
XR-R (F-3)	100	1	1985-2003	0,7	CR7HSA	4549	-	CR7HIX	7544
NHX-WH	110	1	2008-	0,9	CR7EH-9	3486	-	-	-
NSC-Vision 4 Stroke	110	1	2011-	0,9	CPR8EA-9	2306	-	-	-
SCR	110	1	2013-	0,9	CPR8EA-9	2306	-	-	-
@	125	1	2000-	0,8	CR8EH-9	5666	Q228	CR8EHIX-9	3797
ANF	125	1	2004-	0,9	CPR6EA-9	6899	-	-	-
ANF-Innova	125	1	2007-	0,9	CPR6EA-9	6899	-	-	-
ANF-Innova i	125	1	2007-	0,9	CPR6EA-9	6899	-	-	-
CA-Rebel (S>Y)	125	2	1995-2000	0,7	CR6HSA	2983	-	CR6HIX	7274
CBF	125	1	2007-	0,9	CPR7EA-9	3901	-	CPR7EAIX-9	9198
CBR-R, RR	125	1	2003-2010	0,6	CR8E	1275	Q226	CR8EIX	4218
CBR-RW B-F	125	1	2011-	0,6	CR8E	1275	Q226	CR8EIX	4218
CB-TD (J)	125	2	1988-	0,7	CR7HSA	4549	-	CR7HIX	7544
CB-Twin (all models)	125	2	1978-1984	0,7	CR8HSA	2086	-	CR8HIX	7669
CG-(N>X)	125	1	1992-1999	0,9	DPR8EA-9	4929	Q221	DPR8EIX-9	2202
CH-Spacy	125		1997-	0,9	DPR7EA-9	5129	Q220	DPR7EIX-9	7803
CLR-CityFly (X/Y)	125		1998-2000	0,9	DPR8EA-9	4929	Q221	DPR8EIX-9	2202
CM-C Custom (N/P/R)	125		1992-	0,7	CR7HSA	4549	-	CR7HIX	7544
CRE-F (BE/E)	125	1	2014-	0,9	CPR6EA-9	6899	-	-	-
CRM-R (L>Y)	125		1990-2000	0,7	BR9ECS	3570	-	-	-
CR-R (1-7)	125	1	2001-2007	0,6	BR9EG	3230	-	-	-
F5-Dylan	125	1	2002-	0,8	CR8EH-9	5666	Q228	CR8EHIX-9	3797
FES-AB-F Silver Wing ABS	125		2011-	0,9	CR8EH-9	5666	Q228	CR8EHIX-9	3797
FES-Pantheon (W/X/Y/1) 2 Stroke	125	1	1998-	0,7	BR8ES	5422	Q207	BR8EIX	5044
FES-Pantheon 2 (4 Stroke)	125	1	2003-	0,8	CR8EH-9	5666	Q228	CR8EHIX-9	3797
MSX	125	1	2013-	0,9	CPR6EA-9	6899	-	-	-
MTX-R2 (H)	125		1987-	0,8	BR8ES	5422	Q207	BR8EIX	5044
NES-Y / ES (1)	125		2000-	0,9	CR8EH-9	5666	Q228	CR8EHIX-9	3797
NH	125		-	0,7	BR6HS	3922	Q209	BR6HIX	3419
NSR-125R	125		1986-	0,7	BR9ECS	3570	-	-	-
NSR-F (1)	125		2001-	0,7	BR9ECS	3570	-	-	-
NX-Transcity (K>W)	125		1989-1998	0,7	DR8ES	5423	Q217	DR8EIX	6681
PCX	125	1	2010-	0,9	CPR7EA-9	3901	-	CPR7EAIX-9	9198
PCX-EX2 Top Box	125		2011-	0,9	CPR7EA-9	3901	-	CPR7EAIX-9	9198
PS-i	125	1	2006-	0,9	CR8EH-9	5666	Q228	CR8EHIX-9	3797
RS-R	125		2001-	0,6	R7376-10	4457	-	-	-

* Bitte Elektrodenabstand nach Angaben des Herstellers justieren

* Please adjust the groundelectrode gap

* Veuillez vérifier L' écartement

* Por favor, ajustar distancia entre electrodos

* regolare il gap

C
Y
L

0201



Stock-Nr

Quick-Nr



Stock-Nr IX

HONDA

SES-Dylan	125		2002-	0,9	CR8EH-9	5666	Q228	CR8EHIX-9	3797
SH-B-F Injection	125		2011-	0,9	CR8EH-9	5666	Q228	CR8EHIX-9	3797
SH-i	125		2013-	0,9	CPR7EA-9	3901	-	-	-
SH-i / Sport / Special	125	1	2005-2012	0,9	CR8EH-9	5666	Q228	CR8EHIX-9	3797
SH-Scoopy	125	1	2001-2004	0,9	CR8EH-9	5666	Q228	CR8EHIX-9	3797
VT-C Shadow	125		1999-2008	0,9	CR8EH-9	5666	Q228	CR8EHIX-9	3797
XLR	125		-1997	0,7	DR8ES-L	2923	Q218	DR8EIX	6681
XLR-R (W/X)	125		1997-1999	0,9	DPR8EA-9	4929	Q221	DPR8EIX-9	2202
XL-VB-3E Varadero Deluxe	125	2	2011-	0,9	CR8EH-9	5666	Q228	CR8EHIX-9	3797
XL-VB-EU Varadero 125	125	2	2011-	0,9	CR8EH-9	5666	Q228	CR8EHIX-9	3797
XLV-Varadero	125	2	2001-	0,9	CR8EH-9	5666	Q228	CR8EHIX-9	3797
XR-L	125		2003-	0,9	DPR8EA-9	4929	Q221	DPR8EIX-9	2202
CRF-Expert (RB7/8/9/A/B/C/D/E)	150	1	2007-2014	0,9	CR8EH-9	5666	Q228	CR8EHIX-9	3797
CRF-R (R7/8/9/A/B/C/D/E)	150	1	2007-	0,9	CR8EH-9	5666	Q228	CR8EHIX-9	3797
Dylan	150		2002-2005	0,9	CR8EH-9	5666	Q228	CR8EHIX-9	3797
FES-S-Wing ABS	150	1	2007-	0,9	CR8EH-9	5666	Q228	CR8EHIX-9	3797
SH-i / Sport / Special	150	1	2006-	0,9	CR8EH-9	5666	Q228	CR8EHIX-9	3797
CD-T	200		1979-1982	0,7	CR7HS	7223	-	CR7HIX	7544
CM-T (A/B)	200	2	1980-1981	0,7	CR7HS	7223	-	CR7HIX	7544
CRF-F	230	1	2008-	0,8	DPR8EA-9	4929	Q221	DPR8EIX-9	2202
CB -Hornet (CB 250 FV)	250		1998-	0,9	-	-	-	CR8EHIX-9	3797
CBF	250		2004-2006	0,9	CR8EH-9	5666	Q228	CR8EHIX-9	3797
CB-G & G army	250		1974-	0,8	B8ES	2411	Q201	BR8EIX	5044
CB-K(0-4) & Dream	250		1968-1972	0,8	B8ES	2411	Q201	BR8EIX	5044
CBR-R	250		2011-	0,9	SIMR8A9	91064	-	-	-
CBR-RB-2-F/3F	250		2011-	0,9	SIMR8A9	91064	-	-	-
CB-RS ZC	250	2	1982-	0,7	D8EA	2120	Q216	DR8EIX	6681
CB-T (1/2)	250	2	1977-1978	0,7	DR8ES-L	2923	Q218	DR8EIX	6681
CB-Two Fifty (CB 250N/R/W/Y/1/2)	250		1992-2002	0,7	CR6HSA	2983	-	CR6HIX	7274
CD-U	250		1988-1992	0,7	CR6HSA	2983	-	CR6HIX	7274
CMX-C Rebel (T/V)	250		1996-1999	0,7	CR6HSA	2983	-	CR6HIX	7274
CN	250	1	1986-	0,9	DPR6EA-9	5531	-	-	-
CN-Fusion	250	1	-	0,9	DPR8EA-9	4929	Q221	DPR8EIX-9	2202
CN-Helix	250	1	1987-1999	0,9	DPR6EA-9	5531	-	-	-
CN-Spacy	250	1	-	0,9	DPR6EA-9	5531	-	-	-
CN-Spazio (J>V)	250	1	1988-1997	0,9	DPR6EA-9	5531	-	-	-
Forza	250	1	2005-2007	0,9	DPR7EA-9	5129	Q220	DPR7EIX-9	7803
Forza ABS	250	1	2008-	0,9	LMAR8A-9	4313	-	-	-
Jazz	250		2002-	0,9	DPR7EA-9	5129	Q220	DPR7EIX-9	7803
Cota 4RT (Montesa)	260		2009-	0,9	CR6EH-9	2688	-	-	-
CRF-L (D/E/F) & M (E/F)	260		2013-2015	0,9	SIMR8A9	91064	-	-	-
CRF-R (A/B/C/D/E/F/G)	260	1	2010-	0,7	R0451B-8	9356	-	-	-
CRF-R(4)	260	1	2004-	*	IMR8C-9H	3653	-	-	-
CRF-R(5/6/7/8/9)	260	1	2005-2009	0,7	R0409B-8	7791	-	-	-
CRF-X (4)	260	1	2004-	0,9	IMR8C-9H	3653	-	-	-
CR-R (K>4)	260		1989-2004	0,6	BR8EG	3130	-	-	-
CR-RK5	260	1	2005-2007	0,8	BR9EG-N-8	2689	-	-	-
FES-Foresight (W/X/Y)	260	1	1997-	0,9	DPR7EA-9	5129	Q220	DPR7EIX-9	7803
NSF-R	260	1	-	1,0	R0451C-10	92278	-	-	-
NSS-FORZA X / ABS (EX)	260		2005-2009	0,9	DPR7EA-9	5129	Q220	DPR7EIX-9	7803
NSS-FORZA X / ABS (EX)	260		2010-	0,9	LMAR8A-9	4313	-	-	-
NX-II (P>V)	260		1993-1997	0,9	CR9EH-9	7502	Q229	CR9EHIX-9	6216

* Bitte Elektrodenabstand nach Angaben des Herstellers justieren

* Please adjust the groundelectrode gap

* Veuillez vérifier L' écartement

* Por favor, ajustar distancia entre electrodos

* regolare il gap

C
Y
L

0201



Stock-No

Quick-No



Stock-No IX

HONDA

RS-R	260		2001-	0,6	R7282-105	4985	-	-	-
RTL-S	260		1985-	0,6	D6EA	7512	-	-	-
TLM-R	260		1988-	0,8	B6ES	7310	-	-	-
TLR-F	260		1982-	0,9	DPR6EA-9	5531	-	-	-
XR-L	260		1992-1995	0,7	DPR8Z	4730	-	-	-
XR-R (E>S)	260	1	1984-1995	0,7	DPR9Z	4830	-	-	-
XR-R (T>Y)	260	1	1996-	0,9	CR9EH-9	7502	Q229	CR9EHIX-9	6216
NSS	300		2011-	0,9	LMAR8A-9	4313	-	-	-
NSS-i Forza	300	1	2013-	0,9	LMAR8A-9	4313	-	-	-
SH-AB-F	300	1	2011-	0,9	LMAR8A-9	4313	-	-	-
SH-i / Sport / ABS	300	1	2007-2010	0,9	LMAR8A-9	4313	-	-	-
CB	350		1968-1973	0,8	B8ES	2411	Q201	BR8EIX	5044
XL-A	350	1	1977-1978	0,7	D8EA	2120	Q216	DR8EIX	6681
XL-R (E/F/H)	350		1985-1988	0,9	DPR8EA-9	4929	Q221	DPR8EIX-9	2202
XR-R (D/E/F/G)	350		1983-1985	0,9	DPR8EA-9	4929	Q221	DPR8EIX-9	2202
CJ-T A	360	2	1977-1977	0,7	B8ES	2411	Q201	BR8EIX	5044
CB-1	400		1989-1990	0,9	CR8EH-9	5666	Q228	CR8EHIX-9	3797
CB-A A	400	4	1978-1978	0,7	D8EA	2120	Q216	DR8EIX	6681
CB-F Four	400		1974-1977	0,7	DR8ES	5423	Q217	DR8EIX	6681
CB-F2 Four	400		1974-1977	0,7	DR8ES	5423	Q217	DR8EIX	6681
CB-N	400		1978-1985	0,7	DR8ES	5423	Q217	DR8EIX	6681
CB-N (A/B)	400		1980-1981	0,7	DR8ES	5423	Q217	DR8EIX	6681
CBR-RR (S)	400		1995-	0,9	CR8EH-9	5666	Q228	CR8EHIX-9	3797
CBR-RR Fireblade	400		1990-1999	0,9	CR8EH-9	5666	Q228	CR8EHIX-9	3797
CBR-RR Hurricane	400		1988-1989	0,9	CR8EH-9	5666	Q228	CR8EHIX-9	3797
CB-T A	400		1980-1982	0,7	DR8ES-L	2923	Q218	DR8EIX	6681
CB-T B	400		1980-1982	0,7	DR8ES-L	2923	Q218	DR8EIX	6681
CB-T C	400		1980-1982	0,7	DR8ES-L	2923	Q218	DR8EIX	6681
CB-TI A	400		1978-1979	0,7	D8EA	2120	Q216	DR8EIX	6681
CB-TII A	400		1978-1979	0,7	D8EA	2120	Q216	DR8EIX	6681
CBX-F / F2	400		1982-	0,7	DPR9Z	4830	-	-	-
CM-E (D)	400		1983-	0,7	DR8ES-L	2923	Q218	DR8EIX	6681
CM-T (A/B/C)	400	2	1980-1982	0,7	DR8ES-L	2923	Q218	DR8EIX	6681
FJS-Silverwing	400	2	2006-	0,9	CR8EH-9	5666	Q228	CR8EHIX-9	3797
SW-T	400		2009-	0,9	CR8EH-9	5666	Q228	CR8EHIX-9	3797
VFR-R (M)	400		1991-	0,7	ER9EH	5869	-	ER9EHIX	96652
XR-R (T>1)	400	1	1996-2004	0,7	DPR8Z	4730	-	-	-
XR-R Monnier	400	1	1999-	0,7	DPR8Z	4730	-	-	-
CB-S (G/J)	450		1986-1988	0,7	DR8ES-L	2923	Q218	DR8EIX	6681
CRF-4 Stroke	450	1	2005-2008	1,1	IFR9H11	6588	-	-	-
CRF-4 Stroke	450	1	2008-	0,9	SILMAR9A9S	6213	-	-	-
CRF-R (ED)	450	1	2002-2008	1,1	IFR8H11	5068	-	-	-
CRF-R 4 Stroke - sporty drive	450	1	2008-	0,9	SILMAR10A9S	7764	-	-	-
CBF-N / NA	500	2	2004-2006	0,9	CR8EH-9S	7750	-	-	-
CB-R/S	500		1994-2002	0,9	CR8EH-9	5666	Q228	CR8EHIX-9	3797
CBR-R	500	2	2013-	0,9	CPR8EA-9	2306	-	-	-
CB-X	500	2	2013-2015	0,9	CPR8EA-9	2306	-	-	-
F / F (ABS)	500		2013-2015	0,9	CPR8EA-9	2306	-	-	-
FT-A	500		1982-1985	0,7	DR8EA	7162	-	DR8EIX	6681
CB-F Hornet	600	4	2011-	0,9	CR8EH-9	5666	Q228	CR8EHIX-9	3797
CB-F Hornet, S (W/X/Y/1)	600	4	1998-	0,9	CR9EH-9	7502	Q229	CR9EHIX-9	6216
CBF-S / N	600	4	2004-2007	0,9	CR9EH-9	7502	Q229	CR9EHIX-9	6216

* Bitte Elektrodenabstand nach Angaben des Herstellers justieren

* Please adjust the groundelectrode gap

* Veuillez vérifier L' écartement

* Por favor, ajustar distancia entre electrodos

* regolare il gap

C
y
l

0201



Stock-№

Quick-№



Stock-№ IX

HONDA

CBF-S / N	600		2008-2010	0,9	CR8EH-9	5666	Q228	CR8EHIX-9	3797
CB-Hornet N	600	4	2005-	0,9	CR9EH-9	7502	Q229	CR9EHIX-9	6216
CBR- F engine No. 2242874--> &FS engine No. 2242874-->	600		2005-2007	0,9	IMR9C-9H	6777	-	-	-
CBR- F engine No.--> 2242873 & FS engine No.--> 2242873	600	4	2001-2004	0,9	IMR9A-9H	6966	-	-	-
CBR-F	600		2011-	0,9	CR9EH-9	7502	Q229	CR9EHIX-9	6216
CBR-F / F2 / F3 (M>W) / F (X/Y)	600		1991-2000	0,9	CR9EH-9	7502	Q229	CR9EHIX-9	6216
CB-RR	600	4	2009-	0,9	IMR9E-9HES	7556	-	-	-
CBR-RR	600	4	2003-2004	0,9	IMR9C-9H	6777	-	-	-
CBR-RR	600	4	2005-2006	0,9	IMR9C-9HES	5766	-	-	-
CBR-RR	600	4	2007-2010	0,9	IMR9C-9HES	5766	-	-	-
CBR-RR / ABS 600	600	4	2009-	0,9	IMR9E-9HES	7556	-	-	-
CBR-RRAB-F/2F/3F ABS	600		2011-	0,9	IMR9C-9HES	5766	-	-	-
FES-Silver Wing	600	2	2001-	0,9	CR8EH-9	5666	Q228	CR8EHIX-9	3797
FJSB-Silver Wing ABS	600	2	2003-	0,9	CR8EH-9	5666	Q228	CR8EHIX-9	3797
Silver Wing	600		2011-	0,9	IMR9C-9HES	5766	-	-	-
VT-C Shadow (J>Y)	600		1988-	0,9	DPR8EA-9	4929	Q221	DPR8EIX-9	2202
XL-V Transalp (H>X)	600		1986-2000	0,9	DPR8EA-9	4929	Q221	DPR8EIX-9	2202
XR-R (P>X)	600	1	1993-1999	0,9	DPR8EA-9	4929	Q221	DPR8EIX-9	2202
CX-Turbo	650		1983-1985	0,9	-	-	-	DPR8EIX-9	2202
FMX	650	1	2005-2007	0,9	DPR8EA-9	4929	Q221	DPR8EIX-9	2202
FX-X / Y	650		1999-2000	0,9	DPR8EA-9	4929	Q221	DPR8EIX-9	2202
NTV-Deauville (ED)	650	2	2002-2005	0,9	DPR8EA-9	4929	Q221	DPR8EIX-9	2202
NTV-Deauville (W/X/Y/1)	650	2	1998-2002	0,9	DPR8EA-9	4929	Q221	DPR8EIX-9	2202
NTV-J>V	650		1988-1998	0,9	DPR8EA-9	4929	Q221	DPR8EIX-9	2202
NX-Dominator (J>Y)	650		1988-2002	0,9	DPR8EA-9	4929	Q221	DPR8EIX-9	2202
SLR-V / W	650		1997-1998	0,9	DPR8EA-9	4929	Q221	DPR8EIX-9	2202
Transalp	650	2	2005-	0,9	DPR8EA-9	4929	Q221	DPR8EIX-9	2202
XLV-Transalp (Y/1)	650	2	2000-2007	0,9	DPR8EA-9	4929	Q221	DPR8EIX-9	2202
XR-L	650	1	1993-1996	0,9	DPR8EA-9	4929	Q221	DPR8EIX-9	2202
XR-R (Y/1)	650	1	2000-2007	1,1	BKR7E-11	1283	-	BKR7EIX-11	6988
DN-01	680	2	2009-	0,9	CPR8EA-9	2306	-	-	-
DN-01	680	2	2010-	0,9	SIMR8A9	91064	-	-	-
NT-Deauville	680	2	2006-	0,9	CPR8EA-9	2306	-	-	-
NC-D / S / SA /SD	700	2	2012-	1,1	IFR6G-11K	1314	-	-	-
NC-X / XA / XD	700	2	2011-	1,1	IFR6G-11K	1314	-	-	-
NSA-A	700	2	2008-	0,9	SIMR8A9	91064	-	-	-
NSA-DN-01	700	2	2011-	0,9	SIMR8A9	91064	-	-	-
Transalp	700	2	2008-	0,9	CPR8EA-9	2306	-	-	-
CB-F2 Seven Fifty (N>X)	750		1992-2003	0,9	DPR8EA-9	4929	Q221	DPR8EIX-9	2202
NR-N	750		1992-1993	0,7	ER9EH	5869	-	ER9EHIX	96652
RVF-R (RC45) (R>V)	750		1994-1997	0,9	-	-	-	CR9EHIX-9	6216
Shadow 750 Black Spirit	750	2	2010-	0,9	DPR8EA-9	4929	Q221	DPR8EIX-9	2202
Shadow 750 RS	750	2	2010-	0,9	DPR8EA-9	4929	Q221	DPR8EIX-9	2202
Shadow Spirit	750	2	2008-	0,9	DPR7EA-9	5129	Q220	DPR7EIX-9	7803
VF-C Magna (RC43) (P>V)	750		1993-2000	0,9	CR8EH-9	5666	Q228	CR8EHIX-9	3797
VFR-F (R>V)	750		1994-1997	0,9	CR9EH-9	7502	Q229	CR9EHIX-9	6216
VFR-R (RC 30) (J/K)	750		1988-1993	0,9	CR9EH-9	7502	Q229	CR9EHIX-9	6216
VT-C	750	2	2004-2009	0,9	DPR7EA-9	5129	Q220	DPR7EIX-9	7803
VT-C (V>Y)	750	2	1997-2000	0,9	DPR8EA-9	4929	Q221	DPR8EIX-9	2202
VT-C2 Shadow (X/Y)	750	2	1999-	0,9	DPR8EA-9	4929	Q221	DPR8EIX-9	2202
VT-C2B Black Spirit	750		2011-	0,9	DPR8EA-9	4929	Q221	DPR8EIX-9	2202
VT-C2B Shadow	750		2010-	0,9	DPR7EA-9	5129	Q220	DPR7EIX-9	7803

* Bitte Elektrodenabstand nach Angaben des Herstellers justieren

* Please adjust the groundelectrode gap

* Veuillez vérifier L' écartement

* Por favor, ajustar distancia entre electrodos

* regolare il gap

C
Y
L

Stock-No

Quick-No



Stock-No IX

HONDA

VT-DC Black Widow (I)	750	2	2000-2003	0,9	DPR8EA-9	4929	Q221	DPR8EIX-9	2202
VT-DCA, DCB Shadow Spirit	750	2	2007-	0,9	DPR8EA-9	4929	Q221	DPR8EIX-9	2202
VT-S	750	2	2010-	0,9	DPR7EA-9	5129	Q220	DPR7EIX-9	7803
VT-Shadow Spirit C2S	750	2	2010-	0,9	DPR8EA-9	4929	Q221	-	-
XLV-R F	750		1983-1985	0,9	DPR8EA-9	4929	Q221	DPR8EIX-9	2202
XRV-Africa Twin	750	2	1990-2002	0,9	DPR8EA-9	4929	Q221	DPR8EIX-9	2202
VFR	800		2002-2010	0,9	IMR9B-9H	4888	-	-	-
VFR-Fi (W/X/Y/1)	800	4	1997-2001	0,9	CR9EH-9	7502	Q229	CR9EHIX-9	6216
VFR-Fi V4 VTEC (ED)	800	4	2001-	0,9	IMR9B-9H	4888	-	-	-
VFR-VTEC	800	4	2014-	0,9	IMR9B-9H	4888	-	-	-
VFR-X	800	4	2011-	0,9	IMR9D-9H	6544	-	-	-
VFR-XAB Crossrunner	800	4	2012-	0,9	IMR9D-9H	6544	-	-	-
CBR	900		2004-	0,9	IMR9C-9HES	5766	-	-	-
CB-F Hornet (ED)	919	4	2002-2008	0,9	CR8EH-9	5666	Q228	CR8EHIX-9	3797
CBR-RR FireBlade (N>X)	919		1992-1999	0,9	CR9EH-9	7502	Q229	CR9EHIX-9	6216
CBR-RR FireBlade (1)	929	4	2001-2002	0,9	IMR9A-9H	6966	-	-	-
CBR-RR FireBlade (Y)	929	4	2000-2001	0,9	CR9EH-9	6419	-	-	-
CBR-RR FireBlade (ED)	954	4	2002-	0,9	IMR9C-9H	6777	-	-	-
CBF	1000	4	2006-2010	0,9	CR8EH-9	5666	Q228	CR8EHIX-9	3797
CB-F Big One (P>X)	1000		1993-1999	0,9	DPR9EA-9	5329	Q222	DPR9EIX-9	5545
CBF-F	1000	4	2010-	0,9	IMR8C-9HES	5990	-	-	-
CBF-FA	1000	4	2010-	0,9	IMR8C-9HES	5990	-	-	-
CB-R	1000	4	2011-	0,9	IMR9E-9HES	7556	-	-	-
CB-RA	1000	4	2009-	0,9	IMR9E-9HES	7556	-	-	-
CB-RR Fireblade	1000	4	2008-	0,9	IMR9C-9HES	5766	-	-	-
CBR-RAB-2F / RAB-3F	1000		2011-	0,9	IMR9E-9HES	7556	-	-	-
CBR-RR	1000	4	2007-	0,9	IMR9C-9H	6777	-	-	-
CBR-RR	1000	4	2009-	0,9	IMR9E-9HES	7556	-	-	-
CBR-RR / Fireblade / Repsol	1000	4	2004-2007	0,9	IMR9C-9HES	5766	-	-	-
Varadéro	1000	2	2008-	0,9	IJR8B9	4873	-	-	-
VF-F2 (F)	1000		1985-	0,9	DPR9EA-9	5329	Q222	DPR9EIX-9	5545
VTR-F Firestorm (V/W/X/Y/1)	1000		1997-2006	0,9	-	-	-	DPR9EIX-9	5545
VTR-SP-1 (Y/1)	1000	2	2000-2001	1,1	FR9BI-11	4709	-	-	-
VTR-SP-2 (ED)	1000	2	2002-2006	1,1	IFR9H11	6588	-	-	-
XLV-Varadero (3/4/5/6/7)	1000		2003-	0,9	IJR8B9	4873	-	-	-
XLV-Varadero (X/Y/1/2)	1000		1999-	0,9	-	-	-	DPR8EIX-9	2202
CB	1100		2010-	0,9	LMAR8A-9S	6817	-	-	-
CB-A	1100	4	2013-	0,9	LMAR8A-9S	6817	-	-	-
CBR-XX Fi Super Blackbird (1)	1100	4	2001-	0,9	IMR9A-9H	6966	-	-	-
CBR-XX Fi Super Blackbird (V>Y)	1100		1997-2000	0,9	-	-	-	CR9EHIX-9	6216
CB-SF X-11 (Y/1)	1100		1999-2003	0,9	-	-	-	CR8EHIX-9	3797
CB-X-Eleven	1100		1999-	0,9	-	-	-	CR8EHIX-9	3797
GL-Goldwing	1100	4	1980-1980	0,7	DR8ES-L	2923	Q218	DR8EIX	6681
GL-Goldwing	1100	4	1981-1981	0,7	DR8ES-L	2923	Q218	DR8EIX	6681
GL-Goldwing	1100	4	1982-1982	0,9	DPR8EA-9	4929	Q221	DPR8EIX-9	2202
ST-Pan-European (L>Y)	1100	4	1990-	0,9	CR8EH-9	5666	Q228	CR8EHIX-9	3797
VT-C	1100		1988-1989	0,9	DPR7EA-9	5129	Q220	DPR7EIX-9	7803
VT-C (R/S)	1100		1994-1995	0,9	DPR7EA-9	5129	Q220	DPR7EIX-9	7803
VT-C2 (S) / C2 B ACE (T>Y)	1100		1995-2000	0,9	DPR7EA-9	5129	Q220	DPR7EIX-9	7803
VT-C3, AERO (W)	1100		1998-2000	0,9	DPR7EA-9	5129	Q220	DPR7EIX-9	7803
VFR-F	1200	4	2010-	0,9	IMR9E-9HES	7556	-	-	-

* Bitte Elektrodenabstand nach Angaben des Herstellers justieren

* Please adjust the groundelectrode gap

* Veuillez vérifier l' écartement

* Por favor, ajustar distancia entre electrodos

* regolare il gap

C
Y
I

0201



Stock-№

Quick-№



Stock-№ IX

HONDA

VFR-X Crosstourer 1200	1200	4	2012-	0,9	IMR8E-9HES	95397	-	-	-
CB-ABS, S	1300	4	2005-	0,9	DPR8EA-9	4929	Q221	DPR8EIX-9	2202
CB-DCV X4	1300		1997-2003	0,9	DPR8EA-9	4929	Q221	DPR8EIX-9	2202
CB-F Super Four	1300	4	2003-	0,9	DPR8EA-9	4929	Q221	DPR8EIX-9	2202
CB-Super Touring	1300	4	2010-	0,9	DPR9EA-9	5329	Q222	DPR9EIX-9	5545
ST-Pan-European (ED)	1300	4	2002-	0,9	CR7EH-9	3486	-	-	-
VT-CX	1300	2	2010-	0,8	DCPR6E	3481	-	DCPR6EIX	8196
VT-CXA	1300	2	2009-	0,9	DCPR6E	3481	-	DCPR6EIX	8196
VTX-S	1300	2	2003-	0,9	DCPR6E	3481	-	DCPR6EIX	8196
GL-A, SE (N>Y)	1500	6	1992-2000	0,9	DPR7EA-9	5129	Q220	DPR7EIX-9	7803
GL-C F6C (V>1)	1500	6	1996-2003	0,9	DPR7EA-9	5129	Q220	DPR7EIX-9	7803
GL	1800	6	2010-	1,1	BKR6E-11	2756	-	BKR6EIX-11	3764
GL-Gold Wing	1800	6	2011-	1,1	BKR6E-11	2756	-	BKR6EIX-11	3764
GL-Gold Wing (1>7)	1800	6	2001-	1,1	BKR6E-11	2756	-	BKR6EIX-11	3764
VTX-C	1800	6	2002-2006	1,1	IFR6L11	3678	-	-	-
NHX-Lead (Fi)	108	1	2008-	0,9	CR8EH-9	5666	Q228	CR8EHIX-9	3797
NSC-Vision	108	1	2011-	0,9	CPR8EA-9	2306	-	-	-
AFS-Wave 110i	109	1	2012-	0,9	CPR6EA-9S	1582	-	-	-
CRF-F	109	1	2012-	0,9	CPR6EA-9S	1582	-	-	-
S-Wing	125		2007-	0,9	CR8EH-9	5666	Q228	CR8EHIX-9	3797
FES-Pantheon	150		2005-2011	0,9	CR8EH-9	5666	Q228	CR8EHIX-9	3797
CB-SG	350		1986-1988	0,7	DR8ES-L	2923	Q218	DR8EIX	6681
CB-G	360		-	0,7	B8ES	2411	Q201	BR8EIX	5044
CB-F A	400	4	1977-1978	0,7	D8EA	2120	Q216	DR8EIX	6681
C-E-C/E/G, C90MF-T (Step Thru)	90	1	1984-1996	0,7	CR7HS	7223	-	CR7HIX	7544
C-MT (Step Thru)	90	1	1996-2003	0,6	CR6HSA	2983	-	CR6HIX	7274

HRD

GS-Enduro	50	1	1998-1999	0,6	BR8ES	5422	Q207	BR8EIX	5044
Slide Sonic Supermotard	50	1	1998-	0,6	BR8ES	5422	Q207	BR8EIX	5044
Sonic 2 Trail & SM	50	1	1999-	0,6	BR8ES	5422	Q207	BR8EIX	5044
Cabriolet Trail & Super Motard	125	1	1999-	0,7	CR9EB	6955	-	CR9EIX	3521

HUONIAO

HN50-QT8	50		2007-	0,7	C7HSA	4629	-	CR7HIX	7544
HN125-8	125		2006-	0,7	D8EA	2120	Q216	DR8EIX	6681

HUSABERG

TE	125	1	-	0,7	-	-	-	BR7EIX	6664
FE	250	1	2013-	0,8	CR9EKB	2305	-	CR9EIX	3521
TE	250	1	2011-	0,7	BR7ES	5122	-	BR7EIX	6664
TE	300	1	2011-	0,7	BR7ES	5122	-	BR7EIX	6664
FE	350	1	1991-1999	0,7	C8E	7471	-	CR8EIX	4218
MC	350	1	-1999	0,7	C8E	7471	-	CR8EIX	4218
FE	390	1	2010-	0,9	LKAR8AI-9	6706	-	-	-
FC	400	1	1997-1999	0,7	C8E	7471	-	CR8EIX	4218
FE-E	400	1	1999-2002	0,7	DCPR8E	4339	-	DCPR8EIX	6546
FE-E, S	400	1	1997-1999	0,7	C8E	7471	-	CR8EIX	4218
FS-C / E	400	1	1999-2002	0,7	DCPR8E	4339	-	DCPR8EIX	6546
FX	400	1	1999-	0,7	DCPR8E	4339	-	DCPR8EIX	6546
FX-E	400	1	-1999	0,7	C8E	7471	-	CR8EIX	4218
SM	400	1	1999-	0,7	DCPR8E	4339	-	DCPR8EIX	6546

* Bitte Elektrodenabstand nach Angaben des Herstellers justieren

* Please adjust the groundelectrode gap

* Veuillez vérifier L' écartement

* Por favor, ajustar distancia entre electrodos

* regolare il gap

C
Y
I

0201



Stock-No

Quick-No



Stock-No IX

HUSABERG

FE	450	1	2009-	0,9	LKAR8AI-9	6706	-	-	-
FE-E	450	1	2000-2008	0,6	DCPR8E	4179	-	DCPR8EIX	6546
FX	450	1	1999-2002	0,7	DCPR8E	4339	-	DCPR8EIX	6546
FC-6	470	1	1999-2002	0,7	DCPR8E	4339	-	DCPR8EIX	6546
FC-E	470	1	2002-	0,7	DCPR8E	4339	-	DCPR8EIX	6546
FX-E	470	1	1999-2002	0,7	DCPR8E	4339	-	DCPR8EIX	6546
FC-MX	500		1995-1999	0,7	C8E	7471	-	CR8EIX	4218
FC	501	1	1995-1999	0,7	C8E	7471	-	CR8EIX	4218
FC	501	1	1999-	0,7	DCPR8E	4339	-	DCPR8EIX	6546
FE	501	1	2003-	0,7	-	-	-	DCPR8EIX	6546
FE-E	501	1	1999-	0,7	DCPR8E	4339	-	DCPR8EIX	6546
FE-E, S	501	1	1993-1999	0,7	C8E	7471	-	CR8EIX	4218
FX	501	1	1999-	0,7	DCPR8E	4339	-	DCPR8EIX	6546
FX-E	501	1	1997-1999	0,7	C8E	7471	-	CR8EIX	4218
MC	501		1999-	0,7	C8E	7471	-	CR8EIX	4218
SM	501	1	1999-	0,7	DCPR8E	4339	-	DCPR8EIX	6546
FC-4 / 6	550	1	1999-	0,7	DCPR8E	4339	-	DCPR8EIX	6546
FE-E	550		2000-	0,6	DCPR8E	4179	-	DCPR8EIX	6546
FE-E	550	1	2004-	0,7	-	-	-	DCPR8EIX	6546
FS-E	550		2000-	0,6	DCPR8E	4179	-	DCPR8EIX	6546
FE	565	1	2009-	0,9	LKAR8AI-9	6706	-	-	-
FS	565		2010-	0,9	LKAR8AI-9	6706	-	-	-
FC	600	1	1992-1999	0,7	C8E	7471	-	CR8EIX	4218
FE-E, S	600	1	1992-1999	0,7	C8E	7471	-	CR8EIX	4218
FX-E	600	1	1997-1999	0,7	C8E	7471	-	CR8EIX	4218
MC	600		-1999	0,7	C8E	7471	-	CR8EIX	4218
Elduro Rallye	650	1	1999-	0,7	DCPR8E	4339	-	DCPR8EIX	6546
FE-E	650	1	1999-	0,7	DCPR8E	4339	-	DCPR8EIX	6546
FE-E	650	1	2004-	0,7	-	-	-	DCPR8EIX	6546
FS-C / E	650	1	1999-	0,7	DCPR8E	4339	-	DCPR8EIX	6546
FX-E	650	1	1999-	0,7	DCPR8E	4339	-	DCPR8EIX	6546
SM	650	1	1999-	0,7	DCPR8E	4339	-	DCPR8EIX	6546

HUSQVARNA

CR-Minimotard	50	1	2010-	0,7	BR9ES	5722	Q208	BR9EIX	3981
Husky Boy /Racing / J / S	50	1	2001-	0,5	B6HS	4510	Q203	BR6HIX	3419
Husky Boy Junior	50	1	2001-	0,5	B6HS	4510	Q203	BR6HIX	3419
SM	50	1	2002-	0,6	BR9ES	5722	Q208	BR9EIX	3981
SM-Minimotard	50	1	2010-	0,7	BR9ES	5722	Q208	BR9EIX	3981
WRE	50	1	2002-	0,6	BR9ES	5722	Q208	BR9EIX	3981
WRS	50	1	1999-	0,5	B9ES	2611	Q202	BR9EIX	3981
WSM-Super Motard	50	1	2002-	0,7	BR9ES	5722	Q208	BR9EIX	3981
WXE-Enduro	50	1	2003-	0,7	BR9ES	5722	Q208	BR9EIX	3981
CR-Minicross	65	1	2011-	0,6	BR8ECM	3035	-	BR8ECMIX	3520
CR-Minimotard	65	1	2011-	0,6	BR8ECM	3035	-	BR8ECMIX	3520
CR	125	1	1990-1997	0,6	B10EGV	5927	-	-	-
CR	125	1	1998-2000	0,6	BR9EG	3230	-	-	-
CR	125	1	2001-2012	0,5	BR9EG	3230	-	-	-
CR	125	1	2013-	0,5	BR9EG	3230	-	-	-
CR-2 Stroke	125	1	1992-2005	0,5	BR9EG	3230	-	-	-

* Bitte Elektrodenabstand nach Angaben des Herstellers justieren

* Please adjust the groundelectrode gap

* Veuillez vérifier L' écartement

* Por favor, ajustar distancia entre electrodos

* regolare il gap

C
Y
L

0201



Stock-№

Quick-№



Stock-№ IX

HUSQVARNA

SM	125	1	1999-	0,5	BR9EG	3230	-	-	-
SMS	125	1	2000-	0,5	BR9EG	3230	-	-	-
SMS	125	1	2011-	0,6	CR8E	1275	Q226	CR8EIX	4218
TC	125	1	2014-	0,5	BR9EG	3230	-	-	-
TE-4 Stroke	125	1	2011-	0,7	CR8E	1275	Q226	CR8EIX	4218
WER	125	1	1999-	0,5	BR9EG	3230	-	-	-
WR	125	1	1993-1994	0,5	B9EGV	5827	-	-	-
WR	125	1	1995-1999	0,5	B10EGV	5927	-	-	-
WR	125	1	2000-	0,5	BR9EG	3230	-	-	-
WR-2 Stroke	125	1	2005-	0,5	BR9EG	3230	-	-	-
WR-2 Stroke	125	1	2013-	0,5	BR9EG	3230	-	-	-
WRE	125	1	1998-2001	0,6	B9EG	3530	-	-	-
WRE	125	1	2002-	0,5	BR9EG	3230	-	-	-
WRE-Tournament	125	1	1998-	0,5	R7435-10	4897	-	-	-
WSM	125	1	2004-	0,7	CR7HSA	4549	-	CR7HIX	7544
WXE	125	1	2004-	0,7	CR7HSA	4549	-	CR7HIX	7544
WR	240	1	-	0,5	B8EG	3430	-	-	-
CR	250	1	1993-1994	0,6	B10EGV	5927	-	-	-
CR	250	1	1995-2000	0,5	B9EGV	5827	-	-	-
CR	250	1	2000-	0,5	B8EG	3430	-	-	-
CR	250	1	2001-	0,5	BR8EG	3130	-	-	-
TC	250	1	2001-2008	0,6	CR8EB	7784	-	CR8EIX	4218
TC-4 Stroke	250	1	2005-	0,7	CR8EB	7784	-	CR8EIX	4218
TC-MY 2010	250	1	2009-	0,7	CR9EB	6955	-	CR9EIX	3521
TE-4 Stroke	250	1	2001-2007	0,7	CR8EB	7784	-	CR8EIX	4218
TE-i.e	250	1	2008-	0,7	CR9EB	6955	-	CR9EIX	3521
TE-Meo Replica	250	1	2011-	0,7	CR9EB	6955	-	CR9EIX	3521
TE-MY10	250	1	2009-	0,7	CR9EB	6955	-	CR9EIX	3521
TXC	250	1	2010-	0,7	CR9EB	6955	-	CR9EIX	3521
WR	250	1	1992-1995	0,5	B9EGV	5827	-	-	-
WR	250	1	1996-1997	0,6	B9EG	3530	-	-	-
WR	250	1	1998-1999	0,5	B9EGV	5827	-	-	-
WR	250	1	2000-2012	0,5	B8EG	3430	-	-	-
WR-2 Stroke	250	1	2013-	0,6	BR8EG	3130	-	-	-
WR	260	1	1990-	0,5	B9EGV	5827	-	-	-
WR	300	1	2009-	0,6	BR8EG	3130	-	-	-
TE	310	1	2009-2010	0,7	CR9EB	6955	-	CR9EIX	3521
TE	350	1	1990-	0,7	C7E	5096	-	CR7EIX	7385
CR	360	1	1991-	0,5	B8EGV	5627	-	-	-
WR	360	1	1998-	0,5	B8EG	3430	-	-	-
WR	360	1	2001-	0,5	B8EG	3430	-	-	-
WXC	360	1	1998-	0,5	B8EG	3430	-	-	-
MX	390	1	-	0,5	B9ES	2611	Q202	BR9EIX	3981
MX	400	1	-	0,5	B9ES	2611	Q202	BR9EIX	3981
SM	400		2001-2005	0,7	CR8EB	7784	-	CR8EIX	4218
TE-R-4 Stroke	400	1	2001-	0,6	C7E	5096	-	CR7EIX	7385
TE-4 Stroke	400	1	2001-	0,7	CR8EB	7784	-	CR8EIX	4218
WR	400	1	-	0,5	B8EGV	5627	-	-	-
TE	410	1	1995-2000	0,6	C7E	5096	-	CR7EIX	7385
CR	430	1	-	0,5	B9ES	2611	Q202	BR9EIX	3981
SMR	450	1	2004-	0,6	CR8EB	7784	-	CR8EIX	4218

* Bitte Elektrodenabstand nach Angaben des Herstellers justieren

* Please adjust the groundelectrode gap

* Veuillez vérifier L' écartement

* Por favor, ajustar distancia entre electrodos

* regolare il gap

C
Y
L

0201



Stock-No

Quick-No



Stock-No IX

HUSQVARNA

SMR	450	1	2004-	0,8	CR8EB	7784	-	CR8EIX	4218
SM-R	450	1	2003-	0,6	CR8EB	7784	-	CR8EIX	4218
SMR-449	450	1	2011-	0,8	CR9EKB	2305	-	CR9EIX	3521
SM-RR	450	1	2008-	0,6	CR8EB	7784	-	CR8EIX	4218
TC	450		2004-	0,7	CR8EB	7784	-	CR8EIX	4218
TC-449 4 Stroke	450	1	2011-	0,7	CR9EKB	2305	-	CR9EIX	3521
TE	450	1	2003-	0,6	CR8EB	7784	-	CR8EIX	4218
TE-4 Stroke	450	1	2005-	0,7	CR8EB	7784	-	CR8EIX	4218
TE-449 4 Stroke	450	1	2011-	0,7	CR9EKB	2305	-	CR9EIX	3521
TE-449 4 Stroke	450	1	2013-	0,7	CR9EKB	2305	-	CR9EIX	3521
SMR-511	480	1	2011-	0,8	CR9EKB	2305	-	CR9EIX	3521
TE-511	480	1	2011-	0,8	CR9EKB	2305	-	CR9EIX	3521
CR	500		-	0,5	B8EG	3430	-	-	-
WR	500		-	0,5	B8EG	3430	-	-	-
AC	510	1	-	0,9	DP8EA-9	5829	-	DPR8EIX-9	2202
SM-R	510	1	2010-	0,7	CR8EB	7784	-	CR8EIX	4218
TE	510	1	-	0,9	DP8EA-9	5829	-	DPR8EIX-9	2202
TE-4 Stroke	510	1	2005-	0,7	CR8EB	7784	-	CR8EIX	4218
SM-RR	530		2008-	0,7	CR8EB	7784	-	CR8EIX	4218
NOX-Super Motard	570	1	2001-	0,7	C7E	5096	-	CR7EIX	7385
SM	570		2001-2004	0,6	CR7EB	4663	-	CR7EIX	7385
SMR	570		2003-	0,6	CR7EB	4663	-	CR7EIX	7385
SM-R	570	1	2001-	0,7	C7E	5096	-	CR7EIX	7385
SMR-NOX	570		2002-	1,1	R0045J-10	7400	-	-	-
TC	570	1	2001-	0,7	CR7EB	4663	-	CR7EIX	7385
TE	570	1	2001-	0,7	CR7EB	4663	-	CR7EIX	7385
SMS-i.e	600		2011-	0,7	CR8EB	7784	-	CR8EIX	4218
TE-630	600	1	2010-	0,6	CR8EB	7784	-	CR8EIX	4218
TE-i.e	600		2011-	0,7	CR8EB	7784	-	CR8EIX	4218
LT	610	1	2000-	0,6	C7E	5096	-	CR7EIX	7385
SM	610	1	2006-	0,6	CPR8E	7411	-	-	-
SM-R	610	1	2000-	0,7	C7E	5096	-	CR7EIX	7385
SM-S	610	1	1998-	0,7	C7E	5096	-	CR7EIX	7385
TC	610	1	1991-2000	0,7	C7E	5096	-	CR7EIX	7385
TC	610	1	2006-	0,6	CPR8E	7411	-	-	-
TE	610	1	1991-2000	0,7	C7E	5096	-	CR7EIX	7385
TE-E	610	1	1998-2005	0,6	CR7E	4578	Q225	CR7EIX	7385
SM/R	630		2009-	0,6	CR8EB	7784	-	CR8EIX	4218
SM-R	630	1	-	1,1	R0045J-10	7400	-	-	-
TR-Strada	650	1	2012-	0,8	MAR9A-J	6869	-	-	-
TR-Terra	650	1	2012-	0,8	MAR9A-J	6869	-	-	-
Nude	900	2	2012-	0,9	LMAR8C-9	93833	-	-	-
Nude R	900	2	2012-	0,9	LMAR8C-9	93833	-	-	-

HYOSUNG

SB-G Cab	50	1	1995-	0,6	BP6HS	4511	-	BPR6HIX	4085
SB-G Gamma	50	1	1997-	0,6	BP6HS	4511	-	BPR6HIX	4085
SB-Plus & M	50	1	-	0,6	BP6HS	4511	-	BPR6HIX	4085
SD-Avanti	50	1	1999-	0,6	BP6HS	4511	-	BPR6HIX	4085

* Bitte Elektrodenabstand nach Angaben des Herstellers justieren

* Please adjust the groundelectrode gap

* Veuillez vérifier L' écartement

* Por favor, ajustar distancia entre electrodos

* regolare il gap

C
y
l

Stock-№

Quick-№



Stock-№ IX

HYOSUNG

SD-Sense	50	1	1999-2005	0,6	BP6HS	4511	-	BPR6HIX	4085
SF	50	1	1999-	0,6	BR8HSA	5539	-	BR8HIX	7001
SF-B Prima	50	1	-	0,6	BR8HSA	5539	-	BR8HIX	7001
SF-Racing	50	1	-	0,6	BR8HSA	5539	-	BR8HIX	7001
SF-Rally	50	1	2004-	0,6	BR8HSA	5539	-	BR8HIX	7001
EZ-M	100	1	-	0,6	BP7HS	5111	-	BPR7HIX	5944
EZ-Supercab	100	1	1997-	0,6	BP7HS	5111	-	BPR7HIX	5944
FX	110		-	0,7	C6HSA	3228	-	CR6HIX	7274
Midas DLX	110		1999-	0,7	C6HSA	3228	-	CR6HIX	7274
Boomer	125	1	2002-	0,6	DR8EA	7162	-	DR8EIX	6681
Comet	125	2	2001-	0,7	CR8E	1275	Q226	CR8EIX	4218
Cruise 1	125		1996-	0,7	D8EA	2120	Q216	DR8EIX	6681
Cruise 2	125		1999-	0,9	CR8EH-9	5666	Q228	CR8EHIX-9	3797
Exceed	125	1	2002-	0,7	DR8EA	7162	-	DR8EIX	6681
GA-Cruise I / FII / Classic	125	1	-	0,9	DP8EA-9	5829	-	DPR8EIX-9	2202
GA-Cruise III	125		2000-	0,9	CR8EH-9	5666	Q228	CR8EHIX-9	3797
GF-I & II	125	1	1999-	0,9	CR8EH-9	5666	Q228	CR8EHIX-9	3797
GPS-DLX Grand Prix Plus	125	1	1999-	0,6	DR8EA	7162	-	DR8EIX	6681
GPS-Grand Prix	125	1	-	0,6	DR8EA	7162	-	DR8EIX	6681
GPS-Grand Prix 2 Plus	125	1	2001-	0,6	DR8EA	7162	-	DR8EIX	6681
GS	125	1	1997-	0,6	DR8EA	7162	-	DR8EIX	6681
GT	125		2005-	0,9	CR8EH-9	5666	Q228	CR8EHIX-9	3797
GT-R	125	2	2005-	0,9	CR8EH-9	5666	Q228	CR8EHIX-9	3797
GV-Aquila (V2 Custom)	125	2	2000-	0,7	CR8E	1275	Q226	CR8EIX	4218
GV-C	125		2007-	0,8	CR8E	1275	Q226	CR8EIX	4218
HD-Hyper	125		1998-	0,8	DR8EA	7162	-	DR8EIX	6681
Karion	125	1	2002-2009	0,9	CR8EH-9	5666	Q228	CR8EHIX-9	3797
Karion	125	1	2010-	0,9	C8EH-9	7473	-	CR8EHIX-9	3797
MS3	125		2007-	0,8	CR8E	1275	Q226	CR8EIX	4218
Naked	125	1	2001-	0,6	CR8E	1275	Q226	CR8EIX	4218
RT-D Karion	125	1	2007-	0,9	CR8EH-9	5666	Q228	CR8EHIX-9	3797
RX-D, SM	125	1	2007-	0,9	CR8EH-9	5666	Q228	CR8EHIX-9	3797
XRX	125		2010-	0,7	CR8E	1275	Q226	CR8EIX	4218
XRX-Supermoto	125		2010-	0,7	CR8E	1275	Q226	CR8EIX	4218
XRX-Trail	125	1	1999-	0,9	CR8EH-9	5666	Q228	CR8EHIX-9	3797
GT	250	2	2005-	0,7	CR8E	1275	Q226	CR8EIX	4218
GV-Aquila (V2 Custom)	250	2	2000-	0,7	CR8E	1275	Q226	CR8EIX	4218
MS3	250		2007-	0,8	CR8E	1275	Q226	CR8EIX	4218
Aquila	650	2	2006-	0,7	CR8E	1275	Q226	CR8EIX	4218
Comet	650	2	2007-	0,8	CR8E	1275	Q226	CR8EIX	4218
GT-GT650 EFI, Comet	650		2008-	0,8	CR8E	1275	Q226	CR8EIX	4218
GT-GT650, Comet	650		2003-	0,8	CR8E	1275	Q226	CR8EIX	4218
GT-N	650		2012-	0,8	CR8E	1275	Q226	CR8EIX	4218
GT-R EFI	650		2008-	0,8	CR8E	1275	Q226	CR8EIX	4218
GT-R,S	650	2	2005-	0,7	CR8E	1275	Q226	CR8EIX	4218
GT-X	650		2008-	0,7	CR8E	1275	Q226	CR8EIX	4218
GV650 EFI, Aquila	650		2008-	0,8	CR8E	1275	Q226	CR8EIX	4218
GV650, Aquila	650		2006-2008	0,8	CR8E	1275	Q226	CR8EIX	4218
GV700C EFI	680		2010-	0,8	CR8E	1275	Q226	CR8EIX	4218
ST 700i	700	2	2010-	0,7	CR8E	1275	Q226	CR8EIX	4218

* Bitte Elektrodenabstand nach Angaben des Herstellers justieren

* Please adjust the groundelectrode gap

* Veuillez vérifier L' écartement

* Por favor, ajustar distancia entre electrodos

* regolare il gap

C
Y
I

Stock-No

Quick-No



Stock-No IX

INDIAN

Chief	1450	2	1999-2001	1,1	BPR5ES-11	4424	-	BPR5EIX-11	2115
Scout	1450	2	2001-	1,1	BPR5ES-11	4424	-	BPR5EIX-11	2115
Spirit	1450	2	2001-	1,1	BPR5ES-11	4424	-	BPR5EIX-11	2115
Chief	1650	2	2002-	1,1	BPR5ES-11	4424	-	BPR5EIX-11	2115

ITALJET

Ascot 50	50	1	-	0,6	BP7HS	5111	-	BPR7HIX	5944
Bazooka	50	1	-	0,6	BP7HS	5111	-	BPR7HIX	5944
Bazooka II	50	1	-	0,6	BP7HS	5111	-	BPR7HIX	5944
Cruise	50	1	1995-	0,6	BP6HS	4511	-	BPR6HIX	4085
Dragster	50	1	1996-1998	0,6	BPR8HS	3725	-	BPR8HIX	6742
Dragster	50	1	1998-	0,6	BR8HS	4322	Q212	BR8HIX	7001
Dragster Café racer	50	1	1998-	0,6	BR8HS	4322	Q212	BR8HIX	7001
Fastboy	50	1	1998-	0,6	BR7HS	4122	Q211	BR7HIX	7067
Formula 50	50	1	1995-	0,6	BPR6HS	7022	Q214	BPR6HIX	4085
Formula 50 AC	50	1	1998-1998	0,6	BR7HS	4122	Q211	BR7HIX	7067
Formula 50 AC	50	1	1999-	0,6	BR8HS	4322	Q212	BR8HIX	7001
Formula L.C.	50	1	-	0,6	BPR7HS	6422	Q215	BPR7HIX	5944
Formula, Race, Sport, Williams	50	1	1996-	0,6	BPR6HS	7022	Q214	BPR6HIX	4085
Jetset 50 2 Stroke	50		2001-2004	0,7	BR9ES	5722	Q208	BR9EIX	3981
Pack III	50	1	1991-	0,5	B6HS	4510	Q203	BR6HIX	3419
Pirana	50	1	-	0,5	B6HS	4510	Q203	BR6HIX	3419
Pista 50	50	1	1995-	0,6	BP7HS	5111	-	BPR7HIX	5944
Pista II	50	1	-	0,6	BP7HS	5111	-	BPR7HIX	5944
Pulse	50	1	-	0,5	B6HS	4510	Q203	BR6HIX	3419
Reporter	50	1	-	0,6	BP7HS	5111	-	BPR7HIX	5944
Scoop 50	50	1	1995-	0,6	BP7HS	5111	-	BPR7HIX	5944
Sunny 50	50	1	-	0,6	BP6HS	4511	-	BPR6HIX	4085
Tiffany	50	1	1995-	0,5	B6HS	4510	Q203	BR6HIX	3419
Torpedo 2 Stroke	50	1	-	0,6	B7HS	5110	Q204	BR7HIX	7067
Torpedo 25	50	1	1997-	0,6	BPR8HS	3725	-	BPR8HIX	6742
Torpedo 4 Stroke	50	1	-	0,6	CR7E	4578	Q225	CR7EIX	7385
Velocifero	50	1	1996-2000	0,7	BPR6HS	7022	Q214	BPR6HIX	4085
Velocifero "8", "10"	50	1	1998-	0,6	BR8HS	4322	Q212	BR8HIX	7001
Winner	50	1	-	0,5	B5HS	4210	-	-	-
Yankee	50	1	1995-	0,6	BP7HS	5111	-	BPR7HIX	5944
Millennium 100	100		2000-2004	0,6	BR7HS	4122	Q211	BR7HIX	7067
Jetset 125 4 Stroke	125		2001-2004	0,6	CR7E	4578	Q225	CR7EIX	7385
Jupiter	125	1	-	0,7	CR8E	1275	Q226	CR8EIX	4218
Millenium - 4 Stroke	125	1	1999-2004	0,7	CR8E	1275	Q226	CR8EIX	4218
Super Range	125	1	-	0,5	B7HS	5110	Q204	BR7HIX	7067
Torpedo - 4 Stroke	125	1	1998-	0,6	CR7E	4578	Q225	CR7EIX	7385
Union	125	1	1998-	0,5	BP7HS	5111	-	BPR7HIX	5944
Jetset 150 4 Stroke	150		2001-2004	0,6	CR7E	4578	Q225	CR7EIX	7385
Jupiter	150	1	-	0,7	CR8E	1275	Q226	CR8EIX	4218
Millenium - 4 Stroke	150	1	1999-	0,7	CR8E	1275	Q226	CR8EIX	4218
Torpedo - 4 Stroke	150	1	1999-	0,7	CR8EB	7784	-	CR8EIX	4218
Dragster	180	1	1998-	0,6	BR9ES	5722	Q208	BR9EIX	3981
Jupiter	250		2001-2004	0,7	DR8EA	7162	-	DR8EIX	6681
Millenium	250	1	1999-	0,7	DR8EA	7162	-	DR8EIX	6681

* Bitte Elektrodenabstand nach Angaben des Herstellers justieren

* Please adjust the groundelectrode gap

* Veuillez vérifier L' écartement

* Por favor, ajustar distancia entre electrodos

* regolare il gap

C
y
l

0201



Stock-№

Quick-№



Stock-№ IX

JAWA

Betcar 50	50	1	2006-	0,6	C7HSA	4629	-	CR7HIX	7544
Jawa Economy, Jive, Jazz	50	1	-	0,5	B6HS	4510	Q203	BR6HIX	3419
MJ50, Korado Basic/K'start, Lux	50	1	-	0,5	B6HS	4510	Q203	BR6HIX	3419
Betka	125	1	2006-	0,6	C7HSA	4629	-	CR7HIX	7544
Dakar	125	1	2003-	0,7	D8EA	2120	Q216	DR8EIX	6681
Dandy	125	1	1999-	0,7	D8EA	2120	Q216	DR8EIX	6681
Dandy	125	1	2000-	0,7	DR8ES	5423	Q217	DR8EIX	6681
Sport	125	1	2003-	0,7	D8EA	2120	Q216	DR8EIX	6681
Chopper	350	2	-	0,5	B8HS	5510	Q205	BR8HIX	7001
Scot Sabater	350	2	2000-	0,5	B8HS	5510	Q205	BR8HIX	7001
Style	350	2	-	0,5	B8HS	5510	Q205	BR8HIX	7001
R	500	2	-	0,5	D8EA	2120	Q216	DR8EIX	6681
Classic, Dakar, Style	650	2	2006-	0,7	DR8EA	7162	-	DR8EIX	6681

JCM

Trial	125	1	-	0,6	BP6ES	7811	-	BPR6EIX	6637
Trial	240	1	-	0,6	BP7ES	2412	Q206	BPR7EIX	4055
Trial	333	1	-	0,6	BP7ES	2412	Q206	BPR7EIX	4055

JIALING

CJ F/K	50	1	-	0,7	BPR6HS	7022	Q214	BPR6HIX	4085
JD	50	1	1997-	0,6	BPR6HSA	4632	-	BPR6HIX	4085
JH	50	1	1995-	0,7	C7HSA	4629	-	CR7HIX	7544
JL	50	1	1997-	0,6	BPR6HSA	4632	-	BPR6HIX	4085
LX	50	1	-	0,7	BPR6HSA	4632	-	BPR6HIX	4085
QM	50	1	-	0,7	BPR4HS	7823	-	-	-
TA 55	50	1	-	0,7	BPR6HSA	4632	-	BPR6HIX	4085
CJ	70	1	-	0,7	CR7HSA	4549	-	CR7HIX	7544
JD	70	1	1994-	0,7	C7HSA	4629	-	CR7HIX	7544
JH	70	1	1994-	0,7	C7HSA	4629	-	CR7HIX	7544
JH	90	1	1994-	0,7	C6HSA	3228	-	CR6HIX	7274
K	90	1	-	0,7	BP7HS	5111	-	BPR7HIX	5944
K	100	1	-	0,7	BP7HS	5111	-	BPR7HIX	5944
QM	100	1	-	0,7	BP7HS	5111	-	BPR7HIX	5944
JH	125	1	1994-	0,7	DR8ES-L	2923	Q218	DR8EIX	6681
Sanyang Duke	125	1	-	0,9	DPR7EA-9	5129	Q220	DPR7EIX-9	7803
Sanyang Wolf	125	1	-	0,7	DR8ES-L	2923	Q218	DR8EIX	6681

JIANSHE

JS125Y Tiger	125	1	2003-	0,7	DR8ES	5423	Q217	DR8EIX	6681
--------------	-----	---	-------	-----	-------	------	------	--------	------

JINCHENG

JC 50 Q	50	1	-	0,6	C7HSA	4629	-	CR7HIX	7544
JC 50 Q-7	50	1	-	0,6	C7HSA	4629	-	CR7HIX	7544
TR 36 L	50	1	-	0,6	C7HSA	4629	-	CR7HIX	7544
CJ 70 A	70	1	-	0,7	CR6HSA	2983	-	CR6HIX	7274
JC 90	90	1	-	0,7	CR6HSA	2983	-	CR6HIX	7274
JC 90-2B	90	1	-	0,7	CR6HSA	2983	-	CR6HIX	7274

* Bitte Elektrodenabstand nach Angaben des Herstellers justieren

* Please adjust the groundelectrode gap

* Veuillez vérifier L' écartement

* Por favor, ajustar distancia entre electrodos

* regolare il gap

C
Y
L

0201



Stock-No

Quick-No



Stock-No IX

JINCHENG

JC 100-7 Cruiser	100	1	-	0,6	C7HSA	4629	-	CR7HIX	7544
JC 125 7B	125	1	-	0,7	DR8EA	7162	-	DR8EIX	6681
JC 125 A	125	1	-	0,7	DR8EA	7162	-	DR8EIX	6681

JMSTAR

CJ12M	125	1	-	0,7	C7HSA	4629	-	CR7HIX	7544
-------	-----	---	---	-----	-------	------	---	--------	------

KAWASAKI

AE50 A1/A2, AR50 A1/C1-C10	50	1	1981-1997	0,7	B6ES	7310	-	-	-
KDX50-A1~3, A6F	50	1	2003-2006	0,7	BPR4HS	7823	-	-	-
KX60-B11~18	60	1	1995-2002	0,7	BR9EG	3230	-	-	-
KX60-B7~9	60	1	1991-1993	0,6	B9EG	3530	-	-	-
KX65-A1~6	65	1	2000-2005	0,7	BR10EG	3830	-	-	-
KX65-A6F~A9F, AAF~AFF	65	1	2006-2015	0,7	BR10EG	3830	-	-	-
KX65-A9FA	65	1	2009-2009	0,7	BR10EG	3830	-	-	-
KX80-R2~5	80	1	1992-1995	0,8	R6252K-105	2741	-	-	-
KX80-R6~7	80	1	1996-1997	0,8	R6252K-105	2741	-	-	-
KX80-W1~3	80	1	1998-2000	0,8	R6252K-105	2741	-	-	-
KX85-A1~5	85	1	2001-2005	0,8	R6252K-105	2741	-	-	-
KX85-A6F~A9F, AAF~ADF, CDF~CFF	85	1	2006-2015	0,8	R6252K-105	2741	-	-	-
KX85-A9FA	85	1	2009-2009	0,8	R6252K-105	2741	-	-	-
KX85	90	1	2014-	0,8	-	-	-	R6252K-105	2741
KE100-B15~20	100	1	1996-2001	0,7	BR8ES	5422	Q207	BR8EIX	5044
KE100-B6~14	100	1	1987-1995	0,7	B8ES	2411	Q201	BR8EIX	5044
KX100 D1-D5	100	1	2001-2005	0,7	R6252K-105	2741	-	-	-
KX100-B2~7	100	1	1992-1997	0,7	R6254K-105	4076	-	-	-
KX100-C1~3	100	1	1998-2000	0,7	R6252K-105	2741	-	-	-
KX100-D6F~D9F, DAF~DDF, FEF~FFF	100	1	2006-2013	0,7	R6252K-105	2741	-	-	-
KX100-D9FA	100	1	2009-2009	0,7	R6252K-105	2741	-	-	-
KX100-FEF~FFF	100	1	2014-2015	0,7	R6252K-105	2741	-	-	-
AN112 (Edge R & VR) RCF-SCF	110	1	2012-2012	0,7	C6HSA	3228	-	CR6HIX	7274
AN112-D8F~DBF	110	1	2008-2011	0,7	C6HSA	3228	-	CR6HIX	7274
AN112-SDF	110	1	2013-2013	0,7	C6HSA	3228	-	CR6HIX	7274
KLT	110	1	1986-	0,7	C6HSA	3228	-	CR6HIX	7274
KLX110 Monster Energy (KLX110-A9F)	110	1	2009-2009	0,7	CR6HSA	2983	-	CR6HIX	7274
KLX110 Monster Energy (KLX110-A9FA)	110	1	2009-2009	0,7	CR6HSA	2983	-	CR6HIX	7274
KLX110-A1~4, A6F~A9F	110	1	2002-2009	0,7	CR6HSA	2983	-	CR6HIX	7274
KLX110-CAF~CEF	110	1	2010-2014	0,7	CR6HSA	2983	-	CR6HIX	7274
KLX110L (KLX110-DAF~DEF)	110	1	2010-2014	0,7	CR6HSA	2983	-	CR6HIX	7274
KLX111 Monster Energy (KLX110-A9FA)	110	1	2009-2009	0,7	CR6HSA	2983	-	CR6HIX	7274
KLX140 Monster Energy (KLX110-A9F)	110	1	2009-2009	0,7	CR6HSA	2983	-	CR6HIX	7274
KLX140 Monster Energy (KLX110-A9FA)	110	1	2009-2009	0,7	CR6HSA	2983	-	CR6HIX	7274
KLX140L Monster Energy (KLX110-A9F)	110	1	2009-2009	0,7	CR6HSA	2983	-	CR6HIX	7274
KLX140L Monster Energy (KLX110-A9FA)	110	1	2009-2009	0,7	CR6HSA	2983	-	CR6HIX	7274
KSR	110	1	2003-	0,6	CR6HSA	2983	-	CR6HIX	7274
D-Tracker	125	1	2009-	0,8	CR7HSA	4549	-	CR7HIX	7544
Eliminator 125	125	1	1997-	0,6	CR8E	1275	Q226	CR8EIX	4218
Eliminator BN125-A4~8, A6F-A7F	125	1	2001-2007	0,8	CR7E	4578	Q225	CR7EIX	7385
KLX	125	1	2009-	0,8	CR7HSA	4549	-	CR7HIX	7544
KLX125-A1~4	125	1	2003-2006	0,6	DR8EA	7162	-	DR8EIX	6681

* Bitte Elektrodenabstand nach Angaben des Herstellers justieren

* Please adjust the groundelectrode gap

* Veuillez vérifier L' écartement

* Por favor, ajustar distancia entre electrodos

* regolare il gap

C
Y
L

0201



Stock-№

Quick-№



Stock-№ IX

KAWASAKI

KLX125L (KLX125-B1~4)	125	1	2003-2006	0,6	DR8EA	7162	-	DR8EIX	6681
KMX125-A1~A14	125	1	1986-2001	0,8	BR8ES	5422	Q207	BR8EIX	5044
KX125-K1	125	1	1994-1994	0,6	-	-	-	BR9EIX	3981
KX125-K2~3	125	1	1995-1996	0,6	-	-	-	BR9EIX	3981
KX125-K4	125	1	1997-1997	0,8	R6252K-105	2741	-	-	-
KX125-K5	125	1	1998-1998	0,6	-	-	-	BR9EIX	3981
KX125-L1	125	1	1999-1999	0,6	-	-	-	BR9EIX	3981
KX125-L2~3	125	1	2000-2001	0,6	-	-	-	BR9EIX	3981
KX125-L4	125	1	2002-2002	0,6	-	-	-	BR9EIX	3981
KX125-M1	125	1	2003-2003	0,8	-	-	-	BR9EIX	3981
KX125-M2	125	1	2004-2004	0,6	R6918B-9	2954	-	-	-
KX125-M3	125	1	2005-2005	0,6	R6918B-9	2954	-	-	-
KX-M6	125	1	2006-	0,8	-	-	-	BR9ECMIX	2707
KLX140-A8F~A9F, AAF~AFF	140	1	2008-2015	0,8	CR7HSA	4549	-	CR7HIX	7544
KLX140L (KLX140-B8F~B9F, BAF~BFF)	140	1	2008-2015	0,8	CR7HSA	4549	-	CR7HIX	7544
KLX140L (KLX140-B9FA)	140	1	2009-	0,8	CR7HSA	4549	-	CR7HIX	7544
KLT	160	1	1985-	0,7	D8EA	2120	Q216	DR8EIX	6681
KDX200-H1~11, H6F	200	1	1995-2006	0,8	BR8ES	5422	Q207	BR8EIX	5044
KDX220R-A4~12	220	1	1997-2005	0,8	BR8ES	5422	Q207	BR8EIX	5044
BJ	250	1	1993-	0,7	DR8ES	5423	Q217	DR8EIX	6681
BJ-A Estrella	250	1	1993-1996	0,7	DR8ES	5423	Q217	DR8EIX	6681
BJ-C Estrella	250	1	1997-	0,7	DR9EA	3437	Q219	DR9EIX	4772
EL-Eliminator	250	1	1996-1999	0,7	CR8HSA	2086	-	CR8HIX	7669
EX-K8F Ninja R	250	2	2008-	0,8	CR8E	1275	Q226	CR8EIX	4218
KDX250-D1~4	250	1	1991-1994	0,7	BR9ES	5722	Q208	BR9EIX	3981
KL250GAF	250	1	2010-	0,8	CR8E	1275	Q226	CR8EIX	4218
KL250 (KL250-D1~22)	250	1	1984-2005	0,9	DPR9EA-9	5329	Q222	DPR9EIX-9	5545
KLX250R (KLX250-D1~4)	250	1	1993-1996	0,8	CR8E	1275	Q226	CR8EIX	4218
KX250F (KX250-N1)	250	1	2004-2004	0,7	CR8EB	7784	-	CR8EIX	4218
KX250F (KX250-N2)	250	1	2005-2005	0,7	CR8EB	7784	-	CR8EIX	4218
KX250F (KX250-T6F~T8F, W9F)	250	1	2006-2009	0,7	CR8E	1275	Q226	CR8EIX	4218
KX250F (KX250-W9FA)	250	1	2009-	0,7	CR8E	1275	Q226	CR8EIX	4218
KX250F (KX250-XAFB)	250	1	2010-	0,7	CR8E	1275	Q226	CR8EIX	4218
KX250F (KX250-YBF~YCF)	250	1	2011-2012	0,9	CPR8EB-9	6607	-	-	-
KX250F (KX250-ZDF~ZFF)	250	1	2013-2015	0,9	CPR8EB-9	6607	-	-	-
LX 250	250	1	2009-2011	0,8	BR7ES	5122	-	BR7EIX	6664
Ninja R	250	1	2008-2010	0,7	CR8E	1275	Q226	CR8EIX	4218
Ninja R	250	1	2011-	0,7	CR8E	1275	Q226	CR8EIX	4218
KLX250S (KLX250-H6F~H7F)	251	1	2006-2007	0,8	CR8E	1275	Q226	CR8EIX	4218
KLX250S (KLX250-T9FL, TAFL~TEFL)	252	1	2009-2014	0,8	CR8E	1275	Q226	CR8EIX	4218
KR	253	1	1989-	0,8	BR10ES	4832	-	BR10EIX	6801
KX250-K2~5	265	1	1995-1998	0,8	-	-	-	BR8EIX	5044
KX250-L1~4	266	1	1999-2002	0,8	-	-	-	BR8EIX	5044
KX250-M1~2	267	1	2003-2004	0,8	-	-	-	BR8EIX	5044
KX250-R1, R6F~R7F	268	1	2005-2007	0,6	-	-	-	BR8ECMIX	3520
KX 250	269	1	2007-2007	0,8	CR8E	1275	Q226	CR8EIX	4218
KLX300R (KLX300-A1~10)	300	1	1996-2005	0,8	CR8E	1275	Q226	CR8EIX	4218
KLX300R (KLX300-A6F~A7F)	300	1	2006-2007	0,8	CR8E	1275	Q226	CR8EIX	4218
Ninja	300		2013-	0,7	CR8E	1275	Q226	CR8EIX	4218
EX305 B2-B10 (GPz305)	305		1984-1996	0,9	DPR9EA-9	5329	Q222	DPR9EIX-9	5545
GPZ	400	4	1985-	0,9	DPR9EA-9	5329	Q222	DPR9EIX-9	5545
KLX400R (KLX400-B1~2)	400	1	2003-2004	0,8	CR8E	1275	Q226	CR8EIX	4218

* Bitte Elektrodenabstand nach Angaben des Herstellers justieren

* Please adjust the groundelectrode gap

* Veuillez vérifier l' écartement

* Por favor, ajustar distancia entre electrodos

* regolare il gap

C
Y
L

Stock-No

Quick-No



Stock-No IX

KAWASAKI

KLX400SR (KLX400-A1)	400	1	2003-	0,8	CR8E	1275	Q226	CR8EIX	4218
ZL-Eliminator	400		1993-	0,7	DR8ES	5423	Q217	DR8EIX	6681
ZX	400	4	1991-1999	0,8	CR9EK	4548	Q230	CR9EIX	3521
ZXR-R	400		1988-1989	0,8	CR9EK	4548	Q230	CR9EIX	3521
KLX-/R	450		2008-	0,9	CPR8EB-9	6607	-	-	-
KLX450R (KLX450-ACF~AEF)	450	1	2012-2014	0,9	CPR8EB-9	6607	-	-	-
KX450F (KX450-D6F~D8F)	450	1	2006-2008	0,9	CPR8EB-9	6607	-	-	-
KX450F (KX450-E9F, EAF~EBF, FCF~FDF)	450	1	2009-2012	0,9	CPR8EB-9	6607	-	-	-
KX450F (KX450-E9FA)	450	1	2009-2009	0,9	CPR8EB-9	6607	-	-	-
KX450F (KX450-FDF~FFF)	450	1	2013-2015	0,9	CPR8EB-9	6607	-	-	-
EN	500		1994-1999	0,7	DR9EA	3437	Q219	DR9EIX	4772
ER500-A1~4, C1~2	500		1997-2006	0,7	DR9EA	3437	Q219	DR9EIX	4772
EX-R Ninja	500		1993-1997	0,7	DR9EA	3437	Q219	DR9EIX	4772
GPZ-R, S	500		-	0,7	DR8ES	5423	Q217	DR8EIX	6681
GPZ-S (EX500D)	500		1994-1996	0,7	DR9EA	3437	Q219	DR9EIX	4772
GPZ-S (EX500E4)	500		1997-	0,7	DR9EA	3437	Q219	DR9EIX	4772
KLE	500	2	1990-	0,7	DR9EA	3437	Q219	DR9EIX	4772
KX500-D1, E1~12	500	1	1988-2000	0,6	BR8EG	3130	-	-	-
KX500-E13~16	500	1	2001-2004	0,6	BR8EG	3130	-	-	-
ZR-B Zephyr	550		1991-	0,7	DR9EA	3437	Q219	DR9EIX	4772
Eliminator-ZL600-B1~3	600	4	1995-1997	0,7	D9EA	2420	-	DR9EIX	4772
GPZ-R	600	4	1985-1990	0,7	D9EA	2420	-	DR9EIX	4772
KLR	600	1	1985-	0,9	DPR8EA-9	4929	Q221	DPR8EIX-9	2202
ZX-6-R Ninja / RR Ninja (K1)	600	4	1995-2003	0,8	CR9E	6263	Q227	CR9EIX	3521
ZX-6R-Ninja	600	4	2008-	0,7	CR9E	6263	Q227	CR9EIX	3521
ZX-6-RR Ninja	600	4	2004-	0,8	CR9E	6263	Q227	CR9EIX	3521
ZZR	600	4	1990-2006	0,8	CR9E	6263	Q227	CR9EIX	3521
ZX-6-R Ninja / R Ninja (B1)	636	4	2002-	0,8	CR9E	6263	Q227	CR9EIX	3521
ZX-6-R, RR	636	4	2003-	0,7	CR9E	6263	Q227	CR9EIX	3521
ER650-A6S~8F	650	2	2006-2008	0,9	CR9EIA-9	6289	-	-	-
ER650-C9F, CAF~CBF, ECF~EEF	650	2	2009-2014	0,9	CR9EIA-9	6289	-	-	-
ER6-F	650	2	2012-	0,9	CR9EIA-9	6289	-	-	-
ER6-F	650	2	2005-	0,9	CR9EIA-9	6289	-	-	-
KLR650 (KL650-A1~19, A6F~A7F)	650	1	1986-2007	0,9	DPR8EA-9	4929	Q221	DPR8EIX-9	2202
KLR650 New Edition (KL650EES)	650	1	2014-	0,9	DPR8EA-9	4929	Q221	DPR8EIX-9	2202
KLX650-C1~4	650	1	1993-1996	0,9	DPR8EA-9	4929	Q221	DPR8EIX-9	2202
KLX650R (KLX650-A1~3, D1)	650	1	1993-2001	0,9	DPR8EA-9	4929	Q221	DPR8EIX-9	2202
Versys	650	2	2010-	0,9	CR9EIA-9	6289	-	-	-
Versys (KLE650A7F~9F)	650	2	2007-2009	0,9	CR9EIA-9	6289	-	-	-
Versys ABS (KLE650DEF)	650	2	2014-	0,9	CR9EIA-9	6289	-	-	-
W	650	2	1999-2006	0,8	CR8E	1275	Q226	CR8EIX	4218
Z	650	4	-	0,8	BR7ES	5122	-	BR7EIX	6664
GPX-R	750	4	1987-	0,7	DR8ES	5423	Q217	DR8EIX	6681
GPZ-R	750	4	1985-	0,7	DR8ES	5423	Q217	DR8EIX	6681
VN	750	2	-	0,9	DPR8EA-9	4929	Q221	DPR8EIX-9	2202
Z-R	750	4	2011-	0,7	CR9EK	4548	Q230	CR9EIX	3521
ZR-7	750	4	1999-	0,7	DR9EA	3437	Q219	DR9EIX	4772
ZR-7-S	750	4	2001-	0,7	DR9EA	3437	Q219	DR9EIX	4772
ZR-S	750	4	2005-	0,8	CR9EK	4548	Q230	CR9EIX	3521
ZR-Zephyr	750	4	1991-1995	0,7	DR8ES	5423	Q217	DR8EIX	6681
ZR-Zephyr	750	4	1996-1999	0,7	DR9EA	3437	Q219	DR9EIX	4772
Z-S	750	4	2004-	0,8	CR9EK	4548	Q230	CR9EIX	3521

* Bitte Elektrodenabstand nach Angaben des Herstellers justieren

* Please adjust the groundelectrode gap

* Veuillez vérifier L' écartement

* Por favor, ajustar distancia entre electrodos

* regolare il gap

C
Y
I

0201



Stock-№

Quick-№



Stock-№ IX

KAWASAKI

ZX	750	4	2004-	0,7	DR9EA	3437	Q219	DR9EIX	4772
ZX-7-R, RR Ninja	750	4	1993-	0,8	CR9E	6263	Q227	CR9EIX	3521
ZXR-R / L / M	750	4	1988-	0,8	CR9E	6263	Q227	CR9EIX	3521
VN-A	800	2	1995-1998	0,8	CR7E	4578	Q225	CR7EIX	7385
VN-B Classic, C Drifter	800	2	1996-	0,8	CR7E	4578	Q225	CR7EIX	7385
VN-Vulcan	800	2	2006-	0,9	CPR7EA-9	3901	-	CPR7EAIX-9	9198
W-SE	800	2	2011-	0,7	CR8E	1275	Q226	CR8EIX	4218
Z-E-Version	800	4	2012-	0,8	CR9EK	4548	Q230	CR9EIX	3521
VN-A6F, B7F (Classic)	900	2	2006-	0,9	CPR7EA-9	3901	-	CPR7EAIX-9	9198
VN-Custom, Classic, Light Tourer, Classic Special	900	2	-	0,9	CPR7EA-9	3901	-	CPR7EAIX-9	9198
ZX-9-R Ninja	900	4	1994-2001	0,8	CR9EK	4548	Q230	CR9EIX	3521
ZX-9-R Ninja	900	4	2002-2004	0,8	CR9EK	4548	Q230	CR9EIX	3521
GTR	1000	4	1994-2003	0,7	DR9EA	3437	Q219	DR9EIX	4772
KLX	1000	2	2004-	0,7	CR8EK	3478	-	CR8EIX	4218
Police 1000 (KZ1000-P10~19)	1000	4	1991-2000	0,8	BR8ES	5422	Q207	BR8EIX	5044
Police 1000 (KZ1000-P20~24)	1000	4	2001-2005	0,8	BR8ES	5422	Q207	BR8EIX	5044
Versys 1000 (KLZ1000ACF)	1000	4	2012-2012	0,9	CR9EIA-9	6289	-	-	-
Z-A	1000	4	2003-2006	0,8	CR9EK	4548	Q230	CR9EIX	3521
Z-C	1000	4	2007-	0,9	CR9EIA-9	6289	-	-	-
Z-H	1000	4	2010-	0,9	CR9EIA-9	6289	-	-	-
ZR	1000	4	2007-	0,9	CR9EIA-9	6289	-	-	-
Z-SX	1000	4	2010-	0,9	CR9EIA-9	6289	-	-	-
ZX 10-Tomcat	1000	4	-	0,8	CR9E	6263	Q227	CR9EIX	3521
ZX-10R-Ninja (ZX100D6F)	1000	4	2004-	0,9	CR9EIA-9	6289	-	-	-
ZZR-C	1052	4	1990-2001	0,8	CR9E	6263	Q227	CR9EIX	3521
GPZ	1100	4	1995-1999	0,8	CR9EK	4548	Q230	CR9EIX	3521
ZRX-R	1100	4	1997-2001	0,8	CR9EK	4548	Q230	CR9EIX	3521
ZR-Zephyr	1100	4	1992-1997	0,8	CR9E	6263	Q227	CR9EIX	3521
ZX-11-Ninja	1100	4	1993-	0,8	CR9E	6263	Q227	CR9EIX	3521
ZZR	1100	4	1990-2001	0,8	CR9E	6263	Q227	CR9EIX	3521
ZRX-R, S	1200	4	2001-	0,8	CR9EK	4548	Q230	CR9EIX	3521
ZX-12-R Ninja	1200	4	2000-2001	0,8	CR9EKPA	7785	-	-	-
ZX-12-R Ninja	1200	4	2002-2007	0,8	CR9EKPA	7785	-	-	-
ZZR	1200	4	2002-2004	0,8	CR9E	6263	Q227	CR9EIX	3521
GTR	1400	4	2007-	0,9	CR9EIA-9	6289	-	-	-
ZZR	1400	4	2006-	0,9	CR9EIA-9	6289	-	-	-
VN-15	1500		1988-1995	0,9	DPR7EA-9	5129	Q220	DPR7EIX-9	7803
VN-Classic D	1500	2	-1995	0,9	DPR7EA-9	5129	Q220	DPR7EIX-9	7803
VN-Classic, Classic Tourer E	1500	2	1996-	0,9	DPR7EA-9	5129	Q220	DPR7EIX-9	7803
VN-Mean Streak	1500	2	2002-	0,9	DPR6EA-9	5531	-	-	-
Vulcan Drifter VN1500-J1~2, R1~2	1500	4	1999-2002	0,9	DPR6EA-9	5531	-	-	-
VN-Classic Tourer	1600	2	2004-	0,9	DPR6EA-9	5531	-	-	-
VN-Classic, Classic Tour	1600	2	2003-	0,9	DPR6EA-9	5531	-	-	-
VN-Meanstreak	1600	2	2003-	0,9	DPR6EA-9	5531	-	-	-
VN-Tourer	1600	2	2005-	0,9	DPR6EA-9	5531	-	-	-
VN	1700	2	2010-	1,1	ILZKAR7B11	6283	-	-	-
VN-Tourer	1700	2	2014-	1,1	ILZKAR7B11	6283	-	-	-
VN-Voyager	1700	2	2010-	1,1	ILZKAR7B11	6283	-	-	-
VN-Voyager Custom	1700	2	2010-	1,1	ILZKAR7B11	6283	-	-	-
VN	2000	2	2004-	1,1	IZFR6F11	4095	-	-	-

* Bitte Elektrodenabstand nach Angaben des Herstellers justieren

* Please adjust the groundelectrode gap

* Veuillez vérifier L' écartement

* Por favor, ajustar distancia entre electrodos

* regolare il gap

C
Y
L

0201



Stock-No

Quick-No



Stock-No IX

KEEWAY

Easy 25 V2	50	1	-	0,8	BR7ES	5122	-	BR7EIX	6664
Easy 45 V2	50	1	-	0,8	BR7ES	5122	-	BR7EIX	6664
F-act	50	1	-	0,6	BR6HSA	4296	Q210	BR6HIX	3419
Flash	50	1	2006-	0,6	BR6HSA	4296	Q210	BR6HIX	3419
Flash 25V1	50	1	-	0,8	BR7ES	5122	-	BR7EIX	6664
Flash 45V1	50	1	-	0,8	BR7ES	5122	-	BR7EIX	6664
Foc. 25V2	50	1	-	0,8	BR7ES	5122	-	BR7EIX	6664
Foc. 45V1	50	1	-	0,8	BR7ES	5122	-	BR7EIX	6664
Foc. 45V2	50	1	-	0,8	BR7ES	5122	-	BR7EIX	6664
Hurricane (2-temps) Ø14mm	50	1	2008-	0,6	BPR7HS	6422	Q215	BPR7HIX	5944
Hurricane (4-temps) Ø10mm	50	1	2008-	0,7	C7HSA	4629	-	CR7HIX	7544
Hurricane 25V2	50	1	-	0,8	BR7ES	5122	-	BR7EIX	6664
Hurricane 45V1	50	1	-	0,8	BR7ES	5122	-	BR7EIX	6664
Hurricane 45V2	50	1	-	0,8	BR7ES	5122	-	BR7EIX	6664
K1	50	1	2007-	0,6	BR6HSA	4296	Q210	BR6HIX	3419
Matrix 25V2	50	1	-	0,8	BR7ES	5122	-	BR7EIX	6664
Matrix 45V1	50	1	-	0,8	BR7ES	5122	-	BR7EIX	6664
Matrix 45V2	50	1	-	0,8	BR7ES	5122	-	BR7EIX	6664
Pixel 50	50	1	2007-	0,6	BR6HSA	4296	Q210	BR6HIX	3419
RY8 25	50	1	-	0,8	BR7ES	5122	-	BR7EIX	6664
RY8 45	50	1	-	0,8	BR7ES	5122	-	BR7EIX	6664
RY8 45 SP	50	1	-	0,8	BR7ES	5122	-	BR7EIX	6664
X-Ray 50 Enduro V1/SM V1	50	1	-	0,8	BR8ES	5422	Q207	BR8EIX	5044
ARN	125	1	-	0,7	CR6HSA	2983	-	CR6HIX	7274
F-act	125	1	-	0,6	CR7HSA	4549	-	CR7HIX	7544
Foc.	125	1	-	0,7	CR6HSA	2983	-	CR6HIX	7274
Matrix V1	125	1	-	0,7	CR6HSA	2983	-	CR6HIX	7274
Matrix V2	125	1	-	0,6	CR7HSA	4549	-	CR7HIX	7544
Outlook	125	1	2006-	0,6	D7EA	7912	-	DR7EIX	5686
Silver Blade	125	1	2007-	0,6	D7EA	7912	-	DR7EIX	5686
Speed	125	1	-	0,6	DR7ES	3123	-	DR7EIX	5686
Superlight V1	125	1	-	0,6	DR7ES	3123	-	DR7EIX	5686
Superlight V2	125	1	-	0,6	DR7ES	3123	-	DR7EIX	5686
Speed	150	1	2006-	0,6	D7EA	7912	-	DR7EIX	5686
Superbike	150	1	-	0,6	D7EA	7912	-	DR7EIX	5686
Superlight	150	1	2006-	0,6	D7EA	7912	-	DR7EIX	5686

KREIDLER

Florett (RM, RMS, RMC), GS50	50	1	-	0,5	B7HS	5110	Q204	BR7HIX	7067
Florett 25	50	1	1996-	0,6	BPR7HS	6422	Q215	BPR7HIX	5944
Florett 50	50	1	1996-	0,6	BPR7HS	6422	Q215	BPR7HIX	5944
Florett RMC 25	50	1	2005-	0,6	BPR7HS	6422	Q215	BPR7HIX	5944
Florett RMC 50	50	1	2005-	0,6	BPR7HS	6422	Q215	BPR7HIX	5944
Florett XL 25	50	1	-	0,6	BPR7HS	6422	Q215	BPR7HIX	5944
Florett XL 50	50	1	-	0,6	BPR7HS	6422	Q215	BPR7HIX	5944
Flory 25	50	1	1996-	0,6	BPR7HS	6422	Q215	BPR7HIX	5944
Flory 4 temps	50	1	2005-	0,6	C7HSA	4629	-	CR7HIX	7544
Flory 50	50	1	1996-	0,6	BPR7HS	6422	Q215	BPR7HIX	5944
Flory RC 25	50	1	2005-	0,6	BPR7HS	6422	Q215	BPR7HIX	5944
Flory RC 50	50	1	2005-	0,6	BPR7HS	6422	Q215	BPR7HIX	5944
J 50 Junior	50	1	-	0,6	B6HS	4510	Q203	BR6HIX	3419
J 51 Junior	50	1	-	0,6	B6HS	4510	Q203	BR6HIX	3419

* Bitte Elektrodenabstand nach Angaben des Herstellers justieren

* Please adjust the groundelectrode gap

* Veuillez vérifier L' écartement

* Por favor, ajustar distancia entre electrodos

* regolare il gap

C
y
l

0201



Stock-Nr

Quick-Nr



Stock-Nr IX

KREIDLER

K 50	50	1	-	0,6	B7HS	5110	Q204	BR7HIX	7067
K 51	50	1	-	0,6	B7HS	5110	Q204	BR7HIX	7067
K 52 Amazone	50	1	-	0,6	B7HS	5110	Q204	BR7HIX	7067
K 52/2 Amazone	50	1	-	0,6	B7HS	5110	Q204	BR7HIX	7067
K 53 Florett Motorrad	50	1	-	0,6	B7HS	5110	Q204	BR7HIX	7067
K 53/1 Florett Mokick	50	1	-	0,6	B6HS	4510	Q203	BR6HIX	3419
K 54 Florett Motorrad	50	1	-	0,6	B7HS	5110	Q204	BR7HIX	7067
K 54/0(M) Florett Mokick	50	1	-	0,6	B6HS	4510	Q203	BR6HIX	3419
K 54/319 Florett LF	50	1	-	0,5	B6HS	4510	Q203	BR6HIX	3419
K 54/32 D-A(B) Florett LF/LH	50	1	-	0,6	B6HS	4510	Q203	BR6HIX	3419
K 54/404 Florett RMC	50	1	-	0,5	B6HS	4510	Q203	BR6HIX	3419
K 54/410 Florett RMC	50	1	-	0,6	B6HS	4510	Q203	BR6HIX	3419
K 54/42 D Florett RM	50	1	-	0,5	B6HS	4510	Q203	BR6HIX	3419
K 54/421 Florett RMC	50	1	-	0,6	B6HS	4510	Q203	BR6HIX	3419
K 54/540 Florett RMC/S	50	1	-	0,5	B6HS	4510	Q203	BR6HIX	3419
K54/2(A) Florett Super 4	50	1	-	0,6	B8HS	5510	Q205	BR8HIX	7001
K54/2(B) Florett Motorrad	50	1	-	0,6	B8HS	5510	Q205	BR8HIX	7001
K54/2(C) Florett Motorrad	50	1	-	0,6	B8HS	5510	Q205	BR8HIX	7001
K54/3 Florett Motorrad	50	1	-	0,6	B8HS	5510	Q205	BR8HIX	7001
K54/3 Florett RS	50	1	-	0,6	B8HS	5510	Q205	BR8HIX	7001
K54/4 Florett Motorrad	50	1	-	0,6	B8HS	5510	Q205	BR8HIX	7001
K54/5 Florett Super 5/TS	50	1	-	0,6	B8HS	5510	Q205	BR8HIX	7001
K54/503 Florett RS L	50	1	-	0,6	B8HS	5510	Q205	BR8HIX	7001
K54/511 Florett RS	50	1	-	0,6	B8HS	5510	Q205	BR8HIX	7001
K54/512 Mustang / Cross	50	1	-	0,6	B8HS	5510	Q205	BR8HIX	7001
K54/52 Florett GT	50	1	-	0,6	B8HS	5510	Q205	BR8HIX	7001
K54/53 (B) Florett RS	50	1	-	0,6	B8HS	5510	Q205	BR8HIX	7001
K54/54 Florett TM	50	1	-	0,6	B8HS	5510	Q205	BR8HIX	7001
LF 50	50	1	-	0,6	B6HS	4510	Q203	BR6HIX	3419
MC-5-50	50		-	0,5	B7HS	5110	Q204	BR7HIX	7067
MK	50	1	1996-	0,6	BPR7HS	6422	Q215	BPR7HIX	5944
R 50	50	1	-	0,6	B7HS	5110	Q204	BR7HIX	7067
RMC E 25	50	1	2007-	0,7	BPR7HS	6422	Q215	BPR7HIX	5944
RMC E 50	50	1	2007-	0,7	BPR7HS	6422	Q215	BPR7HIX	5944
RMC F 25	50	1	2007-	0,7	BPR7HS	6422	Q215	BPR7HIX	5944
RMC F 50	50	1	2007-	0,7	BPR7HS	6422	Q215	BPR7HIX	5944
Enduro	125	1	2000-	0,9	DP7EA-9	5629	-	DPR7EIX-9	7803
Enduro	125	1	2007-	0,7	CR8E	1275	Q226	CR8EIX	4218
Florett RMC 125	125	1	2005-	0,5	CR7HSA	4549	-	CR7HIX	7544
Flory 125 4 Stroke	125	1	-	0,5	CR7HSA	4549	-	CR7HIX	7544
Mustang	125	1	-	0,7	DR8EA	7162	-	DR8EIX	6681
RMC F	125	1	2007-	0,6	CR7HSA	4549	-	CR7HIX	7544
Supermoto	125	1	2007-2009	0,7	CR8E	1275	Q226	CR8EIX	4218
Supermoto DD	125	1	2004-2007	0,7	CR8E	1275	Q226	CR8EIX	4218
Supermoto DD	125	1	2010-	0,7	CR8E	1275	Q226	CR8EIX	4218
Flory MF12	-	1	-	0,6	B6HS	4510	Q203	BR6HIX	3419
Flory MF13	-	1	-	0,6	B6HS	4510	Q203	BR6HIX	3419
Flory MF23	-	1	-	0,6	B6HS	4510	Q203	BR6HIX	3419

KTM

Chrono 50	50	1	-	0,5	BR7HS	4122	Q211	BR7HIX	7067
Cross 50 AC (Minarelli)	50	1	-	0,6	BR8HS	4322	Q212	BR8HIX	7001

* Bitte Elektrodenabstand nach Angaben des Herstellers justieren

* Please adjust the groundelectrode gap

* Veuillez vérifier L' écartement

* Por favor, ajustar distancia entre electrodos

* regolare il gap

C
Y
L

0201



Stock-No

Quick-No



Stock-No IX

KTM

Go 50	50	1	-	0,5	BR7HS	4122	Q211	BR7HIX	7067
K 50	50	1	-	0,5	BR7HS	4122	Q211	BR7HIX	7067
K-Serie AC (Minarelli)	50	1	-	0,6	BR8HS	4322	Q212	BR8HIX	7001
K-Serie LC (Minarelli)	50	1	-	0,6	BR8HS	4322	Q212	BR8HIX	7001
LC-Junior	50	1	2001-	0,7	CR8HSA	2086	-	CR8HIX	7669
LC-Senior Adventure	50	1	2001-	0,6	BR8HS	4322	Q212	BR8HIX	7001
Mini Adventure	50	1	2002-	0,6	BR8HS	4322	Q212	BR8HIX	7001
Mini Adventure GS	50	1	2002-	0,6	BR8HS	4322	Q212	BR8HIX	7001
Mini Adventure	50	1	2001-2001	0,6	B8HS	5510	Q205	BR8HIX	7001
S5-GS Pro Junior	50	1	1999-	0,6	B8HS	5510	Q205	BR8HIX	7001
S5-GS Pro Senior	50	1	1999-	0,6	B8HS	5510	Q205	BR8HIX	7001
Senior	50	1	2001-	0,7	CR8HSA	2086	-	CR8HIX	7669
Senior	50	1	2003-	0,6	BR8ECM	3035	-	BR8ECMIX	3520
Senior Adventure	50	1	2001-	0,6	BR8HS	4322	Q212	BR8HIX	7001
SX	50	1	2008-2009	0,7	CR8HSA	2086	-	CR8HIX	7669
SX	50	1	2010-	0,7	LR8B	6208	-	-	-
SX Junior	50	1	2001-2001	0,6	B8HS	5510	Q205	BR8HIX	7001
SX Junior LC	50	1	2002-2002	0,6	BR10EG	3830	-	-	-
SX Pro Junior LC Beta Engine	50	1	2003-	0,6	BR8ECM	3035	-	BR8ECMIX	3520
SX Pro Senior LC	50	1	2003-	0,6	BR8ECM	3035	-	BR8ECMIX	3520
SX Senior	50	1	2001-2001	0,6	B8HS	5510	Q205	BR8HIX	7001
SX Senior LC	50	1	2002-2002	0,6	BR10EG	3830	-	-	-
SX-2	50	1	-	0,6	B8HS	5510	Q205	BR8HIX	7001
SX-3	50	1	-	0,6	B6HS	4510	Q203	BR6HIX	3419
SX-Mini	50	1	2010-	0,7	LR8B	6208	-	-	-
SXR Adventure	50	1	1998-2001	0,6	B8HS	5510	Q205	BR8HIX	7001
SXR-Pro-Junior	50	1	1997-	0,6	B6HS	4510	Q203	BR6HIX	3419
SXR-Pro-senior	50	1	1999-	0,6	B8HS	5510	Q205	BR8HIX	7001
SX	60	1	1999-	0,6	B105EGV	2171	-	-	-
CR-2 Stroke	65	1	2008-	0,6	BR8ECM	3035	-	BR8ECMIX	3520
SX	65	1	1998-2007	0,6	R7436-10	4900	-	-	-
SX	65	1	2001-	0,6	BR10EG	3830	-	-	-
SX	65	1	2008-	0,6	LR8B	6208	-	-	-
SX-Beta Engine	65	1	2003-2009	0,6	BR8ECM	3035	-	BR8ECMIX	3520
SX	85	1	2004-2006	0,6	-	-	-	BR10ECMIX	3006
SX	85	1	2007-	0,6	-	-	-	BR9ECMIX	2707
SX-17/14 - 19/16	85	1	2010-	0,8	-	-	-	BR9ECMIX	2707
SX	105	1	2004-	*	-	-	-	BR10ECMIX	3006
SX	105	1	2007-	*	-	-	-	BR9ECMIX	2707
Duke	125	1	1998-	0,7	BR9ES	5722	Q208	BR9EIX	3981
Duke	125	1	2011-	0,9	LKAR8A-9	4786	-	LKAR8AI-9	6706
EGS	125	1	1993-	0,6	B10EGV	5927	-	-	-
EGS	125	1	1998-2000	0,6	R6918B-8	4492	-	-	-
EXC	125	1	1993-1997	0,6	B10EGV	5927	-	-	-
EXC	125	1	1998-2000	0,6	R6918B-8	4492	-	-	-
EXC	125	1	2001-	0,6	-	-	-	BR9EIX	3981
EXC	125	1	2002-	*	-	-	-	BR9ECMIX	2707
EXC	125	1	2004-	0,6	-	-	-	BR10ECMIX	3006
EXC-Six Day	125	1	2008-	0,6	-	-	-	BR9ECMIX	2707
EXE	125	1	1999-	0,6	BR8HS	4322	Q212	BR8HIX	7001
GS-Long Base	125	1	-	0,6	B10EGV	5927	-	-	-
GS-Short Base	125	1	-	0,6	B8HS	5510	Q205	BR8HIX	7001

* Bitte Elektrodenabstand nach Angaben des Herstellers justieren

* Please adjust the groundelectrode gap

* Veuillez vérifier L' écartement

* Por favor, ajustar distancia entre electrodos

* regolare il gap

C
y
l

0201



Stock-№

Quick-№



Stock-№ IX

KTM									
LC2	125	1	1996-1999	0,7	BR9ES	5722	Q208	BR9EIX	3981
LC2	125	1	2000-	0,6	BR8HS	4322	Q212	BR8HIX	7001
RC1	125	1	2009-	0,6	-	-	-	BR9ECMIX	2707
SM	125	1	-	0,6	BR8HS	4322	Q212	BR8HIX	7001
Sting	125	1	1997-	0,7	BR9ES	5722	Q208	BR9EIX	3981
Supermoto	125	1	1999-	0,6	BR8HS	4322	Q212	BR8HIX	7001
SX	125	1	1995-1997	0,6	BR10EG	3830	-	-	-
SX	125	1	1998-2000	0,6	R6918B-8	4492	-	-	-
SX	125	1	2001-2001	0,6	-	-	-	BR9EIX	3981
SX	125	1	2008-	0,6	-	-	-	BR9ECMIX	2707
SX	144	1	2008-	0,6	-	-	-	BR9ECMIX	2707
SX	150	1	2010-	0,8	-	-	-	BR9ECMIX	2707
XC	150	1	2010-	0,6	-	-	-	BR9ECMIX	2707
Duke	200	1	2011-	0,9	LKAR8A-9	4786	-	LKAR8AI-9	6706
EGS	200	1	1998-	0,6	BR8EG	3130	-	-	-
MXC	200	1	1998-	0,6	BR8EG	3130	-	-	-
EXC	200	1	1998-	0,6	BR8EG	3130	-	-	-
EXC	200	1	1999-2001	0,6	BR9EG	3230	-	BR9EIX	3981
EXC	200	1	2002-	0,6	BR8EG	3130	-	-	-
EXC	200	1	2010-	0,6	BR8EG	3130	-	-	-
SX	200	1	2003-2006	0,6	-	-	-	BR9EIX	3981
XC-W	200	1	2010-	0,6	BR8EG	3130	-	-	-
EGS	250	1	1997-2002	0,6	BR8ECM	3035	-	BR8ECMIX	3520
EXC	250	1	1993-1995	0,6	B9EGV	5827	-	-	-
EXC	250	1	1995-1997	0,6	B8EGV	5627	-	-	-
EXC-Enduro Competition / 2 Stroke	250	1	2004-	0,6	BR7ES	5122	-	BR7EIX	6664
EXC-E-Starter	250	1	2010-	0,8	BR7ES	5122	-	BR7EIX	6664
EXC-F 4 Stroke	250	1	2007-	0,8	CR9EKB	2305	-	CR9EIX	3521
EXC-F -Six Days	250	1	2010-	0,8	CR9EKB	2305	-	CR9EIX	3521
EXC-Racing	250	1	1997-	0,6	BR8ECM	3035	-	BR8ECMIX	3520
EXC-Racing	250	1	2002-	0,6	CR8EK	3478	-	CR8EIX	4218
EXC-Racing	250	1	2003-	0,6	DCPR8E	4179	-	DCPR8EIX	6546
EXC-Racing GS / 4 Stroke	250	1	2004-	0,6	DCPR8E	4339	-	DCPR8EIX	6546
EXC-Six Days	250	1	2010-	0,8	BR7ES	5122	-	BR7EIX	6664
EXC-Sixt Days	250	1	1998-2001	0,8	BR8ECM	3035	-	BR8ECMIX	3520
EXC-Sixt Days / Racing	250	1	2002-2002	0,6	CR8EK	3478	-	CR8EIX	4218
GS-14x12,7mm	250	1	-	0,6	B9HS	5810	-	BR9HIX	5687
GS-14x19mm	250	1	-	0,6	B9EGV	5827	-	-	-
MX	250	1	-	0,6	B9EGV	5827	-	-	-
SX	250	1	1993-1995	0,6	B9EGV	5827	-	-	-
SX	250	1	1996-1997	0,6	BR8EG	3130	-	-	-
SX	250	1	1997-2004	0,6	BR8ECM	3035	-	BR8ECMIX	3520
SX	250	1	2010-	0,8	BR8ECM	3035	-	BR8ECMIX	3520
SXF	250	1	2006-2012	0,7	CR9EKB	2305	-	CR9EIX	3521
SXF	250	1	2013-	0,7	LMAR9AI-8	97225	-	-	-
SX-F 4 Stroke	250	1	2005-	0,8	CR9EKB	2305	-	CR9EIX	3521
SXF-Factory Repl.Musquin Edition	250	1	2010-2012	0,7	CR9EKB	2305	-	CR9EIX	3521
TVC	250	1	-	0,6	BR8ECM	3035	-	BR8ECMIX	3520
XC	250	1	2010-	0,8	BR7ES	5122	-	BR7EIX	6664
XCF-W-Champion's Edition	250	1	2010-	0,6	B9EGV	5827	-	-	-
XC-W	250	1	2010-	0,8	BR7ES	5122	-	BR7EIX	6664
EGS	300	1	1997-	0,6	BR8ECM	3035	-	BR8ECMIX	3520

* Bitte Elektrodenabstand nach Angaben des Herstellers justieren

* Please adjust the groundelectrode gap

* Veuillez vérifier L' écartement

* Por favor, ajustar distancia entre electrodos

* regolare il gap

C
Y
L

Stock-No

Quick-No



Stock-No IX

KTM

EXC	300	1	1996-	0,6	BR8EG	3130	-	-	-
EXC	300	1	1997-2002	0,6	BR8ECM	3035	-	BR8ECMIX	3520
EXC-EGS	300	1	1993-1995	0,6	B9EGV	5827	-	-	-
EXC-Enduro Competition	300	1	2003-	0,6	BR7ES	5122	-	BR7EIX	6664
EXC-Six Days	300	1	2010-	0,8	BR7ES	5122	-	BR7EIX	6664
EXC-Sixt Days	300	1	1999-	0,8	BR8ECM	3035	-	BR8ECMIX	3520
GS	300	1	-	0,6	B9EGV	5827	-	-	-
MXC	300		1997-2002	0,6	BR8ECM	3035	-	BR8ECMIX	3520
MXC	300		2003-	0,7	BR7ES	5122	-	BR7EIX	6664
SX	300	1	1993-1995	0,6	B9EGV	5827	-	-	-
SX	300	1	1999-	0,8	BR8ECM	3035	-	BR8ECMIX	3520
TVC	300	1	-	0,6	BR8ECM	3035	-	BR8ECMIX	3520
XC	300	1	2006-	0,8	BR7ES	5122	-	BR7EIX	6664
XC-W	300	1	2010-	0,8	BR7ES	5122	-	BR7EIX	6664
EXC	350	1	2011-	0,8	LMAR9AI-8	97225	-	-	-
EXC-F -Six Days 4 Stroke	350		2011-	0,8	LMAR9AI-8	97225	-	-	-
Freeride	350	1	2012-	1,0	LMAR9AI-10	93188	-	-	-
MX	350	1	2010-	0,8	LMAR9AI-8	97225	-	-	-
SX-F	350	1	2010-	0,8	LMAR9AI-8	97225	-	-	-
XC-F	350	1	2011-	0,8	LMAR9AI-8	97225	-	-	-
EXC	360	1	1996-	0,6	BR8EG	3130	-	-	-
EXC	360	1	1997-	0,6	BR8ECM	3035	-	BR8ECMIX	3520
SX	360	1	1996-	0,6	BR8EG	3130	-	-	-
SX	360	1	1997-	0,6	BR8ECM	3035	-	BR8ECMIX	3520
EXC-Racing	375	1	2009-	0,9	LKAR8A-9	4786	-	LKAR8AI-9	6706
EXC	380	1	1998-	0,6	BR8ECM	3035	-	BR8ECMIX	3520
SX	380	1	1998-	0,6	BR8ECM	3035	-	BR8ECMIX	3520
Duke (use cap VS05EGAK)	390	1	2013-	0,9	LKAR8A-9	4786	-	-	-
FE	390	1	2010-	0,9	LKAR8AI-9	6706	-	-	-
EXC	400	1	2002-	0,6	DCPR8E	4339	-	DCPR8EIX	6546
EXC	400	1	2010-	0,9	LKAR8AI-9	6706	-	-	-
LC4	400	1	1998-	0,7	DR8EA	7162	-	DR8EIX	6681
LC4-E	400	1	1999-	0,6	DR8EA	7162	-	DR8EIX	6681
LC4-E	400	1	2002-	0,6	DCPR8E	4179	-	DCPR8EIX	6546
LC4-E 400 Enduro	400	1	2001-	0,7	DR8EA	7162	-	DR8EIX	6681
LC4-EGS / SC / SXC	400	1	1993-1999	0,6	D8EA	2120	Q216	DR8EIX	6681
LC4-EGS-E, LES	400	1	1997-1999	0,6	DR8EA	7162	-	DR8EIX	6681
LC4-SX / EXC Racing	400	1	2000-	0,8	CR8EK	3478	-	CR8EIX	4218
SX-Racing	400	1	2002-	0,6	DCPR8E	4179	-	DCPR8EIX	6546
XC-W	400	1	2007-	0,6	DCPR8E	4339	-	DCPR8EIX	6546
XC-W	400	1	2010-	0,9	LKAR8AI-9	6706	-	-	-
EXC	450	1	2008-2009	0,9	LKAR8A-9	4786	-	-	-
EXC-R	450	1	2007-	0,9	LKAR8A-9	4786	-	LKAR8AI-9	6706
EXC-Racing, Racing GS	450	1	2002-	0,6	DCPR8E	4339	-	DCPR8EIX	6546
EXC-Six Days	450	1	2010-	0,9	LKAR8AI-9	6706	-	-	-
FE	450	1	2010-	0,9	LKAR8AI-9	6706	-	-	-
FX	450	1	2010-	0,9	LKAR8AI-9	6706	-	-	-
MXC-Dessert	450	1	2004-	0,6	DCPR8E	4339	-	DCPR8EIX	6546
SMR	450	1	2005-	0,6	DCPR8E	4339	-	DCPR8EIX	6546
SX-F	450	1	2007-	0,8	CR9EKB	2305	-	CR9EIX	3521
SX-F-Factory Repl.Nagl Edition	450	1	2010-	0,8	CR9EKB	2305	-	CR9EIX	3521

* Bitte Elektrodenabstand nach Angaben des Herstellers justieren

* Please adjust the groundelectrode gap

* Veuillez vérifier L' écartement

* Por favor, ajustar distancia entre electrodos

* regolare il gap

C
y
l

0201



Stock-№

Quick-№



Stock-№ IX

KTM									
SX-Racing	450	1	2003-	0,7	DCPR8E	4339	-	DCPR8EIX	6546
XC-W	450	1	2007-	0,6	DCPR8E	4339	-	DCPR8EIX	6546
XC-W-Six Days	450	1	2010-	0,9	LKAR8AI-9	6706	-	-	-
SX-F	505	1	2007-	0,7	CR9EKB	2305	-	CR9EIX	3521
EXC-Racing	510	1	2008-	0,9	LKAR8A-9	4786	-	-	-
EXC-Racing	520	1	1999-2002	0,8	CR8EK	3478	-	CR8EIX	4218
EXC-Racing	520	1	2002-	0,6	DCPR8E	4179	-	DCPR8EIX	6546
Six Days	520	1	1999-2002	0,7	CR8EK	3478	-	CR8EIX	4218
LC4-SX	520	1	2000-	0,8	CR8EK	3478	-	CR8EIX	4218
SX-Racing	520	1	1999-2002	0,7	CR8EK	3478	-	CR8EIX	4218
SX-Racing	520	1	2002-	0,6	DCPR8E	4179	-	DCPR8EIX	6546
EXC	525	1	2007-	0,6	DCPR8E	4339	-	DCPR8EIX	6546
EXC Racing GS	525	1	2004-2006	0,6	DCPR8E	4339	-	DCPR8EIX	6546
MXC / Desert Racing	525	1	2004-	0,6	DCPR8E	4339	-	DCPR8EIX	6546
SMR	525	1	2005-	0,6	DCPR8E	4339	-	DCPR8EIX	6546
SX-Racing	525	1	2003-	0,7	DCPR8E	4339	-	DCPR8EIX	6546
XC-W	525	1	2007-	0,6	DCPR8E	4339	-	DCPR8EIX	6546
EXC-R	530	1	2007-	0,7	LKAR8A-9	4786	-	LKAR8AI-9	6706
EXC-Six Days	530	1	2010-	0,9	LKAR8AI-9	6706	-	-	-
XC-W-Six Days	530	1	2010-	0,9	LKAR8AI-9	6706	-	-	-
LC4-SXC	540	1	1998-1999	0,6	D8EA	2120	Q216	DR8EIX	6681
SXS-Racing	540	1	2002-	0,7	CR8EK	3478	-	CR8EIX	4218
SMR	560	1	2007-	0,6	DCPR8E	4179	-	DCPR8EIX	6546
FE	570	1	2010-	0,9	LKAR8AI-9	6706	-	-	-
FS	570	1	2010-	0,9	LKAR8AI-9	6706	-	-	-
LC4-Duke	620	1	1994-	0,6	D8EA	2120	Q216	DR8EIX	6681
LC4-Duke-E	620	1	1996-1998	0,6	DR8EA	7162	-	DR8EIX	6681
LC4-EGS	620	1	1993-1997	0,6	D8EA	2120	Q216	DR8EIX	6681
LC4-EGS-E, LES	620	1	1997-1998	0,6	DR8EA	7162	-	DR8EIX	6681
LC4-EGS-E, LES	620	1	1999-	0,9	DPR8EA-9	4929	Q221	DPR8EIX-9	2202
LC4-Rallye	620	1	1997-1998	0,6	D8EA	2120	Q216	DR8EIX	6681
LC4-Rallye	620	1	1999-	0,9	DPR8EA-9	4929	Q221	DPR8EIX-9	2202
LC4-SC	620	1	1995-1998	0,6	D8EA	2120	Q216	DR8EIX	6681
LC4-Super Competition	620		2000-2002	0,9	DPR8EA-9	4929	Q221	DPR8EIX-9	2202
LC4-Supercomp / Supermoto	620	1	1999-	0,9	DPR8EA-9	4929	Q221	DPR8EIX-9	2202
LC4-Supercopetition Supermoto	620		2002-	0,6	DCPR8E	4179	-	DCPR8EIX	6546
LC4-SX	620	1	1995-1998	0,6	D8EA	2120	Q216	DR8EIX	6681
SC-Enduro, Super Moto	625	1	2000-	0,9	DPR8EA-9	4929	Q221	DPR8EIX-9	2202
SMC	625	1	2005-	0,6	DCPR8E	4339	-	DCPR8EIX	6546
LC4-Adventure R	640	1	1999-	0,6	D8EA	2120	Q216	DR8EIX	6681
LC4-Adventure R	640	1	2000-	0,9	DPR8EA-9	4929	Q221	DPR8EIX-9	2202
LC4-Duke	640	1	2005-	0,6	DCPR8E	4339	-	DCPR8EIX	6546
LC4-Duke II	640	1	1999-	0,6	DR8EA	7162	-	DR8EIX	6681
LC4-Duke II	640	1	2000-	0,9	DPR8EA-9	4929	Q221	DPR8EIX-9	2202
LC4-E / E Supermoto	640	1	1999-	0,6	D8EA	2120	Q216	DR8EIX	6681
LC4-E / E Supermoto	640	1	2000-	0,9	DPR8EA-9	4929	Q221	DPR8EIX-9	2202
LC4-Rallye	640	1	1998-	0,6	D8EA	2120	Q216	DR8EIX	6681
LC4-SM	640	1	2005-	0,6	DCPR8E	4339	-	DCPR8EIX	6546
690 LC4 Supermoto / Prestige	654	1	2007-	0,9	LKAR8AI-9	6706	-	-	-
LC4-Rally Replica	660	1	2008-	0,9	LKAR8A-9	4786	-	-	-
LC4-Rallye	660	1	1999-	0,7	DR9EA	3437	Q219	DR9EIX	4772
SMC	660	1	2003-	0,7	DCPR8E	4339	-	DCPR8EIX	6546

* Bitte Elektrodenabstand nach Angaben des Herstellers justieren

* Please adjust the groundelectrode gap

* Veuillez vérifier L' écartement

* Por favor, ajustar distancia entre electrodos

* regolare il gap



C
Y
L



Stock-No

Quick-No



Stock-No IX

KTM

SMC	660	1	2007-	0,9	LKAR8AI-9	6706	-	-	-
Super Moto Factory Replica	660	1	2002-	0,6	DR9EA	3437	Q219	DR9EIX	4772
Duke	690	1	2010-	0,9	LKAR8AI-9	6706	-	-	-
Duke (Twin Spark)	690	1	2011-	0,9; 0,9	LKAR8BI9; LMAR7A-9	1553; 4908	-	-	-
Duke R	690	1	2010-	0,9	LKAR8AI-9	6706	-	-	-
Duke R (Twin Spark)	690	1	2012-	0,9	LKAR8BI9; LMAR7A-9	1553; 4908	-	-	-
Enduro	690	1	2010-	0,9	LKAR8AI-9	6706	-	-	-
Enduro R	690	1	2008-	0,9	LKAR8AI-9	6706	-	-	-
SM	690	1	-	0,9	LKAR8AI-9	6706	-	-	-
SMC	690	1	2010-	0,9	LKAR8AI-9	6706	-	-	-
LC4-Duke III	700	1	2008-2009	0,9	LKAR8A-9	4786	-	-	-
EXC	780	1	2007-2011	0,9	LKAR8A-9	4786	-	LKAR8AI-9	6706
Adventure	950	2	2003-	0,7	CR8EK	3478	-	CR8EIX	4218
Adventure S	950	2	2003-	0,7	CR8EK	3478	-	CR8EIX	4218
Enduro	950	2	2006-	0,7	CR8EK	3478	-	CR8EIX	4218
LC8	950	2	2007-	0,8	KR8DI	4742	-	-	-
LC8 Rally	950	2	2004-2007	0,7	CR8EK	3478	-	CR8EIX	4218
Super Enduro R	950	2	-	0,7	CR8EK	3478	-	CR8EIX	4218
Superduke	950	2	2005-	0,6	DCPR8E	4339	-	DCPR8EIX	6546
Supermoto	950	2	2005-2006	0,7	CR8EK	3478	-	CR8EIX	4218
Supermoto R	950	2	2007-	0,7	CR8EK	3478	-	CR8EIX	4218
Adventure / ABS, R	990	2	2010-	0,9	LKAR8BI9	1553	-	-	-
Duke	990		2004-2009	0,6	DCPR8E	4179	-	DCPR8EIX	6546
LC8-Super Duke R	990	2	2010-	0,9	LKAR8AI-9	6706	-	-	-
Super Duke	990	2	2005-	0,7	CR8EK	3478	-	CR8EIX	4218
Super Duke	990	2	2007-	0,8	KR8DI	4742	-	-	-
Super Duke R	990	2	2008-2012	0,6	LKAR8AI-9	6706	-	DCPR8EIX	6546
Super Duke R	990	2	2007-	0,8	KR8DI	4742	-	-	-
Supermoto R / T silver / orange	990	2	2009-	0,8	KR8DI	4742	-	-	-
SM-R	999	2	2009-	0,8	KR8DI	4742	-	-	-
SM-Supermoto R	999	2	2009-	0,8	KR8DI	4742	-	-	-
Adventure / S	1000	2	2006-2009	0,6	DCPR8E	4179	-	DCPR8EIX	6546
Duke	1000	2	2004-2009	0,6	DCPR8E	4179	-	DCPR8EIX	6546
LC8	1000	2	2008-	0,9	LKAR8BI9	1553	-	-	-
LC8-Adventure	1000	2	2006-2008	0,9	DCPR8E	4339	-	DCPR8EIX	6546
SM R	1000	2	2009-2009	0,8	KR8DI	4742	-	-	-
SM T	1000	2	2009-2009	0,8	KR8DI	4742	-	-	-
Super Duke	1000	2	2005-2006	0,6	DCPR8E	4179	-	DCPR8EIX	6546
Super Duke	1000	2	2007-	0,8	KR8DI	4742	-	-	-
RC8-1190	1150	2	2008-	0,9	LKAR9BI9	6205	-	-	-
RC8-4 Temps	1150	2	2010-	0,9	LKAR9BI9	6205	-	-	-
RC8-1190 R Akrapovic Ed. Twinspark	1190	2	2010-	0,9; 0,9	LKAR9BI9; LMAR7A-9	6205; 4908	-	-	-
RC8-1190 R Red Bull Twinspark	1190	2	2010-	0,9; 0,9	LKAR9BI9; LMAR7A-9	6205; 4908	-	-	-
RC8-1190 Twinspark	1190	2	2010-	0,9; 0,9	LKAR9BI9; LMAR7A-9	6205; 4908	-	-	-
RC8R-R Twinspark	1200	2	2011-	0,9	LKAR9BI9	6205	-	-	-

* Bitte Elektrodenabstand nach Angaben des Herstellers justieren

* Please adjust the groundelectrode gap

* Veuillez vérifier L' écartement

* Por favor, ajustar distancia entre electrodos

* regolare il gap

C
y
l

0201



Stock-№

Quick-№



Stock-№ IX

KUANG YANG

GS7E - Movie, KA 50G	50	1	-	0,6	BP6HSA	1046	-	BPR6HIX	4085
KA 50	50	1	-	0,6	BP6HSA	1046	-	BPR6HIX	4085
KA 50G	50	1	-	0,6	BP6HSA	1046	-	BPR6HIX	4085

KYMCO

Agility 50 4 Stroke	50	1	2005-	0,6	CR7HSA	4549	-	CR7HIX	7544
Agility 50 MMC 4 Stroke	50	1	2005-	0,6	CR7HSA	4549	-	CR7HIX	7544
Agility Basic 50	50	1	-	0,6	CR7HSA	4549	-	CR7HIX	7544
Agility City 50	50	1	-	0,6	CR7HSA	4549	-	CR7HIX	7544
Agility One 50	50	1	-	0,6	CR7HSA	4549	-	CR7HIX	7544
Agility R10	50	1	-	0,7	CR7HSA	4549	-	CR7HIX	7544
Agility R12	50	1	-	0,7	CR7HSA	4549	-	CR7HIX	7544
Agility R16	50	1	-	0,7	CR7HSA	4549	-	CR7HIX	7544
Agility RS	50	1	-	0,7	CR7HSA	4549	-	CR7HIX	7544
Bet&Win 50LC	50	1	-	0,7	BR8HSA	5539	-	BR8HIX	7001
Calypso 50	50	1	1997-	0,6	BR8HS	4322	Q212	BR8HIX	7001
Cobra-Cross / Racer / Exclusive	50	1	1997-	0,6	BR8HSA	5539	-	BR8HIX	7001
CSX	50	1	-	0,6	BR8HSA	5539	-	BR8HIX	7001
Curio	50	1	1996-	0,7	BR8HSA	5539	-	BR8HIX	7001
CX	50	1	-	0,6	BR8HSA	5539	-	BR8HIX	7001
CX-Super	50	1	-	0,6	BR8HSA	5539	-	BR8HIX	7001
Dink 2 Stroke	50	1	1999-2006	0,7	BR8HSA	5539	-	BR8HIX	7001
Dink 4 Stroke	50	1	2006-	0,7	CR7HSA	4549	-	CR7HIX	7544
Dink 50 LC	50	1	-	0,7	BR8HSA	5539	-	BR8HIX	7001
DJ	50	1	-	0,7	BR8HSA	5539	-	BR8HIX	7001
Filly	50		1998-	0,7	CR7HSA	4549	-	CR7HIX	7544
Filly-LX	50	1	-	0,7	CR7HSA	4549	-	CR7HIX	7544
Grand Dink 2 Stroke	50	1	2005-	0,6	BR8HSA	5539	-	BR8HIX	7001
Grand Dink 50s	50	1	-	0,6	BR8HSA	5539	-	BR8HIX	7001
Heroism	50	1	1996-	0,7	BR8HSA	5539	-	BR8HIX	7001
K12-SC10AE	50	1	1996-	0,7	BR8HSA	5539	-	BR8HIX	7001
KB	50	1	-	0,6	BR8HSA	5539	-	BR8HIX	7001
Like 2 Stroke	50		2009-	0,7	BR8HSA	5539	-	BR8HIX	7001
Like 4 Stroke	50		2009-	0,5	CR7HSA	4549	-	CR7HIX	7544
Nexxon 50	50	1	-	0,6	CR7HSA	4549	-	CR7HIX	7544
People / S2 Stroke	50	1	1999-	0,7	BR8HSA	5539	-	BR8HIX	7001
People S 50 4 Stroke	50	1	2006-	0,6	CR7HSA	4549	-	CR7HIX	7544
RS-Renovo 2 Stroke	50		-	0,7	BR8HSA	5539	-	BR8HIX	7001
Sento	50	1	2009-	0,5	CR7HSA	4549	-	CR7HIX	7544
Sniper 50	50	1	1993-	0,6	BR8HSA	5539	-	BR8HIX	7001
Snuper 50 DD	50	1	-	0,6	BR8HSA	5539	-	BR8HIX	7001
Spacer	50	1	1998-	0,7	BR6HSA	4296	Q210	BR6HIX	3419
Spacer 50	50	1	1999-	0,6	BR8HSA	5539	-	BR8HIX	7001
Super 8 2 Stroke	50	1	2009-	0,7	BR8HSA	5539	-	BR8HIX	7001
Super 8 4 Stroke	50	1	2008-	0,5	CR7HSA	4549	-	CR7HIX	7544
Super 9 AC	50		2001-	0,6	BR8HSA	5539	-	BR8HIX	7001
Super 9 AC 50 Sports	50	1	2001-	0,6	BR8HSA	5539	-	BR8HIX	7001
Super 9 LC	50	1	2000-	0,7	BR8HSA	5539	-	BR8HIX	7001
Tomos Classic / Quadro / Flexer	50	1	2001-	0,6	B6HS	4510	Q203	BR6HIX	3419
Top Boy 50	50	1	2001-	0,6	BR8HSA	5539	-	BR8HIX	7001
Vitality 2 Stroke	50	1	2005-	0,6	BR8HSA	5539	-	BR8HIX	7001

* Bitte Elektrodenabstand nach Angaben des Herstellers justieren

* Please adjust the groundelectrode gap

* Veuillez vérifier L' écartement

* Por favor, ajustar distancia entre electrodos

* regolare il gap

C
Y
I

0201



Stock-No

Quick-No



Stock-No IX

KYMCO

Validity 4 Stroke	50	1	2005-	0,5	CR7HSA	4549	-	CR7HIX	7544
Validity 50 Cross	50	1	-	0,6	BR8HSA	5539	-	BR8HIX	7001
Validity 50 Sports	50	1	-	0,6	BR8HSA	5539	-	BR8HIX	7001
Yager 50 2 Stroke	50	1	2001-	0,6	BR8HSA	5539	-	BR8HIX	7001
Yager GT 50	50	1	-	0,6	CR7HSA	4549	-	CR7HIX	7544
Yup	50	1	2000-	0,7	BR8HSA	5539	-	BR8HIX	7001
ZX-Fever 10 inch	50	1	-	0,7	BR8HSA	5539	-	BR8HIX	7001
ZX-Fever 12 inch	50	1	1996-	0,7	BR8HSA	5539	-	BR8HIX	7001
ZX-Scout	50	1	1996-	0,7	BR8HSA	5539	-	BR8HIX	7001
Cobra Racer	100	1	1998-	0,7	BR6HSA	4296	Q210	BR6HIX	3419
Agility	125	1	2005-	0,7	CR7HSA	4549	-	CR7HIX	7544
Agility R16	125	1	2005-	0,7	CR7HSA	4549	-	CR7HIX	7544
Agility RS	125	1	2005-	0,7	CR7HSA	4549	-	CR7HIX	7544
Calypso 125	125	1	1997-	0,6	C7HSA	4629	-	CR7HIX	7544
CK	125	1	2005-	0,7	DR8EA	7162	-	DR8EIX	6681
Cruiser	125	1	-	0,7	CR8E	1275	Q226	CR8EIX	4218
Dink 4 Stroke / DD	125	1	1999-	0,9	DPR7EA-9	5129	Q220	DPR7EIX-9	7803
Downtown i	125	1	2009-	0,8	CR7E	4578	Q225	CR7EIX	7385
Ego	125	1	2000-	0,9	DPR7EA-9	5129	Q220	DPR7EIX-9	7803
Grand Dink	125	1	2001-	0,9	DPR7EA-9	5129	Q220	DPR7EIX-9	7803
Grand Dink	125	1	2012-	0,9	DPR6EA-9	5531	-	-	-
Heroism	125	1	-	0,7	CR7HSA	4549	-	CR7HIX	7544
Hipster	125	1	2000-	0,7	DR8EA	7162	-	DR8EIX	6681
Hipster (4V)	125	1	-	0,7	CR8E	1275	Q226	CR8EIX	4218
K-Pipe	125	1	2012-	0,6	CR7HSA	4549	-	CR7HIX	7544
K-XCT	125	1	2013-	0,7	CR7E	4578	Q225	CR7EIX	7385
Like	125	1	2009-	0,7	CR7HSA	4549	-	CR7HIX	7544
Like LX E3	125	1	2012-	0,6	CR7HSA	4549	-	CR7HIX	7544
Météorit	125	1	-	0,7	DR8EA	7162	-	DR8EIX	6681
Movie 125 4 Stroke	125	1	-	0,6	C7HSA	4629	-	CR7HIX	7544
Movie XL	125	1	2002-	0,7	CR7HSA	4549	-	CR7HIX	7544
People	125	1	1999-2004	0,7	DR8EA	7162	-	DR8EIX	6681
People	125	1	2005-	0,7	CR7HSA	4549	-	CR7HIX	7544
People 125 E3 / S 125 DD	125	1	2008-	0,7	CR7HSA	4549	-	CR7HIX	7544
People GTi	125	1	2010-	0,7	CR7HSA	4549	-	CR7HIX	7544
People S	125	1	2005-	0,7	CR7HSA	4549	-	CR7HIX	7544
Pulsar	125	1	2001-	0,7	DR8EA	7162	-	DR8EIX	6681
Quannon	125	1	2007-	0,7	CR8E	1275	Q226	CR8EIX	4218
Quannon Naked	125	1	2010-	0,7	CR8E	1275	Q226	CR8EIX	4218
Sector	125	1	1998-	0,7	DR8EA	7162	-	DR8EIX	6681
Spacer	125	1	1997-	0,9	DPR7EA-9	5129	Q220	DPR7EIX-9	7803
Stryker II	125	1	2002-	0,7	DR8EA	7162	-	DR8EIX	6681
Stryker-On / Off Road	125	1	1999-	0,7	DR8EA	7162	-	DR8EIX	6681
Super 8	125	1	2007-2010	0,7	CR7HSA	4549	-	CR7HIX	7544
Vivio	125	1	1999-	0,7	CR7HSA	4549	-	CR7HIX	7544
Yager 125 4 Stroke	125	1	2001-	0,9	DPR7EA-9	5129	Q220	DPR7EIX-9	7803
Yager GT 125	125	1	2008-	0,9	DPR7EA-9	5129	Q220	DPR7EIX-9	7803
Zing	125	1	1997-	0,7	DR8EA	7162	-	DR8EIX	6681
Zing II	125	1	2008-	0,7	DR8EA	7162	-	DR8EIX	6681
Agility R16	150	1	2008-	0,7	CR7HSA	4549	-	CR7HIX	7544
Heroism	150	1	1996-	0,7	CR7HSA	4549	-	CR7HIX	7544

* Bitte Elektrodenabstand nach Angaben des Herstellers justieren

* Please adjust the groundelectrode gap

* Veuillez vérifier L' écartement

* Por favor, ajustar distancia entre electrodos

* regolare il gap

C
y
l

0201



Stock-№

Quick-№



Stock-№ IX

KYMCO

People	150	1	1999-	0,9	DPR7EA-9	5129	Q220	DPR7EIX-9	7803
Agility R16	200	1	2010-	0,7	CR7HSA	4549	-	CR7HIX	7544
Dink DD	200	1	2008-	0,9	DPR6EA-9	5531	-	-	-
Downtown i	200	1	2010-	0,7	CR7E	4578	Q225	CR7EIX	7385
Like i	200	1	2009-	0,7	CR7HSA	4549	-	CR7HIX	7544
People GT 200i	200	1	2010-	0,7	CR7E	4578	Q225	CR7EIX	7385
People S 200i	200	1	2007-	0,6	CR7HSA	4549	-	CR7HIX	7544
People S 200i / S 200 DD	200	1	2008-	0,7	CR7HSA	4549	-	CR7HIX	7544
People S 250i	200	1	2007-	0,9	DPR6EA-9	5531	-	-	-
Dink 4 Stroke	250	1	1999-	0,9	DPR7EA-9	5129	Q220	DPR7EIX-9	7803
Ego	250	2	2000-	0,9	DPR7EA-9	5129	Q220	DPR7EIX-9	7803
Grand Dink	250	1	2001-	0,9	DPR7EA-9	5129	Q220	DPR7EIX-9	7803
People	250	2	2003-	0,9	DPR7EA-9	5129	Q220	DPR7EIX-9	7803
People S 300i	250	1	2007-	0,9	DPR6EA-9	5531	-	-	-
Venox 4 Stroke	250	2	2002-	0,9	DPR7EA-9	5129	Q220	DPR7EIX-9	7803
Xciting	250	2	2005-	0,9	DPR7EA-9	5129	Q220	DPR7EIX-9	7803
Downtown i	300		2009-	0,8	CR7E	4578	Q225	CR7EIX	7385
Grand-Dink i	300		2012-	0,9	DPR6EA-9	5531	-	-	-
People GT i	300	1	2010-	0,8	CR7E	4578	Q225	CR7EIX	7385
People S	300		2008-	0,9	DPR6EA-9	5531	-	-	-
Xciting i R	300		2009-	0,9	DPR6EA-9	5531	-	-	-
Xciting R	300	1	-	0,9	CPR6EA-9	6899	-	-	-
Xciting i	400	1	2009-	0,7	CR7E	4578	Q225	CR7EIX	7385
Xciting	500	1	2005-	0,8	CR8E	1275	Q226	CR8EIX	4218
Xciting i	500	1	2007-	0,7	CR7E	4578	Q225	CR7EIX	7385

K-ZWO

Cat 50	50	1	1997-	0,6	BR7HS	4122	Q211	BR7HIX	7067
K-Zwo Royal 125	125	1	1996-	0,6	C7HSA	4629	-	CR7HIX	7544
Royal 125	125	1	1996-	0,6	C7HSA	4629	-	CR7HIX	7544

LAMBRETTA

3V/4V/5V-77	50	1	-	0,5	B6HS	4510	Q203	BR6HIX	3419
Puma Cross,Trial	50	1	-	0,5	B6HS	4510	Q203	BR6HIX	3419
125,Lince,Linea,SX	125	1	-	0,5	B7ES	1111	-	BR7EIX	6664
LI 125, SL125, SI 125	125		-	0,5	B7ES	1111	-	BR7EIX	6664
GP	150	1	-	0,5	B7ES	1111	-	BR7EIX	6664
Special 150	150	1	-	0,5	B7ES	1111	-	BR7EIX	6664
200,Jet,Lince,Mensa-Expres	200	1	-	0,5	B7ES	1111	-	BR7EIX	6664
GP	200	1	-	0,5	B7ES	1111	-	BR7EIX	6664
Pony,SX	200	1	-	0,5	B7ES	1111	-	BR7EIX	6664

LAVERDA

650, GT, GTL, American Eagle	650		1994-1998	0,7	B9ES	2611	Q202	BR9EIX	3981
Ghost, Ghost Strike, Formula	650	2	1996-	0,6	DCPR8E	4339	-	DCPR8EIX	6546
Sport	650		1995-	0,6	DCPR8E	4339	-	DCPR8EIX	6546
750, GT, GTL, American Eagle	750		-	0,7	B8ES	2411	Q201	BR8EIX	5044
Black Strike	750		2000-	0,6	DCPR8E	4339	-	DCPR8EIX	6546
Diamant	750		1997-	0,6	DCPR8E	4339	-	DCPR8EIX	6546

* Bitte Elektrodenabstand nach Angaben des Herstellers justieren

* Please adjust the groundelectrode gap

* Veuillez vérifier L' écartement

* Por favor, ajustar distancia entre electrodos

* regolare il gap

C
Y
L

0201



Stock-No

Quick-No



Stock-No IX

LAVERDA

Formula	750		1997-	0,6	DCPR8E	4339	-	DCPR8EIX	6546
Ghost, Strike, Sport	750		1998-	0,6	DCPR8E	4339	-	DCPR8EIX	6546
S	750		1997-	0,6	DCPR8E	4339	-	DCPR8EIX	6546
SS	750		2000-	0,6	DCPR8E	4339	-	DCPR8EIX	6546

LEXMOTO

Flash ZN50QT-15A	50		2012-	0,7	C7HSA	4629	-	CR7HIX	7544
Tommy II ZN50QT-E	50		2012-	0,7	C7HSA	4629	-	CR7HIX	7544
Tommy ZN50QT-A	50		2012-	0,7	C7HSA	4629	-	CR7HIX	7544
Tornado SB50QT-16(B08)	50		2012-	0,7	C7HSA	4629	-	CR7HIX	7544
LSM	51		2012-	0,6	BR8ES	5422	Q207	BR8EIX	5044
Arizona ZS125-30	125		2013-	0,7	D8EA	2120	Q216	DR8EIX	6681
Arrow HT125-4F	125		2013-	0,7	D8EA	2120	Q216	DR8EIX	6681
Firenze ZN125T-F	125		2012-	0,7	C7HSA	4629	-	CR7HIX	7544
Gladiator SB125T-23B	125		2012-	0,7	C7HSA	4629	-	CR7HIX	7544
Ranger ZS125-50	125		2013-	0,7	D8EA	2120	Q216	DR8EIX	6681
Street DFE125-8A	125		2013-	0,7	CR7E	4578	Q225	CR7EIX	7385
Tommy ZN125T-E	125		2012-	0,7	C7HSA	4629	-	CR7HIX	7544
Tornado SB125T-21(B08)	125		2013-	0,7	C7HSA	4629	-	CR7HIX	7544
Vixen HT125-8	125		2013-	0,7	D8EA	2120	Q216	DR8EIX	6681
XTR KS125-23	125		2013-	0,7	D8EA	2120	Q216	DR8EIX	6681
XTR S KS125-24	125		-	0,7	D8EA	2120	Q216	DR8EIX	6681
Zoom II SB125T-21(B10)	125		2013-	0,7	C7HSA	4629	-	CR7HIX	7544
Valencia	126		2012-	0,7	C7HSA	4629	-	CR7HIX	7544

LIFAN

LF125-J	125	1	2013-	0,6	D8EA	2120	Q216	DR8EIX	6681
---------	-----	---	-------	-----	------	------	------	--------	------

LINGBEN

Manhattan	125	1	2006-	0,7	CR7HSA	4549	-	CR7HIX	7544
-----------	-----	---	-------	-----	--------	------	---	--------	------

LML

Star Deluxe 2-Stroke	125		-	0,7	BP8HS	2630	-	BPR8HIX	6742
Star Deluxe 4-Stroke	125		2009-	0,7	CR8EH-9	5666	Q228	CR8EHIX-9	3797
Via Toscana 2-Stroke	125		2009-	0,7	BP8HS	2630	-	BPR8HIX	6742
Star Deluxe 2-Stroke	150		-	0,7	BPR6ES	7822	-	BPR6EIX	6637
Star Deluxe 4-Stroke	150		2009-	0,7	CR8EH-9	5666	Q228	CR8EHIX-9	3797

LML- VESPA

NV 125 SPL	125	1	-	0,6	BP8ES	2912	-	BPR8EIX	6684
NV 150 SPL	150	1	-	0,6	BP8ES	2912	-	BPR8EIX	6684
NV 200 SPL	200	1	-	0,6	B5ES	6410	-	-	-

LONGJIA

Alien 50 Xooter	50	1	2008-	0,7	BR7HS	4122	Q211	BR7HIX	7067
Alien 125 Xooter	125	1	-	0,7	CR7HSA	4549	-	CR7HIX	7544

* Bitte Elektrodenabstand nach Angaben des Herstellers justieren

* Please adjust the groundelectrode gap

* Veuillez vérifier L' écartement

* Por favor, ajustar distancia entre electrodos

* regolare il gap

C
y
l

0201



Stock-№

Quick-№



Stock-№ IX

MACAL

GTX	50	1	1998-	0,6	BR7HS	4122	Q211	BR7HIX	7067
MY 50	50	1	1999-	0,6	BR7HS	4122	Q211	BR7HIX	7067
New Star	50	1	1998-	0,6	BR7HS	4122	Q211	BR7HIX	7067
Star Flight	50	1	1998-	0,6	BR7HS	4122	Q211	BR7HIX	7067
Trophy	50	1	1998-	0,6	BR8ES	5422	Q207	BR8EIX	5044

MAGELLI

125 m	125	1	2008-	0,7	DR7EA	7839	-	DR7EIX	5686
125 r	125	1	2008-	0,7	DR7EA	7839	-	DR7EIX	5686
125 s	125	1	2008-	0,7	DR7EA	7839	-	DR7EIX	5686

MAICO

Cross	250	1	1990-	0,5	B9EG	3530	-	-	-
Enduro	250	1	1990-	0,5	B9EG	3530	-	-	-
Cross	320	1	1990-	0,5	B9EG	3530	-	-	-
Enduro	320	1	1990-	0,5	B9EG	3530	-	-	-
Cross	360	1	1992-	0,5	B9EG	3530	-	-	-
Enduro	360	1	1992-	0,5	B9EG	3530	-	-	-
Cross	380	1	1991-	0,5	B9EG	3530	-	-	-
Enduro	380	1	1991-	0,5	B9EG	3530	-	-	-
Cross	440	2	1992-	0,5	B9EG	3530	-	-	-
Enduro	440	3	1992-	0,5	B9EG	3530	-	-	-
Cross	500	7	1990-	0,5	B9EG	3530	-	-	-
Enduro	500	8	1990-	0,5	B9EG	3530	-	-	-
Side Car	610	14	1991-	0,5	B8EG	3430	-	-	-
Bi Cylinder Side Car	640	15	1991-	0,5	B9EG	3530	-	-	-
Short Base Model	-	1	-	0,5	-	-	-	BR9HIX	5687

MALAGUTI

Centro	50	1	1992-	0,5	BR7HS	4122	Q211	BR7HIX	7067
Centro	50	1	2000-	0,7	BR8HS	4322	Q212	BR8HIX	7001
Centro 4 Stroke	50	1	2008-	0,7	PMR7A	4259	-	-	-
Centro 50 SL 4 Stroke	50	1	2010-	0,7	PMR7A	4259	-	-	-
Centro Luxe	50	1	1996-	0,5	BR7HS	4122	Q211	BR7HIX	7067
Centro SL	50	1	1996-	0,5	BR7HS	4122	Q211	BR7HIX	7067
Ciak	50	1	-	0,5	DR8HS	5123	-	-	-
Ciak Master 2 Stroke	50	1	1999-	0,7	BR8HS	4322	Q212	BR8HIX	7001
Ciak Master 4 Stroke	50	1	2008-	0,7	PMR7A	4259	-	-	-
CR1	50	1	1995-	0,5	BPR6HS	7022	Q214	BPR6HIX	4085
Crosser CR1	50	1	1996-	0,5	BPR6HS	7022	Q214	BPR6HIX	4085
DVD 4 Stroke Malbonline	50	1	2010-	0,7	PMR7A	4259	-	-	-
ET	50	1	-	0,6	B6HS	4510	Q203	BR6HIX	3419
F10	50	1	1993-	0,5	BR7HS	4122	Q211	BR7HIX	7067
F10-Jet Line	50	1	1996-	0,7	BR7HS	4122	Q211	BR7HIX	7067
F10-Jet Line Tigers	50	1	-	0,6	BR7HS	4122	Q211	BR7HIX	7067
F10-Jet Line Tribal	50	1	2010-	0,5	BR7HS	4122	Q211	BR7HIX	7067
F10-Jet Line WAP	50	1	2003-	0,6	BR7HS	4122	Q211	BR7HIX	7067
F11	50	1	-	0,7	BR8HS	4322	Q212	BR8HIX	7001
F12-Phantom & Luxe (ref. air)	50	1	2000-	0,7	BR7HS	4122	Q211	BR7HIX	7067

* Bitte Elektrodenabstand nach Angaben des Herstellers justieren

* Please adjust the groundelectrode gap

* Veuillez vérifier L' écartement

* Por favor, ajustar distancia entre electrodos

* regolare il gap

C
Y
L

0201



Stock-No

Quick-No



Stock-No IX

MALAGUTI

F12-Phantom (ref. liquid)	50	1	2000-	0,7	BR8HS	4322	Q212	BR8HIX	7001
F12-PHANTOM AC	50		1996-	0,5	BR7HS	4122	Q211	BR7HIX	7067
F15-Ducati Corse	50	1	2007-	0,7	BR8HS	4322	Q212	BR8HIX	7001
F15-Firefox (ref.air)	50	1	2005-	0,7	BR7HS	4122	Q211	BR7HIX	7067
F15-Firefox, Sesame (ref.liquid)	50	1	1996-	0,7	BR8HS	4322	Q212	BR8HIX	7001
Fifty Full, Fifty Top	50	1	-	0,5	B6HS	4510	Q203	BR6HIX	3419
Foggy Replica	50		-	0,5	BR8HS	4322	Q212	BR8HIX	7001
MRX	50	1	-	0,5	BP7ES	2412	Q206	BPR7EIX	4055
Phantom LC Tiger 50	50	1	1993-	0,6	BR7HS	4122	Q211	BR7HIX	7067
Rannocchio	50	1	1990-	0,5	B6HS	4510	Q203	BR6HIX	3419
RCW-Grizzly 4	50	1	1993-1996	0,5	B6HS	4510	Q203	BR6HIX	3419
RCX 10-Grizzly	50	1	1990-	0,5	B6HS	4510	Q203	BR6HIX	3419
RCX 12-Grizzly	50	1	1990-	0,5	B8HS	5510	Q205	BR8HIX	7001
Yesterday	50	1	1998-	0,5	BR7HS	4122	Q211	BR7HIX	7067
F69-Phantom	70		1997-1999	0,5	BR7HS	4122	Q211	BR7HIX	7067
Ciak	100	1	2002-	0,5	BR7HS	4122	Q211	BR7HIX	7067
F12-Phantom	100	1	-	0,5	BR7HS	4122	Q211	BR7HIX	7067
Blog	125	1	2009-	0,9	DPR7EA-9	5129	Q220	DPR7EIX-9	7803
Centro 4 Stroke	125	1	-	0,9	DPR7EA-9	5129	Q220	DPR7EIX-9	7803
Centro SL 4 Stroke	125	1	2010-	0,9	DPR7EA-9	5129	Q220	DPR7EIX-9	7803
Ciak	125	1	2001-	0,7	CR7HSA	4549	-	CR7HIX	7544
F18-Warrior 4 Stroke	125	1	2001-	0,9	DPR7EA-9	5129	Q220	DPR7EIX-9	7803
Madison	125	1	1999-	0,7	CR8E	1275	Q226	CR8EIX	4218
Madison 3	125	1	-	0,6	CR8EB	7784	-	CR8EIX	4218
Ciak 150 4 Stroke	150	1	-	0,7	CR7HSA	4549	-	CR7HIX	7544
T-Madison	150	1	-	0,7	CR8E	1275	Q226	CR8EIX	4218
Blog	160	1	-	0,9	DPR7EA-9	5129	Q220	DPR7EIX-9	7803
Centro 4 Stroke	160	1	-	0,9	DPR7EA-9	5129	Q220	DPR7EIX-9	7803
Centro SL 4 Stroke	160	1	2010-	0,9	DPR7EA-9	5129	Q220	DPR7EIX-9	7803
R-Madison	180		-2001	0,7	CR9EB	6955	-	CR9EIX	3521
S-Madison	180		2001-	0,7	CR8EB	7784	-	CR8EIX	4218
F12-Phantom Max	200	1	2004-	0,6	CR8EB	7784	-	CR8EIX	4218
Madison S	200	1	2003-	0,7	CR8EB	7784	-	CR8EIX	4218
Madison	250		1999-2004	0,9	DPR9EA-9	5329	Q222	DPR9EIX-9	5545
Madison 3	250	1	-	0,7	PMR8B	6378	-	-	-
Madison S	250	1	1999-	0,6	DR8EA	7162	-	DR8EIX	6681
Password	250	1	-	0,9	DPR8EA-9	4929	Q221	DPR8EIX-9	2202
K-Madison	400	1	2002-	0,8	CR7E	4578	Q225	CR7EIX	7385
Madison	400	1	2003-	0,8	CR9E	6263	Q227	CR9EIX	3521
Spidermax 500 GT	500	1	2004-	0,6	CR7EKB	4455	-	CR7EIX	7385
Spidermax 500 RS	500	1	2010-	0,6	CR7EKB	4455	-	CR7EIX	7385

MASH

Cafe Racer	125		2014-	0,7	CR7E	4578	Q225	CR7EIX	7385
Scrambler	125		2014-	0,7	CR7E	4578	Q225	CR7EIX	7385
Seventy	125		2014-	0,7	CR7E	4578	Q225	CR7EIX	7385
Seventy Five	125		2014-	0,7	CR7E	4578	Q225	CR7EIX	7385
Sixty Five	125		2014-	0,7	CR7E	4578	Q225	CR7EIX	7385
Storia	125		2014-	0,7	CR7E	4578	Q225	CR7EIX	7385
Two Fifty	250	1	2014-	0,7	DR8EA	7162	-	DR8EIX	6681
Five Hundred	400	1	2014-	0,6	DPR8Z	4730	-	-	-

* Bitte Elektrodenabstand nach Angaben des Herstellers justieren

* Please adjust the groundelectrode gap

* Veuillez vérifier L' écartement

* Por favor, ajustar distancia entre electrodos

* regolare il gap

C
Y
L

0201



Stock-№

Quick-№



Stock-№ IX

MBK									
51-Club Swing	50	1	-	0,7	B6HS	4510	Q203	BR6HIX	3419
51-Club, Club VR	50	1	-	0,7	B7HS	5110	Q204	BR7HIX	7067
51-Collection	50	1	-	0,7	B7HS	5110	Q204	BR7HIX	7067
51-Evasion	50	1	-	0,7	B7HS	5110	Q204	BR7HIX	7067
51-Jazz, Hard Rock	50	1	-	0,7	B7HS	5110	Q204	BR7HIX	7067
51-Mag Max	50	1	-	0,7	B8ES	2411	Q201	BR8EIX	5044
51-Magnum Racing	50	1	-	0,7	B6HS	4510	Q203	BR6HIX	3419
51-Magnum Racing XR (ref.liquid)	50	1	-	0,7	B8ES	2411	Q201	BR8EIX	5044
51-Passion	50	1	-	0,7	B8ES	2411	Q201	BR8EIX	5044
51-Roadster	50	1	-	0,7	B8ES	2411	Q201	BR8EIX	5044
51-V	50	1	-	0,7	B7HS	5110	Q204	BR7HIX	7067
881-P, U (air)	50	1	-	0,7	B6HS	4510	Q203	BR6HIX	3419
89-Air	50	1	-	0,7	B6HS	4510	Q203	BR6HIX	3419
Active	50	1	-	0,5	BR7HS	4122	Q211	BR7HIX	7067
Booster	50	1	1990-1994	0,6	BPR7HS	6422	Q215	BPR7HIX	5944
Booster	50	1	1997-	0,6	BR8HS	4322	Q212	BR8HIX	7001
Booster "10 years Spécial"	50	1	2000-	0,7	BR8HS	4322	Q212	BR8HIX	7001
Booster F1	50	1	-	0,7	BR8HS	4322	Q212	BR8HIX	7001
Booster NG	50	1	1997-	0,6	BR8HS	4322	Q212	BR8HIX	7001
Booster Original	50	1	-	0,7	BR8HS	4322	Q212	BR8HIX	7001
Booster Power Rocket	50	1	-	0,7	BR8HS	4322	Q212	BR8HIX	7001
Booster R 50	50	1	-	0,6	BR7HS	4122	Q211	BR7HIX	7067
Booster Road	50	1	-	0,7	BR7HS	4122	Q211	BR7HIX	7067
Booster Rocket	50	1	1997-	0,7	BR8HS	4322	Q212	BR8HIX	7001
Booster Spirit	50	1	-	0,7	BR8HS	4322	Q212	BR8HIX	7001
Booster Spirit SAS	50	1	1999-	0,7	BR8HS	4322	Q212	BR8HIX	7001
Booster Track	50	1	1997-	0,7	BR8HS	4322	Q212	BR8HIX	7001
Champ	50	1	-	0,7	BPR6HS	7022	Q214	BPR6HIX	4085
Champ 88, 89	50	1	-	0,7	B6HS	4510	Q203	BR6HIX	3419
CT-S	50	1	-	1,0	BP7HS-10	7829	-	-	-
CT-SS	50	1	-	1,0	BP7HS-10	7829	-	-	-
Dakota	50	1	2005-	0,7	BR7HS	4122	Q211	BR7HIX	7067
DX-Boite 5	50	1	-	0,7	BR8ES	5422	Q207	BR8EIX	5044
DX-S	50	1	-	0,7	BR7HS	4122	Q211	BR7HIX	7067
Equalis	50	1	-	0,7	BR7HS	4122	Q211	BR7HIX	7067
Evolis, Business Class	50	1	1994-	0,7	BR7HS	4122	Q211	BR7HIX	7067
Fizz	50	1	-	0,6	BR8HS	4322	Q212	BR8HIX	7001
Flipper	50	1	1998-	0,6	BR8HS	4322	Q212	BR8HIX	7001
Forte	50	1	1996-	0,6	BR8HS	4322	Q212	BR8HIX	7001
Hot Champ	50	1	-	0,7	BR7HS	4122	Q211	BR7HIX	7067
Kansas	50	1	2005-	0,7	BR7HS	4122	Q211	BR7HIX	7067
Mach G (AC)	50	1	2004-	0,7	BR8HS	4322	Q212	BR8HIX	7001
Mach G (LC)	50	1	2004-	0,7	BR8HS	4322	Q212	BR8HIX	7001
New Sorriso 50	50	1	1995-	0,6	BP7HS	5111	-	BPR7HIX	5944
Nitro	50	1	1997-	0,7	BR8HS	4322	Q212	BR8HIX	7001
Nitro F1 "Mc Laren"	50	1	2000-	0,7	BR8HS	4322	Q212	BR8HIX	7001
Nitro Jaguar Racing	50	1	2004-	0,7	BR8HS	4322	Q212	BR8HIX	7001
Ovetto	50	1	1997-	0,7	BR7HS	4122	Q211	BR7HIX	7067
Ovetto 4	50	1	2014-	0,8	CR7E	4578	Q225	CR7EIX	7385
Phoenix	50	1	2005-	0,7	BR7HS	4122	Q211	BR7HIX	7067
Sorriso	50	1	-	1,0	BP7HS-10	7829	-	-	-
Stunt	50	1	1999-	0,6	BR9HS	4522	-	BR9HIX	5687

* Bitte Elektrodenabstand nach Angaben des Herstellers justieren

* Please adjust the groundelectrode gap

* Veuillez vérifier L' écartement

* Por favor, ajustar distancia entre electrodos

* regolare il gap

C
Y
L

0201



Stock-No

Quick-No



Stock-No IX

MBK

Stunt	50	1	2003-	0,6	BR8HS	4322	Q212	BR8HIX	7001
Target	50	1	-	0,6	BP7HS	5111	-	BPR7HIX	5944
X power	50	1	2003-	0,8	BR9ES	5722	Q208	BR9EIX	3981
X-Limit	50	1	1996-2004	0,7	BR8ES	5422	Q207	BR8EIX	5044
X-Limit	50	1	2005-	0,7	BR9ES	5722	Q208	BR9EIX	3981
X-Power	50	1	1996-	0,7	BR8ES	5422	Q207	BR8EIX	5044
Active	80	1	-	0,7	BPR7HS	6422	Q215	BPR7HIX	5944
Evolis, Business Class	80	1	-	0,7	BR8HS	4322	Q212	BR8HIX	7001
Zest	80	1	-	0,7	BR7HS	4122	Q211	BR7HIX	7067
Booster	100	1	1999-	1,0	BPR7HS-10	1092	-	-	-
Nitro	100	1	2000-	1,0	BR8HS-10	1134	-	-	-
Ovetto	100	1	2000-	1,0	BR8HS-10	1134	-	-	-
Active	125	1	-1995	0,7	CR6HSA	2983	-	CR6HIX	7274
Doodo	125	1	2000-	0,6	CR8E	1275	Q226	CR8EIX	4218
Flame R	125	1	2000-	0,7	CR7E	4578	Q225	CR7EIX	7385
Flame, Flame R	125	1	1995-1999	0,7	CR7E	4578	Q225	CR7EIX	7385
Skycruiser	125	1	2006-	0,9	CPR9EA-9	2308	-	-	-
Skyliner	125	1	1998-	0,7	CR8E	1275	Q226	CR8EIX	4218
Thunder	125	1	2001-	0,6	CR8E	1275	Q226	CR8EIX	4218
XC-Flame	125	1	-1994	0,7	CR6HSA	2983	-	CR6HIX	7274
XC-Flame	125	1	1995-	0,7	CR7E	4578	Q225	CR7EIX	7385
X-Over	125	1	2010-	0,9	CPR9EA-9	2308	-	-	-
Vertex	150		-	0,7	CR7E	4578	Q225	CR7EIX	7385
Skyliner	180	1	2003-	0,8	CR8E	1275	Q226	CR8EIX	4218
Kilibre	300	1	2003-	0,9	DR8EA	7162	-	DR8EIX	6681
Skyliner	400		2004-	0,7	CR7E	4578	Q225	CR7EIX	7385

MIDWEST

JC50Q-9	50	1	2000-	*	CR6HSA	2983	-	CR6HIX	7274
JC70Y	70	1	2000-	*	CR6HSA	2983	-	CR6HIX	7274
JS70Y	70	1	2000-	*	CR6HSA	2983	-	CR6HIX	7274
JS90Y	90	1	2000-	*	CR6HSA	2983	-	CR6HIX	7274
JC150Y	150	1	2000-	*	DR7EA	7839	-	DR7EIX	5686
JS200Y	200	1	2000-	*	DR7EA	7839	-	DR7EIX	5686

MINSK

MMB3-3	125	1	-	0,7	BP7HS	5111	-	BPR7HIX	5944
MMB3-3.112 7,3kW	125	1	-	0,7	BP7HS	5111	-	BPR7HIX	5944
MMB3-3.113 7,3kW	125	1	-	0,7	BP7HS	5111	-	BPR7HIX	5944
MMB3-3.1131 7,3kW	125	1	-	0,7	BP7HS	5111	-	BPR7HIX	5944
MMB3-3.11311 7,3kW	125	1	-	0,7	BP7HS	5111	-	BPR7HIX	5944
Mototeleschka C-3.901 7,3kW	125	1	-	0,7	BP7HS	5111	-	BPR7HIX	5944

MONDIAL

Cross Special	50	1	-	0,5	B7HS	5110	Q204	BR7HIX	7067
Mondialino	50	1	-	0,5	B7HS	5110	Q204	BR7HIX	7067
Radial	50	1	-	0,5	B8HS	5510	Q205	BR8HIX	7001
Regolarita	50	1	-	0,5	B8HS	5510	Q205	BR8HIX	7001
Special V4 Record	50	1	-	0,5	B7ES	1111	-	BR7EIX	6664
Touring	50	1	-	0,5	B8HS	5510	Q205	BR8HIX	7001
Tourismo	50	1	-	0,5	B7HS	5110	Q204	BR7HIX	7067
Cross Radial v6	125	1	-	0,5	B7HS	5110	Q204	BR7HIX	7067

* Bitte Elektrodenabstand nach Angaben des Herstellers justieren

* Please adjust the groundelectrode gap

* Veuillez vérifier l' écartement

* Por favor, ajustar distancia entre electrodos

* regolare il gap

C
y
l

0201



Stock-№

Quick-№



Stock-№ IX

MONDIAL

175 SS	175	1	-	0,5	B9HS	5810	-	BR9HIX	5687
SP-Piega VTR	1000	2	2003-	1,1	FR9BI-11	4709	-	-	-

MONTESA

COTA	123	1	-	0,5	B6ES	7310	-	-	-
MH-Honda Engine	123	1	-	0,7	BR7ES	5122	-	BR7EIX	6664
COTA-172	175	1	-	0,5	B6ES	7310	-	-	-
COTA-200	175	1	-	0,5	B6ES	7310	-	-	-
MH-Honda Engine	200	1	-	0,5	BPR7ES	2023	-	BPR7EIX	4055
310	250	1	-	0,5	BPR7ES	2023	-	BPR7EIX	4055
COTA-247	250	1	-	0,5	B8HS	5510	Q205	BR8HIX	7001
COTA-248	250	1	-	0,5	BP5ES	6511	-	BPR5EIX	6597
COTA-315 Honda Engine	250	1	1997-1999	0,6	BR6ES	4922	-	-	-
COTA-4 RT	250	1	2005-	0,9	CR6EH-9	2688	-	-	-
COTA-4RT Repsol (242)	250	1	2009-	0,9	CR6EH-9	2688	-	-	-
311	260		-	0,5	BPR5ES	7422	-	BPR5EIX	6597
314	260		-	0,6	BR6ES	4922	-	-	-
304, 307, 309	260		-	0,5	BPR5ES	7422	-	BPR5EIX	6597
COTA	309	1	-	0,6	BPR7ES	2023	-	BPR7EIX	4055
348	310		-	0,5	BPR5ES	7422	-	BPR5EIX	6597
COTA-Evasion	310	1	-	0,6	BPR7ES	2023	-	BPR7EIX	4055
COTA-R	315	1	1997-	0,6	BR6ES	4922	-	-	-
330	330		-	0,5	BPR5ES	7422	-	BPR5EIX	6597
335	350		-	0,5	BPR5ES	7422	-	BPR5EIX	6597
Cota 349	350		-	0,5	BP5ES	6511	-	BPR5EIX	6597

MOPEX

S 2200	49	1	2006-	0,7	BR6HS	3922	Q209	BR6HIX	3419
S 3800	49	1	2006-	0,7	BR6HS	3922	Q209	BR6HIX	3419
S 4800	49	1	2006-	0,7	BR6HS	3922	Q209	BR6HIX	3419

MOTO GUZZI

Nevada Club	350	2	1998-1999	0,7	BR8ES	5422	Q207	BR8EIX	5044
Nevada NT	350	2	1994-1997	0,7	BR8ES	5422	Q207	BR8EIX	5044
V65	650	2	1987-	0,5	BCPR6ES	2330	-	BCPR6EIX	5689
V-Florida	650	2	1992-	0,6	B8ES	2411	Q201	BR8EIX	5044
Breva	750	2	-	0,6	BR8ES	5422	Q207	BR8EIX	5044
Nevada Anniversario	750	2	2012-	0,9	CPR8EB-9	6607	-	-	-
Nevada Aquila Nera	750	2	2010-	0,6	BR8ES	5422	Q207	BR8EIX	5044
Nevada Base-Club	750	2	2002-2003	0,6	BR8ES	5422	Q207	BR8EIX	5044
Nevada Basic	750	2	1992-	0,6	B8ES	2411	Q201	BR8EIX	5044
Nevada Classic	750	2	2004-	0,6	BR8ES	5422	Q207	BR8EIX	5044
Nevada Classic Anniversario	750	2	2010-2011	0,6	BR8ES	5422	Q207	BR8EIX	5044
Nevada Club	750	2	1998-2001	0,6	BR8ES	5422	Q207	BR8EIX	5044
Nevada NT	750	2	1994-1997	0,7	BR8ES	5422	Q207	BR8EIX	5044
Racer	750	2	2012-	0,9	CPR8EB-9	6607	-	-	-
Spécial	750	2	2012-	0,9	CPR8EB-9	6607	-	-	-
V7	750	2	2012-	0,9	CPR8EB-9	6607	-	-	-
V7 Café Classic	750	2	2009-	0,6	BR8ES	5422	Q207	BR8EIX	5044
V7 Classic	750	2	2008-	0,6	BR8ES	5422	Q207	BR8EIX	5044

* Bitte Elektrodenabstand nach Angaben des Herstellers justieren

* Please adjust the groundelectrode gap

* Veuillez vérifier L' écartement

* Por favor, ajustar distancia entre electrodos

* regolare il gap

C
Y
I

0201



Stock-No

Quick-No



Stock-No IX

MOTO GUZZI

V7 Racer	750	2	2010-	0,7	BR8ES	5422	Q207	BR8EIX	5044
V7 Spécial	750	2	2012-	0,9	CPR8EB-9	6607	-	-	-
V7 Stone	750	2	2012-	0,9	CPR8EB-9	6607	-	-	-
V-Breva i.e	750	2	2004-	0,6	BPR6ES	7822	-	BPR6EIX	6637
Griso	850	2	2006-	0,6	BPR6ES	7822	-	BPR6EIX	6637
Norge	850	2	2007-	0,7	BPR6ES	7822	-	BPR6EIX	6637
T4, T5, TS 5	850	2	-	0,6	BP6ES	7811	-	BPR6EIX	6637
V-Breva	850	2	2006-	0,6	BPR6ES	7822	-	BPR6EIX	6637
Bellagio	936	2	2010-	0,6	BPR6ES	7822	-	BPR6EIX	6637
Bellagio	940	2	2007-	0,7;	BPR6ES;	7822;	-	BPR6EIX;	6637;
Twin Spark				0,7	PMR8B	6378	-	PMR8B	6378
California (Carbu. & Inj.)	1000	2	1994-1997	0,7	BPR6ES	7822	-	BPR6EIX	6637
Daytona	1000	2	1992-1995	0,7	D9EA	2420	-	DR9EIX	4772
Daytona Racing	1000	2	1996-1996	0,7	D9EA	2420	-	DR9EIX	4772
Daytona RS	1000	2	1997-1998	0,7	DR9EA	3437	Q219	DR9EIX	4772
Quota	1000	2	1992-1997	0,6	BP7ES	2412	Q206	BPR7EIX	4055
Quota I.E.	1000	2	-	0,7	BPR8ES	3923	Q213	BPR8EIX	6684
Series 1000	1000		-	0,7	BP6ES	7811	-	BPR6EIX	6637
Strada	1000	2	-	0,6	BP6ES	7811	-	BPR6EIX	6637
V10-Centauro	1000	2	1996-1999	0,7	DR9EA	3437	Q219	DR9EIX	4772
V10-Centauro GT	1000	2	1996-	0,7	DR9EA	3437	Q219	DR9EIX	4772
V10-Centauro Sport	1000	2	1996-	0,7	DR9EA	3437	Q219	DR9EIX	4772
California Aluminium	1100	2	2003-2004	0,7	BPR6ES	7822	-	BPR6EIX	6637
California Aquila Nera	1100	2	2010-	0,6	BPR6ES;	7822;	-	-	-
					PMR8B	6378	-	-	-
California Carb. Inj. /Special	1100	2	1994-1997	0,6	BPR6ES	7822	-	BPR6EIX	6637
California Classic	1100	2	2006-	0,6;	BPR6ES;	7822;	-	BPR6EIX;	6637;
				0,7	PMR8B	6378	-	PMR8B	6378
California EV	1100	2	1997-2005	0,7	BPR6ES	7822	-	BPR6EIX	6637
California EV Touring	1100	2	2001-2002	0,7	BPR6ES	7822	-	BPR6EIX	6637
California Jackal	1100	2	1999-2001	0,7	BPR6ES	7822	-	BPR6EIX	6637
California Special	1100	2	1999-2000	0,7	BPR6ES	7822	-	BPR6EIX	6637
California Special Sport	1100	2	2001-2002	0,7	BPR6ES	7822	-	BPR6EIX	6637
California Stone Metal	1100	2	2001-2002	0,7	BPR6ES	7822	-	BPR6EIX	6637
California Stone Touring	1100	2	2003-2004	0,7	BPR6ES	7822	-	BPR6EIX	6637
California Titanium	1100	2	2003-2004	0,7	BPR6ES	7822	-	BPR6EIX	6637
California Touring	1100	2	2006-2006	0,6;	BPR6ES;	7822;	-	BPR6EIX;	6637;
Twin Spark				0,7	PMR8B	6378	-	PMR8B	6378
California Vintage 90er Anniversary	1100	2	2011-	0,7;	BPR6ES;	7822;	-	BPR6EIX;	6637;
				0,7	PMR8B	6378	-	PMR8B	6378
California Vintage	1100	2	2006-	0,7;	BPR6ES;	7822;	-	BPR6EIX;	6637;
Twin Spark				0,7	PMR8B	6378	-	PMR8B	6378
Griso Twin Spark	1100	2	2005-	0,7;	BPR6ES;	7822;	-	BPR6EIX;	6637;
				0,7	PMR8B	6378	-	PMR8B	6378
Quota I.E. / ES	1100	2	1998-2002	0,6	BPR6ES	7822	-	BPR6EIX	6637
Sport	1100	2	1994-1999	0,7	BPR6ES	7822	-	BPR6EIX	6637
V11-Ballabio	1100	2	2003-2005	0,7	BPR6ES	7822	-	BPR6EIX	6637
V11-Cafe Sport	1100	2	2003-2005	0,7	BPR6ES	7822	-	BPR6EIX	6637
V11-Coppa Italia	1100	2	2003-2004	0,7	BPR6ES	7822	-	BPR6EIX	6637
V11-Le Mans	1100	2	2001-2004	0,7	BPR6ES	7822	-	BPR6EIX	6637
V11-Le Mans Nero / Rosso	1100	2	2004-	0,6	BPR6ES	7822	-	BPR6EIX	6637
V11-Naked, Sucra	1100	2	2003-	0,6	BPR6ES	7822	-	BPR6EIX	6637

* Bitte Elektrodenabstand nach Angaben des Herstellers justieren

* Please adjust the groundelectrode gap

* Veuillez vérifier L' écartement

* Por favor, ajustar distancia entre electrodos

* regolare il gap

C
y
l

0201



Stock-№

Quick-№



Stock-№ IX

MOTO GUZZI

V11-Scura R	1100	2	2004-2005	0,7	BPR6ES	7822	-	BPR6EIX	6637
V11-Sport	1100	2	1999-2004	0,7	BPR6ES	7822	-	BPR6EIX	6637
V11-Sport Ballado	1100	2	2003-	0,6	BPR6ES	7822	-	BPR6EIX	6637
V11-Sport IE, Sport IE Corsa	1100	2	1995-1999	0,6	BPR6ES	7822	-	BPR6EIX	6637
V11-	1100	2	2005-	0,7;	BPR6ES;	7822;		BPR6EIX;	6637;
				0,7	PMR8B	6378	-	PMR8B	6378
V-Breva -	1100	2	2005-	0,7;	BPR6ES;	7822;		BPR6EIX;	6637;
				0,7	PMR8B	6378	-	PMR8B	6378
Breva V1200 Twin spark	1150	2	2008-	0,7;	BPR6ES;	7822;		BPR6EIX;	6637;
				0,7	PMR8B	6378	-	PMR8B	6378
Stelvio 1200 4V	1150	2	2008-	0,7	PMR8B	6378	-	-	-
Griso 8V Special Edition	1151		2009-	0,7	CR8EKB	4374	-	CR8EIX	4218
Norge GT 8V	1151		2009-	0,7	CR8EKB	4374	-	CR8EIX	4218
Stelvio 1200 NTX	1151		2009-	0,7	CR8EKB	4374	-	CR8EIX	4218
Griso 8V	1200	2	2008-	0,7	PMR8B	6378	-	-	-
Norge	1200	2	2006-	0,7;	BPR6ES;	7822;		BPR6EIX;	6637;
				0,7	PMR8B	6378	-	PMR8B	6378
Sport	1200		2007-2009	*	BPR6ES;	7822;		-	-
					PMR8B	6378	-	-	-
Sport 4V	1200	2	2009-	0,7	CR8EKB	4374	-	CR8EIX	4218
Stelvio / NTX	1200	2	2011-	0,7	CR8EKB	4374	-	CR8EIX	4218
MGS-01-Corsa	1225	2	2004-	0,6	-	-	-	DCPR9EIX	2316
MGS-Café Sport	1225	2	2004-	0,7	D10EA	2720	-	-	-
California Touring	1400	2	2012-	0,9	LMAR8F-9	90894	-	-	-

MOTO HISPANA

Furia, Furia Cross - 12,7mm	50	1	1999-	0,6	BPR7HS	6422	Q215	BPR7HIX	5944
Furia, Furia Cross - 19mm	50	1	1999-	0,6	BR9ES	5722	Q208	BR9EIX	3981
RX	50	1	-	0,6	BR9ES	5722	Q208	BR9EIX	3981
RYZ-Cross, Supermoto	50	1	-	0,6	BR9ES	5722	Q208	BR9EIX	3981
RYZ	125		-	0,6	CR7HSA	4549	-	CR7HIX	7544

MOTO MORINI

9,5	1187	2	2006-	0,7	CR9E	6263	Q227	CR9EIX	3521
Corsaro	1187	2	2006-	0,7	CR9E	6263	Q227	CR9EIX	3521

MOTO ROMA

GoGo 50	50		2002-	0,6	BPR7HS	6422	Q215	BPR7HIX	5944
MRX2 Sprint	50		2002-	0,6	B7HS	5110	Q204	BR7HIX	7067
MRX3	50		2002-	0,6	B6HS	4510	Q203	BR6HIX	3419
MRX3 Sprint	50		2002-	0,6	B7HS	5110	Q204	BR7HIX	7067
MRX4	50		2003-	0,7	BR10ES	4832	-	BR10EIX	6801
Roadrunner 50	50		-	0,6	BP7HS	5111	-	BPR7HIX	5944
RT 50 (2-Stroke)	50		2002-	0,6	BPR7HS	6422	Q215	BPR7HIX	5944
RT 90 (4-Stroke)	90		2002-	0,6	BPR7HS	6422	Q215	BPR7HIX	5944
GoGo 110	110		2002-	0,6	CR7HS	7223	-	CR7HIX	7544
MRX125	125		2002-	0,6	D8EA	2120	Q216	DR8EIX	6681
Road Runner 125	125		2002-	0,6	C7HSA	4629	-	CR7HIX	7544
SK125	125		2010-	0,6	DR8EA	7162	-	DR8EIX	6681

* Bitte Elektrodenabstand nach Angaben des Herstellers justieren

* Please adjust the groundelectrode gap

* Veuillez vérifier L' écartement

* Por favor, ajustar distancia entre electrodos

* regolare il gap

C
Y
L

0201



Stock-No

Quick-No



Stock-No IX

MOTOBECANE

All Models	50	1	-	0,6	B6HS	4510	Q203	BR6HIX	3419
------------	----	---	---	-----	------	------	------	--------	------

MOTOR TEK

MT 50	50	1	2005-	0,5	BR8HSA	5539	-	BR8HIX	7001
-------	----	---	-------	-----	--------	------	---	--------	------

MOTO-SPEZIAL

Bassa-Lunga	1100	2	1999-	0,8	BP6ES	7811	-	BPR6EIX	6637
Sportiva 1100i	1100	2	1999-	0,8	BP6ES	7811	-	BPR6EIX	6637

MOTOTECHNIKA

Tricycle "ZID-50"	50	1	1998-	0,6	BP7HS	5111	-	BPR7HIX	5944
-------------------	----	---	-------	-----	-------	------	---	---------	------

MOTRON

Sting 50	50	1	1996-	0,6	BR7HS	4122	Q211	BR7HIX	7067
Thunder 50	50	1	1996-	0,6	BR7HS	4122	Q211	BR7HIX	7067

MSA

MX	50	1	-	0,7	BR8HSA	5539	-	BR8HIX	7001
RC	50	1	1999-	0,7	BR8ES	5422	Q207	BR8EIX	5044
RC-SM	50	1	1999-	0,7	BR8ES	5422	Q207	BR8EIX	5044
RC-Trophy "YACCO"	50	1	2000-	0,7	BR8ES	5422	Q207	BR8EIX	5044
RSE	50	1	1999-	0,7	BR8ES	5422	Q207	BR8EIX	5044
RTW	50	1	2000-	0,7	BR8ES	5422	Q207	BR8EIX	5044
SM-Super Motard	50	1	2001-	0,7	BR8ES	5422	Q207	BR8EIX	5044

MV AGUSTA

Brutale	675	3	2013-	0,7	CR9EKB	2305	-	CR9EIX	3521
F3	675	3	2012-	0,7	CR9EKB	2305	-	CR9EIX	3521
F3-/Oro	675	3	2011-	0,7	CR9EKB	2305	-	CR9EIX	3521
F4-Brutale oro 93kW	750	4	1999-	0,7	CR9EKB	2305	-	CR9EIX	3521
F4-Brutale S	750	4	2001-2005	0,7	CR9EKB	2305	-	CR9EIX	3521
F4-Oro / S	750	4	1999-	0,7	CR9EB	6955	-	CR9EIX	3521
F4-Oro --> Fgst.300	750	4	1999-	0,7	CR9EKB	2305	-	CR9EIX	3521
F4-S 1+1 (biposto)	750	4	2000-	0,7	CR9EB	6955	-	CR9EIX	3521
F4-S American	750	4	-	0,5	B7ES	1111	-	BR7EIX	6664
F4-SS PR / Senna / 103KW	750	4	1999-	0,7	CR9EKB	2305	-	CR9EIX	3521
Brutale	800	3	2012-	0,9	CR9EIB-9	92579	-	-	-
Rivale	800	3	2013-	0,9	CR9EIB-9	92579	-	-	-
F4-Brutale 910 / R	910	4	2005-	0,7	CR9EB	6955	-	CR9EIX	3521
Brutale R	990	4	2010-	0,7	CR9EB	6955	-	CR9EIX	3521
F4-1000 S/ Senna	1000	4	2004-	1,1	R0045J-10	7400	-	-	-
F4-1000 Tamburini	1000	4	2004-	1,1	R0045J-10	7400	-	-	-
Brutale 1090	1078	4	2012-	0,7	CR9EB	6955	-	CR9EIX	3521
Brutale 1090 R	1078	4	2010-	0,7	CR9EB	6955	-	CR9EIX	3521
F4-Brutale 1078 RR	1078	4	2008-	0,7	CR9EB	6955	-	CR9EIX	3521
F4-RR 312	1078	4	2008-	0,7	CR9EB	6955	-	CR9EIX	3521

* Bitte Elektrodenabstand nach Angaben des Herstellers justieren

* Please adjust the groundelectrode gap

* Veuillez vérifier L' écartement

* Por favor, ajustar distancia entre electrodos

* regolare il gap

C
y
l

0201



Stock-№

Quick-№



Stock-№ IX

MZ									
Moskito FB	50	1	1997-	0,6	BR7HS	4122	Q211	BR7HIX	7067
Moskito RX	50	1	2002-	0,6	BR8HSA	5539	-	BR8HIX	7001
Moskito SX	50	1	1999-	0,9	BR7HS	4122	Q211	BR7HIX	7067
Fun X	125		2001-	0,7	CR8E	1275	Q226	CR8EIX	4218
RT	125	1	2000-	0,7	CR8E	1275	Q226	CR8EIX	4218
Saxon Roadster	125	1	1994-	0,6	B8HS	5510	Q205	BR8HIX	7001
SM	125	1	2001-	0,7	CR8E	1275	Q226	CR8EIX	4218
SM-Cup Replica	125	1	2005-	0,6	CR8E	1275	Q226	CR8EIX	4218
SM-Gangata	125	1	2005-	0,6	CR8E	1275	Q226	CR8EIX	4218
SM-Twin Colour	125	1	2006-	0,6	CR8E	1275	Q226	CR8EIX	4218
Sportstar	125	1	1993-	0,6	B8HS	5510	Q205	BR8HIX	7001
Striker RT	125	1	2005-	0,6	CR8E	1275	Q226	CR8EIX	4218
Supermoto	125	1	2005-	0,6	CR8E	1275	Q226	CR8EIX	4218
SX	125	1	2001-	0,7	CR8E	1275	Q226	CR8EIX	4218
Younster Cup	125	1	2003-	0,6	CR8E	1275	Q226	CR8EIX	4218
Roadster	150	1	-	0,6	B8HS	5510	Q205	BR8HIX	7001
Saxon Tour	250	1	1994-	0,6	B8HS	5510	Q205	BR8HIX	7001
Country	500	1	1994-	0,7	D8EA	2120	Q216	DR8EIX	6681
Silverstar/Classic/Voyager	500	1	1994-	0,7	D8EA	2120	Q216	DR8EIX	6681
Tour	500	1	1995-	0,7	D8EA	2120	Q216	DR8EIX	6681
Baghira, Black Panther, Mastiff, Supermoto	650		1998-	0,9	DPR8EA-9	4929	Q221	DPR8EIX-9	2202
Baghira Enduro & Forest	660	1	1998-	0,9	DPR8EA-9	4929	Q221	DPR8EIX-9	2202
Baghira HR SM Street Moto	660	1	2004-	0,9	DPR9EA-9	5329	Q222	DPR9EIX-9	5545
Mastiff	660	1	1998-	0,9	DPR8EA-9	4929	Q221	DPR8EIX-9	2202
Skorpion Sport/Tour/Traveller	660	1	1994-	0,9	DPR9EA-9	5329	Q222	DPR9EIX-9	5545
S / SF / ST	1000	2	2004-	0,8	BCPR6ET	2197	-	BCPR6EIX	5689

MZ KANUNI									
SM-Classic	125		1997-	0,5	B8HS	5510	Q205	BR8HIX	7001
Kanuni	300		1997-	0,5	B8HS	5510	Q205	BR8HIX	7001

P.G.O.									
Big Max, Sport / LTD / R	50	1	1995-	0,5	BPR7HS	6422	Q215	BPR7HIX	5944
Comet , PMX Sport, Rodoshow, T-Rex	50		1998-	0,6	BPR7HS	6422	Q215	BPR7HIX	5944
Comet, Light, Sport, Larrousse F1	50	1	1993-	0,7	BP7HS	5111	-	BPR7HIX	5944
Galaxy, Galaxy Junior	50	1	1993-	0,7	BP7HS	5111	-	BPR7HIX	5944
G-Max	50	1	2004-	0,6	BPR7HS	6422	Q215	BPR7HIX	5944
Libra	50		2008-	0,6	BPR7HS	6422	Q215	BPR7HIX	5944
Ligero	50		2008-	0,6	BPR7HS	6422	Q215	BPR7HIX	5944
Mega 50	50	1	1996-	0,5	BPR7HS	6422	Q215	BPR7HIX	5944
New Galaxy 50	50	1	-	0,6	BP6HS	4511	-	BPR6HIX	4085
PMS	50	1	1999-	0,7	BP7HS	5111	-	BPR7HIX	5944
PMX	50	1	1997-	0,7	BP7HS	5111	-	BPR7HIX	5944
Road 66	50	1	1994-	0,7	BP7HS	5111	-	BPR7HIX	5944
Rodoshow	50	1	2000-	0,7	BP7HS	5111	-	BPR7HIX	5944
Star	50	1	1992-	0,7	BP6HS	4511	-	BPR6HIX	4085
Star 2	50	1	1994-	0,7	BP7HS	5111	-	BPR7HIX	5944
Super Comet 50	50	1	-	0,7	BP7HS	5111	-	BPR7HIX	5944
Tornado	50	1	1997-2000	0,5	BPR7HS	6422	Q215	BPR7HIX	5944
TR3	50	1	-	0,7	BP7HS	5111	-	BPR7HIX	5944
TR3-50	50	1	-	0,7	BP7HS	5111	-	BPR7HIX	5944
T-Rex 50	50	1	1999-	0,7	BP7HS	5111	-	BPR7HIX	5944

* Bitte Elektrodenabstand nach Angaben des Herstellers justieren

* Please adjust the groundelectrode gap

* Veuillez vérifier L' écartement

* Por favor, ajustar distancia entre electrodos

* regolare il gap

C
Y
L

0201



Stock-No

Quick-No



Stock-No IX

P.G.O.

Big Max 1.25	80	1	1996-	0,5	BPR7HS	6422	Q215	BPR7HIX	5944
Star	80	1	1992-	0,7	BP6HS	4511	-	BPR6HIX	4085
Big Max 90	90	1	1996-	0,5	BPR7HS	6422	Q215	BPR7HIX	5944
Galaxy	90	1	-	0,6	BPR7HS	6422	Q215	BPR7HIX	5944
G-Max	125	1	2005-	0,7	C7HSA	4629	-	CR7HIX	7544
Libra 125	125		2008-	0,6	C7HSA	4629	-	CR7HIX	7544
Ligero 125	125		2008-	0,6	C7HSA	4629	-	CR7HIX	7544
Tornado	125	1	-	0,7	BPR7HS	6422	Q215	BPR7HIX	5944
T-Rex 125 2 Stroke	125	1	1998-	0,6	BP7HS	5111	-	BPR7HIX	5944
T-Rex 125 4 Stroke	125	1	1998-	0,7	CR7HSA	4549	-	CR7HIX	7544
T-Rex 150 4 Stroke	150	1	2003-	0,7	CR7HSA	4549	-	CR7HIX	7544
G-Max 250	250		2005-2007	0,7	DPR7EA-9	5129	Q220	DPR7EIX-9	7803

PEUGEOT MOTORCYCLES

101, 102, 103, 104, 105	50	1	1975-	0,5	B5HS	4510	-	BR5HIX	3419
103-MVL M	50	1	-	0,7	BP5HS	4111	-	-	-
103-RCX M, LC M	50	1	-	0,6	BR7HS	4122	Q211	BR7HIX	7067
103-SPX	50	1	2002-	0,7	BR7HS	4122	Q211	BR7HIX	7067
103-Vogue LE, SE, VSE	50	1	-	0,7	BP5HS	4111	-	-	-
Blaster RS12	50	1	2006-	0,6	BR7HS	4122	Q211	BR7HIX	7067
Buxy	50	1	1995-1997	0,6	BR7HS	4122	Q211	BR7HIX	7067
Elyséo	50	1	1999-	0,6	BR7HS	4122	Q211	BR7HIX	7067
Elystar Advantage	50	1	-	0,7	BR7HS	4122	Q211	BR7HIX	7067
Elystar TSDI	50	1	-2005	0,6	CPR8E	7411	-	-	-
Elystar TSDI	50	1	2006-	0,6	CR7EKA	1462	-	-	-
Fox Concept	50	1	-	0,7	BR7HS	4122	Q211	BR7HIX	7067
Fox L / LM / SPX M	50	1	-	0,7	B7HS	5110	Q204	BR7HIX	7067
Fox M / MPH / M Pro / LM Pro	50	1	-	0,7	BR7HS	4122	Q211	BR7HIX	7067
Jet C-Tech Carbu	50	1	2010-	0,6	CR7EB	4663	-	CR7EIX	7385
Jet Force	50	1	-2005	0,6	CPR8E	7411	-	-	-
Jet Force - 14x12,7mm	50	1	-	0,7	BR7HS	4122	Q211	BR7HIX	7067
Jet Force C-Tech	50	1	2005-	0,6	CR7EB	4663	-	CR7EIX	7385
Jet Force H2i	50	1	2011-	0,7	CR7EKA	1462	-	-	-
Jet Force TSDI	50	1	2003-	0,6	CR7EKA	1462	-	-	-
Kisbee Carbu	50	1	2010-	0,7	CR7HSA	4549	-	CR7HIX	7544
Looxor	50	1	2001-2002	0,6	BR7HS	4122	Q211	BR7HIX	7067
Looxor TSDI Injection 2 Stroke	50	1	2002-2006	0,6	CR7EKA	1462	-	-	-
Ludix 14 EP	50	1	2004-	0,6	BR7HS	4122	Q211	BR7HIX	7067
Ludix 14 Pro	50	1	2004-	0,6	BR7HS	4122	Q211	BR7HIX	7067
Ludix 2-50	50	1	2004-	0,6	BR7HS	4122	Q211	BR7HIX	7067
Ludix Blaster	50	1	2004-	0,7	BR7HS	4122	Q211	BR7HIX	7067
Ludix Blaster Furious	50	1	2011-	0,8	CR7EKB	4455	-	CR7EIX	7385
Ludix Blaster ref. Liquid	50	1	2007-	0,7	CR7E	4578	Q225	CR7EIX	7385
Ludix Blaster RS12 LC-12	50	1	2004-	0,6	BR7HS	4122	Q211	BR7HIX	7067
Ludix Classic	50	1	2004-	0,7	BR7HS	4122	Q211	BR7HIX	7067
Ludix Elegance	50	1	2004-	0,7	BR7HS	4122	Q211	BR7HIX	7067
Ludix One	50	1	2004-	0,7	BR7HS	4122	Q211	BR7HIX	7067
Ludix Snake	50	1	2004-	0,7	BR7HS	4122	Q211	BR7HIX	7067
Ludix Trend	50	1	2004-	0,7	BR7HS	4122	Q211	BR7HIX	7067
Ludix Urban Track	50	1	2004-	0,6	BR7HS	4122	Q211	BR7HIX	7067
Metal-X	50		2002-	0,6	BR7HS	4122	Q211	BR7HIX	7067
NK7	50	1	2010-	0,6	BR9ES	5722	Q208	BR9EIX	3981

* Bitte Elektrodenabstand nach Angaben des Herstellers justieren

* Please adjust the groundelectrode gap

* Veuillez vérifier L' écartement

* Por favor, ajustar distancia entre electrodos

* regolare il gap

C
y
l

Stock-№

Quick-№



Stock-№ IX

PEUGEOT MOTORCYCLES

Rapido	50	1	-	0,6	BP6HS	4511	-	BPR6HIX	4085
Rapido 2	50	1	-	0,6	BR6HSA	4296	Q210	BR6HIX	3419
Rapido 3 50	50	1	-	0,6	BR6HSA	4296	Q210	BR6HIX	3419
RC X-Race	50	1	2000-	0,6	BR7HS	4122	Q211	BR7HIX	7067
SC-L	50	1	-	0,5	B6HS	4510	Q203	BR6HIX	3419
Speedake	50	1	-	0,7	BR7HS	4122	Q211	BR7HIX	7067
Speedfight	50	1	-	0,6	BR8HS	4322	Q212	BR8HIX	7001
Speedfight 2 AC	50	1	2000-	0,6	BR7HS	4122	Q211	BR7HIX	7067
Speedfight 2 AC Iron	50	1	-	0,7	BR7HS	4122	Q211	BR7HIX	7067
Speedfight 2 AC Motorsport	50	1	-	0,7	BR7HS	4122	Q211	BR7HIX	7067
Speedfight 2 LC	50	1	2000-	0,6	BR7HS	4122	Q211	BR7HIX	7067
Speedfight 2 LC Motorsport	50	1	-	0,7	BR7HS	4122	Q211	BR7HIX	7067
Speedfight 2 LC Victories	50	1	-	0,7	BR7HS	4122	Q211	BR7HIX	7067
Speedfight 2 WRC	50	1	2000-	0,6	BR7HS	4122	Q211	BR7HIX	7067
Speedfight 2 X-Race	50	1	2000-	0,6	BR7HS	4122	Q211	BR7HIX	7067
Speedfight 3 2 Stroke	50	1	2012-	0,7	BR7HS	4122	Q211	BR7HIX	7067
Speedfight 3 2T/RS ref.air 45kmh	50	1	2009-	0,6	BR7HS	4122	Q211	BR7HIX	7067
Speedfight 3 4 Stroke	50	1	2012-	0,7	CR7EKA	1462	-	-	-
Speedfight 3 AC 25kmh	50	1	2009-	0,7	BPR5HS	6222	-	-	-
Speedfight 3 LC 45kmh	50	1	2009-	0,6	CR7EB	4663	-	CR7EIX	7385
Speedfight 3 Le Mans	50	1	2011-	0,7	BR7HS	4122	Q211	BR7HIX	7067
Speedfight 3 Team Peugeot	50	1	2011-	0,7	BR7HS	4122	Q211	BR7HIX	7067
Speedfight AC	50	1	1998-	0,7	BR7HS	4122	Q211	BR7HIX	7067
Speedfight LC	50	1	1996-2000	0,6	BR7HS	4122	Q211	BR7HIX	7067
Speedfight LCD	50	1	1996-2000	0,6	BR7HS	4122	Q211	BR7HIX	7067
Speedfight LCDP	50	1	1996-2000	0,6	BR7HS	4122	Q211	BR7HIX	7067
Speedfight LCT	50	1	1996-2000	0,6	BR7HS	4122	Q211	BR7HIX	7067
Speedfight M	50	1	1996-2000	0,6	BR7HS	4122	Q211	BR7HIX	7067
Speedfight MP	50	1	1996-2000	0,6	BR7HS	4122	Q211	BR7HIX	7067
Speedfight Prost serie	50	1	1996-2000	0,6	BR7HS	4122	Q211	BR7HIX	7067
Speedfight X' Team	50	1	1999-2000	0,6	BR7HS	4122	Q211	BR7HIX	7067
Squab	50	1	-	0,7	BR7HS	4122	Q211	BR7HIX	7067
ST-L2, L3	50	1	-	0,6	BR6HSA	4296	Q210	BR6HIX	3419
SV	50	1	-1995	0,6	B8HS	5510	Q205	BR8HIX	7001
SV	50	1	1996-	0,6	BR8HS	4322	Q212	BR8HIX	7001
SV-Geo	50	1	-	0,6	B8HS	5510	Q205	BR8HIX	7001
SV-Junior	50	1	-	0,6	B8HS	5510	Q205	BR8HIX	7001
SV-M	50	1	-	0,6	B8HS	5510	Q205	BR8HIX	7001
SX-Pro	50	1	-	0,5	BPR6HS	7022	Q214	BPR6HIX	4085
TKR 50	50	1	2003-	0,6	BR7HS	4122	Q211	BR7HIX	7067
TKR 50 307 WRC	50	1	2005-	0,6	BR7HS	4122	Q211	BR7HIX	7067
TKR Furious AC	50	1	-	0,6	BR7HS	4122	Q211	BR7HIX	7067
TKR Streetboard	50	1	-	0,6	BR7HS	4122	Q211	BR7HIX	7067
TKR Victories	50	1	-	0,6	BR7HS	4122	Q211	BR7HIX	7067
Trekker	50	1	-	0,6	BR8HS	4322	Q212	BR8HIX	7001
Trekker Black 2	50	1	2000-	0,7	BR7HS	4122	Q211	BR7HIX	7067
Trekker Métal-X	50	1	2000-	0,7	BR7HS	4122	Q211	BR7HIX	7067
Trekker Off Road	50	1	1997-	0,7	BR7HS	4122	Q211	BR7HIX	7067
Trekker Road	50	1	1997-	0,7	BR7HS	4122	Q211	BR7HIX	7067
Trekker Streetboard	50	1	1999-	0,7	BR7HS	4122	Q211	BR7HIX	7067
Trekker Tuning	50	1	2000-	0,7	BR7HS	4122	Q211	BR7HIX	7067

* Bitte Elektrodenabstand nach Angaben des Herstellers justieren

* Please adjust the groundelectrode gap

* Veuillez vérifier L' écartement

* Por favor, ajustar distancia entre electrodos

* regolare il gap

C
Y
L

Stock-No

Quick-No



Stock-No IX

PEUGEOT MOTORCYCLES

Trekker Urban Black	50	1	1999-	0,7	BR7HS	4122	Q211	BR7HIX	7067
Tweet 4 Stroke	50	1	2010-	0,7	CR6HSA	2983	-	CR6HIX	7274
V-Clic / Silversport	50	1	2007-	0,6	CR7HSA	4549	-	CR7HIX	7544
Vivacity	50	1	1999-	0,6	BR7HS	4122	Q211	BR7HIX	7067
Vivacity 2 Stroke	50	1	2010-	0,7	BR7HS	4122	Q211	BR7HIX	7067
Vivacity 3 Sixties	50		2011-	0,7	CR6HSA	2983	-	CR6HIX	7274
Vivacity 4 Stroke	50	1	2010-	0,7	CR7EKA	1462	-	-	-
Vivacity Compact	50	1	1999-	0,7	BR7HS	4122	Q211	BR7HIX	7067
Vivacity Silversport	50	1	1999-	0,7	BR7HS	4122	Q211	BR7HIX	7067
Vivacity Sportline	50	1	1999-	0,6	BR7HS	4122	Q211	BR7HIX	7067
VS-R	50	1	2000-	0,6	BR7HS	4122	Q211	BR7HIX	7067
XP6-Trail, Supermotard	50	1	1998-	0,6	BR9ES	5722	Q208	BR9EIX	3981
XPS 50 Enduro, Trail, Supermotard 50	50		2003-	0,7	BR9ES	5722	Q208	BR9EIX	3981
XR6-Multivitesses	50	1	2001-	0,6	BR9ES	5722	Q208	BR9EIX	3981
XR7	50	1	2010-	0,6	BR9ES	5722	Q208	BR9EIX	3981
X-Race	50	1	2000-	0,6	BR7HS	4122	Q211	BR7HIX	7067
Zenith LM2	50	1	1996-	0,5	BR8HS	4322	Q212	BR8HIX	7001
Zenith, N, LN, LS	50	1	-1999	0,7	BR7HS	4122	Q211	BR7HIX	7067
SV	80	1	-	0,6	B8HS	5510	Q205	BR8HIX	7001
SX-PRO	80	1	-	0,5	BPR6HS	7022	Q214	BPR6HIX	4085
Elyséo	100	1	1999-	0,7	BR8ES	5422	Q207	BR8EIX	5044
Metal X	100		2002-	0,6	BR8ES	5422	Q207	BR8EIX	5044
M-Looxor	100	1	2001-	0,7	BR8ES	5422	Q207	BR8EIX	5044
M-VivaCity	100	1	1999-	0,7	BR8ES	5422	Q207	BR8EIX	5044
Speedfight & Prost GP	100	1	1997-1999	0,7	BR8ES	5422	Q207	BR8EIX	5044
Speedfight 2	100	1	2000-	0,7	BR8ES	5422	Q207	BR8EIX	5044
Speedfight 2 Victories	100	1	2006-	0,6	BR8ES	5422	Q207	BR8EIX	5044
Speedfight WRC 206 (Refr. Air)	100		2001-	0,6	BR8ES	5422	Q207	BR8EIX	5044
SV	100	1	1997-	0,7	BR8ES	5422	Q207	BR8EIX	5044
SV-L	100	1	-	0,7	BR8ES	5422	Q207	BR8EIX	5044
TKR 100	100	1	2000-	0,6	BR8ES	5422	Q207	BR8EIX	5044
Trekker	100	1	1997-	0,7	BR8ES	5422	Q207	BR8EIX	5044
Atlantis	125	1	2006-	0,7	CR9EB	6955	-	CR9EIX	3521
Black Sat Compresseur	125	1	2008-	0,7	CR9EB	6955	-	CR9EIX	3521
Citystar	125	1	2011-	0,7	CR8EB	7784	-	CR8EIX	4218
Elyséo	125	1	1999-	0,7	CR7E	4578	Q225	CR7EIX	7385
Elyseo Advantage	125	1	2004-	0,7	CR7E	4578	Q225	CR7EIX	7385
Elystar	125	1	2002-	0,7	CR7EB	4663	-	CR7EIX	7385
Elystar Advantage	125	1	2004-	0,7	CR7EB	4663	-	CR7EIX	7385
F-Looxor	125	1	2002-	0,7	CR7EB	4663	-	CR7EIX	7385
Géopolis	125	1	2006-	0,7	CR9EB	6955	-	CR9EIX	3521
Géopolis RS	125	1	2008-	0,7	CR8EB	7784	-	CR8EIX	4218
Jet Force	125	1	2003-	0,7	CR7EB	4663	-	CR7EIX	7385
Jet Force Compressor	125	1	2005-	0,7	CR8EK	3478	-	CR8EIX	4218
Jet Force Compressor K	125	1	2005-	0,7	CR8EKB	4374	-	CR8EIX	4218
Liberty	125	1	2003-	0,7	CR7EB	4663	-	CR7EIX	7385
Ludix 125	125	1	2004-	0,6	CR9EB	6955	-	CR9EIX	3521
LXR	125	1	2009-	0,7	CR7E	4578	Q225	CR7EIX	7385
Satelis	125	1	2003-2008	0,7	CR9EB	6955	-	CR9EIX	3521
Satelis	125	1	2012-	0,7	CR8EB	7784	-	CR8EIX	4218
Satelis Blacksat	125	1	2012-	0,7	CR9EB	6955	-	CR9EIX	3521
Satelis Compressor	125	1	2006-	0,6	CR9EB	6955	-	CR9EIX	3521

* Bitte Elektrodenabstand nach Angaben des Herstellers justieren

* Please adjust the groundelectrode gap

* Veuillez vérifier L' écartement

* Por favor, ajustar distancia entre electrodos

* regolare il gap

C
y
l

0201



Stock-№

Quick-№



Stock-№ IX

PEUGEOT MOTOCYCLES

Satelis Compressor	125	1	2012-	0,7	CR8EB	7784	-	CR8EIX	4218
Satelis Executive	125	1	2006-	0,6	CR9EB	6955	-	CR9EIX	3521
Satelis GT Sport	125	1	2012-	0,7	CR8EB	7784	-	CR8EIX	4218
Satelis Roland Garros	125	1	2012-	0,7	CR8EB	7784	-	CR8EIX	4218
Satelis RS	125	1	2012-	0,7	CR8EB	7784	-	CR8EIX	4218
Satelis Withesat	125	1	2012-	0,7	CR8EB	7784	-	CR8EIX	4218
Sum UP	125	1	2010-	0,7	CR7HSA	4549	-	CR7HIX	7544
Sum-Up	125	1	2007-	0,7	CR7HSA	4549	-	CR7HIX	7544
Tweet	125	1	2010-	0,7	CR7HSA	4549	-	CR7HIX	7544
Tweet RS	125	1	2012-	0,8	CR7HSA	4549	-	CR7HIX	7544
Vivacity	125	1	2010-	0,7	CR7HSA	4549	-	CR7HIX	7544
Vivacity Roland-Garros	125	1	2012-	0,8	CR7HSA	4549	-	CR7HIX	7544
Vivacity Sixties	125	1	2012-	0,8	CR7HSA	4549	-	CR7HIX	7544
WTR	125	1	2007-	0,7	CR9EB	6955	-	CR9EIX	3521
XPS-CT	125		2006-2008	0,7	CR7HSA	4549	-	CR7HIX	7544
Elyséo	150	1	2001-	0,7	CR7E	4578	Q225	CR7EIX	7385
Elystar	150	1	2003-	0,7	CR7EB	4663	-	CR7EIX	7385
Looxor	150	1	2003-	0,7	CR7EB	4663	-	CR7EIX	7385
Tweet	150	1	2010-	0,7	CR7HSA	4549	-	CR7HIX	7544
LXR	200	1	2009-	0,7	CR7E	4578	Q225	CR7EIX	7385
Elystar Injection	250	1	2006-	0,7	PMR8B	6378	-	-	-
Geo RS 250	250	1	2008-	0,7	PMR8B	6378	-	-	-
Géopolis	250	1	2008-	0,7	PMR8B	6378	-	-	-
Géopolis Executive	250		2007-	0,6	CR9EB	6955	-	CR9EIX	3521
Satelis	250	1	2006-	0,7	PMR8B	6378	-	-	-
Satelis RS	250	1	2008-	0,7	PMR8B	6378	-	-	-
SV	250	1	2001-	0,9	DPR7EA-9	5129	Q220	DPR7EIX-9	7803
Géopolis	300	1	2010-	0,8	CR7EKB	4455	-	CR7EIX	7385
Géopolis RS	300	1	2012-	0,8	CR7EKB	4455	-	CR7EIX	7385
Géopolis	400	1	2007-	0,8	CR7EKB	4455	-	CR7EIX	7385
Géopolis RS	400	1	2007-	0,7	CR7EKB	4455	-	CR7EIX	7385
Metropolis 400i	400	1	2013-	0,9	CPR8EB-9	6607	-	-	-
Metropolis 400i RS	400	1	2013-	0,9	CPR8EB-9	6607	-	-	-
Satelis	400	1	2007-	0,7	CR7EKB	4455	-	CR7EIX	7385
Satelis Premium RS	400	1	2011-	0,8	CR7EKB	4455	-	CR7EIX	7385
Satelis RS	400	1	2007-	0,7	CR7EKB	4455	-	CR7EIX	7385
Géopolis	500	1	2007-	0,7	CR7EKB	4455	-	CR7EIX	7385
Satelis	500	1	2007-	0,7	CR7EKB	4455	-	CR7EIX	7385
Satelis RS	500	1	2012-	0,8	CR7EKB	4455	-	CR7EIX	7385

PIAGGIO

Free 25 Mofa	25	1	-	0,5	BP8ES	2912	-	BPR8EIX	6684
Zip 25 Mofa	25	1	-	0,5	BPR8ES	3923	Q213	BPR8EIX	6684
Zip Base 25	25	1	-	0,5	BPR8ES	3923	Q213	BPR8EIX	6684
50 R, Special	50	1	-	0,5	B6HS	4510	Q203	BR6HIX	3419
50 S	50	1	-	0,5	B6HS	4510	Q203	BR6HIX	3419
Ape 50	50	1	-	0,5	B6HS	4510	Q203	BR6HIX	3419
Boss	50	1	-	0,5	B6HS	4510	Q203	BR6HIX	3419
Bravo - Si / Moped	50	1	-	0,5	B5HS	4210	-	-	-
Bravo P	50	1	-	0,7	BR6HS	3922	Q209	BR6HIX	3419
Bravo PV	50	1	-	0,7	BR6HS	3922	Q209	BR6HIX	3419

* Bitte Elektrodenabstand nach Angaben des Herstellers justieren

* Please adjust the groundelectrode gap

* Veuillez vérifier L' écartement

* Por favor, ajustar distancia entre electrodos

* regolare il gap

C
Y
L

0201



Stock-No

Quick-No



Stock-No LX

PIAGGIO

Bravo PVRI	50	1	-	0,5	B8HS	5510	Q205	BR8HIX	7001
Ciao - Bravo SI / Mofa	50	1	-	0,5	B5HS	4210	-	-	-
Ciao M Kat	50	1	-	0,7	BR6HS	3922	Q209	BR6HIX	3419
Ciao V Kat	50	1	-	0,7	BR6HS	3922	Q209	BR6HIX	3419
Diesis 50	50	1	-	0,7	BR9ES	5722	Q208	BR9EIX	3981
Eaglet	50	1	-	0,5	B9ES	2611	Q202	BR9EIX	3981
ET2 - Carbu	50	1	-	0,5	B9ES	2611	Q202	BR9EIX	3981
ET2i	50	1	1998-	0,6	-	-	-	DCPR9EIX	2316
ET4	50	1	-	0,7	CR9EB	6955	-	CR9EIX	3521
Fly 2 Stroke	50	1	-	0,6	BR9ES	5722	Q208	BR9EIX	3981
Fly 4 Stroke	50	1	2006-	0,7	PMR7A	4259	-	-	-
Free	50	1	1993-	0,5	B9ES	2611	Q202	BR9EIX	3981
Free Business 50	50	1	1996-	0,5	B9ES	2611	Q202	BR9EIX	3981
Grillo / Mofa	50	1	-	0,5	B5HS	4210	-	-	-
Liberty 2 Stroke	50	1	1997-	0,7	BR9ES	5722	Q208	BR9EIX	3981
Liberty 4 Stroke	50	1	2002-2005	0,7	CR9EB	6955	-	CR9EIX	3521
Liberty 4 Stroke	50	1	2006-	0,7	PMR7A	4259	-	-	-
Liberty Kat	50	1	-	0,7	BR9ES	5722	Q208	BR9EIX	3981
LX 2 Stroke	50	1	-	0,6	BR9ES	5722	Q208	BR9EIX	3981
LX 4 Stroke	50	1	2006-	0,8	CR8EB	7784	-	CR8EIX	4218
NRG	50	1	-	0,5	B9ES	2611	Q202	BR9EIX	3981
NRG-Extreme	50	1	-	0,5	B9ES	2611	Q202	BR9EIX	3981
NRG-Extreme Kat	50	1	-	0,5	B9ES	2611	Q202	BR9EIX	3981
NRG-H20 Kat	50	1	-	0,5	B9ES	2611	Q202	BR9EIX	3981
NRG-MC2	50	1	-2000	0,5	B9ES	2611	Q202	BR9EIX	3981
NRG-MC2	50	1	1996-	0,6	B9EG	3530	-	-	-
NRG-MC2 DD	50	1	-	0,5	B9ES	2611	Q202	BR9EIX	3981
NRG-MC2 DT	50	1	-	0,5	B9ES	2611	Q202	BR9EIX	3981
NRG-MC3	50	1	2001-	0,5	B9ES	2611	Q202	BR9EIX	3981
NRG-MC3	50	1	2002-2005	0,6	CPR8E	7411	-	-	-
NRG-MC3	50	1	2006-	0,6	ZMR7AP	6914	-	-	-
NRG-MC3 Pure Jet	50	1	2002-	0,6	CPR8E	7411	-	-	-
NRG-Power 50 DD	50	1	-	*	BR9ES	5722	Q208	BR9EIX	3981
NRG-Power DT Purejet	50	1	2005-	0,6	CPR8E	7411	-	-	-
NSP-4 Stroke Aria	50	1	2002-	0,8	CR9EB	6955	-	CR9EIX	3521
NTT	50	1	1995-	0,5	B9ES	2611	Q202	BR9EIX	3981
PK-S Auto	50	1	-	0,5	BR7ES	5122	-	BR7EIX	6664
PK-SS	50	1	-	0,5	B7HS	5110	Q204	BR7HIX	7067
PK-XL2	50	1	-	0,5	B7HS	5110	Q204	BR7HIX	7067
PK-XL2 Auto	50	1	-	0,5	B8ES	2411	Q201	BR8EIX	5044
Plurimatic	50	1	-	0,5	B6HS	4510	Q203	BR6HIX	3419
PX	50	1	-	0,5	B6HS	4510	Q203	BR6HIX	3419
Quartz	50	1	1992-	0,5	B9ES	2611	Q202	BR9EIX	3981
Rush	50	1	-	0,6	BR7HS	4122	Q211	BR7HIX	7067
Sfera	50	1	1991-	0,5	B9ES	2611	Q202	BR9EIX	3981
Sfera 50 Automatic	50	1	1991-	0,5	B9ES	2611	Q202	BR9EIX	3981
Sfera 50 FL, RL, RST	50	1	-	0,5	B9ES	2611	Q202	BR9EIX	3981
Skipper	50	1	-	0,5	B9ES	2611	Q202	BR9EIX	3981
Storm Autom.	50	1	1994-	0,5	B9ES	2611	Q202	BR9EIX	3981
Super Bravo / Mofa	50	1	-	0,5	B5HS	4210	-	-	-
Super Bravo 2 Gang / Mofa	50	1	-	0,5	B5HS	4210	-	-	-

* Bitte Elektrodenabstand nach Angaben des Herstellers justieren

* Please adjust the groundelectrode gap

* Veuillez vérifier L' écartement

* Por favor, ajustar distancia entre electrodos

* regolare il gap

C
y
I

0201



Stock-No

Quick-No



Stock-No IX

PIAGGIO

TPH	50	1	1993-	0,5	B9ES	2611	Q202	BR9EIX	3981
Typhoon	50	1	2011-	0,7	CR7EB	4663	-	CR7EIX	7385
Typhoon air / X 50	50	1	1996-	0,7	BR9ES	5722	Q208	BR9EIX	3981
Typhoon X	50	1	1993-	0,5	B9ES	2611	Q202	BR9EIX	3981
Typhoon XR	50	1	1993-	0,5	B9ES	2611	Q202	BR9EIX	3981
Velofax	50	1	1995-	0,5	B8ES	2411	Q201	BR8EIX	5044
Velofax / Mofa	50	1	-	0,6	BP8ES	2912	-	BPR8EIX	6684
Velofax AE	50	1	1995-	0,5	B8ES	2411	Q201	BR8EIX	5044
Velofax L	50	1	-	0,5	B9ES	2611	Q202	BR9EIX	3981
Velofax M	50	1	-	0,5	B9ES	2611	Q202	BR9EIX	3981
Velofax S	50	1	-	0,5	B9ES	2611	Q202	BR9EIX	3981
Vespa 4 speed	50	1	-	0,5	B8HS	5510	Q205	BR8HIX	7001
Vespa A	50	1	-	0,5	B7ES	1111	-	BR7EIX	6664
Vespa Delta / Puch Condor	50	1	-	0,5	B7HS	5110	Q204	BR7HIX	7067
Vespa Elestart	50	1	-	0,5	B6HS	4510	Q203	BR6HIX	3419
Vespa ET 3 Primavera	50	1	-	0,6	BR7HS	4122	Q211	BR7HIX	7067
Vespa ET 4	50	1	2002-2005	0,8	CR9EB	6955	-	CR9EIX	3521
Vespa ET 4	50	1	2006-	0,7	PMR7A	4259	-	-	-
Vespa HP 4M	50	1	-	0,5	B6HS	4510	Q203	BR6HIX	3419
Vespa HP 4M	50	1	1993-	0,5	B7HS	5110	Q204	BR7HIX	7067
Vespa LX 2 Stroke	50	1	2006-	0,6	BR9ES	5722	Q208	BR9EIX	3981
Vespa LX 50 4 Stroke 4V	50	1	2010-	0,6	ER9EH-6N	1673	-	ER9EHIX	96652
Vespa LXV 50	50	1	-	0,6	BR9ES	5722	Q208	BR9EIX	3981
Vespa R	50	1	-	0,5	B6HS	4510	Q203	BR6HIX	3419
Vespa S	50	1	-	0,5	B6HS	4510	Q203	BR6HIX	3419
Vespa S	50	1	2008-	0,6	BR9ES	5722	Q208	BR9EIX	3981
Vespa S 50 4 Stroke	50	1	2009-	0,6	ER9EH-6N	1673	-	ER9EHIX	96652
Vespa Special	50	1	-	0,5	B6HS	4510	Q203	BR6HIX	3419
Vespa Vale Spécial, Standard	50	1	-	0,5	B5HS	4210	-	-	-
Vespino AL/ALX/GL/GN/GS/NL	50	1	-	0,5	B7HS	5110	Q204	BR7HIX	7067
Vespino NX/SC/T/TL/TN/TS	50	1	-	0,5	B7HS	5110	Q204	BR7HIX	7067
Vespino TX/XE	50	1	-	0,5	B7HS	5110	Q204	BR7HIX	7067
ZIP	50	1	1992-	0,6	B9ES	2611	Q202	BR9EIX	3981
ZIP-& Zip (Hybrid)	50	1	1994-	0,5	B9ES	2611	Q202	BR9EIX	3981
ZIP-& Zip 50	50	1	1994-	0,6	B9ES	2611	Q202	BR9EIX	3981
ZIP-4 Stroke	50	1	2006-	0,7	PMR7A	4259	-	-	-
ZIP-4 Stroke Aria	50	1	2002-	0,7	CR9EB	6955	-	CR9EIX	3521
ZIP-Air	50	1	1996-	0,7	BR9ES	5722	Q208	BR9EIX	3981
ZIP-Base 50	50	1	-	0,5	B9ES	2611	Q202	BR9EIX	3981
ZIP-Eau	50	1	1996-	0,7	B10ES	7928	-	BR10EIX	6801
ZIP-Fast Rider	50	1	1992-1999	0,5	B9ES	2611	Q202	BR9EIX	3981
ZIP-Kat	50	1	-	0,5	BPR8ES	3923	Q213	BPR8EIX	6684
ZIP-RST / F. R. RST	50	1	-1999	0,5	B9ES	2611	Q202	BR9EIX	3981
ZIP-SP	50	1	1996-	0,6	B9ES	2611	Q202	BR9EIX	3981
PK-Vespa S Primavera, T3 Prima.	75	1	-	0,5	B7HS	5110	Q204	BR7HIX	7067
PK-Vespa S/Elestart/Junior	75	1	-	0,5	B7HS	5110	Q204	BR7HIX	7067
PK-Vespa XL/ Elestart	75	1	-	0,6	B8ES	2411	Q201	BR8EIX	5044
PK-Vespa XL/ Elestart	75	1	-	0,6	B9ES	2611	Q202	BR9EIX	3981
SKR-City	75	1	-	0,6	BR9ES	5722	Q208	BR9EIX	3981

* Bitte Elektrodenabstand nach Angaben des Herstellers justieren

* Please adjust the groundelectrode gap

* Veuillez vérifier L' écartement

* Por favor, ajustar distancia entre electrodos

* regolare il gap

C
Y
L

0201



Stock-No

Quick-No



Stock-No LX

PIAGGIO

PX-E, E Lusso, X	80	1	-	0,5	B6ES	7310	-	-	-
Sfera	80	1	-	0,5	B9ES	2611	Q202	BR9EIX	3981
Sfera Automatique	80	1	-	0,5	B9ES	2611	Q202	BR9EIX	3981
Sfera RST	80	1	-	0,5	B9ES	2611	Q202	BR9EIX	3981
Skipper	80	1	-	0,5	B9ES	2611	Q202	BR9EIX	3981
Typhoon	80	1	1994-	0,5	B9ES	2611	Q202	BR9EIX	3981
Diesis	100	1	2001-	0,6	CR8EB	7784	-	CR8EIX	4218
Diesis	100		2003-	0,6	BR9ES	5722	Q208	BR9EIX	3981
Fly	100	1	2006-	0,7	CR9EB	6955	-	CR9EIX	3521
Free	100	1	2002-	0,6	CR8EB	7784	-	CR8EIX	4218
Zip 4 Stroke	100	1	2006-2008	0,7	CR9EB	6955	-	CR9EIX	3521
Ape	125	1	-	0,5	B7HS	5110	Q204	BR7HIX	7067
Beverly / Beverly Tourer	125	1	2002-	0,8	CR8EB	7784	-	CR8EIX	4218
Beverly Light, GT	125	1	2002-	0,8	CR8EB	7784	-	CR8EIX	4218
Carnaby	125	1	2007-	0,8	CR8EB	7784	-	CR8EIX	4218
Cosa 125 MA AE	125	1	1988-	0,6	B9ES	2611	Q202	BR9EIX	3981
Cosa 200 FL EBC 12PS	125	1	-	0,5	B8ES	2411	Q201	BR8EIX	5044
Cosa FL 125	125	1	1991-	0,5	B9ES	2611	Q202	BR9EIX	3981
ET 3	125	1	-	0,6	BR7HS	4122	Q211	BR7HIX	7067
ET 4 Automatic	125	1	-	0,8	CR7EB	4663	-	CR7EIX	7385
Fly	125	1	2005-	0,8	CR7EB	4663	-	CR7EIX	7385
Fly E3	125	1	-	0,6	CR7EKB	4455	-	CR7EIX	7385
GTS Super	125	1	2007-	0,8	CR8EB	7784	-	CR8EIX	4218
Hexagon	125	1	-1997	0,5	B9ES	2611	Q202	BR9EIX	3981
Hexagon LX	125	1	1994-	0,5	B9ES	2611	Q202	BR9EIX	3981
Hexagon LX 4T / 4V H2O LC	125	1	-	0,6	CR8EB	7784	-	CR8EIX	4218
Hexagon LX 4T 2V AC	125	1	-	0,8	CR7EB	4663	-	CR7EIX	7385
L-Granturismo	125	1	2004-	0,7	CR9EB	6955	-	CR9EIX	3521
Liberty	125	1	1998-2000	0,6	CR7E	4578	Q225	CR7EIX	7385
Liberty	125	1	2002-	0,8	CR7EB	4663	-	CR7EIX	7385
Liberty E3	125	1	-	0,6	CR7EKB	4455	-	CR7EIX	7385
Liberty Leader	125	1	2001-	0,7	CR9EB	6955	-	CR9EIX	3521
Liberty S E3	125	1	-	0,6	CR7EKB	4455	-	CR7EIX	7385
LX2	125	1	1997-	0,5	B9ES	2611	Q202	BR9EIX	3981
LX4	125	1	1998-2000	0,6	CR7E	4578	Q225	CR7EIX	7385
LX-Super LX	125	1	2000-	0,7	CR9EB	6955	-	CR9EIX	3521
MP3	125	1	2006-	0,6	CR8EB	7784	-	CR8EIX	4218
MP3 Hys	125	1	2008-	0,8	CR8EB	7784	-	CR8EIX	4218
MP3 ie	125	1	2006-	0,6	CR8EB	7784	-	CR8EIX	4218
MP3 LT ie Hybrid	125	1	2009-	*	CR8EB	7784	-	CR8EIX	4218
MP3 RL	125	1	-	0,8	CR8EB	7784	-	CR8EIX	4218
Runner	125	1	2002-	0,6	CR8EB	7784	-	CR8EIX	4218
Sfera	125	1	1995-	0,6	CR9E	6263	Q227	CR9EIX	3521
Sfera RL 4 Stroke	125	1	-	0,6	CR9E	6263	Q227	CR9EIX	3521
Sfera RST 4 Stroke	125	1	1995-	0,6	CR7E	4578	Q225	CR7EIX	7385
Skipper 4 Stroke	125	1	2000-	0,8	CR7EB	4663	-	CR7EIX	7385
Skipper, LX	125	1	1993-	0,5	B9ES	2611	Q202	BR9EIX	3981
Skr 125	125	1	1993-	0,5	B9ES	2611	Q202	BR9EIX	3981
Sphera 4 Stroke	125	1	1995-1999	0,6	CR9E	6263	Q227	CR9EIX	3521
Sphera 4 Stroke Air	125	1	2000-	0,6	CR8EB	7784	-	CR8EIX	4218
ST-Skipper Leader	125	1	2000-	0,7	CR9EB	6955	-	CR9EIX	3521
Super Hexagon GTX 4 Stroke	125	1	2001-	0,6	CR8EB	7784	-	CR8EIX	4218

* Bitte Elektrodenabstand nach Angaben des Herstellers justieren

* Please adjust the groundelectrode gap

* Veuillez vérifier L' écartement

* Por favor, ajustar distancia entre electrodos

* regolare il gap

C
y
I

0201



Stock-№

Quick-№



Stock-№ IX

PIAGGIO

TPH	125	1	1995-	0,5	B9ES	2611	Q202	BR9EIX	3981
Typhoon 4 Stroke	125	1	2010-	0,8	CR7EB	4663	-	CR7EIX	7385
Vespa CL/ LS/ NK Primavera/T3	125	1	-	0,5	B6HS	4510	Q203	BR6HIX	3419
Vespa ET 4	125	1	1996-	0,7	CR8EB	7784	-	CR8EIX	4218
Vespa ET 4	125	1	1999-	0,8	CR7EB	4663	-	CR7EIX	7385
Vespa FL2	125	1	1990-	0,6	B7HS	5110	Q204	BR7HIX	7067
Vespa Gandturismo	125	1	-2004	0,6	CR9EB	6955	-	CR9EIX	3521
Vespa GT	125	1	2003-	0,6	CR8EB	7784	-	CR8EIX	4218
Vespa GTS 125	125	1	2007-	0,7	CR8EKB	4374	-	CR8EIX	4218
Vespa GTS Super 125 i.e.	125	1	2010-	0,7	CR8EKB	4374	-	CR8EIX	4218
Vespa GTV 125	125	1	-	0,6	CR8EB	7784	-	CR8EIX	4218
Vespa Leader ET 4	125	1	2000-	0,7	CR9EB	6955	-	CR9EIX	3521
Vespa LX	125	1	2005-	0,7	CR7EB	4663	-	CR7EIX	7385
Vespa LX 125 i.e.	125	1	2009-	0,7	CR8EB	7784	-	CR8EIX	4218
Vespa LXV 125	125	1	-	0,8	CR7EB	4663	-	CR7EIX	7385
Vespa PK 125	125	1	1985-	0,6	BR7HS	4122	Q211	BR7HIX	7067
Vespa PK S Elestart	125	1	-	0,5	B6HS	4510	Q203	BR6HIX	3419
Vespa PK XL Elestart	125	1	-	0,6	B7ES	1111	-	BR7EIX	6664
Vespa PX	125	1	2008-	0,7	BR7HS	4122	Q211	BR7HIX	7067
Vespa PX E, E Iris	125	1	-	0,6	B6HS	4510	Q203	BR6HIX	3419
Vespa PX MA AE	125	1	1986-	0,5	B6HS	4510	Q203	BR6HIX	3419
Vespa S	125	1	2008-	0,8	CR7EB	4663	-	CR7EIX	7385
Vespa S i.e.	125	1	2008-	0,8	CR7EB	4663	-	CR7EIX	7385
Vespa Special ET3 Primavera	125	1	-	0,6	B7HS	5110	Q204	BR7HIX	7067
Vespa Special ET4 Carbu	125	1	-	0,6	CR8EB	7784	-	CR8EIX	4218
Vespa T3 Li / T3	125	1	-	0,5	B6HS	4510	Q203	BR6HIX	3419
Vespa T5	125	1	-	0,5	B9ES	2611	Q202	BR9EIX	3981
Vespa T5 Sport Elestart	125	1	-	0,6	B9ES	2611	Q202	BR9EIX	3981
Vespa XL Plurimat Elestart	125	1	-	0,6	B7HS	5110	Q204	BR7HIX	7067
X7	125	1	2007-	0,8	CR8EB	7784	-	CR8EIX	4218
X7 Evo 125 i.e.	125	1	2007-	0,7	CR8EKB	4374	-	CR8EIX	4218
X8	125	1	-	0,7	CR9EB	6955	-	CR9EIX	3521
X8 Street	125	1	-	0,8	CR7EB	4663	-	CR7EIX	7385
X9	125	1	2000-2002	0,7	CR9EB	6955	-	CR9EIX	3521
X9	125	1	2002-	0,6	CR8EB	7784	-	CR8EIX	4218
X-Evo	125	1	2006-	0,6	CR8EB	7784	-	CR8EIX	4218
XR-Typhoon	125	1	-	0,5	B9ES	2611	Q202	BR9EIX	3981
ZIP	125	1	-	0,7	CR7EB	4663	-	CR7EIX	7385
ZIP-New Edge Leader 2 Stroke	125	1	2001-	0,6	B9ES	2611	Q202	BR9EIX	3981
ZIP-New Edge Leader 4 Stroke	125	1	2000-	0,7	CR9EB	6955	-	CR9EIX	3521
Cosa	150		-	0,6	BR9ES	5722	Q208	BR9EIX	3981
Fly	150	1	2008-	0,8	CR7EB	4663	-	CR7EIX	7385
Hexagon	150	1	1994-	0,5	B9ES	2611	Q202	BR9EIX	3981
Liberty	150	1	2002-	0,8	CR7EB	4663	-	CR7EIX	7385
Piaggio	150	1	-	0,5	B9ES	2611	Q202	BR9EIX	3981
PX-Vespa PX Kat	150	1	-	0,7	BR6HS	3922	Q209	BR6HIX	3419
PX-Vespa PX MA AE	150	1	1986-	0,5	B6HS	4510	Q203	BR6HIX	3419
Skipper	150	1	1993-	0,6	B9ES	2611	Q202	BR9EIX	3981
Skipper ST 4 Stroke	150	1	-2000	0,7	BR9ES	5722	Q208	BR9EIX	3981
Skipper ST 4 Stroke	150	1	2001-	0,8	CR7EB	4663	-	CR7EIX	7385
SKR 150	150	1	1998-	0,5	B9ES	2611	Q202	BR9EIX	3981

* Bitte Elektrodenabstand nach Angaben des Herstellers justieren

* Please adjust the groundelectrode gap

* Veuillez vérifier L' écartement

* Por favor, ajustar distancia entre electrodos

* regolare il gap

C
Y
L

Stock-No

Quick-No



Stock-No IX

PIAGGIO

Vespa ET 4	150	1	-2001	0,6	CR7E	4578	Q225	CR7EIX	7385
Vespa ET 4	150	1	2001-2002	0,6	CR8EB	7784	-	CR8EIX	4218
Vespa ET 4	150	1	2002-	0,8	CR7EB	4663	-	CR7EIX	7385
Vespa Long Base	150	1	-	0,5	B6ES	7310	-	-	-
Vespa LX	150	1	2008-	0,8	CR7EB	4663	-	CR7EIX	7385
Vespa LX 150	150		2012-	0,6	CR8EB	7784	-	CR8EIX	4218
Vespa LX 150 i.e.	150	1	2009-	0,8	CR7EB	4663	-	CR7EIX	7385
Vespa LXV	150	1	-	0,8	CR7EB	4663	-	CR7EIX	7385
Vespa S	150	1	-	0,8	CR7EB	4663	-	CR7EIX	7385
Vespa S i.e.	150	1	2008-	0,8	CR7EB	4663	-	CR7EIX	7385
Vespa Short Base	150	1	-	0,5	B6HS	4510	Q203	BR6HIX	3419
X8 Street	150	1	-	0,8	CR7EB	4663	-	CR7EIX	7385
Vespa	160	1	-	0,5	B6HS	4510	Q203	BR6HIX	3419
Vespa GT	160	1	-	0,5	B6HS	4510	Q203	BR6HIX	3419
Vespa	175	1	-	0,5	B6HS	4510	Q203	BR6HIX	3419
Hexagon LXT	180	1	1998-2000	0,5	B9ES	2611	Q202	BR9EIX	3981
Super Hexagon LXT 180	180	1	2001-	0,6	CR8EB	7784	-	CR8EIX	4218
Vespa SS	180	1	-	0,5	B6HS	4510	Q203	BR6HIX	3419
X9 4 Stroke Amalfi	180	1	2001-	0,6	CR8EB	7784	-	CR8EIX	4218
Ape	190		-	0,7	BR7HS	4122	Q211	BR7HIX	7067
Beverly	200	1	2002-	0,6	CR8EB	7784	-	CR8EIX	4218
Carnaby	200	1	2007-	0,6	CR8EB	7784	-	CR8EIX	4218
Cosa	200	1	-	0,5	B8ES	2411	Q201	BR8EIX	5044
Cosa Cylinder Alu. 12hp)	200	1	1993-1997	0,6	BR8ES	5422	Q207	BR8EIX	5044
Cosa FL	200	1	1991-	0,5	B8ES	2411	Q201	BR8EIX	5044
Cosa II MA AE	200	1	1988-	0,6	BR8ES	5422	Q207	BR8EIX	5044
Cosa MA AE	200	1	1988-	0,6	BR8ES	5422	Q207	BR8EIX	5044
DN	200	1	-	0,5	BR7ES	5122	-	BR7EIX	6664
DS	200	1	-	0,5	BR7ES	5122	-	BR7EIX	6664
Leader LXT	200	1	2000-	0,7	CR9EB	6955	-	CR9EIX	3521
Liberty	200	1	2004-	0,8	CR7EB	4663	-	CR7EIX	7385
PE	200	1	-	0,5	BR7ES	5122	-	BR7EIX	6664
Vespa DN, DS, E	200	1	-	0,5	B5ES	6410	-	-	-
Vespa Granturismo L	200	1	-	0,6	CR7EKB	4455	-	CR7EIX	7385
Vespa PX E/Iris/Iris Elestart	200	1	-	0,6	B7ES	1111	-	BR7EIX	6664
Vespa PX MA AE	200	1	1986-	0,5	B6ES	7310	-	-	-
Vespa Rally	200	1	-	0,5	BR7ES	5122	-	BR7EIX	6664
Vespa TX Elestart	200	1	-	0,6	B7ES	1111	-	BR7EIX	6664
X8	200	1	2005-	0,6	CR7EKB	4455	-	CR7EIX	7385
Ape	220		-	0,7	BR7HS	4122	Q211	BR7HIX	7067
Beverly	250	1	2003-	0,7	PMR8B	6378	-	-	-
Beverly GTS 4 Stroke Injection	250	1	2006-	0,7	PMR8B	6378	-	-	-
Carnaby	250	1	2008-	0,7	PMR8B	6378	-	-	-
Cruiser	250	1	2003-	0,7	PMR8B	6378	-	-	-
Hexagon GT, X	250	1	1998-2001	0,9	DPR6EA-9	5531	-	-	-
MP3 ie /RST	250	1	2006-	0,7	PMR8B	6378	-	-	-
MP3 RL ie	250	1	-	0,7	PMR8B	6378	-	-	-
Super Hexagon GTX	250		2000-	0,7	CR9E	6263	Q227	CR9EIX	3521
Tourer	250	1	2003-	0,7	PMR8B	6378	-	-	-
Vespa GTS ie	250	1	2006-	0,7	PMR8B	6378	-	-	-
Vespa GTV Via Montenapoleone	250	1	2011-	0,7	PMR8B	6378	-	-	-

* Bitte Elektrodenabstand nach Angaben des Herstellers justieren

* Please adjust the groundelectrode gap

* Veuillez vérifier L' écartement

* Por favor, ajustar distancia entre electrodos

* regolare il gap

C
y
l

0201



Stock-№

Quick-№



Stock-№ IX

PIAGGIO

X7	250	1	2007-	0,7	PMR8B	6378	-	-	-
X8 4 Stroke Injection	250	1	2006-	0,7	PMR8B	6378	-	-	-
X9 4 Stroke	250	1	2000-2003	0,9	DPR7EA-9	5129	Q220	DPR7EIX-9	7803
X9 Evolution	250	1	-	0,6	CR8EB	7784	-	CR8EIX	4218
X-Evo	250	1	-	0,7	PMR8B	6378	-	-	-
Beverly 300 i.e.	300	1	2011-	0,7	CR8EKB	4374	-	CR8EIX	4218
Beverly Tourer 300 i.e.	300	1	2010-	0,7	CR8EKB	4374	-	CR8EIX	4218
Carnaby	300	1	2009-	0,7	CR8EKB	4374	-	CR8EIX	4218
Carnaby Cruiser 300 i.e.	300	1	2010-	0,7	CR8EKB	4374	-	CR8EIX	4218
MP3 300 i.e. / LT 300 i.e.	300	1	2010-	0,7	CR8EKB	4374	-	CR8EIX	4218
MP3 300 i.e. Hybrid	300	1	2011-	0,7	CR8EKB	4374	-	CR8EIX	4218
MP3 LT	300	1	-	0,7	CR8EKB	4374	-	CR8EIX	4218
MP3 LT 300 i.e. Hybrid	300	1	2011-	0,7	CR8EKB	4374	-	CR8EIX	4218
Vespa GTS Super	300	1	2008-	0,7	CR8EKB	4374	-	CR8EIX	4218
Vespa GTS Super Sport	300	1	2011-	0,7	CR8EKB	4374	-	CR8EIX	4218
Vespa GTS Super Sport ie	300	1	2011-	0,7	CR8EKB	4374	-	CR8EIX	4218
Vespa GTV via Montenapoleone	300	1	2010-	0,7	CR8EKB	4374	-	CR8EIX	4218
X7 EVO i.e.	300	1	2010-	0,7	CR8EKB	4374	-	CR8EIX	4218
Beverly Sport Touring 350 IE	350	1	2012-	0,7	CR8EKB	4374	-	CR8EIX	4218
X10	350		2012-	0,7	CR8EKB	4374	-	CR8EIX	4218
Beverly / Tourer	400	1	2006-	0,7	CR7EKB	4455	-	CR7EIX	7385
MP3	400	1	2007-	0,8	CR7EKB	4455	-	CR7EIX	7385
MP3 LT 400 i.e.	400	1	2009-	0,8	CR7EKB	4455	-	CR7EIX	7385
MP3 LT Sport ie	400		2011-	0,7	CR7EKB	4455	-	CR7EIX	7385
MP3 RL ie	400	1	-	0,7	CR7EKB	4455	-	CR7EIX	7385
MP3 RST	400	1	2007-	0,7	CR7EKB	4455	-	CR7EIX	7385
X8	400	1	2006-	0,7	CR7EKB	4455	-	CR7EIX	7385
X-Evo	400	1	2007-	0,8	CR7EKB	4455	-	CR7EIX	7385
B500	460		2003-	0,8	CR7EKB	4455	-	CR7EIX	7385
Beverly	500	1	2003-	0,7	CR7EKB	4455	-	CR7EIX	7385
Beverly Cruiser	500	1	2007-	0,7	CR7EKB	4455	-	CR7EIX	7385
X9	500	1	2002-	0,7	CR7EKB	4455	-	CR7EIX	7385
X9 Evo ABS	500	1	2002-	0,7	CR7EKB	4455	-	CR7EIX	7385

PIONEER

Nevada 125	125		2008-	0,7	D8EA	2120	Q216	DR8EIX	6681
Torro 125	125		2008-	0,7	D8EA	2120	Q216	DR8EIX	6681

POLINI

Steel-910 LC - pocket bike	50	1	-	0,6	B6HS	4510	Q203	BR6HIX	3419
Steel-910 Race / LC Race - pocket bike	50	1	-	0,6	-	-	-	BR7HIX	7067

REGAL RAPTOR

DD50QE-2	50	1	2003-	0,7	CR7HSA	4549	-	CR7HIX	7544
DD100E	100		2003-	0,7	CR7HSA	4549	-	CR7HIX	7544

RENAULT SPORT

Campus	50	1	2001-	0,6	BR8ES	5422	Q207	BR8EIX	5044
Spécimen	50	1	2001-	0,6	BR8HS	4322	Q212	BR8HIX	7001
Spécimen	100	1	2001-	0,6	BR8HS	4322	Q212	BR8HIX	7001
Fulltime, Groomy	125	1	2001-	0,7	CR9EB	6955	-	CR9EIX	3521

* Bitte Elektrodenabstand nach Angaben des Herstellers justieren

* Please adjust the groundelectrode gap

* Veuillez vérifier L' écartement

* Por favor, ajustar distancia entre electrodos

* regolare il gap

C
Y
L

0201



Stock-No

Quick-No



Stock-No IX

RENAULT SPORT

Kouranos	125	1	2001-	0,7	CR9EB	6955	-	CR9EIX	3521
----------	-----	---	-------	-----	-------	------	---	--------	------

REX

Rex 25	25	1	-	0,6	BPR7HS	6422	Q215	BPR7HIX	5944
Rexy 25	25	1	1996-	0,6	BPR7HS	6422	Q215	BPR7HIX	5944
Rexy 50	25	1	1996-	0,6	BPR7HS	6422	Q215	BPR7HIX	5944
Rex 50	50	1	1996-	0,6	BPR7HS	6422	Q215	BPR7HIX	5944
RS 450 QM50DT-6	50	1	-	0,6	CR7HS	7223	-	CR7HIX	7544
Scooter	50	1	1996-	0,6	BPR7HS	6422	Q215	BPR7HIX	5944
Silver Star	50	1	-	0,6	BPR7HS	6422	Q215	BPR7HIX	5944
Silver Street	50	1	-	0,6	BPR7HS	6422	Q215	BPR7HIX	5944
Chopper 125	125	1	-	0,7	DR8EA	7162	-	DR8EIX	6681
Cruiser 125	125	1	-	0,7	DR8EA	7162	-	DR8EIX	6681
Fun Bike	125	1	2000-	0,9	DP7EA-9	5629	-	DPR7EIX-9	7803
Rex 125	125	1	1997-	0,5	CR7HSA	4549	-	CR7HIX	7544
Rexy 125	125	1	-	0,5	CR7HSA	4549	-	CR7HIX	7544

RFR

Engine Linhai	138		2007-	0,7	C7HSA	4629	-	CR7HIX	7544
---------------	-----	--	-------	-----	-------	------	---	--------	------

RIDERS

Riders Super Cub	50		2011-	0,6	CR7HSA	4549	-	CR7HIX	7544
Riders Super Cub	110		2011-	0,6	CR7HSA	4549	-	CR7HIX	7544

RIEJU

Drac	50	1	1996-	0,5	BR8ES	5422	Q207	BR8EIX	5044
MRT-MRT 50 (Incl. Pro, SM)	50		-	0,6	BR9ES	5722	Q208	BR9EIX	3981
MRX-Euro	50	1	2002-	0,7	BR8ES	5422	Q207	BR8EIX	5044
MRX-Top	50	1	2003-	0,7	BR8ES	5422	Q207	BR8EIX	5044
MX-Infantil - Morini S5	50	1	2001-2001	0,5	B6HS	4510	Q203	BR6HIX	3419
MX-Infantil - Morini S6	50	1	2002-	0,6	B9ES	2611	Q202	BR9EIX	3981
NKD	50	1	2003-	0,6	BR9ES	5722	Q208	BR9EIX	3981
RR	50	1	-	0,7	BR8ES	5422	Q207	BR8EIX	5044
RR-Castrol	50	1	2002-	0,6	BR9ES	5722	Q208	BR9EIX	3981
RR-Euro	50	1	2002-	0,6	BR9ES	5722	Q208	BR9EIX	3981
RR-Racing	50	1	-2000	0,7	BR8ES	5422	Q207	BR8EIX	5044
RR-Special Edition	50		2003-	0,7	BR8ES	5422	Q207	BR8EIX	5044
RR-Spike	50	1	-2000	0,7	BR8ES	5422	Q207	BR8EIX	5044
RR-Spike Racing Pro	50	1	2001-	0,7	BR8ES	5422	Q207	BR8EIX	5044
RR-Supermotard	50	1	-2000	0,7	BR8ES	5422	Q207	BR8EIX	5044
RRX-Spike 50 Supermoto	50		2007-	0,5	BR8ES	5422	Q207	BR8EIX	5044
RS1	50	1	1997-	0,6	BR8ES	5422	Q207	BR8EIX	5044
RS1-Evo	50		1998-2004	0,8	BR9ES	5722	Q208	BR9EIX	3981
RS1-Evo Euro	50	1	2002-	0,6	BR9ES	5722	Q208	BR9EIX	3981
RS1-Racing	50	1	1997-2000	0,7	BR8ES	5422	Q207	BR8EIX	5044
RS2	50		-	0,7	BR8ES	5422	Q207	BR8EIX	5044
RS2-Matrix (Incl. Pro)	50		2003-	0,7	BR9ES	5722	Q208	BR9EIX	3981
RS2-NKD	50		-	0,7	BR9ES	5722	Q208	BR9EIX	3981
RS3	50		2011-	0,7	BR9ES	5722	Q208	BR9EIX	3981

* Bitte Elektrodenabstand nach Angaben des Herstellers justieren

* Please adjust the groundelectrode gap

* Veuillez vérifier L' écartement

* Por favor, ajustar distancia entre electrodos

* regolare il gap

C
y
l

0201



Stock-№

Quick-№



Stock-№ IX

RIEJU

RS3-NKD	50		2013-	0,7	BR9ES	5722	Q208	BR9EIX	3981
SMX	50	1	2002-	0,6	BR9ES	5722	Q208	BR9EIX	3981
SMX-EURO	50		2002-	0,6	BR9ES	5722	Q208	BR9EIX	3981
SMX-FR	50		2008-	0,6	BR9ES	5722	Q208	BR9EIX	3981
Tango	50		2007-	0,7	BR9ES	5722	Q208	BR9EIX	3981
Windy	50	1	-	0,5	BR7HS	4122	Q211	BR7HIX	7067
Marathon (Enduro / SM)	125		-	0,7	CR8E	1275	Q226	CR8EIX	4218
MRX	125		2003-	0,8	BR8ES	5422	Q207	BR8EIX	5044
MRX-(Yamaha Engine)	125	1	2002-	0,6	CR7HSA	4549	-	CR7HIX	7544
RS2-Matrix	125	1	2007-	0,6	CR7HSA	4549	-	CR7HIX	7544
RS2-NKD	125		2006-2007	0,6	CR7HSA	4549	-	CR7HIX	7544
RS2-Pro	125	1	2007-2011	0,8	CR7HSA	4549	-	CR7HIX	7544
RS3	125	1	2011-	0,7	CR8E	1275	Q226	CR8EIX	4218
RS3-NKD	125		2013-	0,7	CR8E	1275	Q226	CR8EIX	4218
SMX	125		2003-	0,8	BR8ES	5422	Q207	BR8EIX	5044
SMX-(Yamaha Engine)	125	1	2002-	0,6	CR7HSA	4549	-	CR7HIX	7544
Tango	125		2007-	0,6	CR7HSA	4549	-	CR7HIX	7544
Marathon	250		2010-	0,7	CR8E	1275	Q226	CR8EIX	4218
Tango	250		-	0,7	D8EA	2120	Q216	DR8EIX	6681
Marathon	450		2010-	0,7	CR8E	1275	Q226	CR8EIX	4218

ROYAL ENFIELD

Sunny, Bonny	50	1	-	0,5	B6HS	4510	Q203	BR6HIX	3419
KB 100	100		-	0,5	B8ES	2411	Q201	BR8EIX	5044
Scooter	125		-	0,5	B6HS	4510	Q203	BR6HIX	3419
Bullet & De Luxe - Long Base	350		-	0,6	BR6ES	4922	-	-	-
Bullet & De Luxe - Short Base	350		-	0,6	BR6HS	3922	Q209	BR6HIX	3419
Bullet - Long Base	500		-	0,6	B8ES	2411	Q201	BR8EIX	5044
Bullet - Short Base	500		-	0,6	B8HS	5510	Q205	BR8HIX	7001
Bullet Classic models	500		1980-2008	0,5	BR8ES	5422	Q207	BR8EIX	5044
Bullet Electra X	500		2004-	0,5	B9ES	2611	Q202	BR9EIX	3981

RTX

C 125	125	1	-	0,5	B7HS	5110	Q204	BR7HIX	7067
T 125	125	1	-	0,5	B7HS	5110	Q204	BR7HIX	7067
C 212	212	1	-	0,5	B8HS	5510	Q205	BR8HIX	7001
T 212	212	1	-	0,5	B8HS	5510	Q205	BR8HIX	7001

SACHS

4 rock	50	1	2006-	0,7	BPR7HS	6422	Q215	BPR7HIX	5944
49er	50	1	2005-	0,5	CR7HSA	4549	-	CR7HIX	7544
Bee 50	50	1	-	0,6	BPR6HS	7022	Q214	BPR6HIX	4085
Buxy (RS)	50	1	-	0,6	B7HS	5110	Q204	BR7HIX	7067
City Roller CV 50	50	1	-	0,7	BPR6HS	7022	Q214	BPR6HIX	4085
Dirty Devil	50		2004-	0,6	BP5HS	4111	-	-	-
Eagle	50	1	2009-	0,6	BR8HSA	5539	-	BR8HIX	7001
Limbo	50	1	-	0,7	BP6HS	4511	-	BPR6HIX	4085
MadAss	50		2004-	0,6	CR7HSA	4549	-	CR7HIX	7544
Reggae (RS)	50	1	-	0,6	B7HS	5110	Q204	BR7HIX	7067
Samba SR	50	1	-	0,5	B8HS	5510	Q205	BR8HIX	7001
Speedake	50	1	-	0,6	B7HS	5110	Q204	BR7HIX	7067

* Bitte Elektrodenabstand nach Angaben des Herstellers justieren

* Please adjust the groundelectrode gap

* Veuillez vérifier L' écartement

* Por favor, ajustar distancia entre electrodos

* regolare il gap

C
Y
L

Stock-No

Quick-No



Stock-No IX

SACHS

Speedfight 50 AC	50	1	1997-	0,6	BR7HS	4122	Q211	BR7HIX	7067
Speedfight 50 LC	50	1	1997-	0,6	BR7HS	4122	Q211	BR7HIX	7067
Speedfight 50 LC ADT	50	1	1997-	0,6	BR7HS	4122	Q211	BR7HIX	7067
Speedforce 25	50	1	2007-	0,6	BPR6HS	7022	Q214	BPR6HIX	4085
Speedforce 50	50	1	2007-	0,6	BPR6HS	7022	Q214	BPR6HIX	4085
Speedforce R50	50	1	2007-	0,6	BPR6HS	7022	Q214	BPR6HIX	4085
Speedjet 25	50	1	-	0,6	BPR6HS	7022	Q214	BPR6HIX	4085
Speedjet 50	50	1	-	0,6	BPR6HS	7022	Q214	BPR6HIX	4085
Speedjet R	50		2009-	0,7	BPR7HS	6422	Q215	BPR7HIX	5944
Speedjet RS	50		2011-	0,7	BPR7HS	6422	Q215	BPR7HIX	5944
Splinter	50	1	-	0,6	B7HS	5110	Q204	BR7HIX	7067
Squab	50	1	-	0,6	BR8HS	4322	Q212	BR8HIX	7001
SR 50	50	1	-	0,6	B8HS	5510	Q205	BR8HIX	7001
SV 50	50	1	-	0,6	B8HS	5510	Q205	BR8HIX	7001
SV 50 Junior	50	1	-	0,6	B8HS	5510	Q205	BR8HIX	7001
SX1	50	1	-	0,6	BPR6HS	7022	Q214	BPR6HIX	4085
T-Rex	50	1	2006-	0,6	BPR7HS	6422	Q215	BPR7HIX	5944
Zenith	50	1	-	0,6	BP6HS	4511	-	BPR6HIX	4085
City Roller CV 80	80	1	-	0,7	BPR6HS	7022	Q214	BPR6HIX	4085
City Roller CV 80 E	80	1	-	0,7	BR8HS	4322	Q212	BR8HIX	7001
SR	80	1	-	0,6	B8HS	5510	Q205	BR8HIX	7001
SV	80	1	-	0,6	B8HS	5510	Q205	BR8HIX	7001
Helix	100		2006-	0,6	BPR7HS	6422	Q215	BPR7HIX	5944
T-Rex	100		2006-	0,6	BPR7HS	6422	Q215	BPR7HIX	5944
4 rock	110		2006-	0,7	BPR7HS	6422	Q215	BPR7HIX	5944
Dirty Devil	110	1	2004-	0,6	C7HSA	4629	-	CR7HIX	7544
Eagle	125	1	2009-	0,6	CR7HSA	4549	-	CR7HIX	7544
MadAss	125		2006-	0,6	C7HSA	4629	-	CR7HIX	7544
SR 125	125	1	-	0,6	BP6HS	4511	-	BPR6HIX	4085
SR 125 C	125	1	-	0,6	BP6HS	4511	-	BPR6HIX	4085
Superduke	125	1	1997-	0,6	C7HSA	4629	-	CR7HIX	7544
SV 125	125	1	-	0,6	BP6HS	4511	-	BPR6HIX	4085
SV 125 C	125	1	-	0,6	BP6HS	4511	-	BPR6HIX	4085
V2-Roadster	125	1	2001-	0,7	CR6HSA	2983	-	CR6HIX	7274
XTC-Racing / N	125	1	1998-2001	0,7	BR8ES	5422	Q207	BR8EIX	5044
ZX-Trail	125	1	2001-	0,7	BR8ES	5422	Q207	BR8EIX	5044
ZZ-Super Motard	125	1	2001-	0,7	BR8ES	5422	Q207	BR8EIX	5044
4 rock	150		2006-	0,7	C7HSA	4629	-	CR7HIX	7544
Helix	150		2006-	0,6	C7HSA	4629	-	CR7HIX	7544
4 rock	250		2006-	0,7	CR8HSA	2086	-	CR8HIX	7669
V 1.6-Roadster	650	1	2000-	0,8	CR9E	6263	Q227	CR9EIX	3521
V 3.8-Roadster	800	2	2001-	0,9	DPR8EA-9	4929	Q221	DPR8EIX-9	2202
B 805	805		2002-	0,9	DPR8EA-9	4929	Q221	DPR8EIX-9	2202

SAN YANG

Bullet (G5A,B)	50	1	-	0,6	BR8HSA	5539	-	BR8HIX	7001
DD	50	1	-	0,6	BR8HSA	5539	-	BR8HIX	7001
DD 50 Mofa	50	1	-	0,6	BR8HSA	5539	-	BR8HIX	7001
Dio (F5A, B, E)	50	1	-	0,6	BR8HSA	5539	-	BR8HIX	7001
Fancy 50	50	1	1995-	0,6	BR8HSA	5539	-	BR8HIX	7001
Flash	50	1	-	0,6	BR8HSA	5539	-	BR8HIX	7001

* Bitte Elektrodenabstand nach Angaben des Herstellers justieren

* Please adjust the groundelectrode gap

* Veuillez vérifier L' écartement

* Por favor, ajustar distancia entre electrodos

* regolare il gap

C
Y
L

0201



Stock-№

Quick-№



Stock-№ IX

SAN YANG

Free	50	1	-	0,6	BR8HSA	5539	-	BR8HIX	7001
Jet	50	1	-	0,6	BR8HSA	5539	-	BR8HIX	7001
Jet Euro X	50	1	-	0,6	BR8HSA	5539	-	BR8HIX	7001
Jet Mio	50	1	-	0,6	BR8HSA	5539	-	BR8HIX	7001
Mike 50	50	1	-	0,6	BR8HSA	5539	-	BR8HIX	7001
Pure 50	50	1	-	0,6	BR8HSA	5539	-	BR8HIX	7001
Red Devil	50	1	-	0,6	BR8HSA	5539	-	BR8HIX	7001
RS 50 (Shark 50)	50	1	-	0,6	BR8HSA	5539	-	BR8HIX	7001
Super Fancy 50	50	1	-	0,6	BR8HSA	5539	-	BR8HIX	7001
Duke 125	125	1	-	0,6	C7HSA	4629	-	CR7HIX	7544
Euro MX 125	125	1	-	0,6	CR7HSA	4549	-	CR7HIX	7544
GTS	125	1	-	0,7	CR8E	1275	Q226	CR8EIX	4218
HD 125 Evo	125	1	-	0,7	CR8E	1275	Q226	CR8EIX	4218
Joyride	125	1	-	0,6	CR7HSA	4549	-	CR7HIX	7544
RS 4V	125	1	-	0,6	CR7HSA	4549	-	CR7HIX	7544
Super Duke 125	125	1	-	0,6	C7HSA	4629	-	CR7HIX	7544
HD 200 i	200	1	-	0,7	CR8E	1275	Q226	CR8EIX	4218
GTS	250	1	-	0,7	CR8E	1275	Q226	CR8EIX	4218

SASY

Classic 200 E	50	1	1996-	0,5	BPR6HS	7022	Q214	BPR6HIX	4085
JC 50	50	1	1996-	0,6	C7HSA	4629	-	CR7HIX	7544
Jet 50	50	1	1996-	0,5	BPR6HS	7022	Q214	BPR6HIX	4085
Mulan B	50	1	1996-	0,5	BPR6HS	7022	Q214	BPR6HIX	4085
Mulan Super AG	50	1	1996-	0,5	BPR6HS	7022	Q214	BPR6HIX	4085
Standard 50	50	1	1996-	0,5	BPR6HS	7022	Q214	BPR6HIX	4085

SCORPA

4-Tricks	70	1	2006-2007	0,6	CR7HSA	4549	-	CR7HIX	7544
SR-R	125	1	2011-	0,6	BP5ES	6511	-	BPR5EIX	6597
SY-FR	125	1	2003-2009	0,6	CR7HSA	4549	-	CR7HIX	7544
TY-F	125		2012-	0,7	CR6HSA	2983	-	CR6HIX	7274
TY-S-F	125	1	2004-2006	0,6	CR7HSA	4549	-	CR7HIX	7544
SY-FR	175	1	2003-2009	0,6	CR7HSA	4549	-	CR7HIX	7544
TY-S-F	175	1	2003-2009	0,6	CR7HSA	4549	-	CR7HIX	7544
Easy Trial	250	1	1994-	0,6	BP5ES	6511	-	BPR5EIX	6597
SY 250 Racing	250		2001-2009	0,6	-	-	-	BKR5EIX	6341
SY-F Long Rider	250	1	2007-	0,8	CR8E	1275	Q226	CR8EIX	4218
SY-FR	250		2007-	0,7	CR8E	1275	Q226	CR8EIX	4218
SY-Long Ride	250	1	2000-	0,6	-	-	-	BPR6EIX	6637
T-Ride F	250	1	2008-	0,8	CR8E	1275	Q226	CR8EIX	4218
TY-250 / E	250		-	0,7	-	-	-	BKR6EIX	6418
SR-280R	272		2011-	0,5	BP5ES	6511	-	BPR5EIX	6597
Easy Trial	280	1	1994-	0,6	BP5ES	6511	-	BPR5EIX	6597
SR-R	280	1	2011-	0,6	BP5ES	6511	-	BPR5EIX	6597
294	300	1	2011-	0,6	BP5ES	6511	-	BPR5EIX	6597
295	300	1	2011-	0,6	BP5ES	6511	-	BPR5EIX	6597

SHE LUNG

Club	50	1	-	0,7	BP7HS	5111	-	BPR7HIX	5944
Racer	50	1	-	0,7	BP7HS	5111	-	BPR7HIX	5944

* Bitte Elektrodenabstand nach Angaben des Herstellers justieren

* Please adjust the groundelectrode gap

* Veuillez vérifier L' écartement

* Por favor, ajustar distancia entre electrodos

* regolare il gap

C
Y
L

0201



Stock-No

Quick-No



Stock-No IX

SHERCO

0.5 Kid	50		2003-	0,6	B9ES	2611	Q202	BR9EIX	3981
Base	50		-	0,7	BR9ES	5722	Q208	BR9EIX	3981
Champion Replica 50	50		-	0,7	BR9ES	5722	Q208	BR9EIX	3981
Enduro 50	50	1	2003-	0,7	BR9ES	5722	Q208	BR9EIX	3981
HRD50	50	1	2003-	0,7	BR9ES	5722	Q208	BR9EIX	3981
Ipone Replica	50		-	0,7	BR9ES	5722	Q208	BR9EIX	3981
Trial Kid	50	1	2001-	0,5	B9ES	2611	Q202	BR9EIX	3981
SE-R	50	1	2014-	0,7	BR9ES	5722	Q208	BR9EIX	3981
SM-R	50	1	2014-	0,7	BR9ES	5722	Q208	BR9EIX	3981
Supermotard 50	50	1	2003-	0,7	BR9ES	5722	Q208	BR9EIX	3981
SM Black Panther	50		2008-	0,6	BR9ES	5722	Q208	BR9EIX	3981
SM	50		2008-	0,6	BR9ES	5722	Q208	BR9EIX	3981
SM Supermotard	50		2008-	0,6	BR9ES	5722	Q208	BR9EIX	3981
SM Sherco Cup Replica	50		2008-	0,6	BR9ES	5722	Q208	BR9EIX	3981
Trail 0,8	80	1	2008-	0,7	BP5ES	6511	-	BPR5EIX	6597
0.8	80	1	-	0,5	BP5ES	6511	-	BPR5EIX	6597
ST	80	1	2014-	0,6	BP5ES	6511	-	BPR5EIX	6597
1.25	125	1	2008-	0,7	BP5ES	6511	-	BPR5EIX	6597
Academy	125		2009	0,6	BP5ES	6511	-	BPR5EIX	6597
1.25 - 2 Stroke	125	1	1999-	0,6	BP5ES	6511	-	BPR5EIX	6597
1.2 Trial	125	1	2000-	0,5	BP5ES	6511	-	BPR5EIX	6597
Trail 125	125		2008-	0,7	BP5ES	6511	-	BPR5EIX	6597
City Corp 125	125	1	2004-	0,6	CR7HSA	4549	-	CR7HIX	7544
City Corp 125 water cooler Supermotard	125		2008-	0,5	CR6HSA	2983	-	CR6HIX	7274
City Corp 125 water cooler Enduro	125		2008-	0,5	CR6HSA	2983	-	CR6HIX	7274
ST	125	1	2014-	0,6	BP5ES	6511	-	BPR5EIX	6597
X-Ride	125	1	2014-	0,6	BPR5ES	7422	-	BPR5EIX	6597
2.0	200	1	1999-	0,5	BP5ES	6511	-	BPR5EIX	6597
Access 2.5 2 Stroke	250		2010-	0,6	BP5ES	6511	-	BPR5EIX	6597
Scottich Six Days Winner	250	1	1999-	0,5	BP5ES	6511	-	BPR5EIX	6597
2.5i-F	250		2008-2011	0,7	CR8EK	3478	-	CR8EIX	4218
2.5 Trial	250	1	2000-	0,5	BP5ES	6511	-	BPR5EIX	6597
SE 2 Stroke	250	1	2014-	0,6	BR8ES	5422	Q207	BR8EIX	5044
SE-R 2 Stroke	250	1	2014-	0,6	BR8ES	5422	Q207	BR8EIX	5044
SEF 4 Stroke	250	1	2014-	0,7	CR8EK	3478	-	CR8EIX	4218
SEF-R 4 Stroke	250	1	2014-	0,7	CR8EK	3478	-	CR8EIX	4218
250i	250		2012-	0,7	CR8EK	3478	-	CR8EIX	4218
ST	250	1	2014-	0,6	BP5ES	6511	-	BPR5EIX	6597
2.5	250		1999-	0,6	BP5ES	6511	-	BPR5EIX	6597
ST	290	1	2014-	0,6	BP5ES	6511	-	BPR5EIX	6597
X-Ride	290	1	2014-	0,6	BP5ES	6511	-	BPR5EIX	6597
3.0i-F	290		2010-2011	0,7	CR8EK	3478	-	CR8EIX	4218
Access 2.9 (2 Stroke)	290		2010-	0,6	BP5ES	6511	-	BPR5EIX	6597
2.9	290		1999-	0,6	BP5ES	6511	-	BPR5EIX	6597
300i	290		2012-	0,7	CR8EK	3478	-	CR8EIX	4218
SE 2 Stroke	300	1	2014-	0,6	BR8ES	5422	Q207	BR8EIX	5044
SE-R 2 Stroke	300	1	2014-	0,6	BR8ES	5422	Q207	BR8EIX	5044
SEF 4 Stroke	300	1	2014-	0,7	CR8EK	3478	-	CR8EIX	4218
SEF-R 4 Stroke	300	1	2014-	0,7	CR8EK	3478	-	CR8EIX	4218
ST	300	1	2014-	0,6	BP5ES	6511	-	BPR5EIX	6597
3.2 4 Stroke	320		2005-	0,6	BCPR6E	6129	-	BCPR6EIX	5689
4.5 4 Stroke	450	1	2004-	0,6	CR8EK	3478	-	CR8EIX	4218

* Bitte Elektrodenabstand nach Angaben des Herstellers justieren

* Please adjust the groundelectrode gap

* Veuillez vérifier L' écartement

* Por favor, ajustar distancia entre electrodos

* regolare il gap

C
y
l

Stock-№

Quick-№



Stock-№ IX

SHERCO

4.5i Enduro	450		2005-	0,6	CR8EK	3478	-	CR8EIX	4218
4.5 4 Stroke Supermotard	450		2005-	0,6	CR8EK	3478	-	CR8EIX	4218
450i	450		2008-	0,6	CR8EK	3478	-	CR8EIX	4218
5.1 4 Stroke Enduro	510		2008-	0,6	CR8EK	3478	-	CR8EIX	4218
5.1 4 Stroke Supermotard	510		2008-	0,6	CR8EK	3478	-	CR8EIX	4218
5.1 4 Stroke	510	1	2005-	0,7	CR8EK	3478	-	CR8EIX	4218

SHERCO-HRD

0.5 Enduro	50	1	2002-	0,6	BR8ES	5422	Q207	BR8EIX	5044
0.5 Super Motard	50	1	2002-	0,6	BR8ES	5422	Q207	BR8EIX	5044

SIAMOTO

Birdie 25 Mofa	25	1	1999-	0,6	BPR6HS	7022	Q214	BPR6HIX	4085
Birdie 50 Mokick	50	1	1999-	0,6	BPR6HS	7022	Q214	BPR6HIX	4085
Sross 50	50	1	1999-	0,5	BR7HS	4122	Q211	BR7HIX	7067
Capri 125 4 Stroke	125	1	1999-	0,7	C7HSA	4629	-	CR7HIX	7544
Favourite 125 4 Stroke	125	1	1999-	0,7	C7HSA	4629	-	CR7HIX	7544
KD 125 4 Stroke	125	1	1999-	0,7	C7HSA	4629	-	CR7HIX	7544

SIMSON

Star 25	50	1	1996-	0,4	B8HS	5510	Q205	BR8HIX	7001
Star 25 Base E	50	1	1996-	0,4	B8HS	5510	Q205	BR8HIX	7001
Star 50	50	1	1996-	0,7	BPR6HS	7022	Q214	BPR6HIX	4085
Star Classic 50	50	1	1996-	0,4	B8HS	5510	Q205	BR8HIX	7001
Star Classic 50 Hot Summer	50	1	1996-	0,4	B8HS	5510	Q205	BR8HIX	7001
Trucky SD 50 CT	50	1	-	0,4	B8HS	5510	Q205	BR8HIX	7001
Hot Summer 80	70	1	1997-	0,4	B9HS	5810	-	BR9HIX	5687
Star Classic 80	70	1	1997-	0,4	B9HS	5810	-	BR9HIX	5687
Hot Summer 80	80	1	1996-	0,4	B8HS	5510	Q205	BR8HIX	7001
Star Classic 80	80	1	1996-	0,4	B8HS	5510	Q205	BR8HIX	7001

SINNIS

Eagle, Hawk (2-Stroke)	50		2006-	0,6	BPR7HS	6422	Q215	BPR7HIX	5944
Falcon, Jet (4-Stroke)	50		2006-	0,6	CR7HSA	4549	-	CR7HIX	7544
Flair	50		2012-	0,6	CR7HSA	4549	-	CR7HIX	7544
Phoenix	50		2012-	0,6	BPR7HS	6422	Q215	BPR7HIX	5944
Breeze	110		-	0,6	CR7HSA	4549	-	CR7HIX	7544
Apache, Blade, Max, Stealth, Vista	125		2007-	0,7	CR8E	1275	Q226	CR8EIX	4218
Eagle, Matrix, Matrix II, Nitro, Pioneer, Sublime (4-Stroke)	125		2007-	0,6	CR7HSA	4549	-	CR7HIX	7544
Eco City	125		2010-	0,6	CR7HSA	4549	-	CR7HIX	7544
Spirit	125		2012-	0,6	CR7HSA	4549	-	CR7HIX	7544
Trackstar	125		2010-	0,7	CR8E	1275	Q226	CR8EIX	4218
Apache, Blade	200		-	0,7	DR8ES-L	2923	Q218	DR8EIX	6681

SKYTEAM

Dax	100	1	-	0,7	CR7HSA	4549	-	CR7HIX	7544
Dax	125	1	2008-	0,7	CR7HSA	4549	-	CR7HIX	7544
Wacky ST125/Y	125		-	0,7	C7HSA	4629	-	CR7HIX	7544

* Bitte Elektrodenabstand nach Angaben des Herstellers justieren

* Please adjust the groundelectrode gap

* Veuillez vérifier L' écartement

* Por favor, ajustar distancia entre electrodos

* regolare il gap

C
y
l

0201



Stock-№

Quick-№



Stock-№ IX

SMC

NAF 50 Navigator	50		-	0,6	BPR7HS	6422	Q215	BPR7HIX	5944
NGF 50 Sports Force	50		-	0,6	BPR7HS	6422	Q215	BPR7HIX	5944
NKF 50 on/off road	50		-	0,6	BPR7HS	6422	Q215	BPR7HIX	5944
NLFR 50 Caprillio	50		-	0,6	BPR7HS	6422	Q215	BPR7HIX	5944
PAF 50 Partner	50		-	0,6	BPR7HS	6422	Q215	BPR7HIX	5944
SBF 50 Super	50		-	0,6	BPR7HS	6422	Q215	BPR7HIX	5944
NGN 90 Sports Force	90		-	0,6	BPR7HS	6422	Q215	BPR7HIX	5944
SBN 90 Super	90		-	0,6	BPR7HS	6422	Q215	BPR7HIX	5944
NKO 100 on/off road	100		-	0,6	BPR7HS	6422	Q215	BPR7HIX	5944
SBO 100 Super	100		-	0,6	BPR7HS	6422	Q215	BPR7HIX	5944
CHP 125 Chopper	125		-	0,7	DR8EA	7162	-	DR8EIX	6681

SPIGAOU

Dax	50	1	-	0,7	CR7HSA	4549	-	CR7HIX	7544
Dax (Engine Loncin)	125	1	-	0,7	CR7HSA	4549	-	CR7HIX	7544

SUNDIRO

Speedy 50	50	1	1996-	0,6	-	-	-	BR9EIX	3981
Speedy 80	80	1	-	0,6	-	-	-	BR9EIX	3981
Phönix XDZ 125 T	125	1	1996-	0,6	CR7HSA	4549	-	CR7HIX	7544
Phönix XDZ 125 TA	125	1	1996-	0,6	CR7HSA	4549	-	CR7HIX	7544
Phönix XDZ TN	125	1	1996-	0,6	DR8EA	7162	-	DR8EIX	6681

SUPERBYKE

M-PED 50	50		2006-	0,6	CR7HSA	4549	-	CR7HIX	7544
Powerband 50 (2-Stroke) Ø14mm Plug	50		2006-	0,6	BPR7HS	6422	Q215	BPR7HIX	5944
Powermax 50 (2-Stroke) Ø14mm Plug	50		2008-	0,6	BPR7HS	6422	Q215	BPR7HIX	5944
Powerband 125	125		2006-	0,6	CR7HSA	4549	-	CR7HIX	7544
RBP125	125		2006-	0,7	D8EA	2120	Q216	DR8EIX	6681
RMR125	125		-	0,7	CR8E	1275	Q226	CR8EIX	4218
SMax125	125		2008-	0,6	CR7HSA	4549	-	CR7HIX	7544

SUZUKI

AE-L, M, N, P, R, T	50	1	1990-1999	0,7	BPR6HS	7022	Q214	BPR6HIX	4085
AH	50	1	1992-	0,6	BPR6HS	7022	Q214	BPR6HIX	4085
AH-Adress	50	1	1992-	0,7	BPR6HS	7022	Q214	BPR6HIX	4085
AH-FD	50	1	-	0,7	BPR6HS	7022	Q214	BPR6HIX	4085
AH-GP	50	1	1995-	0,6	BPR6HS	7022	Q214	BPR6HIX	4085
AJ-ZZ	50	1	1995-	0,5	BPR7HS	6422	Q215	BPR7HIX	5944
A-M/PM/PB-D	50	1	-	0,7	B8HS	5510	Q205	BR8HIX	7001
AP-R	50	1	1994-	0,7	BPR6HS	7022	Q214	BPR6HIX	4085
AP-S	50	1	1994-	0,7	BPR6HS	7022	Q214	BPR6HIX	4085
AP-T	50	1	1994-	0,7	BPR6HS	7022	Q214	BPR6HIX	4085
AP-V	50	1	1994-	0,7	BPR6HS	7022	Q214	BPR6HIX	4085
AP-W	50	1	1994-	0,7	BPR6HS	7022	Q214	BPR6HIX	4085
AY-A K5	50	1	2005-	0,6	CPR8E	7411	-	-	-
AY-Katana Air (V,W)	50	1	1997-1998	0,7	BPR6HS	7022	Q214	BPR6HIX	4085
AY-Katana Air (X,Y)	50	1	1999-	0,7	BPR7HS	6422	Q215	BPR7HIX	5944
AY-W Katana liquid (W,X)	50	1	1997-	0,7	BPR7HS	6422	Q215	BPR7HIX	5944

* Bitte Elektrodenabstand nach Angaben des Herstellers justieren

* Please adjust the groundelectrode gap

* Veuillez vérifier L' écartement

* Por favor, ajustar distancia entre electrodos

* regolare il gap

C
y
l

Stock-№

Quick-№



Stock-№ IX

SUZUKI

CL50D, CS50D, FS50 Snip	50		-	0,7	BPR4HS	7823	-	-	-
CP-CHF (Scooter)	50	1	1989-1992	0,7	BPR6HS	7022	Q214	BPR6HIX	4085
DR-Big	50		-	0,7	BR7HS	4122	Q211	BR7HIX	7067
GT-PE-B	50	1	-	0,7	BPR6HS	7022	Q214	BPR6HIX	4085
JR-(H > K1)	50	1	1987-1993	0,7	BP4HS	3611	-	-	-
RM-T, X, Z, D	50	1	1980-1995	0,7	BR7HS	4122	Q211	BR7HIX	7067
RMX-T,V,W,X,Y,K1	50	1	1996-	0,7	BPR8ES	3923	Q213	BPR8EIX	6684
RV-L/PN	50	1	-	0,7	BPR6HS	7022	Q214	BPR6HIX	4085
SMX-X / Y / K1	50	1	1999-	0,7	BPR8ES	3923	Q213	BPR8EIX	6684
TR-S Street Magic (W,X)	50	1	1998-	0,7	BPR6HS	7022	Q214	BPR6HIX	4085
TS-PC/XAM R	50	1	-	0,7	BPR6HS	7022	Q214	BPR6HIX	4085
UF-Estilette	50	1	2000-	0,8	BPR7HS	6422	Q215	BPR7HIX	5944
UX-Zillion (W,X)	50	1	1998-	0,7	BPR7HS	6422	Q215	BPR7HIX	5944
RM	65	1	2003-	0,7	BR10EG	3830	-	-	-
DR-Z	70	1	2008-	0,7	CR7HSA	4549	-	CR7HIX	7544
CP-C H F(SCOOTER)	80	1	-	0,7	BPR6HS	7022	Q214	BPR6HIX	4085
CS-CD	80	1	-	0,7	BPR6HS	7022	Q214	BPR6HIX	4085
DS-T,V,W,X,Y	80	1	1993-2000	0,7	B7ES	1111	-	BR7EIX	6664
GT-LX	80	1	-	0,8	B8ES	2411	Q201	BR8EIX	5044
JR	80	1	2001-	0,7	BP7ES	2412	Q206	BPR7EIX	4055
RG-EX	80	1	-	0,8	B8ES	2411	Q201	BR8EIX	5044
RM-M	80	1	-	0,7	BR10ES	4832	-	BR10EIX	6801
RM-XM	80	1	1992-1995	0,7	BR10ES	4832	-	BR10EIX	6801
RM-X-T	80	1	-	0,7	B8ES	2411	Q201	BR8EIX	5044
RMX-T,V,W,X,Y,K1	80	1	1996-	0,7	BR10ES	4832	-	BR10EIX	6801
RT-Z(OVNI)	80	1	-	0,7	B7ES	1111	-	BR7EIX	6664
RM	85	1	2001-2007	0,6	BR10ES	4832	-	BR10EIX	6801
RM	85	1	2008-	0,8	BR10ES	4832	-	BR10EIX	6801
AH-F	100		-	0,7	BPR7HS	6422	Q215	BPR7HIX	5944
RM	100	1	2004-	0,6	B9EGV	5827	-	-	-
DR-Z	110		2003-	0,7	CR6HSA	2983	-	CR6HIX	7274
B-M	120		-	0,7	BR7HS	4122	Q211	BR7HIX	7067
Address	125		2008-	0,8	CR8E	1275	Q226	CR8EIX	4218
AN	125	1	1995-1996	0,7	CR8E	1275	Q226	CR8EIX	4218
AN	125	1	1997-1999	0,7	CR7E	4578	Q225	CR7EIX	7385
AN-S	125	1	1995-	0,7	CR8EK	3478	-	CR8EIX	4218
AN-T	125	1	1996-	0,7	CR8E	1275	Q226	CR8EIX	4218
AN-V	125	1	1997-2000	0,7	CR9E	6263	Q227	CR9EIX	3521
AN-W	125	1	1997-2000	0,7	CR9E	6263	Q227	CR9EIX	3521
AN-X	125	1	1997-2000	0,7	CR9E	6263	Q227	CR9EIX	3521
Burgman	125	1	2007-	0,8	CR8E	1275	Q226	CR8EIX	4218
DF-E (X)	125		1999-	0,7	DR8EA	7162	-	DR8EIX	6681
DR-SE (R,S,W,X,Y,K1)	125		1994-	0,7	DR8EA	7162	-	DR8EIX	6681
DR-SM	125		2008-2012	0,8	CR8E	2275	Q226	CR8EIX	4218
DR-Z-L	125		2008-	0,7	DR8EA	7162	-	DR8EIX	6681
FL-DW	125	1	2008-	0,7	CR6HSA	2983	-	CR6HIX	7274
GN-R,V,W,X,Y,K1	125		1991-	0,7	DR8EA	7162	-	DR8EIX	6681
GP-All models	125		-	0,7	B8HS	5510	Q205	BR8HIX	7001
GS-ESD	125		-	0,7	DR8ES-L	2923	Q218	DR8EIX	6681
GZ-K4-K5	125		2004-	0,7	CR8E	1275	Q226	CR8EIX	4218
GZ-Marauder (W,X,Y)	125		1998-	0,7	DR8EA	7162	-	DR8EIX	6681
Marauder	125		2008-	0,8	CR7E	4578	Q225	CR7EIX	7385

* Bitte Elektrodenabstand nach Angaben des Herstellers justieren

* Please adjust the groundelectrode gap

* Veuillez vérifier L' écartement

* Por favor, ajustar distancia entre electrodos

* regolare il gap

C
Y
L

Stock-No

Quick-No



Stock-No IX

SUZUKI

RG	125		1998-2002	0,7	BR9ES	5722	Q208	BR9EIX	3981
RG-FU-N / P / R / U Wolf	125		-	0,7	BR9ECM	3252	-	BR9ECMIX	2707
RM	125		1993-	0,7	BR9EG	3230	-	-	-
RM	125	1	2002-	0,6	R6918B-8	4492	-	-	-
RM	125		2008-	0,6	R6918B-9	2954	-	-	-
RM-PRS	125		1993-1995	0,6	R4118S-9	3245	-	-	-
RM-T,U,W,X,Y,K1-K8	125		1996-	0,6	R6918B-8	4492	-	-	-
RV-Van Van K4-K5	125		2003-	0,7	CR8E	1275	Q226	CR8EIX	4218
Scooter 125	125		2008-	0,7	CR6HSA	2983	-	CR6HIX	7274
Sixteen	125	1	2008-	0,7	CR8E	1275	Q226	CR8EIX	4218
TU-XT (X)	125		1999-	0,7	DR8EA	7162	-	DR8EIX	6681
UC-Epicuro (X,Y)	125		1999-	0,7	CR8E	1275	Q226	CR8EIX	4218
UE-K1	125	1	2001-	0,7	CR7E	4578	Q225	CR7EIX	7385
UH-Burgman	125	1	2002-	0,8	CR8E	1275	Q226	CR8EIX	4218
UX-Sixteen	125		2007-	0,8	CR8E	1275	Q226	CR8EIX	4218
Van Van	125	1	2003-2007	0,8	CR8E	1275	Q226	CR8EIX	4218
Van Van	125	1	2008-	0,7	CR8E	1275	Q226	CR8EIX	4218
VL-Intruder Classic, LC	125		1999-	0,7	CR8E	1275	Q226	CR8EIX	4218
UX-Sixteen 150	150	1	2008-	0,7	CR8E	1275	Q226	CR8EIX	4218
AN-K7 Burgman	200		2007-	0,7	CR8EK	3478	-	CR8EIX	4218
DR-S	200		-	0,6	DR8ES-L	2923	Q218	DR8EIX	6681
GT-X5	200		-	0,7	B8ES	2411	Q201	BR8EIX	5044
TS-R M	200		1991-	0,7	BR9ES	5722	Q208	BR9EIX	3981
UH-Burgman	200	1	2007-	0,7	CR8EK	3478	-	CR8EIX	4218
AN-Burgman (K4-K5)	250	1	2004-	0,7	CR7EK	7546	-	CR7EIX	7385
AN-Burgman (W)	250	1	1998-1999	0,8	CR8EK	3478	-	CR8EIX	4218
GN-F / K / M / N / P / R / T	250		1985-1996	0,7	DR8ES-L	2923	Q218	DR8EIX	6681
GSX-E, T, X	250		-	0,7	DR8ES-L	2923	Q218	DR8EIX	6681
GT-AB	250		-	0,7	B9ES	2611	Q202	BR9EIX	3981
GZ-Marauder X	250		1999-	0,7	DR8EA	7162	-	DR8EIX	6681
LT-R H	250		1987-	0,6	B8EGV	5627	-	-	-
RGV-M, N, P, R	250		1991-	0,8	BR9ECM	3252	-	BR9ECMIX	2707
RM-2 Stroke	250		2008-	0,6	BR8EG	3130	-	-	-
RM-D	250		-	0,6	B9EGV	5827	-	-	-
RM-K1, K5	250	1	2001-2007	0,6	BR8EG	3130	-	-	-
RM-P, R, S	250		1992-1995	0,8	R4118S-8	3236	-	-	-
RM-T,V,W,X,Y	250		1996-2000	0,8	R6918B-7	6259	-	-	-
RMX-K / M / N / S	250		1989-1995	0,6	B8EGV	5627	-	-	-
RM-Z	250	1	2004-	0,6	CR8EB	7784	-	CR8EIX	4218
RM-Z	250	1	2006-	1,0	CR8EIA-10	4708	-	-	-
RM-Z-4 Stroke	250		2008-	1,0	CR8EIA-10	4708	-	-	-
TS-A, B	250		-	0,7	B8ES	2411	Q201	BR8EIX	5044
TS-X E/RH 250	250		-	0,7	-	-	-	BR8EIX	5044
TS-XG,H/RH250	250		-	0,8	BR9ES	5722	Q208	BR9EIX	3981
TU-X (V)	250		1997-	0,7	DR8ES-L	2923	Q218	DR8EIX	6681
TU-X (W,X)	250		1998-	0,7	DR8EA	7162	-	DR8EIX	6681
DR-SE (R,S,T,V,W,X)/SER/SR	350	1	1994-1999	0,6	CR9EK	4548	Q230	CR9EIX	3521
GT-K	380		1989-	0,7	B7ES	1111	-	BR7EIX	6664
AN-Burgman	400	1	2006-	0,7	CR7E	4578	Q225	CR7EIX	7385
AN-Burgman (K7, K8)	400	1	2007-	0,8	CR7E	4578	Q225	CR7EIX	7385
AN-Burgman (X, Y, K1, K6)	400	1	1999-2006	0,7	CR7E	4578	Q225	CR7EIX	7385
DR-S / T / X	400		1995-1997	0,7	DR8ES-L	2923	Q218	DR8EIX	6681

* Bitte Elektrodenabstand nach Angaben des Herstellers justieren

* Please adjust the groundelectrode gap

* Veuillez vérifier L' écartement

* Por favor, ajustar distancia entre electrodos

* regolare il gap

C
Y
I

0201



Stock-№

Quick-№



Stock-№ IX

SUZUKI

DR-Z-Y / K1 / E / SM	400	1	2000-	0,7	CR8E	1275	Q226	CR8EIX	4218
GSF-Bandit P	400		1993-	0,6	CR9EK	4548	Q230	CR9EIX	3521
GSX-F / Z	400		-	0,7	DR8ES-L	2923	Q218	DR8EIX	6681
GSX-R-H	400		1986-	0,7	CR9EK	4548	Q230	CR9EIX	3521
LT-Z	400		2002-	0,7	CR7E	4578	Q225	CR7EIX	7385
PE-T/X/Z	400		-	0,7	BR9EG	3230	-	-	-
TS-A, B	400		-	0,8	B9ES	2611	Q202	BR9EIX	3981
TS-K / L / M	400		1989-1991	0,8	B8ES	2411	Q201	BR8EIX	5044
GS-E, N	450		-	0,7	B8ES	2411	Q201	BR8EIX	5044
RMX	450	1	2010-	1,0	DIMR8A10	5066	-	-	-
RMX-(L0)	450	1	2010-	1,0	DIMR8A10	5066	-	-	-
RM-Z	450	1	2008-	1,0	DIMR8A10	5066	-	-	-
RM-Z-4 Stroke	450	1	2005-	1,0	CR8EIB-10	4948	-	-	-
RM-Z-ZL1 Enduro Inj	450	1	2011-	1,0	DIMR8A10	5066	-	-	-
RM-X / S	465		-	0,7	B8EGV	5627	-	-	-
DR-S / X	500		-	0,7	DR8ES-L	2923	Q218	DR8EIX	6681
GS-E (K,L,M,N,P,R,S)	500	2	1989-1995	0,9	DPR8EA-9	4929	Q221	DPR8EIX-9	2202
GS-E (K1)	500	2	2000-	0,9	DPR8EA-9	4929	Q221	DPR8EIX-9	2202
GS-E (T,V,W,X,Y)	500		1996-2000	0,9	DPR8EA-9	4929	Q221	DPR8EIX-9	2202
GS-F	500	2	2004-	0,9	DPR8EA-9	4929	Q221	DPR8EIX-9	2202
GT-A, B	500		-	0,7	BR7HS	4122	Q211	BR7HIX	7067
GS-EC, EN, D, B	550		-	0,7	B8ES	2411	Q201	BR8EIX	5044
GS-ET	550		-	0,7	B8ES	2411	Q201	BR8EIX	5044
GS-L / N / T	550		-	0,7	B8ES	2411	Q201	BR8EIX	5044
GSF-Bandit N & S (S,T,V,W,X)	600	4	1995-2002	0,7	CR9EK	4548	Q230	CR9EIX	3521
GSF-Bandit N & S (Y,K1)	600	4	2000-	0,7	CR9EK	4548	Q230	CR9EIX	3521
GS-FJ	600		1988-	0,7	DR8ES	5423	Q217	DR8EIX	6681
GSR-K6	600	4	2006-	0,7	CR9E	6263	Q227	CR9EIX	3521
GSX-F-W, X, Y, K1	600		1996-2001	0,9	CR9EK	4548	Q230	CR9EIX	3521
GSX-R-K1, K7	600	4	2000-	0,7	CR9E	6263	Q227	CR9EIX	3521
GSX-R-K6, K9	600	4	2006-	0,7	CR9E	6263	Q227	CR9EIX	3521
GSX-R-K8	600	4	2008-	0,9	CR9EIA-9	6289	-	-	-
GSX-R-V / W / X / Y	600	4	1997-2000	0,7	CR9E	6263	Q227	CR9EIX	3521
VS-GL Intruder S,T,V	600		1996-1997	0,9	DPR8EA-9	4929	Q221	DPR8EIX-9	2202
AN-Burgman	650	2	2002-	0,7	CR8E	1275	Q226	CR8EIX	4218
AN-Burgman Executive	650	2	2004-	0,7	CR8E	1275	Q226	CR8EIX	4218
Bandit / S	650	4	2008-	0,7	CR8E	1275	Q226	CR8EIX	4218
DL-Traveller V-strom K7 Twinspark	650	2	2010-	0,8	CR8E	1275	Q226	CR8EIX	4218
DL-V-Storm AU11 ABS	650	2	2011-	0,8	CR8E	1275	Q226	CR8EIX	4218
DL-V-Strom Twin Spark	650	2	2003-	0,8	CR8E	1275	Q226	CR8EIX	4218
DR-RER,S	650		1994-1995	0,9	DPR9EA-9	5329	Q222	DPR9EIX-9	5545
DR-RN,RSL,M,RM,N,P,R,S	650		1990-1995	0,9	DPR9EA-9	5329	Q222	DPR9EIX-9	5545
DR-SE (M,N,P,R,S,T)	650		1991-1996	0,9	DPR9EA-9	5329	Q222	DPR9EIX-9	5545
DR-SE (T,V,W,X,Y,K1)	650		1996-	0,7	CR10E	6264	-	CR10EIX	6482
GSF-Bandit	650	4	2005-	0,7	CR9EK	4548	Q230	CR9EIX	3521
GSF-Bandit N & S	650	4	2007-	0,9	DPR8EA-9	4929	Q221	DPR8EIX-9	2202
GSF-Bandit SUELA1 ABS	650		2011-	0,8	CR8E	1275	Q226	CR8EIX	4218
GSF-Bandit UE L1 / SUEL1	650		2011-	0,8	CR8E	1275	Q226	CR8EIX	4218
GSF-K7 Bandit Liquid Cooled	650	4	2008-	0,6	CR9E	6263	Q227	CR9EIX	3521
GS-GLX / GX	650		-	0,7	DR8ES-L	2923	Q218	DR8EIX	6681
GSX-F	650		2008-	0,7	CR8E	1275	Q226	CR8EIX	4218
GSX-FUEAL1 ABS/ ABS Leo Vince	650		2011-	0,8	CR8E	1275	Q226	CR8EIX	4218

* Bitte Elektrodenabstand nach Angaben des Herstellers justieren

* Please adjust the groundelectrode gap

* Veuillez vérifier L' écartement

* Por favor, ajustar distancia entre electrodos

* regolare il gap

C
Y
I

0201



Stock-No

Quick-No



Stock-No IX

SUZUKI

LS-P Savage (J > X)	650	1	1988-1999	0,9	DPR8EA-9	4929	Q221	DPR8EIX-9	2202
LS-All models	650	1	1987-1999	0,9	DPR8EA-9	4929	Q221	DPR8EIX-9	2202
SFV-Gladius	650	2	2009-	0,9	CR8EIA-9	4286	-	-	-
SFV-UEL1 Gladius	650	2	2011-	0,9	CR8EIA-9	4286	-	-	-
SV-N & S	650	2	2003-	0,7	-	-	-	CR8EIX	4218
SV-N & S (X,Y,K1)	650	2	1999-	0,6	CR9E	6263	Q227	CR9EIX	3521
SV-V-Strom / S	650	2	2008-	0,7	CR8E	1275	Q226	CR8EIX	4218
XF-Freewind (V,W,X)	650	1	1997-1999	0,7	CR10EK	2360	-	CR10EIX	6482
XF-Freewind (Y,K1)	650	1	2000-	0,7	CR10EK	2360	-	CR10EIX	6482
XN-85 D Turbo	650		-	0,7	DR8ES	5423	Q217	DR8EIX	6681
GSR	750		2011-	0,9	CR9EIA-9	6289	-	-	-
GSX-E	750		-	0,6	DR8ES-L	2923	Q218	DR8EIX	6681
GSX-ET,EX,EZ	750		-	0,7	DR8ES-L	2923	Q218	DR8EIX	6681
GSX-F-K/L/M/N/P/R/S/F/T/V	750	4	1989-1997	0,7	JR9C	6193	-	-	-
GSX-F-W, X, Y, K1, K5	750	4	1998-	0,7	CR9EK	4548	Q230	CR9EIX	3521
GSX-Inazuma (X,Y,K1)	750		1998-	0,7	CR9EK	4548	Q230	CR9EIX	3521
GSX-R-K6	750	4	2006-	0,7	CR9E	6263	Q227	CR9EIX	3521
GSX-R-K8	750	4	2008-	0,9	CR9EIA-9	6289	-	-	-
GSX-R-R Racing (K)	750	4	1989-	0,7	CR10EK	2360	-	CR10EIX	6482
GSX-R-SPR	750	4	1994-	0,7	CR9E	6263	Q227	CR9EIX	3521
GSX-R-T,V,W,X,Y, K1-K7	750	4	1996-1999	0,6	CR9E	6263	Q227	CR9EIX	3521
GSX-R-W (N,P,R,S)	750	4	1992-1995	0,7	CR10EK	2360	-	CR10EIX	6482
VS-GL S	750		1995-	0,9	DPR8EA-9	4929	Q221	DPR8EIX-9	2202
DR-SL,SM,SN,P,R,S,T,V	800		1990-1997	0,9	DPR9EA-9	5329	Q222	DPR9EIX-9	5545
M-Intruder	800	2	2009-	0,6	DR7EA	7839	-	DR7EIX	5686
VL-CL1 Intruder	800	2	2011-	0,6	DR7EA	7839	-	DR7EIX	5686
VL-Volusia (K1)	800	2	2001-	0,9	DPR7EA-9	5129	Q220	DPR7EIX-9	7803
VS-GL Intruder (N,P,R,S,W,X)	800		1991-2001	0,9	DPR8EA-9	4929	Q221	DPR8EIX-9	2202
VX-L/M/(CHOPPER)/N/P/R/T	800		1990-1996	0,9	DPR8EA-9	4929	Q221	DPR8EIX-9	2202
VZ-L1 Intruder M800	800	2	2009-	0,6	DR7EA	7839	-	DR7EIX	5686
VZ-Marauder (V,W,X)	800		1997-2001	0,9	DPR8EA-9	4929	Q221	DPR8EIX-9	2202
VZ-U K5 Intruder M800	800		2005-	0,9	DPR7EA-9	5129	Q220	DPR7EIX-9	7803
GS-GLT	850		-	0,7	B8ES	2411	Q201	BR8EIX	5044
RF-RR / RS / RS2	900		1994-1995	0,8	CR9E	6263	Q227	CR9EIX	3521
DL-V-Strom	1000	2	2002-	0,7	CR8EK	3478	-	CR8EIX	4218
DL-V-Strom	1000	2	2013-	0,9	CR8EIA-9	4286	-	-	-
GSX-R	1000	4	2005-2007	0,7	CR9E	6263	Q227	CR9EIX	3521
GSX-R-K1, K6	1000	4	2000-2005	0,7	CR9E	6263	Q227	CR9EIX	3521
GSX-R-K7	1000	4	2007-	0,9	CR9EIA-9	6289	-	-	-
SV-Classic	1000	2	2008-	0,7	CR8EK	3478	-	CR8EIX	4218
SV-N & S	1000	2	2003-	0,7	CR8EK	3478	-	CR8EIX	4218
TL-S (V,W,X,Y) / R (W,X,Y,K1)	1000		1997-2003	0,7	CR8EK	3478	-	CR8EIX	4218
GS-G / GG (GU71A) / GT	1100		-	0,8	B8ES	2411	Q201	BR8EIX	5044
GSF-Bandit N & S (T,V,W,X)	1200	4	1996-2002	0,7	JR9B	3188	Q224	-	-
GSF-Bandit N & S (Y,K1)	1200	4	1996-2002	0,7	JR9B	3188	Q224	-	-
GSF-K6	1200	4	2006-	0,7	JR9B	3188	Q224	-	-
GSX-Inazuma (X,Y)	1200	4	1999-	0,7	JR8B	7237	-	-	-
GSF-Bandit	1250	4	2008-	0,8	CR7E	4578	Q225	CR7EIX	7385
GSX-FA	1250	4	2010-	0,6	CR7E	4578	Q225	CR7EIX	7385
GSX-B-King	1300	4	2007-	0,8	CR9E	6263	Q227	CR9EIX	3521
GSX-B-King	1300	4	2008-	0,9	CR9EIA-9	6289	-	-	-
GSX-R-Hayabusa	1300	4	2008-	0,9	CR9EIA-9	6289	-	-	-

* Bitte Elektrodenabstand nach Angaben des Herstellers justieren

* Please adjust the groundelectrode gap

* Veuillez vérifier l' écartement

* Por favor, ajustar distancia entre electrodos

* regolare il gap

C
Y
I

0201



Stock-№

Quick-№



Stock-№ IX

SUZUKI

GSX-R-Hayabusa (X,Y,K1)	1300	4	1999-2007	0,7	CR9E	6263	Q227	CR9EIX	3521
GSX	1400	4	2001-	0,7	CR8EK	3478	-	CR8EIX	4218
VS-GLP (H,J,K,L,M,N,P,R,S)	1400	2	1987-1995	0,9	DPR8EA-9	4929	Q221	DPR8EIX-9	2202
VS-GLP Intruder	1400	2	2001-	0,9	DPR8EA-9	4929	Q221	DPR8EIX-9	2202
VS-GLP Intruder (T,V,W,X)	1400	2	1996-1998	0,9	DPR8EA-9	4929	Q221	DPR8EIX-9	2202
C-Intruder T	1500	2	2013-	0,9	CPR6EA-9	6899	-	-	-
VL-Intruder Legend. Classic (W,X,K1)	1500	2	1998-	0,9	DPR7EA-9	5129	Q220	DPR7EIX-9	7803
Marauder	1600	2	2003-	0,9	DPR6EA-9	5531	-	-	-
M-Intruder R / R / R2	1800	2	2006-	0,7	CR8EK	3478	-	CR8EIX	4218
VZR-Intruder ZUF L1 / MR UF L1	1800		2011-	0,7	CR8EK	3478	-	CR8EIX	4218
DR-SM	125		2008-	0,7	DR8EA	7162	-	DR8EIX	6681
VZ-L0 Intruder M1500	1500		2009-	0,7	CR6E	6965	-	-	-
VZ-K4-K5	1600		2003-2004	0,9	DPR6EA-9	5531	-	-	-
VLR1800 C1800R/RT Intruder	1800		2008-	0,7	CR8EK	3478	-	CR8EIX	4218
GW-L2 Inazuma	250		2012-	0,7	CR7E	4578	Q225	CR7EIX	7385
PE-B/C	250		-	0,5	B8EG	3430	-	-	-
RMX-RP, T	250		-	0,6	B9EGV	5827	-	-	-
RM-Z-K4-K5 4T	250		2004-2006	0,7	CR8EB	7784	-	CR8EIX	4218
GSX-F-J, K, L, M, N, P, R, S, V	600		1988-1995	0,7	DR8ES	5423	Q217	DR8EIX	6681
DL-AL2 V-Strom 650 ABS Twin Spark	650	2	2011-	0,9	CR8EIA-9	4286	-	-	-
DR-RSE Models and RE models	650		1991-1995	0,9	DPR9EA-9	5329	Q222	DPR9EIX-9	5545

SYM

City Hopper	50		1998-2003	0,6	BR8HSA	5539	-	BR8HIX	7001
DD	50	1	2005-	0,7	BR8HSA	5539	-	BR8HIX	7001
DD50 City Trek / Sport	50	1	2002-	0,6	BR8HSA	5539	-	BR8HIX	7001
Fancy / Flash / Free	50	1	1996-	0,7	BR8HSA	5539	-	BR8HIX	7001
Fiddle	50	1	1998-	0,6	BR8HSA	5539	-	BR8HIX	7001
Fiddle II 50	50		2008-	0,7	BR8HSA	5539	-	BR8HIX	7001
Jet	50	1	1996-	0,7	BR8HSA	5539	-	BR8HIX	7001
Jet 50 BasiX	50	1	-	0,6	BR8HSA	5539	-	BR8HIX	7001
Jet 50 Euro X	50	1	-	0,6	BR8HSA	5539	-	BR8HIX	7001
Jet 50 Sport X R	50	1	-	0,6	BR8HSA	5539	-	BR8HIX	7001
Jet 50 Sport X S	50	1	2006-	0,7	BR8HSA	5539	-	BR8HIX	7001
Jet 50 Sport X SE	50	1	2006-	0,7	BR8HSA	5539	-	BR8HIX	7001
Jet 50 Sport X SR	50	1	2006-	0,7	BR8HSA	5539	-	BR8HIX	7001
Jet 50 Sport X XS	50	1	2006-	0,7	BR8HSA	5539	-	BR8HIX	7001
Jungle	50	1	1999-	0,7	BR8HSA	5539	-	BR8HIX	7001
Mask	50	1	2000-	0,7	BR8HSA	5539	-	BR8HIX	7001
Mio	50		2005-	0,7	CR6HSA	2983	-	CR6HIX	7274
Orbit 50	50	1	-	0,6	CR7HSA	4549	-	CR7HIX	7544
Pure 50	50	1	1996-	0,6	BR8HSA	5539	-	BR8HIX	7001
Red Devil	50	1	1999-	0,7	BR8HSA	5539	-	BR8HIX	7001
RS	50	1	2005-	0,6	BR8HSA	5539	-	BR8HIX	7001
RS-Shark	50	1	-	0,6	BR8HSA	5539	-	BR8HIX	7001
Shark	50	1	2000-	0,7	BPR8HS	3725	-	BPR8HIX	6742
Simphony	50	1	2009-	0,7	CR7HSA	4549	-	CR7HIX	7544
Simply	50	1	2009-	0,7	CR7HSA	4549	-	CR7HIX	7544
SK	50	1	2000-	0,7	BR8HSA	5539	-	BR8HIX	7001

* Bitte Elektrodenabstand nach Angaben des Herstellers justieren

* Please adjust the groundelectrode gap

* Veuillez vérifier L' écartement

* Por favor, ajustar distancia entre electrodos

* regolare il gap

C
Y
I

Stock-No

Quick-No



Stock-No IX

SYM

Super Fancy	50		1998-2003	0,6	BR8HSA	5539	-	BR8HIX	7001
Jet	100		1999-	0,6	BR8HSA	5539	-	BR8HIX	7001
Jet 100 Sport X S/SR Jet	100		-	0,6	BR8HSA	5539	-	BR8HIX	7001
Mio	100		-	0,7	CR6HSA	2983	-	CR6HIX	7274
Attila	125		1998-2000	0,6	CR7HSA	4549	-	CR7HIX	7544
CT	125	1	2004-	0,7	DR8EA	7162	-	DR8EIX	6681
Euro MX	125	1	2001-	0,7	CR8E	1275	Q226	CR8EIX	4218
Euro MX 125 4V	125	1	2005-	0,7	CR8E	1275	Q226	CR8EIX	4218
Fiddle II	125		2008-	0,6	CR7HSA	4549	-	CR7HIX	7544
GTS	125	1	2006-	0,7	CR8E	1275	Q226	CR8EIX	4218
GTS-E2	125	1	-	0,7	CR8E	1275	Q226	CR8EIX	4218
GTS-E3	125	1	-	0,7	CR8E	1275	Q226	CR8EIX	4218
GTS-Voyager	125		2005-	0,8	CR8E	1275	Q226	CR8EIX	4218
HD	125	1	2004-	0,7	DR8EA	7162	-	DR8EIX	6681
HD	125	1	2005-2008	0,7	CR8E	1275	Q226	CR8EIX	4218
HD2	125		2010-	0,7	CR8E	1275	Q226	CR8EIX	4218
HD-Evo	125	1	2006-	0,7	CR8E	1275	Q226	CR8EIX	4218
Husky	125	1	2002-	0,7	DR8EA	7162	-	DR8EIX	6681
Joyride	125	1	2002-	0,7	CR8E	1275	Q226	CR8EIX	4218
Joyride	125	1	2003-2004	0,6	CR7HSA	4549	-	CR7HIX	7544
Joyride 125 E2/3 / Evo	125	1	2005-	0,7	CR8E	1275	Q226	CR8EIX	4218
Megalo 125	125		2001-	0,6	CR7HSA	4549	-	CR7HIX	7544
Orbit	125	1	-	0,6	CR7HSA	4549	-	CR7HIX	7544
RS-4V	125	1	2005-	0,7	CR8E	1275	Q226	CR8EIX	4218
Shark 125	125		1999-2005	0,8	CR8E	1275	Q226	CR8EIX	4218
Shark 125 R	125		1999-2005	0,8	CR8E	1275	Q226	CR8EIX	4218
Simphony	125	1	2009-	0,7	CR7HSA	4549	-	CR7HIX	7544
Simply	125	1	2009-	0,7	CR7HSA	4549	-	CR7HIX	7544
SK	125	1	2001-	0,7	CR8E	1275	Q226	CR8EIX	4218
Super Duke	125		1996-	0,6	CR7HSA	4549	-	CR7HIX	7544
Voyager	125		-	0,7	CR8E	1275	Q226	CR8EIX	4218
VS	125		2006-	0,7	CR8E	1275	Q226	CR8EIX	4218
Wolf	125	1	2005-2009	0,7	DR8EA	7162	-	DR8EIX	6681
Wolf	125	1	2010-	0,7	DR7EA	7839	-	DR7EIX	5686
XS-K	125	1	-	0,7	DR8EA	7162	-	DR8EIX	6681
Fiddle II	150		2010-	0,7	CR7HSA	4549	-	CR7HIX	7544
Joyride 150	150	1	-	0,7	CR8E	1275	Q226	CR8EIX	4218
Symphony	150		2010-	0,7	CR7HSA	4549	-	CR7HIX	7544
VS	150	1	2007-	0,7	CR8E	1275	Q226	CR8EIX	4218
HD Orbit 180	180		2004-	0,7	CR8E	1275	Q226	CR8EIX	4218
Joyride 180	180		2002-	0,7	CR8E	1275	Q226	CR8EIX	4218
HD	200	1	2005-	0,7	CR8E	1275	Q226	CR8EIX	4218
HD 2	200	1	2010-	0,8	CR7E	4578	Q225	CR7EIX	7385
Joyride	200		2005-	0,7	CR8E	1275	Q226	CR8EIX	4218
Maxsym	200	1	2010-	0,7	CR8E	1275	Q226	CR8EIX	4218
GTS-250	250	1	2006-	0,7	CR8E	1275	Q226	CR8EIX	4218
GTS-250 E2	250	1	-	0,7	CR8E	1275	Q226	CR8EIX	4218
GTS-250i E3	250	1	-	0,7	CR8E	1275	Q226	CR8EIX	4218
Joymax	250	1	2006-	0,7	CR8E	1275	Q226	CR8EIX	4218
Citycom i	300		2008-	0,7	CR8E	1275	Q226	CR8EIX	4218
GTS	300		-	0,7	CR8E	1275	Q226	CR8EIX	4218
Joymax Evo	300	1	2008-	0,7	CR8E	1275	Q226	CR8EIX	4218

* Bitte Elektrodenabstand nach Angaben des Herstellers justieren

* Please adjust the groundelectrode gap

* Veuillez vérifier L' écartement

* Por favor, ajustar distancia entre electrodos

* regolare il gap

C
Y
L

0201



Stock-№

Quick-№



Stock-№ IX

SYM									
MaxSym	400		2010-	0,7	CR8E	1275	Q226	CR8EIX	4218
GT	500	1	2004-	0,6	CR7EKB	4455	-	CR7EIX	7385
XP	500	1	2004-	0,6	CR7EKB	4455	-	CR7EIX	7385

TGB (TAIWAN GOLDEN BEE)									
202 Classic	50		2002-	0,5	BPR7HS	6422	Q215	BPR7HIX	5944
202T (Big Wheels)	50	1	1998-	0,7	BPR7HS	6422	Q215	BPR7HIX	5944
302 Sport	50	1	2002-	0,7	BPR7HS	6422	Q215	BPR7HIX	5944
303 R Hawk	50	1	2002-	0,7	BPR7HS	6422	Q215	BPR7HIX	5944
AKROStec	50	1	2003-2005	0,7	BPR7HS	6422	Q215	BPR7HIX	5944
Bunny AS 50 X	50	1	-	0,6	BP6HS	4511	-	BPR6HIX	4085
Delivery	50	1	2003-	0,7	BPR7HS	6422	Q215	BPR7HIX	5944
Ergon	50	1	1998-	0,7	BPR7HS	6422	Q215	BPR7HIX	5944
KBX 50	50	1	-	0,6	BP6HS	4511	-	BPR6HIX	4085
R50X	50	1	2005-	0,7	BPR7HS	6422	Q215	BPR7HIX	5944
202T (Palio)	125	1	1998-	0,7	CR7HSA	4549	-	CR7HIX	7544
204 Classic	125	1	2002-2007	0,7	CR7HSA	4549	-	CR7HIX	7544
303 R	125		-	0,7	CR7HSA	4549	-	CR7HIX	7544
303 R Hawk	125		2007-	0,7	CR7HSA	4549	-	CR7HIX	7544
304 Sport	125		2002-	0,7	CR7HSA	4549	-	CR7HIX	7544
309 RS	125		-	0,7	CR7HSA	4549	-	CR7HIX	7544
404 Executive	125		2002-2007	0,7	CR7HSA	4549	-	CR7HIX	7544
Delivery	125		2005-	0,7	CR7HSA	4549	-	CR7HIX	7544
F409 / Laser	125		-	0,7	CR7HSA	4549	-	CR7HIX	7544
R125X	125		2008-	0,7	CR7HSA	4549	-	CR7HIX	7544
303R / 309RS	150		-	0,7	CR7HSA	4549	-	CR7HIX	7544
F409 / Laser	150		-	0,7	CR7HSA	4549	-	CR7HIX	7544

TITAN									
Coyote	1573	2	1997-2003	0,7	BPR5ES	7422	-	BPR5EIX	6597
Fat Bobber S&S engine	1573	2	2008-	1,1	BPR5ES-11	4424	-	BPR5EIX-11	2115
Gecko	1573	2	1997-2003	0,7	BPR5ES	7422	-	BPR5EIX	6597
Roadrunner	1573	2	1997-2003	0,7	BPR5ES	7422	-	BPR5EIX	6597
Scorpion	1573	2	1997-2003	0,7	BPR5ES	7422	-	BPR5EIX	6597
Sidewinder	1573	2	1997-2003	0,7	BPR5ES	7422	-	BPR5EIX	6597
Custom Pro Street S&S engine	1753	2	-	1,1	BPR5ES-11	4424	-	BPR5EIX-11	2115

TM									
Cross & Enduro	80	1	1994-	0,6	BR9EG	3230	-	-	-
Cross & Enduro	125	1	1994-	0,6	BR9EG	3230	-	-	-
EN	125	1	2003-	0,6	BR9EG	3230	-	-	-
MX-Racing 2 Stroke	125	1	2005-	0,6	BR9EG	3230	-	-	-
Cross & Enduro	250	1	1994-	0,6	BR8EG	3130	-	-	-
EN	250	1	2003-	0,6	BR8EG	3130	-	-	-
EN-2 Stroke	250	1	2005-	0,6	BR8EG	3130	-	-	-
EN-4 Stroke	250	1	2005-	0,7	CR8E	1275	Q226	CR8EIX	4218
EN-Cross & Enduro 4 Stroke	250		2001-	0,7	CR8E	1275	Q226	CR8EIX	4218
EN-EN-F	250	1	2003-	0,7	CR8E	1275	Q226	CR8EIX	4218
Cross & Enduro	300		1994-	0,6	BR9EG	3230	-	-	-
EN	300	1	2003-	0,6	BR8EG	3130	-	-	-

* Bitte Elektrodenabstand nach Angaben des Herstellers justieren

* Please adjust the groundelectrode gap

* Veuillez vérifier L' écartement

* Por favor, ajustar distancia entre electrodos

* regolare il gap

C
Y
L

0201



Stock-No

Quick-No



Stock-No IX

TM

Cross & Enduro 4 Stroke	400		2002-	0,7	CR8E	1275	Q226	CR8EIX	4218
EN-4 Stroke	450	1	2005-	0,7	CR8E	1275	Q226	CR8EIX	4218
EN-F	450	1	2003-	0,7	CR8E	1275	Q226	CR8EIX	4218
MX-Racing 4 Stroke	450		2005-	0,7	CR8E	1275	Q226	CR8EIX	4218
EN-4 Stroke	530		2005-	0,7	CR8E	1275	Q226	CR8EIX	4218
MX-Racing 4 Stroke	530		2005-	0,7	CR8E	1275	Q226	CR8EIX	4218

TORROT

Ciclomatic / 2VL	50	1	-	0,5	B7HS	5110	Q204	BR7HIX	7067
City CX/N/SL/X	50	1	-	0,5	B7HS	5110	Q204	BR7HIX	7067
City L/2V/2V-TT	50	1	-	0,5	B6HS	4510	Q203	BR6HIX	3419
Cycloscooter S50/HL	50	1	-	0,5	B6HS	4510	Q203	BR6HIX	3419
Gran Cross, Maxi, Mini	50	1	-	0,5	B5HS	4210	-	-	-
Mustang, Panther, Tiburon	50	1	-	0,5	B5HS	4210	-	-	-
Sport Sachs TX50, TT50	50	1	-	0,5	B7HS	5110	Q204	BR7HIX	7067
Super Cross/Rally Sachs	50	1	-	0,5	B7HS	5110	Q204	BR7HIX	7067
Trial, Turismo	50	1	-	0,5	B5HS	4210	-	-	-

TRIUMPH

Twins with 3/4"	250		-	0,6	B8ES	2411	Q201	BR8EIX	5044
Daytona 600	600	4	2004-	0,7	CR9EK	4548	Q230	CR9EIX	3521
Speed Triple S / Speed Four	600	4	2002-	0,7	CR9EK	4548	Q230	CR9EIX	3521
TT-Supersport	600	4	2000-	0,7	CR9EK	4548	Q230	CR9EIX	3521
Daytona	650	4	2005-	0,7	CR9EK	4548	Q230	CR9EIX	3521
Daytona	675	3	2006-	0,7	CR9EK	4548	Q230	CR9EIX	3521
Daytona	675	3	2013-	0,9	CR9EIA-9	6289	-	-	-
Daytona R	675	3	-	0,7	CR9EK	4548	Q230	CR9EIX	3521
Daytona R	675	3	2013-	0,9	CR9EIA-9	6289	-	-	-
Speed Triple R	675	3	2008-	0,7	CR9EK	4548	Q230	CR9EIX	3521
Street Triple	675	3	-	0,7	CR9EK	4548	Q230	CR9EIX	3521
Bonneville T140D/E	750		-	0,5	B6ES	7310	-	-	-
Hurricane TRX75	750	3	-	0,5	B8ES	2411	Q201	BR8EIX	5044
Tiger TR7RV, TR7V	750		-	0,5	B8ES	2411	Q201	BR8EIX	5044
Trident T150V, T160	750		-	0,5	B8ES	2411	Q201	BR8EIX	5044
Trident, Daytona	750	3	1991-1998	0,9	DPR9EA-9	5329	Q222	DPR9EIX-9	5545
TSX8, TSS	750		-	0,6	C8E	7471	-	CR8EIX	4218
America	790	2	2005-	0,9	DPR8EA-9	4929	Q221	DPR8EIX-9	2202
Bonneville T100 / America	790	2	2001-	0,9	DPR8EA-9	4929	Q221	DPR8EIX-9	2202
Speedmaster	790	2	2001-	0,9	DPR8EA-9	4929	Q221	DPR8EIX-9	2202
Tiger	790	2	1991-1998	0,9	DPR8EA-9	4929	Q221	DPR8EIX-9	2202
Bonneville	800	2	2001-	0,9	DPR8EA-9	4929	Q221	DPR8EIX-9	2202
Tiger	800	3	2010-	0,7	CR9EK	4548	Q230	CR9EIX	3521
Tiger XC	800	3	2010-	0,7	CR9EK	4548	Q230	CR9EIX	3521
America	865	2	2007-	0,9	DPR8EA-9	4929	Q221	DPR8EIX-9	2202
America LT	865	2	-	0,9	DPR8EA-9	4929	Q221	DPR8EIX-9	2202
Bonneville / Black	865	2	2007-	0,9	DPR8EA-9	4929	Q221	DPR8EIX-9	2202
Bonneville T100	865	2	2005-	0,9	DPR8EA-9	4929	Q221	DPR8EIX-9	2202
Scrambler	865	2	2006-	0,9	DPR8EA-9	4929	Q221	DPR8EIX-9	2202
Speedmaster	865	2	2005-	0,9	DPR8EA-9	4929	Q221	DPR8EIX-9	2202
Thrupton 900 /SE	865	2	2004-	0,9	DPR8EA-9	4929	Q221	DPR8EIX-9	2202
T509 Speed Triple	885		1996-1998	0,9	DPR8EA-9	4929	Q221	DPR8EIX-9	2202

* Bitte Elektrodenabstand nach Angaben des Herstellers justieren

* Please adjust the groundelectrode gap

* Veuillez vérifier L' écartement

* Por favor, ajustar distancia entre electrodos

* regolare il gap

C
Y
L

0201



Stock-№

Quick-№



Stock-№ IX

TRIUMPH

T709 Tiger	885		1998-	0,9	DPR8EA-9	4929	Q221	DPR8EIX-9	2202
Thunderbird	885	3	1995-2004	0,9	DPR8EA-9	4929	Q221	DPR8EIX-9	2202
Adventurer	900	3	1996-	0,9	DPR8EA-9	4929	Q221	DPR8EIX-9	2202
Daytona / Super III	900		1991-1996	0,9	DPR9EA-9	5329	Q222	DPR9EIX-9	5545
Légend TT	900	3	2000-	0,9	DPR8EA-9	4929	Q221	DPR8EIX-9	2202
Scrambler	900	2	2006-	0,9	DPR8EA-9	4929	Q221	DPR8EIX-9	2202
Speed Triple	900	3	1994-1997	0,9	DPR9EA-9	5329	Q222	DPR9EIX-9	5545
Speedmaster	900	2	2005-	0,9	DPR8EA-9	4929	Q221	DPR8EIX-9	2202
Sprint, Executive, Sport	900		-	0,9	DPR9EA-9	5329	Q222	DPR9EIX-9	5545
Thruxton	900	2	2004-	0,9	DPR8EA-9	4929	Q221	DPR8EIX-9	2202
Thunderbird	900	3	1995-	0,9	DPR9EA-9	5329	Q222	DPR9EIX-9	5545
Thunderbird Sport	900	3	2000-	0,9	DPR9EA-9	5329	Q222	DPR9EIX-9	5545
Tiger	900	3	1993-2000	0,9	DPR9EA-9	5329	Q222	DPR9EIX-9	5545
Trident	900	3	1991-	0,9	DPR9EA-9	5329	Q222	DPR9EIX-9	5545
Trophy	900	3	1991-	0,9	DPR9EA-9	5329	Q222	DPR9EIX-9	5545
i Daytona	955	3	2001-	0,7	CR9EK	4548	Q230	CR9EIX	3521
i Sprint ST / RS	955	3	1999-2000	0,9	DPR9EA-9	5329	Q222	DPR9EIX-9	5545
i Tiger	955	3	2001-	0,9	DPR9EA-9	5329	Q222	DPR9EIX-9	5545
Speed Triple	955		2002-2004	0,6	CR9EK	4548	Q230	CR9EIX	3521
Sprint RS	955	3	2001-2005	0,6	CR9EK	4548	Q230	CR9EIX	3521
T509-i Speed Triple	955	3	1998-2001	0,9	DPR9EA-9	5329	Q222	DPR9EIX-9	5545
T595-Daytona	955	3	1997-1999	0,9	DPR9EA-9	5329	Q222	DPR9EIX-9	5545
T595-i Daytona / Centenary	955	3	2000-	0,9	DPR9EA-9	5329	Q222	DPR9EIX-9	5545
Daytona	1000		1991-	0,9	DPR9EA-9	5329	Q222	DPR9EIX-9	5545
GT-Sprint	1050	3	2010-	0,7	CR8EK	3478	-	CR8EIX	4218
HM	1050	3	2007-	0,7	CR9EK	4548	Q230	CR9EIX	3521
Speed Triple	1050	3	2005-	0,7	CR9EK	4548	Q230	CR9EIX	3521
ST-Sprint, ABS	1050	3	2005-	0,7	CR9EK	4548	Q230	CR9EIX	3521
Tiger	1050	3	2006-	0,7	CR9EK	4548	Q230	CR9EIX	3521
Tiger Sport	1050	3	2013-	0,7	CR8EK	3478	-	CR8EIX	4218
Daytona	1200	4	1992-	0,9	DPR9EA-9	5329	Q222	DPR9EIX-9	5545
Tiger Explorer	1200	3	2012-	0,7	CR8EK	3478	-	CR8EIX	4218
Trophy	1200	4	1991-	0,9	DPR9EA-9	5329	Q222	DPR9EIX-9	5545
Trophy (Incl. SE)	1200	3	2012-	0,7	CR8EK	3478	-	CR8EIX	4218
Thunderbird	1600	2	2009-	0,9	DPR6EA-9	5531	-	-	-
Thunderbird Storm	1700	2	2011-	0,9	DPR6EA-9	5531	-	-	-
Rocket III GT	2300	3	2007-	0,9	DPR8EA-9	4929	Q221	DPR8EIX-9	2202
Rocket III Twinspark	2300	3	2004-	0,9	DPR8EA-9	4929	Q221	DPR8EIX-9	2202

URAL AMERICA

Bavarian Classic	650		1999-	*	-	-	-	BPR8HIX	6742
Deco Classic	650		1997-1998	0,7	BP7HS	5111	-	BPR7HIX	5944
Deco Classic	650		1999-	*	-	-	-	BPR8HIX	6742
Deco Cruiser	650		1998-	0,7	BP7HS	5111	-	BPR7HIX	5944
Italia Cruiser	650		1994-1997	0,7	BP7HS	5111	-	BPR7HIX	5944
Italia Cruiser II	650		1998-	0,7	BP7HS	5111	-	BPR7HIX	5944
Patrol Classic	650		1999-	*	-	-	-	BPR8HIX	6742
Solo Classic	650		1999-	*	-	-	-	BPR8HIX	6742
Solo Cruiser	650		1998-	0,7	BP7HS	5111	-	BPR7HIX	5944
Solo Single	650		1994-1997	0,7	BP7HS	5111	-	BPR7HIX	5944
Sportsman	650		1994-1996	0,7	BP7HS	5111	-	BPR7HIX	5944
Sportsman Classic	650		1997-1998	0,7	BP7HS	5111	-	BPR7HIX	5944

* Bitte Elektrodenabstand nach Angaben des Herstellers justieren

* Please adjust the groundelectrode gap

* Veuillez vérifier L' écartement

* Por favor, ajustar distancia entre electrodos

* regolare il gap

C
Y
L

Stock-No

Quick-No



Stock-No IX

URAL AMERICA

Tourist Classic	650		1997-1998	0,7	BP7HS	5111	-	BPR7HIX	5944
Tourist Classic	650		1999-	*	-	-	-	BPR8HIX	6742

URAL RETRO

Cruiser, Classic	648		1997-	0,6	BP4HS	3611	-	-	-
IMZ-10 / 40 / 50	650		-	0,6	BP4HS	3611	-	-	-
M3-8.103 (23.6kW)	650		-	0,7	BP6ES	7811	-	BPR6EIX	6637
Solo Single, Sportsman	650		1994-1996	0,6	BP4HS	3611	-	-	-
Tourist	745	2	-	0,5	B7HS	5110	Q204	BR7HIX	7067

V.O.R.

EN-Enduro	400	1	2000-	0,6	CR7EK	7546	-	CR7EIX	7385
MX-Cross	400	1	2000-	0,6	CR7EK	7546	-	CR7EIX	7385
SM-Super Motard	400	1	2000-	0,6	CR7EK	7546	-	CR7EIX	7385
ENE	450	1	2004-	0,7	CR8EK	3478	-	CR8EIX	4218
EN-Enduro	450	1	2000-	0,6	CR7EK	7546	-	CR7EIX	7385
EN-MAR	450	1	2004-	0,7	CR8EK	3478	-	CR8EIX	4218
MX-Cross	450	1	2000-	0,6	CR7EK	7546	-	CR7EIX	7385
C-Cross	500	1	2002-	0,7	CR8EK	3478	-	CR8EIX	4218
E-Enduro	501	1	2002-	0,7	CR8EK	3478	-	CR8EIX	4218
S-Super Motard	501	1	2002-	0,7	CR8EK	3478	-	CR8EIX	4218
SM-Super Motard	503	1	1999-	0,6	CR7EK	7546	-	CR7EIX	7385
SM-Super Moto Competition	503	1	1999-	0,7	CR8EK	3478	-	CR8EIX	4218
ENE-EN-MAR	530	1	2004-	0,7	CR8EK	3478	-	CR8EIX	4218
EN-Enduro	530	1	1999-	0,6	CR7EK	7546	-	CR7EIX	7385
MX-Cross	530	1	2001-	0,6	CR7EK	7546	-	CR7EIX	7385
SM-Super Motard Competition	530	1	1999-	0,6	CR7EK	7546	-	CR7EIX	7385

VELOSOLEX

2200/ 3300/ 3800/ 5000/ 6000	50	1	-	0,5	B-4H	4110	-	-	-
8000 / GS Ténor	50	1	-	0,5	B6HS	4510	Q203	BR6HIX	3419
GL Ténor / GR Ténor	50	1	-	0,5	B6HS	4510	Q203	BR6HIX	3419
Micron / Pli-solex	50	1	-	0,5	B-4H	4110	-	-	-
Ténor L/R/S	50	1	-	0,5	B6ES	7310	-	-	-

VERTEMATI

C-Cross	500	1	2002-	0,7	CR8EK	3478	-	CR8EIX	4218
SR-501	500		-	0,7	CR9EK	4548	Q230	CR9EIX	3521
E-Enduro	501	1	2002-	0,7	CR8EK	3478	-	CR8EIX	4218
S-Super Motard	501	1	2002-	0,7	CR8EK	3478	-	CR8EIX	4218
E 450	503	1	-	0,7	CR9EK	4548	Q230	CR9EIX	3521
E 450 E	503	1	-	0,7	CR9EK	4548	Q230	CR9EIX	3521
E 501	503	1	-	0,7	CR9EK	4548	Q230	CR9EIX	3521
E 501 E	503	1	-	0,7	CR9EK	4548	Q230	CR9EIX	3521
E 570	503	1	-	0,7	CR9EK	4548	Q230	CR9EIX	3521
E 570 E	503	1	-	0,7	CR9EK	4548	Q230	CR9EIX	3521
S-570	570		2003-	0,7	CR9EK	4548	Q230	CR9EIX	3521

* Bitte Elektrodenabstand nach Angaben des Herstellers justieren

* Please adjust the groundelectrode gap

* Veuillez vérifier L' écartement

* Por favor, ajustar distancia entre electrodos

* regolare il gap

C
y
l

0201



Stock-№

Quick-№



Stock-№ IX

VICTORY

V92C and all 92 cu.inch models	1507		1999-2001	1,0	DCPR6E	3481	-	DCPR6EIX	8196
V92C and all 92 cu.inch models	1507		2002-2004	0,8	CPR6EB-9	5958	-	-	-
Hammer	1634	2	2006-	0,9	CPR6EB-9	5958	-	-	-
Kingpin	1634	2	2008-	1,0	DCPR6E	3481	-	-	-
Kingpin 8-Ball	1634		2008-	1,0	DCPR6E	3481	-	-	-
Ness Signature Jackpot 100cu in / Freedom	1634		2006-	0,9	CPR6EB-9	5958	-	-	-
Touring Cruiser	1634	2	2006-	0,9	CPR6EB-9	5958	-	-	-
Vegas / Jackpot / 8-Ball	1634	2	2006-	0,9	CPR6EB-9	5958	-	-	-
Cross Country	1700	2	2011-	0,9	DCPR6E	3481	-	DCPR6EIX	8196
Hammer / 8-Ball / S Suede	1700	2	2011-	0,9	DCPR6E	3481	-	DCPR6EIX	8196
Jackpot	1700	2	2011-	0,9	DCPR6E	3481	-	DCPR6EIX	8196
Vision Tour ABS	1700	2	2011-	0,9	DCPR6E	3481	-	DCPR6EIX	8196
Zach Ness Cross Vegas SL	1700	2	2011-	0,9	DCPR6E	3481	-	DCPR6EIX	8196
Arlen Ness Vision, Cory Ness Jackpot	1731		2010-	0,8	DCPR6E	3481	-	DCPR6EIX	8196
Broadwalk	1731		2013-	0,8	DCPR6E	3481	-	-	-
Cross Country, Cross Country Tour, Cross Roads, Jackpot, Vision 8-Ball	1731	2	2008-	0,8	DCPR6E	3481	-	DCPR6EIX	8196
Hammer S	1731	2	2011-	0,9	DCPR6E	3481	-	DCPR6EIX	8196
Vision	1731		2008-	0,8	DCPR6E	3481	-	-	-
8-Ball	1500		2005-	0,9	CPR6EB-9	5958	-	-	-
Classic Cruiser	1500		2003-	0,9	CPR6EB-9	5958	-	-	-
Cruiser	1500		2002-	0,9	CPR6EB-9	5958	-	-	-
Hammer	1500		2005-	0,9	CPR6EB-9	5958	-	-	-
Kingpin	1500		2004-2005	0,9	CPR6EB-9	5958	-	-	-
Kingpin Ness Signature	1500		2005-	0,9	CPR6EB-9	5958	-	-	-
Special Edition	1500		2000-	1,0	DCPR6E	3481	-	-	-
Sport Cruiser	1500		2000-2001	1,0	DCPR6E	3481	-	-	-
Standard Cruiser	1500		1999-2002	1,0	DCPR6E	3481	-	-	-
Touring Cruiser	1500		2000-2001	1,0	DCPR6E	3481	-	-	-
Touring Cruiser	1500		2002-2005	0,9	CPR6EB-9	5958	-	-	-
Vegas	1500		2003-2005	0,9	CPR6EB-9	5958	-	-	-
Vegas ANSS	1500		2004-	0,9	CPR6EB-9	5958	-	-	-
Vegas Ness Signature	1500		2005-	0,9	CPR6EB-9	5958	-	-	-

WUYANG

WY50QT Scooter	50		2006-	0,6	C7HSA	4629	-	CR7HIX	7544
WY125-12	125		2006-	0,9	DPR8EA-9	4929	Q221	DPR8EIX-9	2202
WY125-16C	125		2006-	0,9	DPR8EA-9	4929	Q221	DPR8EIX-9	2202
WY125-24B Cub	125		2006-	0,6	C7HSA	4629	-	CR7HIX	7544

XISPA

X125R	125		2007-2008	0,6	BP5ES	6511	-	BPR5EIX	6597
X250R	250		2007-2008	0,6	BP5ES	6511	-	BPR5EIX	6597
X280R	273		2007-2008	0,6	BP5ES	6511	-	BPR5EIX	6597

YAMAHA

BA-N / NH / S	50	1	2007-2007	0,7	BR7HS	4122	Q211	BR7HIX	7067
Beluga	50	1	-	1,0	BP7HS-10	7829	-	-	-
BW's-Bump	50	1	1996-	0,7	BR8HS	4322	Q212	BR8HIX	7001
BW's-CW50	50	1	1992-	0,7	BR8HS	4322	Q212	BR8HIX	7001
BW's-NG	50	1	1996-	0,7	BR8HS	4322	Q212	BR8HIX	7001
BW's-Original	50	1	1996-	0,7	BR8HS	4322	Q212	BR8HIX	7001

* Bitte Elektrodenabstand nach Angaben des Herstellers justieren

* Please adjust the groundelectrode gap

* Veuillez vérifier L' écartement

* Por favor, ajustar distancia entre electrodos

* regolare il gap



CYL



Stock-No

Quick-No



Stock-No IX

YAMAHA

BW's-R	50	1	1996-	0,7	BR8HS	4322	Q212	BR8HIX	7001
BW's-R 12	50	1	2001-	0,7	BR8HS	4322	Q212	BR8HIX	7001
BW's-Spy	50	1	1996-	0,7	BR8HS	4322	Q212	BR8HIX	7001
BX	50	1	2007-2007	0,7	CR8E	1275	Q226	CR8EIX	4218
BX-N	50	1	2007-2007	0,7	CR8E	1275	Q226	CR8EIX	4218
BX-S	50	1	2008-2008	0,7	CR8E	1275	Q226	CR8EIX	4218
CE	50	1	2007-2009	0,8	CR7E	4578	Q225	CR7EIX	7385
CE-D	50	1	2007-2009	0,8	CR7E	4578	Q225	CR7EIX	7385
CE-ZR	50	1	2009-2009	0,7	CR7E	4578	Q225	CR7EIX	7385
CR-Z	50	1	1993-	1,0	BP7HS-10	7829	-	-	-
CS	50	1	2009-2009	0,7	BR8HS	4322	Q212	BR8HIX	7001
CS-Z	50	1	2009-2009	0,7	BR8HS	4322	Q212	BR8HIX	7001
CT-S	50	1	-	1,0	BP7HS-10	7829	-	-	-
CT-SS	50	1	-	0,7	BP7HS	5111	-	BPR7HIX	5944
CV	50	1	2007-2007	0,7	BPR6HS	7022	Q214	BPR6HIX	4085
CV-A	50	1	2007-2007	0,6	BPR7HS	6422	Q215	BPR7HIX	5944
CV-R	50	1	2007-2007	0,7	BPR7HS	6422	Q215	BPR7HIX	5944
CV-Z2	50	1	2007-2007	0,7	BPR7HS	6422	Q215	BPR7HIX	5944
CV-ZR	50	1	2007-2007	0,7	BPR7HS	6422	Q215	BPR7HIX	5944
CW	50	1	2007-2009	0,7	BR8HS	4322	Q212	BR8HIX	7001
CW-L	50	1	2007-2009	0,7	BR8HS	4322	Q212	BR8HIX	7001
CW-LN	50	1	2008-2009	0,7	BR8HS	4322	Q212	BR8HIX	7001
CW-N	50	1	2007-2009	0,7	BR8HS	4322	Q212	BR8HIX	7001
CW-R	50	1	-	0,7	BR8HS	4322	Q212	BR8HIX	7001
CW-RS	50	1	2009-2009	0,7	BR8HS	4322	Q212	BR8HIX	7001
CW-RSP	50	1	2008-2009	0,7	BR8HS	4322	Q212	BR8HIX	7001
DT-A	50	1	1987-	0,7	BR6HS	3922	Q209	BR6HIX	3419
DT-RM	50	1	1997-	0,8	BR8ES	5422	Q207	BR8EIX	5044
DT-Super Motard	50		2003-	0,8	BR9ES	5722	Q208	BR9EIX	3981
EW-N	50	1	2007-2009	0,7	BR8HS	4322	Q212	BR8HIX	7001
Jog	50	1	1990-	0,7	BPR6HS	7022	Q214	BPR6HIX	4085
JogR	50	1	-	0,6	BR8HS	4322	Q212	BR8HIX	7001
JogRR	50	1	-	0,6	BR8HS	4322	Q212	BR8HIX	7001
Jog-Z 50	50	1	1995-	0,7	BP7HS	5111	-	BPR7HIX	5944
LB, Chappy	50	1	-	0,6	B6HS	4510	Q203	BR6HIX	3419
Meyami	50	1	1986-	0,7	BR7HS	4122	Q211	BR7HIX	7067
PW	50	1	1990-	0,7	BPR4HS	7823	-	-	-
PW	50	1	2008-	0,7	BP4HS	3611	-	-	-
SH-F	50	1	-	1,0	BPR6HS-10	2633	-	-	-
Slider	50	1	1999-	0,6	-	-	-	BR9HIX	5687
TT-R-E / EX / EY	50	1	2007-	0,7	CR7HSA	4549	-	CR7HIX	7544
TZR	50		2003-2006	0,8	BR9ES	5722	Q208	BR9EIX	3981
TZR	50		2013-	0,7	CR8E	1275	Q226	CR8EIX	4218
TZR-R	50	1	1997-	0,8	BR8ES	5422	Q207	BR8EIX	5044
V	50		2007-2007	0,7	BR7HS	4122	Q211	BR7HIX	7067
V-D	50		2007-2007	0,7	BR7HS	4122	Q211	BR7HIX	7067
V-FM	50		-	0,6	B7HS	5110	Q204	BR7HIX	7067
V-MA	50		-	0,6	B6HS	4510	Q203	BR6HIX	3419
V-N	50		2007-2007	0,7	BR7HS	4122	Q211	BR7HIX	7067
Why	50	1	1998-2000	0,7	BR8HS	4322	Q212	BR8HIX	7001
XC-V Vino	50	1	2006-	0,7	CR7E	4578	Q225	CR7EIX	7385
XF	50	1	2007-2009	0,8	CR7E	4578	Q225	CR7EIX	7385

* Bitte Elektrodenabstand nach Angaben des Herstellers justieren

* Please adjust the groundelectrode gap

* Veuillez vérifier L' écartement

* Por favor, ajustar distancia entre electrodos

* regolare il gap

C
y
l

Stock-№

Quick-№



Stock-№ IX

YAMAHA

XF-Giggle	50	1	2008-	0,8	CR7E	4578	Q225	CR7EIX	7385
YA-Axis 50	50	1	1995-1997	0,6	BR7HS	4122	Q211	BR7HIX	7067
YE-Zest	50	1	1992-	0,7	BR7HS	4122	Q211	BR7HIX	7067
YH-Why	50		1999-2003	0,6	BR8HS	4322	Q212	BR8HIX	7001
YM-Breeze	50	1	1993-	0,7	BR8HS	4322	Q212	BR8HIX	7001
YN-Neo's	50	1	1997-2007	0,6	BR8HS	4322	Q212	BR8HIX	7001
YN-Neo's 4 Stroke	50	1	2009-	0,8	CR7E	4578	Q225	CR7EIX	7385
YN-R Neo's	50	1	-	0,7	BR7HS	4122	Q211	BR7HIX	7067
YQ-Aerox / R "Biaggi", Nitro	50	1	1997-	0,7	BR8HS	4322	Q212	BR8HIX	7001
YQ-Aerox R Toyota Racing	50	1	2003-	0,6	BR8HS	4322	Q212	BR8HIX	7001
YW-ZUMA	50	1	2008-	0,7	BPR7HS	6422	Q215	BPR7HIX	5944
YZ-H	50		-	0,6	B9ES	2611	Q202	BR9EIX	3981
YF-S	60	1	-	0,7	BP6HS	4511	-	BPR6HIX	4085
V	70	1	-	0,7	B7HS	5110	Q204	BR7HIX	7067
TY-B	80		-	0,6	B6HS	4510	Q203	BR6HIX	3419
YE-Zest	80	1	-	0,7	BR7HS	4122	Q211	BR7HIX	7067
YFM-Badger	80	1	-	0,7	CR7HSA	4549	-	CR7HIX	7544
YFM-S / T	80	1	1985-	0,6	CR7HSA	4549	-	CR7HIX	7544
YSR	80	1	-	0,6	BR8HS	4322	Q212	BR8HIX	7001
YZ-B	80	1	-	0,7	B8HS	5510	Q205	BR8HIX	7001
YZ-E/F/G/H/H1	80	1	1994-1996	0,6	B10EG	3630	-	-	-
YZ-J / K / L / N / T	80	1	-	0,6	B9EG	3530	-	-	-
YZ-LC	80	1	1999-	0,6	BR10EG	3830	-	-	-
YZ-LW/LWF/LWH/LWG	80	1	1993-1996	0,6	B10EG	3630	-	-	-
YZ-S	80	1	1986-	0,6	BR9EG	3230	-	-	-
YZ	85	1	2001-	0,6	BR10EG	3830	-	-	-
YZ-W1 / X	85	1	2007-	0,6	BR10EG	3830	-	-	-
T-D / N	90	1	2007-2007	0,7	CR6HSA	2983	-	CR6HIX	7274
TT-R	90	1	2000-	0,7	CR6HSA	2983	-	CR6HIX	7274
TT-R-E	90		2007-	0,7	CR6HSA	2983	-	CR6HIX	7274
V	90	1	-	0,7	B7HS	5110	Q204	BR7HIX	7067
AG-F	100		2007-2009	0,8	B7ES	1111	-	BR7EIX	6664
AG-H / E	100	1	-	0,8	B7ES	1111	-	BR7EIX	6664
BW's	100	1	2000-	0,7	BR7HS	4122	Q211	BR7HIX	7067
TT-R-EX, EY	110	1	2008-	0,7	CR6HSA	2983	-	CR6HIX	7274
AF	113		2007-2009	0,7	C7HSA	4629	-	CR7HIX	7544
AL	113		2007-2009	0,7	C7HSA	4629	-	CR7HIX	7544
AT	113		2007-2009	0,8	CR7HSA	4549	-	CR7HIX	7544
AT-C	115	1	2007-2009	0,8	CR7HSA	4549	-	CR7HIX	7544
BW's-Long Base	125	1	2010-	0,6	CR7E	4578	Q225	CR7EIX	7385
BW's-Short Base	125	1	2009-	0,7	CR7HSA	4549	-	CR7HIX	7544
DT	125	1	1988-	0,8	BR9ES	5722	Q208	BR9EIX	3981
DT-LC	125	1	-	0,6	BR9ES	5722	Q208	BR9EIX	3981
DT-MX	125	1	-	0,8	B8ES	2411	Q201	BR8EIX	5044
DT-R, RE	125	1	1990-	0,7	BR9ES	5722	Q208	BR9EIX	3981

* Bitte Elektrodenabstand nach Angaben des Herstellers justieren

* Please adjust the groundelectrode gap

* Veuillez vérifier L' écartement

* Por favor, ajustar distancia entre electrodos

* regolare il gap

C
Y
L

Stock-No

Quick-No



Stock-No IX

YAMAHA

DT-RE	125	1	2004-	0,8	BR9ES	5722	Q208	BR9EIX	3981
DT-X	125	1	2005-	0,5	BR8ES	5422	Q207	BR8EIX	5044
HW-Xenter	125		2012-	0,9	CPR9EA-9	2308	-	-	-
NXC-XC125 Cygnus X	125		2004-	0,8	CR7E	4578	Q225	CR7EIX	7385
RD-C-DX, DX , D-DX	125	1	-	0,8	B8ES	2411	Q201	BR8EIX	5044
RD-Long Base	125	1	-	0,8	B8ES	2411	Q201	BR8EIX	5044
RD-Short Base	125	1	-	0,7	B8HS	5510	Q205	BR8HIX	7001
RS-E	125	1	-	0,7	B7HS	5110	Q204	BR7HIX	7067
RS-H / Z / DX	125	1	-	0,7	B8HS	5510	Q205	BR8HIX	7001
SR	125	1	1996-	0,7	DR8EA	7162	-	DR8EIX	6681
SR-SE	125	1	-1995	0,7	D8EA	2120	Q216	DR8EIX	6681
TDR	125	1	1992-1996	0,8	BR9ES	5722	Q208	BR9EIX	3981
TDR	125	1	1997-	0,8	BR8ES	5422	Q207	BR8EIX	5044
T-H / J	125		-	0,6	B9EG	3530	-	BR9EIX	3981
TTR-EX, LEX, LX	125	1	2007-	0,7	CR7HSA	4549	-	CR7HIX	7544
TT-R-LW	125	1	2000-	0,7	CR7HSA	4549	-	CR7HIX	7544
TW	125	1	1998-	0,7	DR8EA	7162	-	DR8EIX	6681
TY-Short Base	125	1	-	0,7	B7HS	5110	Q204	BR7HIX	7067
TZ-H	125	1	-1995	0,6	-	-	-	BR10EIX	6801
TZ-H	125	1	1995-	0,6	R7376-10	4457	-	-	-
TZR	125	1	1993-	0,8	BR9ECM	3252	-	BR9ECMIX	2707
Vity	125	1	2008-	0,6	CR7E	4578	Q225	CR7EIX	7385
VP-X-City	125		2007-	0,9	CPR9EA-9	2308	-	-	-
V-Z / ZR	125		2007-	0,8	B8ES	2411	Q201	BR8EIX	5044
WR	125	1	1997-	0,6	BR9EG	3230	-	-	-
WR-R Enduro / X Supermotard	125	1	2009-	0,7	CR8E	1275	Q226	CR8EIX	4218
XA	125		2008-	0,6	CR7E	4578	Q225	CR7EIX	7385
XC-(3TE)	125	1	1990-	0,7	CR6HSA	2983	-	CR6HIX	7274
XC-B/E/F/G/H/X/W/ZW	125	1	-	0,7	C6HSA	3228	-	CR6HIX	7274
XC-Beluga	125	1	-	0,7	CR6HSA	2983	-	CR6HIX	7274
XC-Cygnus	125	1	1995-	0,7	CR7E	4578	Q225	CR7EIX	7385
XC-S / SC / ZSC / ZS	125	1	-	0,7	CR6HSA	2983	-	CR6HIX	7274
XC-T (4KY)	125	1	1995-	0,6	CR7E	4578	Q225	CR7EIX	7385
XC-T (4NB)	125	1	1994-	0,7	CR7E	4578	Q225	CR7EIX	7385
XC-T Cygnus T (4NB)	125	1	1996-	0,6	CR7E	4578	Q225	CR7EIX	7385
XC-TR Cygnus	125	1	2000-	0,7	CR7E	4578	Q225	CR7EIX	7385
XC-TR Cygnus, R	125	1	1996-1999	0,7	CR7E	4578	Q225	CR7EIX	7385
XC-X Cygnus	125	1	2007-	0,7	CR7E	4578	Q225	CR7EIX	7385
XN-Teo's	125	1	2000-	0,6	CR8E	1275	Q226	CR8EIX	4218
XQ-Maxster, Thunder	125	1	2001-	0,6	CR8E	1275	Q226	CR8EIX	4218
XT-E / K / R / X / XE / XK	125	1	2005-	0,8	CR7HSA	4549	-	CR7HIX	7544
XT-E, EC, F, FC	125	1	1993-	0,7	DR8EA	7162	-	DR8EIX	6681
XT-J/ K/ KC/ L	125	1	-	0,7	D8EA	2120	Q216	DR8EIX	6681
XVS-DragStar	125	1	2000-	0,7	CR7HSA	4549	-	CR7HIX	7544
XV-Virago	125	1	1997-	0,7	CR6HSA	2983	-	CR6HIX	7274
YBR	125	1	2005-	0,7	CR6HSA	2983	-	CR6HIX	7274
YBR-Custom	125	1	2010-	0,7	CR6HSA	2983	-	CR6HIX	7274
Y-E / F	125		-	0,5	BR9EG	3230	-	-	-
YFA-1 Breeze	125	1	-	0,7	CR7HSA	4549	-	CR7HIX	7544
YJ-V Vino	125	1	2006-	0,7	CR7E	4578	Q225	CR7EIX	7385
YP-Majesty	125	1	2004-	0,7	CR7E	4578	Q225	CR7EIX	7385
YP-Majesty	125	1	2007-	0,7	CR8E	1275	Q226	CR8EIX	4218

* Bitte Elektrodenabstand nach Angaben des Herstellers justieren

* Please adjust the groundelectrode gap

* Veuillez vérifier L' écartement

* Por favor, ajustar distancia entre electrodos

* regolare il gap

C
Y
L

0201



Stock-№

Quick-№



Stock-№ IX

YAMAHA

YP-R Majesty	125	1	1998-	0,7	CR8E	1275	Q226	CR8EIX	4218
YP-X-Max R	125	1	2006-	0,9	CPR9EA-9	2308	-	-	-
YS	125		2013-	*	-	-	-	BR9EIX	3981
YT-N	125	1	1985-	0,6	BP5ES	6511	-	BPR5EIX	6597
YZ	125	1	2011-	*	-	-	-	BR9EIX	3981
YZ-A, U, W, N, S	125	1	-	0,6	BR9EG	3230	-	-	-
YZ-B, C, G, G1, H, X	125	1	-	0,6	B9EG	3530	-	-	-
YZ-E, E1, F, LC	125	1	-	0,6	BR9EG	3230	-	-	-
YZ-S1 / T1	125	1	2004-	0,6	BR9EG	3230	-	-	-
YZ-W1	125	1	2007-	0,6	-	-	-	BR9EIX	3981
YZ-X1	125	1	2008-	0,7	-	-	-	BR9EIX	3981
JT	135	1	2007-2008	0,9	CPR8EA-9	2306	-	-	-
T-HC / S / SE / SEC	135	1	2007-2009	0,9	CPR8EA-9	2306	-	-	-
HW-Xenter	150		2012-	0,9	CPR8EA-9	2306	-	-	-
SRZ	150		2007-	0,7	DR8EA	7162	-	DR8EIX	6681
XC-Fly One	150	1	1995-	0,7	CR7E	4578	Q225	CR7EIX	7385
AC 150 B	153		2009-	0,9	CPR8EA-9	2306	-	-	-
DT-E, MX	175	1	-	0,8	B8ES	2411	Q201	BR8EIX	5044
IT-E	175	1	-	0,6	-	-	-	BR10EIX	6801
IT-H / J / K	175	1	-	0,6	B9EG	3530	-	-	-
TY-E, J	175	1	-	0,8	B7ES	1111	-	BR7EIX	6664
AG-E / F / FE	200		2007-2009	0,7	D8EA	2120	Q216	DR8EIX	6681
DT-R	200	1	-	0,8	BR9ES	5722	Q208	BR9EIX	3981
IT	200	1	-	0,6	BR9EG	3230	-	-	-
RD-B Long Base	200	1	-	0,8	B7ES	1111	-	BR7EIX	6664
RD-B Short Base	200	1	-	0,7	B8HS	5510	Q205	BR8HIX	7001
RD-C, C-DX, D, D-DX	200	1	-	0,8	B8ES	2411	Q201	BR8EIX	5044
RS	200	1	-	0,8	B8ES	2411	Q201	BR8EIX	5044
TW-E/ EC/ FC	200	1	1987-	0,7	DR8EA	7162	-	DR8EIX	6681
TW-W1 / W1C	200		2007-2009	0,7	DR8EA	7162	-	DR8EIX	6681
TW-X	200	1	2008-	0,7	DR8EA	7162	-	DR8EIX	6681
WR-B/R/RD/RE/RG/RH	200	1	-	0,6	BR9ES	5722	Q208	BR9EIX	3981
YFM-DX	200	1	-	0,7	DR7ES	3123	-	DR7EIX	5686
YFM-N (Moto-4)	200	1	-	0,7	D7EA	7912	-	DR7EIX	5686
YFS-Blaster	200	1	-	0,8	BR8ES	5422	Q207	BR8EIX	5044
YTM-K/EK/L/EL/ERN/N	200	1	-	0,7	D7EA	7912	-	DR7EIX	5686
SX-Scorpio	225	1	2007-2009	0,9	DP8EA-9	5829	-	DPR8EIX-9	2202
TT	225	1	-	0,7	DR8ES-L	2923	Q218	DR8EIX	6681
TW-E	225	1	2007-2007	0,7	DR8EA	7162	-	DR8EIX	6681
XT	225	1	2007-2007	0,7	DR8EA	7162	-	DR8EIX	6681
YFM-S (Moto-4)	225	1	-	0,7	D7EA	7912	-	DR7EIX	5686
TDR	240	1	-	0,8	BR9ES	5722	Q208	BR9EIX	3981
XV	240	1	-	0,7	CR6HS	7023	Q223	CR6HIX	7274
CP	250		2007-2009	0,9	CPR7EA-9	3901	-	CPR7EAIX-9	9198
CP-W Morphous	250	1	2007-	0,9	CPR7EA-9	3901	-	CPR7EAIX-9	9198
DT-E, MX	250	1	-	0,8	B8ES	2411	Q201	BR8EIX	5044
Grand Majesty	250	1	2004-	0,9	CPR6EA-9	6899	-	-	-
IT	250		-	0,6	B9EG	3530	-	-	-
MX	250		-	0,6	-	-	-	BR8EIX	5044
RD-D, H, J	250	2	-	0,8	B8ES	2411	Q201	BR8EIX	5044
RD-LC	250	2	-	0,8	BR8ES	5422	Q207	BR8EIX	5044
RD-Long Base	250	2	-	0,8	B9ES	2611	Q202	BR9EIX	3981

* Bitte Elektrodenabstand nach Angaben des Herstellers justieren

* Please adjust the groundelectrode gap

* Veuillez vérifier l' écartement

* Por favor, ajustar distancia entre electrodos

* regolare il gap

C
Y
L

0201



Stock-No

Quick-No



Stock-No IX

YAMAHA

RD-Short Base	250	2	-	0,7	B8HS	5510	Q205	BR8HIX	7001
SR	250	1	-	0,8	BPR7ES	2023	-	BPR7EIX	4055
TDR	250	2	-	0,8	BR9ES	5722	Q208	BR9EIX	3981
TTR	250	1	1994-1999	0,8	CR9E	6263	Q227	CR9EIX	3521
TTR-R	250	1	2000-	0,8	CR9E	6263	Q227	CR9EIX	3521
TY-N	250	1	-	0,6	BR8ES	5422	Q207	BR8EIX	5044
TY-R	250	1	1984-1987	0,8	BR6ES	4922	-	-	-
TY-Z	250	1	1994-1995	0,6	-	-	-	BPR6EIX	6637
TY-Z	250	1	1996-	0,6	-	-	-	BPR6EIX	6637
TZR-A, T	250	2	-	0,8	BR9ES	5722	Q208	BR9EIX	3981
TZR-R, RS, RSP	250	2	-	0,8	BR9ECM	3252	-	BR9ECMIX	2707
V Star 250	250	2	2012-	0,7	C6HSA	3228	-	CR6HIX	7274
WR	250	1	1997-	0,6	BR8EG	3130	-	-	-
WR-F	250	1	2001-	0,7	CR8E	1275	Q226	CR8EIX	4218
WR-FX	250	1	2008-	0,7	CR8E	1275	Q226	CR8EIX	4218
WR-R / X / RY / RYC / XY / XYC	250	1	2008-	0,8	CR9EK	4548	Q230	CR9EIX	3521
WR-Z / ZB / ZG / ZF	250	1	-	0,6	B8EG	3430	-	-	-
WR-ZH	250	1	-	0,6	BR8EG	3130	-	-	-
X-City	250	1	2007-	0,9	DPR8EA-9	4929	Q221	DPR8EIX-9	2202
XG-Tricker	250	1	2005-	0,7	DR7EA	7839	-	DR7EIX	5686
X-Max	250	1	2005-2006	0,6	DR8EA	7162	-	DR8EIX	6681
X-Max	250	1	2007-	0,9	DPR8EA-9	4929	Q221	DPR8EIX-9	2202
XS-C, H, RH, SE, SH	250	2	-	0,8	BP7ES	2412	Q206	BPR7EIX	4055
XS-PK, SK, R	250	2	-	0,7	D8EA	2120	Q216	DR8EIX	6681
XT	250	1	2007-2009	0,6	DR7EA	7839	-	DR7EIX	5686
XTZ	250	1	2007-2009	0,7	DR8EA	7162	-	DR8EIX	6681
XV-S / SG (Virago)	250	2	1995-	0,6	CR6HS	7023	Q223	CR6HIX	7274
XV-Virago	250	2	2008-	0,7	C6HSA	3228	-	CR6HIX	7274
XV-W, WC	250	2	-	0,7	CR6HSA	2983	-	CR6HIX	7274
YBR	250		2007-	0,6	DR8EA	7162	-	DR8EIX	6681
YP-A Majesty, ABS	250	1	2000-	0,7	DR8EA	7162	-	DR8EIX	6681
YP-Black X-Max	250	1	2007-	0,9	DPR8EA-9	4929	Q221	DPR8EIX-9	2202
YP-Black X-Max	250	1	2010-	0,6	DR8EA	7162	-	DR8EIX	6681
YP-Majesty DX	250	1	1997-2000	0,6	DR8EA	7162	-	DR8EIX	6681
YP-R X-Max	250	1	2010-	0,7	CR7E	4578	Q225	CR7EIX	7385
YZ-N / S	250		1985-	0,6	B8ES	2411	Q201	BR8EIX	5044
YZ-4MX	250	1	1995-	0,7	BR8EG	3130	-	-	-
YZ-A/E/U/W/WR/WRA/WRW	250	1	-	0,6	B8EG	3430	-	-	-
YZ-F	250	1	2001-	0,8	CR8E	1275	Q226	CR8EIX	4218
YZ-F	250	1	2013-	0,8	LMAR8G	95627	-	-	-
YZ-F / FS	250	1	2004-	0,8	CR8E	1275	Q226	CR8EIX	4218
YZ-F / W1	250	1	2007-	0,6	BR8EG	3130	-	-	-
YZ-FX	250	1	2008-	0,7	CR8E	1275	Q226	CR8EIX	4218
YZ-G / G1	250	1	1995-	0,5	B8EG	3430	-	-	-
YZ-H / H1	250	1	1996-	0,6	BR8EG	3130	-	-	-
YZ-LC	250	1	1999-	0,6	BR8EG	3130	-	-	-
YZ-N	250	1	-	0,6	B9EG	3530	-	-	-
YZ-S1 / T1	250	1	2004-	0,6	BR8EG	3130	-	-	-
YZ-X	250	1	2008-	0,6	BR8EG	3130	-	-	-
VP-Versity	300	2	2003-	0,9	DR8EA	7162	-	DR8EIX	6681
YZF-R3	321	2	2015-	0,7	CR9E	6263	Q227	CR9EIX	3521
RD-F / N	350	2	1986-	0,8	BR9ES	5722	Q208	BR9EIX	3981

* Bitte Elektrodenabstand nach Angaben des Herstellers justieren

* Please adjust the groundelectrode gap

* Veuillez vérifier l' écartement

* Por favor, ajustar distancia entre electrodos

* regolare il gap

C
Y
L

0201



Stock-№

Quick-№



Stock-№ IX

YAMAHA

RD-LCF	350	2	1986-	0,8	BR9ES	5722	Q208	BR9EIX	3981
RD-Long Base	350	2	-	0,8	B8ES	2411	Q201	BR8EIX	5044
RD-Short Base	350	2	-	0,7	B8HS	5510	Q205	BR8HIX	7001
TT	350		-	0,7	D8EA	2120	Q216	DR8EIX	6681
XT	350		1985-1991	0,7	DR8ES-L	2923	Q218	DR8EIX	6681
YFM-ERT, FWT, XT	350	1	1987-	0,6	D8EA	2120	Q216	DR8EIX	6681
YFZ-T	350		1987-	0,6	B8ES	2411	Q201	BR8EIX	5044
DT-E, MX	400		-	0,8	B8ES	2411	Q201	BR8EIX	5044
FZR-RR/SP	400		1991-1995	0,7	CR8E	1275	Q226	CR8EIX	4218
IT	400		-	0,8	B8ES	2411	Q201	BR8EIX	5044
Majesty	400	1	2001-	0,7	CR7E	4578	Q225	CR7EIX	7385
MX	400		-	0,6	-	-	-	BR8EIX	5044
RD-C / D / E / F	400	2	-	0,8	B8ES	2411	Q201	BR8EIX	5044
WR-F	400		1998-	0,7	CR8E	1275	Q226	CR8EIX	4218
XJ	400	4	-	0,7	D8EA	2120	Q216	DR8EIX	6681
XJR-R	400	2	2007-	0,7	CR9E	6263	Q227	CR9EIX	3521
XVS	400	2	2007-2008	0,9	DPR7EA-9	5129	Q220	DPR7EIX-9	7803
YFM-FW Kodiak	400		1992-1999	0,6	DR8EA	7162	-	DR8EIX	6681
YP-W Majesty	400	1	2007-	0,7	CR7E	4578	Q225	CR7EIX	7385
YZ-C, E	400		-	0,6	-	-	-	BR8EIX	5044
YZ-F	400	4	1998-1999	0,7	CR8E	1275	Q226	CR8EIX	4218
WR-F	426	1	2000-	0,7	CR8E	1275	Q226	CR8EIX	4218
YZ-F	426	1	1999-	0,7	CR8E	1275	Q226	CR8EIX	4218
WR-F	450	1	2003-	0,7	CR8E	1275	Q226	CR8EIX	4218
WR-FX	450		2008-	0,7	CR8E	1275	Q226	CR8EIX	4218
YZF	450	1	2004-	0,7	CR8E	1275	Q226	CR8EIX	4218
YZ-F	450	1	2010-	0,7	CR8E	1275	Q226	CR8EIX	4218
YZ-F / FW / FX	450		2007-	0,8	CR8E	1275	Q226	CR8EIX	4218
YZF-F	450		2009-	0,7	CR8E	1275	Q226	CR8EIX	4218
IT-H / J	465		-	0,8	B8ES	2411	Q201	BR8EIX	5044
YZ-H	465		-	0,8	B8ES	2411	Q201	BR8EIX	5044
YZ-K / L / N / S / T / U / W	490		-	0,6	B9EG	3530	-	-	-
SR	500		1997-	0,8	BPR7ES	2023	-	BPR7EIX	4055
SR-E, H	500		-1996	0,8	BP7ES	2412	Q206	BPR7EIX	4055
XP-T-Max	500	2	2000-	0,8	CR7E	4578	Q225	CR7EIX	7385
XS-X / E	500		-	0,7	D9EA	2420	-	DR9EIX	4772
XT	500		1976-1989	0,8	BPR7ES	2023	-	BPR7EIX	4055
XT-T,Z	500		-	0,9	DPR8EA-9	4929	Q221	DPR8EIX-9	2202
YP-T-Max ABS	500	2	-	0,6	CR7E	4578	Q225	CR7EIX	7385
XV-DX Virago	535	2	1988-2001	0,8	BPR7ES	2023	-	BPR7EIX	4055
XV-S / SP	535		-	0,8	BPR7ES	2023	-	BPR7EIX	4055
XJ	550		-	0,7	D8EA	2120	Q216	DR8EIX	6681
XT	550		-	0,6	DR7ES	3123	-	DR7EIX	5686
XZ	550	2	-	0,7	DR8ES-L	2923	Q218	DR8EIX	6681
FZ	600		-	0,7	DR8ES-L	2923	Q218	DR8EIX	6681
FZ6-Fazer	600	4	2003-2006	0,8	CR9EK	4548	Q230	CR9EIX	3521
FZ6-Fazer S2	600	4	2007-	0,8	CR9EK	4548	Q230	CR9EIX	3521
FZ6R-Fazer	600		2010-	0,7	CR9E	6263	Q227	CR9EIX	3521
FZR-R	600		-	0,8	CR9E	6263	Q227	CR9EIX	3521
FZS-Fazer	600	4	1998-2004	0,7	CR8E	1275	Q226	CR8EIX	4218
SRX	600		-	0,9	DPR8EA-9	4929	Q221	DPR8EIX-9	2202

* Bitte Elektrodenabstand nach Angaben des Herstellers justieren

* Please adjust the groundelectrode gap

* Veuillez vérifier l' écartement

* Por favor, ajustar distancia entre electrodos

* regolare il gap

C
Y
L

Stock-No

Quick-No



Stock-No IX

YAMAHA

TTR-E / R	600		1996-1999	0,9	DPR8EA-9	4929	Q221	DPR8EIX-9	2202
XJ	600	4	-	0,7	DR8ES-L	2923	Q218	DR8EIX	6681
XJ-6N / 6NA / 6S / 6SA / 6SY	600	4	2009-	0,8	CR9E	6263	Q227	CR9EIX	3521
XJ-N & S Diversion	600	4	1991-2002	0,7	CR8E	1275	Q226	CR8EIX	4218
XT-All models	600	1	1986-	0,9	DPR8EA-9	4929	Q221	DPR8EIX-9	2202
XV-V Star Classic	600		2008-	0,9	DPR7EA-9	5129	Q220	DPR7EIX-9	7803
YZF-R, R Thundercat	600	4	1996-	0,8	CR9E	6263	Q227	CR9EIX	3521
YZF-R6	600	4	1999-	0,7	CR10EK	2360	-	CR10EIX	6482
YZF-R6SW, R6S	600	4	2007-	0,7	CR10EK	2360	-	CR10EIX	6482
YZF-RW	600	4	2007-	0,8	CR9E	6263	Q227	CR9EIX	3521
XS-E, SE, Special	650	2	-	0,8	BP7ES	2412	Q206	BPR7EIX	4055
XVS-Drag Star (4VR / 4XR)	650	2	1997-	0,9	DPR7EA-9	5129	Q220	DPR7EIX-9	7803
XVS-V-Star Midnight	650	2	2006-	0,9	DPR7EA-9	5129	Q220	DPR7EIX-9	7803
MT-03	660	1	2006-	0,7	CR7E	4578	Q225	CR7EIX	7385
SZR	660		-	0,9	DPR8EA-9	4929	Q221	DPR8EIX-9	2202
XTR	660	1	2004-	0,7	CR7E	4578	Q225	CR7EIX	7385
XT-R / X	660	1	2004-	0,7	CR7E	4578	Q225	CR7EIX	7385
XTZ-Tenere	660	1	2004-2011	0,9	DPR8EA-9	4929	Q221	DPR8EIX-9	2202
YFM-R Raptor	660		2001-	0,9	DPR8EA-9	4929	Q221	DPR8EIX-9	2202
FZ-Genesis	750		-	0,7	DR8ES-L	2923	Q218	DR8EIX	6681
FZR-R	750		1988-	0,7	DR9EA	3437	Q219	DR9EIX	4772
FZX	750	4	-	0,8	DR8ES-L	2923	Q218	DR8EIX	6681
XJ-RH	750		-	0,7	BP7ES	2412	Q206	BPR7EIX	4055
XS-C, D, E, SE	750	3	-	0,7	BP7ES	2412	Q206	BPR7EIX	4055
XTZ-Super Tenere	750		-	0,9	DPR8EA-9	4929	Q221	DPR8EIX-9	2202
XV-F / FC / SE	750		-	0,7	BPR7ES	2023	-	BPR7EIX	4055
YZF-R RF/RFC, SP/SPF	750		1993-	0,7	CR9E	6263	Q227	CR9EIX	3521
YZF-R7 (0W 02)	750	4	1999-	0,7	R0373A-10	4940	-	-	-
FZ8-FZ8-S / FZ8-SA / FZ8-N	800	4	2010-	0,7	CR9E	6263	Q227	CR9EIX	3521
FZ8-Redline	800	4	2012-	0,7	CR9E	6263	Q227	CR9EIX	3521
TDM	850		1991-1996	0,9	DPR9EA-9	5329	Q222	DPR9EIX-9	5545
TDM	850	2	1997-2001	0,9	DPR8EA-9	4929	Q221	DPR8EIX-9	2202
TRX	850		1996-	0,9	DPR9EA-9	5329	Q222	DPR9EIX-9	5545
TDM	900	2	2002-	0,9	DPR8EA-9	4929	Q221	DPR8EIX-9	2202
XJ-S Diversion & GT Diversion	900	4	1995-	0,9	DPR8EA-9	4929	Q221	DPR8EIX-9	2202
V Star	950	2	2012-	0,9	CPR7EA-9	3901	-	CPR7EAIX-9	9198
V Star Tourer	950	2	2012-	0,9	CPR7EA-9	3901	-	CPR7EAIX-9	9198
XVS-A Midnight Star	950		2009-	0,9	CPR7EA-9	3901	-	CPR7EAIX-9	9198
FZ-1-Fazer	1000	4	2006-2007	0,8	CR9EK	4548	Q230	CR9EIX	3521
FZ-1-Fazer / S / SA / SX / SY	1000	4	2008-	0,8	CR9EK	4548	Q230	CR9EIX	3521
FZR-FC	1000	4	1994-	0,7	DR8EA	7162	-	DR8EIX	6681
FZR-U	1000	4	1994-	0,7	DR8ES-L	2923	Q218	DR8EIX	6681
FZ-S-Fazer	1000	4	2000-	0,8	CR9E	6263	Q227	CR9EIX	3521
GTS-A, ABS, Free Way	1000	4	-	0,9	DPR8EA-9	4929	Q221	DPR8EIX-9	2202
MT-01	1000	2	2007-	0,9	DPR7EA-9	5129	Q220	DPR7EIX-9	7803
TR1	1000		-	0,7	BPR7ES	2023	-	BPR7EIX	4055
XV	1000	2	-	0,7	BPR7ES	2023	-	BPR7EIX	4055
YZF-R Thunderace	1000	4	1995-	0,9	DR8EA	7162	-	DR8EIX	6681
YZF-R1	1000	4	1998-2001	0,7	CR9E	6263	Q227	CR9EIX	3521
YZF-R1	1000	4	2002-2003	0,9	CR9EIA-9	6289	-	-	-
YZF-R1	1000	4	2004-2008	0,8	CR9EK	4548	Q230	CR9EIX	3521
YZF-R1	1000	4	2009-	0,7	LMAR9E-J	6884	-	-	-

* Bitte Elektrodenabstand nach Angaben des Herstellers justieren

* Please adjust the groundelectrode gap

* Veuillez vérifier L' écartement

* Por favor, ajustar distancia entre electrodos

* regolare il gap

C
Y
L

0201



Stock-No

Quick-No



Stock-No IX

YAMAHA

YZF-R1	1000	4	2012-	0,7	LMAR9E-J	6884	-	-	-
BT-Bulldog	1100	4	2002-	0,7	BPR7ES	2023	-	BPR7EIX	4055
XS-E, H, LH, RH, S	1100	4	-	0,8	BP6ES	7811	-	BPR6EIX	6637
XVS-Drag Star / A Classic	1100	2	1999-	0,7	BR7ES	5122	-	BR7EIX	6664
XVS-V Star Classic, Custom	1100	2	2008-	0,7	BPR7ES	2023	-	BPR7EIX	4055
XVS-V-Star Midnight	1100		2006-	0,7	BPR7ES	2023	-	BPR7EIX	4055
XVS-XB / XBC V Star Midnight Custom	1100	2	2008-	0,7	BPR7ES	2023	-	BPR7EIX	4055
XV-Virago	1100		-1998	0,7	BPR7ES	2023	-	BPR7EIX	4055
FJ	1200		1989-1996	0,9	DPR8EA-9	4929	Q221	DPR8EIX-9	2202
V-Max	1200	4	1988-2002	0,9	DPR8EA-9	4929	Q221	DPR8EIX-9	2202
World Crosser (Twin Spark)	1200		2012-	0,9	CPR8EB-9	6607	-	-	-
XJR-SP	1200	4	1995-1998	0,9	DPR8EA-9	4929	Q221	DPR8EIX-9	2202
XT- Z Super Tenere (Twin Spark)	1200	2	2010-	0,9	CPR8EB-9	6607	-	-	-
FJR	1300	4	2001-	0,8	CR8E	1275	Q226	CR8EIX	4218
FJR-/A	1300		2001-	0,7	CR8E	1275	Q226	CR8EIX	4218
FJR-A	1300		2013-	0,7	CPR8EA-9	2306	-	-	-
FJR-A/AS	1300		2006-	0,7	CR8E	1275	Q226	CR8EIX	4218
FJR-AS	1300	4	2013-	0,7	CPR8EA-9	2306	-	-	-
XJR-& SP	1300	4	1998-	0,9	DPR8EA-9	4929	Q221	DPR8EIX-9	2202
XVS-V Star / Tourer	1300	2	2007-	0,9	LMAR7A-9	4908	-	-	-
XV-TD	1300	4	-	0,9	DPR8EA-9	4929	Q221	DPR8EIX-9	2202
XVZ-A Royal Star, A Midnigh Star	1300	4	1998-2001	0,9	DPR7EA-9	5129	Q220	DPR7EIX-9	7803
XVZ-TF Venture	1300	4	2008-	0,9	DPR8EA-9	4929	Q221	DPR8EIX-9	2202
Stryker	1304	2	2012-	0,9	LMAR7A-9	4908	-	-	-
XV-A Wild Star	1600	2	1999-2002	0,9	DPR7EA-9	5129	Q220	DPR7EIX-9	7803
MT-01	1670	2	2005-	0,9	DPR7EA-9	5129	Q220	DPR7EIX-9	7803
Road Star S	1670	4	2012-	0,9	DPR7EA-9	5129	Q220	DPR7EIX-9	7803
Road Star Silverado S	1670	4	2012-	0,9	DPR7EA-9	5129	Q220	DPR7EIX-9	7803
XU-Road Star Warrior	1670		2003-	0,9	DPR7EA-9	5129	Q220	DPR7EIX-9	7803
XV-PC Road Star	1670	2	2007-2009	0,9	DPR7EA-9	5129	Q220	DPR7EIX-9	7803
V Max	1679	4	2012-	0,9	CR9EIA-9	6289	-	-	-
V-Max	1700	2	2009-	0,9	CR9EIA-9	6289	-	-	-
XV-Road Star Warrior	1700	2	2008-	0,9	DPR7EA-9	5129	Q220	DPR7EIX-9	7803
Roadliner S	1854	4	2012-	0,9	DPR8EA-9	4929	Q221	DPR8EIX-9	2202
Royal Star Venture S	1854	4	2012-	0,9	DPR8EA-9	4929	Q221	DPR8EIX-9	2202
Stratoliner Deluxe	1854	4	2012-	0,9	DPR8EA-9	4929	Q221	DPR8EIX-9	2202
Stratoliner S	1854	4	2012-	0,9	DPR8EA-9	4929	Q221	DPR8EIX-9	2202
XV-1900, S	1854	4	2012-	0,9	DPR8EA-9	4929	Q221	DPR8EIX-9	2202
Star Stratoliner Deluxe	1900	4	2010-	0,9	DPR8EA-9	4929	Q221	DPR8EIX-9	2202
XV-Midnight Star	1900	2	2006-	0,9	DPR8EA-9	4929	Q221	DPR8EIX-9	2202
DT-B	100		-	0,5	B8HS	5510	Q205	BR8HIX	7001
DT-C / X	100		-	0,5	B7ES	1111	-	BR7EIX	6664
DT-D / SD / E	100		-	0,5	B8ES	2411	Q201	BR8EIX	5044
RS-B/X/DX/S	100		-	0,5	B8HS	5510	Q205	BR8HIX	7001
RS-P	100		-	0,5	BP6HS	4511	-	BPR6HIX	4085
RT-E / F / G / H	100	1	1993-	0,7	B7ES	1111	-	BR7EIX	6664
YN-Neo's	100	1	2000-2004	0,6	BR8HS	4322	Q212	BR8HIX	7001
YQ-Aerox	100	1	2000-2004	0,6	BR8HS	4322	Q212	BR8HIX	7001
YZ-K	100		-	0,5	B9EG	3530	-	-	-
YZ-L	100		-	0,6	BR9EG	3230	-	-	-
Black X-max	125		2009-	0,9	CPR9EA-9	2308	-	-	-
YZF-R	125		2008-	0,7	CR8E	1275	Q226	CR8EIX	4218

* Bitte Elektrodenabstand nach Angaben des Herstellers justieren

* Please adjust the groundelectrode gap

* Veuillez vérifier L' écartement

* Por favor, ajustar distancia entre electrodos

* regolare il gap

C
Y
L

0201



Stock-No

Quick-No



Stock-No IX

YAMAHA

CS5E	200		-	0,6	B8HS	5510	Q205	BR8HIX	7001
VP-X-City	250		2007-	0,9	DPR8EA-9	4929	Q221	DPR8EIX-9	2202
XVS-Drag Star	250		2001-	0,7	CR6HSA	2983	-	CR6HIX	7274
YP	250	1	2000-	0,6	DR8EA	7162	-	DR8EIX	6681
YP-Grand Majesty	250	1	2004-	0,9	CPR7EA-9	3901	-	CPR7EAIX-9	9198
YP-R Black X-max	250	1	2009-	0,9	DPR8EA-9	4929	Q221	DPR8EIX-9	2202
YP-R X-Max	250	1	2005-2009	0,7	DR8EA	7162	-	DR8EIX	6681
ZE-Zest	50		1993-1996	0,6	BR7HS	4122	Q211	BR7HIX	7067
HL	500		-	0,6	BP7ES	2412	Q206	BPR7EIX	4055
PW-K	80		1993-	0,6	BP6HS	4511	-	BPR6HIX	4085

YIYING

YY	50	1	-	0,7	CR7HSA	4549	-	CR7HIX	7544
YY	125	1	-	0,7	CR7HSA	4549	-	CR7HIX	7544

ZHONGNENG

Sixies	50	1	2006-	0,7	CR7HSA	4549	-	CR7HIX	7544
--------	----	---	-------	-----	--------	------	---	--------	------

ZNEN

Viper	50	1	2006-	0,7	CR7HSA	4549	-	CR7HIX	7544
-------	----	---	-------	-----	--------	------	---	--------	------

ZONGSHEN

Explorer Flash 50	50	1	-	0,6	CR7HSA	4549	-	CR7HIX	7544
Qingqi B2 2 tps / QM50QT-B2	50	1	2008-	0,5	BP7HS	5111	-	BPR7HIX	5944
Ride Flash	50	1	-	0,6	CR7HSA	4549	-	CR7HIX	7544
Vento Phantom 2 Stroke	50	1	2008-	0,5	BP7HS	5111	-	BPR7HIX	5944
Vento Triton 2 Stroke	50	1	2008-	0,5	BP7HS	5111	-	BPR7HIX	5944
Vento Zip 2 Stroke	50	1	2008-	0,5	BP7HS	5111	-	BPR7HIX	5944
Arktix, Predator ZS125-GY10	125		-	0,7	DR8EA	7162	-	DR8EIX	6681
Explorer	125	1	-	0,6	CR7HSA	4549	-	CR7HIX	7544
Explorer MRS, MRX	125	1	-	0,9	DP8EA-9	5829	-	DPR8EIX-9	2202
Explorer Phantom 125	125	1	-	0,6	CR7HSA	4549	-	CR7HIX	7544
Qingqi 10D GY6 4 Stroke	125	1	2008-	0,6	CR7HSA	4549	-	CR7HIX	7544
Ride MRS, MRX	125	1	-	0,9	DP8EA-9	5829	-	DPR8EIX-9	2202
Ride Phantom	125	1	-	0,6	CR7HSA	4549	-	CR7HIX	7544
Qingqi 10D GY6 4 Stroke	150	1	2008-	0,6	CR7HSA	4549	-	CR7HIX	7544
Storm ZS250GS	250		-	0,6	D8EA	2120	Q216	DR8EIX	6681

* Bitte Elektrodenabstand nach Angaben des Herstellers justieren
 * Please adjust the groundelectrode gap
 * Veuillez vérifier L' écartement

* Por favor, ajustar distancia entre electrodos
 * regolare il gap

C
y
I

0201



Stock-№

Quick-№



Stock-№ IX

ACCESS

Long	50	1	-	0,6	BR8HSA	5539	-	BR8HIX	7001
Streak	50	1	-	0,8	BR8HSA	5539	-	BR8HIX	7001
Long	100	1	-	0,8	BR8HSA	5539	-	BR8HIX	7001

ADLY

ATV 50	50	1	-	0,6	BP7HS	5111	-	BPR7HIX	5944
Supersonic XXL	50	1	2007-	0,7	BPR7HS	6422	Q215	BPR7HIX	5944
Buggy	125	1	-	0,8	CR7HSA	4549	-	CR7HIX	7544
ATV150	150	1	-	0,7	CR8E	1275	Q226	CR8EIX	4218
Sentinel	176	1	-	0,7	CR8E	1275	Q226	CR8EIX	4218
Cross Sentinel	220	1	-	0,7	CR8E	1275	Q226	CR8EIX	4218
ATV 300	300	1	-	0,7	DR8ES-L	2923	Q218	DR8EIX	6681
Interceptor	300	1	2007-	0,7	DR8ES-L	2923	Q218	DR8EIX	6681

AEON

Cobra 4x2	50	1	2003-	0,8	BPR7HS	6422	Q215	BPR7HIX	5944
Minikolt 4x2	50	1	2003-	0,8	BPR7HS	6422	Q215	BPR7HIX	5944
Revo	50	1	2004-	0,8	BPR7HS	6422	Q215	BPR7HIX	5944
Cobra 4x2	100	1	2002-	0,8	BPR7HS	6422	Q215	BPR7HIX	5944
Revo	100	1	2004-	0,8	BPR7HS	6422	Q215	BPR7HIX	5944
Cobra RS 1&2	125	1	2002-	0,8	CR7HS	7223	-	CR7HIX	7544
Cobra Sport 4x2	125	1	2002-	0,8	CR8HSA	2086	-	CR8HIX	7669
Cobra Utility	125	1	2002-	0,8	CR7HS	7223	-	CR7HIX	7544
Overland	125	1	2004-	0,8	CR7HS	7223	-	CR7HIX	7544
Cobra Overland	180	1	2004-	0,8	CR7HSA	4549	-	CR7HIX	7544
Cobra RS 1&2	180	1	2004-	0,8	CR7HS	7223	-	CR7HIX	7544
Cobra Sport 4x2	180	1	2002-	0,8	CR8HSA	2086	-	CR8HIX	7669
Cobra Utility 4x2	180	1	2002-	0,8	CR8HSA	2086	-	CR8HIX	7669
LG 180	180	1	2005-	0,8	CR7HSA	4549	-	CR7HIX	7544
Overland	180	1	2004-	0,8	CR7HS	7223	-	CR7HIX	7544
Overland II	180	1	2005-	0,8	CR7HSA	4549	-	CR7HIX	7544
Utility	180	1	2002-	0,8	CR7HS	7223	-	CR7HIX	7544
Cobra	220	1	2005-	0,6	CR7HSA	4549	-	CR7HIX	7544

ARCTIC CAT

DVX (A2006KSA2BUS)	50	1	2006-2006	0,7	CR7HSA	4549	-	CR7HIX	7544
DVX (A2008KSA2BUS)	50	1	2008-2008	0,7	CR7HSA	4549	-	CR7HIX	7544
Utility (A2006KUA2BUS)	50	1	2006-2006	0,7	CR7HSA	4549	-	CR7HIX	7544
Utility (A2008KUA2BUS)	50	1	2008-2008	0,7	CR7HSA	4549	-	CR7HIX	7544
Y-6 Youth (A2004ATA2BUS)	50	1	2004-2004	0,7	BPR7HS	6422	Q215	BPR7HIX	5944
Y-6 Youth (A2005H2A2BUS)	50	1	2005-2005	0,7	BPR7HS	6422	Q215	BPR7HIX	5944
Youth (A2002ATB2BUS)	90	1	2002-2002	0,7	BPR7HS	6422	Q215	BPR7HIX	5944
DVX (A2006KSB2BUS)	90	1	2006-2006	0,7	CR7HSA	4549	-	CR7HIX	7544
DVX (A2007KSB2BUS)	90	1	2007-2007	0,7	CR7HSA	4549	-	CR7HIX	7544
DVX (A2008KSB2BUS)	90	1	2008-2008	0,7	CR7HSA	4549	-	CR7HIX	7544
DVX (A2009KSB2BUS)	90	1	2009-2009	0,7	CR7HSA	4549	-	CR7HIX	7544
DVX (A2010KSB2BUS)	90	1	2010-2010	0,7	CR7HSA	4549	-	CR7HIX	7544
DVX (A2011KSB2BUS)	90	1	2011-2011	0,7	CR7HSA	4549	-	CR7HIX	7544
DVX (A2012KSB2BUS)	90	1	2012-2012	0,7	CR7HSA	4549	-	CR7HIX	7544
DVX (A2013KSB2BUS)	90	1	2013-2013	0,7	CR7HSA	4549	-	CR7HIX	7544

* Bitte Elektrodenabstand nach Angaben des Herstellers justieren

* Please adjust the groundelectrode gap

* Veuillez vérifier l' écartement

* Por favor, ajustar distancia entre electrodos

* regolare il gap

C
Y
L

Stock-No

Quick-No



Stock-No IX

ARCTIC CAT

DVX 2x4 (A2014KSB2BUS)	90	1	2014-2014	0,7	CR7HSA	4549	-	CR7HIX	7544
Utility (A2006KUB2BUS)	90	1	2006-2006	0,7	CR7HSA	4549	-	CR7HIX	7544
Utility (A2007KUB2BUS)	90	1	2007-2007	0,7	CR7HSA	4549	-	CR7HIX	7544
Utility (A2008KUB2BUS)	90	1	2008-2008	0,7	CR7HSA	4549	-	CR7HIX	7544
Utility 2x4 (A2009KUB2BUS)	90	1	2009-2009	0,7	CR7HSA	4549	-	CR7HIX	7544
Utility 2x4 (A2010KUB2BUS)	90	1	2010-2010	0,7	CR7HSA	4549	-	CR7HIX	7544
Utility 2x4 (A2011KUB2BUS)	90	1	2011-2011	0,7	CR7HSA	4549	-	CR7HIX	7544
Utility 2x4 (A2012KUB2BUS)	90	1	2012-2012	0,7	CR7HSA	4549	-	CR7HIX	7544
Utility 2x4 (A2013KUB2BUS)	90	1	2013-2013	0,7	CR7HSA	4549	-	CR7HIX	7544
Utility 2x4 (A2014KUB2BUS)	90	1	2014-2014	0,7	CR7HSA	4549	-	CR7HIX	7544
Y-12 Youth (A2003ATB2BUS)	90	1	2003-2003	0,7	BPR7HS	6422	Q215	BPR7HIX	5944
Y-12 Youth (A2005H4B2BUS)	90	1	2005-2005	0,7	CR6HSA	2983	-	CR6HIX	7274
Y-12 Youth 2 Stroke (A2004ATB2BUS)	90	1	2004-2004	0,7	BPR7HS	6422	Q215	BPR7HIX	5944
Y-12 Youth 4 Stroke (A2004H4B2BUS)	90	1	2004-2004	0,7	CR6HSA	2983	-	CR6HIX	7274
Youth	90	1	2006-	0,7	CR7HSA	4549	-	CR7HIX	7544
Utility 2x4 Auto (A2009KYC2BUS)	150	1	2009-2009	0,6	DR8EA	7162	-	DR8EIX	6681
Utility 2x4 Auto (A2010KYC2BUS)	150	1	2010-2010	0,6	D8EA	2120	Q216	DR8EIX	6681
Utility 2x4 Auto (A2011KYC2BUS)	150	1	2011-2011	0,6	D8EA	2120	Q216	DR8EIX	6681
Utility 2x4 Auto (A2012KYC2BUS)	150	1	2012-2012	0,6	D8EA	2120	Q216	DR8EIX	6681
Utility 2x4 Auto (A2013KYC2BUS)	150	1	2013-2013	0,6	D8EA	2120	Q216	DR8EIX	6681
Utility 2x4 Auto (A2014KYC2BUS)	150	1	2014-2014	0,6	D8EA	2120	Q216	DR8EIX	6681
2x4 (99A2J-AP)	250	1	1999-1999	0,7	DR7EA	7839	-	DR7EIX	5686
2x4 (A2000ATE2AUS)	250	1	2000-2000	0,7	DR7EA	7839	-	DR7EIX	5686
2x4 (A2001ATE2AUS)	250	1	2001-2001	0,7	DR7EA	7839	-	DR7EIX	5686
2x4 (A2002ATE2AUS)	250	1	2002-2002	0,7	DR7EA	7839	-	DR7EIX	5686
2x4 (A2003ATE2AUS)	250	1	2003-2003	0,7	DR7EA	7839	-	DR7EIX	5686
2x4 (A2004ATE2AUS)	250	1	2004-2004	0,7	DR7EA	7839	-	DR7EIX	5686
2X4 (A2005ATE2AUS)	250	1	2005-2005	0,7	DR7EA	7839	-	DR7EIX	5686
4x4 (A2001ATE4AUS)	250	1	2001-2001	0,7	DR7EA	7839	-	DR7EIX	5686
4x4 (A2002ATE4AUS)	250	1	2002-2002	0,7	DR7EA	7839	-	DR7EIX	5686
4x4 (A2003ATE4AUS)	250	1	2003-2003	0,7	DR7EA	7839	-	DR7EIX	5686
4x4 (A2004ATE4AUS)	250	1	2004-2004	0,7	DR7EA	7839	-	DR7EIX	5686
4X4 (A2005ATE4AUS)	250	1	2005-2005	0,7	DR7EA	7839	-	DR7EIX	5686
DVX (A2006KSE2BUS)	250	1	2006-2006	0,9	DPR7EA-9	5129	Q220	DPR7EIX-9	7803
DVX (A2007KSE2BUS)	250	1	2007-2007	0,9	DPR7EA-9	5129	Q220	DPR7EIX-9	7803
DVX (A2008KSE2BUS)	250	1	2008-2008	0,9	DPR7EA-9	5129	Q220	DPR7EIX-9	7803
Utility (A2006KUE2BUS)	250	1	2006-2006	0,9	DPR7EA-9	5129	Q220	DPR7EIX-9	7803
Utility (A2007KUE2BUS)	250	1	2007-2007	0,9	DPR7EA-9	5129	Q220	DPR7EIX-9	7803
Utility (A2008KUE2BUS)	250	1	2008-2008	0,9	DPR7EA-9	5129	Q220	DPR7EIX-9	7803
Utility 2x4 Auto (A2009KUE2BUS)	250	1	2009-2009	0,9	DPR7EA-9	5129	Q220	DPR7EIX-9	7803
2x4 (98A2C)	300	1	1998-1998	0,7	DR7EA	7839	-	DR7EIX	5686
2x4 (99A2C-AP)	300	1	1999-1999	0,7	DR7EA	7839	-	DR7EIX	5686
2x4 (A2000ATF2AUS)	300	1	2000-2000	0,7	DR7EA	7839	-	DR7EIX	5686
2x4 (A2001ATF2AUS)	300	1	2001-2001	0,7	DR7EA	7839	-	DR7EIX	5686
2x4 (A2002ATF2AUS)	300	1	2002-2002	0,7	DR7EA	7839	-	DR7EIX	5686
2x4 (A2003ATF2AUS)	300	1	2003-2003	0,7	DR7EA	7839	-	DR7EIX	5686
300 4x4	300	1	2004-	0,7	DR7EA	7839	-	DR7EIX	5686
4x4 (98A4C)	300	1	1998-1998	0,7	DR7EA	7839	-	DR7EIX	5686
4x4 (99A4C-AP)	300	1	1999-1999	0,7	DR7EA	7839	-	DR7EIX	5686

* Bitte Elektrodenabstand nach Angaben des Herstellers justieren

* Please adjust the groundelectrode gap

* Veuillez vérifier L' écartement

* Por favor, ajustar distancia entre electrodos

* regolare il gap

C
Y
L

Stock-№

Quick-№



Stock-№ IX

ARCTIC CAT

4x4 (A2000ATF4AUS)	300	1	2000-2000	0,7	DR7EA	7839	-	DR7EIX	5686
4x4 (A2001ATF4AUS)	300	1	2001-2001	0,7	DR7EA	7839	-	DR7EIX	5686
4x4 (A2002ATF4AUS)	300	1	2002-2002	0,7	DR7EA	7839	-	DR7EIX	5686
4x4 (A2003ATF4AUS)	300	1	2003-2003	0,7	DR7EA	7839	-	DR7EIX	5686
4x4 (A2004ATF4AUS)	300	1	2004-2004	0,7	DR7EA	7839	-	DR7EIX	5686
4x4 (A2005ATF4AUS)	300	1	2005-2005	0,7	DR7EA	7839	-	DR7EIX	5686
DVX 2x4 (A2010KSF2BUS)	300	1	2010-2010	0,9	DPR7EA-9	5129	Q220	DPR7EIX-9	7803
DVX 2x4 (A2011KSF2BUS)	300	1	2011-2011	0,9	DPR7EA-9	5129	Q220	DPR7EIX-9	7803
DVX 2x4 (A2012KSF2BUS)	300	1	2012-2012	0,9	DPR7EA-9	5129	Q220	DPR7EIX-9	7803
DVX 2x4 (A2013KSF2BUS)	300	1	2013-2013	0,9	DPR7EA-9	5129	Q220	DPR7EIX-9	7803
DVX 2x4 (A2014KSF2BUS)	300	1	2014-2014	0,9	DPR7EA-9	5129	Q220	DPR7EIX-9	7803
DVX Sport Auto (A2009KSF2BUSP)	300	1	2009-2009	0,9	DPR7EA-9	5129	Q220	DPR7EIX-9	7803
Utility 2x4 (A2010KUF2BUS)	300	1	2010-2010	0,9	DPR7EA-9	5129	Q220	DPR7EIX-9	7803
Utility 2x4 (A2011KUF2BUS)	300	1	2011-2011	0,9	DPR7EA-9	5129	Q220	DPR7EIX-9	7803
Utility 2x4 (A2012KUF2BUS)	300	1	2012-2012	0,9	DPR7EA-9	5129	Q220	DPR7EIX-9	7803
Utility 2x4 (A2013KUF2BUS)	300	1	2013-2013	0,9	DPR7EA-9	5129	Q220	DPR7EIX-9	7803
Utility 2x4 (A2014KUF2BUS)	300	1	2014-2014	0,9	DPR7EA-9	5129	Q220	DPR7EIX-9	7803
CR (A2011IRG4BUS)	350	1	2011-2011	0,7	CR8E	1275	Q226	CR8EIX	4218
CR (A2011IRG4BUS)	350	1	2012-2012	0,7	CR8E	1275	Q226	CR8EIX	4218
4x4 Auto (A2008IDG4BUS)	366	1	2008-2008	0,7	CR8E	1275	Q226	CR8EIX	4218
4x4 Auto (A2009IDG4BUS)	366	1	2009-2009	0,7	CR8E	1275	Q226	CR8EIX	4218
4x4 Auto (A2010IDG4BUS)	366	1	2010-2010	0,7	CR8E	1275	Q226	CR8EIX	4218
4x4 Auto SE (A2010IDG4BUS)	366	1	2011-2011	0,7	CR8E	1275	Q226	CR8EIX	4218
2x4 Auto (A2002ATG2BUS)	375	1	2002-2002	0,7	CR7E	4578	Q225	CR7EIX	7385
4x2 & 4x4	375		2001-	0,7	CR7E	4578	Q225	CR7EIX	7385
4x4 Auto (A2002ATG4BUS)	375	1	2002-2002	0,7	CR7E	4578	Q225	CR7EIX	7385
2x4 (98A2E)	400	1	1998-1998	0,7	CR8E	1275	Q226	CR8EIX	4218
2x4 (99A2E-AP)	400	1	1999-1999	0,7	CR6E	6965	-	-	-
2x4 (A2000ATI2AUS)	400	1	2000-2000	0,7	CR6E	6965	-	-	-
2x4 (A2001ATI2AUS)	400	1	2001-2001	0,7	CR6E	6965	-	-	-
4x4 (98A4E)	400	1	1998-1998	0,7	CR8E	1275	Q226	CR8EIX	4218
4x4 (99A4E-AP)	400	1	1999-1999	0,7	CR6E	6965	-	-	-
4x4 (A2000ATI4AUS)	400	1	2000-2000	0,7	CR6E	6965	-	-	-
4x4 (A2001ATI4AUS)	400	1	2001-2001	0,7	CR6E	6965	-	-	-
4x4 Auto (A2003ATH4BUS)	400	1	2003-2003	0,7	CR7E	4578	Q225	CR7EIX	7385
4x4 Auto (A2004ATH4BUS)	400	1	2004-2004	0,7	CR7E	4578	Q225	CR7EIX	7385
4x4 Auto CR (A2013IRG4BUS)	400	1	2013-2013	0,7	CR8E	1275	Q226	CR8EIX	4218
4x4 Auto CR (A2014IRG4BUS)	400	1	2014-2014	0,7	CR8E	1275	Q226	CR8EIX	4218
4x4 Manual (A2003ATH4AUS)	400	1	2003-2003	0,7	CR7E	4578	Q225	CR7EIX	7385
4x4 Manual (A2004ATH4AUS)	400	1	2004-2004	0,7	CR7E	4578	Q225	CR7EIX	7385
DVX (A2004DVI2AUS)	400	1	2004-2004	0,7	CR7E	4578	Q225	CR7EIX	7385
DVX (A2006DVI2AUS)	400	1	2006-2006	0,7	CR7E	4578	Q225	CR7EIX	7385
DVX (A2007DVI2AUS)	400	1	2007-2007	0,7	CR7E	4578	Q225	CR7EIX	7385
DVX (A2008DVI2AUS)	400	1	2008-2008	0,7	CR7E	4578	Q225	CR7EIX	7385
EFT 2x4	400	1	2014-2014	0,7	CR8E	1275	Q226	CR8EIX	4218
EFT 4x4	400	1	2014-2014	0,7	CR8E	1275	Q226	CR8EIX	4218
FIS 2x4 Auto (A2003ISH2BUS)	400	1	2003-2003	0,7	CR7E	4578	Q225	CR7EIX	7385
FIS 2x4 Auto (A2004ISH2BUS)	400	1	2004-2004	0,7	CR7E	4578	Q225	CR7EIX	7385
FIS 2x4 Manual (A2002ISI2AUS)	400	1	2002-2002	0,7	CR6E	6965	-	-	-
FIS 2x4 Manual (A2003ISH2AUS)	400	1	2003-2003	0,7	CR7E	4578	Q225	CR7EIX	7385
FIS 2x4 Manual (A2004ISH2AUS)	400	1	2004-2004	0,7	CR7E	4578	Q225	CR7EIX	7385

* Bitte Elektrodenabstand nach Angaben des Herstellers justieren

* Please adjust the groundelectrode gap

* Veuillez vérifier L' écartement

* Por favor, ajustar distancia entre electrodos

* regolare il gap

C
Y
L

Stock-No

Quick-No



Stock-No IX

ARCTIC CAT

FIS 4x4 Auto (A2003ISH4BUS)	400	1	2003-2003	0,7	CR7E	4578	Q225	CR7EIX	7385
FIS 4x4 Auto (A2004ISH4BUS)	400	1	2004-2004	0,7	CR7E	4578	Q225	CR7EIX	7385
FIS 4x4 Auto (A2005ISH4BGMC)	400	1	2005-2005	0,7	CR7E	4578	Q225	CR7EIX	7385
FIS 4x4 Auto (A2005ISH4BUS)	400	1	2005-2005	0,7	CR7E	4578	Q225	CR7EIX	7385
FIS 4x4 Auto (A2006ICH4BUS)	400	1	2006-2006	0,7	CR7E	4578	Q225	CR7EIX	7385
FIS 4x4 Auto (A2007ICH4BUS)	400	1	2007-2007	0,7	CR7E	4578	Q225	CR7EIX	7385
FIS 4x4 Auto (A2008ICH4BUS)	400	1	2008-2008	0,7	CR7E	4578	Q225	CR7EIX	7385
FIS 4x4 Manual (A2002ISI4AUS)	400	1	2002-2002	0,7	CR6E	6965	-	-	-
FIS 4x4 Manual (A2003ISH4AUS)	400	1	2003-2003	0,7	CR7E	4578	Q225	CR7EIX	7385
FIS 4x4 Manual (A2004ISH4AUS)	400	1	2004-2004	0,7	CR7E	4578	Q225	CR7EIX	7385
FIS 4x4 Manual (A2005ISH4AUS)	400	1	2005-2005	0,7	CR7E	4578	Q225	CR7EIX	7385
FIS 4x4 Manual (A2006ICH4AUS)	400	1	2006-2006	0,7	CR7E	4578	Q225	CR7EIX	7385
FIS 4x4 Manual (A2007ICH4AUS)	400	1	2007-2007	0,7	CR7E	4578	Q225	CR7EIX	7385
FIS 4x4 Manual (A2008ICH4AUS)	400	1	2008-2008	0,7	CR7E	4578	Q225	CR7EIX	7385
i 4x2 & 4x4	400		1998-	0,7	CR8E	1275	Q226	CR8EIX	4218
i 4x2 & 4x4	400		2004-	0,7	CR7E	4578	Q225	CR7EIX	7385
Manual (A2002ATI4AUS)	400	1	2002-2002	0,7	CR6E	6965	-	-	-
TBX	400		2004-	0,7	CR7E	4578	Q225	CR7EIX	7385
TBX 4x4 Auto (A2004BXH4BUS)	400	1	2004-2004	0,7	CR7E	4578	Q225	CR7EIX	7385
TBX 4x4 Auto (A2005BBH4BUS)	400	1	2005-2005	0,7	CR7E	4578	Q225	CR7EIX	7385
TBX 4x4 Auto (A2006BBH4BUS)	400	1	2006-2006	0,7	CR7E	4578	Q225	CR7EIX	7385
TRV 400	400	1	2014-2014	0,7	CR8E	1275	Q226	CR8EIX	4218
TRV 4x4 Auto (A2006TBH4BUS)	400	1	2006-2006	0,7	CR7E	4578	Q225	CR7EIX	7385
TRV 4x4 Auto (A2007TBH4BUS)	400	1	2007-2007	0,7	CR7E	4578	Q225	CR7EIX	7385
TRV 4x4 Auto (A2008TBH4BUS)	400	1	2008-2008	0,7	CR7E	4578	Q225	CR7EIX	7385
TRV 4x4 Auto (A2009TBG4BUS)	400	1	2009-2009	0,7	CR8E	1275	Q226	CR8EIX	4218
TRV 4x4 Auto (A2010TBG4BUS)	400	1	2010-2010	0,7	CR8E	1275	Q226	CR8EIX	4218
TRV 4x4 Auto (A2011TBG4BUS)	400	1	2011-2011	0,7	CR8E	1275	Q226	CR8EIX	4218
TRV 4x4 Auto (A2012TBG4BUS)	400	1	2012-2012	0,7	CR8E	1275	Q226	CR8EIX	4218
TRV 4x4 Auto (A2013TBG4BUS)	400	1	2013-2013	0,7	CR8E	1275	Q226	CR8EIX	4218
VP 4x4 Auto (A2005ATH4BUS)	400	1	2005-2005	0,7	CR7E	4578	Q225	CR7EIX	7385
VP 4x4 Auto (A2006ABH4BUS)	400	1	2006-2006	0,7	CR7E	4578	Q225	CR7EIX	7385
VP 4x4 Manual (A2005ATH4AUS)	400	1	2005-2005	0,7	CR7E	4578	Q225	CR7EIX	7385
VP 4x4 Manual (A2006ABH4AUS)	400	1	2006-2006	0,7	CR7E	4578	Q225	CR7EIX	7385
4x4 CR (A2012IRK4CUS)	425	1	2012-2012	0,7	CR7E	4578	Q225	CR7EIX	7385
4x4 EFI CR (A2011IRK4CUS)	425	1	2011-2011	0,7	CR7E	4578	Q225	CR7EIX	7385
4x4	450		-2001	0,7	CR8E	1275	Q226	CR8EIX	4218
4x4 (A2012ICK4C)	450	1	2012-2012	0,7	CR7E	4578	Q225	CR7EIX	7385
4x4 (A2014IRK4C)	450	1	2014-2014	0,7	CR7E	4578	Q225	CR7EIX	7385
4x4 EFI (A2010ICK4C)	450	1	2010-2010	0,7	CR7E	4578	Q225	CR7EIX	7385
4x4 EFI (A2011ICK4C)	450	1	2011-2011	0,7	CR8E	1275	Q226	CR8EIX	4218
CR (A2013IRK4CUS)	450	1	2013-2013	0,7	CR7E	4578	Q225	CR7EIX	7385
EFT	450	1	2014-2014	0,7	CR7E	4578	Q225	CR7EIX	7385
GT (A2012BGK2P)	450	1	2012-2012	0,7	CR7E	4578	Q225	CR7EIX	7385
TRV (A2012TBK4C)	450	1	2012-2012	0,7	CR7E	4578	Q225	CR7EIX	7385
TRV EFI (A2011TBK4C)	450	1	2010-2010	0,7	CR7E	4578	Q225	CR7EIX	7385
TRV GT (A2012TGK2P)	450	1	2012-2012	0,7	CR7E	4578	Q225	CR7EIX	7385
XC EFI	450	1	2014-2014	0,7	CR7E	4578	Q225	CR7EIX	7385
XC EFI (A2011KCK4C)	450	1	2011-2011	0,7	CR7E	4578	Q225	CR7EIX	7385
XC EFI (A2012KCK4C)	450	1	2012-2012	0,7	CR7E	4578	Q225	CR7EIX	7385
XC EFI (A2013KCK4C)	450	1	2013-2013	0,7	CR7E	4578	Q225	CR7EIX	7385
2x4 (98A2A)	454	1	1998-1998	0,7	CR8E	1275	Q226	CR8EIX	4218

* Bitte Elektrodenabstand nach Angaben des Herstellers justieren

* Please adjust the groundelectrode gap

* Veuillez vérifier L' écartement

* Por favor, ajustar distancia entre electrodos

* regolare il gap

C
y
I

0201



Stock-Nº

Quick-Nº



Stock-Nº IX

ARCTIC CAT

4x4 (98A4A)	454	1	1998-1998	0,7	CR8E	1275	Q226	CR8EIX	4218
Bearcat 4x4 (96A4A-AP)	454	1	1996-1996	0,7	CR8E	1275	Q226	CR8EIX	4218
4x4 (98A4G)	500	1	1998-1998	0,7	CR7E	4578	Q225	CR7EIX	7385
4x4 (99A4G-AP)	500	1	1999-1999	0,7	CR6E	6965	-	-	-
4x4 (A2000ATM4AUS)	500	1	2000-2000	0,7	CR6E	6965	-	-	-
4x4 (A2013ICK4C)	500	1	2013-2013	0,7	CR7E	4578	Q225	CR7EIX	7385
4x4 (A2014ICK4C)	500	1	2014-2014	0,7	CR7E	4578	Q225	CR7EIX	7385
4x4 Auto (A2009IBM4BUS)	500	1	2009-2009	0,7	CR6E	6965	-	-	-
4x4 Manual (A2009IBM4AUS)	500	1	2009-2009	0,7	CR6E	6965	-	-	-
4x4 Méca	500		1999-	0,7	CR6E	6965	-	-	-
4x4 XT (A2013BSK4C)	500	1	2013-2013	0,7	CR7E	4578	Q225	CR7EIX	7385
4x4 XT (A2014BSK4C)	500	1	2014-2014	0,7	CR7E	4578	Q225	CR7EIX	7385
Auto (A2000ATM4BUS)	500	1	2000-2000	0,7	CR6E	6965	-	-	-
Auto (A2001ATM4BUS)	500	1	2001-2001	0,7	CR6E	6965	-	-	-
Auto (A2002ATM4BUS)	500	1	2002-2002	0,7	CR6E	6965	-	-	-
FIS Auto (A2002ISM4BUS)	500	1	2002-2002	0,7	CR6E	6965	-	-	-
FIS Auto (A2003ISM4BUS)	500	1	2003-2003	0,7	CR6E	6965	-	-	-
FIS Auto 4x4 (A2004ISM4BUS)	500	1	2004-2004	0,7	CR6E	6965	-	-	-
FIS Auto 4x4 (A2005IBM4BUS)	500	1	2005-2005	0,7	CR6E	6965	-	-	-
FIS Auto 4x4 (A2006IBM4BUS)	500	1	2006-2006	0,7	CR6E	6965	-	-	-
FIS Auto 4x4 (A2007IBM4BUS)	500	1	2007-2007	0,7	CR6E	6965	-	-	-
FIS Auto 4x4 (A2008IBM4BUS)	500	1	2008-2008	0,7	CR6E	6965	-	-	-
FIS Manual (A2002ISM4AUS)	500	1	2002-2002	0,7	CR6E	6965	-	-	-
FIS Manual (A2003ISM4AUS)	500	1	2003-2003	0,7	CR6E	6965	-	-	-
FIS Manual 4x4 (A2004ISM4AUS)	500	1	2004-2004	0,7	CR6E	6965	-	-	-
FIS Manual 4x4 (A2005IBM4AUS)	500	1	2005-2005	0,7	CR6E	6965	-	-	-
FIS Manual 4x4 (A2006IBM4AUS)	500	1	2006-2006	0,7	CR6E	6965	-	-	-
FIS Manual 4x4 (A2007IBM4AUS)	500	1	2007-2007	0,7	CR6E	6965	-	-	-
FIS Manual 4x4 (A2008IBM4AUS)	500	1	2008-2008	0,7	CR6E	6965	-	-	-
i 4x4 Auto	500		2000-2002	0,7	CR6E	6965	-	-	-
Manual (A2001ATM4AUS)	500	1	2001-2001	0,7	CR6E	6965	-	-	-
Manual (A2002ATM4AUS)	500	1	2002-2002	0,7	CR6E	6965	-	-	-
TBX 4x4	500		2001-	0,7	CR6E	6965	-	-	-
TBX Auto 4x4 (A2002BXM4BUS)	500		2002-2002	0,7	CR6E	6965	-	-	-
TBX Auto 4x4 (A2003BXM4BUS)	500		2003-2003	0,7	CR6E	6965	-	-	-
TBX Auto 4x4 (A2004BXM4BUS)	500		2004-2004	0,7	CR6E	6965	-	-	-
TBX Auto 4x4 (A2005BBM4BUS)	500		2005-2005	0,7	CR6E	6965	-	-	-
TBX Auto 4X4 (A2006BBM4BUS)	500		2006-2006	0,7	CR6E	6965	-	-	-
TRV 4X4 (A2013TBK4C)	500		2013-2013	0,7	CR7E	4578	Q225	CR7EIX	7385
TRV 4X4 (A2014TBK4C)	500		2014-2014	0,7	CR7E	4578	Q225	CR7EIX	7385
TRV Auto (A2003TDM4BUS)	500		2003-2003	0,7	CR6E	6965	-	-	-
TRV Auto 4X4 (A2004TDM4BUS)	500		2004-2004	0,7	CR6E	6965	-	-	-
TRV Auto 4X4 (A2005TDM4BUS)	500		2005-2005	0,7	CR6E	6965	-	-	-
TRV Auto 4X4 (A2006TBM4BUS)	500		2006-2006	0,7	CR6E	6965	-	-	-
TRV Auto 4X4 (A2008TBM4BUS)	500		2008-2008	0,7	CR6E	6965	-	-	-
4x4 (A2012IC04E)	550	1	2012-2012	0,7	CPR8E	7411	-	-	-
4x4 (A2013IC04E)	550	1	2013-2013	0,7	CPR8E	7411	-	-	-
4x4 (A2014IC04E)	550	1	2014-2014	0,7	CPR8E	7411	-	-	-
550 EFT	550	1	2014-2014	0,7	CPR8E	7411	-	-	-
GT (A2012BG01P)	550	1	2012-2012	0,7	CPR8E	7411	-	-	-
H1 4x4 Auto EFI (A2009IB04E)	550	1	2009-2009	0,7	CPR8E	7411	-	-	-
H1 4x4 Auto EFI (A2010IC04E)	550	1	2010-2010	0,7	CPR8E	7411	-	-	-

* Bitte Elektrodenabstand nach Angaben des Herstellers justieren

* Please adjust the groundelectrode gap

* Veuillez vérifier L' écartement

* Por favor, ajustar distancia entre electrodos

* regolare il gap

C
Y
L

Stock-No

Quick-No



Stock-No IX

ARCTIC CAT

H1 4x4 Auto EFI (A2011IC04E)	550	1	2011-2011	0,7	CPR8E	7411	-	-	-
H1 550s EFI (A2010IC01P)	550	1	2010-2010	0,7	CPR8E	7411	-	-	-
H1 550s EFI (A2011IC01P)	550	1	2011-2011	0,7	CPR8E	7411	-	-	-
H1 550s TRV EFI (A2011TC01P)	550	1	2011-2011	0,7	CPR8E	7411	-	-	-
H1 TRV EFI (A2011TB04E)	550	1	2011-2011	0,7	CPR8E	7411	-	-	-
LTD (A2012BL01P)	550	1	2012-2012	0,7	CPR8E	7411	-	-	-
LTD (A2013BL01P)	550	1	2013-2013	0,7	CPR8E	7411	-	-	-
LTD (A2014BL01P)	550	1	2014-2014	0,7	CPR8E	7411	-	-	-
TRV (A2009TB04E)	550	1	2009-2009	0,7	CPR8E	7411	-	-	-
TRV (A2010TB04E)	550	1	2010-2010	0,7	CPR8E	7411	-	-	-
TRV 550s EFI (A2010TB01PUS)	550	1	2010-2010	0,7	CPR8E	7411	-	-	-
TRV 550s EFI GT (A2011TB01P)	550	1	2011-2011	0,7	CPR8E	7411	-	-	-
TRV Cruiser (A2012TC01P)	550	1	2012-2012	0,7	CPR8E	7411	-	-	-
TRV GT (A2012TG01P)	550	1	2012-2012	0,7	CPR8E	7411	-	-	-
TRV LTD	550	1	2015-2015	0,7	CPR8E	7411	-	-	-
TRV LTD (A2013TC01P)	550	1	2013-2013	0,7	CPR8E	7411	-	-	-
TRV LTD (A2014TC01P)	550	1	2014-2014	0,7	CPR8E	7411	-	-	-
TRV XT	550	1	2014-2014	0,7	CPR8E	7411	-	-	-
TRV XT	550	1	2015-2015	0,7	CPR8E	7411	-	-	-
TRV XT (A2013TG01P)	550	1	2013-2013	0,7	CPR8E	7411	-	-	-
TRV XT EFT	550	1	2014-2014	0,7	CPR8E	7411	-	-	-
TRV XT EFT	550	1	2015-2015	0,7	CPR8E	7411	-	-	-
XT (A2013BG01P)	550	1	2013-2013	0,7	CPR8E	7411	-	-	-
XT (A2014BG01P)	550	1	2014-2014	0,7	CPR8E	7411	-	-	-
XT EFT	550	1	2014-2014	0,7	CPR8E	7411	-	-	-
4x4 (A2012ICS4B)	650		2012-2012	0,7	CPR8E	7411	-	-	-
4x4 Auto (A2010ICS4B)	650		2010-2010	0,7	CPR8E	7411	-	-	-
4x4 Auto Mud Pro (A2010IFS4BUS)	650		2010-2010	0,7	CPR8E	7411	-	-	-
4x4 V2 Auto	650		2004-2005	0,7	CR7E	4578	Q225	CR7EIX	7385
FIS 4x4 V-2 (A2004ISR4B)	650	2	2004-2004	0,7	CR7E	4578	Q225	CR7EIX	7385
FIS 4x4 V-2 (A2005IBR4B)	650	2	2005-2005	0,7	CR7E	4578	Q225	CR7EIX	7385
FIS 4x4 V-Twin Auto (A2006IBR4B)	650	2	2006-2006	0,7	CR7E	4578	Q225	CR7EIX	7385
H1 4x4	650	1	2010-	0,6	CPR8E	7411	-	-	-
H1 4x4 (A2005IBS4BUS)	650		2005-2005	0,7	CPR8E	7411	-	-	-
H1 4x4 Auto (A2006IBS4B)	650		2006-2006	0,7	CPR8E	7411	-	-	-
H1 4x4 Auto (A2011ICS4B)	650		2011-2011	0,7	CPR8E	7411	-	-	-
H1 FIS 4x4 Auto (A2007IBS4BUS)	650		2007-2007	0,7	CPR8E	7411	-	-	-
H1 FIS 4x4 Auto (A2008IBS4BUS)	650		2008-2008	0,7	CPR8E	7411	-	-	-
H1 Mud Pro 4x4 (A2011IFS4B)	650	1	2011-2011	0,6	CPR8E	7411	-	-	-
H1 TBX 4x4 Auto (A2007BBS4BUS)	650		2007-2007	0,7	CPR8E	7411	-	-	-
H1 TRV 4x4 Auto (A2007TBS4BUS)	650		2007-2007	0,7	CPR8E	7411	-	-	-
H1 TRV 4x4 Auto (A2008TBS4BUS)	650		2008-2008	0,7	CPR8E	7411	-	-	-
TBX (A2009BBS4BUS)	650	1	2009-2009	0,7	CPR8E	7411	-	-	-
TRV (A2009TBS4BUS)	650	1	2009-2009	0,7	CPR8E	7411	-	-	-
4x4 (A2012IBT4E)	700	1	2012-2012	0,7	CPR8E	7411	-	-	-
4x4 (A2013IBT4E)	700	1	2013-2013	0,7	CPR8E	7411	-	-	-
4x4 (A2014IBT4E)	700	1	2014-2014	0,7	CPR8E	7411	-	-	-
EFT	700	1	2014-2014	0,7	CPR8E	7411	-	-	-
FIS 4x4 Auto (A2006IBT4CUS)	700		2006-2006	0,7	CR6E	6965	-	-	-
FIS 4x4 Auto (A2007IBT4CUS)	700		2007-2007	0,7	CR6E	6965	-	-	-
FIS 4x4 Auto EFI (A2008IBT4CUS)	700		2008-2008	0,7	CR6E	6965	-	-	-
GT (A2012AGT1P)	700		2012-2012	0,7	CPR8E	7411	-	-	-

* Bitte Elektrodenabstand nach Angaben des Herstellers justieren

* Please adjust the groundelectrode gap

* Veuillez vérifier L' écartement

* Por favor, ajustar distancia entre electrodos

* regolare il gap

C
y
I

0201



Stock-№

Quick-№



Stock-№ IX

ARCTIC CAT

GT (A2013AGT1P)	700		2013-2013	0,7	CPR8E	7411	-	-	-
H1 700s EFI (A2010IBT1P)	700		2010-2010	0,7	CPR8E	7411	-	-	-
H1 700s EFI (A2011IBT1P)	700		2011-2011	0,7	CPR8E	7411	-	-	-
H1 700s EFI TBX (A2011BBT1P)	700		2011-2011	0,7	CPR8E	7411	-	-	-
H1 700s EFI TRV (A2010TBT1P)	700		2010-2010	0,7	CPR8E	7411	-	-	-
H1 700s EFI TRV (A2011TBT1P)	700		2011-2011	0,7	CPR8E	7411	-	-	-
H1 EFI 4x4 Auto (A2009IBT4E)	700		2009-2009	0,7	CPR8E	7411	-	-	-
H1 EFI 4x4 Auto (A2010IBT4E)	700		2010-2010	0,7	CPR8E	7411	-	-	-
H1 EFI 4x4 Auto (A2011IBT4E)	700		2011-2011	0,7	CPR8E	7411	-	-	-
H1 EFI 4x4 Auto Mud Pro (A2009IFT4E)	700	1	2009-2009	0,6	CPR8E	7411	-	-	-
H1 EFI 4x4 Auto Mud Pro (A2010IFT4E)	700		2010-2010	0,7	CPR8E	7411	-	-	-
H1 EFI 4x4 Auto Mud Pro (A2011IFT4E)	700		2011-2011	0,7	CPR8E	7411	-	-	-
H1 EFI 4x4 TBX (A2010BBT4E)	700	1	2010-2010	0,6	CPR8E	7411	-	-	-
H1 FIS 4x4 Auto FIE (A2008IBT4EUS)	700		2008-2008	0,7	CPR8E	7411	-	-	-
LTD (A2012ALT1P)	700	1	2012-2012	0,6	CPR8E	7411	-	-	-
LTD (A2013ALT1P)	700	1	2013-2013	0,6	CPR8E	7411	-	-	-
LTD (A2014ALT1P)	700	1	2014-2014	0,6	CPR8E	7411	-	-	-
Mud Pro (A2012IFT4E)	700	1	2012-2012	0,6	CPR8E	7411	-	-	-
Mud Pro (A2013MLT1P)	700	1	2013-2013	0,6	CPR8E	7411	-	-	-
Mud Pro LTD (A2012MLT1P)	700	1	2012-2012	0,6	CPR8E	7411	-	-	-
Mud Pro LTD (A2014MLT1P)	700	1	2014-2014	0,6	CPR8E	7411	-	-	-
TBX (A2013BCT1P)	700	1	2013-2013	0,6	CPR8E	7411	-	-	-
TBX (A2014BBT4E)	700	1	2014-2014	0,6	CPR8E	7411	-	-	-
TBX 700 T3S	700	1	2014-2014	0,6	CPR8E	7411	-	-	-
TBX GT (A2012BCT1P)	700	1	2012-2012	0,6	CPR8E	7411	-	-	-
TRV (A2010TBT4EUS)	700	1	2010-2010	0,6	CPR8E	7411	-	-	-
TRV (A2011TBT4EUS)	700	1	2011-2011	0,6	CPR8E	7411	-	-	-
TRV 4x4 Auto EFI (A2008TCT4CUS)	700	1	2008-2008	0,7	CR6E	6965	-	-	-
TRV 4x4 Auto LE (A2008TBT4CUS)	700	1	2008-2008	0,7	CR6E	6965	-	-	-
TRV 700s Cruiser (A2011TCT1PUS)	700	1	2011-2011	0,6	CPR8E	7411	-	-	-
TRV Cruiser (A2009TCT4E)	700	1	2009-2009	0,6	CPR8E	7411	-	-	-
TRV Cruiser (A2010TCT4E)	700	1	2010-2010	0,6	CPR8E	7411	-	-	-
TRV Cruiser (A2012TCT1P)	700	1	2012-2012	0,6	CPR8E	7411	-	-	-
TRV GT (A2012TGT1P)	700	1	2012-2012	0,6	CPR8E	7411	-	-	-
TRV LTD	700	1	2015-2015	0,6	CPR8E	7411	-	-	-
TRV LTD (A2013TGT1P)	700	1	2013-2013	0,6	CPR8E	7411	-	-	-
TRV LTD (A2014TCT1P)	700	1	2014-2014	0,6	CPR8E	7411	-	-	-
TRV XT	700	1	2015-2015	0,6	CPR8E	7411	-	-	-
TRV XT (A2013TGT1P)	700	1	2013-2013	0,6	CPR8E	7411	-	-	-
TRV XT (A2014TGT1P)	700	1	2014-2014	0,6	CPR8E	7411	-	-	-
TRV XT EFT	700	1	2014-2014	0,6	CPR8E	7411	-	-	-
TRV XT EFT	700	1	2015-2015	0,6	CPR8E	7411	-	-	-
XT (A2013AGT1P)	700	1	2013-2013	0,6	CPR8E	7411	-	-	-
XT (A2014AGT1P)	700	1	2014-2014	0,6	CPR8E	7411	-	-	-
XT EFT	700	1	2014-2014	0,6	CPR8E	7411	-	-	-
4X4 Auto Mud Pro (A2010IFW4EUS)	1000	2	2010-2010	0,7	CPR8E	7411	-	-	-
GT (A2012AGW1P)	1000	2	2012-2012	0,6	CPR8E	7411	-	-	-
H2 1000s EFI (A2011IEW1P)	1000	2	2011-2011	0,6	CPR8E	7411	-	-	-
H2 EFI Mud Pro (A2011IFW4E)	1000	2	2011-2011	0,6	CPR8E	7411	-	-	-
Mud Pro (A2013MLW1P)	1000	2	2013-2013	0,6	CPR8E	7411	-	-	-
Mud Pro LTD (A2012MLW1P)	1000	2	2012-2012	0,6	CPR8E	7411	-	-	-
Mud Pro LTD (A2014MLW1P)	1000	2	2014-2014	0,6	CPR8E	7411	-	-	-

* Bitte Elektrodenabstand nach Angaben des Herstellers justieren

* Please adjust the groundelectrode gap

* Veuillez vérifier l' écartement

* Por favor, ajustar distancia entre electrodos

* regolare il gap

C
Y
I

0201



Stock-No

Quick-No



Stock-No IX

ARCTIC CAT

Thundercat 4x4 Auto (A2008IEW4EUS)	1000	2	2008-2008	0,6	CPR8E	7411	-	-	-
Thundercat 4x4 Auto FIS EFI (A2009IEW4EUS)	1000	2	2009-2009	0,6	CPR8E	7411	-	-	-
Thundercat 4x4 EFI (A2010IEW4EUS)	1000	2	2010-2010	0,6	CPR8E	7411	-	-	-
TRV (A2009TBW4EUS)	1000	2	2009-2009	0,6	CPR8E	7411	-	-	-
TRV (A2010TBW4EUS)	1000	2	2010-2010	0,6	CPR8E	7411	-	-	-
TRV 1000 XT EFT	1000	2	2014-2014	0,6	CPR8E	7411	-	-	-
TRV 1000s Cruiser (A2011TCW1P)	1000	2	2011-2011	0,6	CPR8E	7411	-	-	-
TRV Cruiser (A2009TCW4E)	1000	2	2009-2009	0,6	CPR8E	7411	-	-	-
TRV Cruiser (A2010TCW4E)	1000	2	2010-2010	0,6	CPR8E	7411	-	-	-
TRV Cruiser (A2012TCW1P)	1000	2	2012-2012	0,6	CPR8E	7411	-	-	-
TRV GT (A2012TGW1P)	1000	2	2012-2012	0,6	CPR8E	7411	-	-	-
TRV LTD (A2013TCW1P)	1000	2	2013-2013	0,6	CPR8E	7411	-	-	-
TRV LTD (A2014TCW1P)	1000	2	2014-2014	0,6	CPR8E	7411	-	-	-
XT (A2013AGW1P)	1000	2	2013-2013	0,6	CPR8E	7411	-	-	-
XT (A2013AGW1P)	1000	2	2014-2014	0,6	CPR8E	7411	-	-	-
XT EFT	1000	2	2014-2014	0,6	CPR8E	7411	-	-	-
2x4 (97A2A)	-	1	1997-1997	0,7	CR8E	1275	Q226	CR8EIX	4218
4x4 (97A4A)	-	1	1997-1997	0,7	CR8E	1275	Q226	CR8EIX	4218

ATK

Mini Quad	50	1	2001-	0,5	B7HS	5110	Q204	BR7HIX	7067
Mini Quad	90	1	2001-	0,5	B7HS	5110	Q204	BR7HIX	7067

AXR

UT	250		2006-	0,7	DR8EA	7162	-	DR8EIX	6681
----	-----	--	-------	-----	-------	------	---	--------	------

BAROSSA

Mini	50	1	-	0,6	BPR7HS	6422	Q215	BPR7HIX	5944
Python	50	1	-	0,8	BPR7HS	6422	Q215	BPR7HIX	5944
Python	100	1	-	0,8	BPR7HS	6422	Q215	BPR7HIX	5944
XS-T-13	125	1	2007-	0,8	CR7HSA	4549	-	CR7HIX	7544
Magna	150	1	-	0,7	DR8EA	7162	-	DR8EIX	6681
Magna	170	1	-	0,7	DR8EA	7162	-	DR8EIX	6681
Magna	250	1	-	0,7	DR8EA	7162	-	DR8EIX	6681

BLANEY

FX-70	79	1	1999-	0,7	BP7HS	5111	-	BPR7HIX	5944
FX	90	1	2000-	0,7	BP7HS	5111	-	BPR7HIX	5944
FX	100	1	2000-	0,7	BP7HS	5111	-	BPR7HIX	5944

BLAST (LEM)

50	50	1	-	0,5	B7HS	5110	Q204	BR7HIX	7067
100	100	1	-	0,5	B7HS	5110	Q204	BR7HIX	7067

BOSS

X2S1-90R	90	1	-	0,6	BP6HS	4511	-	BPR6HIX	4085
X4SZ-150R	155	1	-	0,6	BP6HS	4511	-	BPR6HIX	4085

* Bitte Elektrodenabstand nach Angaben des Herstellers justieren

* Please adjust the groundelectrode gap

* Veuillez vérifier L' écartement

* Por favor, ajustar distancia entre electrodos

* regolare il gap

C
y
l

0201



Stock-№

Quick-№



Stock-№ IX

CAN-AM / BOMBARDIER

DS	50	1	2002-2003	0,7	BPR7HS	6422	Q215	BPR7HIX	5944
DS-Rotax	50	1	2004-	0,7	BR9ECS	3570	-	-	-
Quest	50	1	2003-	0,8	BPR7HS	6422	Q215	BPR7HIX	5944
Quest	50	1	2004-	0,5	BR9ECS	3570	-	-	-
DS	70	1	2009-	0,7	C6HSA	3228	-	CR6HIX	7274
DS	90	1	2002-2003	0,7	BPR7HS	6422	Q215	BPR7HIX	5944
DS	90	1	2009-	0,7	C6HSA	3228	-	CR6HIX	7274
DS-Rotax 2 Stroke	90	1	2004-	0,7	BR9ECS	3570	-	-	-
DS-Rotax 4 Stroke	90	1	2002-	0,7	CR7HSA	4549	-	CR7HIX	7544
Quest	90	1	2004-	0,5	BR9ECS	3570	-	-	-
Quest 4 Stroke	90	1	2003-	0,7	CR7HSA	4549	-	CR7HIX	7544
Rally	175	1	2003-	0,7	CR8E	1275	Q226	CR8EIX	4218
Rally (4x2)	200	1	2002-2007	0,6	CR8E	1275	Q226	CR8EIX	4218
Rally 200	200	1	2002-2004	0,5	BR9ECS	3570	-	-	-
DS	250	1	2006-	0,6	CR8E	1275	Q226	CR8EIX	4218
HO-325 Outlander 2x4 / 4x4	330	1	2002-	0,6	DCPR8E	4339	-	DCPR8EIX	6546
Outlander 330 (Rotax)	330	1	2004-	0,5	BR9ECS	3570	-	-	-
HO-Outlander 2x4 / 4x4 / XT / Max	400		2004-	0,6	DCPR8E	4339	-	DCPR8EIX	6546
Outlander 4x4	400		2003-	0,6	DCPR8E	4339	-	DCPR8EIX	6546
511 Traxter 4x4 XT / XL	500		2004-	0,6	DR8EA	7162	-	DR8EIX	6681
514 Quest 4x4	500		2004-	0,6	DCPR8E	4339	-	DCPR8EIX	6546
Outlander / Max / XT	500	2	-	0,6	DCPR8E	4339	-	DCPR8EIX	6546
Traxter - Footshift / SM / XL / XT / 4x4	500		2000-2002	0,6	DR8EA	7162	-	DR8EIX	6681
Traxter 7401	500	1	1999-2002	0,7	DR8EA	7162	-	DR8EIX	6681
Traxter 7414	500	1	1998-2002	0,7	DR8EA	7162	-	DR8EIX	6681
Traxter Rotax	500		2003-	0,7	BR9ECS	3570	-	-	-
Quest	644	1	2003-	0,5	BR9ECS	3570	-	-	-
610 Quest	650		2003-	0,7	BR9ECS	3570	-	-	-
610 Quest 4x4, Max, XT	650		2002-2003	0,6	DR8EA	7162	-	DR8EIX	6681
DS 4x2	650		2000-	0,6	DR8EA	7162	-	DR8EIX	6681
DS 654 Baja, Baja X	650		2004-	0,6	DR8EA	7162	-	DR8EIX	6681
Outlander / Max / XT	650	2	2006-	0,6	DCPR8E	4339	-	DCPR8EIX	6546
Outlander H.O.EFI 4x4	650		2004-	0,6	DCPR8E	4339	-	DCPR8EIX	6546
Quest 4x4	650		2002-	0,6	DCPR8E	4339	-	DCPR8EIX	6546
Traxter DS / DR	650	1	2000-2007	0,7	DR8EA	7162	-	DR8EIX	6681
653 Quest DS	653	1	2003-	0,5	BR9ECS	3570	-	-	-
Commander 800	800	2	2011-	0,7	DCPR8E	4179	-	DCR8EIX	3606
Outlander	800		2006-	0,6	DCPR8E	4339	-	DCPR8EIX	6546
Outlander Max R / R XT / XT-P	800	2	-	0,6	DCPR8E	4339	-	DCPR8EIX	6546
Outlander Max R LTD	800	2	-	0,6	DCPR8E	4339	-	DCPR8EIX	6546
Outlander XY / X xc / X mr	800	2	-	0,6	DCPR8E	4339	-	DCPR8EIX	6546
Renegade R, X xc	800	2	2007-	0,6	DCPR8E	4339	-	DCPR8EIX	6546
Commander 1000	1000	2	2011-	0,7	DCPR8E	4179	-	DCR8EIX	3606
Maverick	1000	2	2013-	0,9	LMAR8C-9	93833	-	-	-

CANNONDALE

EX 400	432		2001-	0,7	CR9EK	4548	Q230	CR9EIX	3521
FX 400	432		2000-	0,7	CR9EK	4548	Q230	CR9EIX	3521
MX 400	432		2000-	0,7	CR9EK	4548	Q230	CR9EIX	3521
XC 400	432		2001-	0,7	CR9EK	4548	Q230	CR9EIX	3521
Blaze	440		2002-	0,7	CR9EK	4548	Q230	CR9EIX	3521
Cannibal (4x2)	440		2002-	0,7	CR9EK	4548	Q230	CR9EIX	3521

* Bitte Elektrodenabstand nach Angaben des Herstellers justieren

* Please adjust the groundelectrode gap

* Veuillez vérifier l' écartement

* Por favor, ajustar distancia entre electrodos

* regolare il gap

C
Y
L

0201



Stock-No

Quick-No



Stock-No IX

CANNONDALE

Glamis	440		2003-	0,7	CR9EK	4548	Q230	CR9EIX	3521
Moto	440		2002-	0,7	CR9EK	4548	Q230	CR9EIX	3521
Speed (4x2)	440		2002-	0,7	CR9EK	4548	Q230	CR9EIX	3521

CECTEK

Gladiator EFI	497	1	2007-	0,7	CR7E	4578	Q225	CR7EIX	7385
Quadrift EFI	497	1	2007-	0,7	CR7E	4578	Q225	CR7EIX	7385

COBRA

ECX80 AC	80	1	2009-	0,8	BPR7ES	2023	-	BPR7EIX	4055
----------	----	---	-------	-----	--------	------	---	---------	------

CPI

200	50	1	2003-	0,8	BR7ES	5122	-	BR7EIX	6664
ATV 50	50	1	-	0,7	BR7HS	4122	Q211	BR7HIX	7067
Crab - 4x2	50	1	2002-	0,7	BR8HSA	5539	-	BR8HIX	7001
Dirt Demon - 4x2	50	1	2002-	0,7	BR8HSA	5539	-	BR8HIX	7001
XT 50 R Quad	50	1	-	0,7	BR7HS	4122	Q211	BR7HIX	7067
ATV 100	100	1	-	0,7	BR7HS	4122	Q211	BR7HIX	7067
Crab - 4x2	100	1	2002-	0,7	BR8HSA	5539	-	BR8HIX	7001
Dirt Demon - 4x2	100	1	2002-	0,7	BR8HSA	5539	-	BR8HIX	7001
ATV 200	200	1	-	0,7	BR7HS	4122	Q211	BR7HIX	7067
XS	250	1	2006-	0,8	CR7HSA	4549	-	CR7HIX	7544

DAREN

4x2	50	1	1999-	0,7	BPR7HS	6422	Q215	BPR7HIX	5944
4x2	100	1	1999-	0,7	BPR7HS	6422	Q215	BPR7HIX	5944
4x2	125	1	1999-	0,6	DR8EA	7162	-	DR8EIX	6681
4x2	150	1	1999-	0,6	DR8EA	7162	-	DR8EIX	6681

DERBI

	170	1	-	0,7	DR8EA	7162	-	DR8EIX	6681
DXR	250	1	2004-	0,7	CR8HS	7423	-	CR8HIX	7669

DINLI

Cobia DL-503	50	1	-	0,6	BPR7HS	6422	Q215	BPR7HIX	5944
Diamond Back DL601-50 2 Stroke	50	1	-	0,8	BPR7HS	6422	Q215	BPR7HIX	5944
Dino (4x2)	50	1	2002-	0,8	BPR7HS	6422	Q215	BPR7HIX	5944
Helix	50	1	2004-	0,8	BPR7HS	6422	Q215	BPR7HIX	5944
JP DL502-51 2 Stroke	50	1	-	0,6	BPR7HS	6422	Q215	BPR7HIX	5944
T-Rex (4x2)	50	1	2003-	0,8	BPR7HS	6422	Q215	BPR7HIX	5944
Beast DL602-90 2 Stroke	90	1	-	0,8	BPR7HS	6422	Q215	BPR7HIX	5944
Diamond Back DL601-90 2 Stroke	90	1	-	0,8	BPR7HS	6422	Q215	BPR7HIX	5944
Helix DL603-90 2 Stroke	90	1	-	0,7	BPR7HS	6422	Q215	BPR7HIX	5944
Helix	100	1	2004-	0,8	BPR7HS	6422	Q215	BPR7HIX	5944
T-Rex (4x2)	100	1	2003-	0,8	BPR7HS	6422	Q215	BPR7HIX	5944
Diablo, Enforcer, Helix	150	1	2004-	0,7	CR7HSA	4549	-	CR7HIX	7544
DMX-DL901	450		2005-	0,6	DCPR8E	4339	-	DCPR8EIX	6546

* Bitte Elektrodenabstand nach Angaben des Herstellers justieren

* Please adjust the groundelectrode gap

* Veuillez vérifier L' écartement

* Por favor, ajustar distancia entre electrodos

* regolare il gap

C
y
l

0201



Stock-№

Quick-№



Stock-№ IX

DRR									
DRR 50	50	1	2004-	0,7	BP7HS	5111	-	BPR7HIX	5944
DRR 90	90	1	2004-	0,7	BP7HS	5111	-	BPR7HIX	5944
DRR 90 GT	90	1	2004-	0,7	C7HSA	4629	-	CR7HIX	7544

E-TON									
JXL-Viper Junior (4x2)	40	1	2003-	0,6	BPM7A	7321	Q305	-	-
Draco	50	1	2006-	0,7	BPR7HS	6422	Q215	BPR7HIX	5944
RXL-Viper (4x2)	50	1	2002-	0,7	BPR7HS	6422	Q215	BPR7HIX	5944
Sierra Ranger (4x2)	90	1	2003-	0,7	BPR7HS	6422	Q215	BPR7HIX	5944
Viper (4x2)	90	1	2002-	0,7	BPR7HS	6422	Q215	BPR7HIX	5944
Challenger 150	150	1	1999-	0,6	C7HSA	4629	-	CR7HIX	7544
YXL-Yukon (4x2)	150	1	1998-	0,6	C7HSA	4629	-	CR7HIX	7544
Vector	250	1	-	0,7	CR8E	1275	Q226	CR8EIX	4218
Vector	300	1	-	0,7	CR8E	1275	Q226	CR8EIX	4218

EXPLORER									
Atlas	500	1	-	0,9	DPR7EA-9	5129	Q220	DPR7EIX-9	7803
Everest	500	1	-	0,9	DPR7EA-9	5129	Q220	DPR7EIX-9	7803
Grumbler	525	1	-	0,9	DPR7EA-9	5129	Q220	DPR7EIX-9	7803
Bazooka	625	1	-	0,9	DPR7EA-9	5129	Q220	DPR7EIX-9	7803
Grison	625	1	-	0,9	DPR7EA-9	5129	Q220	DPR7EIX-9	7803

FOX									
4x2	50	1	2000-	0,7	BP7HS	5111	-	BPR7HIX	5944
VR-Sport 4x2	50	1	2001-	0,7	BP7HS	5111	-	BPR7HIX	5944
MX-4x2	90	1	1998-	0,7	CR7HSA	4549	-	CR7HIX	7544
4x2	100		2000-	0,7	BP7HS	5111	-	BPR7HIX	5944

GAS GAS									
Quad 50	50	1	-	0,7	B9ES	2611	Q202	BR9EIX	3981
Quad 250	250	1	2007-	0,7	DPR7EA-9	5129	Q220	DPR7EIX-9	7803
Wild - 4x2	300	1	2003-	0,6	BR8EG	3130	-	-	-
Wild - 4x2	450	1	2003-	0,6	CR8E	1275	Q226	CR8EIX	4218

GILERA									
Oregon	250	1	2007-	0,6	CR8EB	7784	-	CR8EIX	4218

HONDA									
TRX-H 4x2	70	1	1987-	0,7	CR7HSA	4549	-	CR7HIX	7544
Fourtrax	90	1	2008-	0,7	CR7HSA	4549	-	CR7HIX	7544
TRX (4x2)	90	1	2002-	0,7	CR7HSA	4549	-	CR7HIX	7544
TRX (X)	90	1	2009-	0,7	CR7HSA	4549	-	CR7HIX	7544
Trax	125	1	-	0,7	DR8ES-L	2923	Q218	DR8EIX	6681
TRX-D (S/T/V)	200	1	1995-1997	0,7	DR8ES-L	2923	Q218	DR8EIX	6681
TRX-M	200	1	1991-	0,7	DR8ES-L	2923	Q218	DR8EIX	6681
FL	250	1	-	0,8	BR9ES	5722	Q208	BR9EIX	3981
Fourtrax	250		2008-	0,9	DPR8EA-9	4929	Q221	DPR8EIX-9	2202
TRX	250	1	-	0,6	DR8ES-L	2923	Q218	DR8EIX	6681

* Bitte Elektrodenabstand nach Angaben des Herstellers justieren

* Please adjust the groundelectrode gap

* Veuillez vérifier l' écartement

* Por favor, ajustar distancia entre electrodos

* regolare il gap

C
Y
L

Stock-No

Quick-No



Stock-No IX

HONDA

TRX 1-U (4x2)	250		-2001	0,9	DPR8EA-9	4929	Q221	DPR8EIX-9	2202
TRX-EX (4x2)	250		2002-	0,9	DPR8EA-9	4929	Q221	DPR8EIX-9	2202
TRX-Fourtrax (4x2)	250		2002-	0,9	DPR8EA-9	4929	Q221	DPR8EIX-9	2202
TRX-H	250		1987-	0,7	DR8ES-L	2923	Q218	DR8EIX	6681
TRX-TE	250		2003-	0,9	DPR8EA-9	4929	Q221	DPR8EIX-9	2202
TRX-TM (4x2)	250		-2000	0,9	DPR8EA-9	4929	Q221	DPR8EIX-9	2202
TRX-V/W/X/Y/1 4x2	250		1997-	0,9	DPR8EA-9	4929	Q221	DPR8EIX-9	2202
TRX	300		2009-	0,7	DR8ES-L	2923	Q218	DR8EIX	6681
TRX-(>Y) (4x2)	300		-2001	0,9	DPR8EA-9	4929	Q221	DPR8EIX-9	2202
TRX-EX	300	1	1993-	0,6	DR8ES-L	2923	Q218	DR8EIX	6681
TRX-EX Sportrax	300		2006-	0,7	DR8ES-L	2923	Q218	DR8EIX	6681
TRX-FW (J>Y) (4x4)	300	1	-2001	0,9	DPR8EA-9	4929	Q221	DPR8EIX-9	2202
TRX-N	300	1	1992-	0,9	DPR8EA-9	4929	Q221	DPR8EIX-9	2202
ATC-X	350	1	-	0,7	DR8ES-L	2923	Q218	DR8EIX	6681
FL-R	350	4	-	0,8	BR9ES	5722	Q208	BR9EIX	3981
TRX	350	1	1993-	0,6	DR8ES-L	2923	Q218	DR8EIX	6681
TRX-FE (4x4)	350		2001-	0,9	DPR7EA-9	5129	Q220	DPR7EIX-9	7803
TRX-FM (4x4) Manual / Autom.	350		2001-	0,9	DPR7EA-9	5129	Q220	DPR7EIX-9	7803
TRX-TE	350		2005-	0,9	DPR7EA-9	5129	Q220	DPR7EIX-9	7803
TRX-TM (4x2)	350		2001-	0,9	DPR7EA-9	5129	Q220	DPR7EIX-9	7803
TRX	400		2009-	0,7	DPR8Z	4730	-	-	-
TRX-EX Fourtrax (4x2)	400		1999-	0,7	DPR8Z	4730	-	-	-
TRX-FA, FGA	400		2004-	0,9	DPR8EA-9	4929	Q221	DPR8EIX-9	2202
TRX-FW Foreman (4x2)	400		1996-	0,8	DPR7EA-9	5129	Q220	DPR7EIX-9	7803
TRX-FA / FE / FM / FPA / FPM / TA / TE	420	1	2010-	1,1	BKR5E-11	6953	-	BKR5EIX-11	5464
TRX-FE	420		2008-	1,1	BKR5E-11	6953	-	BKR5EIX-11	5464
TRX-ER	450		2006-	1,1	IFR8H11	5068	-	-	-
TRX-ES	450		2004-	0,9	DPR7EA-9	5129	Q220	DPR7EIX-9	7803
TRX-ESW Foreman (4x4)	450		1998-	0,8	DPR7EA-9	5129	Q220	DPR7EIX-9	7803
TRX-FE	450		2002-	0,9	DPR7EA-9	5129	Q220	DPR7EIX-9	7803
TRX-FA Rubicon (4x4)	500		2001-	0,9	IJR7A9	7901	-	-	-
TRX-FA / FGA / Rincon	650	1	2005-	1,1	IFR5L11	6502	-	-	-
TRX-FA	680	1	2010-	1,1	IFR5L11	6502	-	-	-
TRX-FGA Fourtrax Rincon	680		2006-	1,1	IFR5L11	6502	-	-	-
TRX	700		-	1,1	ZFR7F-11	2975	-	-	-

HUSQVARNA

QM	450		2005-	0,7	CR8EB	7784	-	CR8EIX	4218
----	-----	--	-------	-----	-------	------	---	--------	------

HYOSUNG

4x2	50	1	2003-	0,8	BP6HS	4511	-	BPR6HIX	4085
HY	50	1	2005-	0,7	CR7HSA	4549	-	CR7HIX	7544
Wow 50	50	1	2004-	0,7	BP7HS	5111	-	BPR7HIX	5944
4x2	90	1	2003-	0,8	BPR7HS	6422	Q215	BPR7HIX	5944
Wow 90	90	1	2004-	0,7	BP7HS	5111	-	BPR7HIX	5944
R	450	1	2007-	0,6	CR8E	1275	Q226	CR8EIX	4218
Rapier	450		2010-	0,6	CR8E	1275	Q226	CR8EIX	4218
TE	450		2007-	0,6	CR8E	1275	Q226	CR8EIX	4218

* Bitte Elektrodenabstand nach Angaben des Herstellers justieren

* Please adjust the groundelectrode gap

* Veuillez vérifier L' écartement

* Por favor, ajustar distancia entre electrodos

* regolare il gap

C
y
l

Stock-№

Quick-№



Stock-№ IX

HYTRACK

HY-4x4	420	1	-	0,6	DR8EA	7162	-	DR8EIX	6681
HY-Engine LINHAY	550		2008-	0,6	DR8EA	7162	-	DR8EIX	6681

JOHN DEERE

Buck	500		-	0,6	DR8EA	7162	-	DR8EIX	6681
Trail Buck	500		-	0,8	DCPR8E	4339	-	DCPR8EIX	6546
Trail Buck	650		-	0,8	DCPR8E	4339	-	DCPR8EIX	6546

KAWASAKI

KFX50 (KSF50-A1~3, A6F)	50	1	2003-2006	0,7	BPR4HS	7823	-	-	-
KFX50 (KSF50-B7F~B9F, B9S)	50	1	2007-2009	0,8	CR7HSA	4549	-	CR7HIX	7544
KFX50 (KSF50-BDF~BFF)	50	1	2013-2015	0,8	CR7HSA	4549	-	CR7HIX	7544
KFX80 (KSF80-A1~3, A6F)	80	1	2003-2006	0,6	BPR7HS	6422	Q215	BPR7HIX	5944
KFX90 (KSF90-A7F~A9F, AAF~AFF)	90	1	2007-2015	0,8	CR7HSA	4549	-	CR7HIX	7544
Bayou 220 (KLF220-A1~4)	220	1	1988-1991	0,7	DR8ES	5423	Q217	DR8EIX	6681
Bayou 220 (KLF220-A5~15)	220	1	2000-2002	0,7	DR8ES	5423	Q217	DR8EIX	6681
Bayou 250 (KLF250-A1~3, A6F~A9F)	250	1	2003-2009	0,7	DR8ES	5423	Q217	DR8EIX	6681
Bayou 250 (KLF250-AAF~ABF)	250	1	2010-2011	0,7	DR8ES	5423	Q217	DR8EIX	6681
KFX250 Mojave (KSF250-A1~13)	250	1	1987-1999	0,9	DP8EA-9	5829	-	DPR8EIX-9	2202
KFX250 Mojave (KSF250-A14~17)	250	1	2000-2004	0,9	DPR8EA-9	4929	Q221	DPR8EIX-9	2202
2x4, 4x4	300		2005-	0,7	DR7EA	7839	-	DR7EIX	5686
Bayou 300 (KLF300-B13~17)	300	1	2000-2004	0,6	DR8EA	7162	-	DR8EIX	6681
Bayou 300 (KLF300-B2~4)	300	1	1989-1991	0,7	D8EA	2120	Q216	DR8EIX	6681
Bayou 300 (KLF300-B6~12)	300	1	1992-1999	0,7	D8EA	2120	Q216	DR8EIX	6681
Bayou 300 4x4 (KLF300-C1~8)	300	1	1989-1996	0,7	D8EA	2120	Q216	DR8EIX	6681
Bayou 300 4x4 (KLF300-C12~16)	300	1	2000-2004	0,6	DR8EA	7162	-	DR8EIX	6681
Bayou 300 4x4 (KLF300-C9~11)	300	1	1997-1999	0,7	D8EA	2120	Q216	DR8EIX	6681
Brute Force 300 (KVF300-CCF~CFF)	300	1	2012-2015	0,9	DPR7EA-9	5129	Q220	DPR7EIX-9	7803
KFX	300	1	1995-	0,6	DR7EA	7839	-	DR7EIX	5686
Lakota (KEF300-A1~5)	300	1	1995-1999	0,7	D8EA	2120	Q216	DR8EIX	6681
Lakota (KEF300-A6~)	300	1	2000-2000	0,7	DR7EA	7839	-	DR7EIX	5686
Lakota Sport (KEF300-B1~3)	300	1	2001-2003	0,6	DR8EA	7162	-	DR8EIX	6681
Mule 550	300		1997-2004	0,7	BPR5ES	7422	-	BPR5EIX	6597
Prairie (KVF300-B1~4)	300	1	1999-2002	0,6	DR8EA	7162	-	DR8EIX	6681
Prairie 4x4 (KVF300-A1~4)	300	1	1999-2002	0,6	DR8EA	7162	-	DR8EIX	6681
Prairie 360 4x2 (KVF360-B1~3, B6F~B9F)	360	1	2003-2009	0,9	DPR8EA-9	4929	Q221	DPR8EIX-9	2202
Prairie 360 4x4 (KVF360-A1~3, A6F~A9F, AAF~ADF)	360	1	2003-2013	0,9	DPR8EA-9	4929	Q221	DPR8EIX-9	2202
Prairie 360 4X4 Advantage Classic (KVF360-C1)	360	1	2003-	0,9	DPR8EA-9	4929	Q221	DPR8EIX-9	2202
Prairie 360 4X4 Hardwoods Green HD (KVF360-C2~3, C6F~C9F)	360	1	2004-2009	0,9	DPR8EA-9	4929	Q221	DPR8EIX-9	2202
Prairie 360 4X4 Realtree APG HD (KVF360-CAF~CBF)	360	1	2010-2011	0,9	DPR8EA-9	4929	Q221	DPR8EIX-9	2202
Bayou 400 4x4 (KLF400-B1~7)	400	1	1993-1999	0,9	DPR8EA-9	4929	Q221	DPR8EIX-9	2202
KFX 400 A (SQ)	400		2003-2006	0,7	CR8E	1275	Q226	CR8EIX	4218
KFX400 (KSF400-A1~3, A6F)	400	1	2003-2006	0,7	CR7E	4578	Q225	CR7EIX	7385
Prairie 400 (KVF400-B1)	400	1	1998-1998	0,9	DPR8EA-9	4929	Q221	DPR8EIX-9	2202
Prairie 400 (KVF400-D1~3)	400	1	1999-2002	0,9	DPR8EA-9	4929	Q221	DPR8EIX-9	2202
Prairie 400 4x4 (KVF400-A1)	400	1	1997-1999	0,9	DPR8EA-9	4929	Q221	DPR8EIX-9	2202
Prairie 400 4x4 (KVF400-C1~3)	400	1	1999-2002	0,9	DPR8EA-9	4929	Q221	DPR8EIX-9	2202
KFX450R (KSF450-B8F~B9F, B8FA~B9FB)	450	1	2008-2009	0,9	CPR8EB-9	6607	-	-	-
KFX450R (KSF450-BAF~BEF)	450	1	2010-2014	0,9	CPR8EB-9	6607	-	-	-
Brute Force 650 4x4 (KVF650-D1, D6F~D9F, DAF~DDF)	650	2	2005-2013	0,8	CR7E	4578	Q225	CR7EIX	7385

* Bitte Elektrodenabstand nach Angaben des Herstellers justieren

* Please adjust the groundelectrode gap

* Veuillez vérifier l' écartement

* Por favor, ajustar distancia entre electrodos

* regolare il gap

C
Y
L

Stock-No

Quick-No



Stock-No IX

KAWASAKI

Brute Force 650 4x4 (KVF650-DCS)	650	2	2012-2012	0,8	CR7E	4578	Q225	CR7EIX	7385
Brute Force 650 4x4 Hardwoods Green HD (KVF650-E1, E6F~E9F)	650	2	2005-2008	0,8	CR7E	4578	Q225	CR7EIX	7385
Brute Force 650 4x4i (KVF650-F6F~F9F, FAF~FDF)	650	2	2006-2013	0,8	CR7E	4578	Q225	CR7EIX	7385
Brute Force 650 4x4i (KVF650-FCS)	650	2	2012-2012	0,8	CR7E	4578	Q225	CR7EIX	7385
Brute Force 650 4x4i (KVF650-H7F~H8F)	650	2	2007-2008	0,8	CR7E	4578	Q225	CR7EIX	7385
Brute Force 650 4x4i Hardwoods Green HD (KVF650-G6F~G8F)	650	2	2006-2009	0,8	CR7E	4578	Q225	CR7EIX	7385
Prairie 650 4x4 (KVF650-A1~2)	650	2	2000-2003	0,7	CR7E	4578	Q225	CR7EIX	7385
Prairie 650 4x4 Advantage Classic (KVF650-B1~2)	650	2	2002-2003	0,7	CR7E	4578	Q225	CR7EIX	7385
KFX700 V Force (KSV700-A1~2, B1~2)	700	2	2004-2005	0,8	CR7E	4578	Q225	CR7EIX	7385
KFX700 V Force (KSV700-A7F, B7F~B9F)	700	2	2007-2009	0,8	CR7E	4578	Q225	CR7EIX	7385
Prairie 700 4x4 (KVF700-A1~2, A6F)	700	2	2004-2006	0,7	CR7E	4578	Q225	CR7EIX	7385
Prairie 700 4x4 Hardwoods Green HD (KVF700-B1)	700	2	2004-2005	0,7	CR7E	4578	Q225	CR7EIX	7385
Prairie 700 4x4 Team Green Special Edition (KVF700-D1, D6F)	700	2	2005-2006	0,7	CR7E	4578	Q225	CR7EIX	7385
Brute Force 750 4x4i (KVF750-A1, A6F~A7F)	750	2	2005-2006	0,8	CR7E	4578	Q225	CR7EIX	7385
Brute Force 750 4x4i (KVF750-B7FA)	750	2	2007-2007	0,8	CR7E	4578	Q225	CR7EIX	7385
Brute Force 750 4x4i (KVF750-C6F~C7F)	750	2	2006-2007	0,8	CR7E	4578	Q225	CR7EIX	7385
Brute Force 750 4x4i (KVF750-D9F)	750	2	2008-2009	0,8	CR7E	4578	Q225	CR7EIX	7385
Brute Force 750 4x4i (KVF750-F8F)	750	2	2008-2008	0,8	CR7E	4578	Q225	CR7EIX	7385
Brute Force 750 4x4i (KVF750-FAF~FBF)	750	2	2010-2011	0,8	CR7E	4578	Q225	CR7EIX	7385
Brute Force 750 4x4i (KVF750-LCF~LEF)	750	2	2012-2014	0,8	CR7E	4578	Q225	CR7EIX	7385
Brute Force 750 4x4i (KVF750-LCS)	750	2	2012-2012	0,8	CR7E	4578	Q225	CR7EIX	7385
Brute Force 750 4x4i EPS (KVF750-GFF)	750	2	2015-2015	0,9	CPR7EA-9	3901	-	CPR7EAIX-9	9198
Brute Force 750 4x4i EPS (KVF750-JCF~JEF)	750	2	2012-2014	0,8	CR7E	4578	Q225	CR7EIX	7385
Brute Force 750 4x4i EPS (KVF750-JCS)	750	2	2012-2012	0,8	CR7E	4578	Q225	CR7EIX	7385
Brute Force 750 4x4i EPS CAMO (KVF750-HFF)	750	2	2015-2015	0,9	CPR7EA-9	3901	-	CPR7EAIX-9	9198
Brute Force 750 4x4i Hardwoods Green HD (KVF750-B1, B6F~B7F)	750	2	2005-2006	0,8	CR7E	4578	Q225	CR7EIX	7385
Brute Force 750 4x4i Hardwoods Green HD (KVF750-E8F~E9F)	750	2	2008-2009	0,8	CR7E	4578	Q225	CR7EIX	7385
Brute Force 750 4x4i Hardwoods Green HD (KVF750-E8FA~E9FA)	750	2	2008-2009	0,8	CR7E	4578	Q225	CR7EIX	7385
Brute Force 750 4x4i NRA Outdoors (KVF750-E8F~E9F)	750	2	2008-2009	0,8	CR7E	4578	Q225	CR7EIX	7385
Brute Force 750 4x4i NRA Outdoors (KVF750-E8FA~E9FA)	750	2	2008-2009	0,8	CR7E	4578	Q225	CR7EIX	7385
Brute Force 750 4x4i Realtree APG HD (KVF750-EAF)	750	2	2010-2010	0,8	CR7E	4578	Q225	CR7EIX	7385

KEEWAY

Dragon 250	250	1	-	0,8	DR7ES	3123	-	DR7EIX	5686
------------	-----	---	---	-----	-------	------	---	--------	------

KREIDLER

Mini Mustang	50	1	2005-	0,8	BPR7HS	6422	Q215	BPR7HIX	5944
Mustang	50	1	2005-	0,8	BPR7HS	6422	Q215	BPR7HIX	5944
F-Kart 100	100	1	2005-	0,8	BPR7HS	6422	Q215	BPR7HIX	5944
Mustang 170	170	1	2005-	0,7	DR8EA	7162	-	DR8EIX	6681
Mustang 200	170	1	2005-	0,7	DR8EA	7162	-	DR8EIX	6681
Mustang 250	250	1	2005-	0,7	CR8HS	7423	-	CR8HIX	7669

* Bitte Elektrodenabstand nach Angaben des Herstellers justieren

* Please adjust the groundelectrode gap

* Veuillez vérifier l' écartement

* Por favor, ajustar distancia entre electrodos

* regolare il gap

C
y
l

Stock-№

Quick-№



Stock-№ IX

KTM									
SX 450	450	1	2009-	0,7	CR9EKB	2305	-	CR9EIX	3521
XC	450	1	2008-	0,9	DCPR8E	4339	-	DCPR8EIX	6546
SX 505	477	1	2009-	0,7	CR9EKB	2305	-	CR9EIX	3521
XC	510	1	2008-	0,6	DCPR8E	4339	-	DCPR8EIX	6546
XC 525	525	1	2008-	0,9	DCPR8E	4339	-	DCPR8EIX	6546

KYMCO									
Calypso	50	1	1997-	0,6	BR8HS	4322	Q212	BR8HIX	7001
Fever ZX	50	1	-	0,6	BR8HSA	5539	-	BR8HIX	7001
Grand Dink 2 Stroke	50	1	2005-	0,6	BR8HSA	5539	-	BR8HIX	7001
Heroism	50	1	-	0,6	BR8HSA	5539	-	BR8HIX	7001
K 12	50	1	-	0,6	BR8HSA	5539	-	BR8HIX	7001
KB	50	1	-	0,6	BR8HSA	5539	-	BR8HIX	7001
KXR	50	1	2004-	0,7	BR8HSA	5539	-	BR8HIX	7001
MX	50	1	2001-	0,5	BR8HSA	5539	-	BR8HIX	7001
Mxer (4x2)	50	1	2002-	0,7	BR8HSA	5539	-	BR8HIX	7001
MXU	50	1	2005-	0,5	BR8HSA	5539	-	BR8HIX	7001
People	50	1	1999-	0,6	BR8HSA	5539	-	BR8HIX	7001
Scout	50	1	1997-	0,6	BR8HSA	5539	-	BR8HIX	7001
Snuper DD	50	1	-	0,6	BR8HSA	5539	-	BR8HIX	7001
Tomos Classic/Quadro/Flexer	50	1	2001-	0,6	B6HS	4510	Q203	BR6HIX	3419
Tomos TX	50	1	2001-	0,6	B6HS	4510	Q203	BR6HIX	3419
KXR	90	1	-	0,5	C7HSA	4629	-	CR7HIX	7544
Cobra Racer	100	1	1999-	0,6	BR8HSA	5539	-	BR8HIX	7001
Agility	125	1	2005-	0,7	CR7HSA	4549	-	CR7HIX	7544
Calypso	125	1	1997-	0,6	C7HSA	4629	-	CR7HIX	7544
CK	125	1	2004-	0,7	DR8EA	7162	-	DR8EIX	6681
Dink 4 Stroke	125	1	1999-	0,9	DPR7EA-9	5129	Q220	DPR7EIX-9	7803
Grand Dink 4 Stroke	125	1	1999-	0,9	DPR7EA-9	5129	Q220	DPR7EIX-9	7803
Heroism	125	1	-	0,7	C7HSA	4629	-	CR7HIX	7544
Hipster 2 Stroke	125	1	2001-	0,7	DR8EA	7162	-	DR8EIX	6681
Hipster 4 Stroke	125	1	2001-	0,6	CR8E	1275	Q226	CR8EIX	4218
Movie 4 Stroke	125	1	-	0,6	C7HSA	4629	-	CR7HIX	7544
People	125	1	2005-	0,6	C7HSA	4629	-	CR7HIX	7544
Pulsar4 Stroke	125	1	2001-	0,7	DR8EA	7162	-	DR8EIX	6681
Spacer	125	1	1997-	0,9	DPR7EA-9	5129	Q220	DPR7EIX-9	7803
Stryker	125	1	1999-	0,7	DR8EA	7162	-	DR8EIX	6681
Stryker II	125	1	1999-	0,7	DR8EA	7162	-	DR8EIX	6681
Yager 4 Stroke	125	1	2001-	0,9	DPR7EA-9	5129	Q220	DPR7EIX-9	7803
Zing	125	1	1997-	0,6	DR8EA	7162	-	DR8EIX	6681
Heroism	150	1	-	0,7	C7HSA	4629	-	CR7HIX	7544
MX	150	1	2001-	0,7	DR8EA	7162	-	DR8EIX	6681
Mxer (4x2)	150	1	2002-	0,7	DR8EA	7162	-	DR8EIX	6681
MXU	150	1	-	0,7	DR8EA	7162	-	DR8EIX	6681
Dink / Grand Dink 4 Stroke	250	1	1999-	0,9	DPR7EA-9	5129	Q220	DPR7EIX-9	7803
KXR	250	1	2001-	0,9	DPR7EA-9	5129	Q220	DPR7EIX-9	7803
Maxxer	250	1	2005-	0,9	DPR7EA-9	5129	Q220	DPR7EIX-9	7803
Mxer 250R	250	1	2005-	0,9	DPR7EA-9	5129	Q220	DPR7EIX-9	7803
MXU	250	1	2005-	0,9	DPR7EA-9	5129	Q220	DPR7EIX-9	7803
People	250	1	2005-	0,9	DPR7EA-9	5129	Q220	DPR7EIX-9	7803
Venox 4 Stroke	250	1	2001-	0,9	DPR7EA-9	5129	Q220	DPR7EIX-9	7803

* Bitte Elektrodenabstand nach Angaben des Herstellers justieren

* Please adjust the groundelectrode gap

* Veuillez vérifier l' écartement

* Por favor, ajustar distancia entre electrodos

* regolare il gap

C
Y
L

0201



Stock-No

Quick-No



Stock-No IX

KYMCO

Xciting	250	1	2005-	0,9	DPR7EA-9	5129	Q220	DPR7EIX-9	7803
Maxxer	300	1	2005-	0,9	DPR7EA-9	5129	Q220	DPR7EIX-9	7803
MXU	300	1	2005-	0,9	DPR7EA-9	5129	Q220	DPR7EIX-9	7803
Xciting R	300	1	-	0,9	CPR6EA-9	6899	-	-	-
MXU	400	1	2008-	0,9	CR8E	1275	Q226	CR8EIX	4218
MXU	500	1	2005-	0,8	CR7E	4578	Q225	CR7EIX	7385
MXU 4x4	500	1	2006-	0,6	CR8E	1275	Q226	CR8EIX	4218

LEM

Cayman (4x2)	50	1	1997-	0,7	BR8HS	4322	Q212	BR8HIX	7001
Condor (4x2)	50	1	1997-	0,7	BR8HS	4322	Q212	BR8HIX	7001

LINHAI / HYTRACK

260 Yéti Sport	257	1	-	0,6	DR8EA	7162	-	DR8EIX	6681
260 Yéti Standard	257	1	-	0,6	DR8EA	7162	-	DR8EIX	6681

MANCO

Miny Indy 5.0 hp Engine Subaru	50		-	0,7	BR6HS	3922	Q209	BR6HIX	3419
Stock Car 4.0 hp Engine Subaru	50		-	0,7	BR6HS	3922	Q209	BR6HIX	3419
ZSR-50	50	1	-	0,8	BPR7HS	6422	Q215	BPR7HIX	5944
ZSR-90	90	1	-	0,8	BPR7HS	6422	Q215	BPR7HIX	5944
Bandit Kart 4.0 hp Engine Subaru	126	1	-	0,6	BR6HS	3922	Q209	BR6HIX	3419
Critter Kart 5.0 hp Engine Subaru	126	1	-	0,7	BR6HS	3922	Q209	BR6HIX	3419
Eliminator Kart 5.0 hp Engine Subaru	126	1	-	0,6	BR6HS	3922	Q209	BR6HIX	3419
Force Five Kart 5.0 hp Engine Subaru	126	1	-	0,6	BR6HS	3922	Q209	BR6HIX	3419
Quicksilver Kart 5.0 hp Engine Subaru	126	1	-	0,7	BR6HS	3922	Q209	BR6HIX	3419
Eliminator Kart 6.5 hp Engine Subaru	169	1	-	0,7	BR6HS	3922	Q209	BR6HIX	3419
EZ Rider 6.5 hp Engine Subaru	169		-	0,7	BR6HS	3922	Q209	BR6HIX	3419
Aerforce Kart 7.0 hp Engine Subaru	211		-	0,7	BR6HS	3922	Q209	BR6HIX	3419
Intruder Kart 7.0 hp Engine Subaru	211		-	0,7	BR6HS	3922	Q209	BR6HIX	3419
8260E	260		-	0,7	DR8EA	7162	-	DR8EIX	6681
Aerforce Kart 10.0 hp Robin-Subaru Engine	265		-	0,7	BR6HS	3922	Q209	BR6HIX	3419
XTK-713E 13.5 hp Robin-Subaru Engine	404		-	0,6	BR6HS	3922	Q209	BR6HIX	3419
618 Super Deuce 18.0 hp Honda V-Twin OHV	450		-	0,7	BPR5ES	7422	-	BPR5EIX	6597

MASAI

A300	265	1	-	1,0	DCPR7E	3932	-	DCPR7EIX	6046
A450	450	1	-	0,8	DCPR8E	4339	-	DCPR8EIX	6546

MASSEY FERGUSON

MF-2x4	250	3	-	0,7	DR7EA	7839	-	DR7EIX	5686
MF-MRP	350		-	0,7	DR7EA	7839	-	DR7EIX	5686
MF-MRP	400		-	0,7	CR6E	6965	-	-	-
MF-MRP	450		-	0,7	CR6E	6965	-	-	-
MF-MRP	500		-	0,7	CR6E	6965	-	-	-
MF-TBX	500		-	0,7	CR6E	6965	-	-	-

MOTO ROMA

Roadrunner 4	100	1	2004-	0,6	BP7HS	5111	-	BPR7HIX	5944
Sport 100	100	1	2004-	0,6	BP7HS	5111	-	BPR7HIX	5944

* Bitte Elektrodenabstand nach Angaben des Herstellers justieren

* Please adjust the groundelectrode gap

* Veuillez vérifier L' écartement

* Por favor, ajustar distancia entre electrodos

* regolare il gap

C
y
l

Stock-№

Quick-№



Stock-№ IX

MOTO ROMA

Sportsmann 125	125	1	2003-	0,7	C7HSA	4629	-	CR7HIX	7544
Geko 300	300	1	2005-	0,7	DR8EA	7162	-	DR8EIX	6681

MOTORTEK

MT (4x2)	125	1	2000-	0,7	C7HSA	4629	-	CR7HIX	7544
MT R (4x2)	175	1	2000-	0,7	DR8EA	7162	-	DR8EIX	6681

MSA

Fox	50	1	2000-	0,7	BR8HSA	5539	-	BR8HIX	7001
Mini Fox	50	1	2000-	0,7	BM6A	5921	Q303	-	-
VR (Sport)	50	1	2000-	0,7	BR8HSA	5539	-	BR8HIX	7001
Fox	90	1	2000-	0,7	CR7HSA	4549	-	CR7HIX	7544
Fox	100	1	2000-	0,7	BR8HSA	5539	-	BR8HIX	7001
VR-Sport	100	1	2000-	0,7	BR8HSA	5539	-	BR8HIX	7001

MZ

ATV 50	50	1	2003-	0,6	BP6HS	4511	-	BPR6HIX	4085
ATV 100	100	1	2003-	0,6	BP6HS	4511	-	BPR6HIX	4085
MT 125 Cobra	125	1	2005-	0,6	C7HSA	4629	-	CR7HIX	7544
KX 150	150	1	2005-	0,6	CR7E	4578	Q225	CR7EIX	7385
VRS 150	150	1	2005-	0,6	CR7E	4578	Q225	CR7EIX	7385

P.G.O.

	110	1	2003-	0,7	BPR7HS	6422	Q215	BPR7HIX	5944
	151	1	2003-	0,7	CR7HSA	4549	-	CR7HIX	7544

PANDA

KD 50 A	50	1	2000-	0,7	CR6HSA	2983	-	CR6HIX	7274
KD 80 A	80	1	2000-	0,7	CR6HSA	2983	-	CR6HIX	7274
KD 125 A	125	1	2000-	0,7	CR6HSA	2983	-	CR6HIX	7274

POLARIS

Predator AR03-01	50	1	2003-	0,8	BPR7HS	6422	Q215	BPR7HIX	5944
Scrambler 4x2, Predator	50	1	2001-	0,7	BPR7HS	6422	Q215	BPR7HIX	5944
Youth Scrambler AR03	50	1	2001-	0,8	BPR7HS	6422	Q215	BPR7HIX	5944
Predator 4x2	90	1	2003-	0,7	BPR7HS	6422	Q215	BPR7HIX	5944
Scrambler 4x2	90	1	2001-	0,7	BPR7HS	6422	Q215	BPR7HIX	5944
Sportsman 4x2	90	1	2001-	0,7	BPR7HS	6422	Q215	BPR7HIX	5944
Youth Predator AR07	90	1	2003-	0,8	BPR7HS	6422	Q215	BPR7HIX	5944
Youth Scrambler AR07	90	1	2001-	0,8	BPR7HS	6422	Q215	BPR7HIX	5944
Youth Sportsman AR07	90	1	2001-	0,8	BPR7HS	6422	Q215	BPR7HIX	5944
Pro X 120 2 Temps	121	1	2005-	0,7	B6ES	7310	-	-	-
Phönix 200	200	1	2005-	0,6	CR7HSA	4549	-	CR7HIX	7544
Sawtooth	200		2006-	0,7	CR7HSA	4549	-	CR7HIX	7544
2x4	250	1	1993-1993	0,6	BR8ES	5422	Q207	BR8EIX	5044
Scrambler	250	1	1989-	0,6	BR8ES	5422	Q207	BR8EIX	5044
Trail Blazer	250	1	1990-1997	0,6	BR8ES	5422	Q207	BR8EIX	5044
Trail Boss	250	1	1990-1997	0,6	BR8ES	5422	Q207	BR8EIX	5044
Xplorer 4x2	250		2000-2002	0,7	BR8ES	5422	Q207	BR8EIX	5044

* Bitte Elektrodenabstand nach Angaben des Herstellers justieren

* Please adjust the groundelectrode gap

* Veuillez vérifier L' écartement

* Por favor, ajustar distancia entre electrodos

* regolare il gap

C
Y
L

Stock-No

Quick-No



Stock-No IX

POLARIS

2x4	300	1	1994-1995	0,6	BR8ES	5422	Q207	BR8EIX	5044
4x4	300	1	1995-1995	0,6	BR8ES	5422	Q207	BR8EIX	5044
Big Boss	300		1993-	0,6	BR8ES	5422	Q207	BR8EIX	5044
Hawkeye	300		2006-	0,9	CR8E	1275	Q226	CR8EIX	4218
Xplorer	300	1	1994-2000	0,6	BR8ES	5422	Q207	BR8EIX	5044
Xpress	300		1994-2000	0,6	BR8ES	5422	Q207	BR8EIX	5044
HDS-Magnum 4x2	325		-2002	0,9	BKR6E	6962	-	BKR6EIX	6418
HDS-Magnum 4x4	325		-2002	0,9	BKR6E	6962	-	BKR6EIX	6418
Trail Boss 4x2	325		-2002	0,9	BKR6E	6962	-	BKR6EIX	6418
Xpedition 4x4	325		-2002	0,8	BKR6E	6962	-	BKR6EIX	6418
HDS-Magnum 330 4x4	330	1	2005-	0,6	BKR6ES	3783	-	BKR6EIX	6418
HDS-Magnum 4x2	330		2003-	0,8	BKR6E	6962	-	BKR6EIX	6418
HDS-Magnum 4x4	330		2003-	0,8	BKR6E	6962	-	BKR6EIX	6418
Trail Boss 330	330	1	2005-	0,6	BKR6ES	3783	-	BKR6EIX	6418
Trail Boss 4x2	330		2003-	0,8	BKR6E	6962	-	BKR6EIX	6418
Sportsman 4x4	335		-2000	0,7	BKR7E	6097	-	BKR7EIX	2667
Big Boss	350		1993-	0,6	BR8ES	5422	Q207	BR8EIX	5044
Euro Trail Boss	350	1	1992-1992	0,6	BR8ES	5422	Q207	BR8EIX	5044
Trail Boss EC35	350	1	1990-	0,5	BR8ES	5422	Q207	BR8EIX	5044
400L	400	1	1994-1996	0,6	BR8ES	5422	Q207	BR8EIX	5044
Big Boss 400L	400	1	1995-1998	0,7	BR8ES	5422	Q207	BR8EIX	5044
Norwegian 400L	400	1	1996-1996	0,6	BR8ES	5422	Q207	BR8EIX	5044
Scrambler	400	1	1995-2000	0,7	BR8ES	5422	Q207	BR8EIX	5044
Sport 400L	400	1	1994-1997	0,6	BR8ES	5422	Q207	BR8EIX	5044
Sport 4x2	400		-2000	0,7	BR8ES	5422	Q207	BR8EIX	5044
Sportman 4x4	400		2003-	0,6	BKR5E	7938	-	BKR5EIX	6341
Sportsman	400	1	1994-1997	0,7	BR8ES	5422	Q207	BR8EIX	5044
Trail Blazer 4x2	400		2003-	0,7	BR8ES	5422	Q207	BR8EIX	5044
Xplorer	400	1	1994-2002	0,7	BR8ES	5422	Q207	BR8EIX	5044
Xpress	400	1	1996-1998	0,7	BR8ES	5422	Q207	BR8EIX	5044
Expedition EH42	425		2001-	0,6	BKR5E	7938	-	BKR5EIX	6341
Magnum	425	1	1995-1995	0,6	BKR5E	7938	-	BKR5EIX	6341
Magnum	425	1	1996-1998	0,6	BKR5E	7938	-	BKR5EIX	6341
Norwegian Magnum	425	1	1995-1995	0,6	BKR6E	6962	-	BKR6EIX	6418
Norwegian Magnum	425	1	1996-1996	0,6	BKR5E	7938	-	BKR5EIX	6341
Ranger EH42	425		2002-	0,6	BKR5E	7938	-	BKR5EIX	6341
Sportsman	425		2001-2004	0,6	BKR5E	7938	-	BKR5EIX	6341
Swedish Magnum	425	1	1995-1995	0,6	BKR6E	6962	-	BKR6EIX	6418
Swedish Magnum	425	1	1996-1997	0,6	BKR5E	7938	-	BKR5EIX	6341
Xpedition 4x4	425		-2000	0,6	BKR5E	7938	-	BKR5EIX	6341
Sportsman EH 460	450		2006-	0,8	CR8E	1275	Q226	CR8EIX	4218
ATP 500	500	1	2005-	0,6	BKR6ES	3783	-	BKR6EIX	6418
Big Boss	500	1	1998-2000	0,7	BKR5E	7938	-	BKR5EIX	6341
HDS-Magnum 4x4	500		2000-	0,7	BKR5E	7938	-	BKR5EIX	6341
LUH 6x6 PSS (C02CL50AB)	500	1	2002-2002	0,6	BKR5E	7938	-	BKR5EIX	6341
Predator 4x2	500		2003-	0,8	DCPR8E	4339	-	DCPR8EIX	6546
Pro ATV 4x4 PPS (C02CD50AC)	500	1	2002-2002	0,6	BKR5E	7938	-	BKR5EIX	6341
Ranger 4x4	500		2002-	0,7	BKR5E	7938	-	BKR5EIX	6341
Ranger 6x6	500		1999-	0,7	BKR5E	7938	-	BKR5EIX	6341
RSE-Sportsman 4x4	500		2000-	0,7	BKR5E	7938	-	BKR5EIX	6341
Scrambler	500	1	1996-	0,7	BKR5E	7938	-	BKR5EIX	6341
Scrambler 4x4	500		2010-	0,9	BKR6E	6962	-	BKR6EIX	6418

* Bitte Elektrodenabstand nach Angaben des Herstellers justieren

* Please adjust the groundelectrode gap

* Veuillez vérifier l' écartement

* Por favor, ajustar distancia entre electrodos

* regolare il gap

C
y
l

Stock-Nr

Quick-Nr



Stock-Nr IX

POLARIS

Sportsman	500	1	1996-2005	0,6	BKR5E	7938	-	BKR5EIX	6341
Sportsman 6x6	500	2	2000-	0,7	BKR5E	7938	-	BKR5EIX	6341
Sportsman 6x6	500	2	2005-	0,6	BKR6ES	3783	-	BKR6EIX	6418
Task Force Utility EH50	500		2002-	0,6	BKR5E	7938	-	BKR5EIX	6341
Xplorer	500	1	1997-1998	0,6	BKR5E	7938	-	BKR5EIX	6341
XP	550		2009-	0,9	LZKAR7A	6799	-	-	-
Sportsman 4x4	600		2003-2005	0,7	BKR7E	6097	-	BKR7EIX	2667
Ranger 4x4, 6x6	700		2006-	0,7	BKR7E	6097	-	BKR7EIX	2667
Sportsman 4x4	700		2002-2005	0,7	BKR7E	6097	-	BKR7EIX	2667
Sportsman 4x4	800		2005-	0,7	BKR7E	6097	-	BKR7EIX	2667
Sportsman Touring	850	2	2010-	0,9	LZKAR7A	6799	-	-	-
XP	850	2	2009-	0,9	LZKAR7A	6799	-	-	-

QUADZILLA

XLC500	500		2008-	0,9	DCPR8E	4339	-	DCR8EIX	3606
RS7	700		2010-	0,8	CR6E	6965	-	-	-
RS8	750		2011-	0,8	CR6E	6965	-	-	-

SACHS

4rock 50	50	1	2006-	0,7	BPR7HS	6422	Q215	BPR7HIX	5944
Little Devil	50	1	-	0,6	BP6HS	4511	-	BPR6HIX	4085
T-Rex 50	50	1	2006-	0,6	BPR7HS	6422	Q215	BPR7HIX	5944
Helix 100	100	1	2006-	0,6	BPR7HS	6422	Q215	BPR7HIX	5944
T-Rex 100	100	1	2006-	0,6	BPR7HS	6422	Q215	BPR7HIX	5944
4rock 110	110	1	2006-	0,7	BPR7HS	6422	Q215	BPR7HIX	5944
4rock 150	150	1	2006-	0,7	C7HSA	4629	-	CR7HIX	7544
Helix 150	150	1	2006-	0,6	C7HSA	4629	-	CR7HIX	7544
4rock 250	250	1	2006-	0,7	CR8HS	7423	-	CR8HIX	7669

SHINERAY

	250	1	2012-	0,9	DPR7EA-9	5129	Q220	DPR7EIX-9	7803
--	-----	---	-------	-----	----------	------	------	-----------	------

SUZUKI

LT-A-K2 (4x2)	50	1	2001-	0,7	BPR4HS	7823	-	-	-
LT-X / Y (4x2)	50	1	1989-	0,7	BPR4HS	7823	-	-	-
LT-Z	50	1	2008-	0,7	CR6HSA	2983	-	CR6HIX	7274
LT-Z50	50	1	2005-2007	0,7	CR6HSA	2983	-	CR6HIX	7274
LT	80	1	2008-	0,7	BPR7HS	6422	Q215	BPR7HIX	5944
LT-L/M/N/P/R/S/T/W/X/Y (4x2)	80	1	1990-	0,7	BPR7HS	6422	Q215	BPR7HIX	5944
LT-Z	90	1	2006-	0,7	CR6HSA	2983	-	CR6HIX	7274
LT-E	160	1	1993-	0,9	DPR7EA-9	5129	Q220	DPR7EIX-9	7803
LT-F	160	1	1993-	0,9	DP7EA-9	5629	-	DPR7EIX-9	7803
LT-F	160	1	1995-	0,9	DP7EA-9	5629	-	DPR7EIX-9	7803
LT-E	230	1	1993-	0,7	D7EA	7912	-	DR7EIX	5686
LT-E/F	230	1	-	0,7	DR7ES	3123	-	DR7EIX	5686
LT-GE	230	1	-	0,7	D7EA	7912	-	DR7EIX	5686
LT-4WD	250	1	-	0,7	DR7ES	3123	-	DR7EIX	5686
LT-E/EF	250	1	1993-	0,7	D8EA	2120	Q216	DR8EIX	6681

* Bitte Elektrodenabstand nach Angaben des Herstellers justieren

* Please adjust the groundelectrode gap

* Veuillez vérifier l' écartement

* Por favor, ajustar distancia entre electrodos

* regolare il gap

C
Y
L

Stock-No

Quick-No



Stock-No IX

SUZUKI

LT-F	250	1	1993-	0,7	DR7ES	3123	-	DR7EIX	5686
LT-F	250	1	1995-	0,6	D7EA	7912	-	DR7EIX	5686
LT-F-4WD	250	1	-	0,7	DR7ES	3123	-	DR7EIX	5686
LT-F-Ozark (4x2)	250		2002-	0,8	DR7EA	7839	-	DR7EIX	5686
LT-R	250	1	1993-	0,6	B9EGV	5827	-	-	-
LT-S	250	1	-	0,9	DPR7EA-9	5129	Q220	DPR7EIX-9	7803
LT-4WD	280	1	1995-	0,6	DR7EA	7839	-	DR7EIX	5686
LT-4WD X	280	1	1995-	0,6	D7EA	7912	-	DR7EIX	5686
LT-F-4WD	280	1	1995-	0,6	DR7EA	7839	-	DR7EIX	5686
LT-F-4WD X	280	1	1993-	0,7	DR7ES	3123	-	DR7EIX	5686
LT	300	1	1987-	0,6	D8EA	2120	Q216	DR8EIX	6681
LT-F	300	1	1999-	0,6	D7EA	7912	-	DR7EIX	5686
KingQuad	400		2008-	0,8	CR7E	4578	Q225	CR7EIX	7385
LT-A-F Auto (4x4)	400		2002-	0,7	CR7E	4578	Q225	CR7EIX	7385
LT-F-F Méca (4x4)	400		2002-	0,7	CR7E	4578	Q225	CR7EIX	7385
LT-Z	400		2002-	0,8	CR7E	1275	Q225	CR7EIX	7385
Z-QuadSport	400		2008-	0,8	CR7E	4578	Q225	CR7EIX	7385
LT-R-KingQuad	450		2008-	0,8	CR8EB	7784	-	CR8EIX	4218
LT-A-F Auto (4x4)	500		2001-	0,7	CR6E	6965	-	-	-
LT-F	500		1998-1999	0,6	CR7E	4578	Q225	CR7EIX	7385
LT-F-F Méca (4x4)	500		2001-	0,7	CR6E	6965	-	-	-
KingQuad	750		2008-	0,7	CR6E	6965	-	-	-

SYM

Track Runner 200	200		2006-	0,8	CR8HSA	2086	-	CR8HIX	7669
GTS	250		2006-	0,7	CR8E	1275	Q226	CR8EIX	4218
Quadlander	250		2006-	0,8	CR8HSA	2086	-	CR8HIX	7669
Quadlander 300	300	1	-	0,7	CR8E	1275	Q226	CR8EIX	4218
GT	500		2004-	0,6	CR7EKB	4455	-	CR7EIX	7385
XP	500		2004-	0,6	CR7EKB	4455	-	CR7EIX	7385
Quadlander 600	600	1	-	0,7	CR8E	1275	Q226	CR8EIX	4218
Quadraider LE	600		-	0,7	CR8E	1275	Q226	CR8EIX	4218

TGB (Taiwan Golden Bee)

Hornet 90	90	1	-	0,7	BPR7HS	6422	Q215	BPR7HIX	5944
Blade E	250		2008-	0,7	CR8E	1275	Q226	CR8EIX	4218
Target 325 SL 2WD	325		-	0,8	CR8E	1275	Q226	CR8EIX	4218
Blade LE	425		2007-	0,7	CR7E	4578	Q225	CR7EIX	7385
Blade S	425		2007-	0,7	CR7E	4578	Q225	CR7EIX	7385
4x2, 4x4 IRS	460	1	2011-	0,7	CR7E	4578	Q225	CR7EIX	7385
4x4 LT IRS, SL IRS	460	1	2011-	0,7	CR7E	4578	Q225	CR7EIX	7385
Blade 4x2 Lady Edition	460	1	2011-	0,7	CR7E	4578	Q225	CR7EIX	7385
500 Target Street'R	500	1	2011-	0,7	CR7E	4578	Q225	CR7EIX	7385
Target 4x4 IRS, LT IRS 4x4	550	1	2011-	0,7	CR7E	4578	Q225	CR7EIX	7385

TRAILBLAZER

50	50	1	-	0,7	BP7HS	5111	-	BPR7HIX	5944
Mini	50	1	-	0,7	BPR7HS	6422	Q215	BPR7HIX	5944

* Bitte Elektrodenabstand nach Angaben des Herstellers justieren

* Please adjust the groundelectrode gap

* Veuillez vérifier l' écartement

* Por favor, ajustar distancia entre electrodos

* regolare il gap

C
y
l

Stock-№

Quick-№



Stock-№ IX

TRAILBLAZER

2 Stroke	90	1	-	0,7	BP7HS	5111	-	BPR7HIX	5944
4 Stroke	90	1	-	0,7	CR7HSA	4549	-	CR7HIX	7544
170	170		2004-	0,7	DR8EA	7162	-	DR8EIX	6681
250	250		-	0,8	CR8HSA	2086	-	CR8HIX	7669

TRAILSPORT

TS-500 5.0hp	500	1	2004-	0,6	BR2-LM	5798	Q310	-	-
TSB-600 6.0hp	600	1	2004-	0,6	BR2-LM	5798	Q310	-	-

TRITON

Baja 300 Limited	280	1	-	0,9	DPR7EA-9	5129	Q220	DPR7EIX-9	7803
Baja 300 R	280	1	-	0,9	DPR7EA-9	5129	Q220	DPR7EIX-9	7803
Outback 300	280	1	-	0,9	DPR7EA-9	5129	Q220	DPR7EIX-9	7803
Outback 300 White Desert	280	1	-	0,9	DPR7EA-9	5129	Q220	DPR7EIX-9	7803

UNILLI

KX 150	150	1	2005-	0,6	CR7E	4578	Q225	CR7EIX	7385
--------	-----	---	-------	-----	------	------	------	--------	------

UNISOM

Desert-Cat 50	50	1	2004-	0,6	BR8HS	4322	Q212	BR8HIX	7001
Desert-Cat 90	90	1	2004-	0,6	BR8HS	4322	Q212	BR8HIX	7001

UNITED MOTORS

Dirt Squirt	50	1	-	0,6	BR8HS	4322	Q212	BR8HIX	7001
Monntrax	50	1	-	0,8	BPR7HS	6422	Q215	BPR7HIX	5944
Dirt Squirt	90	1	-	0,6	BR8HS	4322	Q212	BR8HIX	7001
Earthlander	90	1	-	0,8	BPR7HS	6422	Q215	BPR7HIX	5944
Moontrax	90	1	-	0,6	BPR7HS	6422	Q215	BPR7HIX	5944
Reptile	90	1	-	0,7	C7HSA	4629	-	CR7HIX	7544

VENTO

Avalanche EX100	100	1	-	0,7	BPR6HS	7022	Q214	BPR6HIX	4085
Rhino 250	250		-	0,7	DR8EA	7162	-	DR8EIX	6681

VINSON

ETV 4 Stroke	150	1	-	0,6	C7HSA	4629	-	CR7HIX	7544
ETV 4 Stroke	250		-	0,6	C7HSA	4629	-	CR7HIX	7544

YAMAHA

YFM-RV	50	1	2006-	0,7	CR7HSA	4549	-	CR7HIX	7544
YFM-RX	50	1	2006-	0,7	CR7HSA	4549	-	CR7HIX	7544
YFM-S	50	1	2004-	0,7	CR7HS	7223	-	CR7HIX	7544
YF-(1HN)	60	1	1987-	0,7	BPR6HS	7022	Q214	BPR6HIX	4085
YF-S	60	1	1986-	0,7	BP6HS	4511	-	BPR6HIX	4085
YFM-E	80	1	1993-	0,7	C7HSA	4629	-	CR7HIX	7544
YFM-F	80	1	1993-	0,7	C7HSA	4629	-	CR7HIX	7544
YFM-Grizzly	80	1	2008-	0,7	CR7HSA	4549	-	CR7HIX	7544
YFM-RV	80	1	2006-	0,7	CR7HSA	4549	-	CR7HIX	7544
YFM-S	80	1	1985-	0,7	CR7HSA	4549	-	CR7HIX	7544
YFM-T	80	1	1985-	0,7	CR7HSA	4549	-	CR7HIX	7544

* Bitte Elektrodenabstand nach Angaben des Herstellers justieren

* Please adjust the groundelectrode gap

* Veuillez vérifier L' écartement

* Por favor, ajustar distancia entre electrodos

* regolare il gap

C
Y
L

Stock-No

Quick-No



Stock-No IX

YAMAHA

YFM-W (4x2)	80	1	2002-	0,7	CR7HSA	4549	-	CR7HIX	7544
YFM-Raptor	90	1	2009-	0,8	CR7HSA	4549	-	CR7HIX	7544
YFM-T Champ, U Champ	100	1	1987-	0,7	CR7HSA	4549	-	CR7HIX	7544
Grizzly	125	1	2012-	0,8	CR7HSA	4549	-	CR7HIX	7544
YFA-1 Breeze	125	1	1989-	0,7	CR7HS	7223	-	CR7HIX	7544
YFA-1 F	125	1	1994-	0,7	C7HSA	4629	-	CR7HIX	7544
YFA-Breeze (4x2)	125	1	1996-	0,7	CR7HSA	4549	-	CR7HIX	7544
YFM-A	125	1	2007-	0,8	CR7HSA	4549	-	CR7HIX	7544
YFM-G	125	1	2009-	0,8	CR7HSA	4549	-	CR7HIX	7544
YFM-GHX, GX	125	1	2008-	0,7	CR7HSA	4549	-	CR7HIX	7544
YT	125	1	-	0,8	BP6ES	7811	-	BPR6EIX	6637
YT-CH	125	1	-	0,8	BP6ES	7811	-	BPR6EIX	6637
YT-N	125	1	1985-	0,7	BP5ES	6511	-	BPR5EIX	6597
YZ-Grizzly	125	1	2008-	0,7	CR7HSA	4549	-	CR7HIX	7544
YT	175		-	0,8	BP7ES	2412	Q206	BPR7EIX	4055
YFM	200	1	1992-	0,6	D7EA	7912	-	DR7EIX	5686
YFM-(2HT)	200	1	-	0,7	DR7ES	3123	-	DR7EIX	5686
YFM-(52H)	200	1	1985-	0,7	DR7ES	3123	-	DR7EIX	5686
YFM-(59V)	200	1	-	0,7	DR7ES	3123	-	DR7EIX	5686
YFM-DXS / S / DXT	200		1986-	0,6	D7EA	7912	-	DR7EIX	5686
YFS-Blaster	200	1	1990-2004	0,7	BR8ES	5422	Q207	BR8EIX	5044
YFS-E / F	200	1	1993-	0,8	B8ES	2411	Q201	BR8EIX	5044
TT	225		-	0,7	DR8ES-L	2923	Q218	DR8EIX	6681
YFM-59V/2HT	225	1	1992-	0,7	DR7ES	3123	-	DR7EIX	5686
Raptor	250	1	2012-	0,7	DR7EA	7839	-	DR7EIX	5686
YFB- / E / F / FWF	250		1993-	0,7	D7EA	7912	-	DR7EIX	5686
YFB-/ FW	250		1994-	0,7	DR7EA	7839	-	DR7EIX	5686
YFB-Timberwolf (4x2)	250		-1999	0,7	DR7EA	7839	-	DR7EIX	5686
YFM-(3GH)	250	1	1990-	0,7	DR7ES	3123	-	DR7EIX	5686
YFM-(4x2)	250		1990-	0,7	DR7ES	3123	-	DR7EIX	5686
YFM-Big Bear Raptor	250		2008-	0,7	DR7EA	7839	-	DR7EIX	5686
YFM-Bruin	250	1	2005-	0,6	DR7EA	7839	-	DR7EIX	5686
YFM-R	250	1	2008-	0,7	DR7EA	7839	-	DR7EIX	5686
YFM-Timberwolf	250	1	-	0,7	DR7EA	7839	-	DR7EIX	5686
YFM-X Bear Tracker (4x2)	250		1999-	0,7	DR7EA	7839	-	DR7EIX	5686
YTZ-N / S	250		1985-	0,7	B8ES	2411	Q201	BR8EIX	5044
Raptor	350	1	2012-	0,7	DR8EA	7162	-	DR8EIX	6681
YFM-(4x2)	350		1989-	0,7	DR8ES-L	2923	Q218	DR8EIX	6681
YFM-2HR/2HN	350	1	1992-	0,6	DR8ES-L	2923	Q218	DR8EIX	6681
YFM-4x4 (2HR)	350	1	-	0,7	DR8ES-L	2923	Q218	DR8EIX	6681
YFM-4x4 (3HN)	350	1	-	0,7	DR8ES-L	2923	Q218	DR8EIX	6681
YFM-ERF / FWF / XF	350		1994-	0,7	D8EA	2120	Q216	DR8EIX	6681
YFM-ERT / FWT / XT	350		1987-	0,7	D8EA	2120	Q216	DR8EIX	6681
YFM-FW	350	1	1994-	0,7	DR8EA	7162	-	DR8EIX	6681
YFM-FWB Big Bear (4x4)	350		-2001	0,7	DR8EA	7162	-	DR8EIX	6681
YFM-FWX Wolverine (4x4)	350		-1998	0,7	DR8EA	7162	-	DR8EIX	6681
YFM-Grizzly 4x2 / 4x4	350	1	2009-	0,6	DR8EA	7162	-	DR8EIX	6681
YFM-Grizzly, Raptor, Wolverine	350		2008-	0,7	DR8EA	7162	-	DR8EIX	6681
YFM-U Big Bear (4x2)	350		-2000	0,7	DR8EA	7162	-	DR8EIX	6681
YFM-X Warrior (4x2)	350	1	1995-2003	0,7	DR8EA	7162	-	DR8EIX	6681
YFZ	350	2	1994-	0,8	BR8ES	5422	Q207	BR8EIX	5044
YFZ-Banshee	350	2	1986-	0,8	BR8ES	5422	Q207	BR8EIX	5044

* Bitte Elektrodenabstand nach Angaben des Herstellers justieren

* Please adjust the groundelectrode gap

* Veuillez vérifier L' écartement

* Por favor, ajustar distancia entre electrodos

* regolare il gap

C
y
l

Stock-Nr

Quick-Nr



Stock-Nr IX

YAMAHA

YFZ-E / F	350	2	1993-	0,8	B8ES	2411	Q201	BR8EIX	5044
YFZ-T	350		1987-	0,7	B8ES	2411	Q201	BR8EIX	5044
Big Bear 4x4	400	1	2012-	0,7	DR8EA	7162	-	DR8EIX	6681
Big Bear 4x4 Hunter	400	1	2012-	0,7	DR8EA	7162	-	DR8EIX	6681
YFM	400	1	1993-	0,7	DR8ES-L	2923	Q218	DR8EIX	6681
YFM-AN Kodiak (4x2)	400	1	2003-2004	0,7	DR8EA	7162	-	DR8EIX	6681
YFM-Big Bear 4x4	400	1	2008-	0,6	DR8EA	7162	-	DR8EIX	6681
YFM-FW	400	1	1994-	0,7	DR8EA	7162	-	DR8EIX	6681
YFM-FW Big Bear Pro (4x4)	400		2000-	0,6	DR8EA	7162	-	DR8EIX	6681
YFM-FWA Kodiak	400	1	2000-	0,7	DR8EA	7162	-	DR8EIX	6681
YFM-FWA Kodiak (4x4)	400		-2000	0,6	DR8EA	7162	-	DR8EIX	6681
YFM-FWAN Kodiak (4x2 & 4X4)	400		2003-2004	0,7	DR8EA	7162	-	DR8EIX	6681
YFM-FWF	400	1	1994-	0,7	D8EA	2120	Q216	DR8EIX	6681
YFM	450		2008-	0,7	DR8EA	7162	-	DR8EIX	6681
YFM-Grizzly 4x4	450	1	2009-	0,6	DR7EA	7839	-	DR7EIX	5686
YFM-Wolverine 4x4	450	1	2008-	0,6	DR8EA	7162	-	DR8EIX	6681
YFZ-R, X	450	1	2008-	0,7	CR8E	1275	Q226	CR8EIX	4218
YFZ-V / S	450	1	2004-	0,8	CR8E	1275	Q226	CR8EIX	4218
YFM	500		2008-	0,7	CR7HSA	4549	-	CR7HIX	7544
YFM-G	550		2009-	0,9	LMAR6A-9	5946	-	-	-
YFM-Grizzly	550		2009-	0,9	LMAR7A-9	4908	-	-	-
YFM-FWA Grizzly (4x4)	600		-2001	0,9	DP8EA-9	5829	-	DPR8EIX-9	2202
YFM-FWA Grizzly (4x2 & 4x4)	660		2001-	0,9	DPR8EA-9	4929	Q221	DPR8EIX-9	2202
YFM-Grizzly	660		2008-	0,9	DPR8EA-9	4929	Q221	DPR8EIX-9	2202
YFM-R (4x2)	660	1	2000-2004	0,9	DPR8EA-9	4929	Q221	DPR8EIX-9	2202
YXR-FAS	660		2004-	0,9	DPR8EA-9	4929	Q221	DPR8EIX-9	2202
YXR-Rhino	660		2005-	0,9	DPR8EA-9	4929	Q221	DPR8EIX-9	2202
Grizzly EPS 4wd	700	1	2012-	0,9	LMAR6A-9	5946	-	-	-
Grizzly EPS 4wd Hunter	700	1	2009-	0,9	LMAR6A-9	5946	-	-	-
Raptor	700	1	2005-	0,6	CR7E	4578	Q225	CR7EIX	7385
Raptor R	700	1	2012-	0,6	CR8E	1275	Q226	CR8EIX	4218
Raptor R Special edition	700	1	2012-	0,6	CR8E	1275	Q226	CR8EIX	4218
YFM	700	1	2005-	0,7	CR8E	1275	Q226	CR8EIX	4218
YFM 700 Grizzly	700		2006-2008	0,9	CPR7EA-9	3901	-	CPR7EAIX-9	9198
YFM 700 R	700		2006-	0,7	CR8E	1275	Q226	CR8EIX	4218
YFM 700 Rhino	700		2008-2009	0,9	CPR7EA-9	3901	-	CPR7EAIX-9	9198
YFM-FI EPS	700		2010-	0,9	LMAR6A-9	5946	-	-	-
YFM-Grizzly	700	1	2006-	0,9	CPR7EA-9	3901	-	CPR7EAIX-9	9198
YFM-Grizzly	700	1	2009-	0,9	LMAR7A-9	4908	-	-	-
YFM-R	700	1	2006-	0,7	CR8E	1275	Q226	CR8EIX	4218
YFM-Raptor	700	1	2008-	0,7	CR8E	1275	Q226	CR8EIX	4218
YFM-Rhino	700	1	2008-2009	0,9	CPR7EA-9	3901	-	CPR7EAIX-9	9198
YFM-RV	700	1	2006-	0,8	CR8E	1275	Q226	CR8EIX	4218
YFM-Grizzly	800		2008-	0,7	CR7HSA	4549	-	CR7HIX	7544

ZONGSHEN

ZS 125 ST	125	1	2004-	0,6	BKR5E	7938	-	BKR5EIX	6341
Shineray	200	1	-	0,7	D8EA	2120	Q216	DR8EIX	6681

* Bitte Elektrodenabstand nach Angaben des Herstellers justieren

* Please adjust the groundelectrode gap

* Veuillez vérifier L' écartement

* Por favor, ajustar distancia entre electrodos

* regolare il gap

C
Y
I

0201



Stock-No

Quick-No



Stock-No IX

ARCTIC CAT

Prowler HDX (U2014P5K4C)	500	1	2014-2014	0,7	CR7E	4578	Q225	CR7EIX	7385
Prowler HDX EFI 4x4 UTV	500	1	2014-2014	0,7	CR7E	4578	Q225	CR7EIX	7385
Prowler HDX LTD PS EFI 4x4 UTV	500	1	2014-2014	0,7	CR7E	4578	Q225	CR7EIX	7385
Prowler HDX XT (U2014P6K4C)	500	1	2014-2014	0,7	CR7E	4578	Q225	CR7EIX	7385
Prowler 4x4 Flatbed (U2009P104B)	550	1	2009-2009	0,7	CPR8E	7411	-	-	-
Prowler XT H1 EFI 4x4 UTV	550	1	2010-2010	0,7	CPR8E	7411	-	-	-
Prowler XT H1 EFI 4x4 UTV	550	1	2011-2011	0,7	CPR8E	7411	-	-	-
Prowler XT EFI 4x4 UTV	550	1	2012-2012	0,7	CPR8E	7411	-	-	-
Prowler XT EFI 4x4 UTV	550	1	2013-2013	0,7	CPR8E	7411	-	-	-
Prowler XT (U2013P204E)	550	1	2014-2014	0,7	CPR8E	7411	-	-	-
Prowler XT EFI 4x4 UTV	550	1	2014-2014	0,7	CPR8E	7411	-	-	-
Prowler H1 4x4 Auto (U2007P1S4BUS)	650	1	2007-2007	0,7	CPR8E	7411	-	-	-
Prowler H1 4x4 Auto (U2008P1S4BUS)	650	1	2008-2008	0,7	CPR8E	7411	-	-	-
Prowler XT 4x4 Auto (U2009P2S4BUS)	650	1	2009-2009	0,7	CPR8E	7411	-	-	-
Prowler XT H1 4x4 Auto (U2006P2S4BUS)	650	1	2006-2006	0,7	CPR8E	7411	-	-	-
Prowler XT H1 4x4 Auto (U2007P2S4BUS)	650	1	2007-2007	0,7	CPR8E	7411	-	-	-
Prowler XT H1 4x4 Auto (U2008P2S4BUS)	650	1	2008-2008	0,7	CPR8E	7411	-	-	-
Prowler HDX LTD PS EFI 4x4 UTV	650	1	2014-2014	0,7	CPR8E	7411	-	-	-
Prowler XTX H1 EFI 4x4 UTV	700	1	2011-2011	0,7	CPR8E	7411	-	-	-
Prowler XDX H1 EFI 4x4 UTV	700	1	2011-2011	0,7	CPR8E	7411	-	-	-
Prowler XDX EFI 4x4 UTV	700	1	2012-2012	0,7	CPR8E	7411	-	-	-
Prowler XDX EFI PS 4x4 UTV	700	1	2013-2013	0,7	CPR8E	7411	-	-	-
Prowler XDX (U2014P5T1P)	700	1	2014-2014	0,7	CPR8E	7411	-	-	-
Prowler XT 4x4 (U2009P2T4EUS)	700	1	2009-2009	0,7	CPR8E	7411	-	-	-
Prowler XTX EFI 4x4 UTV	700	1	2012-2012	0,7	CPR8E	7411	-	-	-
Prowler XTX EFI PS 4x4 UTV	700	1	2013-2013	0,7	CPR8E	7411	-	-	-
Prowler XTX (U2014P3T1P)	700	1	2014-2014	0,7	CPR8E	7411	-	-	-
Prowler XTX PS EFI 4x4 UTV	700	1	2014-2014	0,7	CPR8E	7411	-	-	-
Prowler XTX 4x4 (U2009P3T4E)	700	1	2009-2009	0,7	CPR8E	7411	-	-	-
Prowler XTX LE 4x4	700	1	2009-2009	0,7	CPR8E	7411	-	-	-
Prowler XTX H1 EFI 4x4 UTV	700	1	2010-2010	0,7	CPR8E	7411	-	-	-
Prowler XTX H1 4x4 Auto (U2008P2T4EUS)	700	1	2008-2008	0,7	CPR8E	7411	-	-	-
Wildcat Sport	700	1	2015-2015	0,7	CR8EB	7784	-	CR8EIX	4218
Wildcat Trail	700	1	2014-2014	0,7	CR8EB	7784	-	CR8EIX	4218
Wildcat Trail	700	1	2015-2015	0,7	CR8EB	7784	-	CR8EIX	4218
Wildcat Trail Cat	700	1	2015-2015	0,7	CR8EB	7784	-	CR8EIX	4218
Wildcat Trail XT	700	1	2014-2014	0,7	CR8EB	7784	-	CR8EIX	4218
Wildcat Trail XT	700	1	2015-2015	0,7	CR8EB	7784	-	CR8EIX	4218
Prowler XTZ H2 4x4 (U2009P4W4E)	1000	2	2009-2009	0,7	CPR8E	7411	-	-	-
Prowler XTZ H2 EFI 4x4 UTV	1000	2	2010-2010	0,7	CPR8E	7411	-	-	-
Prowler XTZ EFI 4x4 UTV	1000	2	2012-2012	0,7	CPR8E	7411	-	-	-
Prowler XTZ EFI PS 4x4 UTV	1000	2	2013-2013	0,7	CPR8E	7411	-	-	-
Prowler XTZ 4x4 (U2014P4W1P)	1000	2	2014-2014	0,7	CPR8E	7411	-	-	-
Prowler XTZ H2 4x4 Baja (U2009P4W4EUS)	1000	2	2009-2009	0,7	CPR8E	7411	-	-	-
Prowler XTZ H2 EFI 4x4 UTV	1000	2	2011-2011	0,7	CPR8E	7411	-	-	-
Prowler XTZ PS EFI 4x4 UTV	1000	2	2014-2014	0,7	CPR8E	7411	-	-	-
Wildcat (U2013W2W1P)	1000	2	2013-2013	0,7	CPR8E	7411	-	-	-
Wildcat (U2014W3W1P)	1000	2	2014-2014	0,7	CPR8E	7411	-	-	-
Wildcat	1000	2	2015-2015	0,7	CPR8E	7411	-	-	-
Wildcat 4 (U2013W4W1P)	1000	2	2013-2013	0,7	CPR8E	7411	-	-	-
Wildcat 4 (U2014W4W1P)	1000	2	2014-2014	0,7	CPR8E	7411	-	-	-
Wildcat 4 LTD (U2014WBW1P)	1000	2	2014-2014	0,7	CPR8E	7411	-	-	-

* Bitte Elektrodenabstand nach Angaben des Herstellers justieren

* Please adjust the groundelectrode gap

* Veuillez vérifier L' écartement

* Por favor, ajustar distancia entre electrodos

* regolare il gap

C
Y
L

Stock-№

Quick-№



Stock-№ IX

ARCTIC CAT

Wildcat 4 X (U2014WFW1P)	1000	2	2014-2014	0,7	CPR8E	7411	-	-	-
Wildcat 4 X LTD	1000	2	2014-2014	0,7	CPR8E	7411	-	-	-
Wildcat GT (U2012W2W1P)	1000	2	2012-2012	0,7	CPR8E	7411	-	-	-
Wildcat GT	1000	2	2013-2013	0,7	CPR8E	7411	-	-	-
Wildcat Late Build (U2013W3W1P)	1000	2	2013-2013	0,7	CPR8E	7411	-	-	-
Wildcat LTD (U2013W2W1P)	1000	2	2013-2013	0,7	CPR8E	7411	-	-	-
Wildcat LTD (U2014WAW1P)	1000	2	2014-2014	0,7	CPR8E	7411	-	-	-
Wildcat LTD Late Build (U2013W3W1P)	1000	2	2013-2013	0,7	CPR8E	7411	-	-	-
Wildcat X (U2013WSW1P)	1000	2	2013-2013	0,7	CPR8E	7411	-	-	-
Wildcat X (U2014WSW1P)	1000	2	2014-2014	0,7	CPR8E	7411	-	-	-
Wildcat X	1000	2	2015-2015	0,7	CPR8E	7411	-	-	-
Wildcat X LTD (U2014WTW1P)	1000	2	2014-2014	0,7	CPR8E	7411	-	-	-

JOHN DEERE

Gator 4x2	-	-	-	0,8	BPR6ES	7822	-	BPR6EIX	6637
Gator Kawasaki 10 hp	-	-	-	0,6	B5HS	4210	-	-	-
Gator Kawasaki OHV 18hp	-	-	-	0,6	BMR6A	7421	Q307	-	-
Gator Kawasaki FD620D 20hp	-	2	-	0,9	BMR2A-10	4452	-	-	-
Gator Kawasaki FE250D 8hp	250	1	-	0,7	BPR5ES	7422	-	BPR5EIX	6597
Gator Kawasaki FE290D 9.5hp	290	1	-	0,7	BPR5ES	7422	-	BPR5EIX	6597
Gator 6x4	854	3	-	0,9	BMR2A-10	4452	-	-	-

KAWASAKI

KAF 4x2	300	-	1991-1999	0,7	BPR5ES	7422	-	BPR5EIX	6597
KAF D Mule 520	300	-	2000-	0,7	BPR5ES	7422	-	BPR5EIX	6597
KAF Mule 500 (KAF300-B1~2)	300	1	1995-1996	0,7	BPR5ES	7422	-	BPR5EIX	6597
KAF Mule 550 (KAF300-C1~7)	300	1	1997-2004	0,7	BPR5ES	7422	-	BPR5EIX	6597
Mule 610	400	-	2007-	0,7	BPR5ES	7422	-	BPR5EIX	6597
Mule 4x2 , 4x4	401	1	-	0,8	BPR2ES	2264	-	-	-
Mule 600 / Mule 610 4x4	401	1	2010-	0,6	BPR5ES	7422	-	BPR5EIX	6597
Mule 1000 / KAF 450B (UV)	450	-	1990-	0,7	D6EA	7512	-	-	-
KAF	450	-	1991-	0,7	D7EA	7912	-	DR7EIX	5686
KAF Liq. Cool.	450	-	1992-1996	0,7	D6EA	7512	-	-	-
KAF	550	-	1994-	0,7	BPR5ES	7422	-	BPR5EIX	6597
KAF B Mule 2520 / C Mule 2500	620	-	1993-	0,7	BMR2A	7677	-	-	-
KAF Mule 2500 (KAF620-C1~6)	620	2	1995-2000	0,6	BMR2A	7677	-	-	-
KAF Mule 2510 4x4 (KAF620-A1~6)	620	2	1995-2000	0,6	BMR2A	7677	-	-	-
KAF Mule 3000 (KAF620-G1~4)	620	2	2001-2004	0,6	BPR2ES	2264	-	-	-
KAF Mule 3010 4x4(KAF620-E1~4)	620	2	2001-2004	0,6	BPR2ES	2264	-	-	-
KAF Mule 2510 Diesel (KAF950-A1~3) -11V-	950	3	2000-2002	-	Y-706R	3041	-	-	-
KAF Mule 3010 4x4 Diesel (KAF950-B1~2) -11V-	950	-	2003-2004	-	Y-706R	3041	-	-	-
KAF Mule 3010 Trans Diese I-11V-	950	-	2007-	-	Y-706R	3041	-	-	-
KAF Mule 4010 Diesel 4x4 -11V-	953	3	2010-	-	Y-706R	3041	-	-	-

KYMCO

UXV	500	1	2008-	0,9	DPR7EA-9	5129	Q220	DPR7EIX-9	7803
UXV	500	1	-	0,6	CR7E	4578	Q225	CR7EIX	7385

POLARIS

UTV 2x4 24 hp 4 Stroke	-	-	-	0,6	BKR5E	7938	-	BKR5EIX	6341
UTV 4x4 30 hp 4 Stroke	-	-	-	0,6	BKR5E	7938	-	BKR5EIX	6341

* Bitte Elektrodenabstand nach Angaben des Herstellers justieren

* Please adjust the groundelectrode gap

* Veuillez vérifier L' écartement

* Por favor, ajustar distancia entre electrodos

* regolare il gap

C
Y
I

0201



Stock-No

Quick-No



Stock-No IX

POLARIS

UTV 6x6 30 hp 4 Stroke	-	-	-	0,6	BKR5E	7938	-	BKR5EIX	6341
Ranger 4x4	400	1	2014-2014	0,9	BKR6E	6962	-	BKR6EIX	6418
Ranger 4x4 HO	400	1	2010-2012	0,9	BKR6E	6962	-	BKR6EIX	6418
Ranger Midsize	400	1	2013-2013	0,9	BKR6E	6962	-	BKR6EIX	6418
Hauler Light Utility EH50	500		2002-	0,6	BKR5E	7938	-	BKR5EIX	6341
Ranger	500	1	1999-1999	0,8	BKR5E	7938	-	BKR5EIX	6341
Ranger 2x4	500	1	2004-2008	0,7	BKR5E	7938	-	BKR5EIX	6341
Ranger 2x4 Carb.	500	1	2009-2009	0,7	BKR5E	7938	-	BKR5EIX	6341
Ranger 4x4	500	1	2004-2007	0,7	BKR5E	7938	-	BKR5EIX	6341
Ranger 4x4 Crew	500	1	2011-2012	0,7	BKR5E	7938	-	BKR5EIX	6341
Ranger 4x4 EFI	500	1	2006-2009	0,7	BKR6E	6962	-	BKR6EIX	6418
Ranger 4x4 EFI	500	1	2010-2012	0,7	BKR5E	7938	-	BKR5EIX	6341
Ranger 6x6	500	1	2004-2005	0,7	BKR5E	7938	-	BKR5EIX	6341
Ranger 4x4 crew - Pursuit camo	500	1	2012-	0,8	BKR5E	7938	-	BKR5EIX	6341
Ranger 4x4 crew - Sagebrush green	500	1	2012-	0,8	BKR5E	7938	-	BKR5EIX	6341
Ranger 4x4 crew - Solar red	500	1	2012-	0,8	BKR5E	7938	-	BKR5EIX	6341
Ranger 4x4 crew le - Turbo silver	500	1	2012-	0,8	BKR5E	7938	-	BKR5EIX	6341
Ranger Crew Midsize	500	1	2013-2013	0,7	BKR5E	7938	-	BKR5EIX	6341
Ranger Midsize	500	1	2013-2013	0,7	BKR5E	7938	-	BKR5EIX	6341
Ranger EFI	570	1	2014-2014	0,6	CPR8E	7411	-	-	-
Ranger EFI Crew	570	1	2014-2014	0,6	CPR8E	7411	-	-	-
RZR EFI	570	1	2012-2014	0,6	CPR8E	7411	-	-	-
RZR EFI INTL	570	1	2012-2013	0,6	CPR8E	7411	-	-	-
Ranger TM (A04RB63AA)	653	2	2004-2004	0,7	BPR4EY	2128	-	-	-
Ranger 4x4 EFI	700	2	2009-2009	0,7	BKR7E	6097	-	BKR7EIX	2667
Ranger 4x4 EFI / LE	700	2	2007-2007	0,7	BKR7E	6097	-	BKR7EIX	2667
Ranger 4x4 EFI / XP	700	2	2008-2008	0,7	BKR7E	6097	-	BKR7EIX	2667
Ranger 4x4 EFI Crew	700	2	2008-2008	0,7	BKR7E	6097	-	BKR7EIX	2667
Ranger 4x4 EFI Crew	700	2	2009-2009	0,7	BKR7E	6097	-	BKR7EIX	2667
Ranger 6x6 EFI	700	2	2006-2008	0,7	BKR7E	6097	-	BKR7EIX	2667
Ranger 6x6 EFI	700	2	2009-2009	0,7	BKR7E	6097	-	BKR7EIX	2667
Ranger XP (R05RD68AA)	700	2	2005-2005	0,7	BKR7E	6097	-	BKR7EIX	2667
Ranger XP 4x4 (R06RD68AA)	700	2	2006-2006	0,7	BKR7E	6097	-	BKR7EIX	2667
Ranger	800	2	2014-2014	0,7	BKR7E	6097	-	BKR7EIX	2667
Ranger EFI Midsize	800	2	2013-2014	0,7	BKR7E	6097	-	BKR7EIX	2667
Ranger 4x4 EFI	800	2	2010-2010	0,7	BKR7E	6097	-	BKR7EIX	2667
Ranger 4x4 EFI	800	2	2011-2011	0,7	BKR7E	6097	-	BKR7EIX	2667
Ranger 4x4 EFI Crew	800	2	2010-2010	0,7	BKR7E	6097	-	BKR7EIX	2667
Ranger 4x4 EFI Crew	800	2	2011-2014	0,7	BKR7E	6097	-	BKR7EIX	2667
Ranger 6x6 EFI	800	2	2010-2010	0,7	BKR7E	6097	-	BKR7EIX	2667
Ranger 6x6 EFI	800	2	2011-2014	0,7	BKR7E	6097	-	BKR7EIX	2667
Ranger XP	800	2	2012-2012	0,7	BKR7E	6097	-	BKR7EIX	2667
RZR EFI	800	2	2008-2008	0,7	BKR7E	6097	-	BKR7EIX	2667
RZR EFI	800	2	2009-2010	0,7	BKR7E	6097	-	BKR7EIX	2667
RZR EFI	800	2	2011-2011	0,7	BKR7E	6097	-	BKR7EIX	2667
RZR EFI / EPS	800	2	2012-2014	0,7	BKR7E	6097	-	BKR7EIX	2667
Ranger EFI - White lightning/black	800	2	2012-	0,7	BKR7E	6097	-	BKR7EIX	2667
RZR 4 EFI	800	2	2010-2010	0,7	BKR7E	6097	-	BKR7EIX	2667
RZR 4 EFI	800	2	2012-2014	0,7	BKR7E	6097	-	BKR7EIX	2667
Ranger EFI EPS INTL	800	2	2012-	0,7	BKR7E	6097	-	BKR7EIX	2667
RZR 4 EFI EPS INTL	800	2	2012-2012	0,7	BKR7E	6097	-	BKR7EIX	2667
RZR 4 EPS RGE	800	2	2011-2011	0,7	BKR7E	6097	-	BKR7EIX	2667

* Bitte Elektrodenabstand nach Angaben des Herstellers justieren

* Please adjust the groundelectrode gap

* Veuillez vérifier L' écartement

* Por favor, ajustar distancia entre electrodos

* regolare il gap



C
y
l



Stock-№

Quick-№



Stock-№ IX

POLARIS

RZR 4 INTL	800	2	2011-2011	0,7	BKR7E	6097	-	BKR7EIX	2667
RZR S EFI	800	2	2009-2010	0,7	BKR7E	6097	-	BKR7EIX	2667
RZR S EFI	800	2	2011-2011	0,7	BKR7E	6097	-	BKR7EIX	2667
RZR S EFI	800	2	2012-2013	0,7	BKR7E	6097	-	BKR7EIX	2667
RZR S EFI INTL	800	2	2009-2010	0,7	BKR7E	6097	-	BKR7EIX	2667
RZR S EPS INTL	800	2	2011-2011	0,7	BKR7E	6097	-	BKR7EIX	2667
RZR S Ranger EFI - Indy red	800	2	2012-	0,7	BKR7E	6097	-	BKR7EIX	2667
RZR S Ranger EFI - Vogue silver/indy red	800	2	2012-	0,7	BKR7E	6097	-	BKR7EIX	2667
SDi 2 Stroke	800	2	2012-	0,7	GR9A-EG	94841	-	-	-

YAMAHA

YXR Rhino	450		2006-	0,7	DR8EA	7162	-	DR8EIX	6681
YXR AS, AT Rhino	660		2004-	0,9	DPR8EA-9	4929	Q221	DPR8EIX-9	2202
YFM Rhino FI Hunter	700	1	2008-	0,9	CPR7EA-9	3901	-	CPR7EAIX-9	9198
YXR Rhino FI	700	1	2008-	0,9	CPR7EA-9	3901	-	CPR7EAIX-9	9198
YXP AS/AT/AVL Pro Hauler 2WD - Hot Spark Plug	700		2004-2007	0,8	BPR2ES	2264	-	-	-
YXP AS/AT/AVL Pro Hauler 2WD - Cold Spark Plug	700		2004-2007	0,8	BPR4ES	7222	-	-	-
RTV (Diesel Engine) -11V-	900		2004-		YE01	2649	-	-	-
YXP AS/AT Pro hauler - Hot Spark Plug	1000		2004-2006	0,8	BPR2ES	2264	-	-	-
YXP AS/AT Pro hauler - Cold Spark Plug	1000		2004-2006	0,8	BPR4ES	7222	-	-	-

* Bitte Elektrodenabstand nach Angaben des Herstellers justieren

* Please adjust the groundelectrode gap

* Veuillez vérifier L' écartement

* Por favor, ajustar distancia entre electrodos

* regolare il gap



Stock-No

Quick-No



Stock-No IX

ARCTIC CAT

Kitty Cat 60	60	1992-1999	0,7	BR6HS	3922	Q209	BR6HIX	3419
AC 120 SnoPro (4 Stroke)	120	2007-2009	0,9	BPR6ES	7822	-	BPR6EIX	6637
AC 120 SnoPro (4 Stroke)	120	2010-2013	0,8	BPR4ES	7222	-	-	-
F 120	120	2006-	0,9	BPR6ES	7822	-	BPR6EIX	6637
Z 120	120	2000-2001	0,9	BPR6ES	7822	-	BPR6EIX	6637
Z 120 Sno-Pro	120	2001-	0,9	BPR6ES	7822	-	BPR6EIX	6637
ZR 120	120	2002-2005	0,9	BPR6ES	7822	-	BPR6EIX	6637
ZR 120 (4 Stroke)	120	2014-2015	0,8	BPR4ES	7222	-	-	-
Bearcat 340	340	1995-1997	0,7	BR9ES	5722	Q208	BR9EIX	3981
Bearcat 340	340	1998-2000	0,7	BR9EYA	7548	-	BR9EIX	3981
JAG 340	340	1998-1999	0,7	BR9EYA	7548	-	BR9EIX	3981
JAG 340	340	1997-	0,7	BR9ES	5722	Q208	BR9EIX	3981
JAG 340 Deluxe	340	1997-	0,7	BR9ES	5722	Q208	BR9EIX	3981
Lynx 340	340	1993-	0,7	BR9ES	5722	Q208	BR9EIX	3981
Lynx 340 Deluxe	340	1993-	0,7	BR9ES	5722	Q208	BR9EIX	3981
Lynx 340 Mountain Cat	340	1992-	0,7	BR9ES	5722	Q208	BR9EIX	3981
Lynx 340 Mountain Cat	340	1993-	0,7	BR9ES	5722	Q208	BR9EIX	3981
Phanter 340	340	1998-2000	0,7	BR9EYA	7548	-	BR9EIX	3981
Puma 340	340	1994-1997	0,7	BR9ES	5722	Q208	BR9EIX	3981
Puma 340 2-up	340	1994-1997	0,7	BR9ES	5722	Q208	BR9EIX	3981
Puma 340 Deluxe	340	1994-1997	0,7	BR9ES	5722	Q208	BR9EIX	3981
Panther 370	370	2001-	0,7	BR9EYA	7548	-	BR9EIX	3981
Panther 370 (2 Stroke)	370	2007-2008	0,7	BR9EYA	7548	-	BR9EIX	3981
Panther 370 R (2 Stroke)	370	2003-2006	0,7	BR9EYA	7548	-	BR9EIX	3981
Z 370	370	1999-2007	0,7	BR9EYA	7548	-	BR9EIX	3981
Z 370 ES	370	2000-2002	0,7	BR9EYA	7548	-	BR9EIX	3981
Z 370 ESR	370	2003-	0,7	BR9EYA	7548	-	BR9EIX	3981
Z 370 LX	370	2004-2007	0,7	BR9EYA	7548	-	BR9EIX	3981
ZR 400	400	1996-	0,7	BR9ES	5722	Q208	BR9EIX	3981
Jag	400	1991-	0,6	BR9ES	3194	Q208	BR9EIX	3981
Super Jag	400	1987-	0,6	BR9ES	3194	Q208	BR9EIX	3981
Bearcat 440	440	1995-1997	0,7	BR9ES	5722	Q208	BR9EIX	3981
Bearcat 440	440	1998-	0,7	BR9EYA	7548	-	BR9EIX	3981
Bearcat 440 I	440	1999-2000	0,7	BR9EYA	7548	-	BR9EIX	3981
Bearcat 440 II	440	1999-2000	0,7	BR9EYA	7548	-	BR9EIX	3981
Cheetah 440 1-Speed	440	1994-	0,7	BR9ES	5722	Q208	BR9EIX	3981
Cheetah 440 2-Speed	440	1994-	0,7	BR9ES	5722	Q208	BR9EIX	3981
Panther 440	440	1997-	0,7	BR9ES	5722	Q208	BR9EIX	3981
Panther 440	440	1998-2002	0,7	BR9EYA	7548	-	BR9EIX	3981
Panther 440 Deluxe	440	1991-1996	0,7	BR9ES	5722	Q208	BR9EIX	3981
Panther 440 ESR	440	2001-	0,7	BR9EYA	7548	-	BR9EIX	3981
Panther 440 LC	440	1996-	0,7	BR9ES	5722	Q208	BR9EIX	3981
Panther 440 Mountain Cat	440	1990-	0,7	BR9ES	5722	Q208	BR9EIX	3981
Panther 440 Mountain Cat	440	1991-	0,7	BR9ES	5722	Q208	BR9EIX	3981
Panther 440 Rental	440	1995-	0,7	BR9ES	5722	Q208	BR9EIX	3981
Prowler Special 440	440	1992-	0,7	BR9ES	5722	Q208	BR9EIX	3981
AC 440 Sno-Pro	440	2003-2006	0,7	BR9EYA	7548	-	BR9EIX	3981
AC 440 Sno-Pro Modified Race Sled	440	2005-2006	0,7	BR9EYA	7548	-	BR9EIX	3981
JAG 440	440	1991-1996	0,7	BR9ES	5722	Q208	BR9EIX	3981
JAG 440	440	1998-1999	0,7	BR9EYA	7548	-	BR9EIX	3981
JAG 440 DELUXE	440	1991-1996	0,7	BR9ES	5722	Q208	BR9EIX	3981
JAG 440 DELUXE	440	1998-1999	0,7	BR9EYA	7548	-	BR9EIX	3981

* Bitte Elektrodenabstand nach Angaben des Herstellers justieren

* Please adjust the groundelectrode gap

* Veuillez vérifier L' écartement

* Por favor, ajustar distancia entre electrodos

* regolare il gap



Stock-No

Quick-No



Stock-No IX

ARCTIC CAT

JAG 440 Liquid	440	1996-	0,7	BR9ES	5722	Q208	BR9EIX	3981
Z 440	440	1995-1997	0,7	BR9ES	5722	Q208	BR9EIX	3981
Z 440	440	1998-2002	0,7	BR9EYA	7548	-	BR9EIX	3981
Z 440 ES	440	2000-2002	0,7	BR9EYA	7548	-	BR9EIX	3981
Z 440 ESR	440	2003-	0,7	BR9EYA	7548	-	BR9EIX	3981
Z 440 LX	440	2004-2006	0,7	BR9EYA	7548	-	BR9EIX	3981
Z 440 Sno-Pro	440	2000-2003	0,7	BR9EYA	7548	-	BR9EIX	3981
ZL 440	440	1996-1997	0,7	BR9ES	5722	Q208	BR9EIX	3981
ZL 440	440	1998-2000	0,7	BR9EYA	7548	-	BR9EIX	3981
ZR 440	440	1993-1997	0,7	BR9ES	5722	Q208	BR9EIX	3981
ZR 440	440	1998-	0,7	BR9EYA	7548	-	BR9EIX	3981
ZR 440 Sno-Pro	440	1998-	0,7	BR9EYA	7548	-	BR9EIX	3981
ZR 440 Sno-Pro	440	1999-	0,7	BR9EYA	7548	-	BR9EIX	3981
ZR 440 Sno-Pro	440	2002-2002	0,7	BR9EYA	7548	-	BR9EIX	3981
ZR 440 Sno-Pro (Sno-Cross)	440	2000-2001	0,7	BR9EYA	7548	-	BR9EIX	3981
ZR 440 Sno-Pro (Cross Country)	440	2000-2001	0,7	BR9EYA	7548	-	BR9EIX	3981
500 Sno-Pro	500	2010-2014	0,7	BR9EYA	7548	-	BR9EIX	3981
Firecat 500	500	2003-2006	0,7	BR9EYA	7548	-	BR9EIX	3981
Firecat 500 Sno-Pro	500	2003-2006	0,7	BR9EYA	7548	-	BR9EIX	3981
Mountain Cat 500	500	2001-2002	0,7	BR9EYA	7548	-	BR9EIX	3981
Powder Special 500 EFI	500	1999-2000	0,7	BR9EYA	7548	-	BR9EIX	3981
Powder Special 500 EFI LE	500	2000-2000	0,7	BR9EYA	7548	-	BR9EIX	3981
Sabercat 500	500	2004-2006	0,7	BR9EYA	7548	-	BR9EIX	3981
Sabercat 500 LX	500	2004-2006	0,7	BR9EYA	7548	-	BR9EIX	3981
CrossFire 500 EFI	500	2007-2009	0,7	BR9EYA	7548	-	BR9EIX	3981
F 5 EFI	500	2007-2009	0,7	BR9EYA	7548	-	BR9EIX	3981
F 5	500	2013-2014	0,7	BR9EYA	7548	-	BR9EIX	3981
F 5 LXR 2 Stroke	500	2007-2012	0,7	BR9EYA	7548	-	BR9EIX	3981
M 5	500	2005-2006	0,7	BR9EYA	7548	-	BR9EIX	3981
T 500	500	2007-2009	0,7	BR9EYA	7548	-	BR9EIX	3981
ZL 500	500	1998-	0,7	BR9EYA	7548	-	BR9EIX	3981
ZL 500	500	1999-2000	0,7	BR9EYA	7548	-	BR9EIX	3981
ZL 500	500	2002-2002	0,7	BR9EYA	7548	-	BR9EIX	3981
ZL 500 EFI	500	1999-2000	0,7	BR9EYA	7548	-	BR9EIX	3981
ZL 500 EFI ESR	500	2001-	0,7	BR9EYA	7548	-	BR9EIX	3981
ZR 500 (January)	500	1998-	0,7	BR9EYA	7548	-	BR9EIX	3981
ZR 500 (2nd Run)	500	1998-	0,7	BR9EYA	7548	-	BR9EIX	3981
ZR 500	500	1999-2002	0,7	BR9EYA	7548	-	BR9EIX	3981
ZR 500 CC	500	2002-2002	0,7	BR9EYA	7548	-	BR9EIX	3981
ZR 500 EFI	500	1999-2001	0,7	BR9EYA	7548	-	BR9EIX	3981
ZR 500 EFI LE	500	1999-	0,7	BR9EYA	7548	-	BR9EIX	3981
ZR 500 LE	500	1999-	0,7	BR9EYA	7548	-	BR9EIX	3981
ZR 500 LE	500	2002-2002	0,7	BR9EYA	7548	-	BR9EIX	3981
Bearcat 550	550	1995-1996	0,7	BR9ES	5722	Q208	BR9EIX	3981
Bearcat Wide Track 550	550	1996-1997	0,7	BR9ES	5722	Q208	BR9EIX	3981
Bearcat Wide Track 550	550	1998-	0,7	BR9EYA	7548	-	BR9EIX	3981
Bearcat Wide Track 550	550	1999-2002	0,7	BR9EYA	7548	-	BR9EIX	3981
Bearcat Wide Track 550	550	2003-2007	0,8	KR8AI	5477	-	-	-
Cougar 550	550	1995-1997	0,7	BR9ES	5722	Q208	BR9EIX	3981
Cougar 550	550	1998-	0,7	BR9EYA	7548	-	BR9EIX	3981
Cougar 2-Up 550	550	1996-	0,7	BR9ES	5722	Q208	BR9EIX	3981
Cougar Deluxe 550	550	1998-	0,7	BR9EYA	7548	-	BR9EIX	3981

* Bitte Elektrodenabstand nach Angaben des Herstellers justieren

* Please adjust the groundelectrode gap

* Veuillez vérifier l' écartement

* Por favor, ajustar distancia entre electrodos

* regolare il gap



Stock-No

Quick-No



Stock-No IX

ARCTIC CAT

Cougar Mountain Cat 550	550	1995-1997	0,7	BR9ES	5722	Q208	BR9EIX	3981
Cougar Mountain Cat 550	550	1998-	0,7	BR9EYA	7548	-	BR9EIX	3981
Cougar Mountain Cat 550	550	1993-1994	0,7	BR9ES	3194	Q208	BR9EIX	3981
Pantera 550	550	1993-1994	0,7	BR9ES	5722	Q208	BR9EIX	3981
Pantera 550	550	2002-2005	0,7	BR9EYA	7548	-	BR9EIX	3981
Phanter 550	550	1997-	0,7	BR9ES	5722	Q208	BR9EIX	3981
Phanter 550	550	1998-	0,7	BR9EYA	7548	-	BR9EIX	3981
Phanter 550	550	1999-2001	0,7	BR9EYA	7548	-	BR9EIX	3981
Prowler 2-Up 550	550	1995-	0,7	BR9ES	5722	Q208	BR9EIX	3981
EXT 550 EFI	550	1993-	0,7	BR9ES	5722	Q208	BR9EIX	3981
EXT 550 EFI Mountain Cat	550	1993-	0,7	BR9ES	5722	Q208	BR9EIX	3981
EXT 550 Mountain Cat	550	1992-	0,7	BR9ES	5722	Q208	BR9EIX	3981
ZL550	550	2001-2003	0,7	BR9EYA	7548	-	BR9EIX	3981
ZL550 ESR	550	2000-2000	0,7	BR9EYA	7548	-	BR9EIX	3981
ZL550 ESR	550	2001-2003	0,7	BR9EYA	7548	-	BR9EIX	3981
Bearcat 570	570	2004-2014	0,7	BR9EYA	7548	-	BR9EIX	3981
Bearcat 570 XT	570	2009-2014	0,7	BR9EYA	7548	-	BR9EIX	3981
Bearcat 570 XTE	570	2014-	0,7	BR9EYA	7548	-	BR9EIX	3981
Mountain Cat 570	570	2002-2004	0,7	BR9EYA	7548	-	BR9EIX	3981
Panther 570	570	2002-2002	0,7	BR9EYA	7548	-	BR9EIX	3981
Panther 570	570	2004-2007	0,7	BR9EYA	7548	-	BR9EIX	3981
Panther 570 ESR	570	2002-2002	0,7	BR9EYA	7548	-	BR9EIX	3981
Panther 570 ESR	570	2003-	0,7	BR9EYA	7548	-	BR9EIX	3981
Panther 570 R	570	2002-2002	0,7	BR9EYA	7548	-	BR9EIX	3981
F 570	570	2008-2014	0,7	BR9EYA	7548	-	BR9EIX	3981
T 570 Touring	570	2008-2014	0,7	BR9EYA	7548	-	BR9EIX	3981
Z 570	570	2002-2002	0,7	BR9EYA	7548	-	BR9EIX	3981
Z 570	570	2002-2007	0,7	BR9EYA	7548	-	BR9EIX	3981
Z 570 ESR	570	2003-	0,7	BR9EYA	7548	-	BR9EIX	3981
Z 570 ESR	570	2002-2002	0,7	BR9EYA	7548	-	BR9EIX	3981
Z 570 LX	570	2004-2007	0,7	BR9EYA	7548	-	BR9EIX	3981
Z 570 SS	570	2002-2002	0,7	BR9EYA	7548	-	BR9EIX	3981
EXT 580	580	1994-1996	0,7	BR9ES	5722	Q208	BR9EIX	3981
EXT 580 EFI	580	1995-1997	0,7	BR9ES	5722	Q208	BR9EIX	3981
EXT 580 EFI	580	1998-	0,7	BR9EYA	7548	-	BR9EIX	3981
EXT 580 EFI MC Deep Lug	580	1995-	0,7	BR9ES	5722	Q208	BR9EIX	3981
EXT 580 EFI DELUXE	580	1996-1997	0,7	BR9ES	5722	Q208	BR9EIX	3981
EXT 580 EFI DELUXE	580	1998-	0,7	BR9EYA	7548	-	BR9EIX	3981
EXT 580 EFI Mountain cat	580	1994-1996	0,7	BR9ES	5722	Q208	BR9EIX	3981
EXT 580 Powder Special	580	1995-1996	0,7	BR9ES	5722	Q208	BR9EIX	3981
Pantera 580	580	1994-1994	0,7	BR9ES	5722	Q208	BR9EIX	3981
Pantera 580	580	1998-	0,7	BR9EYA	7548	-	BR9EIX	3981
Pantera 580 EFI	580	1999-2001	0,7	BR9EYA	7548	-	BR9EIX	3981
Powder Special 580	580	1997-	0,7	BR9EYA	7548	-	BR9EIX	3981
Powder Special 580 EFI	580	1997-	0,7	BR9EYA	7548	-	BR9EIX	3981
ZL 580 EFI ESR	580	2000-2000	0,7	BR9EYA	7548	-	BR9EIX	3981
ZR 580	580	1993-1996	0,7	BR9ES	5722	Q208	BR9EIX	3981
ZR 580	580	1997-	0,7	BR9EYA	7548	-	BR9EIX	3981
ZR 580 EFI	580	1995-1996	0,7	BR9ES	5722	Q208	BR9EIX	3981
ZR 580 EFI ETT	580	1996-	0,7	BR9ES	5722	Q208	BR9EIX	3981
600 Sno-Pro Racer	600	2008-2009	0,7	BR9EYA	7548	-	BR9EIX	3981
600 Sno-Pro Factory Racer	600	2010-2014	0,7	BR9EYA	7548	-	BR9EIX	3981

* Bitte Elektrodenabstand nach Angaben des Herstellers justieren

* Please adjust the groundelectrode gap

* Veuillez vérifier L' écartement

* Por favor, ajustar distancia entre electrodos

* regolare il gap



Stock-№

Quick-№



Stock-№ IX

ARCTIC CAT

600 Sno-Pro Cross Country Racer	600	2011-2014	0,7	BR9EYA	7548	-	BR9EIX	3981
Firecat 600	600	2005-2006	0,7	BR9EYA	7548	-	BR9EIX	3981
Firecat 600 Black Widow	600	2005-	0,7	BR9EYA	7548	-	BR9EIX	3981
Firecat 600 Early Build	600	2004-	0,7	BR9EYA	7548	-	BR9EIX	3981
Firecat 600 EXT	600	2004-2005	0,7	BR9EYA	7548	-	BR9EIX	3981
Firecat 600 Fighter	600	2004-	0,7	BR9EYA	7548	-	BR9EIX	3981
Firecat 600 Jocker	600	2005-	0,7	BR9EYA	7548	-	BR9EIX	3981
Firecat 600 Nightfire	600	2004-	0,7	BR9EYA	7548	-	BR9EIX	3981
Firecat 600 Retro	600	2005-	0,7	BR9EYA	7548	-	BR9EIX	3981
Firecat 600 Team Arctic	600	2004-2005	0,7	BR9EYA	7548	-	BR9EIX	3981
Firecat 600 Tiger	600	2004-	0,7	BR9EYA	7548	-	BR9EIX	3981
Firecat 600 R	600	2005-2006	0,7	BR9EYA	7548	-	BR9EIX	3981
Firecat 600 Sno-Pro	600	2004-2006	0,7	BR9EYA	7548	-	BR9EIX	3981
Firecat 600 Sno-Pro Black Widow	600	2005-	0,7	BR9EYA	7548	-	BR9EIX	3981
Firecat 600 Sno-Pro Fighter	600	2004-	0,7	BR9EYA	7548	-	BR9EIX	3981
Firecat 600 Sno-Pro Jocker	600	2005-	0,7	BR9EYA	7548	-	BR9EIX	3981
Firecat 600 Sno-Pro Nightfire	600	2004-	0,7	BR9EYA	7548	-	BR9EIX	3981
Firecat 600 Sno-Pro Retro	600	2005-	0,7	BR9EYA	7548	-	BR9EIX	3981
Firecat 600 Sno-Pro Team Arctic	600	2004-2005	0,7	BR9EYA	7548	-	BR9EIX	3981
Firecat 600 Sno-Pro Tiger	600	2004-	0,7	BR9EYA	7548	-	BR9EIX	3981
Mountain Cat 600 EFI	600	2001-2004	0,7	BR9EYA	7548	-	BR9EIX	3981
Mountain Cat 600 EFI LE	600	2001-2002	0,7	BR9EYA	7548	-	BR9EIX	3981
Mountain Cat 600 VEV	600	2001-	0,7	BR9EYA	7548	-	BR9EIX	3981
Pantera 600	600	2003-2005	0,7	BR9EYA	7548	-	BR9EIX	3981
Pantera 600 ESR	600	2002-2002	0,7	BR9EYA	7548	-	BR9EIX	3981
Powder Extreme 600	600	1997-	0,7	BR9ES	5722	Q208	BR9EIX	3981
Powder Extreme 600	600	1998-	0,7	BR9EYA	7548	-	BR9EIX	3981
Powder Special 2K 600	600	2000-2000	0,7	BR9EYA	7548	-	BR9EIX	3981
Powder Special 600	600	1998-	0,7	BR9EYA	7548	-	BR9EIX	3981
Powder Special 600	600	1999-	0,7	BR9EYA	7548	-	BR9EIX	3981
Powder Special 600	600	2000-2000	0,7	BR9EYA	7548	-	BR9EIX	3981
Powder Special 600 LE	600	2000-2000	0,7	BR9EYA	7548	-	BR9EIX	3981
Powder Special 600 EFI	600	1998-	0,7	BR9EYA	7548	-	BR9EIX	3981
Powder Special 600 EFI	600	2000-2000	0,7	BR9EYA	7548	-	BR9EIX	3981
Powder Special 600 EFI I	600	1999-	0,7	BR9EYA	7548	-	BR9EIX	3981
Powder Special 600 EFI II LE	600	1999-	0,7	BR9EYA	7548	-	BR9EIX	3981
Powder Special 600 EFI LE	600	1998-	0,7	BR9EYA	7548	-	BR9EIX	3981
Powder Special 600 EFI LE	600	2000-2000	0,7	BR9EYA	7548	-	BR9EIX	3981
Sabercat 600	600	2004-2005	0,7	BR9EYA	7548	-	BR9EIX	3981
Sabercat 600 EXT	600	2004-2005	0,7	BR9EYA	7548	-	BR9EIX	3981
Sabercat 600 LX	600	2004-2006	0,7	BR9EYA	7548	-	BR9EIX	3981
Triple Touring 600	600	1998-1999	0,7	BR9EYA	7548	-	BR9EIX	3981
Triple Touring 600	600	2000-2001	0,7	BR9EYA	7548	-	BR9EIX	3981
AC600 Modified Sno-Pro	600	2007-	0,7	BR9EYA	7548	-	BR9EIX	3981
CrossFire 600 EFI	600	2006-2011	0,7	BR9EYA	7548	-	BR9EIX	3981
CrossFire 600 Sno-Pro	600	2006-	0,7	BR9EYA	7548	-	BR9EIX	3981
EXT 600	600	1997-	0,7	BR9ES	5722	Q208	BR9EIX	3981
EXT 600 Tour	600	1998-	0,7	BR9EYA	7548	-	BR9EIX	3981
EXT 600 Triple	600	1998-	0,7	BR9EYA	7548	-	BR9EIX	3981
F6	600	2007-2008	0,7	BR9EYA	7548	-	BR9EIX	3981
F6 LXR	600	2007-2008	0,7	BR9EYA	7548	-	BR9EIX	3981
F6 Sno-Pro	600	2007-2011	0,7	BR9EYA	7548	-	BR9EIX	3981

* Bitte Elektrodenabstand nach Angaben des Herstellers justieren

* Please adjust the groundelectrode gap

* Veuillez vérifier l' écartement

* Por favor, ajustar distancia entre electrodos

* regolare il gap



Stock-No

Quick-No



Stock-No IX

ARCTIC CAT

M 6 EFI	600	2005-2011	0,7	BR9EYA	7548	-	BR9EIX	3981
M6000 Sno-Pro	600	2014-	0,7	BPR9ES	7788	-	BPR9EIX	6853
ZL600	600	1999-2000	0,7	BR9EYA	7548	-	BR9EIX	3981
ZL600 EFI (SN --> 9915688)	600	1999-2003	0,7	BR9EYA	7548	-	BR9EIX	3981
ZL600 EFI (SN 9915689-->)	600	1999-2003	0,7	BR9EYA	7548	-	BR9EIX	3981
ZL600 EFI ESR	600	2001-2003	0,7	BR9EYA	7548	-	BR9EIX	3981
ZL600 EFI SS	600	2002-2003	0,7	BR9EYA	7548	-	BR9EIX	3981
ZL600 EFI SS ESR	600	2002-2003	0,7	BR9EYA	7548	-	BR9EIX	3981
ZR 600	600	1999-	0,7	BR9EYA	7548	-	BR9EIX	3981
ZR 600	600	2000-2000	0,7	BR9EYA	7548	-	BR9EIX	3981
ZR 600	600	2001-2002	0,7	BR9EYA	7548	-	BR9EIX	3981
ZR 600 2ND RUN	600	1998-	0,7	BR9EYA	7548	-	BR9EIX	3981
ZR 600 Blair Morgan Signature Edition	600	2000-2000	0,7	BR9EYA	7548	-	BR9EIX	3981
ZR 600 CC	600	2002-2002	0,7	BR9EYA	7548	-	BR9EIX	3981
ZR 600 EFI	600	1998-	0,7	BR9EYA	7548	-	BR9EIX	3981
ZR 600 EFI	600	1999-2001	0,7	BR9EYA	7548	-	BR9EIX	3981
ZR 600 EFI LE	600	1998-	0,7	BR9EYA	7548	-	BR9EIX	3981
ZR 600 EFI LE	600	1999-2001	0,7	BR9EYA	7548	-	BR9EIX	3981
ZR 600 EFI LE Reverse	600	2000-2000	0,7	BR9EYA	7548	-	BR9EIX	3981
ZR 600 EFI LE XC	600	1998-	0,7	BR9EYA	7548	-	BR9EIX	3981
ZR 600 January	600	1998-	0,7	BR9EYA	7548	-	BR9EIX	3981
ZR 600 VEV	600	2001-	0,7	BR9EYA	7548	-	BR9EIX	3981
ZR 6000 EL Tigre Sno-Pro LTD	600	2014-	0,7	BPR9ES	7788	-	BPR9EIX	6853
ZR 6000 EL Tigre Sno-Pro ES LTD	600	2014-	0,7	BPR9ES	7788	-	BPR9EIX	6853
ZR 6000 Sno-Pro LTD ES	600	2015-	0,7	BPR9ES	7788	-	BPR9EIX	6853
ZR 6000 Sno-Pro RR	600	2014-	0,7	BPR9ES	7788	-	BPR9EIX	6853
ZR 6000 Sno-Pro RR	600	2015-	0,7	BPR9ES	7788	-	BPR9EIX	6853
ZR 6000 Tucker Hibbert RR	600	2015-	0,7	BPR9ES	7788	-	BPR9EIX	6853
ZRT 600	600	1995-1997	0,7	BR9ES	5722	Q208	BR9EIX	3981
ZRT 600	600	1998-1999	0,7	BR9EYA	7548	-	BR9EIX	3981
ZRT 600	600	2000-2001	0,7	BR9EYA	7548	-	BR9EIX	3981
ZRT 600	600	2002-2002	0,7	BR9EYA	7548	-	BR9EIX	3981
ZRT 600 LE	600	2001-	0,7	BR9EYA	7548	-	BR9EIX	3981
Bearcat Wide Track 660	660	2003-2008	0,8	KR8AI	5477	-	-	-
Bearcat Wide Track WT660 Turbo	660	2006-2008	0,8	KR8AI	5477	-	-	-
Panther 660 Touring (4 Stroke)	660	2006-2008	0,8	KR8AI	5477	-	-	-
Panther 660 Trail (4 Stroke)	660	2006-2007	0,8	KR8AI	5477	-	-	-
T 660 Touring	660	2002-2002	0,8	DCPR7E	3932	-	DCPR7EIX	6046
T 660 Touring	660	2003-2008	0,8	KR8AI	5477	-	-	-
T 660 Turbo ST	660	2005-2006	0,8	KR8AI	5477	-	-	-
T 660 Turbo ST Early Build	660	2005-	0,8	KR8AI	5477	-	-	-
T 660 Turbo Touring	660	2003-2007	0,8	KR8AI	5477	-	-	-
T 660 Turbo Touring LE	660	2006-2007	0,8	KR8AI	5477	-	-	-
T 660 Turbo Trail	660	2003-2007	0,8	KR8AI	5477	-	-	-
T 660 Turbo Trail LE	660	2006-2007	0,8	KR8AI	5477	-	-	-
T 660 Trail	660	2002-2002	0,8	DCPR7E	3932	-	DCPR7EIX	6046
Firecat 700	700	2003-2006	0,7	BR9EYA	7548	-	BR9EIX	3981
Firecat 700 EXT	700	2004-2005	0,7	BR9EYA	7548	-	BR9EIX	3981
Firecat 700 Black Widow	700	2005-	0,7	BR9EYA	7548	-	BR9EIX	3981
Firecat 700 Fighter	700	2004-	0,7	BR9EYA	7548	-	BR9EIX	3981
Firecat 700 Jocker	700	2005-	0,7	BR9EYA	7548	-	BR9EIX	3981
Firecat 700 Nightfire	700	2004-	0,7	BR9EYA	7548	-	BR9EIX	3981

* Bitte Elektrodenabstand nach Angaben des Herstellers justieren

* Please adjust the groundelectrode gap

* Veuillez vérifier L' écartement

* Por favor, ajustar distancia entre electrodos

* regolare il gap



Stock-№

Quick-№



Stock-№ IX

ARCTIC CAT

Firecat 700 Retro	700	2005-	0,7	BR9EYA	7548	-	BR9EIX	3981
Firecat 700 Tiger	700	2004-	0,7	BR9EYA	7548	-	BR9EIX	3981
Firecat 700 Team Arctic	700	2004-2005	0,7	BR9EYA	7548	-	BR9EIX	3981
Firecat 700 Towy Stewart Edition	700	2006-	0,7	BR9EYA	7548	-	BR9EIX	3981
Firecat 700 R	700	2005-2006	0,7	BR9EYA	7548	-	BR9EIX	3981
Firecat 700 Sno-Pro	700	2003-2006	0,7	BR9EYA	7548	-	BR9EIX	3981
Firecat 700 Sno-Pro Black Widow	700	2005-	0,7	BR9EYA	7548	-	BR9EIX	3981
Firecat 700 Sno-Pro Jocker	700	2005-	0,7	BR9EYA	7548	-	BR9EIX	3981
Firecat 700 Sno-Pro Fighter	700	2004-	0,7	BR9EYA	7548	-	BR9EIX	3981
Firecat 700 Sno-Pro Nightfire	700	2004-	0,7	BR9EYA	7548	-	BR9EIX	3981
Firecat 700 Sno-Pro Retro	700	2005-	0,7	BR9EYA	7548	-	BR9EIX	3981
Firecat 700 Sno Pro Team Arctic	700	2004-2005	0,7	BR9EYA	7548	-	BR9EIX	3981
Firecat 700 Sno-Pro Tiger	700	2004-	0,7	BR9EYA	7548	-	BR9EIX	3981
Powder Special 700	700	1999-2000	0,7	BR9EYA	7548	-	BR9EIX	3981
Powder Special 700 LE	700	1999-2000	0,7	BR9EYA	7548	-	BR9EIX	3981
Sabercat 700	700	2004-2005	0,7	BR9EYA	7548	-	BR9EIX	3981
Sabercat 700 EXT	700	2004-2006	0,7	BR9EYA	7548	-	BR9EIX	3981
Sabercat 700 LX	700	2004-2006	0,7	BR9EYA	7548	-	BR9EIX	3981
Wildcat 700	700	1991-1996	0,7	BR9ES	5722	Q208	BR9EIX	3981
Wildcat 700 MC Deep Lug	700	1995-	0,7	BR9ES	5722	Q208	BR9EIX	3981
Wildcat 700 Mountain Cat	700	1991-1996	0,7	BR9ES	5722	Q208	BR9EIX	3981
Wildcat 700 Touring	700	1995-1996	0,7	BR9ES	5722	Q208	BR9EIX	3981
CrossFire 700	700	2006-	0,7	BR9EYA	7548	-	BR9EIX	3981
CrossFire 700 West Yellowstone	700	2006-	0,7	BR9EYA	7548	-	BR9EIX	3981
CrossFire 700 Early Build	700	2006-	0,7	BR9EYA	7548	-	BR9EIX	3981
CrossFire 700 Sno-Pro	700	2006-	0,7	BR9EYA	7548	-	BR9EIX	3981
M7	700	2005-2006	0,7	BR9EYA	7548	-	BR9EIX	3981
M7 CT	700	2006-	0,7	BR9EYA	7548	-	BR9EIX	3981
M7 West Yellowstone	700	2006-	0,7	BR9EYA	7548	-	BR9EIX	3981
M7 LE	700	2005-2006	0,7	BR9EYA	7548	-	BR9EIX	3981
M7 LE CT	700	2006-	0,7	BR9EYA	7548	-	BR9EIX	3981
ZL 700	700	2000-2000	0,7	BR9EYA	7548	-	BR9EIX	3981
ZR 700	700	1994-1995	0,7	BR9ES	5722	Q208	BR9EIX	3981
ZR 700	700	1999-2000	0,7	BR9EYA	7548	-	BR9EIX	3981
ZR 700 LE	700	2000-2000	0,7	BR9EYA	7548	-	BR9EIX	3981
ZR 700 LE Reverse	700	2000-2000	0,7	BR9EYA	7548	-	BR9EIX	3981
Mountain Cat 800	800	2001-2004	0,7	BR9EYA	7548	-	BR9EIX	3981
Mountain Cat 800 LE	800	2001-2002	0,7	BR9EYA	7548	-	BR9EIX	3981
Pantera 800	800	1998-1999	0,7	BR9EYA	7548	-	BR9EIX	3981
Pantera 800	800	2003-2005	0,7	BR9EYA	7548	-	BR9EIX	3981
Pantera 800 ESR	800	2002-2002	0,7	BR9EYA	7548	-	BR9EIX	3981
CrossFire EFI 8 (Twin Spark)	800	2007-2011	0,7	BR9EYA	7548	-	BR9EIX	3981
CrossFire 8 EFI Sno-Pro (Twin Spark)	800	2007-2011	0,7	BR9EYA	7548	-	BR9EIX	3981
CrossFire 8 EFI Sno-Pro LE (Twin Spark)	800	2009-2009	0,7	BR9EYA	7548	-	BR9EIX	3981
CrossFire 8 EFI Sno-Pro LTD (Twin Spark)	800	2011-	0,7	BR9EYA	7548	-	BR9EIX	3981
CrossFireR 8 (Twin Spark)	800	2009-2011	0,7	BR9EYA	7548	-	BR9EIX	3981
CrossFireR 8 LE (Twin Spark)	800	2009-2009	0,7	BR9EYA	7548	-	BR9EIX	3981
F 8 EFI (Twin Spark)	800	2008-2010	0,7	BR9EYA	7548	-	BR9EIX	3981
F 8 LE (Twin Spark)	800	2009-2009	0,7	BR9EYA	7548	-	BR9EIX	3981
F 8 LXR (Twin Spark)	800	2008-2011	0,7	BR9EYA	7548	-	BR9EIX	3981
F 8 EFI Sno-Pro (Twin Spark)	800	2007-2010	0,7	BR9EYA	7548	-	BR9EIX	3981
F 8 Sno-Pro LXR LTD (Twin Spark)	800	2011-	0,7	BR9EYA	7548	-	BR9EIX	3981

* Bitte Elektrodenabstand nach Angaben des Herstellers justieren

* Please adjust the groundelectrode gap

* Veuillez vérifier l' écartement

* Por favor, ajustar distancia entre electrodos

* regolare il gap



Stock-No

Quick-No



Stock-No IX

ARCTIC CAT

F 8 Sno-Pro Tony Stewart Edition (Twin Spark)	800	2007-	0,7	BR9EYA	7548	-	BR9EIX	3981
F 8 EXT (Twin Spark)	800	2011-	0,7	BR9EYA	7548	-	BR9EIX	3981
F 800 LXR (Twin Spark)	800	2012-2013	0,7	BR9EYA	7548	-	BR9EIX	3981
F 800 SnoPro (Twin Spark)	800	2012-2013	0,7	BR9EYA	7548	-	BR9EIX	3981
F 800 SnoPro 50th Anniversary (Twin Spark)	800	2012-	0,7	BR9EYA	7548	-	BR9EIX	3981
F 800 SnoPro RR (Twin Spark)	800	2013-	0,7	BR9EYA	7548	-	BR9EIX	3981
F 800 SnoPro LTD (Twin Spark)	800	2012-2013	0,7	BR9EYA	7548	-	BR9EIX	3981
F 800 Tucker Hibbert Race Replica (Twin Spark)	800	2013-	0,7	BR9EYA	7548	-	BR9EIX	3981
M 8 (Twin Spark)	800	2007-2011	0,7	BR9EYA	7548	-	BR9EIX	3981
M 8 Sno-Pro (Twin Spark)	800	2007-2011	0,7	BR9EYA	7548	-	BR9EIX	3981
M 8 Sno-Pro LE (Twin Spark)	800	2009-2009	0,7	BR9EYA	7548	-	BR9EIX	3981
M 8 Sno-Pro LTD (Twin Spark)	800	2011-	0,7	BR9EYA	7548	-	BR9EIX	3981
M 8 HCR (Twin Spark)	800	2009-2011	0,7	BR9EYA	7548	-	BR9EIX	3981
M 800 (Twin Spark)	800	2012-2013	0,7	BR9EYA	7548	-	BR9EIX	3981
M 800 Sno-Pro (Twin Spark)	800	2012-2013	0,7	BR9EYA	7548	-	BR9EIX	3981
M 800 Sno-Pro Anniversay (Twin Spark)	800	2012-	0,7	BR9EYA	7548	-	BR9EIX	3981
M 800 Sno-Pro LTD (Twin Spark)	800	2012-2013	0,7	BR9EYA	7548	-	BR9EIX	3981
M 800 HCR (Twin Spark)	800	2012-2013	0,7	BR9EYA	7548	-	BR9EIX	3981
M 8000 (Twin Spark)	800	2014-	0,7	BR9EYA	7548	-	BR9EIX	3981
M 8000 Sno-Pro (Twin Spark)	800	2014-	0,7	BR9EYA	7548	-	BR9EIX	3981
M 8000 Sno-Pro LTD (Twin Spark)	800	2014-	0,7	BR9EYA	7548	-	BR9EIX	3981
M 8000 Sno-Pro LTD ES (Twin Spark)	800	2014-	0,7	BR9EYA	7548	-	BR9EIX	3981
M 8000 HCR (Twin Spark)	800	2014-	0,7	BR9EYA	7548	-	BR9EIX	3981
XF 800 LXR (Twin Spark)	800	2012-2013	0,7	BR9EYA	7548	-	BR9EIX	3981
XF 800 Sno-Pro (Twin Spark)	800	2012-2013	0,7	BR9EYA	7548	-	BR9EIX	3981
XF 800 Sno-Pro 50th Anniversary (Twin Spark)	800	2012-	0,7	BR9EYA	7548	-	BR9EIX	3981
XF 800 Sno-Pro High Country (Twin Spark)	800	2012-2013	0,7	BR9EYA	7548	-	BR9EIX	3981
XF 800 Sno-Pro High Country LTD (Twin Spark)	800	2013-	0,7	BR9EYA	7548	-	BR9EIX	3981
XF 800 Sno-Pro LTD (Twin Spark)	800	2012-2013	0,7	BR9EYA	7548	-	BR9EIX	3981
XF 800 CrossTour (Twin Spark)	800	2013-	0,7	BR9EYA	7548	-	BR9EIX	3981
XF 8000 LXR (Twin Spark)	800	2014-	0,7	BR9EYA	7548	-	BR9EIX	3981
XF 8000 LXR (Twin Spark)	800	2015-	0,7	BR9EYA	7548	-	BR9EIX	3981
XF 8000 Sno-Pro (Twin Spark)	800	2014-	0,7	BR9EYA	7548	-	BR9EIX	3981
XF 8000 Sno-Pro (Twin Spark)	800	2015-	0,7	BR9EYA	7548	-	BR9EIX	3981
XF 8000 Sno-Pro LTD (Twin Spark)	800	2014-	0,7	BR9EYA	7548	-	BR9EIX	3981
XF 8000 Sno-Pro LTD (Twin Spark)	800	2015-	0,7	BR9EYA	7548	-	BR9EIX	3981
XF 8000 Cross Country LTD (Twin Spark)	800	2015-	0,7	BR9EYA	7548	-	BR9EIX	3981
XF 8000 Cross Country Sno-Pro (Twin Spark)	800	2014-	0,7	BR9EYA	7548	-	BR9EIX	3981
XF 8000 Cross Country Sno-Pro (Twin Spark)	800	2015-	0,7	BR9EYA	7548	-	BR9EIX	3981
XF 8000 High Country LTD (Twin Spark)	800	2015-	0,7	BR9EYA	7548	-	BR9EIX	3981
XF 8000 High Country Sno-Pro (Twin Spark)	800	2014-	0,7	BR9EYA	7548	-	BR9EIX	3981
XF 8000 High Country Sno-Pro (Twin Spark)	800	2015-	0,7	BR9EYA	7548	-	BR9EIX	3981
XF 8000 High Country Sno-Pro LTD ES (Twin Spark)	800	2014-	0,7	BR9EYA	7548	-	BR9EIX	3981
XF 8000 CrossTour (Twin Spark)	800	2014-	0,7	BR9EYA	7548	-	BR9EIX	3981
XF 8000 CrossTour (Twin Spark)	800	2015-	0,7	BR9EYA	7548	-	BR9EIX	3981
ZL 800 ESR	800	2001-2003	0,7	BR9EYA	7548	-	BR9EIX	3981
ZL 800 ESR Illusion	800	2001-	0,7	BR9EYA	7548	-	BR9EIX	3981
ZL 800 SS	800	2002-2003	0,7	BR9EYA	7548	-	BR9EIX	3981
ZR 800	800	2001-2003	0,7	BR9EYA	7548	-	BR9EIX	3981
ZR 800 CC	800	2002-2002	0,7	BR9EYA	7548	-	BR9EIX	3981
ZR 800 LE	800	2001-	0,7	BR9EYA	7548	-	BR9EIX	3981
ZR 800 Sno-Pro	800	2003-	0,7	BR9EYA	7548	-	BR9EIX	3981

* Bitte Elektrodenabstand nach Angaben des Herstellers justieren

* Please adjust the groundelectrode gap

* Veuillez vérifier L' écartement

* Por favor, ajustar distancia entre electrodos

* regolare il gap



Stock-No

Quick-No



Stock-No IX

ARCTIC CAT

ZR 8000 LXR (Twin Spark)	800	2014-	0,7	BR9EYA	7548	-	BR9EIX	3981
ZR 8000 LXR (Twin Spark)	800	2015-	0,7	BR9EYA	7548	-	BR9EIX	3981
ZR 8000 Sno-Pro (Twin Spark)	800	2014-	0,7	BR9EYA	7548	-	BR9EIX	3981
ZR 8000 Sno-Pro (Twin Spark)	800	2015-	0,7	BR9EYA	7548	-	BR9EIX	3981
ZR 8000 Sno-Pro LTD (Twin Spark)	800	2015-	0,7	BR9EYA	7548	-	BR9EIX	3981
ZR 8000 Sno-Pro LTD ES (Twin Spark)	800	2014-	0,7	BR9EYA	7548	-	BR9EIX	3981
ZR 8000 Sno-Pro LTD ES (Twin Spark)	800	2015-	0,7	BR9EYA	7548	-	BR9EIX	3981
ZR 8000 Sno-Pro RR (Twin Spark)	800	2014-	0,7	BR9EYA	7548	-	BR9EIX	3981
ZR 8000 Sno-Pro RR (Twin Spark)	800	2015-	0,7	BR9EYA	7548	-	BR9EIX	3981
ZR 8000 Sno-Pro LTD RR NE OS (Twin Spark)	800	2014-	0,7	BR9EYA	7548	-	BR9EIX	3981
ZRT 800	800	1995-1997	0,7	BR9ES	5722	Q208	BR9EIX	3981
ZRT 800	800	1998-1999	0,7	BR9EYA	7548	-	BR9EIX	3981
ZRT 800	800	2000-2001	0,7	BR9EYA	7548	-	BR9EIX	3981
ZRT 800 LE	800	2001-	0,7	BR9EYA	7548	-	BR9EIX	3981
King Cat 900	900	2004-2006	0,7	BR9EYA	7548	-	BR9EIX	3981
King Cat 900 Early Build	900	2005-	0,7	BR9EYA	7548	-	BR9EIX	3981
Mountain Cat 900	900	2003-2004	0,7	BR9EYA	7548	-	BR9EIX	3981
Mountain Cat 900 1M	900	2003-	0,7	BR9EYA	7548	-	BR9EIX	3981
Mountain Cat 900 Early Build	900	2003-	0,7	BR9EYA	7548	-	BR9EIX	3981
Thundercat 900	900	1993-	0,7	BR9ES	5722	Q208	BR9EIX	3981
Thundercat 900	900	1994-1997	0,7	BR9ES	5722	Q208	BR9EIX	3981
Thundercat 900 MC	900	1997-	0,7	BR9ES	5722	Q208	BR9EIX	3981
Thundercat 900 MC Deep Lug	900	1995-	0,7	BR9ES	5722	Q208	BR9EIX	3981
Thundercat 900 Mountain Cat	900	1994-1996	0,7	BR9ES	5722	Q208	BR9EIX	3981
Thundercat 900 Mountain Cat W	900	1994-	0,7	BR9ES	5722	Q208	BR9EIX	3981
ZR 900	900	2003-2006	0,7	BR9EYA	7548	-	BR9EIX	3981
ZR 900 Early Build	900	2003-	0,7	BR9EYA	7548	-	BR9EIX	3981
ZR 900 Sno-Pro	900	2003-2006	0,7	BR9EYA	7548	-	BR9EIX	3981
Bearcat Z1 XT	1000	2009-2014	0,9	MR8AI9	7692	-	-	-
Bearcat Z1 XT LTD	1000	2011-2014	0,9	MR8AI9	7692	-	-	-
Bearcat Z1 XT GS	1000	2012-2014	0,9	MR8AI9	7692	-	-	-
Mountain Cat 1000	1000	2001-	0,7	BR9EYA	7548	-	BR9EIX	3981
Mountain Cat 1000	1000	2002-2002	0,7	BR9EYA	7548	-	BR9EIX	3981
Pantera 1000	1000	2000-2001	0,7	BR9EYA	7548	-	BR9EIX	3981
Thundercat 1000	1000	1998-1999	0,7	BR9EYA	7548	-	BR9EIX	3981
Thundercat 1000	1000	2000-2001	0,7	BR9EYA	7548	-	BR9EIX	3981
Thundercat 1000	1000	2002-2002	0,7	BR9EYA	7548	-	BR9EIX	3981
Thundercat 1000 MC	1000	1998-1999	0,7	BR9EYA	7548	-	BR9EIX	3981
Thundercat 1000 MC	1000	2000-2000	0,7	BR9EYA	7548	-	BR9EIX	3981
Thundercat 1000 THC	1000	2000-2000	0,7	BR9EYA	7548	-	BR9EIX	3981
CrossFire 1000 EFI (Twin Spark)	1000	2007-2009	0,7	BR9EYA	7548	-	BR9EIX	3981
CrossFire 1000 EFI Sno-Pro (Twin Spark)	1000	2007-2009	0,7	BR9EYA	7548	-	BR9EIX	3981
CrossFire 1000 EFI Sno-Pro Nitefire (Twin Spark)	1000	2009-2009	0,7	BR9EYA	7548	-	BR9EIX	3981
CrossFireR 1000 (Twin Spark)	1000	2009-2011	0,7	BR9EYA	7548	-	BR9EIX	3981
CrossFireR 1000 LE (Twin Spark)	1000	2009-2009	0,7	BR9EYA	7548	-	BR9EIX	3981
F1000 EFI (Twin Spark)	1000	2007-2008	0,7	BR9EYA	7548	-	BR9EIX	3981
F1000 EFI LXR (Twin Spark)	1000	2007-2008	0,7	BR9EYA	7548	-	BR9EIX	3981
F1000 EFI Sno-Pro (Twin Spark)	1000	2007-2009	0,7	BR9EYA	7548	-	BR9EIX	3981
M1000 (Twin Spark)	1000	2007-2009	0,7	BR9EYA	7548	-	BR9EIX	3981
M1000 Sno-Pro (Twin Spark)	1000	2007-2011	0,7	BR9EYA	7548	-	BR9EIX	3981
M1000 Sno-Pro LE (Twin Spark)	1000	2009-2009	0,7	BR9EYA	7548	-	BR9EIX	3981
XF7000 LXR	1050	2014-	0,8	CR9E	6263	Q227	CR9EIX	3521

* Bitte Elektrodenabstand nach Angaben des Herstellers justieren

* Please adjust the groundelectrode gap

* Veuillez vérifier l' écartement

* Por favor, ajustar distancia entre electrodos

* regolare il gap



Stock-No

Quick-No



Stock-No IX

ARCTIC CAT

XF7000 Sno-Pro	1050	2014-	0,8	CR9E	6263	Q227	CR9EIX	3521
XF7000 Sno-Pro LTD	1050	2014-	0,8	CR9E	6263	Q227	CR9EIX	3521
XF7000 Sno-Pro Cross Country	1050	2014-	0,8	CR9E	6263	Q227	CR9EIX	3521
XF7000 CrossTour	1050	2014-	0,8	CR9E	6263	Q227	CR9EIX	3521
XF7000 CrossTour Sno-Pro	1050	2014-	0,8	CR9E	6263	Q227	CR9EIX	3521
ZR7000 LXR	1050	2014-	0,8	CR9E	6263	Q227	CR9EIX	3521
ZR7000 LXR	1050	2015-	0,8	CR9E	6263	Q227	CR9EIX	3521
ZR7000 Sno-Pro	1050	2014-	0,8	CR9E	6263	Q227	CR9EIX	3521
ZR7000 Sno-Pro	1050	2015-	0,8	CR9E	6263	Q227	CR9EIX	3521
ZR7000 Sno-Pro LTD	1050	2015-	0,8	CR9E	6263	Q227	CR9EIX	3521
ZR7000 Sno-Pro LTD El Tigre	1050	2015-	0,8	CR9E	6263	Q227	CR9EIX	3521
ZR7000 Sno-Pro RR	1050	2015-	0,8	CR9E	6263	Q227	CR9EIX	3521
ZR7000 Sno-Pro RR Early Build	1050	2015-	0,8	CR9E	6263	Q227	CR9EIX	3521
F1100 LXR	1100	2012-2013	0,9	MR8A19	7692	-	-	-
F1100 Turbo LXR	1100	2012-2013	0,9	MR8A19	7692	-	-	-
F1100 SnoPro	1100	2012-2013	0,9	MR8A19	7692	-	-	-
F1100 SnoPro 50 Anniversary	1100	2012-	0,9	MR8A19	7692	-	-	-
F1100 SnoPro LTD	1100	2012-2013	0,9	MR8A19	7692	-	-	-
F1100 Turbo SnoPro	1100	2012-2013	0,9	MR8A19	7692	-	-	-
F1100 Turbo SnoPro 50 Anniversary	1100	2012-	0,9	MR8A19	7692	-	-	-
F1100 Turbo SnoPro LTD	1100	2012-2013	0,9	MR8A19	7692	-	-	-
F1100 Turbo SnoPro RR	1100	2013-	0,9	MR8A19	7692	-	-	-
M1100	1100	2012-2013	0,9	MR8A19	7692	-	-	-
M1100 Turbo	1100	2012-2013	0,9	MR8A19	7692	-	-	-
M1100 Sno-Pro	1100	2012-2013	0,9	MR8A19	7692	-	-	-
M1100 Sno-Pro 50th Anniversary	1100	2012-	0,9	MR8A19	7692	-	-	-
M1100 Sno-Pro LTD	1100	2012-2013	0,9	MR8A19	7692	-	-	-
M1100 Turbo Sno-Pro	1100	2012-2013	0,9	MR8A19	7692	-	-	-
M1100 Turbo Sno-Pro 50th Anniversary	1100	2012-	0,9	MR8A19	7692	-	-	-
M1100 Turbo Sno-Pro LTD	1100	2012-2013	0,9	MR8A19	7692	-	-	-
M1100 Turbo High Country	1100	2012-2013	0,9	MR8A19	7692	-	-	-
M9000 Turbo	1100	2014-	0,9	MR8A19	7692	-	-	-
M9000 Sno-Pro Turbo	1100	2014-	0,9	MR8A19	7692	-	-	-
M9000 Sno-Pro LTD Turbo	1100	2014-	0,9	MR8A19	7692	-	-	-
M9000 HCR Turbo	1100	2014-	0,9	MR8A19	7692	-	-	-
TZ1 Park Version	1100	2009-2009	0,9	MR8A19	7692	-	-	-
TZ1 Touring	1100	2008-2014	0,9	MR8A19	7692	-	-	-
TZ1 Touring LXR	1100	2008-2014	0,9	MR8A19	7692	-	-	-
TZ1 Turbo LXR	1100	2009-2014	0,9	MR8A19	7692	-	-	-
TZ1 Turbo LXR LE	1100	2009-2010	0,9	MR8A19	7692	-	-	-
XF1100 LXR	1100	2012-2013	0,9	MR8A19	7692	-	-	-
XF1100 SnoPro	1100	2012-2013	0,9	MR8A19	7692	-	-	-
XF1100 SnoPro LTD	1100	2012-2013	0,9	MR8A19	7692	-	-	-
XF1100 SnoPro 50th Anniversary	1100	2012-	0,9	MR8A19	7692	-	-	-
XF1100 Turbo LXR	1100	2012-2013	0,9	MR8A19	7692	-	-	-
XF1100 Turbo SnoPro	1100	2012-2013	0,9	MR8A19	7692	-	-	-
XF1100 Turbo Sno-Pro 50th Anniversary	1100	2012-	0,9	MR8A19	7692	-	-	-
XF1100 Turbo SnoPro LTD	1100	2012-2013	0,9	MR8A19	7692	-	-	-
XF1100 Turbo SnoPro HiCountry	1100	2012-2013	0,9	MR8A19	7692	-	-	-
XF1100 Turbo SnoPro HiCountry LTD	1100	2013-	0,9	MR8A19	7692	-	-	-
XF1100 CrossTour	1100	2013-	0,9	MR8A19	7692	-	-	-
XF1100 Turbo CrossTour	1100	2013-	0,9	MR8A19	7692	-	-	-

* Bitte Elektrodenabstand nach Angaben des Herstellers justieren

* Please adjust the groundelectrode gap

* Veuillez vérifier l' écartement

* Por favor, ajustar distancia entre electrodos

* regolare il gap



Stock-№

Quick-№



Stock-№ IX

ARCTIC CAT

XF 9000 LXR	1100	2014-	0,9	MR8AI9	7692	-	-	-
XF 9000 Sno-Pro	1100	2014-	0,9	MR8AI9	7692	-	-	-
XF 9000 Sno-Pro LTD	1100	2014-	0,9	MR8AI9	7692	-	-	-
XF 9000 Sno-Pro LTD 137 Early Build	1100	2015-	0,9	MR8AI9	7692	-	-	-
XF 9000 Sno-Pro Cross Country	1100	2014-	0,9	MR8AI9	7692	-	-	-
XF 9000 High Country Sno-Pro	1100	2014-	0,9	MR8AI9	7692	-	-	-
XF 9000 High Country Sno-Pro LTD	1100	2014-	0,9	MR8AI9	7692	-	-	-
XF 9000 CrossTour	1100	2014-	0,9	MR8AI9	7692	-	-	-
Jaguar Z1 (Eng. Suzuki - 4 Stroke)	1100	2007-2008	0,9	MR8AI9	7692	-	-	-
Jaguar Z1 Early Build	1100	2007-	0,9	MR8AI9	7692	-	-	-
Jaguar Z1 Sno-Pro & Nitefire Sno-Pro (Eng. Suzuki - 4 Stroke)	1100	2008-	0,9	MR8AI9	7692	-	-	-
Z1 EFI	1100	2009-2010	0,9	MR8AI9	7692	-	-	-
Z1 EFI LXR	1100	2010-2011	0,9	MR8AI9	7692	-	-	-
Z1 Sno-Pro	1100	2011-	0,9	MR8AI9	7692	-	-	-
Z1 Turbo	1100	2009-2010	0,9	MR8AI9	7692	-	-	-
Z1 Turbo LE	1100	2009-2009	0,9	MR8AI9	7692	-	-	-
Z1 Turbo LXR	1100	2009-2011	0,9	MR8AI9	7692	-	-	-
Z1 Turbo Sno-Pro	1100	2009-2011	0,9	MR8AI9	7692	-	-	-
Z1 Turbo Sno-Pro LE	1100	2010-	0,9	MR8AI9	7692	-	-	-
Z1 Turbo Sno-Pro LTD	1100	2011-	0,9	MR8AI9	7692	-	-	-
Z1 Turbo EXT	1100	2010-2011	0,9	MR8AI9	7692	-	-	-
Z1 Turbo EXT LE	1100	2010-	0,9	MR8AI9	7692	-	-	-
Z1 Turbo EXT Sno-Pro	1100	2010-	0,9	MR8AI9	7692	-	-	-
ZR 5000 LXR (4 Stroke)	1100	2014-	0,9	MR8AI9	7692	-	-	-
ZR 5000 LXR Early build	1100	2015-	0,9	MR8AI9	7692	-	-	-
ZR 9000 EL Tigre early Build	1100	2015-	0,9	MR8AI9	7692	-	-	-
ZR 9000 Turbo LXR	1100	2014-	0,9	MR8AI9	7692	-	-	-
ZR 9000 Sno-Pro Turbo	1100	2014-	0,9	MR8AI9	7692	-	-	-
ZR 9000 Sno-Pro LTD Turbo	1100	2014-	0,9	MR8AI9	7692	-	-	-
ZR 9000 Sno-Pro RR Turbo	1100	2014-	0,9	MR8AI9	7692	-	-	-

BOLENS

292, 295, R295	292	-	0,6	B8HS	5510	Q205	BR8HIX	7001
315	310	-	0,6	B8HS	5510	Q205	BR8HIX	7001
340, R340	336	-	0,6	B8HS	5510	Q205	BR8HIX	7001
399, R399	396	-	0,6	B8HS	5510	Q205	BR8HIX	7001
440, R440	438	-	0,6	B8HS	5510	Q205	BR8HIX	7001

BOMBARDIER ROTAX & BSE ENG

250(10-12HP)	250	-	0,5	AB-6	2910	-	-	-
250(14HP)	250	-	0,5	AB-7	3010	-	-	-
250E	250	-	0,5	AB-7	3010	-	-	-
250SS	250	-	0,5	B8HS	5510	Q205	BR8HIX	7001
Deluxe, T	250	-	0,5	B7HS	5110	Q204	BR7HIX	7067
M	250	-	0,6	B7HS	5110	Q204	BR7HIX	7067
TNT, RV250	250	-	0,5	B8ES	2411	Q201	BR8EIX	5044
Safari Citation/E	250	-	0,5	BR9ES	5722	Q208	BR9EIX	3981
Elan, Spirit	250	-	0,5	AB-7	3010	-	-	-
Citation L/S	250	-	0,5	BR9ES	5722	Q208	BR9EIX	3981
Citation L/S Elec.	250	-	0,5	BR9ES	5722	Q208	BR9EIX	3981
Tunda, -LT	250	-	0,5	BR9ES	5722	Q208	BR9EIX	3981

* Bitte Elektrodenabstand nach Angaben des Herstellers justieren

* Please adjust the groundelectrode gap

* Veuillez vérifier l' écartement

* Por favor, ajustar distancia entre electrodos

* regolare il gap



Stock-No

Quick-No



Stock-No IX

BOMBARDIER ROTAX & BSE ENG

Citation 3500	270	-	0,5	B8ES	2411	Q201	BR8EIX	5044
TNT294, TNT300SM	290	-	0,5	B8HS	5510	Q205	BR8HIX	7001
300 Citation	290	-	0,5	B8HS	5510	Q205	BR8HIX	7001
300SS, 300E, 300 Olym.	290	-	0,5	B8HS	5510	Q205	BR8HIX	7001
300	300	-	0,6	B8HS	5510	Q205	BR8HIX	7001
300(12.0HP)	300	-	0,5	AB-6	2910	-	-	-
300(15.0, 16.0HP)	300	-	0,5	AB-7	3010	-	-	-
300S	300	-	0,5	AB-7	3010	-	-	-
320E	320	-	0,5	AB-7	3010	-	-	-
320SS	320	-	0,5	AB-8	7909	-	-	-
420	320	-	0,5	AB-7	3010	-	-	-
335, 335E	340	-	0,5	AB-7	3010	-	-	-
340T, 340SS 12.7mm(1/2") Reach	340	-	0,6	B7HS	5110	Q204	BR7HIX	7067
340T, 340SS 19.0mm(3/4") Reach	340	-	0,6	B8ES	2411	Q201	BR8EIX	5044
TNT, RV340, Sonic 340	340	-	*	BR10EIX	6801	-	-	-
TNT340, TNT340SE	340	-	0,5	B8HS	5510	Q205	BR8HIX	7001
340, 340E	340	-	0,5	B8HS	5510	Q205	BR8HIX	7001
340, 340E Olym.Ever	340	-	0,5	B9HS	5810	-	-	-
340SS	340	-	0,5	AB-8	7909	-	-	-
354 Blizzard 6500	340	-	*	BR10EIX	6801	-	-	-
354 Blizzard 7500, -Plus	340	-	*	BR10EIX	6801	-	-	-
354 Super Sonic/LC	340	-	*	BR10EIX	6801	-	-	-
Nuvik(339cc) 1979	340	-	0,5	B9HS	5810	-	-	-
TNT340 Free Air	340	-	0,5	B9ES	2611	Q202	BR9EIX	3981
TNT340SM	340	-	0,5	B8HS	5510	Q205	BR8HIX	7001
340	340	-	0,6	B8ES	2411	Q201	BR8EIX	5044
370	370	-	0,5	B7HS	5110	Q204	BR7HIX	7067
377 Citation 300	370	-	0,5	BR8ES	5422	Q207	BR8EIX	5044
377 Safari Scout/E	370	-	0,5	BR9ES	5722	Q208	BR9EIX	3981
377 Skandic	370	-	0,5	BR8ES	5422	Q207	BR8EIX	5044
377 Formula S	380	-	0,5	BR9ES	5722	Q208	BR9EIX	3981
377 Mirage III	380	-	0,5	BR9ES	5722	Q208	BR9EIX	3981
377 Safari, -E	380	-	0,5	BR9ES	5722	Q208	BR9EIX	3981
377 Skandic	380	-	0,5	BR8ES	5422	Q207	BR8EIX	5044
380 Scandic 380	380	-	0,4	BR9ES	5722	Q208	BR9EIX	3981
Legend Fan 380F	380	-	0,5	BR9ES	5722	Q208	BR9EIX	3981
Legend GT 380F	380	-	0,5	BR9ES	5722	Q208	BR9EIX	3981
MX Z Fan	380	-	0,5	BR9ES	5722	Q208	BR9EIX	3981
399	400	-	0,5	B8HS	5510	Q205	BR8HIX	7001
400, 400E Futura	400	-	0,5	B8HS	5510	Q205	BR8HIX	7001
TNT400 Free Air	400	-	0,5	B10ES	7928	-	BR10EIX	6801
440T, 440SS 12.7mm(1/2") Reach	440	-	0,6	B7HS	5110	Q204	BR7HIX	7067
440T, 440SS 19.0mm(3/4") Reach	440	-	0,6	B8ES	2411	Q201	BR8EIX	5044
440 MX-Z 440/F	440	-	0,4	BR9ES	5722	Q208	BR9EIX	3981
444 Elite	440	-	0,5	B8ES	2411	Q201	BR8EIX	5044
444LC Everest, Futura	440	-	0,5	B8ES	2411	Q201	BR8EIX	5044
440, 440E	440	-	0,5	AB-8	7909	-	-	-
440ER, 440R	440	-	0,5	AB-7	3010	-	-	-
447 Grand Luxe	440	-	0,5	BR8ES	5422	Q207	BR8EIX	5044
447 Nordic 50	440	-	0,5	BR9ES	5722	Q208	BR9EIX	3981
447 Safari 447	440	-	0,5	BR8ES	5422	Q207	BR8EIX	5044

* Bitte Elektrodenabstand nach Angaben des Herstellers justieren

* Please adjust the groundelectrode gap

* Veuillez vérifier L' écartement

* Por favor, ajustar distancia entre electrodos

* regolare il gap



Stock-No

Quick-No



Stock-No IX

BOMBARDIER ROTAX & BSE ENG

454 Blizzard 9500/Plus	440	-	*	BR10EIX	6801	-	-	-
Olympique Plus	440	-	0,5	AB-7	3010	-	-	-
TNT440	440	-	0,5	AB-8	7909	-	-	-
TNT440 Free Air 14mm Head	440	-	0,5	B9ES	2611	Q202	BR9EIX	3981
TNT440 Free Air 18mm Head	440	-	0,5	AB-7	3010	-	-	-
TNT440SE	440	-	0,5	AB-8	7909	-	-	-
TNT440SM	440	-	0,5	AB-8	7909	-	-	-
440 Touring LE	440	-	0,4	BR9ES	5722	Q208	BR9EIX	3981
MX Zx Racing 440	440	-	0,5	BR9ECS	3570	-	-	-
Skandic LT 440F	440	-	0,5	BR9ES	5722	Q208	BR9EIX	3981
Skandic LT(E) 440F	440	-	0,5	BR9ES	5722	Q208	BR9EIX	3981
443 Touring LE	440	-	0,5	BR9ES	5722	Q208	BR9EIX	3981
447-447 Safari	450	-	0,5	BR9ES	5722	Q208	BR9EIX	3981
454 Ultra Sonic	460	-	*	BR10EIX	6801	-	-	-
462 SS25, SP, SS	460	-	0,5	BR8ES	5422	Q207	BR8EIX	5044
464 Elite	460	-	0,5	B8ES	2411	Q201	BR8EIX	5044
494 Skandic WT LC	500	-	0,5	BR8ES	5422	Q207	BR8EIX	5044
494 Summit 500	500	-	0,5	BR9ES	5722	Q208	BR9EIX	3981
467 Formula MX/LT	500	-	0,5	BR9ES	5722	Q208	BR9EIX	3981
503 Alpine II	500	-	0,5	BR8ES	5422	Q207	BR8EIX	5044
503 Escapade	500	-	0,5	BR9ES	5722	Q208	BR9EIX	3981
503 Nordic 60	500	-	0,5	BR9ES	5722	Q208	BR9EIX	3981
503 Safari 503R	500	-	0,5	BR9ES	5722	Q208	BR9EIX	3981
503 Alpine	500	-	0,5	BR7ES	5122	-	-	-
503 Safari Escapade	500	-	0,5	BR9ES	5722	Q208	BR9EIX	3981
503 Safari Voyageur	500	-	0,5	BR9ES	5722	Q208	BR9EIX	3981
503 Sonic MX	500	-	0,5	BR7ES	5122	-	-	-
500 Scandic 500	500	-	0,4	BR9ES	5722	Q208	BR9EIX	3981
GSX Sport 1+1 500 SS	500	-	0,5	BR9ECS	3570	-	-	-
GSX Sport 500 SS	500	-	0,5	BR9ECS	3570	-	-	-
Legend Sport 500 SS	500	-	0,5	BR9ECS	3570	-	-	-
Legend Sport GT 500 SS	500	-	0,5	BR9ECS	3570	-	-	-
MX Z Adrenaline 500 SS	500	-	0,5	BR9ECS	3570	-	-	-
MX Z Adrenaline 500 SS (E)	500	-	0,5	BR9ECS	3570	-	-	-
MX Z Trail 500 SS	500	-	0,5	BR9ECS	3570	-	-	-
MX Z Trail 500 SS (E)	500	-	0,5	BR9ECS	3570	-	-	-
503 Formula SL	500	-	0,5	BR9ES	5722	Q208	BR9EIX	3981
503 Skandic SWT	500	-	0,5	BR8ES	5422	Q207	BR8EIX	5044
503 Skandic WT503R	500	-	0,5	BR9ES	5722	Q208	BR9EIX	3981
503 Summit 500	500	-	0,5	BR9ES	5722	Q208	BR9EIX	3981
503 Touring SLE	500	-	0,5	BR9ES	5722	Q208	BR9EIX	3981
534 Blizzasd 9700	520	-	0,5	BR8ES	5422	Q207	BR8EIX	5044
537 Formula Plus	540	-	0,5	BR9ES	5722	Q208	BR9EIX	3981
Legend Fan 550F	550	-	0,5	BR9ES	5722	Q208	BR9EIX	3981
Legend GT 550F	550	-	0,5	BR9ES	5722	Q208	BR9EIX	3981
MX Z Fan 550F	550	-	0,5	BR9ES	5722	Q208	BR9EIX	3981
Skandic Sport 550F	550	-	0,5	BR9ES	5722	Q208	BR9EIX	3981
Skandic SUV 550F	550	-	0,5	BR9ES	5722	Q208	BR9EIX	3981
Skandic SWT 550F	550	-	0,5	BR9ES	5722	Q208	BR9EIX	3981
Skandic WT 550F	550	-	0,5	BR9ES	5722	Q208	BR9EIX	3981
Summit Fan 550F	550	-	0,5	BR9ES	5722	Q208	BR9EIX	3981
583 Formula Mach I	580	-	0,5	BR9ES	5722	Q208	BR9EIX	3981

* Bitte Elektrodenabstand nach Angaben des Herstellers justieren

* Please adjust the groundelectrode gap

* Veuillez vérifier L' écartement

* Por favor, ajustar distancia entre electrodos

* regolare il gap



Stock-No

Quick-No



Stock-No IX

BOMBARDIER ROTAX & BSE ENG

582 GT 582	580	-	0,4	BR9ES	5722	Q208	BR9EIX	3981
583 Formula STX/STXL/STXLT/Z 583	580	-	0,5	BR9ES	5722	Q208	BR9EIX	3981
583 GT 583	580	-	0,5	BR9ES	5722	Q208	BR9EIX	3981
583 MX-Z 583	580	-	0,5	BR9ES	5722	Q208	BR9EIX	3981
583 MX-Z LI 583	580	-	0,5	BR9ES	5722	Q208	BR9EIX	3981
583 Summit 583	580	-	0,5	BR9ES	5722	Q208	BR9EIX	3981
599 Formula III/III LT	600	-	0,5	BR10ES	4832	-	BR10EIX	6801
600 Formula III	600	-	0,5	BR10ES	4832	-	BR10EIX	6801
GSX Limited 600 HO SDI	600	-	0,8	BR9ECS	3570	-	-	-
GSX LTD 1+1 600 HO SDI	600	-	0,8	BR9ECS	3570	-	-	-
GSX Sport 1+1 600 HO	600	-	0,5	BR9ECS	3570	-	-	-
GSX Sport 1+1 600HO SDI	600	-	0,8	BR9ECS	3570	-	-	-
GSX Sport 600 HO	600	-	0,5	BR9ECS	3570	-	-	-
GSX Sport 600 HO SDI	600	-	0,8	BR9ECS	3570	-	-	-
Legend SE 600 HO SDI	600	-	0,5	BR9ECS	3570	-	-	-
Legend SE GT 600 HO SDI	600	-	0,5	BR9ECS	3570	-	-	-
Legend Sport 600 HO SDI	600	-	0,5	BR9ECS	3570	-	-	-
Legend Sport GT 600 HO SDI	600	-	0,5	BR9ECS	3570	-	-	-
MX Z Renegade X 600 HO SDI	600	-	0,8	BR9ECS	3570	-	-	-
MX Z X 600 HO	600	-	0,5	BR9ECS	3570	-	-	-
MX Z X 600 HO (E)	600	-	0,5	BR9ECS	3570	-	-	-
MX Z X 600 HO SDI	600	-	0,8	BR9ECS	3570	-	-	-
MX Z Adrenaline 600 HO	600	-	0,5	BR9ECS	3570	-	-	-
MX Z Adrenaline 600 HO (E)	600	-	0,5	BR9ECS	3570	-	-	-
MX Z Adrenaline 600 HO SDI	600	-	0,8	BR9ECS	3570	-	-	-
MX Z Adrenaline 600 HO SDI (E)	600	-	0,8	BR9ECS	3570	-	-	-
MX Z Renegade X 600 HO SDI (E)	600	-	0,8	BR9ECS	3570	-	-	-
MX Z Renegade 600 HO	600	-	0,5	BR9ECS	3570	-	-	-
MX Z Renegade 600 HO (E)	600	-	0,5	BR9ECS	3570	-	-	-
MX Z Renegade X 600 HO	600	-	0,5	BR9ECS	3570	-	-	-
MX Z Renegade X 600 HO (E)	600	-	0,5	BR9ECS	3570	-	-	-
MX Z Trail 600 HO	600	-	0,5	BR9ECS	3570	-	-	-
MX Z Trail 600 HO (E)	600	-	0,5	BR9ECS	3570	-	-	-
MX Z X 600 HO SDI (E)	600	-	0,8	BR9ECS	3570	-	-	-
Skandic SUV 600	600	-	0,5	BR9ECS	3570	-	-	-
Skandic WT LC 600	600	-	0,5	BR9ECS	3570	-	-	-
Summit Adrenaline 600 HO	600	-	0,5	BR9ECS	3570	-	-	-
Summit X 600 HO	600	-	0,5	BR9ECS	3570	-	-	-
640 ER Alpine	635	-	0,5	B7HS	5110	Q204	BR7HIX	7067
640, 640ER	635	-	0,5	AB-7	3010	-	-	-
TNT640	635	-	0,5	AB-7	3010	-	-	-
TNT669	670	-	0,5	AB-7	3010	-	-	-
670 Formula SS	670	-	0,5	BR9ES	5722	Q208	BR9EIX	3981
670 GT SE670	670	-	0,5	BR9ES	5722	Q208	BR9EIX	3981
670 Mach 1	670	-	0,5	BR10ES	4832	-	BR10EIX	6801
670 Summit 670	670	-	0,5	BR9ES	5722	Q208	BR9EIX	3981
699 GT SE	700	-	0,4	BR10ES	4832	-	BR10EIX	6801
699 Mach 1	700	-	0,4	BR10ES	4832	-	BR10EIX	6801
Legend SE 700	700	-	0,5	BR9ECS	3570	-	-	-
Legend SE GT 700	700	-	0,5	BR9ECS	3570	-	-	-
Legend Sport 700	700	-	0,5	BR9ECS	3570	-	-	-
Legend Sport GT 700	700	-	0,5	BR9ECS	3570	-	-	-

* Bitte Elektrodenabstand nach Angaben des Herstellers justieren

* Please adjust the groundelectrode gap

* Veuillez vérifier L' écartement

* Por favor, ajustar distancia entre electrodos

* regolare il gap



Stock-№

Quick-№



Stock-№ IX

BOMBARDIER ROTAX & BSE ENG

TNT775	770	-	0,5	AB-8	7909	-	-	-
779 Mach Z/ZLT	780	-	0,5	BR10ES	4832	-	BR10EIX	6801
GSX Limited 1+1 800 HO	800	-	0,5	BR9ECS	3570	-	-	-
GSX Limited 800 HO	800	-	0,5	BR9ECS	3570	-	-	-
Legend SE 800 SDI	800	-	0,8	BR9ECS	3570	-	-	-
Legend SE GT 800 SDI	800	-	0,8	BR9ECS	3570	-	-	-
MX Z Renegade 800 (E)	800	-	0,5	BR9ECS	3570	-	-	-
MX Z X Renegade 800 HO (E)	800	-	0,5	BR9ECS	3570	-	-	-
MX Z Adrenaline 800 (E)	800	-	0,5	BR9ECS	3570	-	-	-
MX Z Adrenaline 800 HO	800	-	0,5	BR9ECS	3570	-	-	-
MX Z Renegade 800 HO	800	-	0,5	BR9ECS	3570	-	-	-
MX Z Renegade X 800 HO	800	-	0,5	BR9ECS	3570	-	-	-
MX Z X 800 HO	800	-	0,5	BR9ECS	3570	-	-	-
MX Z X 800 HO (E)	800	-	0,5	BR9ECS	3570	-	-	-
Summit Adrenaline 800 HO	800	-	0,5	BR9ECS	3570	-	-	-
Summit HM 800 HO	800	-	0,5	BR9ECS	3570	-	-	-
Summit HM X 800 HO	800	-	0,5	BR9ECS	3570	-	-	-
Summit HM Xtreme 800 HO	800	-	0,5	BR9ECS	3570	-	-	-
Summit Sport 800 HO	800	-	0,5	BR9ECS	3570	-	-	-
Summit X 800 HO	800	-	0,5	BR9ECS	3570	-	-	-
809 Mach Z	800	-	0,4	BR10ES	4832	-	BR10EIX	6801
Legend SE GT V-1000	1000	-	0,8	DCPR8E	4339	-	DCPR8EIX	6546
Legend SE V-1000	1000	-	0,8	DCPR8E	4339	-	DCPR8EIX	6546
Mini Z	-	-	0,7	BPR6ES	7822	-	BPR6EIX	6637

CANADIAN CURTIS WRIGHT

KEC248	250	-	0,6	AB-7	3010	-	-	-
KEC290/2, KEC290/3	300	-	0,6	B8HS	5510	Q205	BR8HIX	7001
KEC295RS/2	300	-	*	BUE	2322	-	-	-
KEC340/2, KEC340/3	340	-	0,6	B8HS	5510	Q205	BR8HIX	7001
KEC340/22A	340	-	0,6	B8ES	2411	Q201	BR8EIX	5044
KEC340/4	340	-	0,6	B8HS	5510	Q205	BR8HIX	7001
KEC340/5	340	-	0,6	B8ES	2411	Q201	BR8EIX	5044
KEC340/5A	340	-	0,6	B8ES	2411	Q201	BR8EIX	5044
KEC400/2, KEC400/3	400	-	0,6	B8HS	5510	Q205	BR8HIX	7001
KEC400/21	400	-	0,6	B8HS	5510	Q205	BR8HIX	7001
KEC400/22	400	-	0,6	B8ES	2411	Q201	BR8EIX	5044
KEC400/22A	400	-	0,6	B8ES	2411	Q201	BR8EIX	5044
KEC400/4	400	-	0,6	B8HS	5510	Q205	BR8HIX	7001
KEC440/21	440	-	0,6	B8HS	5510	Q205	BR8HIX	7001
KEC440/22	440	-	0,6	B8HS	5510	Q205	BR8HIX	7001
KEC440/22A	440	-	0,6	B8HS	5510	Q205	BR8HIX	7001
KEC440/3, KEC440/4	440	-	0,6	B8HS	5510	Q205	BR8HIX	7001
KEC440/5	440	-	0,6	B8ES	2411	Q201	BR8EIX	5044

CHAPARRAL (XENOAH)

250	250	-	0,5	B8ES	2411	Q201	BR8EIX	5044
295	295	-	0,5	BR7ES	5122	-	-	-
340	340	-	0,5	BR7ES	5122	-	-	-
340SS	340	-	0,5	B9ES	2611	Q202	BR9EIX	3981
SSX340	340	-	0,5	BR8ES	5422	Q207	BR8EIX	5044
400 19.0mm(3/4") Reach	400	-	0,5	B8ES	2411	Q201	BR8EIX	5044

* Bitte Elektrodenabstand nach Angaben des Herstellers justieren

* Please adjust the groundelectrode gap

* Veuillez vérifier L' écartement

* Por favor, ajustar distancia entre electrodos

* regolare il gap



Stock-No

Quick-No



Stock-No IX

CHAPARRAL (XENOAH)

400 12.7mm(1/2") Reach	400	-	0,5	B7HS	5110	Q204	BR7HIX	7067
400SS 12.7mm(1/2") Reach	400	-	0,5	B8HS	5510	Q205	BR8HIX	7001
400SS 19.0mm(3/4") Reach	400	-	0,5	B9ES	2611	Q202	BR9EIX	3981
440 12.7mm(1/2") Reach	440	-	0,5	B7HS	5110	Q204	BR7HIX	7067
440 19.0mm(3/4") Reach	440	-	0,5	BR7ES	5122	-	-	-
SSX440	440	-	0,5	BR8ES	5422	Q207	BR8EIX	5044
440 Racing, 650 Racing	440	-	*	BR8HIX	7001	-	-	-
440SS 12.7mm(1/2") Reach	440	-	0,5	B8HS	5510	Q205	BR8HIX	7001
440SS 19.0mm(3/4") Reach	440	-	0,5	B9ES	2611	Q202	BR9EIX	3981

HIRTH

110R	180	-	0,5	AB-7	3010	-	-	-
60R	199	-	0,5	AB-7	3010	-	-	-
81R, 82R	246	-	0,5	AB-7	3010	-	-	-
261R, 261R3, 261R4	292	-	0,5	B8ES	2411	Q201	BR8EIX	5044
56R, 193R	292	-	0,5	AB-7	3010	-	-	-
190, 191R	300	-	0,5	AB-7	3010	-	-	-
52R, 53R, 54R, 55R	300	-	0,5	AB-7	3010	-	-	-
192R	317	-	0,5	AB-7	3010	-	-	-
194R	338	-	0,5	AB-7	3010	-	-	-
260R, 260R3, 260R4	338	-	0,5	B8ES	2411	Q201	BR8EIX	5044
160R, 200R	372	-	0,5	AB-7	3010	-	-	-
210R, 271R0	399	-	0,5	AB-7	3010	-	-	-
211R, 270R, 273R	438	-	0,5	AB-7	3010	-	-	-
180R, 220R, 275R	493	-	0,5	AB-7	3010	-	-	-
170R	600	-	0,5	AB-7	3010	-	-	-
171R	634	-	0,5	AB-7	3010	-	-	-
231R	647	-	0,5	B8HS	5510	Q205	BR8HIX	7001
280R	649	-	0,5	B8ES	2411	Q201	BR8EIX	5044
172R	650	-	0,5	AB-7	3010	-	-	-
281R0	650	-	0,5	B8ES	2411	Q201	BR8EIX	5044
230R	793	-	0,5	B8HS	5510	Q205	BR8HIX	7001

IKAR

PM3-320 11,8kW	320	-	0,7	BP6ES	7811	-	-	-
----------------	-----	---	-----	-------	------	---	---	---

ILO-ROCKWELL

L99	100	-	0,5	B6HS	4510	Q203	BR6HIX	3419
L152	148	-	0,5	AB-6	2910	-	-	-
L197	192	-	0,5	AB-6	2910	-	-	-
L227, L230	223	-	0,5	AB-7	3010	-	-	-
L252	257	-	0,5	AB-6	2910	-	-	-
2F295	285	-	0,5	B8ES	2411	Q201	BR8EIX	5044
L292, L295	292	-	0,5	AB-7	3010	-	-	-
R295, L295/70	292	-	0,5	B8ES	2411	Q201	BR8EIX	5044
L297, L300	296	-	0,5	AB-7	3010	-	-	-
2F340	337	-	0,5	B8ES	2411	Q201	BR8EIX	5044
L340	337	-	0,5	AB-7	3010	-	-	-
R340, L340/70, LR340/2	337	-	0,5	B8ES	2411	Q201	BR8EIX	5044

* Bitte Elektrodenabstand nach Angaben des Herstellers justieren

* Please adjust the groundelectrode gap

* Veuillez vérifier L' écartement

* Por favor, ajustar distancia entre electrodos

* regolare il gap



Stock-№

Quick-№



Stock-№ IX

ILO-ROCKWELL

L372, L380	372	-	0,5	AB-7	3010	-	-	-
L395	396	-	0,5	AB-7	3010	-	-	-
L399/2, LR399/2, LR400/2	398	-	0,5	B8ES	2411	Q201	BR8EIX	5044

KIORITZ(ECHO)

KEC295RS	290	-	*	BUE	2322	-	-	-
KEC340/22A w/C.D.I.	339	-	*	BUE	2322	-	-	-
KEC340/22A w/Mag.I.	339	-	0,6	B8ES	2411	Q201	BR8EIX	5044
KEC340/22B w/C.D.I.	339	-	*	BR10EIX	6801	-	-	-
KEC340/23LC, 23ALC, 23BLC	339	-	*	BR10EIX	6801	-	-	-
KEC340/5A	339	-	0,6	B8ES	2411	Q201	BR8EIX	5044
KEC340RS/2	339	-	*	BUE	2322	-	-	-
KEC340RS/24LC	339	-	*	BUE	2322	-	-	-
KEC440/22A w/C.D.I.	436	-	*	BUE	2322	-	-	-
KEC440/22A w/Mag.I.	436	-	0,6	B8ES	2411	Q201	BR8EIX	5044
KEC440/22B w/C.D.I.	436	-	*	BR10EIX	6801	-	-	-
KEC440/23LC, -23ALC, -23BLC	436	-	*	BR10EIX	6801	-	-	-

KOHLER

K141, K161, K181(4 Stroke)	-	-	0,5	B6S	3510	Q302	-	-
K250-1AM	220	-	0,5	B8ES	2411	Q201	BR8EIX	5044
K250-RLC	250	-	*	BUE	2322	-	-	-
K295-2, K295-2AX	290	-	0,5	B8ES	2411	Q201	BR8EIX	5044
K295-2SS	290	-	0,5	B10ES	7928	-	BR10EIX	6801
K295-2T	292	-	0,5	B8ES	2411	Q201	BR8EIX	5044
K295-1, K295-1T	294	-	0,5	AB-7	3010	-	-	-
K309-1, K309-1T	309	-	0,5	AB-7	3010	-	-	-
K335-1, K335-1T	335	-	0,5	AB-7	3010	-	-	-
K340-2, K340-2T	338	-	0,5	B8HS	5510	Q205	BR8HIX	7001
K340-2AX	338	-	0,5	B8ES	2411	Q201	BR8EIX	5044
K340-2FA	338	-	0,5	BR8ES	5422	Q207	BR8EIX	5044
K340-2SS	338	-	0,5	B10ES	7928	-	BR10EIX	6801
K340-2AS, -2RS, -RLC	339	-	*	BUE	2322	-	-	-
SK340-2AX	339	-	*	BUE	2322	-	-	-
K399-2, -2T	398	-	0,5	AB-7	3010	-	-	-
K399-2AX, RK399-2AX	398	-	0,5	B9ES	2611	Q202	BR9EIX	3981
K400-2RS	398	-	*	BUE	2322	-	-	-
K440-2SS 12.7mm(1/2") Reach	429	-	0,5	B9HS	5810	-	-	-
K440-2SS 19.0mm(3/4") Reach	429	-	0,5	B10ES	7928	-	BR10EIX	6801
K440-3RS 12.7mm(1/2") Reach	429	-	0,5	B9HS	5810	-	-	-
K440-3RS 19.0mm(3/4") Reach	429	-	0,5	B10ES	7928	-	BR10EIX	6801
K440-2	436	-	0,5	AB-7	3010	-	-	-
K440-2AM	436	-	0,5	B9ES	2611	Q202	BR9EIX	3981
K440-2AM w/C.D.I.	436	-	*	BUE	2322	-	-	-
K440-2AS, -2RS, -RLC	436	-	*	BUE	2322	-	-	-
K440-2AX	436	-	0,5	B8ES	2411	Q201	BR8EIX	5044
K440-2T	436	-	0,5	AB-7	3010	-	-	-
RK440-2T	436	-	0,5	AB-8	7909	-	-	-
SK440-2LC	436	-	*	BUE	2322	-	-	-
K539-2	539	-	0,5	AB-7	3010	-	-	-
K618-2	618	-	0,5	AB-7	3010	-	-	-

* Bitte Elektrodenabstand nach Angaben des Herstellers justieren

* Please adjust the groundelectrode gap

* Veuillez vérifier l' écartement

* Por favor, ajustar distancia entre electrodos

* regolare il gap



Stock-No

Quick-No



Stock-No IX

KOHLER

K645-3RS 12.7mm(1/2") Reach	645	-	0,5	B9HS	5810	-	-	-
K645-3RS 19.0mm(3/4") Reach	645	-	0,5	B10ES	7928	-	BR10EIX	6801
K645-3SS 12.7mm(1/2") Reach	645	-	0,5	B9HS	5810	-	-	-
K645-3SS 19.0mm(3/4") Reach	645	-	0,5	B10ES	7928	-	BR10EIX	6801

OCKELBOW

MAG 2034	-	-	0,5	B7ES	1111	-	BR7EIX	6664
Sachs Wankel KM914	-	-	0,5	B6HS	4510	Q203	BR6HIX	3419
Sachs SA280	280	-	0,5	AB-6	2910	-	-	-
Sachs SA290	290	-	0,5	AB-7	3010	-	-	-
Sachs SA290SS	290	-	0,5	B8HS	5510	Q205	BR8HIX	7001
JLO LR340/2	340	-	0,5	B8ES	2411	Q201	BR8EIX	5044
Sachs SA340	340	-	0,5	AB-8	7909	-	-	-
Sachs SA340RX	340	-	0,5	B9ES	2611	Q202	BR9EIX	3981
JLO 2F-400	400	-	0,5	B7ES	1111	-	BR7EIX	6664
Rotax Ockelbo 400	400	-	0,5	B7ES	1111	-	BR7EIX	6664
Rotax Ockelbo 600, 800, 8000	600	-	0,5	B8ES	2411	Q201	BR8EIX	5044

POLARIS

120 Indy / INTL	120	2014-	0,9	BR6ES	4922	-	-	-
120 Pro / INTL	120	2012-	0,9	BR6ES	4922	-	-	-
120 Pro-R / INTL	120	2013-	0,9	BR6ES	4922	-	-	-
120	120	2007-	0,9	BR6ES	4922	-	-	-
120 / EURO	120	2009-	0,9	BR6ES	4922	-	-	-
120 Assault / INTL	120	2011-	0,9	BR6ES	4922	-	-	-
120 Dragon / EURO	120	2008-	0,9	BR6ES	4922	-	-	-
120 Dragon / INTL	120	2010-	0,9	BR6ES	4922	-	-	-
120 PRO X	120	2006-	0,9	BR6ES	4922	-	-	-
120 PRO X (S04WB1AS)	120	2003-	0,9	BR6ES	4922	-	-	-
120 PRO X (S05WB1AS)	120	2005-	0,9	BR6ES	4922	-	-	-
120 XC SP (S01WB1AS)	120	2001-	0,9	BR6ES	4922	-	-	-
120 XC SP (S02WB1AS)	120	2002-	0,9	BR6ES	4922	-	-	-
120 XC SP (S03WB1AS)	120	2003-	0,9	BR6ES	4922	-	-	-
120 XCR (S00WB1AS)	120	2000-2000	0,9	BR6ES	4922	-	-	-
EC16P	164	-	0,5	B7ES	1111	-	-	-
EC17P	175	-	0,5	B7ES	1111	-	-	-
EC17PM	175	-	0,4	B7ES	1111	-	-	-
EC25PC	244	-	0,5	B9ES	2611	Q202	BR9EIX	3981
EC25PM-01	244	-	0,7	BR8ES	3961	Q207	BR8EIX	5044
EC25PS	244	-	0,5	BR8ES	5422	Q207	BR8EIX	5044
EC25PT	244	-	0,5	B9ES	2611	Q202	BR9EIX	3981
EC25PT-04	244	-	0,7	BR8ES	3961	Q207	BR8EIX	5044
EC25PT-05	244	-	0,5	B10ES	7928	-	BR10EIX	6801
EC25PT-06	244	-	0,5	B9ES	2611	Q202	BR9EIX	3981
EC25PT-07	244	-	0,7	BR9ES	3194	Q208	BR9EIX	3981
Indy Starlite	244	1991-1995	0,7	BR8ES	3961	Q207	BR8EIX	5044
EC25	250	-	0,6	BR8ES	5422	Q207	BR8EIX	5044
EC25PC	250	-	0,5	B9ES	2611	Q202	BR9EIX	3981
EC25PT	250	-	0,5	B9ES	2611	Q202	BR9EIX	3981
EC25PT-04	250	-	0,5	B8ES	2411	Q201	BR8EIX	5044
EC25PT-05	250	-	0,5	B10ES	7928	-	BR10EIX	6801

* Bitte Elektrodenabstand nach Angaben des Herstellers justieren

* Please adjust the groundelectrode gap

* Veuillez vérifier l' écartement

* Por favor, ajustar distancia entre electrodos

* regolare il gap



Stock-№

Quick-№



Stock-№ IX

POLARIS

EC25PT-06	250	-	0,5	B9ES	2611	Q202	BR9EIX	3981
EC25PT-07	250	-	0,5	BR9ES	5722	Q208	BR9EIX	3981
250 STAR (0870927)	250	1987-	0,8	BR8ES	5422	Q207	BR8EIX	5044
250 STAR (0900927)	250	1990-	0,8	BR8ES	5422	Q207	BR8EIX	5044
250 STAR FIN (F900927)	250	1990-	0,8	BR8ES	5422	Q207	BR8EIX	5044
250 STAR NOR (N870927)	250	1987-	0,8	BR8ES	5422	Q207	BR8EIX	5044
250 STAR NOR (N900927)	250	1990-	0,8	BR8ES	5422	Q207	BR8EIX	5044
250 STARTRAK (0871027)	250	1987-	0,8	BR8ES	5422	Q207	BR8EIX	5044
250 STARTRAK (0901027)	250	1990-	0,8	BR8ES	5422	Q207	BR8EIX	5044
250 STARTRAK FIN (F901027)	250	1990-	0,8	BR8ES	5422	Q207	BR8EIX	5044
250 STARTRAK NOR (N871027)	250	1987-	0,8	BR8ES	5422	Q207	BR8EIX	5044
250 STARTRAK NOR (N901027)	250	1990-	0,8	BR8ES	5422	Q207	BR8EIX	5044
EC29P	294	-	0,5	B7ES	1111	-	-	-
EC29PF	294	-	0,5	B7ES	1111	-	-	-
EC29PM	294	-	0,5	B7ES	1111	-	-	-
EC29PS	294	-	0,7	BR8ES	3961	Q207	BR8EIX	5044
EC34-2P-03	333	-	0,6	BR9ES	5722	Q208	BR9EIX	3981
EC34PL-01	333	-	0,5	B9ES	2611	Q202	BR9EIX	3981
EC34PL-02	333	-	0,5	BR9ES	5722	Q208	BR9EIX	3981
EC34PL-03	333	-	0,5	B10ES	7928	-	BR10EIX	6801
EC34PL-04	333	-	0,5	B10ES	7928	-	BR10EIX	6801
EC34PL-05	333	-	0,5	BR9ES	5722	Q208	BR9EIX	3981
EC34PM-03	333	-	0,7	BR8ES	3961	Q207	BR8EIX	5044
EC34PM-04	333	-	0,5	BR9ES	5722	Q208	BR9EIX	3981
EC34PM-04-N	333	-	0,5	B8ES	2411	Q201	BR8EIX	5044
EC34-2P-02	333	-	0,6	BR9ES	5722	Q208	BR9EIX	3981
EC34-2PM-01	333	-	0,6	BR9ES	5722	Q208	BR9EIX	3981
EC34P	335	-	0,5	B7ES	1111	-	-	-
EC34PC	335	-	0,7	BR8ES	3961	Q207	BR8EIX	5044
EC34PF	335	-	0,7	BR8ES	3961	Q207	BR8EIX	5044
EC34PQ	335	-	0,7	BR8ES	3961	Q207	BR8EIX	5044
EC34PR-06	335	-	0,5	B10ES	7928	-	BR10EIX	6801
EC34PS	335	-	0,7	BR8ES	3961	Q207	BR8EIX	5044
EC34PT-04	335	-	0,5	B8ES	2411	Q201	BR8EIX	5044
EC34PT-05	335	-	0,7	BR9ES	3194	Q208	BR9EIX	3981
EC34PT-06	335	-	0,5	B10ES	7928	-	BR10EIX	6801
EC34PT-07	335	-	0,7	BR9ES	3194	Q208	BR9EIX	3981
EC34-2PM-02	335	-	0,5	B8ES	2411	Q201	BR8EIX	5044
EC34PC	336	-	0,5	B8ES	2411	Q201	BR8EIX	5044
EC34PQ	336	-	0,7	BR8ES	5422	Q207	BR8EIX	5044
EC34-2PME-02	336	-	0,7	BR8ES	5422	Q207	BR8EIX	5044
340	340	2008-	0,8	BR8ES	5422	Q207	BR8EIX	5044
340 CLASSIC	340	2005-	0,8	BR8ES	5422	Q207	BR8EIX	5044
340 CLASSIC (S05ND3AS)	340	2003-	0,8	BR8ES	5422	Q207	BR8EIX	5044
340 EDGE LX	340	2007-	0,8	BR8ES	5422	Q207	BR8EIX	5044
340 EDGE TOURING	340	2007-	0,8	BR8ES	5422	Q207	BR8EIX	5044
340 EDGE/EDGE CLASSIC (S03NB3AS/S03ND3AS)	340	2003-	0,8	BR8ES	5422	Q207	BR8EIX	5044
340 INDY (099LB3AS)	340	1999-	0,8	BR8ES	5422	Q207	BR8EIX	5044
340 INDY DELUXE (099LD3AS)	340	1999-	0,8	BR8ES	5422	Q207	BR8EIX	5044
340 INDY DELUXE (S00LD3AS)	340	2000-2000	0,8	BR8ES	5422	Q207	BR8EIX	5044
340 INDY DELUXE (S01LD3AS)	340	2001-	0,8	BR8ES	5422	Q207	BR8EIX	5044
340 INDY DELUXE (S02LD3AS)	340	2002-	0,8	BR8ES	5422	Q207	BR8EIX	5044

* Bitte Elektrodenabstand nach Angaben des Herstellers justieren

* Please adjust the groundelectrode gap

* Veuillez vérifier l' écartement

* Por favor, ajustar distancia entre electrodos

* regolare il gap



Stock-No

Quick-No



Stock-No IX

POLARIS

340 INDY TOURING (099LT3AS)	340	1999-	0,8	BR8ES	5422	Q207	BR8EIX	5044
340 INDY TOURING (S00LT3AS)	340	2000-2000	0,8	BR8ES	5422	Q207	BR8EIX	5044
340 INDY TOURING (S01LT3AS)	340	2001-	0,8	BR8ES	5422	Q207	BR8EIX	5044
340 INDY TOURING (S02LT3AS)	340	2002-	0,8	BR8ES	5422	Q207	BR8EIX	5044
340 INDY TOURING (S03LT3AS)	340	2003-	0,8	BR8ES	5422	Q207	BR8EIX	5044
340 INDY/INT'L/CLASSIC (S04NB3AS)	340	2004-	0,8	BR8ES	5422	Q207	BR8EIX	5044
340 LITE (0913033)	340	1991-	0,8	BR8ES	5422	Q207	BR8EIX	5044
340 LITE (0923033)	340	1992-	0,8	BR8ES	5422	Q207	BR8EIX	5044
340 LITE (0933433)	340	1993-	0,8	BR8ES	5422	Q207	BR8EIX	5044
340 LITE (0943433)	340	1994-	0,8	BR8ES	5422	Q207	BR8EIX	5044
340 LITE (0953433)	340	1995-	0,8	BR8ES	5422	Q207	BR8EIX	5044
340 LITE (0963433)	340	1996-	0,8	BR8ES	5422	Q207	BR8EIX	5044
340 LITE (0973433)	340	1997-	0,8	BR8ES	5422	Q207	BR8EIX	5044
340 LITE (0983433)	340	1998-	0,8	BR8ES	5422	Q207	BR8EIX	5044
340 LITE DELUXE (0923231)	340	1992-	0,8	BR8ES	5422	Q207	BR8EIX	5044
340 LITE DELUXE (0933431)	340	1993-	0,8	BR8ES	5422	Q207	BR8EIX	5044
340 LITE DELUXE (0943431)	340	1994-	0,8	BR8ES	5422	Q207	BR8EIX	5044
340 LITE DELUXE (0953431)	340	1995-	0,8	BR8ES	5422	Q207	BR8EIX	5044
340 LITE DELUXE (0963431)	340	1996-	0,8	BR8ES	5422	Q207	BR8EIX	5044
340 LITE DELUXE (0973431)	340	1997-	0,8	BR8ES	5422	Q207	BR8EIX	5044
340 LITE DELUXE (0983431)	340	1998-	0,8	BR8ES	5422	Q207	BR8EIX	5044
340 LITE EUROPEAN (E943433)	340	1994-	0,8	BR8ES	5422	Q207	BR8EIX	5044
340 LITE EUROPEAN (E963433)	340	1996-	0,8	BR8ES	5422	Q207	BR8EIX	5044
340 LITE GT FINLAND (F923133)	340	1992-	0,8	BR8ES	5422	Q207	BR8EIX	5044
340 LITE GT (0913133)	340	1991-	0,8	BR8ES	5422	Q207	BR8EIX	5044
340 LITE GT (0923133)	340	1992-	0,8	BR8ES	5422	Q207	BR8EIX	5044
340 LITE GT (0933133)	340	1993-	0,8	BR8ES	5422	Q207	BR8EIX	5044
340 LITE GT (0943133)	340	1994-	0,8	BR8ES	5422	Q207	BR8EIX	5044
340 LITE GT (0953133)	340	1995-	0,8	BR8ES	5422	Q207	BR8EIX	5044
340 LITE GT (0963133)	340	1996-	0,8	BR8ES	5422	Q207	BR8EIX	5044
340 LITE GT (0973133)	340	1997-	0,8	BR8ES	5422	Q207	BR8EIX	5044
340 LITE GT EUROPEAN (E943133)	340	1994-	0,8	BR8ES	5422	Q207	BR8EIX	5044
340 LITE GT EUROPEAN (E953133)	340	1995-	0,8	BR8ES	5422	Q207	BR8EIX	5044
340 LITE GT EUROPEAN (E963133)	340	1996-	0,8	BR8ES	5422	Q207	BR8EIX	5044
340 LITE GT EUROPEAN (E973133)	340	1997-	0,8	BR8ES	5422	Q207	BR8EIX	5044
340 LITE GT SWE (S923133)	340	1992-	0,8	BR8ES	5422	Q207	BR8EIX	5044
340 LITE SWE (S913033)	340	1991-	0,8	BR8ES	5422	Q207	BR8EIX	5044
340 LITE SWE (S923033)	340	1992-	0,8	BR8ES	5422	Q207	BR8EIX	5044
340 LITE TOURING (0983133)	340	1998-	0,8	BR8ES	5422	Q207	BR8EIX	5044
340 LITE TOURING EUROPEAN (E983133)	340	1998-	0,8	BR8ES	5422	Q207	BR8EIX	5044
340 SPORT (0870433)	340	1987-	0,7	BR9ES	5722	Q208	BR9EIX	3981
340 SPORT NOR (N870433)	340	1987-	0,7	BR9ES	5722	Q208	BR9EIX	3981
340 SPRINT (0870933)	340	1987-	0,7	BR9ES	5722	Q208	BR9EIX	3981
340 SPRINT ES (0870931)	340	1987-	0,7	BR9ES	5722	Q208	BR9EIX	3981
340 SPRINT ES (0900931)	340	1990-	0,7	BR9ES	5722	Q208	BR9EIX	3981
340 SPRINT ES NOR (N870931)	340	1987-	0,7	BR9ES	5722	Q208	BR9EIX	3981
340 SPRINT NOR (N870933)	340	1987-	0,7	BR9ES	5722	Q208	BR9EIX	3981
340 STAR LITE (0913027)	340	1991-	0,8	BR8ES	5422	Q207	BR8EIX	5044
340 STAR LITE (0923027)	340	1992-	0,8	BR8ES	5422	Q207	BR8EIX	5044
340 STAR LITE (0933427)	340	1993-	0,8	BR8ES	5422	Q207	BR8EIX	5044
340 STAR LITE (0943427)	340	1994-	0,8	BR8ES	5422	Q207	BR8EIX	5044
340 STAR LITE (0953427)	340	1995-	0,8	BR8ES	5422	Q207	BR8EIX	5044

* Bitte Elektrodenabstand nach Angaben des Herstellers justieren

* Please adjust the groundelectrode gap

* Veuillez vérifier l' écartement

* Por favor, ajustar distancia entre electrodos

* regolare il gap



Stock-№

Quick-№



Stock-№ IX

POLARIS

340 STAR LITE GT (0933127)	340	1993-	0,8	BR8ES	5422	Q207	BR8EIX	5044
340 STAR LITE GT (0943127)	340	1994-	0,8	BR8ES	5422	Q207	BR8EIX	5044
340 STAR LITE SWE (S913027)	340	1991-	0,8	BR8ES	5422	Q207	BR8EIX	5044
340 STAR LITE SWE (S923027)	340	1992-	0,8	BR8ES	5422	Q207	BR8EIX	5044
340 TOURING	340	2006-	0,8	BR8ES	5422	Q207	BR8EIX	5044
340 TOURING/INT'L (S04NT3AS/AE)	340	2004-	0,8	BR8ES	5422	Q207	BR8EIX	5044
340 TRANSPORT/EURO	340	2008-	0,8	BR8ES	5422	Q207	BR8EIX	5044
EC37P	372	-	0,7	BR8ES	3961	Q207	BR8EIX	5044
EC40P	398	-	0,5	B7ES	1111	-	-	-
EC40P-03	398	-	0,6	BR9ES	5722	Q208	BR9EIX	3981
EC40PL-01	398	-	0,6	BR9ES	5722	Q208	BR9EIX	3981
EC40PL-02/04	398	-	0,6	BR8ES	5422	Q207	BR8EIX	5044
EC40PM	398	-	0,5	B7ES	1111	-	-	-
EC40PS	398	-	0,5	B10ES	7928	-	BR10EIX	6801
400 (0870759)	400	1987-	0,7	BR9ES	5722	Q208	BR9EIX	3981
400 (0900759)	400	1990-	0,7	BR9ES	5722	Q208	BR9EIX	3981
400 (0910759)	400	1991-	0,8	BR8ES	5422	Q207	BR8EIX	5044
400 NOR (N870759)	400	1987-	0,7	BR9ES	5722	Q208	BR9EIX	3981
400 SKS (0870559)	400	1987-	0,7	BR9ES	5722	Q208	BR9EIX	3981
400 SKS NOR (N870559)	400	1987-	0,7	BR9ES	5722	Q208	BR9EIX	3981
400 XC (0911759)	400	1991-	0,7	BR9ES	5722	Q208	BR9EIX	3981
EC34-2PM-02	432	-	0,7	BR8ES	5422	Q207	BR8EIX	5044
EC44-2PM-1100	432	-	0,7	BR9ES	3194	Q208	BR9EIX	3981
EC44-2PM-2100	432	-	0,5	BR9ES	5722	Q208	BR9EIX	3981
EC44-2PM-3100	432	-	0,7	BR9ES	3194	Q208	BR9EIX	3981
EC44-2PM-3300	432	-	0,5	BR9ES	5722	Q208	BR9EIX	3981
EC44-2PM-4100	432	-	0,6	BR9ES	5722	Q208	BR9EIX	3981
EC44-2PM-5000	432	-	0,5	BR9ES	5722	Q208	BR9EIX	3981
EC44-2PM-5100	432	-	0,7	BR9ES	3194	Q208	BR9EIX	3981
EC44-3PM-01	432	-	0,6	BR8ES	5422	Q207	BR8EIX	5044
EC44P	432	-	0,5	B7ES	1111	-	-	-
EC44PM-01	432	-	0,7	BR8ES	3961	Q207	BR8EIX	5044
EC44PM-02	432	-	0,5	BR8ES	5422	Q207	BR8EIX	5044
EC44PM-03	432	-	0,7	BR8ES	3961	Q207	BR8EIX	5044
EC44PQ	432	-	0,5	B8ES	2411	Q201	BR8EIX	5044
EC44PT	432	-	0,5	B10ES	7928	-	BR10EIX	6801
EC44PT-04	432	-	0,5	B10ES	7928	-	BR10EIX	6801
EC44PT-05	432	-	0,7	BR9ES	3194	Q208	BR9EIX	3981
Indy	432	1991-1998	0,7	BR9ES	3194	Q208	BR9EIX	3981
Indy SKS	432	1993-1995	0,7	BR9ES	3194	Q208	BR9EIX	3981
Indy Sport	432	1995-1999	0,7	BR9ES	3194	Q208	BR9EIX	3981
Indy Super Sport	432	1991-1996	0,7	BR9ES	3194	Q208	BR9EIX	3981
Indy Tran Sport	432	1996-1999	0,7	BR9ES	3194	Q208	BR9EIX	3981
Indy XCF Edge	432	1997-1998	0,7	BR9ES	3194	Q208	BR9EIX	3981
EC45PL-01	436	1999-	0,5	B10ES	7928	-	BR10EIX	6801
EC45PL-08	439	-	0,6	BR9ES	5722	Q208	BR9EIX	3981
EC45PL-09	439	-	0,7	BR8ES	5422	Q207	BR8EIX	5044
440 INDY (0982760)	440	1998-	0,8	BR8ES	5422	Q207	BR8EIX	5044
440 IQ	440	2006-	0,6	BR10EG	3830	-	-	-
440 IQ (S05MX4CS)	440	2005-	0,6	BR10EG	3830	-	-	-
440 IQ / EURO	440	2007-	0,6	BR10EG	3830	-	-	-
440 (0920760)	440	1992-	0,8	BR8ES	5422	Q207	BR8EIX	5044

* Bitte Elektrodenabstand nach Angaben des Herstellers justieren

* Please adjust the groundelectrode gap

* Veuillez vérifier L' écartement

* Por favor, ajustar distancia entre electrodos

* regolare il gap



Stock-No

Quick-No



Stock-No IX

POLARIS

440 L/C (0930760)	440	1993-	0,8	BR8ES	5422	Q207	BR8EIX	5044
440 L/C (0942760)	440	1994-	0,8	BR8ES	5422	Q207	BR8EIX	5044
440 L/C (0952760)	440	1995-	0,8	BR8ES	5422	Q207	BR8EIX	5044
440 L/C (0962760)	440	1996-	0,8	BR8ES	5422	Q207	BR8EIX	5044
440 L/C (0972760)	440	1997-	0,8	BR8ES	5422	Q207	BR8EIX	5044
440 LONGTRAK (0871549)	440	1987-	0,7	BR9ES	5722	Q208	BR9EIX	3981
440 LONGTRAK W/REVERSE (0871549)	440	1987-	0,7	BR9ES	5722	Q208	BR9EIX	3981
440 LONGTRAK W/REVERSE NOR (N861549)	440	1987-	0,7	BR9ES	5722	Q208	BR9EIX	3981
440 LONGTRAK W/REVERSE NOR (N871549)	440	1987-	0,7	BR9ES	5722	Q208	BR9EIX	3981
440 EUROPEAN (E930760)	440	1993-	0,8	BR8ES	5422	Q207	BR8EIX	5044
440 EUROPEAN (E942760)	440	1994-	0,8	BR8ES	5422	Q207	BR8EIX	5044
440 PRO X (S01NX4CS)	440	2001-	0,6	BR10EG	3830	-	-	-
440 PRO X (S02NX4CS)	440	2002-	0,6	BR10EG	3830	-	-	-
440 PRO X (S03NX4CS)	440	2003-	0,6	BR10EG	3830	-	-	-
440 PRO X FAN COOLED (S02NX4FS)	440	2002-	0,7	BR9ES	5722	Q208	BR9EIX	3981
440 PRO X FAN COOLED (S03NX4FS)	440	2003-	0,7	BR9ES	5722	Q208	BR9EIX	3981
440 PRO XR (S04NX4CS)	440	2004-	0,6	BR10EG	3830	-	-	-
440 SKS (0930560)	440	1993-	0,8	BR8ES	5422	Q207	BR8EIX	5044
440 SKS (0942560)	440	1994-	0,8	BR8ES	5422	Q207	BR8EIX	5044
440 SKS (0952560)	440	1995-	0,8	BR8ES	5422	Q207	BR8EIX	5044
440 SKS EUROPEAN (E930560)	440	1993-	0,8	BR8ES	5422	Q207	BR8EIX	5044
440 SKS EUROPEAN (E942560)	440	1994-	0,8	BR8ES	5422	Q207	BR8EIX	5044
440 SKS EUROPEAN (E952560)	440	1995-	0,8	BR8ES	5422	Q207	BR8EIX	5044
440 SPORT (0900433)	440	1990-	0,7	BR9ES	5722	Q208	BR9EIX	3981
440 SPORT (0910443)	440	1991-	0,8	BR8ES	5422	Q207	BR8EIX	5044
440 SPORT (0920443)	440	1992-	0,8	BR8ES	5422	Q207	BR8EIX	5044
440 SPORT (0930443)	440	1993-	0,8	BR8ES	5422	Q207	BR8EIX	5044
440 SPORT (0940443)	440	1994-	0,8	BR8ES	5422	Q207	BR8EIX	5044
440 SPORT (0950443)	440	1995-	0,8	BR8ES	5422	Q207	BR8EIX	5044
440 SPORT (0960443)	440	1996-	0,8	BR8ES	5422	Q207	BR8EIX	5044
440 SPORT (0970443)	440	1997-	0,8	BR8ES	5422	Q207	BR8EIX	5044
440 SPORT (0980443)	440	1998-	0,8	BR8ES	5422	Q207	BR8EIX	5044
440 SPORT (099SB4DS)	440	1999-	0,8	BR8ES	5422	Q207	BR8EIX	5044
440 SPORT EUROPEAN (E930443)	440	1993-	0,8	BR8ES	5422	Q207	BR8EIX	5044
440 SPORT EUROPEAN (E970443)	440	1997-	0,8	BR8ES	5422	Q207	BR8EIX	5044
440 SPORT GT (0902433)	440	1990-	0,7	BR9ES	5722	Q208	BR9EIX	3981
440 SPORT GT (0912443)	440	1991-	0,8	BR8ES	5422	Q207	BR8EIX	5044
440 SPORT GT (0922443)	440	1992-	0,8	BR8ES	5422	Q207	BR8EIX	5044
440 SPORT GT SWE (S912443)	440	1991-	0,8	BR8ES	5422	Q207	BR8EIX	5044
440 SPORT GT SWE (S922443)	440	1992-	0,8	BR8ES	5422	Q207	BR8EIX	5044
440 SPORT GT NOR (N902433)	440	1990-	0,7	BR9ES	5722	Q208	BR9EIX	3981
440 SPORT GT SWE (S902433)	440	1990-	0,7	BR9ES	5722	Q208	BR9EIX	3981
440 SPORT NOR (N900433)	440	1990-	0,7	BR9ES	5722	Q208	BR9EIX	3981
440 SPORT SKS (0940243)	440	1994-	0,8	BR8ES	5422	Q207	BR8EIX	5044
440 SPORT SKS EUROPEAN (E940243)	440	1994-	0,8	BR8ES	5422	Q207	BR8EIX	5044
440 SPORT SWE (S900433)	440	1990-	0,7	BR9ES	5722	Q208	BR9EIX	3981
440 SPORT SWE (S920443)	440	1992-	0,8	BR8ES	5422	Q207	BR8EIX	5044
440 SPORT TOURING (0950243)	440	1995-	0,8	BR8ES	5422	Q207	BR8EIX	5044
440 SPORT TOURING (0960243)	440	1996-	0,8	BR8ES	5422	Q207	BR8EIX	5044
440 SPORT TOURING (0970243)	440	1997-	0,8	BR8ES	5422	Q207	BR8EIX	5044
440 SPORT TOURING (0980243)	440	1998-	0,8	BR8ES	5422	Q207	BR8EIX	5044
440 SPORT TOURING (099ST4DS)	440	1999-	0,8	BR8ES	5422	Q207	BR8EIX	5044

* Bitte Elektrodenabstand nach Angaben des Herstellers justieren

* Please adjust the groundelectrode gap

* Veuillez vérifier l' écartement

* Por favor, ajustar distancia entre electrodos

* regolare il gap



Stock-№

Quick-№



Stock-№ IX

POLARIS

440 SPORT TOURING EUROPEAN (E950243)	440	1995-	0,8	BR8ES	5422	Q207	BR8EIX	5044
440 SPORT TOURING EUROPEAN (E960243)	440	1996-	0,8	BR8ES	5422	Q207	BR8EIX	5044
440 SPORT TOURING EUROPEAN (E970243)	440	1997-	0,8	BR8ES	5422	Q207	BR8EIX	5044
440 SPORT (LITE) (S00LB4AS)	440	2000-2000	0,7	BR9ES	5722	Q208	BR9EIX	3981
440 SUPER SPORT (0940743)	440	1994-	0,8	BR8ES	5422	Q207	BR8EIX	5044
440 SUPER SPORT (0950743)	440	1995-	0,8	BR8ES	5422	Q207	BR8EIX	5044
440 SUPER SPORT (0960743)	440	1996-	0,8	BR8ES	5422	Q207	BR8EIX	5044
440 SUPER SPORT EUROPEAN (E940743)	440	1994-	0,8	BR8ES	5422	Q207	BR8EIX	5044
440 SWE (S920760)	440	1992-	0,8	BR8ES	5422	Q207	BR8EIX	5044
440 TRANSPORT (0960143)	440	1996-	0,8	BR8ES	5422	Q207	BR8EIX	5044
440 TRANSPORT (0970143)	440	1997-	0,8	BR8ES	5422	Q207	BR8EIX	5044
440 TRANSPORT (0980143)	440	1998-	0,8	BR8ES	5422	Q207	BR8EIX	5044
440 TRANSPORT (099SU4DS)	440	1999-	0,8	BR8ES	5422	Q207	BR8EIX	5044
440 TRANSPORT EUROPEAN (E960143)	440	1996-	0,8	BR8ES	5422	Q207	BR8EIX	5044
440 TRANSPORT EUROPEAN (E970143)	440	1997-	0,8	BR8ES	5422	Q207	BR8EIX	5044
440 TRANSPORT EUROPEAN (E980143)	440	1998-	0,8	BR8ES	5422	Q207	BR8EIX	5044
440 XC (0971760)	440	1997-	0,7	BR9ES	5722	Q208	BR9EIX	3981
440 XC SP (S00NX4CS]	440	2000-2000	0,6	BR10EG	3830	-	-	-
440 XCF (0971643)	440	1997-	0,8	BR8ES	5422	Q207	BR8EIX	5044
440 XCF (0981643)	440	1998-	0,8	BR8ES	5422	Q207	BR8EIX	5044
440 XCF (099SP4AS)	440	1999-	0,7	BR9ES	5722	Q208	BR9EIX	3981
440 XCR (0921760)	440	1992-	0,7	BR9ES	5722	Q208	BR9EIX	3981
440 XCR (0931760)	440	1993-	0,7	BR9ES	5722	Q208	BR9EIX	3981
440 XCR (0941760)	440	1994-	0,7	BR9ES	5722	Q208	BR9EIX	3981
440 XCR (0951660)	440	1995-	0,7	BR9ES	5722	Q208	BR9EIX	3981
440 XCR (0961660)	440	1996-	0,7	BR9ES	5722	Q208	BR9EIX	3981
440 XCR (0971660)	440	1997-	0,7	BR9ES	5722	Q208	BR9EIX	3981
440 XCR (0981660)	440	1998-	0,7	BR9ES	5722	Q208	BR9EIX	3981
440 XCR (099SX4CS)	440	1999-	0,7	BR9ES	5722	Q208	BR9EIX	3981
440 XCR EUROPEAN (E931760)	440	1993-	0,7	BR9ES	5722	Q208	BR9EIX	3981
440 XCR SP (0941660)	440	1995-	0,7	BR9ES	5722	Q208	BR9EIX	3981
440 XCR SP (0951660)	440	1995-	0,7	BR9ES	5722	Q208	BR9EIX	3981
440 XCR SP (0961760)	440	1996-	0,7	BR9ES	5722	Q208	BR9EIX	3981
440 XCR SP (099NX4CS)	440	1999-	0,6	BR10EG	3830	-	-	-
440 XCR SWE (S921760)	440	1992-	0,7	BR9ES	5722	Q208	BR9EIX	3981
450 XCF EDGE (S00NX4FS)	450	2000-2000	0,7	BR9ES	5722	Q208	BR9EIX	3981
450 XCF SP (099SX4FS)	450	1999-	0,7	BR9ES	5722	Q208	BR9EIX	3981
450 XCF SP EDGE (S01NX4FS)	450	2001-	0,7	BR9ES	5722	Q208	BR9EIX	3981
EC50P	488	-	0,5	B7ES	1111	-	-	-
EC50P	488	-	0,7	BR9ES	3194	Q208	BR9EIX	3981
EC50PL-01	488	-	0,7	BR9ES	3194	Q208	BR9EIX	3981
EC50PL-02/04/05/06/	488	-	0,6	BR8ES	5422	Q207	BR8EIX	5044
EC50PL-02	488	-	0,7	BR9ES	3194	Q208	BR9EIX	3981
EC50PL-03	488	-	0,7	BR9ES	3194	Q208	BR9EIX	3981
EC50PL-16/17/1819/20	488	-	0,6	BR8ES	5422	Q207	BR8EIX	5044
EC50PM-01/02/03/04/05/06	488	-	0,6	BR8ES	5422	Q207	BR8EIX	5044
EC5-PM-01	488	-	0,7	BR9ES	3194	Q208	BR9EIX	3981
EC5-PM-02	488	-	0,7	BR9ES	3194	Q208	BR9EIX	3981
EC5-PM-03	488	-	0,7	BR9ES	3194	Q208	BR9EIX	3981
500 INDY (0972764)	500	1997-	0,8	BR8ES	5422	Q207	BR8EIX	5044
500 INDY EUROPEAN (E972764)	500	1997-	0,8	BR8ES	5422	Q207	BR8EIX	5044
500 INDY (0982764)	500	1998-	0,8	BR8ES	5422	Q207	BR8EIX	5044

* Bitte Elektrodenabstand nach Angaben des Herstellers justieren

* Please adjust the groundelectrode gap

* Veuillez vérifier l' écartement

* Por favor, ajustar distancia entre electrodos

* regolare il gap



Stock-No

Quick-No



Stock-No IX

POLARIS

500 INDY (0982764A)	500	1998-	0,8	BR8ES	5422	Q207	BR8EIX	5044
500 INDY (0982764B)	500	1998-	0,8	BR8ES	5422	Q207	BR8EIX	5044
500 INDY EUROPEAN (E982764A)	500	1998-	0,8	BR8ES	5422	Q207	BR8EIX	5044
500 INDY (099EB4BS)	500	1999-	0,8	BR8ES	5422	Q207	BR8EIX	5044
500 INDY (099EB4BSA)	500	1999-	0,8	BR8ES	5422	Q207	BR8EIX	5044
500 INDY (S00SB4BS)	500	2000-2000	0,8	BR8ES	5422	Q207	BR8EIX	5044
500 INDY (S01NB4BS)	500	2001-	0,8	BR8ES	5422	Q207	BR8EIX	5044
500 INDY (S02NB4BS)	500	2002-	0,8	BR8ES	5422	Q207	BR8EIX	5044
500 INDY	500	2006-	0,8	BR8ES	5422	Q207	BR8EIX	5044
500 INDY (S05NB4BS)	500	2005-	0,8	BR8ES	5422	Q207	BR8EIX	5044
500 CARB RMK (0962964)	500	1996-	0,8	BR8ES	5422	Q207	BR8EIX	5044
500 RMK (0972564)	500	1996-	0,8	BR8ES	5422	Q207	BR8EIX	5044
500 RMK EUROPEAN (E972564)	500	1996-	0,8	BR8ES	5422	Q207	BR8EIX	5044
500 RMK (0972964)	500	1997-	0,8	BR8ES	5422	Q207	BR8EIX	5044
500 RMK EUROPEAN (E972964)	500	1997-	0,8	BR8ES	5422	Q207	BR8EIX	5044
500 RMK (0982964)	500	1998-	0,8	BR8ES	5422	Q207	BR8EIX	5044
500 RMK EUROPEAN (E982964)	500	1998-	0,8	BR8ES	5422	Q207	BR8EIX	5044
500 RMK (099ER4BS)	500	1999-	0,8	BR8ES	5422	Q207	BR8EIX	5044
500 RMK (S00SR5AS)	500	2000-2000	0,7	BR9ES	5722	Q208	BR9EIX	3981
500 RMK 136 (S01SR5AS)	500	2001-	0,7	BR9ES	5722	Q208	BR9EIX	3981
500 RMK 136 (S02SR5AS)	500	2002-	0,7	BR9ES	5722	Q208	BR9EIX	3981
500 TRAIL RMK (0980961)	500	1997-	0,8	BR8ES	5422	Q207	BR8EIX	5044
500 TRAIL RMK (0980961)	500	1998-	0,8	BR8ES	5422	Q207	BR8EIX	5044
500 CARB (0952764)	500	1995-	0,8	BR8ES	5422	Q207	BR8EIX	5044
500 CARB (0962764)	500	1996-	0,8	BR8ES	5422	Q207	BR8EIX	5044
500 CARB SKS (0962564)	500	1996-	0,8	BR8ES	5422	Q207	BR8EIX	5044
500 CARB SKS EUROPEAN (E962564)	500	1996-	0,8	BR8ES	5422	Q207	BR8EIX	5044
500 (0900764)	500	1990-	0,7	BR9ES	5722	Q208	BR9EIX	3981
500 (0910764)	500	1991-	0,8	BR8ES	5422	Q207	BR8EIX	5044
500 (0920764)	500	1992-	0,8	BR8ES	5422	Q207	BR8EIX	5044
500 CLASSIC (0900865)	500	1990-	0,7	BR9ES	5722	Q208	BR9EIX	3981
500 CLASSIC (0910865)	500	1991-	0,8	BR8ES	5422	Q207	BR8EIX	5044
500 CLASSIC (0920865)	500	1992-	0,8	BR8ES	5422	Q207	BR8EIX	5044
500 CLASSIC (0930864)	500	1993-	0,8	BR8ES	5422	Q207	BR8EIX	5044
500 CLASSIC (0942865)	500	1994-	0,8	BR8ES	5422	Q207	BR8EIX	5044
500 CLASSIC (0952865)	500	1995-	0,8	BR8ES	5422	Q207	BR8EIX	5044
500 CLASSIC (0963865)	500	1996-	0,8	BR8ES	5422	Q207	BR8EIX	5044
500 CLASSIC (0973865)	500	1997-	0,8	BR8ES	5422	Q207	BR8EIX	5044
500 CLASSIC (0983865)	500	1998-	0,8	BR8ES	5422	Q207	BR8EIX	5044
500 CLASSIC (099ED4BS)	500	1999-	0,8	BR8ES	5422	Q207	BR8EIX	5044
500 CLASSIC (S00SD4BS)	500	2000-2000	0,8	BR8ES	5422	Q207	BR8EIX	5044
500 CLASSIC (S01SD4BS)	500	2001-	0,8	BR8ES	5422	Q207	BR8EIX	5044
500 CLASSIC (S02ND4BS)	500	2002-	0,8	BR8ES	5422	Q207	BR8EIX	5044
500 CLASSIC (S03ND5CS)	500	2003-	0,6	BR10EG	3830	-	-	-
500 CLASSIC (S04ND4BS)	500	2004-	0,8	BR8ES	5422	Q207	BR8EIX	5044
500 CLASSIC (S05ND4BS)	500	2005-	0,8	BR8ES	5422	Q207	BR8EIX	5044
500 CLASSIC	500	2006-	0,8	BR8ES	5422	Q207	BR8EIX	5044
500 CLASSIC EUROPEAN (E930864)	500	1993-	0,8	BR8ES	5422	Q207	BR8EIX	5044
500 CLASSIC EUROPEAN (E942865)	500	1994-	0,8	BR8ES	5422	Q207	BR8EIX	5044
500 CLASSIC FIN (F900865)	500	1990-	0,7	BR9ES	5722	Q208	BR9EIX	3981
500 CLASSIC NOR (N900865)	500	1990-	0,7	BR9ES	5722	Q208	BR9EIX	3981
500 CLASSIC SWE (S900865)	500	1990-	0,7	BR9ES	5722	Q208	BR9EIX	3981

* Bitte Elektrodenabstand nach Angaben des Herstellers justieren

* Please adjust the groundelectrode gap

* Veuillez vérifier l' écartement

* Por favor, ajustar distancia entre electrodos

* regolare il gap



Stock-№

Quick-№



Stock-№ IX

POLARIS

500 CLASSIC TOURING (0930865)	500	1993-	0,8	BR8ES	5422	Q207	BR8EIX	5044
500 CLASSIC TOURING (0942875)	500	1994-	0,8	BR8ES	5422	Q207	BR8EIX	5044
500 CLASSIC TOURING (0963365)	500	1996-	0,8	BR8ES	5422	Q207	BR8EIX	5044
500 CLASSIC TOURING (0973365)	500	1997-	0,8	BR8ES	5422	Q207	BR8EIX	5044
500 CLASSIC TOURING (0983365)	500	1998-	0,8	BR8ES	5422	Q207	BR8EIX	5044
500 CLASSIC TOURING (099ET4BS)	500	1999-	0,8	BR8ES	5422	Q207	BR8EIX	5044
500 CLASSIC TOURING (S00ST4BS)	500	2000-2000	0,8	BR8ES	5422	Q207	BR8EIX	5044
500 CLASSIC TOURING (S01ST4BS)	500	2001-	0,8	BR8ES	5422	Q207	BR8EIX	5044
500 CLASSIC TOURING (S02ST4BS)	500	2002-	0,8	BR8ES	5422	Q207	BR8EIX	5044
500 CLASSIC TOURING (S03ST4BS)	500	2003-	0,8	BR8ES	5422	Q207	BR8EIX	5044
500 CLASSIC TOURING EUROPEAN (E930865)	500	1993-	0,8	BR8ES	5422	Q207	BR8EIX	5044
500 CLASSIC TOURING EUROPEAN (E942875)	500	1994-	0,8	BR8ES	5422	Q207	BR8EIX	5044
500 CLASSIC TOURING EUROPEAN (E963365)	500	1996-	0,8	BR8ES	5422	Q207	BR8EIX	5044
500 CLASSIC TOURING EUROPEAN (E973365)	500	1997-	0,8	BR8ES	5422	Q207	BR8EIX	5044
500 CLASSIC TOURING EUROPEAN (E983365)	500	1998-	0,8	BR8ES	5422	Q207	BR8EIX	5044
500 EDGE (S04NB4BS)	500	2003-	0,8	BR8ES	5422	Q207	BR8EIX	5044
500 EDGE (S04NB4BS)	500	2004-	0,8	BR8ES	5422	Q207	BR8EIX	5044
500 EFI (0930674)	500	1993-	0,8	BR8ES	5422	Q207	BR8EIX	5044
500 EFI (0942774)	500	1994-	0,8	BR8ES	5422	Q207	BR8EIX	5044
500 EFI (0952774)	500	1995-	0,8	BR8ES	5422	Q207	BR8EIX	5044
500 EFI (0963774)	500	1996-	0,8	BR8ES	5422	Q207	BR8EIX	5044
500 EFI (0973774)	500	1997-	0,8	BR8ES	5422	Q207	BR8EIX	5044
500 EFI EUROPEAN (E930674)	500	1993-	0,8	BR8ES	5422	Q207	BR8EIX	5044
500 EFI EUROPEAN (E942774)	500	1994-	0,8	BR8ES	5422	Q207	BR8EIX	5044
500 EFI EUROPEAN (E963774)	500	1996-	0,8	BR8ES	5422	Q207	BR8EIX	5044
500 EFI SKS (0930574)	500	1993-	0,8	BR8ES	5422	Q207	BR8EIX	5044
500 EFI SKS (0942574)	500	1994-	0,8	BR8ES	5422	Q207	BR8EIX	5044
500 EFI SKS (0952574)	500	1995-	0,8	BR8ES	5422	Q207	BR8EIX	5044
500 EFI SKS (0962574)	500	1996-	0,8	BR8ES	5422	Q207	BR8EIX	5044
500 EFI SKS EUROPEAN (E942574)	500	1994-	0,8	BR8ES	5422	Q207	BR8EIX	5044
500 EFI SKS EUROPEAN (E952574)	500	1995-	0,8	BR8ES	5422	Q207	BR8EIX	5044
500 EFI SKS EUROPEAN (E962574)	500	1996-	0,8	BR8ES	5422	Q207	BR8EIX	5044
500 EFI SKS PDL TRK (0952974)	500	1995-	0,8	BR8ES	5422	Q207	BR8EIX	5044
500 FIN (F900764)	500	1990-	0,7	BR9ES	5722	Q208	BR9EIX	3981
500 SKS (0900564)	500	1990-	0,7	BR9ES	5722	Q208	BR9EIX	3981
500 SKS (0910564)	500	1991-	0,8	BR8ES	5422	Q207	BR8EIX	5044
500 SKS (0920574)	500	1992-	0,8	BR8ES	5422	Q207	BR8EIX	5044
500 SKS (0952574)	500	1995-	0,8	BR8ES	5422	Q207	BR8EIX	5044
500 SKS (0972564)	500	1997-	0,8	BR8ES	5422	Q207	BR8EIX	5044
500 SKS EUROPEAN (E930574)	500	1993-	0,8	BR8ES	5422	Q207	BR8EIX	5044
500 SKS EUROPEAN (E972564)	500	1997-	0,8	BR8ES	5422	Q207	BR8EIX	5044
500 SKS EURO (E00SS5AU)	500	2000-2000	0,7	BR9ES	5722	Q208	BR9EIX	3981
500 SKS EURO (S01SS5AU)	500	2001-	0,7	BR9ES	5722	Q208	BR9EIX	3981
500 SKS EURO (S02SS5AE)	500	2002-	0,7	BR9ES	5722	Q208	BR9EIX	3981
500 SKS FIN (F900564)	500	1990-	0,7	BR9ES	5722	Q208	BR9EIX	3981
500 SKS FINLAND (F920574)	500	1992-	0,8	BR8ES	5422	Q207	BR8EIX	5044
500 SKS NOR (N900564)	500	1990-	0,7	BR9ES	5722	Q208	BR9EIX	3981
500 SKS SWE (S900564)	500	1990-	0,7	BR9ES	5722	Q208	BR9EIX	3981
500 SKS SWE (S910564)	500	1991-	0,8	BR8ES	5422	Q207	BR8EIX	5044
500 SKS SWE (S920574)	500	1992-	0,8	BR8ES	5422	Q207	BR8EIX	5044
500 SP (0900664)	500	1990-	0,7	BR9ES	5722	Q208	BR9EIX	3981
500 SP (0910664)	500	1991-	0,8	BR8ES	5422	Q207	BR8EIX	5044

* Bitte Elektrodenabstand nach Angaben des Herstellers justieren

* Please adjust the groundelectrode gap

* Veuillez vérifier L' écartement

* Por favor, ajustar distancia entre electrodos

* regolare il gap



Stock-No

Quick-No



Stock-No IX

POLARIS

500 SP (X920674)	500	1992-	0,8	BR8ES	5422	Q207	BR8EIX	5044
500 SP EFI (0920674)	500	1992-	0,8	BR8ES	5422	Q207	BR8EIX	5044
500 SP FIN (F900664)	500	1990-	0,7	BR9ES	5722	Q208	BR9EIX	3981
500 SP SWE (S900664)	500	1990-	0,7	BR9ES	5722	Q208	BR9EIX	3981
500 SP SWE (S920674)	500	1992-	0,8	BR8ES	5422	Q207	BR8EIX	5044
500 SPX (0920674N)	500	1992-	0,8	BR8ES	5422	Q207	BR8EIX	5044
500 SUPERSPORT (0970761)	500	1997-	0,8	BR8ES	5422	Q207	BR8EIX	5044
500 SUPERSPORT (0980761)	500	1998-	0,8	BR8ES	5422	Q207	BR8EIX	5044
500 SUPERTRAK (0920161)	500	1992-	0,8	BR8ES	5422	Q207	BR8EIX	5044
500 SUPERTRAK SWE (S920161)	500	1992-	0,8	BR8ES	5422	Q207	BR8EIX	5044
500 SWE (S910764)	500	1991-	0,8	BR8ES	5422	Q207	BR8EIX	5044
500 TRAIL (0870761)	500	1987-	0,7	BR9ES	5722	Q208	BR9EIX	3981
500 TRAIL (0900761)	500	1990-	0,7	BR9ES	5722	Q208	BR9EIX	3981
500 TRAIL (0910761)	500	1991-	0,8	BR8ES	5422	Q207	BR8EIX	5044
500 TRAIL (0920761)	500	1992-	0,8	BR8ES	5422	Q207	BR8EIX	5044
500 TRAIL (0930761)	500	1993-	0,8	BR8ES	5422	Q207	BR8EIX	5044
500 TRAIL (0940761)	500	1994-	0,8	BR8ES	5422	Q207	BR8EIX	5044
500 TRAIL (0952761)	500	1995-	0,8	BR8ES	5422	Q207	BR8EIX	5044
500 TRAIL (0962761)	500	1996-	0,8	BR8ES	5422	Q207	BR8EIX	5044
500 TRAIL (0972761)	500	1997-	0,8	BR8ES	5422	Q207	BR8EIX	5044
500 TRAIL (0982761)	500	1998-	0,8	BR8ES	5422	Q207	BR8EIX	5044
500 TRAIL (099EB4ES)	500	1999-	0,8	BR8ES	5422	Q207	BR8EIX	5044
500 TRAIL (099EB4ESA)	500	1999-	0,8	BR8ES	5422	Q207	BR8EIX	5044
500 TRAIL DELUXE (0900262)	500	1990-	0,7	BR9ES	5722	Q208	BR9EIX	3981
500 TRAIL DELUXE (0910262)	500	1991-	0,8	BR8ES	5422	Q207	BR8EIX	5044
500 TRAIL DELUXE (0920262)	500	1992-	0,8	BR8ES	5422	Q207	BR8EIX	5044
500 TRAIL DELUXE (0930262)	500	1993-	0,8	BR8ES	5422	Q207	BR8EIX	5044
500 TRAIL DELUXE (0940262)	500	1994-	0,8	BR8ES	5422	Q207	BR8EIX	5044
500 TRAIL DELUXE (0950262)	500	1995-	0,8	BR8ES	5422	Q207	BR8EIX	5044
500 TRAIL DELUXE EUROPEAN (E930262)	500	1993-	0,8	BR8ES	5422	Q207	BR8EIX	5044
500 TRAIL DELUXE EUROPEAN (E940262)	500	1994-	0,8	BR8ES	5422	Q207	BR8EIX	5044
500 TRAIL DELUXE EUROPEAN (E950262)	500	1995-	0,8	BR8ES	5422	Q207	BR8EIX	5044
500 TRAIL DELUXE FIN (F900262)	500	1990-	0,7	BR9ES	5722	Q208	BR9EIX	3981
500 TRAIL DELUXE NOR (N900262)	500	1990-	0,7	BR9ES	5722	Q208	BR9EIX	3981
500 TRAIL DELUXE SWE (S900262)	500	1990-	0,7	BR9ES	5722	Q208	BR9EIX	3981
500 TRAIL DELUXE SWE (S910262)	500	1991-	0,8	BR8ES	5422	Q207	BR8EIX	5044
500 TRAIL ES (0870762)	500	1987-	0,7	BR9ES	5722	Q208	BR9EIX	3981
500 TRAIL EUROPEAN (E930761)	500	1993-	0,8	BR8ES	5422	Q207	BR8EIX	5044
500 TRAIL EUROPEAN (E952761)	500	1995-	0,8	BR8ES	5422	Q207	BR8EIX	5044
500 TRAIL EUROPEAN (E972761)	500	1997-	0,8	BR8ES	5422	Q207	BR8EIX	5044
500 TRAIL FIN (F900761)	500	1990-	0,7	BR9ES	5722	Q208	BR9EIX	3981
500 TRAIL NOR (N870761)	500	1987-	0,7	BR9ES	5722	Q208	BR9EIX	3981
500 TRAIL SKS (0870561)	500	1987-	0,7	BR9ES	5722	Q208	BR9EIX	3981
500 TRAIL SKS NOR (N870561)	500	1987-	0,7	BR9ES	5722	Q208	BR9EIX	3981
500 TRAIL SUPERTRAK (0900161)	500	1990-	0,7	BR9ES	5722	Q208	BR9EIX	3981
500 TRAIL SUPERTRAK (0910161)	500	1991-	0,8	BR8ES	5422	Q207	BR8EIX	5044
500 TRAIL SUPERTRAK NOR (N900161)	500	1990-	0,7	BR9ES	5722	Q208	BR9EIX	3981
500 TRAIL SUPERTRAK SWE (S900161)	500	1990-	0,7	BR9ES	5722	Q208	BR9EIX	3981
500 TRAIL SUPERTRAK SWE (S910161)	500	1991-	0,8	BR8ES	5422	Q207	BR8EIX	5044
500 TRAIL SWE (S910761)	500	1991-	0,8	BR8ES	5422	Q207	BR8EIX	5044
500 TRAIL TOURING (0960262)	500	1996-	0,8	BR8ES	5422	Q207	BR8EIX	5044
500 TRAIL TOURING (0982362)	500	1998-	0,8	BR8ES	5422	Q207	BR8EIX	5044

* Bitte Elektrodenabstand nach Angaben des Herstellers justieren

* Please adjust the groundelectrode gap

* Veuillez vérifier l' écartement

* Por favor, ajustar distancia entre electrodos

* regolare il gap



Stock-No

Quick-No



Stock-No IX

POLARIS

500 TRAIL TOURING (0972262)	500	1997-	0,8	BR8ES	5422	Q207	BR8EIX	5044
500 TRAIL TOURING (099ET4ES)	500	1999-	0,8	BR8ES	5422	Q207	BR8EIX	5044
500 TRAIL TOURING (099ET4ESA)	500	1999-	0,8	BR8ES	5422	Q207	BR8EIX	5044
500 TRAIL TOURING EUROPEAN (E960262)	500	1996-	0,8	BR8ES	5422	Q207	BR8EIX	5044
500 TRAIL TOURING EUROPEAN (E972262)	500	1997-	0,8	BR8ES	5422	Q207	BR8EIX	5044
500 TRAIL TOURING EUROPEAN (E982362)	500	1998-	0,8	BR8ES	5422	Q207	BR8EIX	5044
500 WIDETRAK (0902064)	500	1990-	0,7	BR9ES	5722	Q208	BR9EIX	3981
500 WIDETRAK (0912064)	500	1991-	0,8	BR8ES	5422	Q207	BR8EIX	5044
500 WIDETRAK (0922064)	500	1992-	0,8	BR8ES	5422	Q207	BR8EIX	5044
500 WIDETRAK (0932064)	500	1993-	0,8	BR8ES	5422	Q207	BR8EIX	5044
500 WIDETRAK EUROPEAN (E932064)	500	1993-	0,8	BR8ES	5422	Q207	BR8EIX	5044
500 WIDETRAK GT (X932061)	500	1993-	0,8	BR8ES	5422	Q207	BR8EIX	5044
500 WIDETRAK GT (0942061)	500	1994-	0,8	BR8ES	5422	Q207	BR8EIX	5044
500 WIDETRAK GT (0952061)	500	1995-	0,8	BR8ES	5422	Q207	BR8EIX	5044
500 WIDETRAK GT (0962061)	500	1996-	0,8	BR8ES	5422	Q207	BR8EIX	5044
500 WIDETRAK GT (0972061)	500	1997-	0,8	BR8ES	5422	Q207	BR8EIX	5044
500 WIDETRAK GT EUROPEAN (E942061)	500	1994-	0,8	BR8ES	5422	Q207	BR8EIX	5044
500 WIDETRAK GT EUROPEAN (E952061)	500	1995-	0,8	BR8ES	5422	Q207	BR8EIX	5044
500 WIDETRAK GT EUROPEAN (E972061)	500	1997-	0,8	BR8ES	5422	Q207	BR8EIX	5044
500 WIDETRAK LX (0942064)	500	1994-	0,8	BR8ES	5422	Q207	BR8EIX	5044
500 WIDETRAK LX (0952064)	500	1995-	0,8	BR8ES	5422	Q207	BR8EIX	5044
500 WIDETRAK LX (0962065)	500	1996-	0,8	BR8ES	5422	Q207	BR8EIX	5044
500 WIDETRAK LX (0972065)	500	1997-	0,8	BR8ES	5422	Q207	BR8EIX	5044
500 WIDETRAK LX (0982065)	500	1998-	0,8	BR8ES	5422	Q207	BR8EIX	5044
500 WIDETRAK LX (099SU4BS)	500	1999-	0,8	BR8ES	5422	Q207	BR8EIX	5044
500 WIDETRAK LX (S00SU4BS)	500	2000-2000	0,8	BR8ES	5422	Q207	BR8EIX	5044
500 WIDETRAK LX (S01SU4BS)	500	2001-	0,8	BR8ES	5422	Q207	BR8EIX	5044
500 WIDETRAK LX (S02SU4BS)	500	2002-	0,8	BR8ES	5422	Q207	BR8EIX	5044
500 WIDETRAK LX (S03SU4BS)	500	2003-	0,8	BR8ES	5422	Q207	BR8EIX	5044
500 WIDETRAK LX (S04SU4BS)	500	2004-	0,8	BR8ES	5422	Q207	BR8EIX	5044
500 WIDETRAK LX (S05SU4BS)	500	2005-	0,8	BR8ES	5422	Q207	BR8EIX	5044
500 WIDETRAK LX	500	2006-2007	0,8	BR8ES	5422	Q207	BR8EIX	5044
500 WIDETRAK LX EUROPEAN (E952064)	500	1995-	0,8	BR8ES	5422	Q207	BR8EIX	5044
500 WIDETRAK LX EUROPEAN (E962065)	500	1996-	0,8	BR8ES	5422	Q207	BR8EIX	5044
500 WIDETRAK LX EUROPEAN (E972065)	500	1997-	0,8	BR8ES	5422	Q207	BR8EIX	5044
500 WIDETRAK LX EUROPEAN (E982065)	500	1998-	0,8	BR8ES	5422	Q207	BR8EIX	5044
500 WIDETRAK LX EURO (E01SU4BU)	500	2000-2000	0,8	BR8ES	5422	Q207	BR8EIX	5044
500 WIDETRAK LX EURO (S02SU4BE)	500	2002-	0,8	BR8ES	5422	Q207	BR8EIX	5044
500 WIDETRAK NOR (N902064)	500	1990-	0,7	BR9ES	5722	Q208	BR9EIX	3981
500 WIDETRAK SWE (S902064)	500	1990-	0,7	BR9ES	5722	Q208	BR9EIX	3981
500 XC (099SB5AS)	500	1999-	0,7	BR9ES	5722	Q208	BR9EIX	3981
500 XC (S00SB5AS)	500	2000-2000	0,7	BR9ES	5722	Q208	BR9EIX	3981
500 XC (S01NP5AS)	500	2001-	0,6	BR10EG	3830	-	-	-
500 XC (S02NP5AS)	500	2002-	0,6	BR10EG	3830	-	-	-
500 XC EDGE (S03NP5AS)	500	2003-	0,6	BR10EG	3830	-	-	-
500 XC EDGE F/O (S03NP5CS)	500	2003-	0,6	BR10EG	3830	-	-	-
500 XC SP (099SP5AS)	500	1999-	0,7	BR9ES	5722	Q208	BR9EIX	3981
500 XC SP (S00SP5CS)	500	2000-2000	0,6	BR10EG	3830	-	-	-
500 XC SP (S01NP5CS)	500	2001-	0,6	BR10EG	3830	-	-	-
500 XC SP (S01NP5CSA)	500	2001-	0,6	BR10EG	3830	-	-	-
500 XC SP (S01NP5CSB)	500	2001-	0,6	BR10EG	3830	-	-	-
500 XC SP (S02NP5CSA)	500	2002-	0,6	BR10EG	3830	-	-	-

* Bitte Elektrodenabstand nach Angaben des Herstellers justieren

* Please adjust the groundelectrode gap

* Veuillez vérifier l' écartement

* Por favor, ajustar distancia entre electrodos

* regolare il gap



Stock-No

Quick-No



Stock-No IX

POLARIS

500 XC SP (S02NP5CSB)	500	2002-	0,6	BR10EG	3830	-	-	-
500 XC SP	500	2007-	0,6	BR10EG	3830	-	-	-
500 XC SP EDGE (S03NP5CSA/B)	500	2003-	0,6	BR10EG	3830	-	-	-
500 XC SP EDGE STOCK B	500	2006-	0,6	BR10EG	3830	-	-	-
500 XC SP EDGE M-10 F/O (S03NE5CS)	500	2003-	0,6	BR10EG	3830	-	-	-
500 XC SP EDGE M-10 F/O (S03NF5CS)	500	2003-	0,6	BR10EG	3830	-	-	-
500 XC SP EDGE X F/O (S03NA5CS)	500	2003-	0,6	BR10EG	3830	-	-	-
500 XC SP EDGE/M-10 (S04NP5CS)	500	2004-	0,6	BR10EG	3830	-	-	-
500 XC SP EDGE/M-10 (S05NE5CS)	500	2005-	0,6	BR10EG	3830	-	-	-
500 XC SP F/O (S02NP5CS)	500	2002-	0,6	BR10EG	3830	-	-	-
500 XC SP M-10 F/O BUILT AFTER 3/1/01 (S02NE5CS)	500	2002-	0,6	BR10EG	3830	-	-	-
EC51PL	500	-	0,7	BR9ES	3194	Q208	BR9EIX	3981
EC51PL-01	500	-	0,7	BR9ES	3194	Q208	BR9EIX	3981
EC51PL-02	500	-	0,5	BR9ES	5722	Q208	BR9EIX	3981
EC51PS	500	-	0,5	B10ES	7928	-	BR10EIX	6801
EC51PT	500	-	0,5	B9ES	2611	Q202	BR9EIX	3981
EC51PT-04	500	-	0,5	B8ES	2411	Q201	BR8EIX	5044
EC54P	530	-	0,5	B8ES	2411	Q201	BR8EIX	5044
EC54PM	530	-	0,7	BR8ES	3961	Q207	BR8EIX	5044
EC60PL-01	530	-	0,5	BR9ES	5722	Q208	BR9EIX	3981
EC60PL-02	530	-	0,6	BR9ES	5722	Q208	BR9EIX	3981
550 Indy / ES / INTL	550	2014-	0,7	BR9ES	5722	Q208	BR9EIX	3981
550 Indy 144 / ES	550	2014-	0,7	BR9ES	5722	Q208	BR9EIX	3981
550 Indy Adventure / INTL	550	2014-	0,7	BR9ES	5722	Q208	BR9EIX	3981
550 Indy LXT	550	2014-	0,7	BR9ES	5722	Q208	BR9EIX	3981
550 Indy Voyager / INTL	550	2014-	0,7	BR9ES	5722	Q208	BR9EIX	3981
550 IQ LXT / INTL	550	2011-2013	0,7	BR9ES	5722	Q208	BR9EIX	3981
550 IQ Shift / ES / INTL	550	2010-2013	0,7	BR9ES	5722	Q208	BR9EIX	3981
550 IQ Shift / EURO	550	2009-	0,7	BR9ES	5722	Q208	BR9EIX	3981
TRAIL RMK	550	2007-	0,7	BR9ES	5722	Q208	BR9EIX	3981
TRAIL RMK (099SR5BS)	550	1999-	0,8	BR8ES	5422	Q207	BR8EIX	5044
TRAIL RMK (S00SR5BS)	550	2000-2000	0,7	BR9ES	5722	Q208	BR9EIX	3981
TRAIL RMK (S01SR5BS)	550	2001-	0,7	BR9ES	5722	Q208	BR9EIX	3981
TRAIL RMK (S03SR5BS)	550	2003-	0,7	BR9ES	5722	Q208	BR9EIX	3981
TRAIL RMK (S04NJ5BS/A)	550	2004-	0,7	BR9ES	5722	Q208	BR9EIX	3981
TRAIL RMK / ES	550	2010-	0,7	BR9ES	5722	Q208	BR9EIX	3981
TRAIL RMK 136 (S02SR5BS)	550	2002-	0,7	BR9ES	5722	Q208	BR9EIX	3981
TRAIL RMK 136 F/O (S05NJ5BS/A)	550	2005-	0,7	BR9ES	5722	Q208	BR9EIX	3981
TRAIL RMK 136 STOCK A	550	2006-	0,7	BR9ES	5722	Q208	BR9EIX	3981
TRAIL RMK/FLEET/ES/EURO	550	2009-	0,7	BR9ES	5722	Q208	BR9EIX	3981
TRAIL RMK/FLEET/EURO	550	2008-	0,7	BR9ES	5722	Q208	BR9EIX	3981
TRAIL TOURING (S00ST5BS)	550	2000-2000	0,7	BR9ES	5722	Q208	BR9EIX	3981
TRAIL TOURING (S03ST5BS)	550	2003-	0,7	BR9ES	5722	Q208	BR9EIX	3981
TRAIL TOURING DELUXE	550	2007-	0,7	BR9ES	5722	Q208	BR9EIX	3981
TRAIL TOURING/FLEET/EURO	550	2008-	0,7	BR9ES	5722	Q208	BR9EIX	3981
TRAIL TOURING/FLEET/TRANSPORT/EURO	550	2009-	0,7	BR9ES	5722	Q208	BR9EIX	3981
550 CLASSIC	550	2006-	0,7	BR9ES	5722	Q208	BR9EIX	3981
550 CLASSIC (S05ND5BS)	550	2002-	0,7	BR9ES	5722	Q208	BR9EIX	3981
550 CLASSIC EDGE (S03ND5BS)	550	2003-	0,7	BR9ES	5722	Q208	BR9EIX	3981
550 CLASSIC EDGE (S04ND5BS)	550	2004-	0,7	BR9ES	5722	Q208	BR9EIX	3981
550 EDGE LX	550	2007-	0,7	BR9ES	5722	Q208	BR9EIX	3981
550 F/C CLASSIC (S02ND5BS)	550	2002-	0,7	BR9ES	5722	Q208	BR9EIX	3981

* Bitte Elektrodenabstand nach Angaben des Herstellers justieren

* Please adjust the groundelectrode gap

* Veuillez vérifier l' écartement

* Por favor, ajustar distancia entre electrodos

* regolare il gap



Stock-№

Quick-№



Stock-№ IX

POLARIS

550 LX	550	2008-	0,7	BR9ES	5722	Q208	BR9EIX	3981
550 Shift 136 / ES / CND ES / CND ES INTL	550	2011-2013	0,7	BR9ES	5722	Q208	BR9EIX	3981
SPORT TOURING EURO (E00SD5BU)	550	2000-2000	0,7	BR9ES	5722	Q208	BR9EIX	3981
SPORT TOURING EURO (S01SD5BU)	550	2001-	0,7	BR9ES	5722	Q208	BR9EIX	3981
SPORT TOURING (S00SD5BS)	550	2000-2000	0,7	BR9ES	5722	Q208	BR9EIX	3981
SPORT TOURING (S01SD5BS)	550	2001-	0,7	BR9ES	5722	Q208	BR9EIX	3981
SPORT TOURING (S02SU5BS)	550	2002-	0,7	BR9ES	5722	Q208	BR9EIX	3981
SPORT TOURING (S03SU5BS)	550	2003-	0,7	BR9ES	5722	Q208	BR9EIX	3981
SPORT TOURING (S03SU5BSA)	550	2003-	0,7	BR9ES	5722	Q208	BR9EIX	3981
SPORT TOURING ES (S01ST5BS)	550	2001-	0,7	BR9ES	5722	Q208	BR9EIX	3981
SPORT TOURING ES EURO (S02SD5BE)	550	2002-	0,7	BR9ES	5722	Q208	BR9EIX	3981
SPORT TOURING/INT'L (S04NU5BS/BE)	550	2004-	0,7	BR9ES	5722	Q208	BR9EIX	3981
SUPERSPORT	550	2006-	0,7	BR9ES	5722	Q208	BR9EIX	3981
SUPERSPORT (099SB5BS)	550	1999-	0,8	BR8ES	5422	Q207	BR8EIX	5044
SUPERSPORT (S00SB5BS)	550	2000-2000	0,7	BR9ES	5722	Q208	BR9EIX	3981
SUPERSPORT (S00SB5BSA)	550	2000-2000	0,7	BR9ES	5722	Q208	BR9EIX	3981
SUPERSPORT (S02NB5BS)	550	2002-	0,7	BR9ES	5722	Q208	BR9EIX	3981
SUPERSPORT (S05NP5BS)	550	2005-	0,7	BR9ES	5722	Q208	BR9EIX	3981
SUPERSPORT EDGE (S01NB5BS)	550	2001-	0,7	BR9ES	5722	Q208	BR9EIX	3981
SUPERSPORT EDGE (S01NB5BSA)	550	2001-	0,7	BR9ES	5722	Q208	BR9EIX	3981
SUPERSPORT EDGE (S03NB5BS/A)	550	2003-	0,7	BR9ES	5722	Q208	BR9EIX	3981
SUPERSPORT EDGE (S04NP5BS/A/B)	550	2004-	0,7	BR9ES	5722	Q208	BR9EIX	3981
SUPERSPORT EDGE X F/O (S03NA5BS)	550	2003-	0,7	BR9ES	5722	Q208	BR9EIX	3981
SUPERSPORT/EURO	550	2007-2008	0,7	BR9ES	5722	Q208	BR9EIX	3981
SUPERSPORT M-10 F/O (S03NE5BS)	550	2003-	0,7	BR9ES	5722	Q208	BR9EIX	3981
SUPERSPORT M-10 X F/O (S03NF5BS)	550	2003-	0,7	BR9ES	5722	Q208	BR9EIX	3981
TRAIL SKS EURO (099SS5BU)	550	1999-	0,8	BR8ES	5422	Q207	BR8EIX	5044
TRAIL SKS EURO (E99SS5BU)	550	1999-	0,8	BR8ES	5422	Q207	BR8EIX	5044
TRAIL TOURING	550	2006-	0,7	BR9ES	5722	Q208	BR9EIX	3981
TRAIL TOURING (S02ST5BS)	550	2002-	0,7	BR9ES	5722	Q208	BR9EIX	3981
TRAIL TOURING/EURO (S05NU5BS)	550	2005-	0,7	BR9ES	5722	Q208	BR9EIX	3981
TRAIL TOURING/INT'L (S04NT5BS/BE)	550	2004-	0,7	BR9ES	5722	Q208	BR9EIX	3981
TRAIL TOURING/INTL/FLEET	550	2010-	0,7	BR9ES	5722	Q208	BR9EIX	3981
600 Indy / SP / ES / Intl All Options	600	2013-	0,7	BPR9ES	7788	-	BPR9EIX	6853
600 Indy / SP / ES / Intl All Options	600	2014-	0,7	BPR9ES	7788	-	BPR9EIX	6853
600 INDY Voyager / Intl	600	2014-	0,7	BPR9ES	7788	-	BPR9EIX	6853
600 / IQ LX / EURO ALL OPTIONS	600	2008-	0,6	BR10EG	3830	-	-	-
600 HO IQ F/O	600	2007-	0,6	BR10EG	3830	-	-	-
600 HO IQ TOURING CLEANFIRE/EURO	600	2007-	0,6	BR10EG	3830	-	-	-
600 HO IQ/LX CLEANFIRE	600	2007-	0,6	BR10EG	3830	-	-	-
600 IQ LXT / INTL	600	2011-2014	0,6	BR10EG	3830	-	-	-
600 IQ Racer	600	2010-	0,6	BR10EG	3830	-	-	-
600 IQ Racer / INTL	600	2011-2014	0,6	BR10EG	3830	-	-	-
600 IQ RACER/EURO	600	2008-2009	0,6	BR10EG	3830	-	-	-
600 IQ Shift / ES / INTL	600	2010-2012	0,6	BR10EG	3830	-	-	-
600 IQ SHIFT / EURO	600	2008-2009	0,6	BR10EG	3830	-	-	-
600 IQ SHIFT 136/EURO	600	2009-	0,7	BPR9ES	7788	-	BPR9EIX	6853
600 IQ Touring / EURO	600	2008-	0,6	BR10EG	3830	-	-	-
600 IQ Touring / EURO	600	2009-	0,6	BR10EG	3830	-	-	-
600 IQ Touring / INTL	600	2010-	0,6	BR10EG	3830	-	-	-
600 IQ/ES/ES EURO	600	2009-	0,6	BR10EG	3830	-	-	-
600 Widetrack IQ / Intl	600	2010-2014	0,7	BPR9ES	7788	-	BPR9EIX	6853

* Bitte Elektrodenabstand nach Angaben des Herstellers justieren

* Please adjust the groundelectrode gap

* Veuillez vérifier L' écartement

* Por favor, ajustar distancia entre electrodos

* regolare il gap



Stock-No

Quick-No



Stock-No IX

POLARIS

600 HO RMK 144 F/O	600	2006-	0,6	BR10EG	3830	-	-	-
600 Pro RMK 155	600	2012-	0,7	BPR9ES	7788	-	BPR9EIX	6853
600 Pro RMK 155	600	2013-2014	0,7	BPR9ES	7788	-	BPR9EIX	6853
600 RMK (0980958)	600	1998-	0,7	BR9ES	5722	Q208	BR9EIX	3981
600 RMK EUROPEAN (E980958)	600	1998-	0,7	BR9ES	5722	Q208	BR9EIX	3981
600 RMK (099SR6DS)	600	1999-	0,7	BR9ES	5722	Q208	BR9EIX	3981
600 RMK (099SR6DSA)	600	1999-	0,7	BR9ES	5722	Q208	BR9EIX	3981
600 RMK (S00SR6DS)	600	2000-2000	0,6	BR10EG	3830	-	-	-
600 RMK / 144 / 155 / ES / INTL	600	2010-2011	0,6	BR10EG	3830	-	-	-
600 RMK 136 (S01SR6DS)	600	2001-	0,6	BR10EG	3830	-	-	-
600 RMK 136 (S02NJ6ES)	600	2002-	0,6	BR10EG	3830	-	-	-
600 RMK 144 (S03NK6ES)	600	2003-	0,6	BR10EG	3830	-	-	-
600 RMK 144/155	600	2007-	0,6	BR10EG	3830	-	-	-
600 RMK 144/155	600	2014-	0,7	BPR9ES	7788	-	BPR9EIX	6853
600 RMK 144/155 All Options	600	2013-	0,7	BPR9ES	7788	-	BPR9EIX	6853
600 RMK 144/ES/INTL/155/ES ALL OPTIONS	600	2012-	0,7	BPR9ES	7788	-	BPR9EIX	6853
600 RMK 144/EURO/RMK SHIFT/EURO	600	2008-	0,6	BR10EG	3830	-	-	-
600 RMK 155	600	2008-	0,6	BR10EG	3830	-	-	-
600 RMK F/O (S04NK6ES)	600	2004-	0,6	BR10EG	3830	-	-	-
600 RMK F/O (S05NK6ES)	600	2005-	0,6	BR10EG	3830	-	-	-
600 RMK SHIFT 144/155/EURO	600	2009-	0,7	BPR9ES	7788	-	BPR9EIX	6853
600 XLT RMK (0950956)	600	1995-	0,8	BR8ES	5422	Q207	BR8EIX	5044
600 XLT RMK (0960956)	600	1996-	0,8	BR8ES	5422	Q207	BR8EIX	5044
600 XLT RMK (0970956)	600	1997-	0,8	BR8ES	5422	Q207	BR8EIX	5044
600 XLT (0930767)	600	1993-	0,7	BR9ES	5722	Q208	BR9EIX	3981
600 XLT (0940756)	600	1994-	0,8	BR8ES	5422	Q207	BR8EIX	5044
600 XLT (0950756)	600	1995-	0,8	BR8ES	5422	Q207	BR8EIX	5044
600 XLT (0966756)	600	1996-	0,8	BR8ES	5422	Q207	BR8EIX	5044
600 XLT EUROPEAN (E930767)	600	1993-	0,7	BR9ES	5722	Q208	BR9EIX	3981
600 XLT EUROPEAN (E940756)	600	1994-	0,8	BR8ES	5422	Q207	BR8EIX	5044
600 XLT SKS (0930567)	600	1993-	0,7	BR9ES	5722	Q208	BR9EIX	3981
600 XLT SKS (0940567)	600	1994-	0,8	BR8ES	5422	Q207	BR8EIX	5044
600 XLT SKS (0950556)	600	1995-	0,8	BR8ES	5422	Q207	BR8EIX	5044
600 XLT SKS (0960556)	600	1996-	0,8	BR8ES	5422	Q207	BR8EIX	5044
600 XLT SKS EUROPEAN (E930567)	600	1993-	0,7	BR9ES	5722	Q208	BR9EIX	3981
600 XLT SKS EUROPEAN (E940567)	600	1994-	0,8	BR8ES	5422	Q207	BR8EIX	5044
600 XLT SKS EUROPEAN (E950556)	600	1995-	0,8	BR8ES	5422	Q207	BR8EIX	5044
600 XLT SKS EUROPEAN (0960556)	600	1996-	0,8	BR8ES	5422	Q207	BR8EIX	5044
600 XLT SP (0920767)	600	1992-	0,7	BR9ES	5722	Q208	BR9EIX	3981
600 XLT SP (0930667)	600	1993-	0,7	BR9ES	5722	Q208	BR9EIX	3981
600 XLT SP (0940667)	600	1994-	0,8	BR8ES	5422	Q207	BR8EIX	5044
600 XLT SP (0956756)	600	1995-	0,8	BR8ES	5422	Q207	BR8EIX	5044
600 XLT SP (0966676)	600	1996-	0,7	BR9ES	5722	Q208	BR9EIX	3981
600 XLT SP 48" / Stance (0956456)	600	1995-	0,8	BR8ES	5422	Q207	BR8EIX	5044
600 XLT SP EUROPEAN (E930667)	600	1993-	0,7	BR9ES	5722	Q208	BR9EIX	3981
600 XLT SP EUROPEAN (E940667)	600	1994-	0,8	BR8ES	5422	Q207	BR8EIX	5044
600 XLT SP EUROPEAN (E956756)	600	1995-	0,8	BR8ES	5422	Q207	BR8EIX	5044
600 XLT SP EUROPEAN (0966676)	600	1996-	0,7	BR9ES	5722	Q208	BR9EIX	3981
600 XLT SP LT (0956756)	600	1995-	0,8	BR8ES	5422	Q207	BR8EIX	5044
600 XLT SP XTRA (0946767)	600	1994-	0,8	BR8ES	5422	Q207	BR8EIX	5044
600 XLT TOURING (0952857)	600	1995-	0,8	BR8ES	5422	Q207	BR8EIX	5044
600 XLT TOURING (0963357)	600	1996-	0,8	BR8ES	5422	Q207	BR8EIX	5044

* Bitte Elektrodenabstand nach Angaben des Herstellers justieren

* Please adjust the groundelectrode gap

* Veuillez vérifier L' écartement

* Por favor, ajustar distancia entre electrodos

* regolare il gap



Stock-№

Quick-№



Stock-№ IX

POLARIS

600 XLT TOURING EUROPEAN (E952857)	600	1995-	0,8	BR8ES	5422	Q207	BR8EIX	5044
600 XLT TOURING EUROPEAN (E963357)	600	1996-	0,8	BR8ES	5422	Q207	BR8EIX	5044
600 RR / EURO	600	2008-2009	0,6	BR10EG	3830	-	-	-
600 Rush / ES	600	2012-	0,7	BPR9ES	7788	-	BPR9EIX	6853
600 Rush / ES	600	2013-	0,7	BPR9ES	7788	-	BPR9EIX	6853
600 Rush Pro R/ ES / Intl	600	2014-	0,7	BPR9ES	7788	-	BPR9EIX	6853
600 Rush Pro R/ ES / Intl / Retro	600	2013-	0,7	BPR9ES	7788	-	BPR9EIX	6853
600 RUSH PRO-R / ES / RETRO ALL OPTIONS	600	2011-	0,7	BPR9ES	7788	-	BPR9EIX	6853
600 RUSH PRO-R / SC / SP / ES / INTL ALL OPTIONS	600	2012-	0,7	BPR9ES	7788	-	BPR9EIX	6853
600 RUSH/ES/RETRO ES/LX/LX RETRO ALL OPTIONS	600	2011-	0,7	BPR9ES	7788	-	BPR9EIX	6853
600 SHIFT 136 / ES / INTL	600	2011-	0,6	BR10EG	3830	-	-	-
600 DRAGON SWITCHBACK ALL OPTIONS	600	2010-	0,6	BR10EG	3830	-	-	-
600 Switchback / ES	600	2011-	0,6	BR10EG	3830	-	-	-
600 Switchback / ES	600	2012-	0,7	BPR9ES	7788	-	BPR9EIX	6853
600 Switchback / ES	600	2013-	0,7	BPR9ES	7788	-	BPR9EIX	6853
600 Switchback / ES	600	2014-	0,7	BPR9ES	7788	-	BPR9EIX	6853
600 Switchback Adventure	600	2012-	0,7	BPR9ES	7788	-	BPR9EIX	6853
600 Switchback Adventure	600	2013-	0,7	BPR9ES	7788	-	BPR9EIX	6853
600 Switchback Adventure	600	2014-	0,7	BPR9ES	7788	-	BPR9EIX	6853
600 Switchback Assault All options	600	2014-	0,7	BPR9ES	7788	-	BPR9EIX	6853
600 SWITCHBACK F/O (S05NS6ES)	600	2005-	0,6	BR10EG	3830	-	-	-
600 Switchback Pro R / ES / Intl	600	2014-	0,7	BPR9ES	7788	-	BPR9EIX	6853
600 Switchback Pro R / ES / Intl / Retro	600	2013-	0,7	BPR9ES	7788	-	BPR9EIX	6853
600 Switchback Pro-R	600	2012-	0,7	BPR9ES	7788	-	BPR9EIX	6853
600 SWITCHBACK/DRAGON SWITCHBACK ALL OPTIONS	600	2008-	0,6	BR10EG	3830	-	-	-
600 SWITCHBACK/DRAGON/EURO	600	2009-	0,6	BR10EG	3830	-	-	-
600 SWITCHBACK/ES/INTL/LX/INTL ALL OPTIONS	600	2010-	0,6	BR10EG	3830	-	-	-
600 CLEANFIRE SWITCHBACK	600	2007-	0,6	BR10EG	3830	-	-	-
600 HO SWITCHBACK F/O	600	2006-2007	0,6	BR10EG	3830	-	-	-
600 SWITCHBACK (S04NS6ES)	600	2004-	0,6	BR10EG	3830	-	-	-
600 CLASSIC	600	2006-	0,6	BR10EG	3830	-	-	-
600 CLASSIC (S02ND6ES)	600	2002-	0,6	BR10EG	3830	-	-	-
600 CLASSIC (S03ND6ES)	600	2003-	0,6	BR10EG	3830	-	-	-
600 CLASSIC (S04ND6ES)	600	2004-	0,6	BR10EG	3830	-	-	-
600 CLASSIC (S05ND6ES)	600	2005-	0,6	BR10EG	3830	-	-	-
600 CLASSIC EDGE (S01ND6DS)	600	2001-	0,6	BR10EG	3830	-	-	-
600 CLASSIC TOURING (S01ST6ES)	600	2001-	0,6	BR10EG	3830	-	-	-
600 CLASSIC TOURING (S02ST6ES)	600	2002-	0,6	BR10EG	3830	-	-	-
600 CLASSIC TOURING (S02ST6ESA)	600	2002-	0,6	BR10EG	3830	-	-	-
600 CLASSIC TOURING (S03ST6ES/ESA)	600	2003-	0,6	BR10EG	3830	-	-	-
600 CLASSIC TOURING/INT'L (S04NT6ES/EE)	600	2004-	0,6	BR10EG	3830	-	-	-
600 DRAGON SP/ES EURO	600	2009-	0,6	BR10EG	3830	-	-	-
600 EDGE TOURING	600	2005-	0,6	BR10EG	3830	-	-	-
600 EDGE TOURING	600	2006-	0,6	BR10EG	3830	-	-	-
600 HO FUSION F/O	600	2006-	0,6	BR10EG	3830	-	-	-
600 PRO X (S01NX6ES)	600	2001-	0,6	BR10EG	3830	-	-	-
600 PRO X (S02NX6ES)	600	2002-	0,6	BR10EG	3830	-	-	-
600 PRO X (S03NX6ES)	600	2003-	0,6	BR10EG	3830	-	-	-
600 PRO X/PRO X2 (S04NX6ES)	600	2004-	0,6	BR10EG	3830	-	-	-
600 SKS EUROPEAN (E99SS6DU)	600	1999-	0,7	BR9ES	5722	Q208	BR9EIX	3981
600 TOURING (S00ST6ES)	600	2000-2000	0,6	BR10EG	3830	-	-	-
600 TRIUMPH (S00SB6AS)	600	2000-2000	0,7	BR9ES	5722	Q208	BR9EIX	3981

* Bitte Elektrodenabstand nach Angaben des Herstellers justieren

* Please adjust the groundelectrode gap

* Veuillez vérifier l' écartement

* Por favor, ajustar distancia entre electrodos

* regolare il gap



Stock-No

Quick-No



Stock-No IX

POLARIS

600 XC (TWIN) (0971758)	600	1996-	0,7	BR9ES	5722	Q208	BR9EIX	3981
600 XC (0971776)	600	1997-	0,7	BR9ES	5722	Q208	BR9EIX	3981
600 XC EUROPEAN (E971776)	600	1997-	0,7	BR9ES	5722	Q208	BR9EIX	3981
600 XC (0981758)	600	1998-	0,7	BR9ES	5722	Q208	BR9EIX	3981
600 XC (099SB6DS)	600	1999-	0,7	BR9ES	5722	Q208	BR9EIX	3981
600 XC DELUXE (S00SD6DS)	600	2000-2000	0,6	BR10EG	3830	-	-	-
600 XC EDGE F/O (S03NP6ES)	600	2003-	0,6	BR10EG	3830	-	-	-
600 XC SP (099SP6DS)	600	1999-	0,7	BR9ES	5722	Q208	BR9EIX	3981
600 XC SP (S01NP6ES)	600	2001-	0,6	BR10EG	3830	-	-	-
600 XC SP (S01NP6ESA)	600	2001-	0,6	BR10EG	3830	-	-	-
600 XC SP (S01NP6ESB)	600	2001-	0,6	BR10EG	3830	-	-	-
600 XC SP (S01NP6ESX)	600	2001-	0,6	BR10EG	3830	-	-	-
600 XC SP (S02NP6ESA)	600	2002-	0,6	BR10EG	3830	-	-	-
600 XC SP (S02NP6ESB)	600	2002-	0,6	BR10EG	3830	-	-	-
600 XC SP EDGE (S00NP6ES)	600	2000-2000	0,6	BR10EG	3830	-	-	-
600 XC SP EDGE (S03NP6ESA/B)	600	2003-	0,6	BR10EG	3830	-	-	-
600 XC SP EDGE M-10 F/O (S03NE6ES)	600	2003-	0,6	BR10EG	3830	-	-	-
600 XC SP EDGE M-10 F/O (S03NF6ES)	600	2003-	0,6	BR10EG	3830	-	-	-
600 XC SP EDGE X F/O (S03NA6ES)	600	2003-	0,6	BR10EG	3830	-	-	-
600 XC SP EDGE/M-10 (S04NP5CS)	600	2004-	0,6	BR10EG	3830	-	-	-
600 XC SP EDGE/M-10 (S05NE5CS)	600	2005-	0,6	BR10EG	3830	-	-	-
600 XC SP (EV) (S00SP6ES)	600	2000-2000	0,6	BR10EG	3830	-	-	-
600 XC SP F/O (S02NP6ES)	600	2002-	0,6	BR10EG	3830	-	-	-
600 XC SP M-10 F/O (S02NE6ES)	600	2002-	0,6	BR10EG	3830	-	-	-
600 XCR (0941667)	600	1994-	0,7	BR9ES	5722	Q208	BR9EIX	3981
600 XCR (0951676)	600	1995-	0,7	BR9ES	5722	Q208	BR9EIX	3981
600 XCR (0961676)	600	1996-	0,7	BR9ES	5722	Q208	BR9EIX	3981
600 XCR EUROPEAN (E961676)	600	1996-	0,7	BR9ES	5722	Q208	BR9EIX	3981
600 XCR (0965677)	600	1996-	0,7	BR9ES	5722	Q208	BR9EIX	3981
600 XCR EUROPEAN (E965677)	600	1996-	0,7	BR9ES	5722	Q208	BR9EIX	3981
600 XCR (0975677)	600	1997-	0,7	BR9ES	5722	Q208	BR9EIX	3981
600 XCR SE (H975677)	600	1997-	0,7	BR9ES	5722	Q208	BR9EIX	3981
600 XCR SE EUROPEAN (E975677)	600	1997-	0,7	BR9ES	5722	Q208	BR9EIX	3981
600 XCR (0985677)	600	1998-	0,7	BR9ES	5722	Q208	BR9EIX	3981
600 XLT (0970756)	600	1997-	0,8	BR8ES	5422	Q207	BR8EIX	5044
600 XLT SKS (0970556)	600	1997-	0,8	BR8ES	5422	Q207	BR8EIX	5044
600 XLT CLASSIC (0983857)	600	1998-	0,7	BR9ES	5722	Q208	BR9EIX	3981
600 XLT CLASSIC (099ED6AS)	600	1999-	0,8	BR8ES	5422	Q207	BR8EIX	5044
600 XLT LTD (0973756)	600	1997-	0,8	BR8ES	5422	Q207	BR8EIX	5044
600 XLT LTD EUROPEAN (E973756)	600	1997-	0,8	BR8ES	5422	Q207	BR8EIX	5044
600 XLT LTD (0983756)	600	1998-	0,8	BR8ES	5422	Q207	BR8EIX	5044
600 XLT LTD SP (0973776)	600	1997-	0,7	BR9ES	5722	Q208	BR9EIX	3981
600 XLT SP (0976676)	600	1997-	0,8	BR8ES	5422	Q207	BR8EIX	5044
600 XLT SP (0985776)	600	1998-	0,7	BR9ES	5722	Q208	BR9EIX	3981
600 XLT SP (099AB6AS)	600	1999-	0,7	BR9ES	5722	Q208	BR9EIX	3981
600 XLT TOURING (0973357)	600	1997-	0,8	BR8ES	5422	Q207	BR8EIX	5044
600 XLT TOURING (0983357)	600	1998-	0,8	BR8ES	5422	Q207	BR8EIX	5044
600 XLT TOURING (099ET6AS)	600	1999-	0,8	BR8ES	5422	Q207	BR8EIX	5044
600 XLT TOURING (099ET6ASA)	600	1999-	0,8	BR8ES	5422	Q207	BR8EIX	5044
600 XLT TOURING EUROPEAN (E973357)	600	1997-	0,8	BR8ES	5422	Q207	BR8EIX	5044
650 (0900758)	650	1990-	0,7	BR9ES	5722	Q208	BR9EIX	3981
650 (0910758)	650	1991-	0,7	BR9ES	5722	Q208	BR9EIX	3981

* Bitte Elektrodenabstand nach Angaben des Herstellers justieren

* Please adjust the groundelectrode gap

* Veuillez vérifier L' écartement

* Por favor, ajustar distancia entre electrodos

* regolare il gap



Stock-No

Quick-No



Stock-No IX

POLARIS

650 (0920758)	650	1992-1994	0,7	BR9ES	5722	Q208	BR9EIX	3981
650 FIN (F900758)	650	1990-	0,7	BR9ES	5722	Q208	BR9EIX	3981
650 NOR (N900758)	650	1990-	0,7	BR9ES	5722	Q208	BR9EIX	3981
650 RXL (0900768)	650	1990-	0,7	BR9ES	5722	Q208	BR9EIX	3981
650 RXL (0910768)	650	1991-	0,7	BR9ES	5722	Q208	BR9EIX	3981
650 RXL (0920768)	650	1992-	0,7	BR9ES	5722	Q208	BR9EIX	3981
650 RXL (0930768)	650	1993-	0,7	BR9ES	5722	Q208	BR9EIX	3981
650 RXL (0940768)	650	1994-	0,7	BR9ES	5722	Q208	BR9EIX	3981
650 RXL (0956168)	650	1995-	0,7	BR9ES	5722	Q208	BR9EIX	3981
650 RXL (0966768)	650	1996-	0,7	BR9ES	5722	Q208	BR9EIX	3981
650 RXL (0976768)	650	1997-	0,7	BR9ES	5722	Q208	BR9EIX	3981
650 RXL EUROPEAN (E930768)	650	1993-	0,7	BR9ES	5722	Q208	BR9EIX	3981
650 RXL LT (0956768)	650	1995-	0,7	BR9ES	5722	Q208	BR9EIX	3981
650 RXL SKS (0910568)	650	1991-	0,7	BR9ES	5722	Q208	BR9EIX	3981
650 RXL SKS (0920568)	650	1992-	0,7	BR9ES	5722	Q208	BR9EIX	3981
650 RXL SKS (0930568)	650	1993-	0,7	BR9ES	5722	Q208	BR9EIX	3981
650 RXL SKS EUROPEAN (E930568)	650	1993-	0,7	BR9ES	5722	Q208	BR9EIX	3981
650 RXL SKS FINLAND (F920568)	650	1992-	0,7	BR9ES	5722	Q208	BR9EIX	3981
650 RXL SKS SWE (S910568)	650	1991-	0,7	BR9ES	5722	Q208	BR9EIX	3981
650 RXL SKS SWE (S920568)	650	1992-	0,7	BR9ES	5722	Q208	BR9EIX	3981
650 RXL SWE (S910768)	650	1991-	0,7	BR9ES	5722	Q208	BR9EIX	3981
650 RXL SWE (S920768)	650	1992-	0,7	BR9ES	5722	Q208	BR9EIX	3981
650 RXL TOURING (0940869)	650	1994-	0,7	BR9ES	5722	Q208	BR9EIX	3981
650 RXL TOURING (0950869)	650	1995-	0,7	BR9ES	5722	Q208	BR9EIX	3981
650 RXL TOURING EUROPEAN (E940869)	650	1994-	0,7	BR9ES	5722	Q208	BR9EIX	3981
650 SKS (0900558)	650	1990-	0,7	BR9ES	5722	Q208	BR9EIX	3981
650 SKS FIN (F900558)	650	1990-	0,7	BR9ES	5722	Q208	BR9EIX	3981
650 SKS NOR (N900558)	650	1990-	0,7	BR9ES	5722	Q208	BR9EIX	3981
650 SKS SWE (S900558)	650	1990-	0,7	BR9ES	5722	Q208	BR9EIX	3981
650 SWE (S910758)	650	1991-	0,7	BR9ES	5722	Q208	BR9EIX	3981
650 SWE (S920758)	650	1992-	0,7	BR9ES	5722	Q208	BR9EIX	3981
EC66PL-01	679	-	0,7	BR8ES	5422	Q207	BR8EIX	5044
EC66PL-04	679	-	0,7	BR8ES	5422	Q207	BR8EIX	5044
EC68PL-01/03/04	679	-	0,7	BR9ES	5722	Q208	BR9EIX	3981
Indy Ultra	679	1996-1998	0,7	BR9ES	3194	Q208	BR9EIX	3981
Indy XCR	679	1998-	0,7	BR9ES	3194	Q208	BR9EIX	3981
700 IQ / DRAGON	700	2008-	0,6	BR10EG	3830	-	-	-
700 EDGE RMK CC BUILT BEFORE 1/01/02 (S03NS7CS)	700	2003-	0,6	BR10EG	3830	-	-	-
700 RMK	700	2006-	0,6	BR10EG	3830	-	-	-
700 RMK (0970966)	700	1997-	0,7	BR9ES	5722	Q208	BR9EIX	3981
700 RMK (0980966)	700	1998-	0,7	BR9ES	5722	Q208	BR9EIX	3981
700 RMK EUROPEAN (E980966)	700	1998-	0,7	BR9ES	5722	Q208	BR9EIX	3981
700 RMK (099SR7AS)	700	1999-	0,7	BR9ES	5722	Q208	BR9EIX	3981
700 RMK (099SR7ASA)	700	1999-	0,7	BR9ES	5722	Q208	BR9EIX	3981
700 RMK (S00SR7AS)	700	2000-2000	0,6	BR10EG	3830	-	-	-
700 RMK (S00SR7ASA)	700	2000-2000	0,6	BR10EG	3830	-	-	-
700 RMK 136 (S01SR7AS)	700	2001-	0,6	BR10EG	3830	-	-	-
700 RMK 136 (S02NJ7CS)	700	2002-	0,6	BR10EG	3830	-	-	-
700 RMK 136 STOCK (S02NJ7CSA)	700	2002-	0,6	BR10EG	3830	-	-	-
700 RMK 144 (S01SM7AS)	700	2001-	0,6	BR10EG	3830	-	-	-
700 RMK 144 F/O (S02NK7CS, CSA)	700	2002-	0,6	BR10EG	3830	-	-	-
700 RMK 144 F/O (S03NK7CS)	700	2003-	0,6	BR10EG	3830	-	-	-

* Bitte Elektrodenabstand nach Angaben des Herstellers justieren

* Please adjust the groundelectrode gap

* Veuillez vérifier L' écartement

* Por favor, ajustar distancia entre electrodos

* regolare il gap



Stock-No

Quick-No



Stock-No IX

POLARIS

700 RMK 144 STOCK (S02NK7CSA)	700	2002-	0,6	BR10EG	3830	-	-	-
700 RMK 144 STOCK (S03NK7CSA)	700	2003-	0,6	BR10EG	3830	-	-	-
700 RMK 151 F/O (S02NL7CS)	700	2002-	0,6	BR10EG	3830	-	-	-
700 RMK 151 F/O (S03NL7CS)	700	2003-	0,6	BR10EG	3830	-	-	-
700 RMK 151 STOCK (S03NL7CSA)	700	2003-	0,6	BR10EG	3830	-	-	-
700 RMK 155/163 ALL OPTIONS	700	2008-	0,6	BR10EG	3830	-	-	-
700 RMK 155/ES	700	2009-	0,6	BR10EG	3830	-	-	-
700 RMK EARLY PROD	700	2008-	0,6	BR10EG	3830	-	-	-
700 RMK F/O (S04NK6ES)	700	2004-	0,6	BR10EG	3830	-	-	-
700 RMK F/O (S05NK6ES)	700	2005-	0,6	BR10EG	3830	-	-	-
700 SWITCHBACK/Dragon SWITCHBACK ALL OPTIONS	700	2008-	0,6	BR10EG	3830	-	-	-
700 SWITCHBACK (S04NS6ES)	700	2004-	0,6	BR10EG	3830	-	-	-
700 CLASSIC (S01SD7AS)	700	2001-	0,6	BR10EG	3830	-	-	-
700 CLASSIC (S02ND7CS)	700	2002-	0,6	BR10EG	3830	-	-	-
700 CLASSIC (S03ND7CS)	700	2003-	0,6	BR10EG	3830	-	-	-
700 CLASSIC	700	2006-	0,6	BR10EG	3830	-	-	-
700 CLASSIC (S04ND7CS)	700	2004-	0,6	BR10EG	3830	-	-	-
700 CLASSIC TOURING (S03NT7CS)	700	2003-	0,6	BR10EG	3830	-	-	-
700 CLASSIC TOURING/INT'L (S04NT6ES/EE)	700	2004-	0,6	BR10EG	3830	-	-	-
700 CLEANFIRE DRAGON/EURO	700	2007-	0,6	BR10EG	3830	-	-	-
700 FUSION F/O	700	2006-	0,6	BR10EG	3830	-	-	-
700 HO TOURING	700	2006-	0,6	BR10EG	3830	-	-	-
700 PRO X (S03NX7CS)	700	2003-	0,6	BR10EG	3830	-	-	-
700 PRO X/PRO X2 (S04NX6ES)	700	2004-	0,6	BR10EG	3830	-	-	-
700 SKS (0970566)	700	1997-	0,7	BR9ES	5722	Q208	BR9EIX	3981
700 SKS EUROPEAN (E970566)	700	1997-	0,7	BR9ES	5722	Q208	BR9EIX	3981
700 SKS EUROPEAN (E99SS7AU)	700	1999-	0,7	BR9ES	5722	Q208	BR9EIX	3981
700 SKS (099SS7AS)	700	1999-	0,7	BR9ES	5722	Q208	BR9EIX	3981
700 SKS (E00SS7AU)	700	2000-2000	0,6	BR10EG	3830	-	-	-
700 SKS (E01SS7AU)	700	2000-2000	0,6	BR10EG	3830	-	-	-
700 SKS (S00SS7AS)	700	2000-2000	0,6	BR10EG	3830	-	-	-
700 SKS (S01SS7AS)	700	2001-	0,6	BR10EG	3830	-	-	-
700 SKS (S02NS7CS)	700	2002-	0,6	BR10EG	3830	-	-	-
700 SKS (S03NS7CS/A)	700	2003-	0,6	BR10EG	3830	-	-	-
700 SKS EURO (S02SS7CE)	700	2002-	0,6	BR10EG	3830	-	-	-
700 ULTRA (0976778)	700	1997-	0,7	BR9ES	5722	Q208	BR9EIX	3981
700 ULTRA (0986778)	700	1998-	0,7	BR9ES	5722	Q208	BR9EIX	3981
700 ULTRA RMK (0960978)	700	1996-	0,7	BR9ES	5722	Q208	BR9EIX	3981
700 ULTRA SKS (0966778)	700	1996-	0,7	BR9ES	5722	Q208	BR9EIX	3981
700 ULTRA SKS EUROPEAN (E966778)	700	1996-	0,7	BR9ES	5722	Q208	BR9EIX	3981
700 ULTRA SP (0960678)	700	1996-	0,7	BR9ES	5722	Q208	BR9EIX	3981
700 ULTRA SP (0970678)	700	1997-	0,7	BR9ES	5722	Q208	BR9EIX	3981
700 ULTRA SP EUROPEAN (E960678)	700	1996-	0,7	BR9ES	5722	Q208	BR9EIX	3981
700 ULTRA SPX (0975678)	700	1997-	0,7	BR9ES	5722	Q208	BR9EIX	3981
700 ULTRA SPX SE (H975678)	700	1997-	0,7	BR9ES	5722	Q208	BR9EIX	3981
700 ULTRA SPX SE EUROPEAN (E975678)	700	1997-	0,7	BR9ES	5722	Q208	BR9EIX	3981
700 ULTRA TOURING (0975378)	700	1997-	0,7	BR9ES	5722	Q208	BR9EIX	3981
700 ULTRA TOURING (0985378)	700	1998-	0,7	BR9ES	5722	Q208	BR9EIX	3981
700 ULTRA TOURING EUROPEAN (E975378)	700	1997-	0,7	BR9ES	5722	Q208	BR9EIX	3981
700 ULTRA TOURING EUROPEAN (E985378)	700	1998-	0,7	BR9ES	5722	Q208	BR9EIX	3981
700 XC (0971766)	700	1997-	0,7	BR9ES	5722	Q208	BR9EIX	3981
700 XC (0981766)	700	1998-	0,7	BR9ES	5722	Q208	BR9EIX	3981

* Bitte Elektrodenabstand nach Angaben des Herstellers justieren

* Please adjust the groundelectrode gap

* Veuillez vérifier l' écartement

* Por favor, ajustar distancia entre electrodos

* regolare il gap



Stock-№

Quick-№



Stock-№ IX

POLARIS

700 XC EUROPEAN (E981766)	700	1998-	0,7	BR9ES	5722	Q208	BR9EIX	3981
700 XC (099SB7AS)	700	1999-	0,7	BR9ES	5722	Q208	BR9EIX	3981
700 XC DELUXE (S00SD7AS)	700	2000-2000	0,6	BR10EG	3830	-	-	-
700 XC EDGE F/O (S03NP7CS)	700	2003-	0,6	BR10EG	3830	-	-	-
700 XC EDGE F/O (S04NP7CS)	700	2004-	0,6	BR10EG	3830	-	-	-
700 XC SP (099SP7AS)	700	1999-	0,7	BR9ES	5722	Q208	BR9EIX	3981
700 XC SP (S00SP7AS)	700	2000-2000	0,6	BR10EG	3830	-	-	-
700 XC SP (S01NP7AS)	700	2001-	0,6	BR10EG	3830	-	-	-
700 XC SP (S01NP7ASA)	700	2001-	0,6	BR10EG	3830	-	-	-
700 XC SP (S01NP7ASB)	700	2001-	0,6	BR10EG	3830	-	-	-
700 XC SP (S02NP7CSA)	700	2002-	0,6	BR10EG	3830	-	-	-
700 XC SP (S02NP7CSB)	700	2002-	0,6	BR10EG	3830	-	-	-
700 XC SP EDGE (S03NP7CSA/B)	700	2003-	0,6	BR10EG	3830	-	-	-
700 XC SP EDGE EV (S01NP7CS)	700	2001-	0,6	BR10EG	3830	-	-	-
700 XC SP EDGE M-10 F/O (S03NE7CS)	700	2003-	0,6	BR10EG	3830	-	-	-
700 XC SP EDGE M-10 F/O (S03NF7CS)	700	2003-	0,6	BR10EG	3830	-	-	-
700 XC SP EDGE X F/O (S03NA7CS)	700	2003-	0,6	BR10EG	3830	-	-	-
700 XC SP F/O (S02NP7CS)	700	2002-	0,6	BR10EG	3830	-	-	-
700 XC SP M-10 F/O (S02NE7CS)	700	2002-	0,6	BR10EG	3830	-	-	-
700 XC SP M-10 F/O	700	2005-	0,6	BR10EG	3830	-	-	-
700 XCR (0985678)	700	1998-	0,7	BR9ES	5722	Q208	BR9EIX	3981
700 XCR EUROPEAN (E985678)	700	1998-	0,7	BR9ES	5722	Q208	BR9EIX	3981
700 XCR (0985678A)	700	1998-	0,7	BR9ES	5722	Q208	BR9EIX	3981
700 XCR EUROPEAN (E985678)	700	1998-	0,7	BR9ES	5722	Q208	BR9EIX	3981
700 XCR (099AB7BS)	700	1999-	0,7	BR9ES	5722	Q208	BR9EIX	3981
SN70LCDSP-01/02	701	-	0,7	BR9ES	5722	Q208	BR9EIX	3981
EC74P	744	-	0,5	B7ES	1111	-	-	-
EC74P	744	-	0,5	B7ES	1111	-	-	-
FS IQ TOURING/EURO	750	2007-2009	0,7	BKR7E	6097	-	BKR7EIX	2667
FST IQ TOURING	750	2007-	0,9	PFR7G-9	4371	-	-	-
800 Indy SP / ES / Intl All options	800	2014-	0,7	BPR9ES	7788	-	BPR9EIX	6853
800 DRAGON IQ/ES/INTL ALL OPTIONS	800	2010-	0,6	BR10EG	3830	-	-	-
800 IQ / ES	800	2009-2010	0,6	BR10EG	3830	-	-	-
800 DRAGON RMK 155 SPECIAL LATE PROD	800	2008-	0,6	BR10EG	3830	-	-	-
800 DRAGON RMK 155/163 ALL OPTIONS	800	2010-	0,6	BR10EG	3830	-	-	-
800 DRAGON RMK 155/163/ES/EURO ALL OPTIONS	800	2009-	0,6	BR10EG	3830	-	-	-
800 DRAGON RMK 155/163/EURO	800	2008-	0,6	BR10EG	3830	-	-	-
800 Pro RMK / 155 / 163 All Options	800	2012-	0,7	BPR9ES	7788	-	BPR9EIX	6853
800 Pro RMK / 155 / 163 All Options	800	2013-	0,7	BPR9ES	7788	-	BPR9EIX	6853
800 Pro RMK / LE 155 / 163 All Options	800	2014-	0,7	BPR9ES	7788	-	BPR9EIX	6853
800 PRO RMK 155/163/ES/INTL ALL OPTIONS	800	2011-	0,7	BPR9ES	7788	-	BPR9EIX	6853
800 RMK (S00SR8BS)	800	2000-2000	0,6	BR10EG	3830	-	-	-
800 RMK (S00SR8BSA)	800	2000-2000	0,6	BR10EG	3830	-	-	-
800 RMK 144 (S01SM8BS)	800	2001-	0,6	BR10EG	3830	-	-	-
800 RMK 144 F/O (S02NK8CS)	800	2002-	0,6	BR10EG	3830	-	-	-
800 RMK 144 F/O (S03NK8CS)	800	2003-	0,6	BR10EG	3830	-	-	-
800 RMK 144 F/O STOCK (S02NK8CSA)	800	2002-	0,6	BR10EG	3830	-	-	-
800 RMK 144 STOCK (S03NK8CSA)	800	2003-	0,6	BR10EG	3830	-	-	-
800 RMK 144 / 155 / ES / INTL	800	2010-	0,6	BR10EG	3830	-	-	-
800 RMK 151 (S01SM8BSA)	800	2001-	0,6	BR10EG	3830	-	-	-
800 RMK 151 F/O (S02NL8CS/CSA)	800	2002-	0,6	BR10EG	3830	-	-	-
800 RMK 151 F/O (S03NL8CS)	800	2003-	0,6	BR10EG	3830	-	-	-

* Bitte Elektrodenabstand nach Angaben des Herstellers justieren

* Please adjust the groundelectrode gap

* Veuillez vérifier L' écartement

* Por favor, ajustar distancia entre electrodos

* regolare il gap



Stock-No

Quick-No



Stock-No IX

POLARIS

800 RMK 151 STOCK (S02NL8CSA)	800	2002-	0,6	BR10EG	3830	-	-	-
800 RMK 151 STOCK (S03NL8CSA)	800	2003-	0,6	BR10EG	3830	-	-	-
800 RMK 155	800	2014-	0,7	BPR9ES	7788	-	BPR9EIX	6853
800 RMK 155/ES/INTL	800	2011-2013	0,7	BPR9ES	7788	-	BPR9EIX	6853
800 RMK 156 F/O (S02NM8CS)	800	2002-	0,6	BR10EG	3830	-	-	-
800 RMK 159 F/O (S03NM8CS)	800	2003-	0,6	BR10EG	3830	-	-	-
800 RMK 159 VERTICAL ESCAPE (S03NN8CS)	800	2003-	0,6	BR10EG	3830	-	-	-
800 RMK ASSAULT / INTL	800	2010-	0,6	BR10EG	3830	-	-	-
800 RMK ASSAULT 146	800	2009-	0,6	BR10EG	3830	-	-	-
800 RMK ASSAULT 155 ALL OPTIONS	800	2012-	0,7	BPR9ES	7788	-	BPR9EIX	6853
800 RMK ASSAULT 155/ INTL	800	2011-	0,7	BPR9ES	7788	-	BPR9EIX	6853
800 RMK ASSAULT ALL OPTIONS	800	2013-2014	0,7	BPR9ES	7788	-	BPR9EIX	6853
800 RMK F/O (S04NK6ES)	800	2004-	0,6	BR10EG	3830	-	-	-
800 RMK F/O (S05NK6ES)	800	2005-	0,6	BR10EG	3830	-	-	-
800 RMK SHIFT 144	800	2009-	0,6	BR10EG	3830	-	-	-
800 RMK SP 144 (S01SM8BSC)	800	2001-	0,6	BR10EG	3830	-	-	-
800 RMK SP 151 (S01SM8BSB)	800	2001-	0,6	BR10EG	3830	-	-	-
800 RUSH / ES	800	2009-	0,6	BR10EG	3830	-	-	-
800 RUSH / ES	800	2012-2013	0,7	BPR9ES	7788	-	BPR9EIX	6853
800 RUSH PRO R ALL OPTIONS	800	2014-	0,7	BPR9ES	7788	-	BPR9EIX	6853
800 RUSH PRO R ALL OPTIONS	800	2012-2013	0,7	BPR9ES	7788	-	BPR9EIX	6853
800 RUSH PRO-R/ES/RETRO ALL OPTIONS	800	2011-	0,7	BPR9ES	7788	-	BPR9EIX	6853
800 RUSH/ES/RETRO/RETRO LX/RETRO ES ALL OPTIONS	800	2011-	0,7	BPR9ES	7788	-	BPR9EIX	6853
800 STORM (0932770)	800	1993-	0,7	BR9ES	5722	Q208	BR9EIX	3981
800 STORM (0940782)	800	1994-	0,7	BR9ES	5722	Q208	BR9EIX	3981
800 STORM (0950782)	800	1995-	0,8	BR8ES	5422	Q207	BR8EIX	5044
800 STORM (0965782)	800	1996-	0,7	BR9ES	5722	Q208	BR9EIX	3981
800 STORM EUROPEAN (E932770)	800	1993-	0,7	BR9ES	5722	Q208	BR9EIX	3981
800 STORM EUROPEAN (E940782)	800	1994-	0,7	BR9ES	5722	Q208	BR9EIX	3981
800 STORM EUROPEAN (E950782)	800	1995-	0,8	BR8ES	5422	Q207	BR8EIX	5044
800 STORM EUROPEAN (E965782)	800	1996-	0,7	BR9ES	5722	Q208	BR9EIX	3981
800 STORM RMK (0965982)	800	1996-	0,7	BR9ES	5722	Q208	BR9EIX	3981
800 STORM SKS (0932570)	800	1993-	0,7	BR9ES	5722	Q208	BR9EIX	3981
800 STORM SKS (0940582)	800	1994-	0,7	BR9ES	5722	Q208	BR9EIX	3981
800 STORM SKS (0950582)	800	1995-	0,8	BR8ES	5422	Q207	BR8EIX	5044
800 STORM SKS (0965582)	800	1996-	0,7	BR9ES	5722	Q208	BR9EIX	3981
800 STORM SKS EUROPEAN (E932570)	800	1993-	0,7	BR9ES	5722	Q208	BR9EIX	3981
800 STORM SKS EUROPEAN (E940582)	800	1994-	0,7	BR9ES	5722	Q208	BR9EIX	3981
800 STORM SKS EUROPEAN (E950582)	800	1995-	0,8	BR8ES	5422	Q207	BR8EIX	5044
800 STORM SKS EUROPEAN (E965582)	800	1996-	0,7	BR9ES	5722	Q208	BR9EIX	3981
800 STORM SKS PDL TRK (0950982)	800	1995-	0,8	BR8ES	5422	Q207	BR8EIX	5044
800 STORM (0975782)	800	1997-	0,7	BR9ES	5722	Q208	BR9EIX	3981
800 STORM RMK (0975982)	800	1997-	0,7	BR9ES	5722	Q208	BR9EIX	3981
800 STORM SE (H975782)	800	1997-	0,7	BR9ES	5722	Q208	BR9EIX	3981
800 STORM SE EUROPEAN (E975782)	800	1997-	0,7	BR9ES	5722	Q208	BR9EIX	3981
800 STORM (0985782)	800	1998-	0,7	BR9ES	5722	Q208	BR9EIX	3981
800 DRAGON SWITCHBACK/ES/INTL ALL OPTIONS	800	2010-	0,6	BR10EG	3830	-	-	-
800 SWITCHBACK ADVENTURE	800	2014-	0,7	BPR9ES	7788	-	BPR9EIX	6853
800 SWITCHBACK ASSAULT ALL OPTIONS	800	2014-	0,7	BPR9ES	7788	-	BPR9EIX	6853
800 SWITCHBACK ASSAULT ALL OPTIONS	800	2012-2013	0,7	BPR9ES	7788	-	BPR9EIX	6853
800 SWITCHBACK ASSAULT/INTL	800	2011-	0,7	BPR9ES	7788	-	BPR9EIX	6853
800 SWITCHBACK F/O (S05NS6ES)	800	2005-	0,6	BR10EG	3830	-	-	-

* Bitte Elektrodenabstand nach Angaben des Herstellers justieren

* Please adjust the groundelectrode gap

* Veuillez vérifier L' écartement

* Por favor, ajustar distancia entre electrodos

* regolare il gap



Stock-№

Quick-№



Stock-№ IX

POLARIS

800 SWITCHBACK PRO R/ES/INT/LE ALL OPTIONS	800	2014-	0,7	BPR9ES	7788	-	BPR9EIX	6853
800 SWITCHBACK PRO-R/ES/INTL/RETRO/LE ALL OPTIONS	800	2013-	0,7	BPR9ES	7788	-	BPR9EIX	6853
800 SWITCHBACK PRO-R/ES/SC/SP/INTL ALL OPTIONS	800	2012-	0,7	BPR9ES	7788	-	BPR9EIX	6853
800 SWITCHBACK/DRAGON/EURO	800	2009-	0,6	BR10EG	3830	-	-	-
800 SWITCHBACK/ES	800	2010-	0,6	BR10EG	3830	-	-	-
800 SWITCHBACK/ES	800	2014-	0,7	BPR9ES	7788	-	BPR9EIX	6853
800 SWITCHBACK/ES	800	2012-2013	0,7	BPR9ES	7788	-	BPR9EIX	6853
800 SWITCHBACK (S04NS6ES)	800	2004-	0,6	BR10EG	3830	-	-	-
800 CLASSIC (S04ND8CS)	800	2004-	0,6	BR10EG	3830	-	-	-
800 CLASSIC TOURING (S03NT8CS)	800	2003-	0,6	BR10EG	3830	-	-	-
800 CLASSIC TOURING/INT'L (S04NT6ES/EE)	800	2004-	0,6	BR10EG	3830	-	-	-
800 DRAGON SP/ES EURO	800	2009-	0,6	BR10EG	3830	-	-	-
800 EDGE TOURING	800	2005-	0,6	BR10EG	3830	-	-	-
800 LE (S01ND8BS)	800	2001-	0,6	BR10EG	3830	-	-	-
800 PRO X (S03NX8CS)	800	2003-	0,6	BR10EG	3830	-	-	-
800 PRO X/PRO X2 (S04NX6ES)	800	2004-	0,6	BR10EG	3830	-	-	-
800 PRO XR (S04NZ8CS)	800	2004-	0,6	BR10EG	3830	-	-	-
800 SKS (S03NS8CS/A)	800	2003-	0,6	BR10EG	3830	-	-	-
800 XC EDGE F/O (S03NP8CS)	800	2003-	0,6	BR10EG	3830	-	-	-
800 XC EDGE F/O (S04NP7CS)	800	2004-	0,6	BR10EG	3830	-	-	-
800 XC SP (S01NP8BS)	800	2001-	0,6	BR10EG	3830	-	-	-
800 XC SP (S01NP8BSA)	800	2001-	0,6	BR10EG	3830	-	-	-
800 XC SP (S01NP8BSB)	800	2001-	0,6	BR10EG	3830	-	-	-
800 XC SP EDGE (S03NP8CSA/B)	800	2003-	0,6	BR10EG	3830	-	-	-
800 XC SP EDGE M-10 F/O (S03NE8CS)	800	2003-	0,6	BR10EG	3830	-	-	-
800 XC SP EDGE M-10 F/O (S03NF8CS)	800	2003-	0,6	BR10EG	3830	-	-	-
800 XC SP EDGE X F/O (S03NA8CS)	800	2003-	0,6	BR10EG	3830	-	-	-
800 XC SP F/O (S02NP8CS)	800	2002-	0,6	BR10EG	3830	-	-	-
800 XC SP M-10 F/O (S02NE8CS)	800	2002-	0,6	BR10EG	3830	-	-	-
800 XC SP M-10 F/O	800	2005-	0,6	BR10EG	3830	-	-	-
800 XC SP STOCK (S02NP8CSA)	800	2002-	0,6	BR10EG	3830	-	-	-
800 XC SP STOCK (S02NP8CSB)	800	2002-	0,6	BR10EG	3830	-	-	-
800 XCR (099AB8AS)	800	1999-	0,7	BR9ES	5722	Q208	BR9EIX	3981
800 XCR (S00SB8AS)	800	2000-2000	0,7	BR9ES	5722	Q208	BR9EIX	3981
800 XCR (S01SB8AS)	800	2001-	0,7	BR9ES	5722	Q208	BR9EIX	3981
800 XCR (S02SB8AS)	800	2002-	0,7	BR9ES	5722	Q208	BR9EIX	3981
800 XCR (S03SB8AS)	800	2003-	0,7	BR9ES	5722	Q208	BR9EIX	3981
900 RMK	900	2006-	0,6	BR10EG	3830	-	-	-
900 RMK ALL OPTIONS (S05PL8/PM8/PN8)	900	2005-	0,6	BR10EG	3830	-	-	-
900 Switchback	900	2006-	0,6	BR10EG	3830	-	-	-
900 SWITCHBACK (S05PS8DS)	900	2005-	0,6	BR10EG	3830	-	-	-
900 FUSION (S05MP8DS)	900	2005-	0,6	BR10EG	3830	-	-	-
900 FUSION F/O	900	2006-	0,6	BR10EG	3830	-	-	-
INDY FRONTIER (S02NT7DS)	-	2002-	0,7	BKR7E	6097	-	BKR7EIX	2667
FST IQ CRUISER	-	2007-	0,9	PFR7G-9	4371	-	-	-
FST IQ LX	-	2007-	0,9	PFR7G-9	4371	-	-	-
FST IQ SWITCHBACK	-	2007-	0,9	PFR7G-9	4371	-	-	-
DRAGON RMK/INTL	-	2007-	0,6	BR10EG	3830	-	-	-
FST Switchback	-	2006-	0,9	PFR7G-9	4371	-	-	-
FRONTIER CLASSIC (S04ND7DS)	-	2004-	0,7	BKR7E	6097	-	BKR7EIX	2667
FRONTIER CLASSIC BUILT BEFORE 1/01/02 (S03ND7DS)	-	2003-	0,7	BKR7E	6097	-	BKR7EIX	2667
FRONTIER TOURING (S04NT7DS)	-	2004-	0,7	BKR7E	6097	-	BKR7EIX	2667

* Bitte Elektrodenabstand nach Angaben des Herstellers justieren

* Please adjust the groundelectrode gap

* Veuillez vérifier l' écartement

* Por favor, ajustar distancia entre electrodos

* regolare il gap



Stock-No

Quick-No



Stock-No IX

POLARIS

FRONTIER TOURING (S03NT7DS)	-	2003-	0,7	BKR7E	6097	-	BKR7EIX	2667
FRONTIER TOURING (S05NT7DS/DE)	-	2005-	0,7	BKR7E	6097	-	BKR7EIX	2667
FS CLASSIC	-	2006-	0,7	BKR7E	6097	-	BKR7EIX	2667
FS TOURING	-	2006-	0,7	BKR7E	6097	-	BKR7EIX	2667
FST CLASSIC	-	2006-	0,9	PFR7G-9	4371	-	-	-
FST TOURING	-	2006-	0,9	PFR7G-9	4371	-	-	-
WIDETRAK LX	-	2010-	0,8	BR8ES	5422	Q207	BR8EIX	5044
WIDETRAK LX / EURO	-	2008-2009	0,8	BR8ES	5422	Q207	BR8EIX	5044
WIDETRAK LX / INTL	-	2011-2014	0,8	BR8ES	5422	Q207	BR8EIX	5044

SACHS

SA280, SA280A	277	-	0,5	AB-7	3010	-	-	-
SA2-290 12.7mm(1/2") Reach	291	-	0,5	B8HS	5510	Q205	BR8HIX	7001
SA2-290 19.0mm(3/4") Reach	291	-	0,5	B8ES	2411	Q201	BR8EIX	5044
SA290	293	-	0,5	AB-7	3010	-	-	-
SA290C, SA290R, SA290SS	293	-	0,5	B8HS	5510	Q205	BR8HIX	7001
KM914	300	-	0,5	B7HS	5110	Q204	BR7HIX	7067
SA320	318	-	0,5	AB-7	3010	-	-	-
SA340C, SA340R	334	-	0,5	B8HS	5510	Q205	BR8HIX	7001
SA340	336	-	0,5	AB-7	3010	-	-	-
SA340SS	336	-	0,5	AB-8	7909	-	-	-
SA2-340 12.7mm(1/2") Reach	338	-	0,5	B8HS	5510	Q205	BR8HIX	7001
SA2-340 19.0mm(3/4") Reach	338	-	0,5	B8ES	2411	Q201	BR8EIX	5044
SA2-340RX, SA2-340C	338	-	0,5	B9ES	2611	Q202	BR9EIX	3981
SA370	368	-	0,5	AB-7	3010	-	-	-
SA400	396	-	0,5	AB-8	7909	-	-	-

SKI-DOO / BOMBARDIER

Mini Z	120	1998-2003	0,6	BPR6ES	7822	-	BPR6EIX	6637
250 (10-12HP)	247	-	0,5	AB-6	2910	-	-	-
250 (14HP)	247	-	0,5	AB-7	3010	-	-	-
250 Deluxe, 250T	247	-	0,5	B7HS	5110	Q204	BR7HIX	7067
250SS	247	-	0,5	B8HS	5510	Q205	BR8HIX	7001
247 Elan, Spirit	250	-	0,5	AB-7	3010	-	-	-
Citation L/S	253	-	0,5	BR9ES	5722	Q208	BR9EIX	3981
Tunda, -LT	253	-	0,5	BR9ES	5722	Q208	BR9EIX	3981
Tundra	277	2000-	0,8	BR10ES	4684	-	BR10EIX	6801
Skandic	277	2002-	0,7	BR9ES	3194	Q208	BR9EIX	3981
Tundra F	280	2003-	0,5	BR9ES	5722	Q208	BR9EIX	3981
Skanic Tundra LC	280	2003-2004	0,5	BR9ECS	3570	-	-	-
300 (12.0HP)	299	-	0,5	AB-6	2910	-	-	-
300S	299	-	0,5	AB-7	3010	-	-	-
300 MX-Z300 / Fan	300	-	0,5	BR9ES	5722	Q208	BR9EIX	3981
TNT, RV340, Sonic 340	337	-	0,5	-	-	-	BR10EIX	6801
TNT340 Free Air	339	-	0,5	B9ES	2611	Q202	BR9EIX	3981
TNT340SM	339	-	0,5	B8HS	5510	Q205	BR8HIX	7001
354 Blizzard 6500	339	-	0,5	-	-	-	BR10EIX	6801
354 Super Sonic / LC	339	-	0,5	-	-	-	BR10EIX	6801
300 Touring 300 / Fan	368	-	0,5	BR9ES	5722	Q208	BR9EIX	3981
Formula S	368	-	0,5	BR9ES	5722	Q208	BR9EIX	3981

* Bitte Elektrodenabstand nach Angaben des Herstellers justieren

* Please adjust the groundelectrode gap

* Veuillez vérifier L' écartement

* Por favor, ajustar distancia entre electrodos

* regolare il gap



Stock-№

Quick-№



Stock-№ IX

SKI-DOO / BOMBARDIER

368 MX-Z380 / Fan	368	-	0,5	BR9ES	5722	Q208	BR9EIX	3981
368 Touring 380 / Fan	368	-	0,5	BR9ES	5722	Q208	BR9EIX	3981
377 Safari Saga	368	-	0,5	BR9ES	5722	Q208	BR9EIX	3981
377 Touring E / ELT	377	-	0,4	BR9ES	5722	Q208	BR9EIX	3981
380 Formula Deluxe 380	377	1987-2001	0,4	BR9ES	5722	Q208	BR9EIX	3981
380 Scandic 380	380	-	0,4	BR9ES	5722	Q208	BR9EIX	3981
Legend Fan, GT	380	2004-	0,5	BR9ES	5722	Q208	BR9EIX	3981
MX Z Fan	380	2004-	0,5	BR9ES	5722	Q208	BR9EIX	3981
400 MX-Z400 / Fan	400	-	0,5	BR9ES	5722	Q208	BR9EIX	3981
440 MX-Z 440 / F	436	-	0,4	BR9ES	5722	Q208	BR9EIX	3981
444 Elite	436	-	0,5	B8ES	2411	Q201	BR8EIX	5044
444 LC Everest, Futura	436	-	0,5	B8ES	2411	Q201	BR8EIX	5044
TNT440 Free Air 18mm Head	437	-	0,7	AB-8	7909	-	-	-
TNT440 Free Air 14mm Head	437	-	0,8	BR8ES	3961	Q207	BR8EIX	5044
440 Skandic LC / LT440	437	2001-2002	0,5	BR9ES	5722	Q208	BR9EIX	3981
Skandic	440	2003-2004	0,5	BR9ECS	3570	-	-	-
447 Grand Luxe	437	-	0,5	BR8ES	5422	Q207	BR8EIX	5044
454 Blizzard 9500 / Plus	437	-	0,5	-	-	-	BR10EIX	6801
440	440	2004-	0,5	BR9ECS-5	6669	-	-	-
Touring LE	440	-	0,4	BR9ES	5722	Q208	BR9EIX	3981
Skandic LT	440	2004-	0,5	BR9ES	5722	Q208	BR9EIX	3981
447 Safari 1986	447	-	0,5	BR9ES	5722	Q208	BR9EIX	3981
454 Ultra Sonic	463	-	0,5	-	-	-	BR10EIX	6801
Grand Touring	470	1995-	0,7	BR9ES	3194	Q208	BR9EIX	3981
MX	470	1994-1995	0,7	BR9ES	3194	Q208	BR9EIX	3981
MXZ	470	1994-	0,7	BR9ES	3194	Q208	BR9EIX	3981
Formula SLS	494	-	0,5	BR9ES	5722	Q208	BR9EIX	3981
Skandic WT LC	494	-	0,5	BR8ES	5422	Q207	BR8EIX	5044
Skandic LC	500	2002-2003	0,5	BR9ECS	3570	-	-	-
Summit 500	494	-	0,5	BR9ES	5722	Q208	BR9EIX	3981
467 Formula MX	496	-	0,5	BR9ES	5722	Q208	BR9EIX	3981
467 Formula LT	496	-	0,5	BR9ES	5722	Q208	BR9EIX	3981
503 Alpine II	496	-	0,5	BR8ES	5422	Q207	BR8EIX	5044
Formula Deluxe / LC / Fan	497	-	0,4	BR9ES	5722	Q208	BR9EIX	3981
Scandic SWT / WT / LC	497	-	0,4	BR9ES	5722	Q208	BR9EIX	3981
Summit Fun / Touring Fan	497	-	0,5	BR9ES	5722	Q208	BR9EIX	3981
503 Safari Cheyenne / Escapade	497	-	0,5	BR9ES	5722	Q208	BR9EIX	3981
503 Sonic MX 1983	497	-	0,5	BR7ES	5122	-	BR7EIX	6664
500 Formula Z / Grand Touring	499	-	0,4	BR9ES	5722	Q208	BR9EIX	3981
500 MX-Z Trail / Fan	499	-	0,4	BR9ES	5722	Q208	BR9EIX	3981
Scandic / SWT / WT / WT LC	500	-	0,4	BR9ES	5722	Q208	BR9EIX	3981
GSX Sport, 1+1	500	2004-	0,5	BR9ECS-5	6669	-	-	-
Legend Sport, Sport GT	500	2004-	0,5	BR9ECS-5	6669	-	-	-
MX Z Adrenaline	500	2004-	0,5	BR9ECS-5	6669	-	-	-
MX Z Trail	500	2004-	0,5	BR9ECS-5	6669	-	-	-
503 Formula SL	503	-	0,5	BR9ES	5722	Q208	BR9EIX	3981
Legend Fan	500	2002-	0,5	BR9ECS	3570	-	-	-
Formula	500	1997-1998	0,7	BR9ES	3194	Q208	BR9EIX	3981
Formula Deluxe	500	1999-2000	0,7	BR9ES	3194	Q208	BR9EIX	3981
Formula Deluxe F/C	500	2001-	0,7	BR9ES	3194	Q208	BR9EIX	3981
Grand Touring	500	1996-2001	0,7	BR9ES	3194	Q208	BR9EIX	3981
Grand Touring Fan	500	2002-2003	0,8	BR9ES	3194	Q208	BR9EIX	3981

* Bitte Elektrodenabstand nach Angaben des Herstellers justieren

* Please adjust the groundelectrode gap

* Veuillez vérifier L' écartement

* Por favor, ajustar distancia entre electrodos

* regolare il gap



SKI-DOO / BOMBARDIER

Grand Touring LC	500	2002-	0,5	BR9ECS	3570	-	-	-
GSX	500	2004-	0,5	BR9ECS	3570	-	-	-
Legend LC	500	2002-2004	0,5	BR9ECS	3570	-	-	-
MXZ Fan	500	1998-2003	0,7	BR9ES	3194	Q208	BR9EIX	3981
MXZ LC	500	2002-2004	0,5	BR9ECS	3570	-	-	-
Touring LC	500	1995-2000	0,7	BR9ES	3194	Q208	BR9EIX	3981
536 Formula Plus / LT	521	-	0,5	BR9ES	5722	Q208	BR9EIX	3981
Skandic Sport /SUV/SWT/WT	550	2004-	0,5	BR9ECS	3570	-	-	-
Legend Fan, GT	550	2004-	0,5	BR9ES	5722	Q208	BR9EIX	3981
Grand Touring FC	550	2002-2003	0,7	BR9ES	3194	Q208	BR9EIX	3981
MX Z Fan	550	2004-	0,5	BR9ECS	3570	-	-	-
Summit Fan	550	2004-	0,5	BR9ES	5722	Q208	BR9EIX	3981
583 Formula Deluxe	581	-	0,4	BR9ES	5722	Q208	BR9EIX	3981
Grand Touring	581	-	0,5	BR9ES	5722	Q208	BR9EIX	3981
Summit	583	-	0,5	BR9ES	5722	Q208	BR9EIX	3981
MXZ	583	1994-1998	0,7	BR9ES	3194	Q208	BR9EIX	3981
Plus	583	1993-	0,7	BR9ES	3194	Q208	BR9EIX	3981
Formula III LT	599	-	0,5	BR10ES	4832	-	BR10EIX	6801
Ace	600	2012-	0,8	MR7BI-8	90982	-	-	-
Formula III	600	-	0,5	BR10ES	4832	-	BR10EIX	6801
Formula Delux	600	-	0,5	BR9ES	5722	Q208	BR9EIX	3981
Expedition	600	2006-	0,8	BR8ECS	3972	-	-	-
Formula Z	600	-	0,5	BR9ES	5722	Q208	BR9EIX	3981
GSX SDI	600	2006-	0,8	BR8ECS	3972	-	-	-
GSX LTD	600	2009-	0,8	PZFR6F	7550	-	-	-
Grand Touring / SE	600	-	0,5	BR9ES	5722	Q208	BR9EIX	3981
Grand Touring	600	2002-2003	0,5	BR9ECS	3570	-	-	-
MX Z Adrenaline	600	2002-	0,5	BR9ECS-5	6669	-	-	-
MXZ 50TH, X, Adrenaline, TNT	600	2009-	0,8	PZFR6F	7550	-	-	-
MX Z SDI	600	2006-	0,8	BR8ECS	3972	-	-	-
MX-Z / Trail	600	1999-2001	0,5	BR9ES	5722	Q208	BR9EIX	3981
Skandic SUV / WT LC	600	2002-	0,5	BR9ECS-5	6669	-	-	-
Skandic LC	600	-2001	0,7	BR9ES	3194	Q208	BR9EIX	3981
Summit	600	2006-	0,8	BR8ECS	3972	-	-	-
Summit	600	1999-2001	0,7	BR9ES	3194	Q208	BR9EIX	3981
Summit Everest, X	600	2009-	0,8	PZFR6F	7550	-	-	-
XP, XR, XU	600	2008-	0,8	PZFR6F	7550	-	-	-
GSX Sport, 1+1	600	2004-	0,5	BR9ECS-5	6669	-	-	-
MX Z, Adrenaline, Renegade	600	2004-	0,5	BR9ECS-5	6669	-	-	-
Summit Adren, X	600	2002-	0,5	BR9ECS-5	6669	-	-	-
Legend SE/SE GT/Sport/Sport GT	600	2004-	0,5	BR9ECS-5	6669	-	-	-
GSX Limited, Limited 1+1, Sport	600	2004-	0,5	BR9ECS-5	6669	-	-	-
670 MX-Z H.O.	669	-	0,4	BR9ES	5722	Q208	BR9EIX	3981
670 Formula SS / Z	670	-	0,5	BR9ES	5722	Q208	BR9EIX	3981
Formula III	670	1996-1997	0,8	BR10ES	4684	-	BR10EIX	6801
Mach 1	670	1996-1997	0,5	BR10ES	4832	-	BR10EIX	6801
Mach I	670	1998-	0,7	BR9ES	3194	Q208	BR9EIX	3981
Summit / X	670	-	0,5	BR9ES	5722	Q208	BR9EIX	3981
Grand Touring SE	670	1995-1997	0,7	BR9ES	3194	Q208	BR9EIX	3981
Mach 1	699	1996-1997	0,4	BR10ES	4832	-	BR10EIX	6801

* Bitte Elektrodenabstand nach Angaben des Herstellers justieren

* Please adjust the groundelectrode gap

* Veuillez vérifier l' écartement

* Por favor, ajustar distancia entre electrodos

* regolare il gap



Stock-№

Quick-№



Stock-№ IX

SKI-DOO / BOMBARDIER

Mach I	700	1994-1995	0,7	BR9ES	3194	Q208	BR9EIX	3981
Mach I	700	1998-2000	0,7	BR9ES	3194	Q208	BR9EIX	3981
Formula Z 600	699	-	0,5	BR9ES	5722	Q208	BR9EIX	3981
MX-Z 700 / Trail 700	699	-	0,5	BR9ES	5722	Q208	BR9EIX	3981
Legend SE, SE GT, Sport, Sport GT	700	2004-	0,5	BR9ECS	3570	-	-	-
Grand Touring	700	1998-2001	0,7	BR9ES	3194	Q208	BR9EIX	3981
Grand Touring	700	2002-2003	0,5	BR9ECS	3570	-	-	-
Grand Touring SE	700	1997-	0,8	BR10ES	4684	-	BR10EIX	6801
Grand Touring SE	700	1994-1995	0,7	BR9ES	3194	Q208	BR9EIX	3981
Grand Touring XTC	700	1994-1995	0,7	BR9ES	3194	Q208	BR9EIX	3981
MXZ	700	2002-2003	0,5	BR9ECS	3570	-	-	-
Summit	700	2000-2001	0,7	BR9ES	3194	Q208	BR9EIX	3981
Mach Z	765	-	0,5	BR9ES	5722	Q208	BR9EIX	3981
MX2600	765	-	0,5	BR9ES	5722	Q208	BR9EIX	3981
MX2700	765	-	0,5	BR9ES	5722	Q208	BR9EIX	3981
Summit 700	765	-	0,5	BR9ES	5722	Q208	BR9EIX	3981
Skandic WT LC	765	-	0,5	BR9ES	5722	Q208	BR9EIX	3981
Mach Z / ZLT	779	-	0,5	BR10ES	4832	-	BR10EIX	6801
Grand Touring SE	796	2001-	0,5	BR9ES	5722	Q208	BR9EIX	3981
Mach Z800	796	-	0,5	BR9ES	5722	Q208	BR9EIX	3981
Grand Touring SE	798	1999-2000	0,5	BR10ES	4832	-	BR10EIX	6801
Grand Touring SE	800	2002-2003	0,5	BR9ECS	3570	-	-	-
Formula III	800	1999-2000	0,7	BR9ES	3194	Q208	BR9EIX	3981
Summit	800	-	0,5	BR9ES	5722	Q208	BR9EIX	3981
GSX Limited, Limited 1+1	800	2004-	0,5	BR9ECS	3570	-	-	-
GTX & GSX	800	2005-	0,6	BR8ECS	3972	-	-	-
Legend	800	2002-2004	0,5	BR9ECS	3570	-	-	-
MX Z Adrenaline, Renegade, X	800	2002-2003	0,5	BR9ECS-5	6669	-	-	-
Summit Adrenaline, HM, HM X, HM Xtreme, Sport, X	800	2002-2004	0,5	BR9ECS-5	6669	-	-	-
Summit	800	2001-	0,7	BR9ES	3194	Q208	BR9EIX	3981
Summit	800	2005-	0,5	BR9ECS	3570	-	-	-
Summit X R, R E-Tec	800	2012-	0,8	PFR7AB	93322	-	-	-
Mach Z	800	1994-1995	0,7	BR9ES	3194	Q208	BR9EIX	3981
Mach Z	800	2000-2002	0,7	BR9ES	3194	Q208	BR9EIX	3981
Mach Z	800	2003-2004	0,5	BR9ECS	3570	-	-	-
Mach Z	800	1996-1999	0,8	BR10ES	4684	-	BR10EIX	6801
MXZ	800	2002-2003	0,5	BR9ECS	3570	-	-	-
MXZ	800	-2001	0,7	BR9ES	3194	Q208	BR9EIX	3981
MXZ	800	2005-	0,6	BR8ECS	3972	-	-	-
Mach Z	809	-	0,4	BR10ES	4832	-	BR10EIX	6801
Legend SE, SE GT, Sport, Sport GT	1000	2004-	0,8	DCPR8E	4339	-	DCPR8EIX	6546
Grand Tour Sport	1000	2003-	0,8	DCPR8E	4179	-	DCPR8EIX	6546
Legend	1000	2003-2004	0,5	BR9ECS	3570	-	-	-
Elite SE	1000	2004-	0,6	BR8ECS	3972	-	-	-
Expedition	1000	2006-	0,8	BR8ECS	3972	-	-	-
MXZ	1000	2006-	0,8	BR8ECS	3972	-	-	-
Mach Z Adrenaline 2 Stroke	1000	2005-	0,5	BR9ECS-5	6669	-	-	-
Summit Highmark 2 Stroke	1000	2005-	0,5	BR8ECS	3972	-	-	-

SUZUKI

Nomad	292	-	0,7	B7HS	5110	Q204	BR7HIX	7067
Nomad	336	-	0,7	B7HS	5110	Q204	BR7HIX	7067

* Bitte Elektrodenabstand nach Angaben des Herstellers justieren

* Please adjust the groundelectrode gap

* Veuillez vérifier l' écartement

* Por favor, ajustar distancia entre electrodos

* regolare il gap



Stock-No

Quick-No



Stock-No IX

SUZUKI

F / C	340	-	0,8	BR9EYA	7548	-	BR9EIX	3981
SM10 / SM10D	360	-	0,7	B7HS	5110	Q204	BR7HIX	7067
370F/C	370	-	0,8	BR9EYA	7548	-	BR9EIX	3981
400 Wide Track	395	-	0,7	B7HS	5110	Q204	BR7HIX	7067
SM20	395	-	0,7	B7HS	5110	Q204	BR7HIX	7067
SM20 Hop Up Kit	395	-	0,7	B8ES	2411	Q201	BR8EIX	5044
XR400	395	-	0,7	B7HS	5110	Q204	BR7HIX	7067
440 L/C-ZRV	400	1998-	0,7	BR10ES	4832	-	BR10EIX	6801
440 L/C-ZRV	400	1999-	0,8	-	-	-	BR10EIX	6801
440 L/C-ZRV	400	2000-	0,8	BR9EYA	7548	-	BR9EIX	3981
XR440	432	-	0,7	B7HS	5110	Q204	BR7HIX	7067
440 F/C	433	-	0,8	BR9EYA	7548	-	BR9EIX	3981
440 F/C-C	433	-	0,8	BR9ES	5722	Q208	BR9EIX	3981
440 L/C-LWS	433	-	0,8	BR9EYA	7548	-	BR9EIX	3981
SM440M	433	-	0,7	-	-	-	BR9EIX	3981
F / C	500	-	0,8	BR9ES	5722	Q208	BR9EIX	3981
L/C	500	2000-	0,8	-	-	-	BR10EIX	6801
L/C - L/C-EID	500	1999-	0,8	BR9EYA	7548	-	BR9EIX	3981
L/C	530	-	0,7	BR10ES	4832	-	BR10EIX	6801
550 L/C	530	-	0,8	BR9EYA	7548	-	BR9EIX	3981
L/C-EID	580	-	0,8	BR9EYA	7548	-	BR9EIX	3981
L/C - L/C-EID	600	-	0,8	BR9EYA	7548	-	BR9EIX	3981
L/C	650	-	0,7	BR10ES	4832	-	BR10EIX	6801
L/C	700	1999-	0,7	BR10ES	4832	-	BR10EIX	6801
L/C	700	-1995	0,8	BR9ES	5722	Q208	BR9EIX	3981
L/C	785	-	0,8	BR9EYA	7548	-	BR9EIX	3981
L/C	800	-	0,8	BR9EYA	7548	-	BR9EIX	3981
L/C	900	-	0,8	BR9EYA	7548	-	BR9EIX	3981
L/C	1000	-	0,8	BR9EYA	7548	-	BR9EIX	3981

YAMAHA

SE80	80	-	0,7	BR8HS	4322	Q212	BR8HIX	7001
SV80 Series	80	-	0,7	BR8HS	4322	Q212	BR8HIX	7001
SV125 Series	125	-	0,7	BR8HS	4322	Q212	BR8HIX	7001
GP246	146	-	0,4	B7ES	1111	-	BR7EIX	6664
BR250 Series	250	-	0,7	BR8HS	4322	Q212	BR8HIX	7001
ET250 Series	250	-	0,7	B8HS	5510	Q205	BR8HIX	7001
ET250A/B	250	-	0,6	-	-	-	BR8HIX	7001
SL292	292	-	0,5	B7HS	5110	Q204	BR7HIX	7067
SM292	292	-	0,5	B6ES	7310	-	-	-
SR292	292	-	0,4	B10ES	7928	-	BR10EIX	6801
CF300	300	-	0,7	BR8HS	4322	Q212	BR8HIX	7001
EC300	300	-	0,8	BR9ES	5722	Q208	BR9EIX	3981
ET300 Series	300	-	0,8	BR9ES	5722	Q208	BR9EIX	3981
ET300C	300	-	0,6	-	-	-	BR9EIX	3981
GP300	300	-	*	BR8EIX	5044	-	-	-
GP338	338	-	*	BR8EIX	5044	-	-	-
GPX338	338	-	0,4	B9ES	2611	Q202	BR9EIX	3981
SL338	338	-	0,5	B7HS	5110	Q204	BR7HIX	7067
SS338	338	-	0,5	B9ES	2611	Q202	BR9EIX	3981
CS340 / E / EC	340	-	0,8	BR9ES	5722	Q208	BR9EIX	3981

* Bitte Elektrodenabstand nach Angaben des Herstellers justieren

* Please adjust the groundelectrode gap

* Veuillez vérifier L' écartement

* Por favor, ajustar distancia entre electrodos

* regolare il gap



Stock-No

Quick-No



Stock-No IX

YAMAHA

EC / ET 340 Series	340	-	0,8	BR9ES	5722	Q208	BR9EIX	3981
ET340 B / C / EC	340	-	0,6	-	-	-	BR9EIX	3981
EX340 Series	340	-	0,6	-	-	-	BR9EIX	3981
EX570 Series	340	-	0,8	BR9ES	5722	Q208	BR9EIX	3981
GS340	340	-	0,5	BR7HS	4122	Q211	BR7HIX	7067
S340	340	-	0,8	BR8ES	5422	Q207	BR8EIX	5044
GP396	396	-	0,5	B7HS	5110	Q204	BR7HIX	7067
SL396	396	-	0,5	B7HS	5110	Q204	BR7HIX	7067
SW396	396	-	0,5	B7HS	5110	Q204	BR7HIX	7067
ET400 Series	400	-	0,8	BR8ES	5422	Q207	BR8EIX	5044
ET410TR	410	-	0,8	BR9ES	5722	Q208	BR9EIX	3981
EL433	433	-	0,5	B7HS	5110	Q204	BR7HIX	7067
EW433	433	-	0,5	B7HS	5110	Q204	BR7HIX	7067
GP433	433	-	0,4	B8ES	2411	Q201	BR8EIX	5044
GPX433	433	-	0,4	B9ES	2611	Q202	BR9EIX	3981
SR433	433	-	0,4	B9ES	2611	Q202	BR9EIX	3981
SS433	433	-	0,5	B9ES	2611	Q202	BR9EIX	3981
SW433	433	-	0,5	B7HS	5110	Q204	BR7HIX	7067
TL433	433	-	0,5	B7HS	5110	Q204	BR7HIX	7067
TW433	433	-	0,5	B7HS	5110	Q204	BR7HIX	7067
EX440	440	-	0,5	B9ES	2611	Q202	BR9EIX	3981
GP440	440	-	*	BR8EIX	5044	-	-	-
SRX440	440	-	0,5	B9ES	2611	Q202	BR9EIX	3981
SS440 Series	440	-	0,8	BR9ES	5722	Q208	BR9EIX	3981
PZ480 Series	480	-	0,8	BR9ES	5722	Q208	BR9EIX	3981
VT480 Series	480	-	0,8	BR9ES	5722	Q208	BR9EIX	3981
Venture Lite / Multi Purpose	499	2010-	0,7	CR9EKB	2305	-	CR9EIX	3521
Phazer	499	2012-	0,8	CR9EKB	2305	-	CR9EIX	3521
Phazer	499	2010-	0,7	CR9EKB	2305	-	CR9EIX	3521
PZ500 / C / DX / ML / MLD / ST	500	-	0,8	BR9ES	5722	Q208	BR9EIX	3981
SX500 / D	500	-	0,8	BR9ES	5722	Q208	BR9EIX	3981
VT500 Series	500	-	0,8	BR9ES	5722	Q208	BR9EIX	3981
VX500 Series	500	-	0,8	BR9ES	5722	Q208	BR9EIX	3981
VK540 Series	540	-	0,8	BR9ES	5722	Q208	BR9EIX	3981
XL540 Series	540	-	0,8	BR9ES	5722	Q208	BR9EIX	3981
III	540	2005-	0,8	BR9ES	5722	Q208	BR9EIX	3981
EX570 Series	570	-	0,8	BR9ES	5722	Q208	BR9EIX	3981
MM600/D	600	-	0,8	BR9ES	5722	Q208	BR9EIX	3981
SRX600 / C / S / SC	600	1999-	0,8	BR9ECS	3570	-	-	-
SRX600 Series	600	-1998	0,8	BR10ECS	5880	-	-	-
SX600 / D	600	-	0,8	BR9ES	5722	Q208	BR9EIX	3981
VT600 / C / D	600	2000-	0,8	BR9ES	5722	Q208	BR9EIX	3981
VT600	600	-2000	0,8	BR9ECS	3570	-	-	-
VX600 Series	600	-	0,8	BR9ES	5722	Q208	BR9EIX	3981
EW643	643	-	0,5	B9ES	2611	Q202	BR9EIX	3981
SR643	643	-	0,4	B9ES	2611	Q202	BR9EIX	3981
MM700/D	700	-	0,8	BR9ES	5722	Q208	BR9EIX	3981
SRX700 / C / S / SC	700	1999-	0,8	BR9ECS	3570	-	-	-
RX-1	700	-	0,8	CR9E	6263	Q227	CR9EIX	3521
SRX700 Series	700	-1998	0,8	BR10ECS	5880	-	-	-
SX700 / D / SD	700	-	0,8	BR9ES	5722	Q208	BR9EIX	3981

* Bitte Elektrodenabstand nach Angaben des Herstellers justieren

* Please adjust the groundelectrode gap

* Veuillez vérifier L' écartement

* Por favor, ajustar distancia entre electrodos

* regolare il gap



Stock-No

Quick-No



Stock-No IX

YAMAHA

SXV700	700	-	0,7	BR9ES	3194	Q208	BR9EIX	3981
VT700 Series	700	-	0,8	BR9ES	5722	Q208	BR9EIX	3981
VX700 Series	700	-	0,8	BR9ES	5722	Q208	BR9EIX	3981
VX750 Series	750	-	0,8	BR9ES	5722	Q208	BR9EIX	3981
MM800	800	-	0,7	BR9ES	3194	Q208	BR9EIX	3981
VX800 Series	800	-	0,8	BR9ES	5722	Q208	BR9EIX	3981
Rage / Venture TF/ Vector GT	973	2005-	0,7	CR9E	6263	Q227	CR9EIX	3521
Nytro ER Nytro / Vertor	973	2006-	0,7	CR8E	1275	Q226	CR8EIX	4218
Viking Professional	973	2010-	0,7	CR9E	6263	Q227	CR9EIX	3521
RS Rage	973	2006-	0,7	CR8E	1275	Q226	CR8EIX	4218
Apex	998	2012-	0,7	CR9EB	6955	-	CR9EIX	3521
Apex SE	998	2012-	0,7	CR9EB	6955	-	CR9EIX	3521
Apex XTX	998	2012-	0,7	CR9EB	6955	-	CR9EIX	3521
Apex	998	2006-	0,7	CR9EB	6955	-	CR9EIX	3521
Attak	998	2006-	0,7	CR9EB	6955	-	CR9EIX	3521
ER	998	2005-	0,7	CR9E	6263	Q227	CR9EIX	3521
Warrior	998	2005-	0,7	CR9E	6263	Q227	CR9EIX	3521
Warrior GT	998	2010-	0,7	CR9E	6263	Q227	CR9EIX	3521
Venture Lite	1049	2012-	0,8	CR9EKB	2305	-	CR9EIX	3521
FX Nytro M-TX SE 162	1049	2010-	0,7	CR9E	6263	Q227	CR9EIX	3521
FX Nytro R-TX SE / X-TX	1049	2010-	0,7	CR9E	6263	Q227	CR9EIX	3521
Venture TF 120 FI / GT	1049	2009-	0,7	CR9E	6263	Q227	CR9EIX	3521

* Bitte Elektrodenabstand nach Angaben des Herstellers justieren
 * Please adjust the groundelectrode gap
 * Veuillez vérifier L' écartement

* Por favor, ajustar distancia entre electrodos
 * regolare il gap

NGK RESISTOR PLUG COVERS

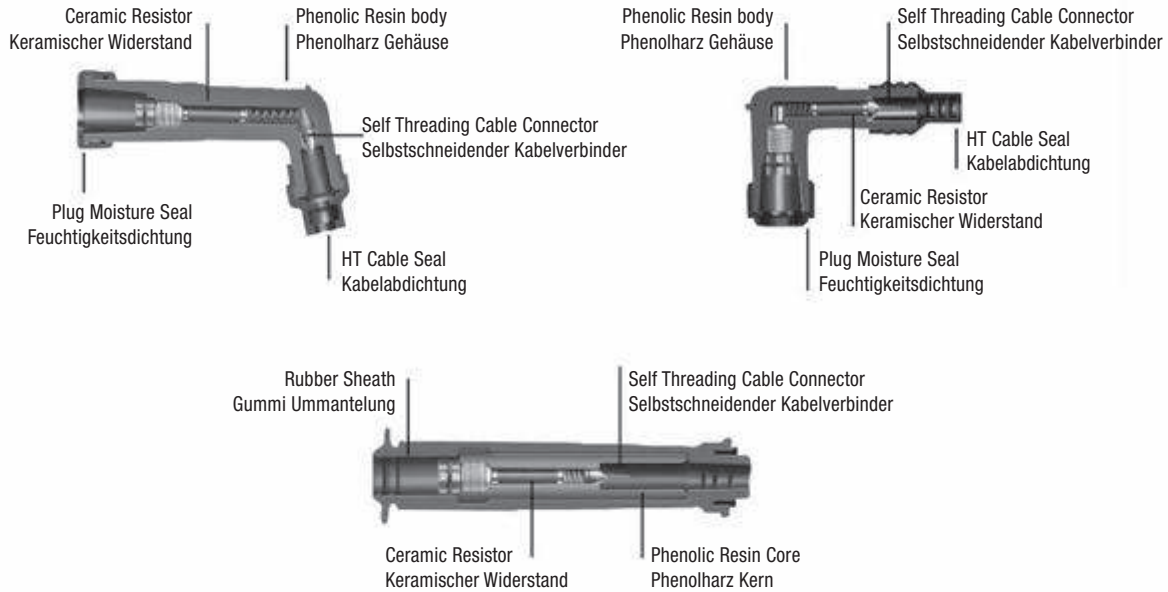





COVER SYMBOLS EXPLANATION CHART

L	B	10	E	H	F																															
<table border="1"> <thead> <tr><th>External appearance</th></tr> </thead> <tbody> <tr><td>L 90° Elbow Type</td></tr> <tr><td>S Straight</td></tr> <tr><td>X 102° Elbow Std.</td></tr> <tr><td>V 120° Elbow (Long)</td></tr> <tr><td>Y 120° Elbow (Short)</td></tr> <tr><td>T T Type</td></tr> </tbody> </table>	External appearance	L 90° Elbow Type	S Straight	X 102° Elbow Std.	V 120° Elbow (Long)	Y 120° Elbow (Short)	T T Type	<table border="1"> <thead> <tr><th>Suitable Ø Plug Thread</th></tr> </thead> <tbody> <tr><td>B 14 mm minimum</td></tr> <tr><td>D 10 & 12 mm</td></tr> <tr><td>Z 10, 12 & 14 mm</td></tr> </tbody> </table>	Suitable Ø Plug Thread	B 14 mm minimum	D 10 & 12 mm	Z 10, 12 & 14 mm	<table border="1"> <thead> <tr><th>Resistance</th></tr> </thead> <tbody> <tr><td>None /</td></tr> <tr><td>01 1 k Ω</td></tr> <tr><td>05 5 k Ω</td></tr> <tr><td>10 10 k Ω</td></tr> </tbody> </table>	Resistance	None /	01 1 k Ω	05 5 k Ω	10 10 k Ω	<table border="1"> <thead> <tr><th>Suitable Terminal Type</th></tr> </thead> <tbody> <tr><td>E Terminal nut or solid post</td></tr> <tr><td>F Terminal stud</td></tr> </tbody> </table>	Suitable Terminal Type	E Terminal nut or solid post	F Terminal stud	<table border="1"> <thead> <tr><th>Special Feature</th></tr> </thead> <tbody> <tr><td>A Special design</td></tr> <tr><td>H Compact type</td></tr> <tr><td>P Special waterproof cover</td></tr> <tr><td>K Silicon waterproof cover</td></tr> <tr><td>M Rubber sheathed</td></tr> <tr><td>G With rubber grommet</td></tr> <tr><td>R Racing</td></tr> <tr><td>F For Ø 5mm HT cable</td></tr> <tr><td>L Inductive resistor type</td></tr> <tr><td>Y With handle</td></tr> <tr><td>Z Special design</td></tr> </tbody> </table>	Special Feature	A Special design	H Compact type	P Special waterproof cover	K Silicon waterproof cover	M Rubber sheathed	G With rubber grommet	R Racing	F For Ø 5mm HT cable	L Inductive resistor type	Y With handle	Z Special design	
External appearance																																				
L 90° Elbow Type																																				
S Straight																																				
X 102° Elbow Std.																																				
V 120° Elbow (Long)																																				
Y 120° Elbow (Short)																																				
T T Type																																				
Suitable Ø Plug Thread																																				
B 14 mm minimum																																				
D 10 & 12 mm																																				
Z 10, 12 & 14 mm																																				
Resistance																																				
None /																																				
01 1 k Ω																																				
05 5 k Ω																																				
10 10 k Ω																																				
Suitable Terminal Type																																				
E Terminal nut or solid post																																				
F Terminal stud																																				
Special Feature																																				
A Special design																																				
H Compact type																																				
P Special waterproof cover																																				
K Silicon waterproof cover																																				
M Rubber sheathed																																				
G With rubber grommet																																				
R Racing																																				
F For Ø 5mm HT cable																																				
L Inductive resistor type																																				
Y With handle																																				
Z Special design																																				



ERKLÄRUNG DER KURZZEICHEN

L	B	10	E	H	F																															
<table border="1"> <thead> <tr><th>Bauart</th></tr> </thead> <tbody> <tr><td>L 90° Winkel</td></tr> <tr><td>S 0° Gerade</td></tr> <tr><td>X 102° Winkel</td></tr> <tr><td>V 120° Winkel (lang)</td></tr> <tr><td>Y 120° Winkel (kurz)</td></tr> <tr><td>T T-Typ</td></tr> </tbody> </table>	Bauart	L 90° Winkel	S 0° Gerade	X 102° Winkel	V 120° Winkel (lang)	Y 120° Winkel (kurz)	T T-Typ	<table border="1"> <thead> <tr><th>Für Kerzengewinde Durchmesser</th></tr> </thead> <tbody> <tr><td>B 14 mm min.</td></tr> <tr><td>D 10 - 12 mm</td></tr> <tr><td>Z 10 - 12 - 14 mm</td></tr> </tbody> </table>	Für Kerzengewinde Durchmesser	B 14 mm min.	D 10 - 12 mm	Z 10 - 12 - 14 mm	<table border="1"> <thead> <tr><th>Widerstand</th></tr> </thead> <tbody> <tr><td>- /</td></tr> <tr><td>01 1 k Ω</td></tr> <tr><td>05 5 k Ω</td></tr> <tr><td>10 10 k Ω</td></tr> </tbody> </table>	Widerstand	- /	01 1 k Ω	05 5 k Ω	10 10 k Ω	<table border="1"> <thead> <tr><th>Für Anschluß Zündkerze</th></tr> </thead> <tbody> <tr><td>E SAE Anschlußmutter oder integriertem Anschluß</td></tr> <tr><td>F M4 Anschlußgewinde</td></tr> </tbody> </table>	Für Anschluß Zündkerze	E SAE Anschlußmutter oder integriertem Anschluß	F M4 Anschlußgewinde	<table border="1"> <thead> <tr><th>Ausstattung</th></tr> </thead> <tbody> <tr><td>A Spezialausführung</td></tr> <tr><td>H Kompakttyp</td></tr> <tr><td>P mit spezieller wasserdichter Abdeckung</td></tr> <tr><td>K mit wasserdichter Silikonabdeckung</td></tr> <tr><td>M mit Gummi ummantelt</td></tr> <tr><td>G mit Gummihülse</td></tr> <tr><td>R Racing</td></tr> <tr><td>F für Zündleitungen mit 5 mm Ø</td></tr> <tr><td>L mit Induktionswiderstand</td></tr> <tr><td>Y mit Griff</td></tr> <tr><td>Z Spezialausführung</td></tr> </tbody> </table>	Ausstattung	A Spezialausführung	H Kompakttyp	P mit spezieller wasserdichter Abdeckung	K mit wasserdichter Silikonabdeckung	M mit Gummi ummantelt	G mit Gummihülse	R Racing	F für Zündleitungen mit 5 mm Ø	L mit Induktionswiderstand	Y mit Griff	Z Spezialausführung	
Bauart																																				
L 90° Winkel																																				
S 0° Gerade																																				
X 102° Winkel																																				
V 120° Winkel (lang)																																				
Y 120° Winkel (kurz)																																				
T T-Typ																																				
Für Kerzengewinde Durchmesser																																				
B 14 mm min.																																				
D 10 - 12 mm																																				
Z 10 - 12 - 14 mm																																				
Widerstand																																				
- /																																				
01 1 k Ω																																				
05 5 k Ω																																				
10 10 k Ω																																				
Für Anschluß Zündkerze																																				
E SAE Anschlußmutter oder integriertem Anschluß																																				
F M4 Anschlußgewinde																																				
Ausstattung																																				
A Spezialausführung																																				
H Kompakttyp																																				
P mit spezieller wasserdichter Abdeckung																																				
K mit wasserdichter Silikonabdeckung																																				
M mit Gummi ummantelt																																				
G mit Gummihülse																																				
R Racing																																				
F für Zündleitungen mit 5 mm Ø																																				
L mit Induktionswiderstand																																				
Y mit Griff																																				
Z Spezialausführung																																				

Basic	Type	Stock-No.	Colour	R [kΩ]	Ø [mm]	Terminal
LB	LB - E	8302	black	/	14	
	LB01E	8011	black	1		
	LB05E - R	8898	red	5		
	LB05E	8031	black	5		
	LB10E	8349	black	10		
	LB - F	8309	black	/		
	LB01F	8330	black	1		
	LB01FF	8331	black	1		
	LB05F	8051	black	5		
	LB05F - R	8854	red	5		
	LB05FF	30326	black	5		
	LB10F	8358	black	10		
	LB10FF	8359	black	10		
LD	LD05E	6902	black	5	10-12	
	LD - F	8311	black	/		
	LD01F	8362	black	1		
	LD05F - R	8231	red	5		
	LD05F	8060	black	5		
	LD10F	8997	black	10		

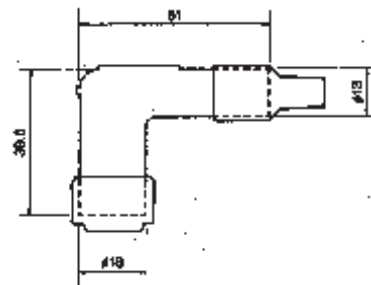

Phenolic Resin





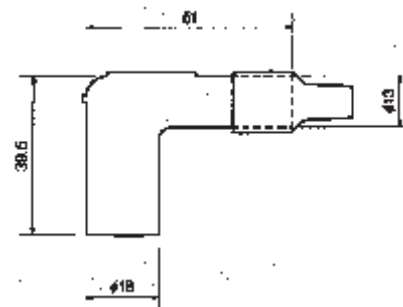



Basic	Type	Stock-No.	Colour	R [kΩ]	Ø [mm]	Terminal
LB	LB01EP	8328	black	1	14	
	LB05EP	8020	black	5		
	LB - EPK	8304	black	/		
	LB05EPK	8342	black	5		
	LB01FP	8088	black	1		
	LB05FP	8030	black	5		
LD	LD05FP	8070	black	5	10 - 12	

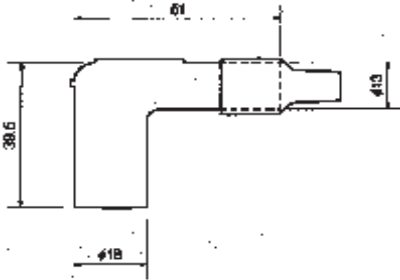

Phenolic Resin

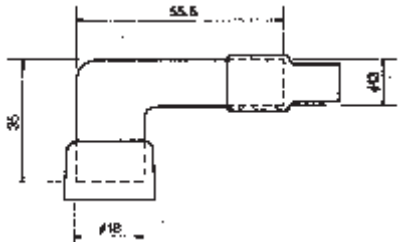

Basic	Type	Stock-No.	Colour	R [kΩ]	 Ø [mm]	Terminal
LZ	LZ05F	8368	black	5	10-12-14	
Phenolic Resin 						

Basic	Type	Stock-No.	Colour	R [kΩ]	 Ø [mm]	Terminal
LB	LB05FG	8346	black	5	14	
Phenolic Resin  						

Basic	Type	Stock-No.	Colour	R [kΩ]	 Ø [mm]	Terminal
LB	LB05EZ	8744	black	5	14	
Phenolic Resin  						

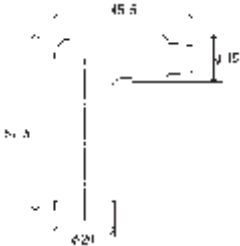
Basic	Type	Stock-No.	Colour	R [kΩ]	 Ø [mm]	Terminal
L	L05EA	6667	black	5		
Phenolic Resin  						

Basic	Type	Stock-No.	Colour	R [kΩ]	Ø [mm]	Terminal
L	L - EH	8301	black	/		
Phenolic Resin						

Basic	Type	Stock-No.	Colour	R [kΩ]	Ø [mm]	Terminal
LB	LB01EH	8326	black	1	14	
	LB01EHF	8327	black	1		
	LB05EH	8334	black	5		
	LB05EHF	8336	black	5		
	LB10EH	8351	black	10		
	LB10EHF	8055	black	10		
	LB - FH	8310	black	/		
LD	LD - FH	8313	black	/	10-12	
Phenolic Resin						

Basic	Type	Stock-No.	Colour	R [kΩ]	Ø [mm]	Terminal
LB	LB10EHAK	8719	black	10	14	
Phenolic Resin						

Basic	Type	Stock-No.	Colour	R [kΩ]	Ø [mm]	Terminal
LZ	LZEH	8760	black	/	10-12-14	
	LZFH	8710	black	/		
Phenolic Resin						

Basic	Type	Stock-No.	Colour	R [kΩ]	Ø [mm]	Terminal
LC	LC05EFK	8050	black	5	CM6	
Phenolic Resin						

Basic	Type	Stock-No.	Colour	R [kΩ]	Ø [mm]	Terminal
LB	LB05EMH	8338	black	5	14	
	LB05EMH - R	8160	red	5		
Rubber sheated						

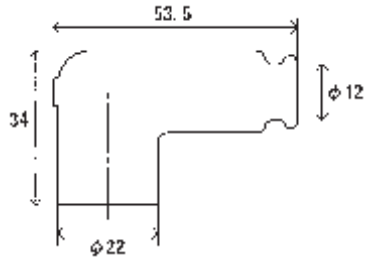
Basic	Type	Stock-No.	Colour	R [kΩ]	Ø [mm]	Terminal
LB	LB05EMHA	8549	red	5	14	
<p>Rubber sheated</p>  						

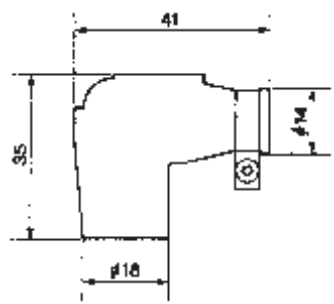
Basic	Type	Stock-No.	Colour	R [kΩ]	Ø [mm]	Terminal
LB	LBER - B	8308	blue	/	14	
<p>Silikon Rubber</p>  						

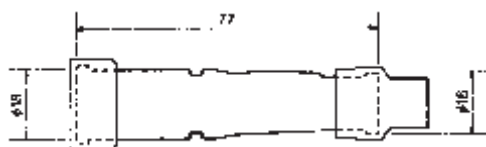
Basic	Type	Stock-No.	Colour	R [kΩ]	Ø [mm]	Terminal	
SB	SB01E	8370	black	1	14		
	SB05E	8374	black	5			
	SB10E	8803	black	10			
	SB01F	8372	black	1		10-12	
	SB05F	8080	black	5			
	SB05F - R	8567	red	5			
	SB10F	8387	black	10			
SD	SD05E	6894	black	5	10-12		
	SD01F	8388	black	1			
	SD05F	8022	black	5			
	SD05F - R	8238	red	5			
	SD10F	8394	black	10			
SZ	SZ05F	8396	black	5	10-12-14		
<p>Phenolic Resin</p>  							

Basic	Type	Stock-No.	Colour	R [kΩ]	Ø [mm]	Terminal
SB	SB05FP	8386	black	5	14	⏏
SD	SD05FP	8325	black	5	10 - 12	
Phenolic Resin						
						

Basic	Type	Stock-No.	Colour	R [kΩ]	Ø [mm]	Terminal
SD	SD05EG	5818	black	5	10-12	⏏
Phenolic Resin						
						

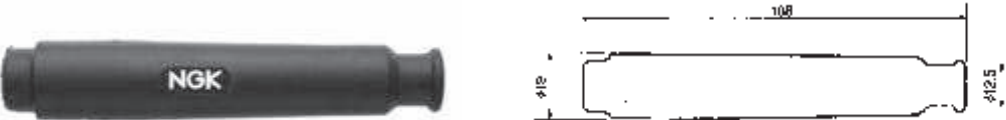
Basic	Type	Stock-No.	Colour	R [kΩ]	Ø [mm]	Terminal
SD	SD05FM	8392	black	5	10-12	⏏
	SD05FM - R	8673	red	5		
Rubber sheathed						
						

Basic	Type	Stock-No.	Colour	R [kΩ]	Ø [mm]	Terminal
SD	SD05FGA	8683	black	5	10-12	⏏
Phenolic Resin						
						
<p>Application: Honda VT 600, XL 600</p>						

Basic	Type	Stock-No.	Colour	R [kΩ]	Ø [mm]	Terminal
VB	VB01E	8405	black	1	14	⏏
	VB05E	8408	black	5		
	VB - F	8913	black	/		
	VB01F	8406	black	1		
	VB05F	8032	black	5		
	VB05F - R	8759	red	5		
	VB10F	8414	black	10		
VD	VD01F	8415	black	1	10-12	⏏
	VD05F	8052	black	5		
	VD05F - R	8376	red	5		
	VD10F	8430	black	10		

Phenolic Resin

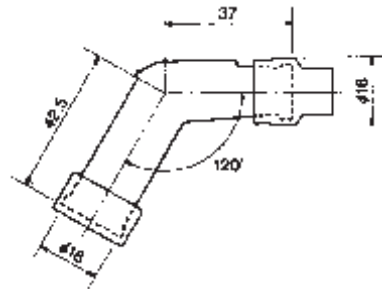

Basic	Type	Stock-No.	Colour	R [kΩ]	Ø [mm]	Terminal
VB	VB05FP	8413	black	5	14	⏏



Phenolic Resin





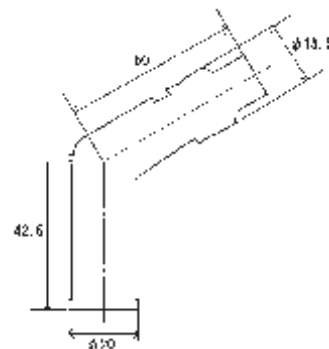

Basic	Type	Stock-No.	Colour	R [kΩ]	Ø [mm]	Terminal
V	V05E	6665	black	5		⏏



Phenolic Resin

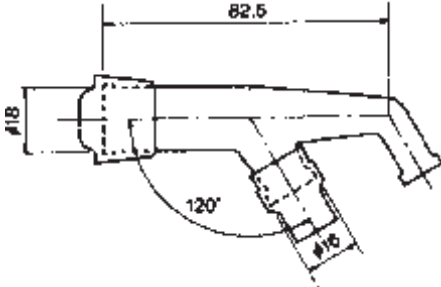

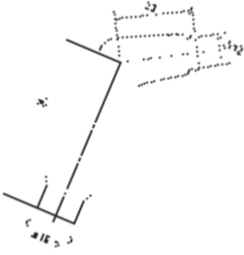

Basic	Type	Stock-No.	Colour	R [kΩ]	Ø [mm]	Terminal
VD	VD05EG	5817	black	5	10-12	
Phenolic Resin						
						

Basic	Type	Stock-No.	Colour	R [kΩ]	Ø [mm]	Terminal
VB	VB05EYK	8411	black	5	14	
Phenolic Resin						
 						

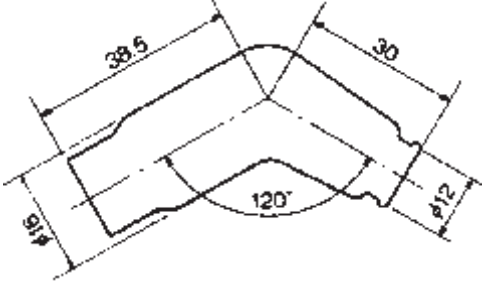
Basic	Type	Stock-No.	Colour	R [kΩ]	Ø [mm]	Terminal
VD	VD05EM	8422	black	5	10-12	
Rubber sheathed						
 						

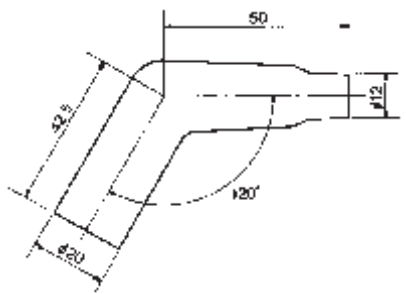
Basic	Type	Stock-No.	Colour	R [kΩ]	Ø [mm]	Terminal
VD	VD05EMH	7744	black	5	10-12	
	VD05FMH	8425	black	5		
Rubber sheathed						
 						

Basic	Type	Stock-No.	Colour	R [kΩ]	Ø [mm]	Terminal
VD	VD05FML	8427	black	5	10-12	
Rubber sheathed  						

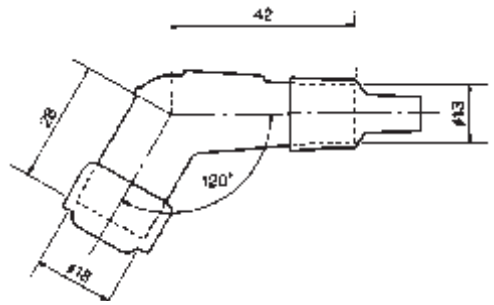
Basic	Type	Stock-No.	Colour	R [kΩ]	Ø [mm]	Terminal
YB	YB01F	8446	black	1	14	
	YB05F	8082	black	5		
	YB05F	8162	red	5		
	YB10F	8449	black	10		
YD	YD01F	8450	black	1	10-12	
	YD05F	8454	black	5		
	YD05F	8453	red	5		
Phenolic Resin  						

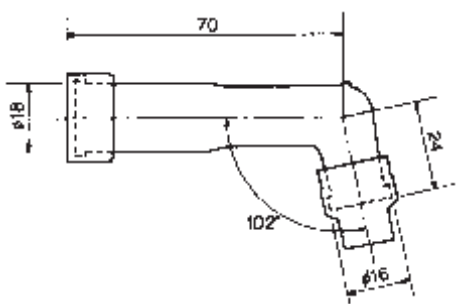
Basic	Type	Stock-No.	Colour	R [kΩ]	Ø [mm]	Terminal
XB	XB01F	8431	black	1	14	
	XB05F	8062	black	5		
	XB05F - R	8592	red	5		
	XB10F	8436	black	10		
XD	XD01F	8439	black	1	10-12	
	XD05F	8072	black	5		
	XD05F - R	8768	red	5		
	XD10F	8442	black	10		
XZ	XZ01F	8443	black	1	10-12-14	
	XZ05F	8444	black	5		
Phenolic Resin  						

Basic	Type	Stock-No.	Colour	R [kΩ]	Ø [mm]	Terminal
XB	XB05FP	8435	black	5	14	⏚
XD	XD05FP	8641	black	5	10 - 12	

Phenolic Resin



Basic	Type	Stock-No.	Colour	R [kΩ]	Ø [mm]	Terminal
TB	TB05EM - R	8955	red	5	14	⏚
	TB10EM - Y	8404	yellow	10		

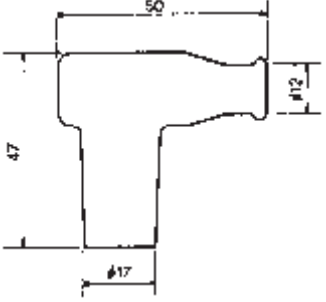

Rubber sheathed





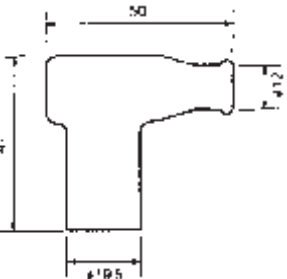

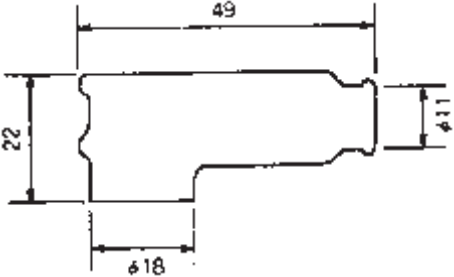

Basic	Type	Stock-No.	Colour	R [kΩ]	Ø [mm]	Terminal
TB	TB05EMA	8636	black	5	14	⏚

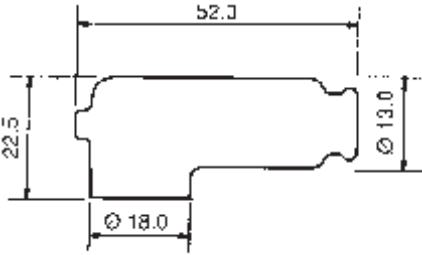

Rubber sheathed





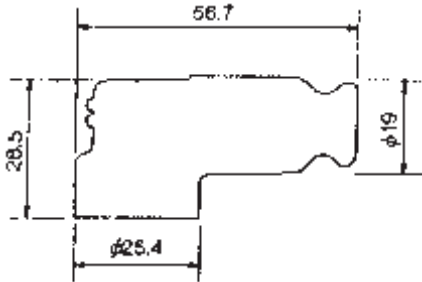

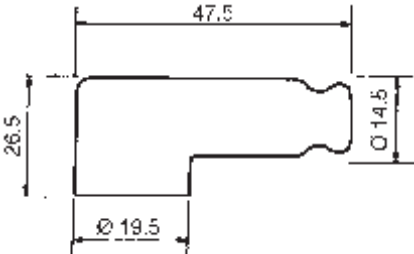

Basic	Type	Stock-No.	Colour	R [kΩ]		Terminal
TB	TRS1225 - B	8787	blue	5	R6120 A/C/M R7282 A/C/M	
<p>Rubber sheathed</p>  						

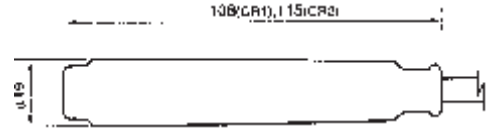

Basic	Type	Stock-No.	Colour	R [kΩ]		Terminal
TB	TRS1233A - R	8929	red	5	R6120 A/C/M R7282 A/C/M	
	TRS1233B - Y	8897	yellow	5		
	TRS1233C - G	8546	green	5		
<p>Rubber sheathed</p>  						

Basic	Type	Stock-No.	Colour	R [kΩ]		Terminal
TB	TRS1408F - B	8871	blue	5	R5300A R5300N	
<p>Rubber sheathed</p>  						

Basic	Type	Stock-No.	Colour	R [kΩ]		Terminal
TB	TRS1409 - R	8733	red	5	R5540F	
<p>Rubber sheathed</p>  						

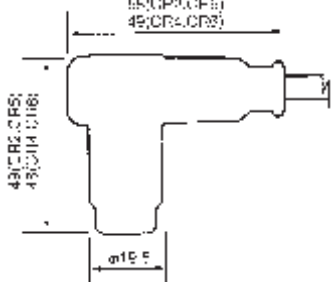
Basic	Type	Stock-No.	Colour	R [kΩ]	Ø [mm]	Terminal
CR	CR1	8035	red	5	10-12-14	
	CR3	8089	red	5		
<p>Rubber sheathed</p>   <p style="text-align: center;">red 500 mm</p> <p style="text-align: right;">CR1: SD05FM CR3: SD05EMK</p>						

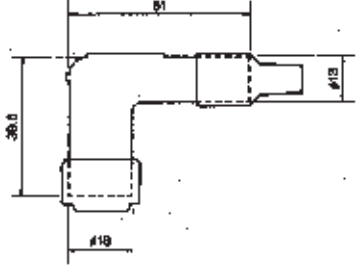

Basic	Type	Stock-No.	Colour	R [kΩ]	Ø [mm]	Terminal
CR	CR2	8048	red	5	10-12-14	
	CR4	8054	red	5		
	CR5	8515	red	5		
	CR6	8736	red	5		
<p>Rubber sheathed</p>   <p style="text-align: center;">red 500 mm</p> <p style="text-align: center;">red 1000 mm</p> <p style="text-align: right;">CR2: LZ05FM CR4: TB05EMA CR5: LZ05FM CR6: TB05EMA</p>						

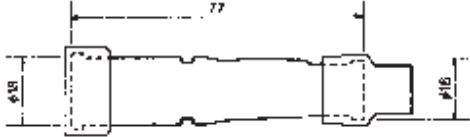
Basic	Type	Stock-No.	Colour	R [kΩ]	Ø [mm]	Terminal
	LY11	8718	red	5	10-12-14	
<p>Phenolic Resin</p>   <p style="text-align: center;">yellow 500 mm</p> <p style="text-align: right;">LZ05F</p>						

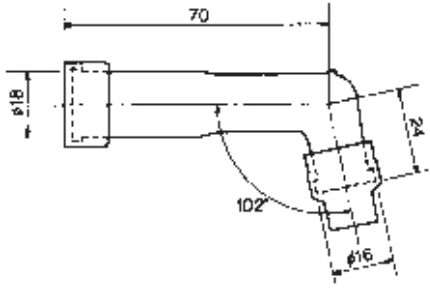
Basic	Type	Stock-No.	Colour	R [kΩ]	Ø [mm]	Terminal
	SY11	8539	red	5	10-12-14	⏚
Phenolic Resin						
					SZ05F	
<p style="text-align: center;">yellow ↔ 500 mm</p>						

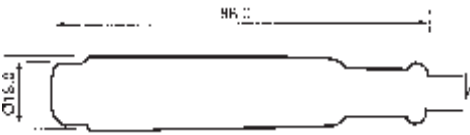
Basic	Type	Stock-No.	Colour	R [kΩ]	Ø [mm]	Terminal
	XY11	8584	red	5	10-12-14	⏚
Phenolic Resin						
					XZ05F	
<p style="text-align: center;">yellow ↔ 500 mm</p>						

Basic	Type	Stock-No.	Colour	R [kΩ]	Ø [mm]	Terminal
	SD05FMC	8393	black	5	10-12	⏚
Rubber sheathed						
					SD05FMC	
<p style="text-align: center;">red ↔ 500 mm</p>						

Basic	Type	Stock-No.	Colour	R [kΩ]	Ø [mm]	Terminal
	RC-X140	5937	black	5	10-12	
<p>Phenolic Resin</p>  <p style="text-align: center;">black ↔ 350 mm</p> <p style="text-align: right;">LD05EAK</p>						

Basic	Type	Stock-No.	Colour	R [kΩ]	Ø [mm]	Terminal
	J-1	8739	black	/		
						



kW



Stock-No

APRILIA

RSV 1000 R	Rotax V2	998	102	04.04-		OZA591-SZ1	1767
RSV 1000 R Factory	Rotax V2	998	102	10.03-		OZA591-SZ1	1767
Tuono 1000 R	Rotax V2	998	102	03.06-		OZA591-SZ1	1767
Tuono 1000 R Factory	Rotax V2	998	102	03.06-		OZA591-SZ1	1767

BMW

F 650 CS		652	25	11.01-12.03		OZA457-EE12	97070
F 650 CS		652	25	11.01-12.03		OZA457-EE12	97070
F 650 GS		652	37	09.99-12.03		OZA457-EE12	97070
F 650 GS Dakar		652	37	09.99-12.03		OZA457-EE12	97070
F 650 CS	K14/02	652	25	01.04-12.05		OZA630-BM3	0074
F 650 CS	K14/02	652	37	01.04-12.05		OZA630-BM3	0074
F 650 GS	R13Mü	652	25	12.03-12.07		OZA630-BM3	0074
F 650 GS	R13Mü	652	37	12.03-12.07		OZA630-BM3	0074
G 650 Xchallenge	K15	650	39	03.07-08.11		OZA630-BM1	0072
G 650 Xmoto	K15	650	39	03.07-08.11		OZA630-BM1	0072
G 650 Xcountry	K15	650	39	03.07-08.11		OZA630-BM1	0072
F 650 GS	K72	798	25	10.07-		OZA630-BM2	0073
F 650 GS	K72	798	52	10.07-		OZA630-BM2	0073
F 800 S	K71	798	25	12.05-		OZA630-BM2	0073
F 800 S	K71	798	62	12.05-		OZA630-BM2	0073
F 800 GS	K72	798	63	10.07-		OZA630-BM2	0073
F 800 ST	K71	798	25	09.06-		OZA630-BM2	0073
F 800 ST	K71	798	62	09.06-		OZA630-BM2	0073
F 800 R	K73	798	25	12.06-02.09		OZA630-BM2	0073
F 800 R	K73	798	62	12.06-02.09		OZA630-BM2	0073
F 800 R	K73/02	798	25	03.09-		OZA630-BM2	0073
F 800 R	K73/02	798	64	03.09-		OZA630-BM2	0073
R 850 R	R28	848	25	07.02-08.05		OZA522-BM1	0053
R 850 R	R28	848	52	07.02-08.05		OZA522-BM1	0053
R 850 RT	R22	848	52	03.01-12.04		OZA522-BM1	0053
R 1100 S	259S	1085	72	01.03-12.03		OZA522-BM1	0053
R 1150 GS	R21	1130	63	11.01-12.03		OZA522-BM1	0053
R 1150 GS Adventure	R21	1130	63	11.01-09.06		OZA522-BM1	0053
R 1150 R	R28	1130	63	10.02-08.05		OZA522-BM1	0053
R 1150 RS	R22	1130	70	05.01-09.04		OZA522-BM1	0053
R 1150 RT	R22	1130	70	03.01-12.04		OZA522-BM1	0053
K 1200 GT	K41GT	1171	72	11.02-08.05		OZA522-BM1	0053
K 1200 GT	K41GT	1171	96	11.02-08.05		OZA522-BM1	0053
K 1200 GT	K44	1157	112	12.05-10.08		OZA630-BM2	0073
K 1200 LT	K589	1171	85	01.04-07.08		OZA522-BM2	0054
K 1200 RS	K41	1171	72	01.01-12.04		OZA522-BM1	0053
K 1200 RS	K41	1171	96	01.01-12.04		OZA522-BM1	0053
K 1200 R	K43	1157	120	03.05-09.08		OZA630-BM2	0073
K 1200 S	K40	1157	123	06.04-09.08		OZA630-BM2	0073
R 1200 C	259C	1170	45	06.03-12.04		OZA522-BM1	0053
R 1200 CL	K30	1170	45	02.02-12.04		OZA522-BM1	0053
R 1200 GS	K25	1170	72	11.03-01.08		OZA630-BM1	0072
R 1200 GS	K25Mü	1170	77	10.07-		OZA630-BM1	0072
R 1200 GS Adventure	K25Mü	1170	77	01.08-		OZA630-BM1	0072
R 1200 R	K27	1170	81	12.06-09.10		OZA630-BM1	0072
R 1200 RT	K26	1170	81	10.04-07.09		OZA630-BM1	0072



kW



Stock-No

BMW

R 1200 S	K29	1170	81	10.05-12.07		OZA630-BM1	0072
R 1200 ST	K28	1170	81	12.04-07.08		OZA630-BM1	0072
HP2	K25HP	1170	77	12.05-12.06		OZA630-BM1	0072
HP2 Megamoto	K25HPMeg	1170	83	10.07-10.08		OZA630-BM1	0072
HP2 Sport	K29 HP	1170	96	11.07-04.10		OZA630-BM1	0072
K 1300 GT	K44TÜ	1293	118	10.08-		OZA630-BM2	0073
K 1300 R	K43Mü	1293	127	10.08-		OZA630-BM2	0073
K 1300 S	K40Mü	1293	129	09.08-		OZA630-BM2	0073

DUCATI

Monster 695		695	54	06.04-07.08		OZA591-BB3	0066
Monster 696		696	59	08.08-	2x	OZA591-BA2	90520
Hypermotard 796		803	60	01.10-	2x	OZA591-BA1	6496
Monster 796		803	64	08.09-	2x	OZA591-BA2	90520
Monster S2R		803	57	04.06-07.08		OZA591-BB3	0066
848		849	99	09.07-		OZA591-BB3	0066
848 S		849	99	09.07-		OZA591-BB3	0066
GT 1000		992	68	01.06-		OZA591-BB3	0066
Monster S2R 1000		992	70	01.06-07.08		OZA591-BB3	0066
Monster S4RS		992	96	06.04-07.08		OZA591-BB3	0066
Paul Smart 1000		992	68	01.06-07.08		OZA591-BB3	0066
ST3		992	79	01.04-12.07		OZA591-BB3	0066
ST3 S		992	79	01.04-12.07		OZA591-BB3	0066
Sport 1000		992	68	01.06-		OZA591-BB3	0066
Desmosedici RR		989	147	07.07-12.08		OZA591-BB3	0066
Hypermotard		1078	70	08.07-12.09		OZA591-BB3	0066
Hypermotard S		1078	70	08.07-12.09		OZA591-BB3	0066
Hypermotard 1100 Evo		1078	70	01.10-	2x	OZA591-BA1	6496
Hypermotard 1100 Evo SP		1078	70	01.10-	2x	OZA591-BA1	6496
Monster 1100		1078	70	01.09-12.10		OZA591-BB3	0066
Monster 1100 S		1078	70	01.09-12.10		OZA591-BB3	0066
Monster 1100 Evo		1078	73	01.11-	2x	OZA591-BA2	90520
Multistrada 1100		1078	70	06.06-12.09		OZA591-BB3	0066
Multistrada 1100 S		1078	70	06.06-12.09		OZA591-BB3	0066
1098		1098	119	11.06-12.08		OZA591-BB3	0066
1098 S		1098	119	11.06-12.08		OZA591-BB3	0066
1098 R		1098	132	01.08-		OZA591-BB3	0066
Streetfighter		1099	116	01.09-		OZA591-BB3	0066
Streetfighter S		1099	116	01.09-		OZA591-BB3	0066
1198		1198	125	01.08-		OZA591-BB3	0066
1198 S		1198	125	01.08-		OZA591-BB3	0066

HONDA

Zoomer 50		50	3	01.05-		OZA577-H13	6475
Pantheon 125i		125	10	01.05-		OZA577-H6	0065
PS 125i		125	10	01.06-		OZA577-H15	0064
SH 125i		125	10	01.05-		OZA577-H15	0064
S-Wing 125		125	10	01.06-		OZA577-H15	0064
PS 150i		150	11	01.06-		OZA577-H15	0064
Pantheon 150i		150	12	01.05-		OZA577-H6	0065
SH 150i		150	11	01.05-		OZA577-H15	0064



kW

0201



Stock-No

HONDA

S-Wing 150		150	11	01.06-		OZA577-H15	0064
S-Wing 150 ABS		150	11	01.06-		OZA577-H15	0064
SH 300		279	28	04.07-		ZSJ0002-HG002	6538
SH 300 ABS		279	28	04.07-		ZSJ0002-HG002	6538
Silver Wing 600		582	37	02.07-		OZA577-H22	6483
Hornet 600		599	75	02.07-		OZA656-H3	6493
CBR 600 RR		599	88	01.07-		OZA577-H24	6484
XL 680 Transalp		680	44	07.08-		OZA656-H1	6491
VT 750		745	34	01.07-	Sensor I	OZA577-H19	6476
VT 750		745	34	01.07-	Sensor II	OZA577-H20	6477
VT 750 Shadow		745	34	01.07-	Sensor I	OZA577-H19	6476
VT 750 Shadow		745	34	01.07-	Sensor II	OZA577-H20	6477
VT 750 Shadow Spirit		745	34	01.07-	Sensor I	OZA577-H19	6476
VT 750 Shadow Spirit		745	34	01.07-	Sensor II	OZA577-H20	6477
VFR 800		782	80	01.99-12.99		OZA333-H16	6456
VFR 800		782	80	01.00-12.00		OZA333-H29	6459
VFR 800		782	80	01.01-	Sensor I	OZA333-H30	6460
VFR 800		782	80	01.01-	Sensor II	OZA333-H31	6462
XL 1000 Varadeiro		996	69	01.03-12.06		OZA577-H7	6471
XL 1000 Varadeiro		996	69	01.07-		OZA656-H2	6492
CBF 1000		998	72	01.06-		OZA577-H17	0007
CBF 1000 ABS		998	72	01.06-		OZA577-H17	0007
CBR 1000 RR Fireblade		998	126	02.04-12.05		OZA577-H12	6473
CBR 1000 RR Fireblade		998	126	01.06-12.07		OZA577-H21	6479
CBR 1000 RR Fireblade		1000	131	01.08-		AZD0102-HG009	6576
CBR 1100 XX Super Blackbird		1137	112	01.03-12.07		AZD0101-HG004	6543
Pan European		1261	93	01.06-08.07	Sensor I	OZA577-H4	6463
Pan European		1261	93	01.06-08.07	Sensor II	OZA577-H5	6469
Pan European		1261	93	09.07-	Sensor I	OZA656-H5	6494
Pan European		1261	93	09.07-	Sensor II	OZA656-H6	6495
CB 1300		1284	85	03.08-	Sensor I	AZD0102-HG003	7664
CB 1300		1284	85	03.08-	Sensor II	AZD0102-HG004	7665
CB 1300 S		1284	85	03.08-	Sensor I	AZD0102-HG003	7664
CB 1300 S		1284	85	03.08-	Sensor II	AZD0102-HG004	7665
VTX 1800		1795	71	01.03-12.05		AZD0101-HG003	6541
GL 1800 Gold Wing		1832	87	01.04-12.06	Sensor I	OZA577-H27	1346
GL 1800 Gold Wing		1832	87	01.04-12.06	Sensor II	OZA577-H28	1347
GL 1800 Gold Wing		1832	87	01.07-	Sensor I	AZD0101-HG001	6539
GL 1800 Gold Wing		1832	87	01.07-	Sensor II	AZD0101-HG002	6540

HUSQVARNA

TE 450		449	21	09.07-		OZA591-WB1	0010
SM 450 R		449	14	09.07-		OZA591-WB1	0010
SM 510 R		501	14	09.07-		OZA591-WB1	0010
SM 610		576	39	10.06-		OZA591-WB1	0010

HYOSUNG

GT 650i		647	25	01.07-		OZA591-WB1	0010
GT 650i		647	60	01.07-		OZA591-WB1	0010
GV 650i		647	24	01.07-		OZA591-WB1	0010
GV 650i		647	59	01.07-		OZA591-WB1	0010



kW



Stock-No

KAWASAKI

ZX-6R Ninja		599	25	01.07-	Sensor I	AZD0101-KJ002	6552
ZX-6R Ninja		599	25	01.07-	Sensor II	AZD0101-KJ006	6559
ZX-6R Ninja		599	72	01.07-	Sensor I	AZD0101-KJ002	6552
ZX-6R Ninja		599	72	01.07-	Sensor II	AZD0101-KJ006	6559
ZX-6R Ninja		599	92	01.07-	Sensor I	AZD0101-KJ002	6552
ZX-6R Ninja		599	92	01.07-	Sensor II	AZD0101-KJ006	6559
ZX-10R		998	128	11.05-05.06		AZD0101-KJ001	6551
ZX-10R		998	129	06.06-12.07	Sensor I	AZD0101-KJ004	6556
ZX-10R		998	129	06.06-12.07	Sensor II	AZD0101-KJ005	6558
ZX-10R		998	129	01.08-	Sensor I	AZD0102-KJ003	6568
ZX-10R		998	129	01.08-	Sensor II	AZD0102-KJ004	6574
ZZR 1400		1352	72	01.07-12.07	Sensor I	AZD0101-KJ004	6556
ZZR 1400		1352	72	01.07-12.07	Sensor II	AZD0101-KJ008	6561
ZZR 1400		1352	140	01.07-12.07	Sensor I	AZD0101-KJ004	6556
ZZR 1400		1352	140	01.07-12.07	Sensor II	AZD0101-KJ008	6561
ZZR 1400		1352	142	01.08-		AZD0102-KJ001	6567

KTM

690 Enduro		654	45	03.08-		AZD0101-VB002	7673
690 Supermoto		654	47	03.07-		AZD0101-VB002	7673
690 Supermoto R		654	46	03.08-		AZD0101-VB002	7673
690 SMC		654	45	03.08-		AZD0101-VB002	7673
690 Duke		654	48	03.08-		AZD0101-VB002	7673
990 Adventure		999	25	01.06-		OZA591-VB2	0009
990 Adventure		999	72	01.06-		OZA591-VB2	0009
990 Adventure S		999	72	01.06-		OZA591-VB2	0009
990 Superduke		999	88	01.06-		OZA591-VB2	0009
990 Superduke R		999	88	01.06-		OZA591-VB2	0009
990 Supermoto		999	85	03.08-		OZA591-VB2	0009

KYMCO

People S 200i		163	8	01.07-		AZD0101-BA001	7667
People S 250i		251	15	01.07-		AZD0101-BA001	7667
Yager GT 200i		176	11	06.06-		OZA591-YB1	0011
Venox 250 AFI		249	21	06.06-		OZA591-YB1	0011
Xciting 250i		251	16	06.06-		OZA591-YB1	0011

MV AGUSTA

F4 Brutale 910		910	100	10.06-12.08		OZA591-BB2	1710
Brutale 989 R		989	104	01.09-		OZA591-BB2	1710
F4 1000R		998	128	10.06-12.08		OZA591-BB2	1710
Brutale 1078 RR		1078	108	01.09-		OZA591-BB2	1710
F4 1000CC		1078	141	07.07-12.08		OZA591-BB2	1710
F4 1078 RR		1078	140	01.09-		OZA591-BB2	1710

MOTO GUZZI

Breva V 750 i.e.		744	25	01.03-12.05		OZA341-BB1	0036
Breva V 750 i.e.		744	36	01.03-12.05		OZA341-BB1	0036
Breva V 750 i.e.		744	36	01.06-		OZA591-BB2	1710
Nevada V 750 i.e.		744	36	01.06-		OZA591-BB2	1710



kW



Stock-No

MOTO GUZZI

Breva V 850 i.e.		877	53	01.06-		OZA591-BB2	1710
Griso V 850 i.e.		877	56	01.06-		OZA591-BB2	1710
Norge V 850 i.e.		877	53	01.06-		OZA591-BB2	1710
Breva V 1100		1064	62	03.04-12.05		OZA341-BB1	0036
Breva V 1100 i.e.		1064	63	01.06-		OZA591-BB2	1710
California EV		1064	55	03.04-12.05		OZA341-BB1	0036
California EV Touring		1064	55	03.04-12.05		OZA341-BB1	0036
California Classic		1064	55	01.06-12.05		OZA341-BB1	0036
California Classic		1064	54	01.06-		OZA591-BB2	1710
California Touring		1064	55	01.06-12.05		OZA341-BB1	0036
California Vintage		1064	55	01.06-12.05		OZA341-BB1	0036
California Vintage		1064	54	01.06-		OZA591-BB2	1710
Griso V 1100 i.e.		1064	65	01.06-		OZA591-BB2	1710
V11 Cafè Sport		1064	67	03.04-12.04		OZA341-BB1	0036
V11 Coppa Italia		1064	67	03.04-12.05		OZA341-BB1	0036
V11 Le Mans		1064	67	03.04-12.05		OZA341-BB1	0036
V11 Le Mans Nero		1064	67	03.04-12.05		OZA341-BB1	0036
V11 Le Mans Rosso Corsa		1064	67	03.04-12.05		OZA341-BB1	0036
V11 Scura R		1064	67	01.05-12.05		OZA341-BB1	0036
V11 Sport Ballabio		1064	67	03.04-12.05		OZA341-BB1	0036
Norge V 1200 i.e.		1151	66	01.06-		OZA591-BB2	1710
Sport V 1200 i.e.		1151	70	01.06-		OZA591-BB2	1710
Stelvio 1200 4V		1151	81	01.09-		OZA591-BB2	1710

MOTO MORINI

Corsaro 1200		1187	103	01.05-		OZA591-BB2	1710
9 1/2		1187	86	01.05-		OZA591-BB2	1710

PEUGEOT

Geopolis 125		125	11	03.06-		OZA591-SZ1	1767
Satelis 125		125	11	03.06-		OZA591-SZ1	1767
Satelis 125 K15 Compressor		125	11	03.06-		OZA591-SZ1	1767
Satelis 125 K20 Compressor		125	15	03.06-		OZA591-SZ1	1767

ROYAL ENFIELD

Bullet 500 Classic		499	20	01.09-		AZD0101-VB001	7672
Bullet 500 Electra		499	20	01.09-		AZD0101-VB001	7672

SUZUKI

RV 125 VanVan		125	9	01.07-		AZD0101-SU002	6547
GSX-R 600		599	91	03.06-12.07		OZA448-J4	0003
GSX-R 600		599	91	01.08-		AZD0101-SU005	7671
AN 650 Burgman		638	40	01.03-12.03		OZA523-J1	1333
DL 650 V-Strom		645	25	03.06-		OZA591-J2	6454
DL 650 V-Strom		645	49	03.06-		OZA591-J2	6454
SV 650		645	25	01.07-		AZD0101-SU005	7671
SV 650 S		645	25	02.07-		AZD0101-SU005	7671
SV 650		645	53	01.07-		AZD0101-SU005	7671
SV 650 S		645	53	02.07-		AZD0101-SU005	7671
GSX-R 750		750	110	03.06-12.07		OZA448-J4	0003
GSX-R 750		750	110	01.08-		AZD0101-SU005	7671



kW



Stock-No

SUZUKI

VL 800 Intruder		805	39	05.04-		AZD0101-SU001	6545
DL 1000 V-Strom		996	72	05.02-12.06		OZA448-J2	6414
TL 1000		996	92	05.07-12.00		OZA448-J3	6415
GSX-R 1000		999	136	01.07-		AZD0101-SU004	7668
Bandit 1200		1157	72	11.06-12.07		AZD0101-SU005	7671
Bandit 1200 S		1157	72	11.06-12.07		AZD0101-SU005	7671
GSX-R 1300 Hayabusa		1299	129	05.02-12.06		OZA448-J1	6413
GSX-R 1300 Hayabusa		1299	129	05.07-		AZD0101-SU004	7668
VL 1500 Intruder		1462	49	01.06-		AZD0101-SU002	6547
M 1800 R		1783	92	04.06-12.07		OZA448-J5	0004
VZR 1800 Intruder		1783	92	01.08-		OZA582-J3	6446
VZR 1800 Intruder		1783	92	01.08-		OZA582-J4	6447

TRIUMPH

Daytona 600		599	25	01.03-12.05		OZA591-UB1	0067
Daytona 600		599	72	01.03-12.05		OZA591-UB1	0067
Daytona 600		599	82	01.03-12.05		OZA591-UB1	0067
Speed Four		599	25	01.02-		OZA591-UB1	0067
Speed Four		599	72	01.02-		OZA591-UB1	0067
Daytona 675		675	25	01.07-		AZD0101-VB003	7689
Daytona 675		675	72	01.07-		AZD0101-VB003	7689
Daytona 675		675	91	01.07-		AZD0101-VB003	7689
Street Triple 675		675	25	01.08-		AZD0101-VB003	7689
Street Triple 675		675	78	01.08-		AZD0101-VB003	7689
Thunderbird Sport		855	67	01.03-12.04		OZA591-UB1	0067
America		865	25	01.07-		AZD0101-VB003	7689
America		865	41	01.07-		AZD0101-VB003	7689
Bonneville		865	25	01.07-		AZD0101-VB003	7689
Bonneville		865	50	01.07-		AZD0101-VB003	7689
Scrambler		865	25	01.07-		AZD0101-VB003	7689
Scrambler		865	42	01.07-		AZD0101-VB003	7689
Thrupton		865	25	01.07-		AZD0101-VB003	7689
Thrupton		865	51	01.07-		AZD0101-VB003	7689
Daytona 955i		955	72	01.01-		OZA591-UB1	0067
Daytona 955i		955	108	01.01-		OZA591-UB1	0067
Speed Triple		955	72	01.01-12.05		OZA591-UB1	0067
Speed Triple		955	108	01.01-12.04		OZA591-UB1	0067
Sprint RS		955	72	01.01-12.04		OZA591-UB1	0067
Sprint RS		955	108	01.01-12.04		OZA591-UB1	0067
Sprint ST		955	72	01.01-12.04		OZA591-UB1	0067
Sprint ST		955	108	01.01-12.04		OZA591-UB1	0067
Tiger		955	72	01.03-12.06		OZA591-UB1	0067
Tiger		1050	72	01.07-		AZD0101-VB002	7673
Tiger		955	78	01.04-12.06		OZA591-UB1	0067
Tiger		1050	84	01.07-		AZD0101-VB002	7673
Sprint ST		1050	72	01.05-12.07		OZA591-UB1	0067
Sprint ST		1050	72	01.08-		AZD0101-VB002	7673
Sprint ST		1050	92	01.05-12.07		OZA591-UB1	0067
Sprint ST		1050	93	01.08-		AZD0101-VB002	7673
Speed Triple		1050	72	01.06-12.07		OZA591-UB1	0067
Speed Triple		1050	72	01.08-		AZD0101-VB002	7673
Speed Triple		1050	95	01.05-12.07		OZA591-UB1	0067

GB Cross Reference Guide*

Note : This chart is furnished as a guide. Due to differences in design, materials, etc., products by various manufacturers may not match. See therefore our recommendation for the proper use of the acquired product.

D Referenzliste*

Anmerkung: Diese Liste dient nur zur Information. Bedingt durch Unterschiede hinsichtlich Konstruktion, Werkstoffen usw. können Produkte verschiedener Hersteller nicht zusammenpassen. Siehe daher unsere Empfehlung für die richtige Anwendung des erworbenen Produkts.

F Tableau de comparaison*

Note: Cette liste est donnée à titre indicative. De par leurs différences de conceptions, matériaux, etc., les pièces produites par les différents fabricants n'ont pas exactement les mêmes caractéristiques. Se reporter au tableau d'affectations NGK pour déterminer la référence adaptée à l'application.

I Tabelle comparative*

Nota: Questa tabella viene fornita a scopo di guida. A causa della differenza nel design, materiali ecc., le bobine prodotte da un altro costruttore potrebbero non corrispondere. Attenersi alle nostre raccomandazioni per il corretto utilizzo del prodotto.

E Guia de equivalencias*

Nota: Este cuadro le servirá como guía. Debido a la diferencia en el diseño, materiales , etc., las bobinas producidas por otro fabricante pueden no coincidir. Siga nuestras recomendaciones para el uso adecuado del producto.

NL Kruistabel*

Let op : Deze tabel dient als leidraad. Door verschillen in ontwerp, materialen, enz. kunnen producten die door verschillende fabrikanten zijn vervaardigd afwijken. Zie ook onze aanbeveling voor het juiste gebruik van het product dat u gekocht heeft.

P Guia de referência cruzada*

Nota: Este gráfico é fornecido como guia. Devido a diferenças em termos de design, materiais, etc., os produtos dos vários fabricantes poderão não corresponder. Conseqüentemente, consulte a nossa recomendação quanto à utilização adequada do produto adquirido.

GR Οδηγός παραπομπών*

Σημείωση: Αυτός ο πίνακας παρέχεται ως οδηγός. Λόγω των διαφορών στη σχεδίαση, στα υλικά κ.λπ., τα προϊόντα από διάφορους κατασκευαστές ενδέχεται να παρουσιάζουν ασυμφωνίες. Συνεπώς, ανατρέξτε στις συστάσεις μας για την ενδεδειγμένη χρήση του προϊόντος που έχετε αποκτήσει.

TR Çapraz Referans Kılavuzu*

Not: Bu tablo referans amaçlıdır. Tasarım, malzeme ve benzeri şeylerdeki farklılıklar sebebiyle, farklı üreticilerin ürünleri eşleşmeyebilir. Bu yüzden alınan ürünün uygun kullanımı ile ilgili tavsiyelerimize bakın.

PL Listy porównawcze*

Uwaga: Załączona lista zamienników powinna być traktowana jedynie jako wskazówka. Ze względu na różnice w kształcie, zastosowanych materiałach itp., produkty poszczególnych producentów mogą się różnić między sobą. Z powyższych powodów prosimy stosować się do zaleceń dotyczących użytkowania produktu.

RUS Справочник соответствия продуктам других производителей*

Примечание: Данная таблица предоставлена в качестве справочной. Продукты разных производителей могут не соответствовать друг другу вследствие отличий в конструкции, материалах и т. п. Просим вас руководствоваться нашими рекомендациями по надлежащему использованию приобретенного продукта.

*German law is applicable



ACDelco	→ NGK	Quick
44	B6S	Q302
45	B-4	
46	B-4	
48	B-4	
40 TS	BP7FS	
41 F	B6HS-10	
41 TS	BP6FS	
41 XL	B9ES	Q202
41 XLS	BP7ES	Q206
41-101	ITR4A15	
412 XLS	BP7ES	Q206
414 XLS	BP6ES	
41-600	TR55IX	
41-601	BPR6ES	
41-602	FR5	
41-603	FR4	
41-606	TR55	
41-608	FR45	
41-610	FR4	
41-611	FR45	
41-627	BKR4E-11	
41-628	FR4	
41-812	TR6IX	
41-900	TR5	
41-902	TR55	
41-904	TR5	
41-905	UR4	
41-906	TR5	
41-907	TR5	
41-908	BPR5EFIX-13P	
41-910	TR5	
41-913	TR55	
41-919	TR55	
41-921	TR55	
41-928	TR55-1	
41-929	TR55	
41-932	TR55	
41-933	PTR4B-15	
41-936	TR55	
41-940	TR55	
41-942	TR55	
41-943	TR55	
41-947	TR55	
41-948	TR4IX	
41-950	PTR5C-13	
41-952	BPR5EFIX-13P	
41-963	PTR5C-13	
41-974	PZTR5A-15	
41-983	PZTR5A-15	
41-987	PTR5C-13	
42 F	B6HS	Q203
42 FF	B6HS	Q203

ACDelco	→ NGK	Quick
42 FS	BP6HS	
42 S	BP6S	
42 TS	BP6FS	
42 XL	B8ES	Q201
42 XLS	BP6ES	
420 Z	B-4H	
422 Z	B5HS	
425 F	B6HS	Q203
425 Z	B6HS	Q203
426 FS	BP6HS	
43 F	B6HS	Q203
43 FFS	BP6HS	
43 FS	BP6HS	
43 N	B7ES	
43 S	BP6S	
43 TS	BP6FS	
43 XL	B7ES	
43 XLS	BP6ES	
430 Z	B7HS	Q204
436 XLS	BP9ES	
438 XLS	BP8ES	
44 F	B5HS	
44 FF	B5HS	
44 FFS	BP5HS	
44 N	B6ES	
44 NS	BP5ES	
44 S	BP5S	
44 TS	BP5FS	
44 XL	B6ES	
44 XLO	BP5ES	
44 XLS	BP5ES	
440 T	B7FS	
440 XLS	BP8ES	
445 Z	B8HS	Q205
45 F	B5HS	
45 FF	B5HS	
45 FFS	BP5HS	
45 L	B-4L	
45 NS	BP5ES	
45 S	BP5S	
45 TS	BP4FS	
45 XL	B6ES	
45 XLS	BP5ES	
46 F	B5HS	
46 FF	B5HS	
46 FFS	BP5HS	
46 N	B5ES	
46 S	BP5S	
46 TS	BP4FS	
46 XL	B5ES	
46 XLS	BP4ES	
47 FF	B-4H	



ACDelco	→ NGK	Quick
47 S	BP-4	
47 XL	B4ES	
83 CTS	AP6FS	
83 TS	AP6FS	
84 T	A6FS	
84 TS	AP5FS	
85 TS	AP5FS	
86 TS	AP5FS	
B 4021	B6S	Q302
B 4031	B-4	
B 43	B6S	Q302
B 44 FS	BP5HS	
B 44 S	BP5S	
B 45	B-4	
C 41	B7S	
C 42 CFS	BP6HS	
C 42 CLTS	BP6EFS	
C 42 CXLS	BP6ES	
C 42 LTS	BP6EFS	
C 42 N	B7ES	
C 42 XLS	BP5ES	
C 421	B6S	Q302
C 43	B6S	Q302
C 43 CXLS	BP6ES	
C 43 L	B-6L	
C 43 N	B6ES	
C 44	B6S	Q302
C 44 N	B6ES	
C 44 NS	BP5ES	
C 44 S	BP5S	
C 44 XL	B6ES	
C 45	B-4	
C 45 L	B-4L	
C 46	B-4	
C 47	B-4	
C 47 W	B-4	
C 49	B-2	
C 73	G-2Z	
C 75	G-2Z	
C 81	AB-8	
C 82	AB-7	
C 82 T	A7FS	
C 83	AB-7	
C 83 T	A6FS	
C 84 T	A6FS	
C 85	AB-6	
C 85 TS	AP5FS	
C 86	AB-6	
C 87	AB-6	
C 88	AB-2	
C 88 L	AB-2	
CFR 1 CLS	BCPR7ES	

ACDelco	→ NGK	Quick
CFR 2 CLS	BKR6ES	
CR 42 CFS	BPR6FS	
CR 42 CXLS	BPR6ES	
CR 42 N	BR7ES	
CR 43	BR6S	
CR 43 CXLS	BPR6ES	
CR 43 K	BR6S	
CR 43 N	BR6ES	
CR 43 S	BP6S	
CR 43 TS	BPR5FS-11	
CR 43 TSM	BPR5FS-11	
CR 44 N	BR6ES	
CR 44 NS	BPR5ES	
CR 44 TS	BPR5FS-11	
CR 45 TS	UR4	
CR 83 T	AR6FS	
CS 40	BM7A	
CS 41	BM7A	
CS 41 T	BM7F	
CS 42	BM7A	
CS 42 S	BM7A	
CS 42 T	BM6F	
CS 45	BM6A	Q303
CS 45 T	BM6F	
CS 49	BM4A	
CSR 45	BMR6A	Q307
FR 2 LS	BKR6ES	
FR 2 LSK	BKR6ES	
FR 3 CLS	BKR5ES	
FR 3 CLS 6	BKR5ES-11	
FR 3 LM	ZFR5A-11	
FR 3 LS	BKR5ES	
FR 3 LS 6	BKR5ES-11	
FR 3 LSJ	BKR4E-11	
FR 3 LSK	BKR5ES	
FR 4 LE	ZFR4F-11	
FR 4 LSJ	BKR4E-11	
FR 5 LS	BKR5ES	
LM 46	B4-LM	Q301
LM 49	B4-LM	Q301
M 40 FF	B9HS	
M 40 FFX	B9HS-10	
M 41 FF	B8HS	Q205
M 41 K	B8S	
M 42 FF	B7HS	Q204
M 42 K	B7S	
M 43 FF	B6HS	Q203
M 43 S	BP6S	
M 44 B	B6S	Q302
M 44 C	B6S	Q302
M 44 L	B-6L	
M 45	B-4	



ACDelco	→ NGK	Quick
M 45 FF	B5HS	
M 47	B-4	
M 86	AB-6	
MB 42 K	B6S	Q302
MC 104 F	C6HSA	
MC 122 F	D8HA	
MC 124 FS	D6HA	
MC 41	B8S	
MC 41 F	B8HS	Q205
MC 42	B8S	
MC 42 F	B7HS	Q204
MC 44	B7S	
MR 42 K	BR6S	
MR 42 LTS	BPR6EFS	
MR 43 LTS	BPR6EFS	
MR 43 T	BR6FS	
MR 44 C	BR6S	
MR 44 T	BR5FS	
MR 45	B-4	
R 41 CF	BR7HS	Q211
R 41 CXL	BR9ES	Q208
R 41 CXLS	BPR7ES	
R 41 TS	BPR6FS	
R 415 TS	BPR6FS	
R 42 CF	BR6HS	Q209
R 42 CFS	BPR6HS	Q214
R 42 CFS	BPR6HS	Q214
R 42 CFS	BPR6HS	Q214
R 42 CLTS	BPR6EFS	
R 42 CT	BR6FS	
R 42 CTS	BPR6FS	
R 42 CXL	BR8ES	Q207
R 42 CXLS	BPR6ES	
R 42 FS	BPR6HS	Q214
R 42 FS	BPR6HS	Q214
R 42 FS	BPR6HS	Q214
R 42 LTS	BPR6EFS	
R 42 LTSM	BPR5EFS-13	
R 42 S	BP6S	
R 42 T	BR6FS	
R 42 TS	BPR6FS	
R 42 TSM	BPR6FS	
R 42 TX	BR6FS	
R 42 XL	BR8ES	Q207
R 42 XLS	BPR6ES	
R 42 XLSM	ZGR5C	
R 425 LTS	BPR6EFS	
R 425 TS	BPR6FS	
R 426 FS	BPR6HS	Q214
R 426 FS	BPR6HS	Q214
R 426 FS	BPR6HS	Q214
R 43	BR6S	

ACDelco	→ NGK	Quick
R 43 C	BR6S	
R 43 CFS	BPR6HS	Q214
R 43 CFS	BPR6HS	Q214
R 43 CFS	BPR6HS	Q214
R 43 CNTSE	TR5-1	
R 43 CS	BP6S	
R 43 CT	BR6FS	
R 43 CTS	BPR6FS	
R 43 CTS 6	BPR6FS	
R 43 CXL	BR7ES	
R 43 CXLS	BPR6ES	
R 43 FS	BPR6HS	Q214
R 43 FS	BPR6HS	Q214
R 43 FS	BPR6HS	Q214
R 43 LTS	BPR6EFS	
R 43 LTSE	TR4	
R 43 LTSX	BPR6EFS-13	
R 43 N	BR7ES	
R 43 NTSE	TR5-1	
R 43 S	BP6S	
R 43 T	BR6FS	
R 43 TS	BPR6FS	
R 43 TSK	BPR6FS	
R 43 TSX	BPR6FS	
R 43 TX	BR6FS	
R 43 XL	BR7ES	
R 43 XLS	BPR6ES	
R 44	BR6S	
R 44 CF	BR5HS	
R 44 CNTSE	TR5-1	
R 44 CXL	BR6ES	
R 44 CXLS	BPR5ES	
R 44 F	BR5HS	
R 44 LTS	BPR5EFS	
R 44 LTS 6	BPR5EFS-13	
R 44 LTS 6K	BPR5EFS-13	
R 44 LTSM	TR4	
R 44 LTSM 6	TR4	
R 44 N	BR6ES	
R 44 NS	BPR5ES	
R 44 NTSE	TR5-1	
R 44 S	BP5S	
R 44 T	BR5FS	
R 44 TS	BPR5FS	
R 44 TSX	BPR5FS-15	
R 44 TX	BR5FS	
R 44 XL	BR6ES	
R 44 XLS	BPR5ES	
R 44 XLS 6	BPR4ES-13	
R 44 XLSE	ZGR5C	
R 44 XLSM	ZGR5C	
R 45	BR6S	



ACDelco	→ NGK	Quick
R 45 LTS 6	BPR5EFS-13	
R 45 LTS 6K	BPR5EFS-13	
R 45 NS	BPR5ES	
R 45 NSX	BPR5ES-13	
R 45 NTSE	TR5-1	
R 45 S	BP5S	
R 45 T	BR5FS	
R 45 TS	BPR4FS	
R 45 TSX	BPR4FS-15	
R 45 XL	BR6ES	
R 45 XLS	BPR5ES	
R 46	BR6S	
R 46 LTS	BPR5EFS	
R 46 N	BR5ES	
R 46 S	BP-4	
R 46 SZ	XR45IX	
R 46 T	BR5FS	
R 46 TS	BPR4FS	
R 46 TSX	BPR4FS-15	
R 46 TX	BR5FS	
R 46 XL	BR5ES	
R 46 XLS	BPR4ES	
R 47 S	BP-4	
R 83 CT	AR6FS	
R 83 CTS	APR6FS	
R 83 TS	APR6FS	
R 84 TS	APR5FS	
R 85 TS	APR5FS	
S 102 F	C7HSA	
S 104 F	C6HSA	
S 121 F	D8HA	
S 121 XL	D8EA	Q216
S 122 F	D8HA	
S 123 XL	D7EA	
S 124 FS	D6HA	
S 40 F	B9HS	
S 40 FR	BR9HS	
S 40 XL	B10ES	
S 40 XLG	B9ECS	
S 40 XLR	BR8ES	Q207
S 404 XLG	B10EG	
S 408 XLG	B9EG	
S 41 F	B8HS	Q205
S 41 FG	B7HCS	
S 41 FR	BR8HS	Q212
S 41 XL	B9ES	Q202
S 41 XLG	B8ECS	
S 41 XLR	BR9ES	Q208
S 42	B7S	
S 42 F	B7HS	Q204
S 42 FR	BR7HS	Q211
S 42 XL	B8ES	Q201

ACDelco	→ NGK	Quick
S 42 XLR	BR8ES	Q207
S 43 XL	B7ES	
S 43 XLR	BR7ES	
S 44	B6S	Q302
S 44 F	B5HS	
S 44 XL	B6ES	
S 45 F	B5HS	
S 46	B-4	
S 81 F	AB-8	
S 82 F	AB-8	
S 83 F	AB-7	
S 85 F	AB-6	
SB 41	B7S	
SN 46	B-4	
SV 4 XL	BUE	
SV 41 XL	BUE	
TC 42	B8S	
TC 45	B6S	Q302
TC 49	B-2	
TC 81	AB-8	
TC 82	AB-8	
TC 83	AB-7	
TC 85	AB-6	
TC 86	AB-6	
V 40 FFK	BUHW-2	
V 40 FFM	BUHW	
V 40 FFS	BUH	
VB 40 FFM	BUHXW-1	
VR 40 FFK	BUZHW-2	
VR 40 FFM	BUZHW	
APRILIA	→ NGK	Quick
2 BEN 000181	CPR8E	
2 BEN 000276	CPR8E	
2 BEN 000319	ZMR7AP	
297 542	DR8EA	
297 547	DR8EB	
297 830	BR10EG	
297 920	CR8E	Q226
297 921	CR8EIX	
297 942	DCPR9E	
297 945	R0045J-10	
8 122 586	DR7EA	
8 176 075	BPR4HS	
8 206 870	BR7HS	Q211
8 206 871	BR8HS	Q212
8 206 873	BR8ES	Q207
8 206 915	BR9ES	Q208
8 224 684	CR7EB	
8 224 685	CR9EB	
8 520 007	CR7E	Q225
8 550 352	CR7E	Q225



APRILIA	→ NGK	Quick
8 560 146	CR7EKB	
8 570 084	CR8EB	
8 600 008	BR9ECM	
897 055	BR8ES	Q207
ARCTIC CAT	→ NGK	Quick
0217-027	BR6HS	Q209
0217-028	BR9EIX	
0217-028	BR9ES	Q208
0217-029	B8ES	Q201
0217-034	BR8ES	Q207
0217-035	BR9ES	Q208
0217-035	BR10EIX	
0217-632	CR6E	
0217-634	BR10ES	
0217-700	BR9ES	Q208
0217-703	BPR6ES	
0217-705	CR8E	Q226
0217-708	CR7E	Q225
0217-709	BR9EYA	
0217-713	DR7EA	
0217-716	BPR7HS	Q215
0217-717	DCPR7E	
0217-719	KR8AI	
0217-725	CR6HSA	
0217-726	CR7HSA	
0217-726	CR7HSA	
0217-729	BR9EIX	
0217-729	BR9ES	Q208
0217-730	DPR7EA-9	Q220
0217-730	DPR7EA-9	Q220
0217-738	CR9E	Q227
0217-762	BPR9ES	
0217-796	D8EA	Q216
0217-799	CPR8E	
0217-804	BR10ES	
0217-804	BR10EIX	
0217-806	MR8AI9	
0217-809	BPR4ES	
0217-813	CR8EB	
3304-919	DR8EA	
BERU	→ NGK	Quick
0 001 245 700	D7EA	
0 001 325 701	BP5ES	
0 001 325 704	BP5ESZ	
0 001 325 705	BCP5ES	
0 001 325 710	BP5ET	
0 001 330 104	BUR5ET	
0 001 330 112	BUR5ET-10	
0 001 330 113	BUR5ET	

BERU	→ NGK	Quick
0 001 330 116	BKUR5ET-10	
0 001 330 119	BKUR5ET	
0 001 330 501	BKR6EK	
0 001 330 702	BP5ES	
0 001 330 707	BCP5ES	
0 001 330 709	BP5ET-10	
0 001 330 713	BP5ESZ	
0 001 330 717	ZFR5F	
0 001 330 718	ZGR5A	
0 001 330 725	BCP5ES	
0 001 330 726	BP5ESZ	
0 001 330 731	BCP5ES	
0 001 330 780	BKR6EZB	
0 001 330 904	IFR5D10	
0 001 335 107	BKUR6ET-10	
0 001 335 107	BKUR6ET-10	
0 001 335 108	BUR6ET	
0 001 335 702	BP6ES	
0 001 335 707	B6ES	
0 001 335 709	BUR6ET	
0 001 335 714	BP6ESZ	
0 001 335 721	BCP6ES	
0 001 335 725	BCP6ES	
0 001 335 729	BKR6ES	
0 001 335 732	BKR6EK	
0 001 335 737	BP6ESZ	
0 001 335 742	ZFR5P-G	
0 001 335 905	IFR6D10	
0 001 335 910	IFR6D10	
0 001 335 911	PZFR5D-11	
0 001 335 914	PFR6Q	
0 001 340 103	BKUR6ET	
0 001 340 702	BP6ES	
0 001 340 704	BUR6ET	
0 001 340 706	BCP6ET	
0 001 340 707	BP6ESZ	
0 001 340 716	BCP6ES	
0 001 340 717	BCP6ET	
0 001 340 723	BKR6ES	
0 001 340 806	BKR6ES	
0 001 340 903	BP6ES	
0 001 340 908	PFR7Q	
0 001 345 702	BP7ES	Q206
0 001 345 704	BUR6ET	
0 001 345 711	BP7ES	Q206
0 001 345 720	BCP7ES	
0 001 350 903	BP7ES	Q206
0 001 355 700	B9ES	Q202
0 001 400 701	B6HS	Q203
0 001 430 700	BP5HS	
0 001 430 701	B5HS	
0 001 435 700	BP6HS	



BERU	→ NGK	Quick
0 001 435 705	B6HS	Q203
0 001 440 700	BP6HS	
0 001 445 700	BP7HS	
0 001 445 702	B7HS	Q204
0 001 450 702	B8HS	Q205
0 001 455 702	B9HS	
0 001 529 302	B-4	
0 001 625 700	BP5EFS	
0 001 625 702	BP5EFS	
0 001 630 700	BP5EFS	
0 001 630 704	BP5EFS	
0 001 635 700	BP6EFS	
0 001 635 709	BP6EFS	
0 001 640 700	BP6EFS	
0 001 640 704	BP6EFS	
0 001 640 705	BP6EFS	
0 001 645 700	BP7EFS	
0 001 645 703	BP7EFS	
0 001 735 700	AP6FS	
0 001 740 700	AP6FS	
0 001 820 700	AB-6	
0 001 835 700	AB-7	
0 001 845 700	AB-7	
0 002 235 901	PLZKBR7B8DG	Q216
0 002 240 902	PLZKBR7B8DG	Q216
0 002 240 907	PLZKBR7B8DG	Q216
0 002 240 911	PLZKBR7B8DG	Q216
0 002 325 700	BPR5ES	
0 002 330 204	BKR5EYA-11	
0 002 330 701	BPR5ES	
0 002 330 702	BPR5ES-11	
0 002 330 703	BKR5ES	
0 002 330 704	BKR5ES-11	
0 002 330 706	BPR5EKU	
0 002 330 710	BKR5EK	
0 002 330 712	BCRE527Y	
0 002 330 713	BKR5EY	
0 002 330 714	BKR5EYA	
0 002 330 794	ZFR5F-11	
0 002 335 100	BCPR7ET	
0 002 335 500	BKR6EK	
0 002 335 701	BPR6ES	
0 002 335 704	BR6ES	
0 002 335 706	BPR6ES-11	
0 002 335 707	BKR6ES	
0 002 335 708	BKR6ES-11	
0 002 335 712	BKR6EY	
0 002 335 713	BKR6EYA	
0 002 335 714	BKR6EYA-11	
0 002 335 715	ZFR6F-11	
0 002 335 719	LFR6B	
0 002 335 902	BCPR6EP-11	

BERU	→ NGK	Quick
0 002 335 903	BCPR6EP-11	
0 002 335 904	BKR6EP-8	
0 002 335 911	BKR6EQUP	
0 002 340 102	BKR6EKUB	
0 002 340 500	BKR6EK	
0 002 340 501	BKR6EKE	
0 002 340 504	BKR6EKC	
0 002 340 701	BPR6ES	
0 002 340 702	BKR6ES	
0 002 340 703	BPR6ES-11	
0 002 340 704	BKR6ES-11	
0 002 345 701	BPR7ES	
0 002 345 702	BCPR7ES	
0 002 345 704	BCPR7ET	
0 002 435 701	BPR6HS	Q214
0 002 435 701	BPR6HS	Q214
0 002 435 701	BPR6HS	Q214
0 002 515 400	BP-4	
0 002 630 701	PTR5A-13	
0 002 630 715	LTR6B-10T	
0 002 630 900	TR55IX	
0 002 635 700	BPR6EFS	
0 002 635 701	BPR6EFS-13	
0 002 640 100	BUR6EFSZ	
0 002 640 700	BPR6EFS	
0 002 640 701	BPR6FS	
0 002 640 900	PTR5A-13	
0 004 525 700	B4-LM	Q301
0 004 525 701	BR4-LM	
0 004 535 402	BPM6A	Q304
0 004 540 401	BPMR6A	Q308
0 004 545 401	BPM7A	Q305
12 ZR-6 SP03	PLZKBR7B8DG	Q216
12 ZR-6 SP2	PLZKBR7B8DG	Q216
12 ZR-6 SPP21	PLZKBR7B8DG	Q216
12 ZR-7 SP03	PLZKBR7B8DG	Q216
12-5 DU	D7EA	
125/14/3	B5ES	
125/14/3A	BP5ES	
14 F-5 DU	BCP7ES	
14 F-6 DPUR021	PFR7Q	
14 F-6 DSR	BKR6ES	
14 F-6 DTU	BCP6ET	
14 F-6 DU0	BCP6ES	
14 F-6 DU0R	BKR6ES	
14 F-7 DPUR02	PFR6Q	
14 F-7 DPURX2	IFR6D10	
14 F-7 DU	BCP6ES	
14 F-7 DU0	BCP6ES	
14 F-7 DU0R	BKR6ES	
14 F-7 HPURX2	PZFR5D-11	
14 F-7 HUR2	ZFR5P-G	



BERU	→ NGK	Quick
14 F-7 LDUR	BKR6EK	
14 F-7 LDUR4	BKR6EK	
14 F-8 DU	BCP5ES	
14 F-8 DU0	BCP5ES	
14 F-8 DU4	BCP5ES	
14 F-8 DUR	BKR6EZB	
14 F-8 LDUSR	BKR6EK	
14 F-8 LUR	ZFR5F	
14 F-9 DU0	BCP5ES	
14 FGH-6 DTUR	BKUR6ET	
14 FGH-7 DPURX2	IFR6D10	
14 FGH-7 DTURX	BKUR6ET-10	
14 FGH-7 DTURX	BKUR6ET-10	
14 FGH-8 DPURX2	IFR5D10	
14 FGH-8 DTURW	BKUR5ET	
14 FGH-8 DTURX0	BKUR5ET-10	
14 FGR-6 DDU	BKR6EKUB	
14 FGR-7 CTU	BCPR7ET	
14 FR-5 DTU	BCPR7ET	
14 FR-5 DU	BCPR7ES	
14 FR-6 DU	BKR6ES	
14 FR-6 DUX	BKR6ES-11	
14 FR-6 LDU	BKR6EK	
14 FR-6 LDU3	BKR6EKE	
14 FR-6 LDUW	BKR6EKC	
14 FR-7 DQUP7	BKR6EQUP	
14 FR-7 DU	BKR6ES	
14 FR-7 DUX	BKR6ES-11	
14 FR-7 KPU	BKR6EP-8	
14 FR-7 KPUV	BCPR6EP-11	
14 FR-7 KPUX	BCPR6EP-11	
14 FR-7 KU	BKR6EY	
14 FR-7 KU0	BKR6EYA	
14 FR-7 KU0X	BKR6EYA-11	
14 FR-7 LDU	BKR6EK	
14 FR-7 LUX	ZFR6F-11	
14 FR-7 MU2	LFR6B	
14 FR-8 DU	BKR5ES	
14 FR-8 DUX	BKR5ES-11	
14 FR-8 HU	BCRE527Y	
14 FR-8 KU	BKR5EY	
14 FR-8 KU0U	BKR5EYA-11	
14 FR-8 KU0	BKR5EYA	
14 FR-8 LDUOX4	BKR5EK	
14 FR-8 LU2	ZFR5F-11	
14 G-8 DTU	BUR5ET	
14 GH-7 DTUR	BUR6ET	
14 GH-8 DTUR	BUR5ET	
14 GH-8 DTURX	BUR5ET-10	
14 GR-8 DTU	BPR5EKU	
14 K-5 DU	BP7EFS	
14 K-5 DU0	BP7EFS	

BERU	→ NGK	Quick
14 K-6 D	BP6EFS	
14 K-6 DU	BP6EFS	
14 K-6 DU0	BP6EFS	
14 K-7 D	BP6EFS	
14 K-7 DU	BP6EFS	
14 K-7 DU0	BP6EFS	
14 K-8 DU	BP5EFS	
14 K-8 DU0	BP5EFS	
14 K-9 DU	BP5EFS	
14 K-9 DU0	BP5EFS	
14 KGR-6 KQU	BUR6EFSZ	
14 KR-6 BU	BPR6FS	
14 KR-6 DU	BPR6EFS	
14 KR-7 DU	BPR6EFS	
14 KR-7 DUX	BPR6EFS-13	
14 KR-8 DPUOV	TR55IX	
14 KR-8 MPX	PTR5A-13	
14 KR-8 MUV	PTR5A-13	
14 KR-8 STUX	LTR6B-10T	
14 R-11 F	BP-4	
14 R-5 DU	BPR7ES	
14 R-6 B	BPR6HS	Q214
14 R-6 B	BPR6HS	Q214
14 R-6 B	BPR6HS	Q214
14 R-6 BU	BPR6HS	Q214
14 R-6 BU	BPR6HS	Q214
14 R-6 BU	BPR6HS	Q214
14 R-6 BU	BPR6HS	Q214
14 R-6 D	BPR6ES	
14 R-6 DU	BPR6ES	
14 R-6 DUX	BPR6ES-11	
14 R-7 B	BPR6HS	Q214
14 R-7 B	BPR6HS	Q214
14 R-7 B	BPR6HS	Q214
14 R-7 BU	BPR6HS	Q214
14 R-7 BU	BPR6HS	Q214
14 R-7 BU	BPR6HS	Q214
14 R-7 CU	BR6ES	
14 R-7 D	BPR6ES	
14 R-7 DU	BPR6ES	
14 R-7 DUX	BPR6ES-11	
14 R-8 DU	BPR5ES	
14 R-8 DUX	BPR5ES-11	
14 R-9 DU	BPR5ES	
14 R-9 EU0	BR4-LM	
14 S-5 F	BPM7A	Q305
14 S-7 F	BPM6A	Q304
14 S-8 F	BPM6A	Q304
14 SR-6 F	BPMR6A	Q308
14 X-AU	B6HS	Q203
14 Z-2 C1	BR9EIX	
14 Z-3 A1	B9HS	
14 Z-3 AU	B9HS	

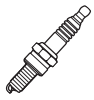

BERU	→ NGK	Quick
14 Z-3 C1	B9ES	Q202
14 Z-3 CU	B9ES	Q202
14 Z-4 AU	B8HS	Q205
14 Z-6 A2	B6HS	Q203
14 Z-7 AU	B7HS	Q204
14-10 A	B-4H	
14-10 B	BP4HS	
14-10 C	B4ES	
14-10 D	BP4ES	
14-10 E	B-4	
14-10 F	BP-4	
14-2 AS1	B9HCS	
14-3 A1	B8HS	Q205
14-3 AS1	BR8HIX	
14-3 AU	B8HS	Q205
14-3 CS1	BR8EIX	
14-3 DP2	BR8EIX	
14-4 A1	B8HS	Q205
14-4 A2	B7HS	Q204
14-4 AS1	BR8HIX	
14-4 AU	B7HS	Q204
14-4 B2	BP7HS	
14-4 C1	B8ES	Q201
14-4 C2	B7ES	
14-4 CS1	BR8EIX	
14-4 DP0	BP7ES	Q206
14-5 A	B7HS	Q204
14-5 AU	B7HS	Q204
14-5 B	BP7HS	
14-5 BU	BP7HS	
14-5 C	B7ES	
14-5 CS	B7ECS	
14-5 D	BP7ES	Q206
14-5 D1	BP7ES	Q206
14-5 DP1	BP7ES	Q206
14-5 DTU	BUR6ET	
14-5 DU	BP7ES	Q206
14-5 DU0	BP7ES	Q206
14-5 E	B7S	
14-5 F	BP6S	
145/14	B5HS	
145/14/3	B5ES	
145/14/3A	BP5ES	
145/14/5	B-4	
145/14/5A	BP5S	
145/14/5AMX	BPM6A	Q304
145/18	AB-6	
145/18K	AP5FS	
145/1A	BP5HS	
14-6 B	BP6HS	
14-6 BU	BP6HS	
14-6 C	B6ES	

BERU	→ NGK	Quick
14-6 D	BP6ES	
14-6 D1	BP6ES	
14-6 DP0	BP6ES	
14-6 DTU	BUR6ET	
14-6 DU	BP6ES	
14-6 DU0	BP6ESZ	
14-7 A	B6HS	Q203
14-7 AU	B6HS	Q203
14-7 B	BP6HS	
14-7 BU	BP6HS	
14-7 C	B6ES	
14-7 CU	B6ES	
14-7 D	BP6ES	
14-7 DTU	BUR6ET	
14-7 DU	BP6ES	
14-7 DU0	BP6ESZ	
14-7 E	B6S	Q302
14-7 F	BP6S	
14-8 A	B5HS	
14-8 AU	B5HS	
14-8 B	BP5HS	
14-8 BU	BP5HS	
14-8 C	B5ES	
14-8 C1	B6ES	
14-8 D	BP5ES	
14-8 DTU	BP5ET-10	
14-8 DU	BP5ES	
14-8 DU0	BP5ESZ	
14-8 E	B-4	
14-8 F	BP5S	
14-8 LUR	ZGR5A	
14-9 C	B5ES	
14-9 D	BP5ES	
14-9 DTU	BP5ET	
14-9 DU	BP5ES	
14-9 DU0	BP5ESZ	
14-9 EU0	B4-LM	Q301
160/14/3	B6ES	
175/14	B6HS	Q203
175/14/3	B6ES	
175/14/3A	BP6ES	
175/14/5	B6S	Q302
175/14/5A	BP6S	
175/14/5AMX	BPM6A	Q304
175/14A	BP6HS	
175/18	AB-6	
175/18K	AP6FS	
18 K-12 B	AP5FS	
18 K-6 BU	AP6FS	
18 K-7 B	AP6FS	
18 K-7 BU	AP6FS	
18 K-8 B	AP5FS	



BERU	→ NGK	Quick
18 K-8 BU	AP5FS	
18-10 A	AB-6	
18-10 AU	AB-6	
18-12 B	AB-2	
18-4 A1	AB-7	
18-4 A2	AB-7	
18-5 A	AB-7	
18-5 AS	AB-7	
18-5 AU	AB-7	
18-7 A	AB-6	
18-7 AU	AB-7	
18-8 A	AB-6	
190/14 Z	B6HS	Q203
200/14/3	B6ES	
200/14/3A	BP6ES	
200/14/3K	BP6EFS	
200/14A	BP6HS	
215/14/3A	BP6ES	
225/14	B7HS	Q204
225/14/3	B7ES	
225/14/3A	BP7ES	Q206
225/14/3S	B7ECS	
225/14/5	B7S	
225/14/5A	BP6S	
225/14/5AMX	BPM7A	Q305
225/14A	BP7HS	
225/18	AB-7	
225/18S	AB-7	
230/14/3A	BP7ES	Q206
235/14/3P	BP7ES	Q206
240/14	B7HS	Q204
240/14 A	BP7HS	
240/14 S	BR8HIX	
240/14/3	B7ES	
240/18	AB-7	
260/14	B8HS	Q205
260/14 S	BR8HIX	
260/14/3	B8ES	Q201
260/18	AB-8	
265/14/3P	BR8EIX	
280/14	B8HS	Q205
280/14/3S	BR8EIX	
280/14/3Z	B9ES	Q202
280/14Z	B9HS	
310/14/3Z	BR9EIX	
310/14S	B9HCS	
45/18	AP5FS	
95/14	B-4H	
95/14/3	B4ES	
95/14/3A	BP4ES	
95/14/5	B-4	
95/14/5A	BP-4	

BERU	→ NGK	Quick
95/14A	BP4HS	
95/18	AB-6	
D 175/14	B6HS	Q203
D 175/14/3	B6ES	
D 200/14/3A	BP6ES	
D 215/14/3	B7ES	
D 230/14/3A	BP7ES	Q206
RS 16	BPR6HIX	
RS 18	BPR7HIX	
RS 33	BPR5EIX	
RS 35	BPR6EIX	
RS 37	BPR7EIX	
RS 39	BPR7EIX	
Z 1	BP5ES	
Z 10	BP6HS	
Z 100	BCP5ES	
Z 101	BKR6EK	
Z 103	BP7ES	Q206
Z 104	BP6ES	
Z 105	BKR6ES	
Z 107	BP-4	
Z 11	BP6ES	
Z 112	B-4	
Z 116	BKR6EK	
Z 118	BP5HS	
Z 12	BUR6ET	
Z 121	BKUR5ET-10	
Z 122	IFR5D10	
Z 13	BKR6ES	
Z 132	BPM6A	Q304
Z 14	BKR6EK	
Z 144	BUR6EFSZ	
Z 145	BKR6EKUB	
Z 148	TR55IX	
Z 149	BCPR6EP-11	
Z 15	BKR6ES	
Z 150	BCPR6EP-11	
Z 151	BKR6EP-8	
Z 152	BCRE527Y	
Z 153	BKR5EY	
Z 154	BKR5EYA	
Z 155	BKR6EY	
Z 156	BKR6EYA	
Z 157	BKR6EYA-11	
Z 158	ZFR6F-11	
Z 16	BKR6ES-11	
Z 17	BP6EFS	
Z 171	IFR6D10	
Z 176	PZFR5D-11	
Z 177	PTR5A-13	
Z 18	BP6EFS	
Z 184	LFR6B	



BERU	→ NGK	Quick
Z 185	PFR7Q	
Z 188	PFR6Q	
Z 19	BPR6HS	Q214
Z 19	BPR6HS	Q214
Z 19	BPR6HS	Q214
Z 194	BKR6EKE	
Z 2	BP5ET-10	
Z 20	BPR6ES	
Z 200	ZFR5P-G	
Z 203	ZFR5F-11	
Z 21	BPR6ES-11	
Z 22	BP6ES	
Z 222	LTR6B-10T	
Z 227	BKR6EZB	
Z 23	BKR6ES	
Z 233	PLZKBR7B8DG	Q216
Z 237	BKR6EQUP	
Z 24	BKR6ES	
Z 245	BKR6EKC	
Z 246	BKUR5ET	
Z 249	BKR5EYA-11	
Z 25	BP6EFS	
Z 26	BPR6EFS	
Z 27	BPR6ES	
Z 28	BPR6ES-11	
Z 282	IFR6D10	
Z 288	PLZKBR7B8DG	Q216
Z 29	BCP7ES	
Z 3	ZGR5A	
Z 30	BCPR7ES	
Z 31	BP7EFS	
Z 32	AP6FS	
Z 33	AP6FS	
Z 336	PLZKBR7B8DG	Q216
Z 35	D7EA	
Z 37	B9HS	
Z 38	B9ES	Q202
Z 39	B8HS	Q205
Z 4	ZFR5F	
Z 40	B7HS	Q204
Z 41	BP7HS	
Z 42	BP7ES	Q206
Z 43	BP7ES	Q206
Z 44	BUR6ET	
Z 45	BCPR7ET	
Z 46	BP7EFS	
Z 47	BPR7ES	
Z 48	BP6HS	
Z 49	BPR6FS	
Z 5	BCP5ES	
Z 50	BP6ESZ	
Z 51	BUR6ET	

BERU	→ NGK	Quick
Z 52	BCP6ET	
Z 53	BCP6ET	
Z 54	BCP6ES	
Z 55	BP6EFS	
Z 56	BP6EFS	
Z 57	B6HS	Q203
Z 58	B6ES	
Z 59	BR6ES	
Z 6	BP5EFS	
Z 60	BCPR7ET	
Z 61	BP6ESZ	
Z 62	BP6ESZ	
Z 63	BCP6ES	
Z 64	BCP6ES	
Z 67	BPR6EFS-13	
Z 68	B5HS	
Z 69	BP5ESZ	
Z 7	BP5EFS	
Z 70	BP5ESZ	
Z 71	BCP5ES	
Z 72	BKR5ES	
Z 73	BKR5ES-11	
Z 74	BKR5EK	
Z 75	BUR5ET	
Z 76	BP5ES	
Z 77	BP5ESZ	
Z 78	BP5ET	
Z 79	BCP5ES	
Z 8	BPR5ES	
Z 80	BP5EFS	
Z 81	BP5EFS	
Z 82	BPR5ES	
Z 83	B4-LM	Q301
Z 84	BR4-LM	
Z 85	B6HS	Q203
Z 86	AB-7	
Z 87	AB-7	
Z 88	AB-6	
Z 89	BKUR6ET	
Z 9	BPR5ES-11	
Z 90	BKUR6ET-10	
Z 90	BKUR6ET-10	
Z 91	BUR6ET	
Z 92	BUR5ET	
Z 93	BUR5ET-10	
Z 94	BPR5EKU	
Z 95	BPR6EFS	
Z 97	PTR5A-13	
Z 98	BKR6EK	
Z 99	BKR6ES-11	



BMW	→ NGK	Quick
11 12 7 675 485	KR9CI	
12 12 0 022 902	DCPR8EKP	
12 12 0 030 548	BKR6EQUP	
12 12 0 031 708	BKR7EQUP	
12 12 0 032 134	IZFR6H11	
12 12 0 032 136	BKR6EQU	
12 12 0 032 137	ILZFR6D11	
12 12 0 032 273	LKR8AP	
12 12 0 034 091	ZKBR7A-HTU	
12 12 0 034 094	R6601-9	
12 12 0 034 098	PLZKBR7B8DG	Q216
12 12 0 035 531	PLZKBR7B8DG	Q216
12 12 0 035 747	PFR7B	
12 12 0 035 915	PLZFR6A-11S	
12 12 0 037 581	SILZKBR8D8S	
12 12 0 037 607	BKR6EQUP	
12 12 0 037 608	BKR6EQUP	
12 12 0 038 349	ZKBR7A-HTU	
12 12 0 038 507	SIZKBR8A8HS	
12 12 0 141 871	BKR6EQUP	
12 12 1 265 595	BP6ES	
12 12 1 267 485	BP6ES	
12 12 1 338 145	BP6ES	
12 12 1 338 146	BP7ES	Q206
12 12 1 338 147	BP6ES	
12 12 1 342 125	BKR7EKC	
12 12 1 342 125	BKR6EKC	
12 12 1 342 836	BKR7EKC	
12 12 1 404 310	PKR7A	
12 12 1 435 955	BKR6EQUP	
12 12 1 435 956	BKR6EQUP	
12 12 1 460 800	D7EA	
12 12 1 464 293	DR7EA	
12 12 1 465 104	DCPR7E	
12 12 1 704 399	BKR6EK	
12 12 2 158 252	IZFR6H11	
12 12 2 158 253	PLZFR6A-11S	
12 12 2 343 144	D8EA	Q216
12 12 7 521 111	PLZFR6A-11S	
12 12 7 521 112	ILZFR6D11	
12 12 7 523 457	BKR6EQU	
12 12 7 526 799	IZFR6H11	
12 12 7 534 226	PLZKBR7B8DG	Q216
12 12 7 550 011	ZKBR7A-HTU	
12 12 7 550 011 02	ZKBR7A-HTU	
12 12 7 556 979	BKR7EQUP	
12 12 7 570 106	ILZKBR7B8DG	
12 12 7 570 106.02	ILZKBR7B8DG	
12 12 7 600 994	SIZKBR8A8HS	
12 12 7 650 676	BKR7EKC	
12 12 7 650 676.3	BKR7EKC	
12 12 7 653 439	CR8EB	

BMW	→ NGK	Quick
12 12 7 653 771	BKR7EKC	
12 12 7 664 404	DR8EB	
12 12 7 671 301	DCPR8EKC	
12 12 7 671 302	BKR7EKC	
12 12 7 677 560	DCPR8EKC	
12 12 7 681 415	BKR7EKC	
12 12 7 690 603	DCPR8E	
12 12 7 698 956	MAR9B-JDS	
12 12 7 699 116	KR9CI	
12 12 7 710 636	CR9EKB	
12 12 7 710 681	MAR9B-JDS	
12 12 7 719 772	LMAR9D-J	
12 12 7 722 278	MAR9B-JDS	
12 12 7 726 112	MAR8B-JDS	
12 12 7 728 634	DCPR8EKC	
12 12 7 728 635	KR9CI	
12 12 7 728 657	LMAR8AI-8	
12 12 7 830 787	DCPR8EKP	
12 12 7 830 787.3	DCPR8EKP	
12 12 7 835 198	LKR8AP	
12 12 8 003 572	B9ES	Q202
12 12 8 532 942	LMAR8D-J	
12 12 9 061 870	ZFR5F	
12 12 9 062 217	D7EA	
12 12 9 062 594	BP6ES	
12 12 9 063 428	BKR6EK	
12 12 9 064 617	BKR6EK	
12 12 9 064 619	BKR6EK	
12 12 9 064 656	BKR6EK	
12 12 9 065 366	BKR6EK	
12 12 9 069 048	PKR7A	
12 12 9 071 003	BKR6EQUP	
75 34 2 26A 104	PLZKBR7B8DG	Q216
91 47 1 210 043	PFR7B	

BOMBARDIER	→ NGK	Quick
415 129 484	PFR7AB	
512 059 533	BR9ECS-5	
512 060 294	PZFR6F	

BOSCH	→ NGK	Quick
+1	BPR6ES	
+2	BUR6ET	
+3	BPR5ES	
+4	BUR5ET-10	
+5	BPR6EFS	
+6	BKR5ES	
+7	BKR6EK	
+8	BKR6ES	
+9	BKR5EK	
+10	BPR6HS	Q214



BOSCH	→ NGK	Quick
+10	BPR6HS	Q214
+10	BPR6HS	Q214
+11	BKR6ES-11	
+12	BPR6ES	
+13	BKR6ES	
+14	BPR5EFS	
+15	BPR7ES	
+16	BPR5ES	
+17	PTR5A-13	
+18	BPR6EFS	
+19	BKR5ES-11	
+20	BPR5HS	
+21	BPR6ES-11	
+22	BPR5ES-11	
+23	BKR6EKUB	
+24	PFR6B	
+25	BPR4FS	
+26	TR55	
+27	BPR5ES-11	
+31	BKR6EY-11	
+32	ZFR6F-11	
+33	BPR4FS-15	
+34	ZGR5A	
+36	BKR5EKB-11	
+37	BPR6EFS-15	
+39	TR5B-13	
+41	ZKR7A-10	
+42	LFR6B	
+45	PFR5R-11	
+46	BPR6EFS-13	
+47	BKR6EY	
+48	BKR6EQUP	
+50	PFR6Q	
+51	ZFR6T-11G	
+52	PZFR5D-11	
+53	BKR6EZ	
0 241 040 501	CR4HSA	
0 241 045 001	C5HSA	
0 241 045 003	C5HSA	
0 241 045 502	C5HSA	
0 241 050 002	C6HSA	
0 241 056 501	C7E	
0 241 140 500	DCP6E	
0 241 145 003	DP7EA-9	
0 241 145 500	DP7EA-9	
0 241 145 504	DP7EA-9	
0 241 145 507	D8EA	Q216
0 241 145 515	PZKER7A8EGS	
0 241 150 502	D8EA	Q216
0 241 200 500	BUH	
0 241 209 003	B-4H	
0 241 219 536	BP-4	

BOSCH	→ NGK	Quick
0 241 219 537	BP4FS	
0 241 219 540	B-4H	
0 241 219 541	B4ES	
0 241 219 542	BP4ES	
0 241 219 543	B-4H	
0 241 219 554	B-4	
0 241 219 555	BP4ES	
0 241 225 013	BP5ES	
0 241 225 543	BP4FS	
0 241 225 545	BP5ES	
0 241 225 547	B4ES	
0 241 225 548	B-4	
0 241 225 549	B5HS	
0 241 225 550	BP5ES	
0 241 225 551	B4-LM	Q301
0 241 225 555	BPR4FS-15	
0 241 225 556	BP5ES	
0 241 225 558	BP5EFS	
0 241 225 573	BP5EFS	
0 241 225 574	BCPR4ES-11	
0 241 225 576	BP5ET	
0 241 225 582	BP5ES-11	
0 241 225 585	ZGR5A	
0 241 225 589	BM4A	
0 241 225 590	B4-LM	Q301
0 241 225 593	BP5ES	
0 241 229 059	ZGR5A	
0 241 229 060	BP5ET-10	
0 241 229 061	BP5ES	
0 241 229 062	BP5ES	
0 241 229 541	BM6F	
0 241 229 560	BM6A	Q303
0 241 229 561	BPM6A	Q304
0 241 229 574	BP5ES	
0 241 229 578	BP5HS	
0 241 229 579	B5ES	
0 241 229 580	B6S	Q302
0 241 229 588	BP5ES	
0 241 229 593	BP5S	
0 241 229 594	BP5FS	
0 241 229 596	BP5ES-11	
0 241 229 604	B5HS	
0 241 229 612	B5HS	
0 241 229 617	BP5EFS	
0 241 229 619	BP5ET	
0 241 229 634	BCP5ES	
0 241 229 639	ZFR5F	
0 241 229 641	BP5HS	
0 241 229 649	BP5EFS	
0 241 229 657	ZFR5F	
0 241 229 661	BUR6ET	
0 241 229 663	BUR5ET-10	



BOSCH	→ NGK	Quick
0 241 229 665	BUR5ET	
0 241 229 666	BKR6EK	
0 241 229 676	BKUR5ET	
0 241 229 682	BCP5ES-11	
0 241 229 684	BKR5ES	
0 241 229 704	IFR5D10	
0 241 229 712	BCP5ES	
0 241 229 713	BCP5ES	
0 241 229 714	BP5HS	
0 241 229 715	BP5ES	
0 241 229 716	BP5ET	
0 241 229 926	BP5ES	
0 241 235 089	B6ES	
0 241 235 098	B6ES	
0 241 235 099	BPR6ES	
0 241 235 103	BP6ESZ	
0 241 235 108	BCP6ET	
0 241 235 563	BP6ES	
0 241 235 564	BP6HS	
0 241 235 566	BM6A	Q303
0 241 235 567	BPM6A	Q304
0 241 235 574	B6ES	
0 241 235 585	BP6HS-10	
0 241 235 594	B6S	Q302
0 241 235 602	BP6ES	
0 241 235 607	B6HS-5	
0 241 235 610	BP6ES-11	
0 241 235 619	B6HS-5	
0 241 235 623	BP6S	
0 241 235 633	BUR6ET	
0 241 235 635	BP6EFS	
0 241 235 636	BP6EFS	
0 241 235 638	BR6EF	
0 241 235 643	BUR6ET	
0 241 235 646	BP6EFS-13	
0 241 235 668	BP6EFS	
0 241 235 673	BCP6ES	
0 241 235 674	ZFR6A-11	
0 241 235 676	BCP6ES	
0 241 235 681	BP6EFS	
0 241 235 685	BCP6ES-11	
0 241 235 690	BKR6EK	
0 241 235 692	ZFR6F-11	
0 241 235 693	BP6ESZ	
0 241 235 698	BUR6ET	
0 241 235 705	BP6ESZ	
0 241 235 706	BKUR6ET-10	
0 241 235 706	BKUR6ET-10	
0 241 235 715	PZFR5D-11	
0 241 235 735	ZFR5P-G	
0 241 235 736	BKR6ES	
0 241 235 739	IFR6D10	

BOSCH	→ NGK	Quick
0 241 235 750	BCP6ES	
0 241 235 751	BKR6EK	
0 241 235 752	BKUR6ET-10	
0 241 235 752	BKUR6ET-10	
0 241 235 753	BP6EFS	
0 241 235 754	BP6HS	
0 241 235 755	BP6ES	
0 241 235 756	BUR6ET	
0 241 235 757	BUR6ET	
0 241 240 057	BP6ESZ	
0 241 240 058	BP6ESZ	
0 241 240 524	BP6EFS	
0 241 240 530	BP6ES	
0 241 240 532	BP6HS	
0 241 240 539	BP6ES	
0 241 240 542	BCP6ES	
0 241 240 543	BP6FS	
0 241 240 558	BUR6ET	
0 241 240 563	BP6EFS	
0 241 240 564	BCP6ET	
0 241 240 569	BCP6ES-11	
0 241 240 574	BP6ES-11	
0 241 240 578	BP6EFS	
0 241 240 585	BKR6EIX	
0 241 240 587	BKR6ES	
0 241 240 592	BKUR7ET	
0 241 240 600	BM6A	Q303
0 241 240 601	BPM6A	Q304
0 241 240 603	B6HS	Q203
0 241 240 608	BCP6ES	
0 241 240 609	BCP6ET	
0 241 240 611	BP6ES	
0 241 240 631	ILFR6A	
0 241 243 501	BPR6EIX	
0 241 245 070	BUR6ET	
0 241 245 539	BM7F	
0 241 245 552	BP7ES	Q206
0 241 245 553	BP7HS	
0 241 245 554	BM7A	
0 241 245 555	BPM7A	Q305
0 241 245 570	BP7EFS	
0 241 245 574	BR7HIX	
0 241 245 575	BR7EIX	
0 241 245 580	B7HS	Q204
0 241 245 581	B7ES	
0 241 245 592	B7S	
0 241 245 599	BP7ES	Q206
0 241 245 602	B7HS	Q204
0 241 245 603	B7ES	
0 241 245 619	BP7HS	
0 241 245 636	BP7EFS	
0 241 245 641	PFR7B	



BOSCH	→ NGK	Quick
0 241 245 642	BCP7ES	
0 241 245 646	BP7HS-10	
0 241 245 655	BCP7ES	
0 241 245 656	BP7HS	
0 241 245 673	PLFER7A8EG	
0 241 247 500	BPR7EIX	
0 241 248 531	B8HS	Q205
0 241 248 534	B8ES	Q201
0 241 248 538	B8ES	Q201
0 241 248 540	B8HS	Q205
0 241 250 502	BPR8EIX	
0 241 250 512	BPR8EIX	
0 241 250 526	R7433-8	
0 241 252 521	BR8HIX	
0 241 252 522	BR8EIX	
0 241 255 505	B8EFS	
0 241 255 507	R7433-9	
0 241 256 512	B8HS	Q205
0 241 256 513	B9ES	Q202
0 241 256 514	BR8HIX	
0 241 256 515	BR9EIX	
0 241 256 517	BPR8EIX	
0 241 256 519	B8HS	Q205
0 241 256 522	B9ES	Q202
0 241 260 507	B9HS	
0 241 260 508	B10ES	
0 241 260 510	B9EFS	
0 241 260 512	R7433-9	
0 241 262 505	BR9HIX	
0 241 262 506	BR10EIX	
0 241 268 505	BR9HIX	
0 241 268 506	B10EGV	
0 241 274 504	BR10HIX	
0 241 274 505	B10EGV	
0 241 280 503	B11EGV	
0 241 309 501	AP5FS	
0 241 319 510	AP5FS	
0 241 319 512	AB-6	
0 241 319 513	AB-6	
0 241 325 509	AP5FS	
0 241 329 520	AP5FS	
0 241 329 525	AB-6	
0 241 329 526	AB-6	
0 241 335 516	AP6FS	
0 241 335 520	A6FS	
0 241 335 524	AB-7	
0 241 335 526	AB-7	
0 241 335 528	AP6FS	
0 241 340 501	AP6FS	
0 241 345 512	AB-7	
0 241 350 505	AB-7	
0 242 035 500	CMR6H	

BOSCH	→ NGK	Quick
0 242 040 500	CR6HS	Q223
0 242 050 500	CR6HS	Q223
0 242 055 500	CR7HS	
0 242 055 501	CR7HSA	
0 242 055 502	CR7E	Q225
0 242 055 505	CR7HSA	
0 242 060 500	CR8HS	
0 242 060 501	CR8E	Q226
0 242 129 503	LZKAR7A	
0 242 129 508	LZKAR7A	
0 242 129 512	PLZKBR7B8DG	Q216
0 242 129 804	PLZKBR7B8DG	Q216
0 242 135 500	DPR7EA-9	Q220
0 242 135 501	DCPR8E-N	
0 242 135 509	PLKR7A	
0 242 135 515	ZKR7A-10	
0 242 135 518	PLZKBR7B8DG	Q216
0 242 140 500	DR7EA	
0 242 140 504	DCPR8EKC	
0 242 140 512	PLKR7B8E	
0 242 140 528	ILZKR7A	
0 242 145 500	DPR7EA-9	Q220
0 242 145 501	DPR7EA-9	Q220
0 242 145 503	DCPR8EKC	
0 242 145 504	KR9CI	
0 242 145 516	DPR7EA-9	Q220
0 242 145 517	SILZKBR8D8S	
0 242 150 500	DR8HS	
0 242 150 501	DR8ES	Q217
0 242 150 505	DPR8EA-9	Q221
0 242 160 501	DR8ES	Q217
0 242 215 502	BR4-LM	
0 242 219 004	BR4HS	
0 242 219 511	BPR4FS-15	
0 242 219 512	BP-4	
0 242 219 513	BP-4	
0 242 219 514	BR5FS	
0 242 219 515	BR5FS	
0 242 219 516	BPR4FS	
0 242 219 517	BPR4FS-11	
0 242 219 519	BCPR4ES-11	
0 242 219 520	BP-4	
0 242 219 529	ZGR5B	
0 242 219 530	BPR4ES-13	
0 242 225 522	BR6S	
0 242 225 523	BR5ES	
0 242 225 524	BPR5ES	
0 242 225 525	BPR5ES-13	
0 242 225 526	BP5S	
0 242 225 527	BP5S	
0 242 225 528	ZGR5C	
0 242 225 529	BR5FS	



BOSCH	→ NGK	Quick
0 242 225 530	BR5FS	
0 242 225 531	BPR4FS	
0 242 225 532	BPR4FS-15	
0 242 225 533	BPR5EFS	
0 242 225 534	BPR5EFS-13	
0 242 225 536	BR6S	
0 242 225 537	ZFR4F-11	
0 242 225 538	BPR5EIX	
0 242 225 539	ZGR5A	
0 242 225 548	BPR5ES-11	
0 242 225 549	BCPR4ES-11	
0 242 225 550	BPR5ES	
0 242 225 553	BPR5ES	
0 242 225 554	BPR5ES-11	
0 242 225 560	BPR4FS-11	
0 242 225 563	BP5S	
0 242 225 564	BP5S	
0 242 225 566	BPR4FS-15	
0 242 225 571	TR5IX	
0 242 225 573	BPR4FS	
0 242 225 578	TR55IX	
0 242 225 582	BKR5ES	
0 242 225 599	BPR5ES	
0 242 225 612	BMR4A	Q306
0 242 225 622	BPR4FS	
0 242 225 623	TR55	
0 242 225 624	BPR5ES-11	
0 242 225 641	BPR4FS-15	
0 242 225 859	BPR5ES	
0 242 225 861	BPR5ES	
0 242 229 524	BR6S	
0 242 229 525	BP5S	
0 242 229 526	BR5FS	
0 242 229 528	BPR5FS	
0 242 229 529	BPR5FS-15	
0 242 229 530	BKR5ES-11	
0 242 229 531	BPR5ES	
0 242 229 533	BR5ES	
0 242 229 534	BR5HS	
0 242 229 537	BPR5EIX	
0 242 229 538	BPR5ES	
0 242 229 543	BKR5ES-11	
0 242 229 544	ZFR5F-11	
0 242 229 548	BPR5FS	
0 242 229 549	BPR5FS-11	
0 242 229 555	BPR5ES	
0 242 229 556	BR5ES	
0 242 229 557	BPR5ES-11	
0 242 229 566	BPR5ES-11	
0 242 229 568	BKR5ES	
0 242 229 570	BPR5ES	
0 242 229 576	ZFR6F-11	

BOSCH	→ NGK	Quick
0 242 229 587	BKR5ES	
0 242 229 589	BPR5HS	
0 242 229 591	BKR5EK	
0 242 229 594	BKR5ES	
0 242 229 598	BKR5EIX	
0 242 229 605	BKR5EK	
0 242 229 607	BPR5ES	
0 242 229 610	BPR5HS	
0 242 229 613	BKR5EKUP	
0 242 229 625	BKUR5ET-10	
0 242 229 626	BKR5EK	
0 242 229 628	BKR5EK	
0 242 229 630	LFR5B	
0 242 229 634	PLFR5A-11	
0 242 229 635	BKR5EYA-11	
0 242 229 641	PTR5D-10	
0 242 229 648	BKR5EQUPA	
0 242 229 650	TR5B-13	
0 242 229 654	BKR5EK	
0 242 229 655	BPR5EFS	
0 242 229 656	BPR5ES	
0 242 229 657	BPR5HS	
0 242 229 658	BUR5ET-10	
0 242 229 659	BKR5ES	
0 242 229 660	BKR5ES-11	
0 242 229 661	LTR6B-10T	
0 242 229 671	BKR5EKB-11	
0 242 229 673	BKR5ES	
0 242 229 687	BPR5ES-11	
0 242 229 699	ZFR5F-11	
0 242 229 708	ILFR5B11	
0 242 229 713	PFR5R-11	
0 242 229 724	BKR6EZB	
0 242 229 779	ZGR5A	
0 242 229 781	BKR5EKB-11	
0 242 229 782	BKR5EKB-11	
0 242 229 785	TR5B-13	
0 242 229 797	LFR6B	
0 242 229 878	BKR5EK	
0 242 229 879	BPR5EFS	
0 242 229 880	BPR5ES	
0 242 229 881	BPR5HS	
0 242 229 882	BUR5ET-10	
0 242 229 883	BKR5ES	
0 242 229 884	BKR5ES-11	
0 242 229 885	BPR5ES-11	
0 242 229 887	BKR5EK	
0 242 229 888	BKR5ES	
0 242 229 902	TR5B-13	
0 242 229 923	LFR6B	
0 242 229 925	PFR5R-11	
0 242 229 982	BPR5ES	



BOSCH	→ NGK	Quick
0 242 230 500	PFR5R-11	
0 242 230 806	ZFR5F-11	
0 242 235 511	BPR6ES	
0 242 235 522	BPR6HS	Q214
0 242 235 522	BPR6HS	Q214
0 242 235 522	BPR6HS	Q214
0 242 235 525	BPR6EIX	
0 242 235 529	BPR6ES	
0 242 235 530	BPR6ES-11	
0 242 235 532	BR6ES	
0 242 235 533	BR6HS	Q209
0 242 235 535	BPR6HS	Q214
0 242 235 535	BPR6HS	Q214
0 242 235 535	BPR6HS	Q214
0 242 235 537	BPR6ES	
0 242 235 538	BPR6EFS	
0 242 235 541	BPR6EIX	
0 242 235 542	BPR6EFS	
0 242 235 543	BR6ES-11	
0 242 235 544	BKR6ES-11	
0 242 235 545	BR6ES-11	
0 242 235 546	BR6ES	
0 242 235 547	BKR6ES-11	
0 242 235 551	BKR6ES	
0 242 235 554	BR6S	
0 242 235 556	BKR6ES	
0 242 235 564	BCPR6ET	
0 242 235 567	ZFR6F-11	
0 242 235 571	BUR6ET	
0 242 235 577	BPR6EFS-15	
0 242 235 579	BKR6ES	
0 242 235 587	BKR6ES	
0 242 235 588	BKR6ES	
0 242 235 589	BKR6EK	
0 242 235 590	BUR6ET	
0 242 235 592	BPR6EFS-13	
0 242 235 597	BKR6ES	
0 242 235 599	BKR6EY	
0 242 235 602	BKR6EY-11	
0 242 235 605	BKR6EK	
0 242 235 607	BUR6EFSZ	
0 242 235 609	BKR6EZ	
0 242 235 610	BKR6EP-13	
0 242 235 616	BKR6ES	
0 242 235 617	BKR6EQUP	
0 242 235 624	BKR6ES	
0 242 235 630	BPR6ES	
0 242 235 636	LFR6A	
0 242 235 640	BKR6EZ	
0 242 235 642	BKR6EKUB	
0 242 235 651	BPMR6A	Q308
0 242 235 656	BKR6EQUP	

BOSCH	→ NGK	Quick
0 242 235 659	BKR6EYA-11	
0 242 235 661	BPR6EFS	
0 242 235 662	PTR5A-13	
0 242 235 663	BPR6ES	
0 242 235 664	BUR6ET	
0 242 235 665	BPR6HS	Q214
0 242 235 665	BPR6HS	Q214
0 242 235 665	BPR6HS	Q214
0 242 235 666	BKR6ES	
0 242 235 667	BKR6ES-11	
0 242 235 668	BKR6EK	
0 242 235 690	PFR6N-11	
0 242 235 692	ZFR5E-11	
0 242 235 699	BKR6EIX	
0 242 235 707	BPR6ES-11	
0 242 235 715	BKR6EQUA	
0 242 235 740	PFR6Q	
0 242 235 743	PLFR6A	
0 242 235 748	BKR6EKUB	
0 242 235 749	PFR6B	
0 242 235 761	ZFR5P-G	
0 242 235 767	PTR5A-13	
0 242 235 769	ILZFR6C-11K	
0 242 235 776	IZFR6H11	
0 242 235 908	BPR6EFS	
0 242 235 909	BPR6ES	
0 242 235 910	BUR6ET	
0 242 235 911	BPR6HS	Q214
0 242 235 911	BPR6HS	Q214
0 242 235 911	BPR6HS	Q214
0 242 235 912	BKR6ES	
0 242 235 913	BKR6ES-11	
0 242 235 914	BKR6EK	
0 242 235 915	BPR6ES-11	
0 242 235 916	PTR5A-13	
0 242 235 917	BKR6EKUB	
0 242 235 918	PFR6B	
0 242 235 925	BKR6ES	
0 242 235 930	BPR6ES	
0 242 235 931	BUR6ET	
0 242 235 979	BPR6EFS-13	
0 242 235 980	BKR6EY	
0 242 235 981	BKR6EQUP	
0 242 235 982	PFR6Q	
0 242 235 983	ZFR6T-11G	
0 242 235 984	PZFR5D-11	
0 242 235 985	BKR6EY-11	
0 242 235 986	ZFR6F-11	
0 242 236 510	ILZFR6D11	
0 242 236 528	ILFR6B	
0 242 236 541	BKR6EY-11	
0 242 236 542	ZFR6F-11	



BOSCH	→ NGK	Quick
0 242 236 543	BPR6EFS-15	
0 242 236 560	BPR6EFS-13	
0 242 236 561	BKR6EY	
0 242 236 562	BKR6EQUP	
0 242 236 564	PFR6Q	
0 242 236 565	ZFR6T-11G	
0 242 236 566	PZFR5D-11	
0 242 236 577	ILFR6K8	
0 242 236 583	PFR6X-11	
0 242 240 506	BPMR7A	Q309
0 242 240 511	BPR6ES	
0 242 240 514	BPR6EFS	
0 242 240 516	BPR6EIX	
0 242 240 519	BPR6EFS	
0 242 240 520	BPR6FS	
0 242 240 521	BPR6ES	
0 242 240 522	BPR6EFS	
0 242 240 526	BKR6ES	
0 242 240 528	BCPR6ET	
0 242 240 530	BKR6ES	
0 242 240 531	BPR6ES-11	
0 242 240 532	BPR6ES-11	
0 242 240 533	BKR6ES-11	
0 242 240 539	BKR6ES-11	
0 242 240 546	BUR6ET	
0 242 240 547	BKR5EKC	
0 242 240 557	BKR6EK	
0 242 240 561	BPR6HS	Q214
0 242 240 561	BPR6HS	Q214
0 242 240 561	BPR6HS	Q214
0 242 240 562	BKR6EZ	
0 242 240 564	BKR7EKC	
0 242 240 565	BKR7EKC	
0 242 240 566	BKR6EK	
0 242 240 569	BUR6EFSZ	
0 242 240 572	BKUR6ET	
0 242 240 576	BPMR7A	Q309
0 242 240 579	BPR6ES	
0 242 240 582	BMR6A	Q307
0 242 240 584	BKR6EKE	
0 242 240 587	BKR6EQUP	
0 242 240 590	ZFR6S-Q	
0 242 240 591	BPR6EFS	
0 242 240 592	BPR6ES	
0 242 240 593	BKR6ES	
0 242 240 605	BKR6ES	
0 242 240 619	ILFR6A	
0 242 240 648	BKR6EZ	
0 242 240 665	PZFR6R	
0 242 240 848	BPR6EFS	
0 242 240 849	BPR6ES	
0 242 240 850	BKR6ES	

BOSCH	→ NGK	Quick
0 242 240 851	BKR6ES	
0 242 245 015	BPR7EIX	
0 242 245 018	BKR7EKC	
0 242 245 514	BPR7EIX	
0 242 245 515	BCPR7ES	
0 242 245 517	BR7HS	Q211
0 242 245 519	BPR7ES	
0 242 245 520	BCPR7ES	
0 242 245 521	BR7ES	
0 242 245 533	BPMR7A	Q309
0 242 245 536	BCPR7ES	
0 242 245 537	BPR7ES	
0 242 245 539	BCPR7ET	
0 242 245 550	BCPR7ES-11	
0 242 245 552	BPR7ES	
0 242 245 557	BR7ES	
0 242 245 559	BKR7EQUP	
0 242 245 576	PFR7S8EG	
0 242 245 812	BPR7ES	
0 242 250 503	BR8ES	Q207
0 242 250 506	BR8HS	Q212
0 242 250 517	BR8EIX	
0 242 255 501	BR9ET	
0 242 255 502	BR9ES	Q208
0 242 255 504	BR9EIX	
0 242 260 001	BR10ES	
0 242 319 501	APR5FS	
0 242 325 501	APR5FS	
0 242 329 503	APR5FS	
0 242 335 504	APR6FS	
0 242 340 501	APR6FS	
877 1207	R2349-10	
888 1101	R2349-11	
D 10 B	AP5FS	
D 10 BC	AP5FS	
D 6 B	AP6FS	
D 6 BC	AP6FS	
D 6 BP	AP6FS	
D 7 A	A6FS	
D 7 AC	A6FS	
D 7 B	AP6FS	
D 7 BC	AP6FS	
D 7 BP	AP6FS	
D 8 B	AP5FS	
D 8 BC	AP5FS	
D 8 BP	AP5FS	
D 9 B	AP5FS	
D 9 BC	AP5FS	
DR 10 B	APR5FS	
DR 10 BC	APR5FS	
DR 6 B	APR6FS	
DR 6 BC	APR6FS	

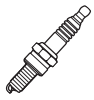

BOSCH	→ NGK	Quick
DR 6 BP	APR6FS	
DR 7 B	APR6FS	
DR 7 BC	APR6FS	
DR 7 BP	APR6FS	
DR 8 B	APR5FS	
DR 8 BC	APR5FS	
DR 8 BP	APR5FS	
DR 9 B	APR5FS	
DR 9 BC	APR5FS	
F 000 KE0 017	BKUR6ET-10	
F 000 KE0 017	BKUR6ET-10	
F 000 KE0 P34	BPR6ES	
F 000 KE0 P40	BKR6ES-11	
F 000 KE0 P41	BKR5ES-11	
F 03 DAR	BKR6EK	
F 04 DAR	BKR6EK	
F 2 CS	R7433-9	
F 2 DTC	R6888A-9	
F 3 CS	R7433-9	
F 4 CS	R7433-8	
F 5 DC	BCP7ES	
F 5 DP	BCP7ES	
F 5 DP 0 R	PFR7B	
F 5 DTC	BCP7ET	
F 5 KPP 332SB	PFR7S8EG	
F 5KP P33 2GF	PFR8S8EG	
F 6 DC	BCP6ES	
F 6 DC 0	BCP6ES	
F 6 DCOR	BKR6ES	
F 6 DCX	BCP6ES-11	
F 6 DP	BCP6ES	
F 6 DPOR	PFR6Q	
F 6 DPX	BCP6ES-11	
F 6 DSR	BKR6EIX	
F 6 DTC	BCP6ET	
F 6 KPP 332 S	PFR6Q	
F 6 LTCR	BKUR7ET	
F 6 MPP 332	ILFR6A	
F 7 DC	BCP6ES	
F 7 DC 0	BCP6ES	
F 7 DCOR	BKR6ES	
F 7 DCX	BCP6ES-11	
F 7 DER	BKR6ES	
F 7 DP	BCP6ES	
F 7 DPER	PFR6G-11	
F 7 DPP 332	IFR6D10	
F 7 DTC	BCP6ET	
F 7 HER 02	ZFR6T-11G	
F 7 HER 2	ZFR5P-G	
F 7 HPP 22	PFR6Q	
F 7 HPP 222	PZFR5D-11	
F 7 HPP 222U	PZFR6J-11	

BOSCH	→ NGK	Quick
F 7 HPPRX	PZFR5D-11	
F 7 KTCR	BKUR6ET-10	
F 7 KTCR	BKUR6ET-10	
F 7 LCOR 2	ZFR6F-11	
F 7 LCR	ZFR6A-11	
F 7 LDCR	BKR6EK	
F 7 LTCR	BKUR6ET-10	
F 7 LTCR	BKUR6ET-10	
F 8 DC	BCP5ES	
F 8 DC 0	BCP5ES	
F 8 DC 4	BCP5ES	
F 8 DCOR	BKR5ES	
F 8 DCX	BCP5ES-11	
F 8 DPER	IFR5D10	
F 8 DPP 332	IFR5D10	
F 8 KTCR	BKUR5ET	
F 8 LCR	ZFR5F	
F 8 LCR 2	ZFR5F	
F 8 LDCR	BKR6EK	
F 9 DC 0	BCPR4ES-11	
F 9 LCR	ZFR4F-11	
FGR 5 KQE 0	BKR7EQUP	
FGR 6 HQE 0	ZFR6S-Q	
FGR 6 KQC	BKR6EQUP	
FGR 6 KQE	BKR6EQUP	
FGR 7 DPP 10	BKR6EIX-11P	
FGR 7 DQE+	BKR6EKUB	
FGR 7 DQE0	BKR6EKUB	
FGR 7 DQP	BKR6EQUP	
FGR 7 DQP+	BKR6EQUP	
FGR 7 KQC	BKR6EQUP	
FGR 7 KQE	BKR6EQUP	
FGR 7 KQE 0	BKR6EQUA	
FGR 8 KQE	BKR5EKUP	
FGR 8 KQE 0	BKR5EQUA	
FGR 8 MQPE	PLFR5A-11	
FLR 8 LDCU	BKR5EK	
FLR 8 LDCU+	BKR5EK	
FQ 5 NIPP 332 S	PLFER7A8EG	
FQ 5 NPP 332 S	PLFER7A8EG	
FQR 8 DE	BKR6EZB	
FQR 8 LEU 2	ZFR5F-11	
FR 10 DCX	BCPR4ES-11	
FR 10 DX	BCPR4ES-11	
FR 5 DC	BCPR7ES	
FR 5 DCX	BCPR7ES-11	
FR 5 DP	BCPR7ES	
FR 5 DTC	BCPR7ET	
FR 5 KPP 332 S	PFR7S8EG	
FR 5 LDC	BKR7EKC	
FR 6 D 133	IFR6J11	
FR 6 D+	BKR6ES	



BOSCH	→ NGK	Quick
FR 6 DC	BKR6ES	
FR 6 DC 0	BKR6EK	
FR 6 DC 2	BKR6ES	
FR 6 DC+	BKR6ES	
FR 6 DCX	BKR6ES-11	
FR 6 DDC	BKR7EKC	
FR 6 DP	BKR6ES	
FR 6 DP 1 X	PFR6J-11	
FR 6 DPX	BKR6ES-11	
FR 6 DTC	BCPR6ET	
FR 6 DTCW	BKR5EKC	
FR 6 HI 332	PZFR6R	
FR 6 KDC	BKR6EZ	
FR 6 KDC+	BKR6EZ	
FR 6 KDE 0	BKR6EKE	
FR 6 KTC	BKUR6ET	
FR 6 LDC	BKR6EK	
FR 6 MPP 10	PLFR6A-11	
FR 6 MPP 332	ILFR6A	
FR 7 DC	BKR6ES	
FR 7 DC 0	BKR6ES	
FR 7 DC 2	BKR6ES	
FR 7 DC 4	BKR6ES	
FR 7 DC+	BKR6ES	
FR 7 DCX	BKR6ES-11	
FR 7 DCX+	BKR6ES-11	
FR 7 DE	BKR6EZ	
FR 7 DP	BKR6ES	
FR 7 DP 1 X	PFR6B-11	
FR 7 DPP 10	BKR6EIX	
FR 7 DPP 22U	PFR6N-11	
FR 7 DPP 33	PFR6Q	
FR 7 DPP+	PFR6B	
FR 7 DPX	BKR6ES-11	
FR 7 DQP	BKR6EQUP	
FR 7 DTC	BCPR6ET	
FR 7 HC 0 X	ZFR5E-11	
FR 7 HC+	ZFR6T-11G	
FR 7 HE 2	ZFR5P-G	
FR 7 HPP 33+	PZFR5D-11	
FR 7 KC	BKR6EY	
FR 7 KC+	BKR6EY	
FR 7 KCU	BKR6EYA-11	
FR 7 KCW	BKR6EP-13	
FR 7 KCX	BKR6EY-11	
FR 7 KCX+	BKR6EY-11	
FR 7 KDC	BKR6EZ	
FR 7 KI30	FR6EI	
FR 7 KPP 33+	PFR6Q	
FR 7 KPP 332	IZFR6H11	
FR 7 KPP 332 U	PFR6X-11	
FR 7 LC 2	BKR6ES	

BOSCH	→ NGK	Quick
FR 7 LCX	ZFR6F-11	
FR 7 LCX+	ZFR6F-11	
FR 7 LD+	BKR6EK	
FR 7 LDC	BKR6EK	
FR 7 LDC+	BKR6EK	
FR 7 LDU	BKR6EK	
FR 7 ME	LFR6A	
FR 7 MPP 10	PLFR6A	
FR 7 NI 33	ILFR6B	
FR 7 NI 332S	ILFR6K8	
FR 7 NPP 332	ILZFR6D11	
FR 7 SI 30	ILZFR6C-11K	
FR 8 DC	BKR5ES	
FR 8 DC 0	BKR5ES	
FR 8 DC+	BKR5ES	
FR 8 DCX	BKR5ES-11	
FR 8 DCX+	BKR5ES-11	
FR 8 DE	BKR5ES	
FR 8 DPP 33	PFR5R-11	
FR 8 DPP 33+	PFR5R-11	
FR 8 DPX	BKR5ES-11	
FR 8 DS	BKR5EIX	
FR 8 DX	BKR5ES-11	
FR 8 HDC	BKR5EKB-11	
FR 8 HDC+	BKR5EKB-11	
FR 8 HP	ZFR5F-11	
FR 8 KCU	BKR5EYA-11	
FR 8 KDC	BKR5EK	
FR 8 LCX	ZFR6F-11	
FR 8 LD+U	BKR5EK	
FR 8 LDC	BKR5EK	
FR 8 LDC 4	BKR5EK	
FR 8 LTC	BKUR5ET-10	
FR 8 ME	LFR5B	
FR 8 SC+	LFR6B	
FR 8 SPP 332	ILFR5B11	
FR 9 DC	BKR5ES	
FR 9 DCX	BCPR4ES-11	
FR 9 HC	ZFR4F-11	
H 10 B	BP4FS	
H 10 BC	BP4FS	
H 10 C	BP4FS	
H 2 CS	B9EFS	
H 3 CS	B8EFS	
H 5 D	BP7EFS	
H 5 DC	BP7EFS	
H 5 DC 0	BP7EFS	
H 5 DP	BP7EFS	
H 6 B	BP6FS	
H 6 BC	BP6FS	
H 6 D	BP6EFS	
H 6 DC	BP6EFS	



BOSCH	→ NGK	Quick
H 6 DC 0	BP6EFS	
H 6 DP	BP6EFS	
H 7 CC	BR6EF	
H 7 CP	BR6EF	
H 7 D	BP6EFS	
H 7 DC	BP6EFS	
H 7 DC 0	BP6EFS	
H 7 DCY	BP6EFS-13	
H 7 DP	BP6EFS	
H 7 DPY	BP6EFS-13	
H 8 B	BP5FS	
H 8 BC	BP5FS	
H 8 BP	BP5FS	
H 8 DC	BP5EFS	
H 8 DC 0	BP5EFS	
H 8 DCX	BP5EFS-13	
H 8 DP	BP5EFS	
H 9 B	BP4FS	
H 9 BC	BP4FS	
H 9 BCY	BPR4FS-15	
H 9 D	BP5EFS	
H 9 DC	BP5EFS	
H 9 DC0	BP5EFS	
H 9 HP	BP5EFS	
HGR 6 KQC	BUR6EFSZ	
HGR 7 KQC	BUR6EFSZ	
HLR 8 STEX	LTR6B-10T	
HR 10 A	BR5FS	
HR 10 AC	BR5FS	
HR 10 ACY	BR5FS	
HR 10 AY	BR5FS	
HR 10 B	BPR4FS	
HR 10 BC	BPR4FS	
HR 10 BCX	BPR4FS-11	
HR 10 BCY	BPR4FS-15	
HR 10 BX	BPR4FS-11	
HR 10 BY	BPR4FS-15	
HR 6 B	BPR6FS	
HR 6 BC	BPR6FS	
HR 6 BP	BPR6FS	
HR 6 D+	BPR6EFS	
HR 6 DC	BPR6EFS	
HR 6 DC+	BPR6EFS	
HR 6 DP	BPR6EFS	
HR 6 DS	BPR6EFS	
HR 7 D+	BPR6EFS	
HR 7 DC	BPR6EFS	
HR 7 DC+	BPR6EFS	
HR 7 DCX	BPR6EFS-13	
HR 7 DCX+	BPR6EFS-13	
HR 7 DCY	BPR6EFS-15	
HR 7 DCY+	BPR6EFS-15	

BOSCH	→ NGK	Quick
HR 7 MPP 302	PTR5A-13	
HR 7 MPP 302 X	PTR5A-13	
HR 7 MPP+	PTR5A-13	
HR 7 MPP+V	PTR5A-13	
HR 8 A	BR5FS	
HR 8 AC	BR5FS	
HR 8 ACY	BR5FS	
HR 8 AP	BR5FS	
HR 8 APY	BR5FS	
HR 8 AY	BR5FS	
HR 8 B	BPR5FS	
HR 8 BC	BPR5FS	
HR 8 BCY	BPR5FS-15	
HR 8 BP	BPR5FS	
HR 8 BPX	BPR5FS-11	
HR 8 BPY	BPR5FS-15	
HR 8 BY	BPR5FS-15	
HR 8 D+	BPR5EFS	
HR 8 DC+	BPR5EFS	
HR 8 DPP 22U	PTR5D-10	
HR 8 LCO	TR5-1	
HR 8 LPO	TR5-1	
HR 8 MCV+	TR5B-13	
HR 8 MEV	TR5B-13	
HR 9 A	BR5FS	
HR 9 AC	BR5FS	
HR 9 ACY	BR5FS	
HR 9 AP	BR5FS	
HR 9 APY	BR5FS	
HR 9 AY	BR5FS	
HR 9 B	BPR4FS	
HR 9 BC	BPR4FS	
HR 9 BC+	BPR4FS	
HR 9 BCY	BPR4FS-15	
HR 9 BCY+	BPR4FS-15	
HR 9 BP	BPR4FS	
HR 9 BPX	BPR4FS-11	
HR 9 BPY	BPR4FS-15	
HR 9 BY	BPR4FS-15	
HR 9 D	BPR5EFS	
HR 9 DC	BPR5EFS	
HR 9 DCX	BPR5EFS-13	
HR 9 DCY+	TR55	
HR 9 DPX	TR5IX	
HR 9 DPY	TR55IX	
HS 5 E	BM7F	
HS 8 E	BM6F	
M 10 A	AB-6	
M 10 A0	AB-6	
M 10 AC	AB-6	
M 10 ACO	AB-6	
M 12 B	AP5FS	



BOSCH	→ NGK	Quick
M 145 T1	AB-6	
M 145 T5	AB-6	
M 175 T1	AB-6	
M 175 T5	AB-6	
M 225 P11S	AB-7	
M 225 T1	AB-7	
M 240 T1	AB-7	
M 260 T1	AB-8	
M 280 T1	AB-8	
M 35 T1	AB-2	
M 4 A	AB-7	
M 4 A1	AB-8	
M 4 A2	AB-7	
M 4 AC	AB-7	
M 45 T1	AB-6	
M 5 A	AB-7	
M 5 AC	AB-7	
M 7 A	AB-6	
M 7 AC	AB-7	
M 8 A	AB-6	
M 8 A0	AB-6	
M 8 AC	AB-6	
M 8 AC0	AB-6	
M 95 T1	AB-6	
M 95 T5	AB-6	
MA 125 T7	AP5FS	
MA 125 TR7	APR5FS	
MA 145 T7	AP5FS	
MA 145 TR7	APR5FS	
MA 175 T1	A6FS	
MA 175 T7	AP6FS	
MA 200 T 7	AP6FS	
MA 225 T 1	A7FS	
MA 95 T7	AP5FS	
MA 95 TR7	APR5FS	
N 40	ZFR5F-11	
U 175 T 1	C6HSA	
U 260 T 1	CR6HS	Q223
U 3 CC	C7E	
U 4 AC	C6HSA	
U 5 AC	C5HSA	
U 6 AC	CR4HSA	
UR 2 AS	CR8HS	
UR 2 CC	CR8E	Q226
UR 3 AC	CR7HSA	
UR 3 AS	CR7HS	
UR 3 CC	CR7E	Q225
UR 4 AS	CR6HS	Q223
UR 6 AC	CR6HS	Q223
USR 7 AC	CMR6H	
VR 8 SE	LZKAR7A	
VR 8 SEW	LZKAR7A	

BOSCH	→ NGK	Quick
W 06 CS	B11EGV	
W 07 AS	BR10HIX	
W 07 CS	B10EGV	
W 08 AS	BR9HIX	
W 08 CS	B10EGV	
W 10 A	B-4H	
W 10 AC	B-4H	
W 10 C	B4ES	
W 10 CC	B4ES	
W 10 D	BP4ES	
W 10 DC	BP4ES	
W 10 E	B-4	
W 10 EC	B-4	
W 10 F	BP-4	
W 10 FC	BP-4	
W 12 A	B-4H	
W 12 E	B-2	
W 125 T1	B-4H	
W 125 T2	B4ES	
W 125 T3	B-4	
W 125 T30	BP5ES	
W 125 T4	B-4H	
W 125 T6	BP5S	
W 125 TR2	BR5ES	
W 125 TR3	BR6S	
W 125 TR30	BPR5ES	
W 125 TR6	BP5S	
W 145 M1	B5HS	
W 145 M2	B5ES	
W 145 T1	B5HS	
W 145 T11	B5HS	
W 145 T2	B5ES	
W 145 T3	B6S	Q302
W 145 T30	BP5ES	
W 145 T35	BP5HS	
W 145 T6	BP5S	
W 145 TR2	BR5ES	
W 145 TR3	BR6S	
W 145 TR30	BPR5ES	
W 145 TR6	BP5S	
W 160 T2	B6ES	
W 160 T30	BP5ES	
W 175 T1	B6HS	Q203
W 175 T2	B6ES	
W 175 T3	B6S	Q302
W 175 T30	BP6ES	
W 175 T35	BP6HS	
W 175 T6	BP6S	
W 175 T7	BP6HS	
W 175 TR1	BR6HS	Q209
W 175 TR2	BR6ES	
W 175 TR30	BPR6ES	



BOSCH	→ NGK	Quick
W 175 TR35	BPR6HS	Q214
W 175 TR35	BPR6HS	Q214
W 175 TR35	BPR6HS	Q214
W 175 Z1	B6HS	Q203
W 190 M11S	BR6HIX	
W 2 A	B9HS	
W 2 AC	B9HS	
W 2 AS	BR9HIX	
W 2 C	B10ES	
W 2 C 0	B10ES	
W 2 CC	B10ES	
W 2 CS	BR10EIX	
W 2 D	BP9ES	
W 200 T27	BP6ES	
W 200 T30	BP6ES	
W 200 T35	BP6HS	
W 200 TR30	BPR6ES	
W 215 P21	BPR7EIX	
W 215 T30	BP6ES	
W 220 T30	BP6ES	
W 225 S1S	BR7HIX	
W 225 S2S	BR7EIX	
W 225 T1	B7HS	Q204
W 225 T2	B7ES	
W 225 T3	B7S	
W 225 T30	BP8ES	
W 225 T35	BP7HS	
W 225 T7	BPR7HS	Q215
W 225 TR1	BR7HS	Q211
W 225 TR2	BR7ES	
W 225 TR30	BPR7ES	
W 230 T30	BP7ES	Q206
W 235 P21	BP7ES	Q206
W 235 T28	BP8ES	
W 240 M1	B8HS	Q205
W 240 MZ1	B8HS	Q205
W 240 T1	B8HS	Q205
W 240 T2	B8ES	Q201
W 240 T28	B8ES	Q201
W 240 T3	B7S	
W 250 P21	BP7ES	Q206
W 250 T1	B8HS	Q205
W 250 T2	B8ES	Q201
W 250 TR2	BR8ES	Q207
W 255 T30	BP7ES	Q206
W 260 M1	B8HS	Q205
W 260 MZ1	B8HS	Q205
W 260 MZ2	B9ES	Q202
W 260 S1S	BR8HIX	
W 260 S2S	BR8EIX	
W 260 T1	B8HS	Q205
W 260 T2	B8ES	Q201

BOSCH	→ NGK	Quick
W 260 T20	B8ES	Q201
W 260 T30	BP8ES	
W 265 P21	BPR9EIX	
W 275 T1	B8HS	Q205
W 275 T2	B9ES	Q202
W 280 MZ1	B8HS	Q205
W 280 MZ2	B9ES	Q202
W 280 P21	BP8ES	
W 280 S1S	BR9HIX	
W 280 S2S	BR9EIX	
W 280 T30	BP8ES	
W 3 A	B8HS	Q205
W 3 A 0	B8HS	Q205
W 3 AC	B8HS	Q205
W 3 AP	B8HS	Q205
W 3 AS	BR8HIX	
W 3 C	B9ES	Q202
W 3 C0	B9ES	Q202
W 3 CC	B9ES	Q202
W 3 CP	B9ES	Q202
W 3 CS	BR9EIX	
W 3 D	BP8ES	
W 3 DP	BPR8EIX	
W 3 DP 2	BP8ES	
W 3 DP0	BPR8EIX	
W 300 MZ2	B10ES	
W 300 T1	B9HS	
W 300 T2	B10ES	
W 300 T30	BP9ES	
W 310 S1S	BR9HIX	
W 310 S2S	BR10EIX	
W 330 T1	B9HS	
W 340 S1S	BR9HIX	
W 340 S2S	B10EGV	
W 370 S1S	BR10HIX	
W 370 S2S	B10EGV	
W 4 A	B8HS	Q205
W 4 A 1	B8HS	Q205
W 4 A 2	B8HS	Q205
W 4 A 5	B8HS	Q205
W 4 AC	B8HS	Q205
W 4 AP	B8HS	Q205
W 4 AS	BR8HIX	
W 4 C	B8ES	Q201
W 4 C 1	B8ES	Q201
W 4 C 2	B7ES	
W 4 C 3	B7HS	Q204
W 4 CC	B8ES	Q201
W 4 CP	BR8EIX	
W 4 CPX	B8ES	Q201
W 4 CS	BR8EIX	
W 4 DP	BPR7EIX	



BOSCH	→ NGK	Quick
W 4 DP 0	BPR8EIX	
W 4 E2	B7S	
W 400 S1S	BR10HIX	
W 400 S2S	B11EGV	
W 45 T1	B-4H	
W 45 T3	B-4	
W 5 A	B7HS	Q204
W 5 AC	B7HS	Q204
W 5 AP	B7HS	Q204
W 5 AS	BR7HIX	
W 5 B	BP7HS	
W 5 BC	BP7HS	
W 5 BP	BP7HS	
W 5 C	B7ES	
W 5 CC	B7ES	
W 5 CCX	B7ES-11	
W 5 CP	B7ES	
W 5 CPX	B7ES-11	
W 5 CS	BR7EIX	
W 5 D	BP7ES	Q206
W 5 D 1	BP7ES	Q206
W 5 DC	BP7ES	Q206
W 5 DC0	BP7ES	Q206
W 5 DCX	BP7ES-11	
W 5 DP	BP7ES	Q206
W 5 DP0	BPR7EIX	
W 5 DPX	BP7ES-11	
W 5 DTC	BUR6ET	
W 5 E	B7S	
W 5 EC	B7S	
W 5 EP	B7S	
W 6 AC	B6HS	Q203
W 6 B	BP6HS	
W 6 BC	BP6HS	
W 6 BP	BP6HS	
W 6 D	BP6ES	
W 6 D 1	BP6ES	
W 6 DC	BP6ES	
W 6 DC 0	BP6ESZ	
W 6 DCX	BP6ES-11	
W 6 DP	BPR6EIX	
W 6 DP 0	BPR6EIX	
W 6 DTC	BUR6ET	
W 6 LTCR	BUR6ET	
W 7 A	B6HS	Q203
W 7 A 0	B6HS	Q203
W 7 AC	B6HS-5	
W 7 AO 0	B6HS	Q203
W 7 AP	B6HS	Q203
W 7 B	BP6HS	
W 7 BC	BP6HS	
W 7 BP	BP6HS	

BOSCH	→ NGK	Quick
W 7 C	B6ES	
W 7 CC	B6ES	
W 7 CC 0	B6ES	
W 7 CCX	B6ES-11	
W 7 CP	B6ES	
W 7 CPX	B6ES-11	
W 7 CX	B6ES-11	
W 7 D	BP6ESZ	
W 7 D 0	BP6ES	
W 7 DC	BP6ES	
W 7 DC 0	BP6ESZ	
W 7 DCR	BPR6ES	
W 7 DCX	BP6ES-11	
W 7 DP	BP6ES	
W 7 DPX	BP6ES-11	
W 7 DTC	BUR6ET	
W 7 DX	BP6ES-11	
W 7 E	B6S	Q302
W 7 EC	B6S	Q302
W 7 EP	B6S	Q302
W 7 F	BP6S	
W 7 FC	BP6S	
W 7 LTCR	BUR6ET	
W 8 A	B5HS	
W 8 A 0	B5HS	
W 8 AC	B5HS	
W 8 AP	B5HS	
W 8 B	BP5HS	
W 8 BC	BP5HS	
W 8 BP	BP5HS	
W 8 C	B5ES	
W 8 C 0	B5ES	
W 8 CC	B5ES	
W 8 CCX	B5ES	
W 8 CP	B5ES	
W 8 D	BP5ES	
W 8 DC	BP5ES	
W 8 DC 0	BP5ES	
W 8 DCX	BP5ES-11	
W 8 DCY	BP5ES-13	
W 8 DP	BP5ES	
W 8 DPX	BP5ES-11	
W 8 DTC	BP5ET	
W 8 DX	BP5ES-11	
W 8 E	B6S	Q302
W 8 EC	B6S	Q302
W 8 F	BP5S	
W 8 FC	BP5S	
W 8 LCR	ZGR5A	
W 8 LDCR	BUR6ET	
W 8 LPR	ZGR5A	
W 8 LTCR	BUR5ET-10	



BOSCH	→ NGK	Quick
W 8 LTCR	BUR5ET	
W 9 A	B-4H	
W 9 A0	B-4H	
W 9 AC	B5HS	
W 9 AC 0	B5HS	
W 9 C	B4ES	
W 9 CC	B4ES	
W 9 D	BP5ES	
W 9 DC	BP5ES	
W 9 DC0	BP5ES	
W 9 DCX	BP5ES-11	
W 9 DP	BP5ES	
W 9 DPX	BP5ES-11	
W 9 DTC	BP5ET	
W 9 E	B-4	
W 9 E0	B4-LM	Q301
W 9 EC	B-4	
W 9 EC 0	B4-LM	Q301
W 9 F	BP5S	
W 9 FC	BP5S	
W 9 LC	ZGR5A	
W 95 T1	B-4H	
W 95 T2	B4ES	
W 95 T3	B-4	
W 95 T30	BP4ES	
W 95 T6	BP-4	
W 95 TR6	BP-4	
WA 125 T30	BP5EFS	
WA 125 T40	BP4FS	
WA 125 TR30	BPR5EFS	
WA 125 TR4	BR5FS	
WA 125 TR40	BPR4FS	
WA 145 T40	BP5FS	
WA 145 TR4	BR5FS	
WA 145 TR40	BPR5FS	
WA 175 T30	BP6EFS	
WA 200 T30	BP6EFS	
WA 200 T40	BP6FS	
WA 200 TR30	BPR6EFS	
WA 200 TR40	BPR6FS	
WA 225 T30	BP7EFS	
WA 95 T40	BP4FS	
WA 95 TR4	BR5FS	
WA 95 TR40	BPR4FS	
WAK 145 T3	BM6F	
WAK 225 T3	BM7F	
WEA	BUH	
WEC	BUE	
WET 1	BUH	
WET 2	BUE	
WG 235 T28	BP7ES	Q206
WG 250 P21	BPR9EIX	

BOSCH	→ NGK	Quick
WG 250 T28	BPR8EIX	
WG 250 T30	BP8ES	
WG 265 T2SP	BPR9EIX	
WKA 145 T3	BM6A	Q303
WKA 145 T6	BPM6A	Q304
WKA 145 TR6	BPMR6A	Q308
WKA 175 T3	BM6A	Q303
WKA 175 T6	BPM6A	Q304
WKA 200 TR6	BPMR6A	Q308
WKA 225 T3	BM7A	
WKA 225 T6	BPM7A	Q305
WR 10 A	BR4HS	
WR 10 AC	BR4HS	
WR 10 E	BR6S	
WR 10 F	BP-4	
WR 10 FC	BP-4	
WR 10 FCY	BP-4	
WR 10 FY	BP-4	
WR 10 LC	ZGR5B	
WR 10 LCV	BPR4ES-13	
WR 11 E 0	BR4-LM	
WR 2 CC	BR10ES	
WR 3 CC	BR9ES	Q208
WR 3 CS	BR9EIX	
WR 3 CTC	BR9ET	
WR 4 AC	BR8HS	Q212
WR 4 CC	BR8ES	Q207
WR 4 CP	BR8EIX	
WR 5 A	BR7HS	Q211
WR 5 AC	BR7HS	Q211
WR 5 C	BR7ES	
WR 5 CC	BR7ES	
WR 5 CP	BR7ES	
WR 5 D+	BPR7ES	
WR 5 DC	BPR7ES	
WR 5 DC+	BPR7ES	
WR 5 DP	BPR7ES	
WR 5 DS	BPR7EIX	
WR 6 BC	BPR6HS	Q214
WR 6 BC	BPR6HS	Q214
WR 6 BC	BPR6HS	Q214
WR 6 D+	BPR6ES	
WR 6 DC	BPR6ES	
WR 6 DC+	BPR6ES	
WR 6 DCX	BPR6ES-11	
WR 6 DP	BPR6ES	
WR 6 DPX	BPR6ES-11	
WR 6 DS	BPR6EIX	
WR 6 DTC	BUR6ET	
WR 7 A	BR6HS	Q209
WR 7 AC	BR6HS	Q209
WR 7 B+	BPR6HS	Q214



BOSCH	→ NGK	Quick
WR 7 B+	BPR6HS	Q214
WR 7 B+	BPR6HS	Q214
WR 7 BC	BPR6HS	Q214
WR 7 BC	BPR6HS	Q214
WR 7 BC	BPR6HS	Q214
WR 7 BC+	BPR6HS	Q214
WR 7 BC+	BPR6HS	Q214
WR 7 BC+	BPR6HS	Q214
WR 7 BP	BPR6HS	Q214
WR 7 BP	BPR6HS	Q214
WR 7 BP	BPR6HS	Q214
WR 7 C	BR6ES	
WR 7 CC	BR6ES	
WR 7 CCX	BR6ES-11	
WR 7 CP	BR6ES	
WR 7 CPX	BR6ES-11	
WR 7 D+	BPR6ES	
WR 7 DC	BPR6ES	
WR 7 DC+	BPR6ES	
WR 7 DC2	BPR6ES	
WR 7 DCX	BPR6ES-11	
WR 7 DCX+	BPR6ES-11	
WR 7 DP	BPR6EIX	
WR 7 DS	BPR6EIX	
WR 7 DTC	BUR6ET	
WR 7 EC	BR6S	
WR 7 F	BP6S	
WR 7 LTC+	BUR6ET	
WR 8 AC	BR5HS	
WR 8 B+	BPR5HS	
WR 8 BC	BPR5HS	
WR 8 BC+	BPR5HS	
WR 8 C	BR5ES	
WR 8 CC	BR5ES	
WR 8 CP	BR5ES	
WR 8 D+	BPR5ES	
WR 8 DC	BPR5ES	
WR 8 DC+	BPR5ES	
WR 8 DC0	BPR5ES	
WR 8 DC4	BPR5ES	
WR 8 DCX	BPR5ES-11	
WR 8 DCX+	BPR5ES-11	
WR 8 DP	BPR5ES	
WR 8 DPX	BPR5ES-11	
WR 8 DPY	BPR5ES-13	
WR 8 DS	BPR5EIX	
WR 8 E	BR6S	
WR 8 EC	BR6S	
WR 8 EP	BR6S	
WR 8 F	BP5S	
WR 8 FC	BP5S	
WR 8 FP	BP5S	

BOSCH	→ NGK	Quick
WR 8 FPY	BP5S	
WR 8 HP	ZGR5C	
WR 8 LC+	ZGR5A	
WR 8 LTC+	BUR5ET-10	
WR 9 A0	BR5HS	
WR 9 C	BR5ES	
WR 9 CC	BR5ES	
WR 9 D+	BPR5ES	
WR 9 DC	BPR5ES	
WR 9 DC+	BPR5ES	
WR 9 DCX	BPR5ES-11	
WR 9 DCX+	BPR5ES-11	
WR 9 DCY	BPR5ES-13	
WR 9 DP	BPR5ES	
WR 9 DPX	BPR5ES-11	
WR 9 DS	BPR5EIX	
WR 9 DY	BPR5ES-13	
WR 9 E	BR6S	
WR 9 E0	BR6S	
WR 9 EC	BR6S	
WR 9 EC0	BR6S	
WR 9 F	BP5S	
WR 9 FC	BP5S	
WR 9 FCY	BP5S	
WR 9 FP	BP5S	
WR 9 FPY	BP5S	
WR 9 FY	BP5S	
WR 9 H	ZGR5C	
WR 9 HC	ZGR5C	
WR 9 HP	ZGR5C	
WR 9 LC	ZGR5A	
WR 9 LS	ZGR5A	
WS 5 E	BM7A	
WS 5 F	BPM7A	Q305
WS 6 E	BM6A	Q303
WS 6 F	BPM6A	Q304
WS 7 E	BM6A	Q303
WS 7 F	BPM6A	Q304
WS 8 E	BM6A	Q303
WS 8 F	BPM6A	Q304
WS 9 EC	BM4A	
WSR 5 F	BPMR7A	Q309
WSR 6 E	BMR6A	Q307
WSR 6 F	BPMR7A	Q309
WSR 7 F	BPMR6A	Q308
WSR 9 E	BMR4A	Q306
WSR 9 EC	BMR4A	Q306
X 175 T 1	D5HS	
X 260 T 1	D6HA	
X 260 T 2	D6EA	
X 3 CP 0	D9EA	
X 300 T 1	D8HA	



BOSCH	→ NGK	Quick
X 300 T 2	D9EA	
X 4 CS	D8EA	Q216
X 5 CC	D8EA	Q216
X 5 DC	DP7EA-9	
XR 2 AS	DR8HS	
XR 2 CS	DR8ES	Q217
XR 4 AS	DR8HS	
XR 4 CS	DR8ES	Q217
XR 4 DC	DPR8EA-9	Q221
XR 5 DC	DPR7EA-9	Q220
XR 6 CC	DR7EA	
XR 7 LDC	DPR7EA-9	Q220
Y 5 KPP 332 S	PZKER7A8EGS	
Y 6 DC	DCP6E	
YR 5 DDE	KR9CI	
YR 5 LDE	DCPR8EKC	
YR 6 LDE	DCPR8EKC	
YR 6 NPP 332	PLKR7B8E	
YR 6 TII 330 T	ILZKR7A	
YR 7 DC+	ZKR7A-10	
YR 7 DE	DCPR8E-N	
YR 7 MPP 33	PLKR7A	
ZMR 5 TPP 33	SILZKBR8D8S	
ZQR 8 SI 302	PLZKBR7B8DG	Q216
ZR 7 SI 332 S	PLZKBR7B8DG	Q216

BRISK	→ NGK	Quick
B 12 YC	DP9EA-9	
B 14 YC	DP8EA-9	
B 15 YC	DP7EA-9	
D 12 YC	BCP7ES	
D 14 Y	BCP7ES	
D 14 YC	BCP7ES	
D 15 Y	BCP6ES	
D 15 YC	BCP6ES	
D 17 Y	BCP5ES	
D 17 YC	BCP5ES	
DOX 15 LE 1	ZFR6T-11G	
DR 12 YC	BKR7E	
DR 14 YC	BKR7E	
DR 14 ZC	ZFR7F-11	
DR 14 ZC 1	BCPR7ES-11	
DR 15 TC	BKUR5ET-10	
DR 15 YC	BKR6ES	
DR 15 Z	BKR6ES	
DR 15 Z 1	BKR6ES-11	
DR 17 YC	BKR5ES	
F 14 YC	AP7FS	
F 15 YC	AP6FS	
FR 14 YC	APR6FS	
FR 15 YC	APR6FS	

BRISK	→ NGK	Quick
G 12 YC	BP7EFS	
G 14 Y	BP7EFS	
G 14 YC	BP7EFS	
G 15 Y	BP6EFS	
G 15 YC	BP6EFS	
G 17 Y	BP5EFS	
G 17 YC	BP5EFS	
GR 15 YC	BPR6EFS	
GR 17 YC	BPR5EFS	
J 17	B4-LM	Q301
J 19	B2-LM	
JR 17	BR4-LM	
JR 19	BR2-LM	Q310
K 15 YC	BP6S	
K 17 C	B6S	Q302
K 17 Y	BP5S	
K 19	B-4	
L 08 JW	B10EGV	
L 08 W	B11EGV	
L 10 JW	B8EGV	
L 12 W	BR9EIX	
L 12 Y	BP8ES	
L 12 YC	BP8ES	
L 14	B8ES	Q201
L 14 C	B8ES	Q201
L 14 Y	BP7ES	Q206
L 14 YC	BP7ES	Q206
L 15	B7ES	
L 15 C	B7ES	
L 15 W	BR7EIX	
L 15 Y	BP6ES	
L 15 YC	BP6ES	
L 17	B6ES	
L 17 C	B6ES	
L 17 W	BR7EIX	
L 17 Y	BP5ES	
L 17 YC	BP5ES	
L 19	B-4E	
L 19 C	B5ES	
LR 12 YC	BPR8ES	Q213
LR 12 ZC	BPR8ES	Q213
LR 14 TXS	BUR6ET	
LR 14 YC	BPR7ES	
LR 14 ZC	BPR7ES	
LR 14 ZC 1	BPR7ES-11	
LR 15 TXS	BUR6ET	
LR 15 YC	BPR6ES	
LR 15 Z	BPR6ES	
LR 15 Z 1	BPR6ES-11	
LR 17 YC	BPR5ES	
N 08 W	BR10HIX	
N 12 W	BR9HIX	



BRISK	→ NGK	Quick
N 12 Y	BP8HS	
N 12 YC	BP8HS	
N 14	B8HS	Q205
N 14 C	B8HS	Q205
N 14 Y	BP7HS	
N 14 YC	BP7HS	
N 15	B7HS	Q204
N 15 C	B7HS	Q204
N 15 W	BR8HIX	
N 15 Y	BP6HS	
N 15 YC	BP6HS	
N 17	B6HS	Q203
N 17 C	B6HS	Q203
N 17 W	BR7HIX	
N 17 Y	BP5HS	
N 17 YC	BP5HS	
N 19	B5HS	
N 19 C	B5HS	
NR 12 YC	BPR8HS	
NR 15 YC	BPR6HS	Q214
NR 15 YC	BPR6HS	Q214
NR 15 YC	BPR6HS	Q214
P 15	BM7A	
P 15 Y	BPM7A	Q305
P 17	BM6A	Q303
P 17 Y	BPM6A	Q304
PR 15 Y	BPMR7A	Q309
PR 17 Y	BPMR6A	Q308
U 15	BM7F	
U 17	BM6F	
UR 17	BMR6F	
CHAMPION	→ NGK	Quick
860	A6FS	
2301	BPR5ES-11	
2322	BPR4ES-11	
2332	BPR6ES	
2338	BKR6ES	
2415	BPR5ES	
2430	BKR5E-11	
3322	BPR5EIX-11	
3344	BKR6EIX-11	
3407	TR5-1IX	
5828	BZ7HS-10	
5843	BM7A	
5846	BM6A	Q303
5847	BM6F	
5861	B2-LM	
5883	BR7HS	Q211
5931	BR6HS	Q209
5933	B6HS	Q203

CHAMPION	→ NGK	Quick
5939	BPR7HS	Q215
9005	IZFR6F11	
88 091	DPR7EA-9	Q220
9 179 100	PFR6G	
9 202 064	BKR6EKUB	
A 10	D7EA	
A 4 HC	DP9EA-9	
A 5 YC	DP9EA-9	
A 51 R	R2525-10	
A 55 C	R2525-10	
A 55 R	R2525-10	
A 55 V	R2349-11	
A 57 CST	R2525-10	
A 57 G	R2525-10	
A 59 C	D9EA	
A 59 G	DR9EIX	
A 59 GC	DCPR9EIX	
A 6	D8EA	Q216
A 6 G	DR8EIX	
A 6 GC	DR8EIX	
A 6 HC	DP8EA-9	
A 6 Y	DP8EA-9	
A 6 YC	DP8EA-9	
A 61	D9EA	
A 61 G	DR9EIX	
A 8	D7EA	
A 8 Y	DP7EA-9	
A 8 YC	DP7EA-9	
BL 11 Y	BP5FS	
BL 13 Y	BP5FS	
BL 4	B7FS	
BL 5	B7FS	
BL 6	BR6FS	
BL 7 Y	BP7FS	
BL 8	BR6FS	
BL 9 Y	BP6FS	
BN 12 Y	BP5EFS	
BN 2	B9EFS	
BN 6 Y	BP7EFS	
BN 7 Y	BP6EFS	
BN 89 Y	BP6EFS	
BN 9 Y	BP6EFS	
C 10 YCC	BCP6ES	
C 11 YCC	BCP5ES	
C 12 YCC	BK5E	
C 281 YC	BCP6ES	
C 55	R7436-10	
C 55 R	R7436-10	
C 57	R7436-9	
C 57 A	R7436-10	
C 57 C	R7436-9	
C 57 CX	R7434-10	

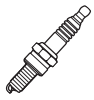

CHAMPION	→ NGK	Quick
C 57 JC 4	R7436-10	
C 57 YCST	R7436-9	
C 59	R7436-9	
C 59 C	R7436-9	
C 6 BYC	BCP7ET	
C 6 VPYC	BKR7EIX-11	
C 6 YCC	BCP7ES	
C 61	R7436-8	
C 7 Y	BCP7ES	
C 7 YC	BCP7ES	
C 7 YCC	BCP7ES	
C 7 YCX	BCP7ES	
C 9 MCC	ZFR5F	
C 9 Y	BCP6ES	
C 9 YC	BCP6ES	
C 9 YCC	BCP6ES	
C 9 YCX	BCP6ES	
CJ 11	BM6A	Q303
CJ 14	BM4A	
CJ 17 LM	B4-LM	Q301
CJ 3	BM7A	
CJ 4	BM7A	
CJ 6	BM7A	
CJ 6 Y	BPM7A	Q305
CJ 7 Y	BPM7A	Q305
CJ 8	BM6A	Q303
CJ 8 Y	BPM6A	Q304
CJ 86	BM6A	Q303
D 10	AB-6	
D 14	AB-6	
D 16	AB-6	
D 16 J	AB-6	
D 21	AB-6	
D 23	AB-6	
D 6	AB-8	
D 9	AB-6	
D 9 J	AB-6	
DJ 6 J	BM7F	
DJ 6 Y	BPM7F	
DJ 7 J	BM6F	
DJ 7 Y	BPM6F	
DJ 8 J	BM6F	
EON 1	BKR6ES	
EON 2	BKR5ES	
EON 3	BPR5EFS	
EON 4	TR5A-10	
EON 5	BPR6ES	
EON 6	BPR5ES	
F 10	A6FS	
F 10 C	A6FS	
F 11 Y	AP5FS	
F 11 YC	AP5FS	

CHAMPION	→ NGK	Quick
F 14 Y	AP5FS	
F 62 Y	AP8FS	
F 7 Y	AP7FS	
F 7 YC	AP7FS	
F 7 YCC	AP7FS	
F 81 Y	AP8FS	
F 82	A8FS	
F 83 Y	AP8FS	
F 9 Y	AP6FS	
F 9 YC	AP6FS	
FN 507 Y	BCP7ES	
G 1	C9E	
G 2	C8E	
G 54 V	R0045J-10	
G 55	C9E	
G 56 R	R0373A-10	
G 58	C9E	
G 59 C	C7E	
G 61	C8E	
G 63	C8E	
G 63 R	CR8EIX	
H 03	B6S	Q302
H 10	B-6L	
H 10 C	B-6L	
H 10 J	B-6L	
H 11	B-4L	
H 12	B-4L	
H 8	B-6L	
H 8 C	B-6L	
H 8 J	B-6L	
J 10 Y	BP6S	
J 11	B-4	
J 11 C	B-4	
J 11 J	B-4	
J 11 Y	BP5S	
J 12 J	B-2	
J 12 Y	BP5S	
J 12 YC	BP5S	
J 13 Y	BP5S	
J 14	B-2	
J 14 J	B-2	
J 14 Y	BP5S	
J 14 YC	BP5S	
J 17 LM	B4-LM	Q301
J 18 Y	BP-4	
J 18 YC	BP-4	
J 19 LM	B2-LM	
J 4	B7S	
J 4 C	B7S	
J 4 J	B7S	
J 5	B7S	
J 6	B6S	Q302



CHAMPION	→ NGK	Quick
J 6 C	B6S	Q302
J 6 J	B6S	Q302
J 7	B6S	Q302
J 7 J	B6S	Q302
J 8	B6S	Q302
J 8 C	B6S	Q302
J 8 J	B6S	Q302
K 13	AB-6	
K 15 J	AB-6	
K 3 G	AB-8	
K 5 G	AB-8	
K 7	AB-8	
K 8	AB-8	
K 8 G	AB-8	
K 9	AB-7	
L 10	B6HS	Q203
L 12 Y	BP5HS	
L 14	B-4H	
L 15 Y	BP4HS	
L 19 V	BUH	
L 2 G	BR9HIX	
L 20 V	BUH	
L 288	B5HS	
L 3 G	BR8HIX	
L 4 G	BR7HIX	
L 4 J	B7HS	Q204
L 5	B7HS	Q204
L 55 G	BR10HIX	
L 6 G	BR7HIX	
L 6 VC	BU8H	
L 61 Y	BP8HS	
L 64 Y	BP7HS	
L 66 Y	BP6HS	
L 7 J	B6HS	Q203
L 76 V	BUHW	
L 77 J	B7HS	Q204
L 77 J 4	B7HS-10	
L 77 JC	B7HS	Q204
L 77 JC 4	B7HS-10	
L 77 V	BUHW	
L 78	B7HS	Q204
L 78 C	B7HS	Q204
L 78 V	BUHW-2	
L 78 YC	BP7HS-10	
L 78 YC 6	BP8HS-15	
L 81	B7HS	Q204
L 81 Y	BP7HS	
L 82	B6HS	Q203
L 82 C	B6HS	Q203
L 82 Y	BP6HS	
L 82 YC	BP6HS	
L 82 YCC	BP6HS	

CHAMPION	→ NGK	Quick
L 85	B6HS	Q203
L 85 Y	BP6HS	
L 86	B6HS	Q203
L 86 C	B6HS	Q203
L 86 CC	B6HS	Q203
L 87 Y	BP6HS	
L 87 YC	BP6HS	
L 87 YCC	BP6HS	
L 9 G	BR6HIX	
L 9 J	B6HS	Q203
L 90	B5HS	
L 90 C	B5HS	
L 92 LCC	BP5HA	
L 92 Y	BP5HS	
L 92 YC	BP5HS	
L 92 YC 4	BP5HS-10	
L 95 Y	BP4HS	
N 1	B10ES	
N 1 C	B10ES	
N 10 PY	BPR6EIX	
N 10 Y	BP6ES	
N 10 Y 4	BP6ES-11	
N 10 YC	BP5ES	
N 11 Y	BP5ES	
N 11 YC	BP5ES	
N 11 YC 4	BP5ES-11	
N 11 YCC	BP5ES	
N 12 Y	BP5ES	
N 12 YC	BP5ES	
N 12 YCC	BP5ES	
N 13 L	ZGR5C	
N 13 Y	BP5ES	
N 14 LY	ZGR5C	
N 14 Y	BP5ES	
N 16 Y	BP4ES	
N 16 YC	BP4ES	
N 178 B	BR8EM	
N 180 B	B7EM	
N 19 V	BUJ	
N 2	B9ES	Q202
N 2 C	B9ES	Q202
N 2 G	BR9EIX	
N 21	B4ES	
N 279 YC	BP7ES	Q206
N 281 YC	BP6ES	
N 288	B5ES	
N 3	B8ES	Q201
N 3 C	B8ES	Q201
N 3 G	BR8EIX	
N 4	B7ES	
N 4 C	B7ES	
N 4 G	BR7EIX	



CHAMPION	→ NGK	Quick
N 4 YC	BP9ES	
N 5	B6ES	
N 5 C	B6ES	
N 54 R	B10EG	
N 55 G	B105EGV	
N 56 R	B105EGP	
N 57	B10ES	
N 57 G	B105EGV	
N 57 R	B10EG	
N 59 G	B95EGV	
N 6	B6ES	
N 6 BYC	BUR6ET	
N 6 GY	BPR8EIX	
N 6 Y	BP8ES	
N 6 YC	BP8ES	
N 6 YCC	BP8ES	
N 60	B9ES	Q202
N 60 R	B8EG	
N 62 R	B8EG	
N 63 Y	BP9ES	
N 64 Y	BP8ES	
N 65 Y	BP7ES	Q206
N 66 Y	BP6ES	
N 7	B7ES	
N 7 BMC	BUR6ET	
N 7 BYC	BUR6ET	
N 7 GY	BPR7EIX	
N 7 Y	BP7ES	Q206
N 7 YC	BP7ES	Q206
N 7 YCC	BP7ES	Q206
N 7 YCX	BP7ES	Q206
N 74 C	BUR6EB-11	
N 79 Y	BP6ES	
N 8	B6ES	
N 8 GY	BPR6EIX	
N 8 L	ZGR5C	
N 8 Y	BP6ES	
N 80	B10EG	
N 80 G	B11EGV	
N 82	B10EG	
N 82 G	B105EGV	
N 84	B9EG	
N 84 G	B95EGV	
N 86	B9EG	
N 86 G	B9EGV	
N 87	B8EG	
N 87 G	B8EGV	
N 89 GY	BP6ES	
N 89 Y	BP5ES	
N 9 BMC	BPR5EKU	
N 9 BYC	BUR6ET	
N 9 BYC 4	BP5ET-10	

CHAMPION	→ NGK	Quick
N 9 Y	BP6ES	
N 9 YC	BP6ES	
N 9 YC 4	BP6ES-11	
N 9 YCC	BP6ES	
N 9 YCE	BP5ES	
N 9 YCX	BP6ES	
N 92 Y	BP4ES	
OBL 9 Y	BPR6FS	
OE 001	BP6ES	
OE 002	BKR6ES	
OE 003	BCP6ES	
OE 004	BPR6ES	
OE 005	BKR6ES	
OE 006	BPR6ES	
OE 007	BP6HS	
OE 008	BPR7ES	
OE 009	BP6EFS	
OE 010	BP7ES	Q206
OE 011	BPR6EFS	
OE 012	BUR6ET	
OE 013	BKR5ES	
OE 014	BCPR7ES	
OE 015	BP5ES	
OE 016	BKR6ES	
OE 017	BCP7ES	
OE 018	BPR7ES	
OE 019	BKR5EK	
OE 020	BPR6EFS	
OE 021	BCPR6ET	
OE 022	BP6ES	
OE 023	BCP6ES	
OE 024	BKR6E-11	
OE 025	BUR6ET	
OE 026	BKR6EK	
OE 027	BUR5ET-10	
OE 028	BP5ET-10	
OE 030	BKR6EKC	
OE 031	PTR5A-13	
OE 032	BKUR6ET-10	
OE 032	BKUR6ET-10	
OE 033	BKR6EZ	
OE 034	BKR6ES	
OE 035	LFR5B	
OE 036	BP6EFS	
OE 037	B6HS	Q203
OE 038	BP6HS	
OE 039	BKR6ES-11	
OE 040	B9ES	Q202
OE 041	ZFR5F	
OE 042	BPR5ES	
OE 043	BCPR7ES	
OE 044	BUR6ET	



CHAMPION	→ NGK	Quick
OE 045	BPR5ES	
OE 046	BP7ES	Q206
OE 048	BPR6ES-11	
OE 049	BPR5ES-11	
OE 050	BP7EFS	
OE 051	BPR5ES	
OE 052	DCPR9EIX	
OE 053	APR6FS	
OE 054	APR6FS	
OE 055	BP5ES	
OE 056	BKR7ES-11	
OE 057	BCP5ES	
OE 058	BCP7ES	
OE 059	BP5HS	
OE 060	ZGR5B	
OE 061	AP7FS	
OE 063	BKR6ES-11	
OE 064	BPR6HS	Q214
OE 064	BPR6HS	Q214
OE 064	BPR6HS	Q214
OE 065	BP5ES	
OE 067	BP7EFS	
OE 068	B8ES	Q201
OE 070	BP6HS	
OE 071	BPR6HS	Q214
OE 071	BPR6HS	Q214
OE 071	BPR6HS	Q214
OE 074	B6ES	
OE 075	BCP7ES	
OE 076	BCP7ET	
OE 077	BCPR6ET	
OE 078	BR8EIX	
OE 079	B7ES	
OE 080	BKR7ES-11	
OE 084	BP8ES	
OE 085	BKR5EKU	
OE 086	BR6HS	Q209
OE 087	BP8ES	
OE 088	BKR5E	
OE 089	ZFR6F-11	
OE 090	BP7EFS	
OE 091	BR9ES	Q208
OE 092	CR9E	Q227
OE 093	BKR5EZ	
OE 094	BCPR7ES	
OE 095	BUR6ET	
OE 096	B6HS	Q203
OE 098	BR7ES	
OE 100	BPR5EKU	
OE 102	BKR6EZ	
OE 103	DCPR9EIX	
OE 104	BP6HS	

CHAMPION	→ NGK	Quick
OE 105	GR4	
OE 106	BP5ES	
OE 107	BPR7ES-11	
OE 108	BR8ES	Q207
OE 109	BUR6ET	
OE 110	BCPR7ES	
OE 111	BPR6ES	
OE 112	DR8EIX	
OE 114	BRE527Y-11	
OE 115	ZFR5N	
OE 116	BPR8ES	Q213
OE 119	BKR6ES	
OE 120	BKUR5ET-10	
OE 122	PMR7A	
OE 124	PFR5J-11	
OE 125	BR9EIX	
OE 127	BKR5E	
OE 129	BKR7EIX-11	
OE 130	LZKAR7B	
OE 132	DP8EA-9	
OE 134	PFR5J-11	
OE 136	PFR6J-11	
OE 138	PFR5G-11	
OE 141	BKR6EIX	
OE 143	PFR6G-9	
OE 144	BKUR6ET-10	
OE 144	BKUR6ET-10	
OE 146	PFR5G-13E	
OE 151	BPR5EFS	
OE 152	BKR5E-11	
OE 154	ZFR5F-11	
OE 155	APR6FS	
OE 156	ZGR5C	
OE 160	ZFR4F-11	
OE 161	GR4	
OE 162	BR6ES	
OE 163	LZTR4A-11	
OE 165	R7436-9	
OE 166	C7E	
OE 167	PLZTR5A-13	
OE 168	TR5IX	
OE 169	R5724-9	
OE 171	BPR6FS	
OE 172	B9EG	
OE 173	R2525-10	
OE 174	PTR5A-13	
OE 175	LFR5AP-11	
OE 178	LFR5B	
OE 190	IFR5G11	
OE 197	PLKR7A	
OE 198	ZFR6V-G	
OE 199	DCPR8E	



CHAMPION	→ NGK	Quick
OE 201	LZKR6B-10E	
OJ 11 Y	BP6S	
OJ 12 Y	BP5S	
OJ 13 Y	BP5S	
ON 11 Y	BP5ES	
ON 12 Y	BP5ES	
ON 3	BR8ES	Q207
P 10 Y	D6HA	
P 7	D8HA	
P 7 G	DR8HS	
P 7 Y	D8HA	
P 8 Y	D6HA	
PA 5 HC	D7EA	
PA 7 HC	D7EA	
PG 2 PHP	PMR8A	
PG 4 PHP	PMR7A	
PG 7 C	C7E	
PL 7 YC 4	BP6HS-10	
PL 9 YC	BP6HS	
PN 5 C	B8ES	Q201
PRL 5 SC	BR6HSA	Q210
PRL 9 SC	BR4HSA	
PRZ 9 HC	CR7HSA	
PZ 7 HC	C7HSA	
PZ 9 HC	C6HSA	
Q 504 V	R2349-10	
QC 10 PEPB	IZFR6N-E	
QC 10 WEP	IZFR6F11	
QC 12 PEP	PZFR6H	
QC 12 PEPB	IZFR6N-E	
QC 12 YC	BKR5ES	
QC 501 V	R7434-10	
QC 9 MC 4	ZFR6F-11	
QJ 17 LM	BR4-LM	
QJ 19 LM	BR2-LM	Q310
QL 16 V	BUZ8H	
QL 6 VC	BU8H	
QL 7 J 5	BR6HS	Q209
QL 76 V	BUZHW	
QL 77 CC	BR8HS	Q212
QL 77 J 4	BZ7HS-10	
QL 77 JC 4	BZ7HS-10	
QL 78 C	BR7HS	Q211
QL 78 V	BUZHW-2	
QL 78 YC	BPR7HS	Q215
QL 82 C	BR6HS	Q209
QL 82 YC	BPR6HS	Q214
QL 82 YC	BPR6HS	Q214
QL 82 YC	BPR6HS	Q214
QL 86	BR6HS	Q209
QL 86 C	BR6HS	Q209
QL 87 YC	BPR6HS	Q214

CHAMPION	→ NGK	Quick
QL 87 YC	BPR6HS	Q214
QL 87 YC	BPR6HS	Q214
QL 92 LCC	BP8HS-10	
QN 2	BR9ES	Q208
QN 2 C	BR9ES	Q208
QN 2 G	BR9EIX	
QN 3	BR8ES	Q207
QN 3 C	BR8ES	Q207
QN 84	BR9EG	
QN 86	BR8EG	
R 10	D6EA	
R 54 G	R2525-10	
R 6	D8EA	Q216
R 6 G	DR8EIX	
R 6 J	D8EA	Q216
R 8	D7EA	
RA 2 HC	DPR7EA-9	Q220
RA 4 HCC	DCPR8E	
RA 4 HCX	DCPR9EIX	
RA 59 GC	DCPR9EIX	
RA 59 PP	DCPR9EIX	
RA 6	DR8ES-L	Q218
RA 6 Y	DPR7EA-9	Q220
RA 6 YC	DPR7EA-9	Q220
RA 7 YC	DCPR8E	
RA 8 GHC	DCPR6E	
RA 8 HC	DCPR7E	
RA 8 Y	DPR7EA-9	Q220
RA 8 YC	DPR7EA-9	Q220
RAX 92 C	DR9EA	Q219
RAX 92 DC	JR9C	
RAX 92 YC	DPR7EA-9	Q220
RAX 94 C	DR8EA	
RAX 94 YC	DPR7EA-9	Q220
RAX 96 C	DR7EA	
RAX 96 YC	DPR7EA-9	Q220
RBL 11 Y	BPR5FS	
RBL 11 Y 6	BPR5FS-15	
RBL 12	BR5FS	
RBL 126	BR5FS	
RBL 13 Y	BPR5FS	
RBL 13 Y 6	BPR5FS-15	
RBL 15 Y	BPR4FS	
RBL 15 Y 4	BPR4FS-11	
RBL 15 Y 6	BPR4FS-15	
RBL 16 Y	BPR4FS	
RBL 17 Y	BPR4FS	
RBL 17 Y 6	BPR4FS-15	
RBL 8	BR6FS	
RBL 86	BR6FS	
RBL 9 Y	BPR6FS	
RBN 12 Y	BPR5EFS	



CHAMPION	→ NGK	Quick
RBN 13 Y	BPR5EFS	
RBN 14 Y	BPR5EFS	
RBN 9 Y	BPR6EFS	
RC 10 DMC	BKR5EK	
RC 10 ECC	ZFR6F-11	
RC 10 MCC	ZFR6V-G	
RC 10 PYC	BKR6EIX	
RC 10 PYP 4	PFR5J-11	
RC 10 PYPB 4	PFR5G-11	
RC 10 YC	BKR5E	
RC 10 YC 4	BKR6ES-11	
RC 10 YCC	BKR6ES	
RC 10 YCL	BKR5EZ	
RC 11 LCC 4	BRE527Y-11	
RC 11 PYPB 4	PFR5G-11	
RC 12 ECC	ZFR5N	
RC 12 LYC	ZFR5F	
RC 12 MC 5	ZFR5F-11	
RC 12 MC4	PZFR5F-11	
RC 12 MCC 4	ZFR5F-11	
RC 12 PEC5	ZFR5LP-13G	
RC 12 PYP	PFR5J-11	
RC 12 YC	BKR5ES	
RC 12 YC5	FR45	
RC 14 ES	ZFR5LP-13G	
RC 14 YC	BKR5ES	
RC 14 YC 4	BKR5E-11	
RC 503 C	R7433-8	
RC 6 VPYC	BKR7EIX-11	
RC 6 YC	BCPR7ES	
RC 6 YCC	BCPR7ES	
RC 7 BMC	BCPR6ET	
RC 7 BYC 4	BCPR6ET	
RC 7 GYC	BKR7EIX-11	
RC 7 GYG	BKR6EIX	
RC 7 Y	BCPR7ES	
RC 7 YC	BCPR7ES	
RC 7 YC 4	BKR7ES-11	
RC 7 YCC	BCPR7ES	
RC 7 YCC 4	BKR7ES-11	
RC 8 BYC	BKR6EKC	
RC 8 DMC	BKR6EK	
RC 8 PYCB	PFR6G-9	
RC 8 PYP	PFR6J-11	
RC 8 PYP 4	PFR6G-11	
RC 8 PYPB 4	PFR5G-13E	
RC 8 VTYC 4	BKUR6ET-10	
RC 8 VTYC 4	BKUR6ET-10	
RC 8 YC	BKR5E	
RC 8 YC 4	BKR5E-11	
RC 8 YCC	BKR6ES	
RC 8 YCL	BKR6ES	

CHAMPION	→ NGK	Quick
RC 87 PYC	BKUR6ET-10	
RC 87 PYC	BKUR6ET-10	
RC 87 YC	BKR6ES	
RC 87 YCC	BKR6EZ	
RC 87 YCL	BKR6EZ	
RC 89 TMC	BKUR5ET-10	
RC 89 YCC	BKR5EZ	
RC 9 BMC	BKR5EQU	
RC 9 MC 4	ZFR5F-11	
RC 9 MCC 4	ZFR6F-11	
RC 9 TMC	BKR6EKUB	
RC 9 YC	BKR6ES	
RC 9 YC 4	BKR6ES-11	
RC 9 YC 5	BKR6E-11	
RC 9 YCC	BKR6ES	
RC 9 YCC 4	BKR6E-11	
RC 9 YCN 4	BKR6E-11	
RCJ 4	BMR7A	
RCJ 501 H	BPMR4A	
RCJ 6	BMR7A	
RCJ 6 Y	BPMR7A	Q309
RCJ 7 Y	BPMR7A	Q309
RCJ 8	BMR6A	Q307
RCJ 8 Y	BPMR6A	Q308
RD 14	AB-6	
RD 16	AB-6	
RD 16 J	AB-6	
RD 9	AB-6	
RDJ 6 J	BM7F	
RDJ 7 J	BMR6F	
RDJ 7 Y	BPMR6F	
RDJ 8 J	BMR6F	
RE 10 LC	TR5-11X	
RE 10 PMC 5	PTR5A-13	
RE 10 YC 4	BKR5ES-11	
RE 14 MCC 4	LZTR4A-11	
RE 14 MCC 5	LZTR4A-11	
RE 14 PLP 5	PLZTR5A-13	
RE 7 PYC 5	PTR5A-13	
RE 7 YCC	PTR5A-13	
REA 12 WMB 4	LZKAR6AP-11	
REA 8 MCL	LZKAR7B	
REA 8 MX	LZKAR7B	
REC 10 PYC 4	LFR5AP-11	
REC 10 WYPB 4	IFR5G11	
REC 9 MCLX	LFR5B	
REC 9 YCL	LFR5B	
RER 8 MC	LZKR6B-10E	
RER 8 YC	PLKR7A	
RES 9 YCC 4	PTR5A-13	
RF 10	AR6FS	
RF 10 C	AR6FS	



CHAMPION	→ NGK	Quick
RF 11 Y	APR6FS	
RF 11 YC	APR6FS	
RF 14 Y	APR5FS	
RF 7 YC	APR6FS	
RF 7 YCC	APR6FS	
RF 9 Y	APR6FS	
RF 9 Y 5	APR6FS	
RF 9 YC	APR6FS	
RFN 14 LY	ZFR4F-11	
RG 2 PHP	CR8EIX	
RG 4 HC	CR9E	Q227
RG 4 PHP	PMR7A	
RG 6 YC	CR8EB	
RG 6 YCA	CPR8E	
RG 6 YCH	CPR8E	
RG 92 C	CR9E	Q227
RG 92 DC	CR9EK	Q230
RG 94 C	CR8E	Q226
RGU 92 C	CR9EH-9	Q229
RGU 94 C	CR8EH-9	Q228
RH 10 C	B-6L	
RH 18 Y	B-4L	
RJ 10 Y	BP6S	
RJ 11	BR6S	
RJ 11 Y	BP5S	
RJ 12	BR6S	
RJ 12 Y	BP5S	
RJ 12 YC	BP5S	
RJ 14 CC	XR4	
RJ 14 Y	BP5S	
RJ 14 YC	BP5S	
RJ 17 LM	BR4-LM	
RJ 18 Y	BP-4	
RJ 18 YC	BP-4	
RJ 18 YC 6	XR45IX	
RJ 19 LMC	BR2-LM	Q310
RJ 20 Y	BP-4	
RJ 6	BR6S	
RJ 6 C	BR6S	
RJ 6 J	BR6S	
RJ 7	BR6S	
RJ 8	BR6S	
RJ 8 C	BR6S	
RJ 8 J	BR6S	
RL 12 Y	BPR6HS	Q214
RL 12 Y	BPR6HS	Q214
RL 12 Y	BPR6HS	Q214
RL 19	BR5HS	
RL 4 J	BR7HS	Q211
RL 7 J	BR6HS	Q209
RL 77 J	BR7HS	Q211
RL 78	BR7HS	Q211

CHAMPION	→ NGK	Quick
RL 78 C	BR7HS	Q211
RL 82	BR6HS	Q209
RL 82 C	BR6HS	Q209
RL 82 Y	BPR6HS	Q214
RL 82 Y	BPR6HS	Q214
RL 82 Y	BPR6HS	Q214
RL 82 YC	BPR6HS	Q214
RL 82 YC	BPR6HS	Q214
RL 82 YC	BPR6HS	Q214
RL 82 YCC	BPR6HS	Q214
RL 82 YCC	BPR6HS	Q214
RL 82 YCC	BPR6HS	Q214
RL 85	BR6HS	Q209
RL 86	BR6HS	Q209
RL 86 C	BR6HS	Q209
RL 87 Y	BPR6HS	Q214
RL 87 Y	BPR6HS	Q214
RL 87 Y	BPR6HS	Q214
RL 87 YC	BPR6HS	Q214
RL 87 YC	BPR6HS	Q214
RL 87 YC	BPR6HS	Q214
RL 90	BR5HS	
RL 95 YC	BPR5HS	
RN 1 C	BR10ES	
RN 10 GY	BPR6EIX	
RN 10 PYP 4	PGR5A-11	
RN 10 VTYC	BUR5ET	
RN 10 VTYC 4	BUR5ET-10	
RN 10 Y	BPR6ES	
RN 10 Y 4	BPR6ES-11	
RN 10 YC	BPR6ES	
RN 11 Y	BPR5ES	
RN 11 YC	BPR5ES	
RN 11 YC 4	BPR5ES-11	
RN 11 YCC	BPR5ES	
RN 12 GY	BPR5EIX	
RN 12 MC 4	BPR4EY-11	
RN 12 Y	BPR5ES	
RN 12 YC	BPR5ES	
RN 12 YC 4	BPR5ES-11	
RN 12 YC 6	BPR5ES-13	
RN 12 YCC	BPR5ES	
RN 13 L	ZGR5C	
RN 13 LYC	ZGR5C	
RN 14 LY	ZGR5C	
RN 14 MC 5	BPR4EY-11	
RN 14 PMP 5	GR4	
RN 14 Y	BPR5ES	
RN 14 Y 6	BPR5ES-13	
RN 14 YC	GR4	
RN 16 Y	BPR4ES	
RN 16 YC 5	BPR4ES-13	



CHAMPION	→ NGK	Quick
RN 16 YC 6	BPR4EY-11	
RN 180 B	BR7EM	
RN 2	BR9ES	Q208
RN 2 C	BR9ES	Q208
RN 2 G	BR9EIX	
RN 3	BR8ES	Q207
RN 3 C	BR8ES	Q207
RN 3 G	BR8EIX	
RN 4	BR7ES	
RN 4 C	BR7ES	
RN 5	BR6ES	
RN 5 C	BR6ES	
RN 57 YC	BR10EG	
RN 6	BR6ES	
RN 6 Y	BPR8ES	Q213
RN 6 YC	BPR8ES	Q213
RN 7 GY	BPR7EIX	
RN 7 Y	BPR7ES	
RN 7 YC	BPR7ES	
RN 7 YCC	BPR7ES	
RN 7 YCC 4	BPR7ES-11	
RN 74 C	BUR6EB-11	
RN 8	BR5ES	
RN 8 L	ZGR5C	
RN 8 VTYC 4	BUR6ET	
RN 9 BMC	BPR5EKU	
RN 9 GY	BPR6EIX	
RN 9 LCC	ZGR5B	
RN 9 Y	BPR6ES	
RN 9 YC	BPR6ES	
RN 9 YC 4	BPR6ES-11	
RN 9 YCC	BPR6ES	
RP 10 HC	DR5HS	
RP 7	DR8HS	
RS 10 LC	TR5-1	
RS 12 PYP	TR5IX	
RS 12 YC	BPR5EFS	
RS 12 YC 6	BPR5EFS-13	
RS 13 LYC	TR4	
RS 14 LC	TR5-1	
RS 14 LYC	TR4	
RS 14 PYP	TR4IX	
RS 14 YC	BPR5EFS	
RS 14 YC6	TR55IX	
RS 15 LYC	TR4	
RS 16 YC	TR4	
RS 17 YX	TR4	
RS 5 C	BR7EFS	
RS 9 YC	BPR6EFS	
RS 9 YCC	BPR6EFS	
RV 12 C	BR5FS	
RV 12 C 6	BR5FS	

CHAMPION	→ NGK	Quick
RV 12 YC	BPR5FS	
RV 12 YC 6	BPR5FS-15	
RV 15 YC	BPR4FS	
RV 15 YC4	BPR4FS-11	
RV 15 YC6	BPR4FS-15	
RV 17 YC	BPR4FS	
RV 17 YC6	BPR4FS-15	
RV 8 C	BR6FS	
RV 8 C 6	BR6FS	
RV 9 YC	BPR6FS	
RV 91 MC	BR6FS	
RV 92 YC	BPR5FS	
RZ 7 C	CMR7H	
RZ 94 C	CR8HSA	
RZ 96 C	CR7HSA	
RZN 12 Y	BPR5EFS	
RZN 12 Y 5	BPR5EFS	
S 279 YC	BP6EFS	
S 281 YC	BP6EFS	
S 379 YC	BP7EFS	
S 59 C	R5724-9	
S 59 CST	R5724-9	
S 6 YC	BP7EFS	
S 7 YC	BP7EFS	
S 7 YCC	BP7EFS	
S 9 YC	BP6EFS	
S 9 YCC	BP6EFS	
UD 16	AB-6	
UF 11 Y	AP6FS	
UF 9 Y	AP6FS	
UJ 12	B-2	
UJ 2 J	B8S	
UJ 4 J	B7S	
UJ 6	B6S	Q302
UJ 8	B6S	Q302
UJ 81 C	B7S	
UJ 81 J	B7S	
UK 10	AB-6	
UL 17 V	BUHXW-1	
UL 18 V	BUHX	
UL 4 J	B7HS	Q204
UL 77 V	BUHXW-1	
UL 81 C	B7HS	Q204
UL 81 J	B7HS	Q204
UL 82 Y	BP7HS	
UN 19 V	BUE	
UN 79 Y	BP6ES	
V 12 YC	BP5FS	
V 4 C	B7FS	
V 61	R5673-8	
V 63 C	R5673-7	
V 9 YC	BP6FS	



CHAMPION	→ NGK	Quick
XC 12 PEPB	PZFR6H	
XC 92 YC	BKR5E	
XJ 10 Y	BP6S	
Y 82	CM-6	
Z 10	C6HSA	
Z 10 G	CR7HIX	
Z 12	C6HSA	
Z 6	C8HSA	
Z 7 G	CR7HIX	
Z 8	C7HSA	
Z 9 Y	C7HSA	

DAYTONA	→ NGK	Quick
61 479	BR8EIX	
61 480	BR9EIX	
61 481	CR8EIX	
61 482	B8HCS	
61 483	CR8EHIX-9	
61 484	CR9EHIX-9	
61 485	CR6HIX	
61 486	CR7HIX	
61 487	CR8HIX	
61 488	DR8EIX	
61 489	DR9EIX	
61 490	BPR6HIX	
61 491	BPR7HIX	
61 492	BPR8HIX	
61 493	DPR7EIX-9	
61 494	DPR8EIX-9	

DENSO	→ NGK	Quick
3004	BPR5EP-11	
3005	BCPR5EIX-11	
3006	BCPR5EY-11	
3009	BCPR6EY-11	
3011	BP4EY	
3013	BPR4EY	
3018	BP5ES	
3025	B5ES	
3027	BP5EY	
3032	BPR5EY-11	
3034	B5HS	
3036	BP5S	
3043	BP6ES	
3046	BUR6EA-11	
3049	BPR6ES-11	
3051	B6ES	
3057	BR6ES	
3062	BP6EY	
3066	BPR6EY	
3067	BPR6EY-11	

DENSO	→ NGK	Quick
3068	BP6HS	
3070	BPR6HS	Q214
3070	BPR6HS	Q214
3070	BPR6HS	Q214
3073	B6HS	Q203
3074	BR6HIX	
3075	B6S	Q302
3085	BP7ES	Q206
3088	BPR7ES	
3089	BPR7ES-11	
3093	B7ES	
3095	BR7EIX	
3098	BR7ES	
3103	BR8ET	
3107	BR9ET	
3110	BR5ES	
3111	SD11A	
3112	ZFR6A-11	
3113	BCPR6EP-N-8	
3114	PGR5A-11	
3115	PGR6A-11	
3117	BCPR6EP-11	
3119	BKR5EYA	
3120	BKR5EYA-11	
3121	BKR6E-11	
3122	BKR6EYA	
3123	BCPR5EP-8	
3125	BCP6ES	
3127	BKR6EP-8	
3128	BKR6EP-11	
3129	BCPR5EY	
3130	BKR5E-11	
3131	ZFR5J-11	
3132	ZFR5F-11	
3133	ZFR6J-11	
3134	BKR5EP-11	
3135	ZFR5E-11	
3139	BKR6EY-11	
3140	BCPR6EY	
3141	PFR6J-11	
3142	PFR6G-11	
3144	BKR6E-N-11	
3156	BCPR5EIX-11	
3157	BCPR6EIX-11	
3161	BKR5EIX-11	
3163	BKR6EIX-11	
3165	BKR7E	
3167	ZFR4F-11	
3168	PFR6B-11	
3169	ZFR6F-11	
3172	PFR6G-13	
3174	PFR5J-11	



DENSO	→ NGK	Quick
3175	PZFR5F	
3179	DCPR7E	
3184	BCPR5EY-11	
3186	BCPR5EY-11	
3187	BCPR6EY-11	
3192	BKR7E-11	
3194	BKR5EKB-11	
3195	BKR6EKB-11	
3196	BKUR6EK	
3197	BKUR7EK	
3199	BP5EY-11	
3201	BPR5ES-11	
3210	BPR5EY	
3213	BPR5ES-13	
3226	BKR6EP-13	
3231	BPR5EIX	
3235	BCRE527Y	
3239	BPR5EP-11	
3244	BCPR6EIX-11	
3245	PFR6J	
3246	PZFR5F-11	
3247	PZFR6F-11	
3253	BKR6EKPB-11	
3255	BCP7ES	
3256	ZGR5A	
3262	BKR6EIX-11	
3264	PFR5B-11	
3273	PFR7B	
3275	PFR5G-11	
3277	BPR6EKN	
3281	BPR7EIX	
3285	BPR5EIX-11	
3289	BKR5EKPB-11	
3290	BKR7EIX	
3291	BPR6EIX	
3293	BKR5EIX	
3297	IFR6T11	
3299	BKR7E-N-11	
3302	PGR7A	
3303	IFR5T-8N	
3304	BKR6EKC	
3305	BKUR6EK-9	
3306	PGR6A	
3307	IFR6C	
3310	BR10ET	
3312	DCPR8E	
3313	DCPR9E	
3314	DCPR9EIX	
3333	BKR6E	
3344	BPR6ES	
3345	BPR5ES	
3346	BCPR5E	

DENSO	→ NGK	Quick
3347	BCPR7ES	
3348	ZFR7F-11	
3349	BKR5E	
3353	BKR5EIX-11P	
3354	IGR7A	
3372	IFR7G-11KS	
3373	BKR6EP-8	
3374	ZFR6K-11	
3377	IZFR6K11	
3378	ZFR6FIX-11	
3379	BCPR7ES-11	
3380	BKR6EKPA	
3381	LF6C-11	
3398	BKR6EIX-11P	
3400	IFR5E11	
3403	IFR6S	
3412	IFR5E11	
3413	ZFR5F	
3418	IFR6E11	
3424	BKR6E	
3427	LZKAR7A	
3432	IZFR6K11NS	
3434	IKR7C	
3437	FR5EI	
3439	DILKAR6A11	
3441	ILKR7B8	
3444	ILKAR7B11	
3449	IFR6J11	
4019	BP5HS	
4021	BP7HS	
4025	B7HS	Q204
4026	BR7HIX	
4027	B7S	
4028	BP8ES	
4030	B8ES	Q201
4032	B8EGV	
4048	B9EGV	
4057	B95EGV	
4093	DP8EA-9	
4097	DPR8EIX-9	
4136	BPR8ES	Q213
4167	DR8EIX	
4172	DR9EIX	
4189	CR8EIX	
4201	CR7EK	
5008	APR5FS	
5012	AP6FS	
5013	APR6FS	
5022	BPR5EFS	
5027	BPR5FS-15	
5031	BP6EFS	
5032	BPR6EFS	

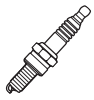

DENSO	→ NGK	Quick
5035	BPR6FS	
5040	BP7EFS	
5060	BKUR6ET	
5061	BKUR6ET-10	
5061	BKUR6ET-10	
5062	BKUR7ET	
5063	BKR6EKUB	
5064	BP5ET-10	
5065	BUR6ET	
5066	BP7ET	
5067	BUR6ET	
5068	PTR5A-13	
5069	BCP7ET	
5070	PTR5D-10	
5077	PZTR5A-15	
5301	BCPR5EIX-11	
5302	BCPR6EIX-11	
5303	BKR5EIX-11	
5304	BKR6EIX-11	
5305	BPR5EIX-11	
5306	BPR6EIX-11	
5307	BPR7EIX	
5308	DCPR7EIX	
5310	IRIWAY7	
5311	IRIWAY8	
5312	IRIWAY9	
5313	IRITOP7	
5316	BR8EIX	
5317	BR9EIX	
5325	TR5IX	
5326	TR6IX	
5327	TR7IX	
5328	TR8IX	
5330	UR5IX	
5331	UR6IX	
5343	LFR5AIX-11	
5344	LFR6AIX-11	
5361	CR7EIX	
5362	CR8EIX	
5372	DR8EIX	
5376	DPR8EIX-9	
5378	BPR6HIX	
5379	BR7HIX	
5601	BCPR5EIX-11P	
5602	BCPR6EIX-11P	
5603	BKR5EIX-11P	
5604	IZFR6H11	
5608	DCPR7EIX-P	
5615	IFR6L11	
5616	IFR8H11	
5617	ILZFR5B	
5618	ILZFR6D11	

DENSO	→ NGK	Quick
5619	LFR7AIX-P	
5620	BKR6EIX-P	
5623	HB6AIX-11P	
5625	HB6BIX-11P	
5630	IFR9H11	
5639	LFR6AIX-P	
6054	B6HS	Q203
6076	LFR5A-11	
FK 20 HBR 11	DFH6B-11A	
FXE 20 HR 11	DILKAR6A11	
FXE 22 HR 11	DF7H-11B	
FXE 24 HR 11	DF8H-11B	
IA 01-32	R7282A-105	
IA 01-34	R7282A-11	
IAE 01-32	R7282-105	
IAE 01-34	R7282-11	
IK 01-24	R7434-8	
IK 01-27	R7434-9	
IK 01-31	R7434-10	
IK 02-24	R7434-8	
IK 02-27	R7434-9	
IK 02-31	R7434-10	
IK 16	BKR5EIX-11	
IK 20	BKR6EIX-11	
IK 22	IRIWAY7	
IK 24	IRIWAY8	
IK 24 C 11	FR8BI-11	
IK 27	IRIWAY9	
IK 27 C 11	FR9BI-11	
IKH 01-24	R7438-8	
IKH 01-27	R7438-9	
IKH 01-31	R7438-10	
IKH 16	LFR5AIX-11	
IKH 20	LFR6AIX-11	
IQ 01-24	R7436-8	
IQ 01-27	R7436-9	
IQ 01-31	R7436-10	
IQ 02-24	R7436-8	
IQ 02-27	R7436-9	
IQ 02-31	R7436-10	
IQ 16	BCPR5EIX-11	
IQ 20	BCPR6EIX-11	
IQ 22	IRITOP7	
IQ 24	IRITOP8	
IQ 27	IRITOP9	
IRE 01-34	R7420-11	
IT 16	TR5IX	
IT 20	TR6IX	
IT 22	TR7IX	
IT 24	TR8IX	
ITF 16	UR5IX	
ITF 20	UR6IX	



DENSO	→ NGK	Quick
IU 01-27	R0373A-9	
IU 01-31	R0373A-10	
IU 01-34	R0373A-11	
IU 22	CR7EIX	
IU 24	CR8EIX	
IU 27	B8HCS	
IU 27 D	CR9EIA-9	
IUF 22	CR7HIX	
IUF 24	CR8HIX	
IUH 24	CR8EHIX-9	
IUH 27	CR9EHIX-9	
IUH 27 D	IMR9A-9H	
IW 01-24	R7376-8	
IW 01-27	R7376-9	
IW 01-31	R7376-10	
IW 06-27	R7376-9	
IW 06-31	R7376-10	
IW 16	BPR5EIX-11	
IW 20	BPR6EIX-11	
IW 22	BPR7EIX	
IW 24	BR8EIX	
IW 27	BR9EIX	
IW 31	BR10EIX	
IWF 20	BPR6HIX	
IWF 22	BR7HIX	
IWF 24	BR8HIX	
IWF 27	BR9HIX	
IWM 24	BR8ECMIX	
IWM 27	BR9ECMIX	
IWM 31	BR10ECMIX	
IX 22	DR7EIX	
IX 22 B	DPR7EIX-9	
IX 24	DR8EIX	
IX 24 B	DPR8EIX-9	
IX 27	DR9EIX	
IX 27 B	DPR9EIX-9	
IXU 01-27	R2525-9	
IXU 01-31	R2525-10	
IXU 01-34	R2349-11	
IXU 22	DCPR7EIX	
IXU 22 C	KR7AI	
IY 24	ER8EHIX	
J 16 AR-U 11	BRE527Y-11	
J 16 A-U 11	BE527Y-11	
J 16 AY	BPR5EY-11	
J 16 AYR	BPR5EJ	
J 16 BR-U	BRE529Y	
J 16 BR-U 11	BRE529Y-11	
J 16 B-U 11	BE529Y-11	
J 16 CR-U	ZGR5A	
J 16 C-U	BPR5EY	
J 20 AY	BPR6EY-11	

DENSO	→ NGK	Quick
K 14 PR-U 11	BKR4E-11	
K 14 P-U 11	BKR5E-11	
K 16 DTR-S 11	ZFR5G	
K 16 GPR-U 11	ZFR5E-11	
K 16 HPR-U 11	LFR5A-11	
K 16 PR-L 11	BKR5E-N-11	
K 16 PR-P 11	BKR5EIX	
K 16 PR-TP 11	BKR5EIX-11	
K 16 PR-U	BKR5E	
K 16 PR-U 11	BKR5E-11	
K 16 PRUR	BKR5E	
K 16 PRZ-U 11	BKR5EIX-11	
K 16 PSR-B 8	FR5EI	
K 16 P-U	BK5E	
K 16 P-U 11	BK5E-11	
K 16 R-U	BKR5EYA	
K 16 R-U 11	BKR5EYA-11	
K 16 RZ-U 11	BKR5EIX-11	
K 16 TNRS 9	BKR5EKC	
K 16 TR 11	BKR5EKB-11	
K 16 U	BKR5EYA	
K 16 U 11	BKR5EYA-11	
K 20 DTR-S 11	ZFR6G	
K 20 HR-U	LFR6B	
K 20 HR-U 11	LFR6C-11	
K 20 PBR	BKUR6ET	
K 20 PBR-S 10	BKUR6ET-10	
K 20 PBR-S 10	BKUR6ET-10	
K 20 PR-L 11	BKR6E-N-11	
K 20 PR-TP 11	BKR6EIX-11	
K 20 PR-U	BKR6E	
K 20 PR-U 11	BKR6E-11	
K 20 PR-U 9 S	BKR6E-9S	
K 20 PRUR	BKR6E	
K 20 PRZ-U 11	BKR6EIX-11	
K 20 PSR-B 8	FR6EI	
K 20 P-U	BK6E	
K 20 P-U 11	BK6E-11	
K 20 R-U	BKR6EYA	
K 20 R-U 11	BKR6EY-11	
K 20 RZ	BKR6EIX	
K 20 RZ-U 11	BKR6EIX-11	
K 20 TMR 11	BKR6EKC-N-11	
K 20 TNR	BKR6EKC	
K 20 TNR-S	BKUR6EK	
K 20 TNRS 9	BKUR6EK-9	
K 20 TR 11	BKR6EKB-11	
K 20 TRX	BKR6EKU	
K 20 TXR	BKR6EKUB	
K 20 U	BKR6EYA	
K 20 U 11	BKR6EYA-11	
K 22 P 11	BK7EK-N-11	



DENSO	→ NGK	Quick
K 22 PB	BCP7ET	
K 22 PBR-S	BKUR7ET	
K 22 PR-L 11	BKR7E-N-11	
K 22 PR-TP 11	BKR7EIX-11	
K 22 PR-U	BKR7E	
K 22 PR-U 11	BKR7E-11	
K 22 PRUR	BKR7E	
K 22 PRZ-U	BKR7EIX	
K 22 PRZ-U 11	BKR7EIX-11	
K 22 P-U 11	BK7E-11	
K 22 TM 11	BK7EK-N-11	
K 22 TMR	BKR7EKC-N	
K 22 TMR 11	BKR7EKC-N-11	
K 22 TNR	BKR7EKC	
K 22 TNRS	BKUR7EK	
K 24 PR-U 11	BKR8E-11	
K 29 AZ	R7434-10	
KJ 14 CR 11	ZFR4F-11	
KJ 14 CR-L 11	ZFR4F-11	
KJ 16 CR	ZFR5F	
KJ 16 CR 11	ZFR5J-11	
KJ 16 CR-L 11	ZFR5F-11	
KJ 16 CR-U 11	ZFR5F-11	
KJ 20 CR 11	ZFR6J-11	
KJ 20 CR-L 11	ZFR6F-11	
KJ 20 CR-U 11	ZFR6F-11	
KJ 20 DR-M 11	ZFR6K-11	
KJ 20 SR 11	ZFR6FIX-11	
KJ 206 CR-L 11	ZFR6F-11	
KJ 22 CR 11	ZFR7F-11	
KJ 22 CR-L 11	ZFR7F-11	
KJ 22 CR-L 8	ZFR7F	
L 14 U	AB-6	
M 17	AB-6	
M 22	AB-7	
M 24 S	AB-8	
MA 14 P-U	AP5FS	
MA 16 PR-U	APR5FS	
MA 16 PR-U 11	APR5FS	
MA 16 PR-U 15	APR5FS	
MA 16 P-U	AP5FS	
MA 17 P-U	AP6FS	
MA 20 PR-U	APR6FS	
MA 20 P-U	AP6FS	
MA 20 R-U	AR6FS	
MA 20 R-U 11	AR6FS	
MW 17	AB-6	
MW 22	AB-7	
MW 9	AB-2	
P 16 PR 11	PGR5A-11	
P 16 PR 8	PGR5A	
P 16 R	BPR5EP-11	

DENSO	→ NGK	Quick
P 16 R 13	BPR5EP-11	
P 20 PR 11	PGR6A-11	
P 20 PR 8	PGR6A	
P 20 R 8	BPR6EP-8	
P 22 PR 8	PGR7A	
PK 16 PR 11	PFR5B-11	
PK 16 PR-L 11	PFR5G-11	
PK 16 PR-P 11	PFR5J-11	
PK 16 R 11	BKR5EP-11	
PK 16 TR 11	BKR5EKP-11	
PK 16 TR 13	BKR5EKP-13	
PK 20 GR 8	BKR6EPA-8	
PK 20 PR 11	PFR6B-11	
PK 20 PR-L 11	PFR6G-11	
PK 20 PR-L 13	PFR6G-13	
PK 20 PRP	PFR6J	
PK 20 PR-P 11	PFR6J-11	
PK 20 PR-P 8	PFR6J	
PK 20 PRTP	PFR6M	
PK 20 PTR-S 9	BKR6EKPA	
PK 20 R 11	BKR6EP-11	
PK 20 R 13	BKR6EP-13	
PK 20 R 8	BKR6EP-8	
PK 20 RP 8	BKR6EP-N-8	
PK 20 TR 11	BKR6EKP-11	
PK 22 PR 11	PFR7B-11	
PK 22 PR 8	PFR7B	
PK 22 PR-L 11	PFR7G-11	
PK 22 PR-L 11 S	PFR7G-11S	
PK 22 PRTP	PFR7M	
PKJ 16 CR 8	PZFR5F	
PKJ 16 CR-L 11	PZFR5F-11	
PKJ 16 CR-L 13	PZFR5F-13	
PKJ 20 CR 8	PZFR6F	
PKJ 20 CR-L 11	PZFR6F-11	
PKJ 20 CR-M 11	PZFR6F-11	
PQ 16 R	BCPR5EIX-11	
PQ 16 R 13	BCPR5EIX-11	
PQ 16 R 8	BCPR5EP-8	
PQ 20 R	BCPR6EP-11	
PQ 20 R 13	BCPR6EIX-11	
PQ 20 R 8	BCPR6EP-8	
PQ 20 R-P 11	BCPR6EIX-11	
PQ 20 R-P 8	BCPR6EP-N-8	
PT 16 EPR-C 13	PTR5C-13	
PT 16 EPR-L 13	PTR5D-10	
PT 16 VR 13	PTR5A-13	
PTJ 16 R 15	PZTR5A-15	
Q 14 R-U 11	BCPR4EY-11	
Q 16 PR-TP 11	BCPR5EIX-11	
Q 16 PR-U	BCPR5E	
Q 16 PR-U 11	BCPR5EY-11	



DENSO	→ NGK	Quick
Q 16 PRZ-U 11	BCPR5EIX-11	
Q 16 P-U 11	BCPR5EY-11	
Q 16 R-U	BCPR5EY	
Q 16 R-U 11	BCPR5EY-11	
Q 16 RZ-U 11	BCPR5EIX-11	
Q 16 U 11	BCPR5EY-11	
Q 16 Z-U 11	BCPR5EIX-11	
Q 20 PR-P 11	BCPR6EIX-11	
Q 20 PR-U	BKR6E	
Q 20 PR-U 11	BCPR6EY-11	
Q 20 PRU-L 11	BCPR6EY-N-11	
Q 20 PRZ-U 11	BCPR6EIX-11	
Q 20 P-U	BCP6ES	
Q 20 P-U 11	BKR6E-11	
Q 20 R-U	BCPR6EY	
Q 20 R-U 11	BCPR6EY-11	
Q 20 RZ-U 11	BCPR6EIX-11	
Q 20 U	BCP6E	
Q 20 U 11	BKR6E-11	
Q 20 Z-U 11	BCPR6EIX-11	
Q 22 PR-P 11	BKR7EIX-11	
Q 22 PR-U	BCPR7ES	
Q 22 PR-U 11	BCPR7ES-11	
Q 22 PRU-L 11	BCPR7EY-N-11	
Q 22 PRZ-U 11	BKR7EIX-11	
Q 22 P-U	BCP7ES	
Q 22 P-U 11	BKR7E-11	
Q 27 AZ	R7435-9	
QJ 16 AR-U	BCRE527Y	
QJ 16 C 11	ZFR5A-11	
QJ 16 CR 11	ZFR5A-11	
QJ 20 CR 11	ZFR6A-11	
QJ 22 CR 11	ZFR7F-11	
QL 20 PR-U	BCPR6ED	
QL 20 TRS	BCPR6EKD	
QL 22 TRS	BCPR7EKD	
RU 01-31	R0045Q-10	
RU 01-34	R0045Q-11	
S 22 PR-A 7	IGR7A	
S-29 A	SD10A	
S-31 A	SD11A	
SC 20 HR 11	ILKAR7B11	
SD 29 A	SD10A	
SF 10	BUHX	
SF 24	BU8H	
SF 50	BUHW	
SF 51	BUHW-2	
SK 16 PR-A 11	IFR5E11	
SK 16 PR-E11	IFR5E11	
SK 16 PR-E13	IFR5E13	
SK 16 PR-L 11	IFR5G-11K	
SK 16 R-P 11	BKR5EIX-11P	

DENSO	→ NGK	Quick
SK 16 R-P 8	IFR5T-8N	
SK 20 BGR 11	HB6AIX-11P	
SK 20 BR 11	HB6BIX-11P	
SK 20 HPR-L 11	ILFR6J-11K	
SK 20 HR 11	ILFR6T11	
SK 20 PR-A 11	IFR6E11	
SK 20 PR-A8	IFR6S	
SK 20 PR-L9	IFR6C	
SK 20 R 11	IFR6T11	
SK 20 R 8-G	LPG1	
SK 20 R-P 11	BKR6EIX-11P	
SK 22 PR-M 11	IFR7G-11KS	
SKJ 16 DR-M 11	IZFR5K11	
SKJ 20 DR-M 11	IZFR6K11	
SKJ 20 DR-M 11 S	IZFR6K11NS	
SKJ 20 DR-M 13	IZFR6K13	
SVK 20 RZ 11	IFR6J11	
SVK 20 RZ 8	BKR6EP-8	
SXU 22 HCR 11 S	ILZKR7B11GS	
SXU 22 HDR 8	ILKR7B8	
SXU 22 PR 9	IKR7C	
T 14 PR-U	BPR4FS	
T 14 PR-U 15	BPR4FS-15	
T 16 EPR-U	BPR5EFS	
T 16 EX-U	BP5EFS	
T 16 PR-U	BPR5FS	
T 16 PR-U 11	BPR5FS-11	
T 16 PR-U 15	BPR5FS-15	
T 16 P-U	BP5FS	
T 16 R-U	BR5FS	
T 16 RU 15	BR5FS	
T 16 U 15	YR55IX	
T 20 EPR-U	BPR6EFS	
T 20 EPR-U 15	BPR6EFS-15	
T 20 EP-U	BP6EFS	
T 20 EPU 15	BPR6EFS-15	
T 20 EX-U	BP6EFS	
T 20 MP-U	BPM6F	
T 20 M-U	BM6F	
T 20 PR-U	BPR6FS	
T 20 PR-U 15	BPR6FS	
T 20 P-U	BP6FS	
T 20 R-U	BR6FS	
T 20 R-U 15	BR6FS	
T 22 EP-U	BP7EFS	
T 22 MP-U	BPM7F	
T 22 M-U	BM7F	
TR 20	B6HS	Q203
TR 22	B7HS	Q204
TR 22-10	B7HS-10	
TR 24	B8HS	Q205
TR 24-10	B8HS-10	



DENSO	→ NGK	Quick
U 14 FSRUB	CR4HSB	
U 14 FSUB	C4HSB	
U 16 FER-9	CR5EH-9	
U 16 FSL	C5HSA	
U 16 FSRL	CR5HSA	
U 16 FSR-U	CR5HSA	
U 16 FSRUB	CR5HSB	
U 16 FS-U	C5HSA	
U 16 FSUB	C5HSB	
U 17 F	C5HSA	
U 20 EPR-9	CPR6EA-9	
U 20 ESR-N	CR6E	
U 20 FS	C6HSA	
U 20 FSL	C6HSA	
U 20 FSRL	CR6HS	Q223
U 20 FSR-U	CR6HSA	
U 20 FS-U	C6HSA	
U 20 M-U	CM-6	
U 21 FB	C6HSA	
U 22 EPR-U	CPR7EA-9	
U 22 ESN	C7E	
U 22 ESRN	CR7E	Q225
U 22 ETR	CR7EK	
U 22 FER 9	CR7EH-9	
U 22 FS	C7HSA	
U 22 FSG-U	CR7HIX	
U 22 FSL	C7HSA	
U 22 FSRL	CR7HS	
U 22 FSR-U	CR7HSA	
U 22 FS-U	C7HSA	
U 22 FSZ-U	CR7HIX	
U 24 ESN	C8E	
U 24 ESRN	CR8E	Q226
U 24 ESRNB	CR8EB	
U 24 ESRNZ-U	CR8EIX	
U 24 ETR	CR8EK	
U 24 FB	C8HSA	
U 24 FE 9	C8EH-9	
U 24 FER 9	CR8EH-9	Q228
U 24 FER 9 S	CR8EH-9S	
U 24 FERZ-U 9	CR8EHIX-9	
U 24 FS	C8HSA	
U 24 FSL	C8HSA	
U 24 FSRC	LR8A	
U 24 FSR-U	CR8HS	
U 24 FS-U	C8HSA	
U 27 ESN	C9E	
U 27 ESNZ-U	CR9EIX	
U 27 ESRN	CR9E	Q227
U 27 ESRNB	CR9EB	
U 27 ESRNZ-U	CR9EIX	
U 27 ETR	CR9EK	Q230

DENSO	→ NGK	Quick
U 27 FE 9	C9EH-9	
U 27 FER 9	CR9EH-9	Q229
U 27 FERZ-U 9	CR9EHIX-9	
U 27 FEZ-U 9	CR9EHIX-9	
U 31 ESRN	CR10E	
U 31 ETR	CR10EK	
VK 16	BKR5EIX-11P	
VK 16 J	ZFR5FIX-11P	
VK 16 PRZ 11	IFR5L11	
VK 20	IZFR6H11	
VK 20 PRZ 11	IFR6L11	
VK 20 T	LPG1	
VK 20 Y	BKR6EIX-P	
VK 22	IFR7F-6D	
VK 22 G	BKR7EIX-11PS	
VK 24 PRZ 11	IFR8H11	
VK 27 PRZ 11	IFR9H11	
VKA 20	HB6AIX-11P	
VKB 20	HB6BIX-11P	
VKH 16	ILZFR5B	
VKH 20	ILZFR6D11	
VKH 20 Y	LF6AIX-P	
VKH 22	LF7AIX-P	
VKJ 20 RZ-M 11	IZFR6F11	
VNH 27 Z	IMR9B-9H	
VQ 16	BCPR5EIX-11P	
VQ 20	BCPR6EIX-11P	
VUH 24 D	IMR8C-9H	
VUH 27 D	IMR9C-9H	
VUH 27 ES	IMR9C-9HES	
VUH 27 Z	IMR9A-9H	
VW 20 T	LPG2	
VX 22 BC	IJR7A9	
VX 22 BZ	IJR7A9	
VXU 22	DCPR7EIX-P	
W 14	B-4	
W 14 E	B4ES	
W 14 EKR-S 11	BUR4EB-11	
W 14 EP	BP4ES	
W 14 EPR	BPR4ES	
W 14 EPR 11	BPR4ES-11	
W 14 EPR-U	BPR4ES	
W 14 EP-U	BP4ES	
W 14 EXR-U	BPR4EY	
W 14 EXR-U 11	BPR4EY-11	
W 14 EXR-U 13	BPR4ES-13	
W 14 EXRZ-U	GR4IX	
W 14 EX-U	BP4EY	
W 14 EX-U 11	BP4EY-11	
W 14 EX-U 13	BPR4ES-13	
W 14 EXZ-U	GR4IX	
W 14 F	B-4H	



DENSO	→ NGK	Quick
W 14 FP	BP-4H	
W 14 FPL	BP4HS	
W 14 FPLUL	BP4HA	
W 14 FPR	BPR-4H	
W 14 FPRL	BPR4HS	
W 14 FPR-U	BPR-4H	
W 14 FPR-UL	BPR4HS	
W 14 FPR-UL 10	BPR4HS-10	
W 14 FP-U	BP-4H	
W 14 FP-UL	BP4HS	
W 14 FP-UL 10	BP4HS-10	
W 14 FRL	BR4HSA	
W 14 FR-U	BR4HS	
W 14 F-U	B-4H	
W 14 F-U 10	B-4H-10	
W 14 L	B-4L	
W 14 LMR-US	BR4-LM	
W 14 LM-U	B4-LM	Q301
W 14 LM-US	B4-LM	Q301
W 14 MPR-U 10	BPMR4A	
W 14 MP-U 10	BPM4A-10	
W 14 MR-U	BMR4A	Q306
W 14 M-U	BM4A	
W 14 M-US	BM4A	
W 14 P	BP5S	
W 14 PR-U	BP-4	
W 14 P-U	BP-4	
W 14 U	B-4	
W 14 U 10	B-4	
W 14 US	B-4	
W 16 DTRS	BPR5EKB	
W 16 EKR-S 11	BUR5EB-11	
W 16 EK-S 11	BUR5EB-11	
W 16 EP	BP5ES	
W 16 E-P 11	BP5ES-11	
W 16 EPB	BP5EY	
W 16 EPB 10	BP5ET-10	
W 16 EPG-U	BPR5EIX	
W 16 EPR	BPR5ES	
W 16 EPR 11	BPR5ES-11	
W 16 EPR-S 11	BUR5EA-11	
W 16 EPR-U	BPR5ES	
W 16 EPR-U 10	BPR5E-11	
W 16 EPR-U 11	BPR5ES-11	
W 16 EP-U	BP5ES	
W 16 EP-U 10	BP5ES-11	
W 16 EP-U 11	BP5EY-11	
W 16 EPZ-U	BPR5EIX	
W 16 ES	B5ES	
W 16 ES-L 11	BR5ES	
W 16 ESRL	BR5ES	
W 16 ESR-L 11	BUR5EB-11	

DENSO	→ NGK	Quick
W 16 ESR-U	BR5ES	
W 16 ES-U	B5ES	
W 16 ETL	BPR5EY	
W 16 ETRS	BPR5EIX-11	
W 16 ETS	BP5EK-A	
W 16 EX	BP5EY	
W 16 EXR-U	BPR5EY	
W 16 EXR-U 11	BPR5EY-11	
W 16 EXR-U 13	BPR5ES-13	
W 16 EXRZ-U	BPR5EIX	
W 16 EX-U	BP5EY	
W 16 EX-U 11	BP5EY-11	
W 16 EX-U 13	BP5ES-13	
W 16 EXZ-U	BPR5EIX	
W 16 FP	BP5HS	
W 16 FPL	BP5HA	
W 16 FPR	BPR5HS	
W 16 FPR-U	BPR5HS	
W 16 FP-U	BP5HS	
W 16 FPU 10	BP5HS-10	
W 16 FPUL	BP5HA	
W 16 FS	B5HS	
W 16 FSR	BR5HS	
W 16 FS-U	B5HS	
W 16 LS	B-6L	
W 16 PR-U	BP5S	
W 16 P-U	BP5S	
W 17	B6S	Q302
W 17 ES	BR6ES	
W 17 FP	BP6HS	
W 17 P	BP6S	
W 17 PR-U	BP6S	
W 17 P-U	BP6S	
W 20 DTRSA	BPR6EKB-L	
W 20 EAR	BR6EM	
W 20 EKR-S 11	BUR6EB-11	
W 20 EK-S 11	BUR6EB-11	
W 20 EP	B6ES	
W 20 E-P 11	BP6ES-11	
W 20 EPB	BUR6ET	
W 20 EPBR-S	BUR6ET	
W 20 EPG-U	BPR6EIX	
W 20 EPR	BPR6ES	
W 20 EPR 11	BPR6ES-11	
W 20 EPR-S 11	BUR6EA-11	
W 20 EPR-U	BPR6ES	
W 20 EPR-U 10	BPR6ES-11	
W 20 EPR-U 11	BPR6ES-11	
W 20 EPRZ-U	BPR6EIX	
W 20 EP-S 11	BUR6EA-11	
W 20 EP-U	BP6ES	
W 20 EP-U 10	BP6ES-11	



DENSO	→ NGK	Quick
W 20 EP-U 11	BP6ES-11	
W 20 EPZ-U	BPR6EIX	
W 20 ES	B6ES	
W 20 ESL	BR6ES	
W 20 ES-L 11	BUR6EB-11	
W 20 ESR	BR6ES	
W 20 ESRL	BR6ES	
W 20 ESR-L 11	BUR6EB-11	
W 20 ESR-U	BR6ES	
W 20 ES-U	B6ES	
W 20 ES-U 11	B6ES-11	
W 20 ET	BPR6EK-A	
W 20 ETL	BPR6EKN	
W 20 ETR	BPR6EK-A	
W 20 ETR-L	BPR6EKN	
W 20 ETR-L 8	BPR6EKN	
W 20 ETRS	BPR6EK-A	
W 20 ETS	BPR6EK-A	
W 20 EXR-U	BPR6EY	
W 20 EXR-U11	BPR6EY-11	
W 20 EXRZ-U	BPR6EIX	
W 20 EX-U	BP6EY	
W 20 EX-U 11	BP6EY-11	
W 20 EX-U 13	BP6ES-13	
W 20 EXZ-U	BPR6EIX	
W 20 FP	BP6HS	
W 20 FPL	BP6HSA	
W 20 FPR	BPR6HS	Q214
W 20 FPR	BPR6HS	Q214
W 20 FPR	BPR6HS	Q214
W 20 FPRL	BPR6HSA	
W 20 FPR-U	BPR6HS	Q214
W 20 FPR-U	BPR6HS	Q214
W 20 FPR-U	BPR6HS	Q214
W 20 FPR-U 10	BPR6HS-10	
W 20 FPRU-L 10	BPR6HS-10	
W 20 FP-U	BP6HS	
W 20 FP-U 10	BP6HS-10	
W 20 FRL	BR6HSA	Q210
W 20 FS	B6HS	Q203
W 20 FSG-U	BR6HIX	
W 20 FSR	BR6HS	Q209
W 20 FSR-U	BR6HS	Q209
W 20 FS-U	B6HS	Q203
W 20 FSU 10	B6HS-10	
W 20 FSZ-U	BR6HIX	
W 20 M	BM6A	Q303
W 20 MPRU 10	BPMR6A-10	
W 20 MP-U	BPM6A	Q304
W 20 MPU 10	BPM6A-10	
W 20 MR-U	BMR6A	Q307
W 20 M-U	BM6A	Q303

DENSO	→ NGK	Quick
W 20 MUS	BM6A	Q303
W 20 PR-U	BP6S	
W 20 P-U	BP6S	
W 20 S	B6S	Q302
W 20 SR-U	BR6S	
W 20 S-U	B6S	Q302
W 21 ES-L 11	BR6EB-L-11	
W 21 ESR-L 11	BR6EB-L-11	
W 22	B7S	
W 22 EA	B7EM	
W 22 EAR	BR7EM	
W 22 EB	BR7ET	
W 22 EBR	BR7ET	
W 22 EDR	BR7EQ	
W 22 EDR 14	BR7EQ-14	
W 22 EKR-S 11	BUR7EB-11	
W 22 EK-S 11	BUR7EB-11	
W 22 EP	BP7ES	Q206
W 22 E-P 11	BP7ES-11	
W 22 EPB	BP7ET	
W 22 EPG-U	BPR7EIX	
W 22 EPR	BPR7ES	
W 22 EPR 11	BPR7ES-11	
W 22 EPR-S 11	BUR7EA-11	
W 22 EPR-U	BPR7ES	
W 22 EPR-U 11	BPR7ES-11	
W 22 EPRZ-U	BPR7EIX	
W 22 EP-S 11	BUR7EA-11	
W 22 EP-U	BP7ES	Q206
W 22 EP-U 11	BP7ES-11	
W 22 EPZ-U	BPR7EIX	
W 22 ES	B7ES	
W 22 ESG-U	BR7EIX	
W 22 ESL	BR7ES	
W 22 ES-L 11	BUR7EB-11	
W 22 ESR	BR7ES	
W 22 ESRL	BR7ES	
W 22 ESR-L 11	BUR7EB-11	
W 22 ESR-U	BR7ES	
W 22 ES-U	B7ES	
W 22 ES-U 11	B7ES-11	
W 22 ESZ-U	BR7EIX	
W 22 ETL	BPR7EKN	
W 22 ETRL	BPR7EKN	
W 22 ETR-L 8	BPR7EKN	
W 22 EXR-U	BPR7EIX	
W 22 EXR-U 11	BPR7EY-11	
W 22 EX-U	BP7EY	
W 22 FP	BP7HS	
W 22 FPR	BPR7HS	Q215
W 22 FPR-U	BPR7HS	Q215
W 22 FPRZ-U	BPR7HIX	



DENSO	→ NGK	Quick
W 22 FP-U	BP7HS	
W 22 FP-U 10	BP7HS-10	
W 22 FPUS	BP7HS	
W 22 FS	B7HS	Q204
W 22 FSG-U	BR7HIX	
W 22 FSR	BR7HS	Q211
W 22 FSR-U	BR7HS	Q211
W 22 FS-U	B7HS	Q204
W 22 FSZ-U	BR7HIX	
W 22 M	BM7A	
W 22 MPR-U	BPMR7A	Q309
W 22 MP-U	BPM7A	Q305
W 22 MPUS	BPM7A	Q305
W 22 M-U	BM7A	
W 22 MUS	BM7A	
W 22 S	B7S	
W 22 S-U	B7S	
W 24	B8S	
W 24 EMRC	BR8ECM	
W 24 EP	BP8ES	
W 24 E-P 11	BP8ES	
W 24 EPR	BPR8ES	Q213
W 24 EPR-U	BPR8ES	Q213
W 24 EPRZ-U	BPR8EIX	
W 24 EP-U	BP8ES	
W 24 ES	B8ES	Q201
W 24 ESG-U	BR8EIX	
W 24 ESR	BR8ES	Q207
W 24 ESR-U	BR8ES	Q207
W 24 ESRV	BR8EG	
W 24 ESRZ-U	BR8EIX	
W 24 ES-U	B8ES	Q201
W 24 ES-U 11	B8ES	Q201
W 24 ESV	B8EG	
W 24 ESZ-U	B8EGV	
W 24 FP	BP8HS	
W 24 FPL	BPR8HSA	
W 24 FPR	BPR8HS	
W 24 FPRL	BPR8HSA	
W 24 FPR-U 10	BPR8HS-10	
W 24 FP-U	BP8HS	
W 24 FRL	BR8HSA	
W 24 FS	B8HS	Q205
W 24 FSG-U	BR8HIX	
W 24 FSR	BR8HS	Q212
W 24 FSR-U 10	BR8HS-10	
W 24 FS-U	B8HS	Q205
W 24 FS-U 10	B8HS-10	
W 24 FSZ-U	BR8HIX	
W 24 S	B8S	
W 24 S-U	B8S	
W 25 EA	BR8EM	

DENSO	→ NGK	Quick
W 25 EAR	BR8EM	
W 25 EB	BR8ET	
W 25 EBR	BR8ET	
W 25 EDR	BR8EQ	
W 25 EDR 14	BR8EQ-14	
W 25 EN	B8EG	
W 25 EPT	B8EGP	
W 25 FC	B8HCS	
W 25 FN	BR8HIX	
W 27 EBR	BR9ET	
W 27 EDR	BR9EQ-14	
W 27 EDR 14	BR9EQ-14	
W 27 EMRC	BR9ECM	
W 27 EMRZ-U	BR9ECMIX	
W 27 EN	B9EG	
W 27 EPT	BR9EIX	
W 27 ES	B9ES	Q202
W 27 ESC	B9ECS	
W 27 ESG-U	BR9EIX	
W 27 ESR	BR9ES	Q208
W 27 ESR-U	BR9ES	Q208
W 27 ESRV	BR9EG	
W 27 ESRZ-U	BR9EIX	
W 27 ES-U	B9ES	Q202
W 27 ESV	B9EG	
W 27 ESZ-U	B9EGV	
W 27 FC	B9HCS	
W 27 FN	BR9HIX	
W 27 FS	B9HS	
W 27 FSG-U	BR9HIX	
W 27 FSR	BR9HS	
W 27 FSR-U 10	BR9HS-10	
W 27 FS-U	B9HS	
W 27 FS-U 10	B9HS-10	
W 27 FSZ-U	BR9HIX	
W 29 EBR	BR10ET	
W 29 EPT	B95EGP	
W 29 ESG-U	B95EGV	
W 29 ESRV	BR10EG	
W 29 ESV	B10EG	
W 29 ESZ-U	B95EGV	
W 31 EMRC	BR10ECM	
W 31 EMRZ-U	BR10ECMIX	
W 31 EN	B10EG	
W 31 EPT	B10EGP	
W 31 ES	B10ES	
W 31 ESG-U	BR10EIX	
W 31 ESR-U	BR10ES	
W 31 ES-U	B10ES	
W 31 ESZ-U	B10EGV	
W 31 FS	B10HS	
W 31 FSG-U	BR10HIX	



DENSO	→ NGK	Quick
W 31 FSZ-U	BR10HIX	
W 32 EPT	B105EGP	
W 34 EN	B11EG	
W 34 ESZ-U	B11EGV	
W 9	B-2	
W 9 EP	BP-2E	
W 9 EPR	BPR2ES	
W 9 EXR-U	BPR2ES	
W 9 EX-U	BP-2E	
W 9 FP	BP-2H	
W 9 FPL	BP2HS	
W 9 FPLUL	BP2HS	
W 9 FPUL	BP2HS	
W 9 LMRUS	BR2-LM	Q310
W 9 LMUS	B2-LM	
W 9 P	BP-4	
W 9 PR-U	BP-4	
W 9 P-U	BP-4	
W 9 U	B-2	
WA 20 M	BM6F	
WA 20 M-U	BM6F	
WA 22 M	BM7F	
WA 22 M-U	BM7F	
X 16 EPR-U 9	DPR5EA-9	
X 16 EP-U 9	DPR5EA-9	
X 16 FSR-U	DR5HS	
X 16 FS-U	D5HS	
X 20 EPR-U 9	DPR6EA-9	
X 20 EP-U 9	DP6EA-9	
X 20 ES-U	D6EA	
X 20 FSR-U	DR6HS	
X 20 FS-U	D6HA	
X 22 EPRGL	PJR7A	
X 22 EPR-U 9	DPR7EA-9	Q220
X 22 EPRZ-U 9	DPR7EIX-9	
X 22 EP-U	DP7EA-9	
X 22 EP-U 9	DP7EA-9	
X 22 EPZ-U 9	DPR7EIX-9	
X 22 ESG-U	DR7EIX	
X 22 ESR-U	DR7ES	
X 22 ES-U	D7EA	
X 22 ESZ-U	DR7EIX	
X 22 GPR-U	DPR7Z	
X 22 GP-U	DPR7Z	
X 24 EPR-U 9	DPR7EA-9	Q220
X 24 EPRZ-U 9	DPR8EIX-9	
X 24 EP-U	DP8EA-9	
X 24 EP-U 9	DP8EA-9	
X 24 EPZ-U 9	DPR8EIX-9	
X 24 ESG-U	DR8EIX	
X 24 ESR-U	DR8ES-L	Q218
X 24 ESRZ-U	DR8EIX	

DENSO	→ NGK	Quick
X 24 ESRZ-U 9	DR8EIX	
X 24 ES-U	D8EA	Q216
X 24 ESZ-U	DR8EIX	
X 24 ESZ-U 9	DR8EIX	
X 24 FSR-U	DR8HS	
X 24 FS-U	D8HA	
X 24 GPR-U	DPR8Z	
X 24 GP-U	DP8Z	
X 27 EPR-U 9	DPR7EA-9	Q220
X 27 EPRZ-U 9	DPR9EIX-9	
X 27 EP-U 9	DP9EA-9	
X 27 EPZ-U 9	DPR9EIX-9	
X 27 ESR-U	DR8ES	Q217
X 27 ESRZ-U	DR9EIX	
X 27 ESRZ-U 9	DR9EIX	
X 27 ES-U	D9EA	
X 27 ESZ-U	DR9EIX	
X 27 ESZ-U 9	DR9EIX	
X 27 ET	J9A	
X 27 ETR	JR9B	Q224
X 27 GPR-U	DPR9Z	
X 27 GP-U	DP9Z	
X 29 ESZ-U	DR9EIX	
X 31 ES-U	D10EA	
X 31 ETR	JR10B	
XE 20 HR-U 9	LZKAR7A	
XU 20 EPR-U	DCPR6E	
XU 20 EP-U	DCP6E	
XU 22 EPR	DCPR7E	
XU 22 EPR-U	DCPR7E	
XU 22 EP-U	DCP7E	
XU 22 HDR 9	LKR7B-9	
XU 22 PR 9	DCPR7EA-9	
XU 24 EPRP	DCPR8EIX	
XU 24 EPR-U	DCPR8E	
XU 24 EPRZ-U	DCPR8EIX	
XU 24 EP-U	DCPR8E	
XU 24 EPZ-U	DCPR8EIX	
XU 27 EPR-U	DCPR9E	
XU 27 EPRZ-U	DCPR9EIX	
Y 24 FERC	ER8EH	
Y 27 FER	ER9EH	
Y 27 FERC	ER9EH	
Y 31 FERC	ER10EH	
Z 20 ES-U	D6EA	
ZC 20 HPR 11	ILKAR7L11	
ZXU 20 PR 11	IKR6G11	
ZXU 22 PR 11	IKR6G11	
DUCATI	→ NGK	Quick
670-403-51A	DCPR8E	
670-403-51B	DCPR8E	



DUCATI	→ NGK	Quick
670-403-81	MAR10A-J	
670-403-81A	MAR10A-J	
670-404-51A	MAR9A-J	
ENKER	→ NGK	Quick
F 100 C	B8HS	Q205
F 45 CP	BP4HS	
F 50 C	B5HS	
F 55 CP	BP5HS	
F 65 CP	BP6HS	
F 75 C	B6HS	Q203
F 80 C	B7HS	Q204
F 85 CP	BP7HS	
FA 50	B-4L	
FA 70	B-6L	
FE 100 C	B9ES	Q202
FE 30 C	B4ES	
FE 35 CP	BP4ES	
FE 45 CP	BP5ES	
FE 50 C	B5ES	
FE 55 CP	BP5ES	
FE 55 CPD	BP5ET	
FE 65 CP	BP6ES	
FE 65 CPD	BUR6ET	
FE 70 C	B6ES	
FE 75 C	B7ES	
FE 80 C	B8ES	Q201
FE 85 CP	BP7ES	Q206
FE 85 CPD	BP7ET	
FE 85 CPU	BP7ET	
FE 95 CP	BP8ES	
FET 65 CP	BP5EFS	
FET 75 CP	BP6EFS	
FS 20	B-2	
FS 30	B-4	
FS 50 CP	BP5S	
FS 55 CP	BP6S	
FS 70	B6S	Q302
FS 75 C	B7S	
FS 80	B8S	
FSC 50 C	BM6A	Q303
FSC 50 P	BPM6A	Q304
FSC 70 P	BPM6A	Q304
FSC 75 CP	BPM7A	Q305
FT 45 CP	BP5FS	
FT 55 CP	BP6FS	
FT 85 CP	BP7FS	
M 30	AB-2	
M 60	AB-6	
M 75	AB-7	
M 80	AB-8	

ENKER	→ NGK	Quick
MT 45 CP	AP5FS	
MT 55 CP	AP6FS	
MT 65 CP	AP7FS	
SFE 55 CP	BKR5ES	
SFE 65 CP	BKR6ES	
SFE 65 CPD	BCP6ET	
SFE 65 CPR	BPR5ES	
SFE 85 CP	BCPR7ES	
SFE 85 CPD	BCP7ET	
T 70	C6HSA	
T 90	C7HSA	
EVINRUDE	→ NGK	Quick
204 470 091	BR7ES	
278 000 237	TB05EMA	
278 000 608	BR7ES	
278 000 609	BR8ES	Q207
MCBR 10 EG	BR10EG	
MCBR 8 EG	BR8EG	
MCBR 8 HS	BR8HS	Q212
MCBR 9 EG	BR9EG	
MCBR 9 ES	BR9ES	Q208
EYQUEM	→ NGK	Quick
200	B-4H	
406	BP6HS	
700	B6HS	Q203
750	BP6HS	
755	B6HS	Q203
850	B7HS	Q204
1000	B8HS	Q205
1100	B9HS	
100 M	B8HS	Q205
1000 CM	B7S	
1000 L	B8ES	Q201
1000 M	B8HS	Q205
1100 L	B8ES	Q201
1150 L	B9ES	Q202
202 CT	B2-LM	
30 AM	B-4L	
300 AM	B-4L	
400 J	BR5FS	
450 JS	BPR4FS-15	
450 L	B5ES	
480 CS	BP5S	
50 AM	B-6L	
50 M	B5HS	
500 AM	B-6L	
500 C	B6S	Q302
500 CJT	BM6F	

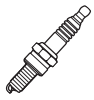

EYQUEM	→ NGK	Quick
500 CM	B6S	Q302
500 CS	BP5S	
500 CT	BM6A	Q303
500 J	BR6FS	
500 JS	BPR4FS	
500 M	B5HS	
502 CT	B4-LM	Q301
505 JS	BP5FS	
520 CS	BP5S	
550 CS	BP5S	
550 JS	BPR5FS	
550 LS	BP5ES	
550 S	BP4HS	
580 LS	BP5ES	
580 S	BP4HS	
600 CS	BP5S	
600 JS	BPR6FS	
600 L	B6ES	
600 LS	BP6ES	
600 S	BP5HS	
70 M	B6HS	Q203
700 CM	B6S	Q302
700 CTS	BPM6A	Q304
705 JS	BP7FS	
705 L	B6ES	
705 S	BP6HS	
707 LS	BP6ES	
75 LM	B6ES	
75 M	B6HS	Q203
750 L	B6ES	
750 LJS	BP6EFS	
750 LS	BP6ES	
753 LJS	BP6EFS	
755 CJT	BM7F	
755 CM	B6S	Q302
755 CT	BM7A	
755 L	B6ES	
755 LJS	BP6EFS	
755 LS	BP6ES	
755 M	B6HS	Q203
755 S	BP6HS	
775 SX	BP6HS	
775 X	B6HS	Q203
800 L	B6ES	
800 LJS	BP6EFS	
800 LS	BP6ES	
802 L	B6ES	
803 LJS	BP6EFS	
805 L	B6ES	
805 LJS	BP7EFS	
805 LJSP	TR7IX	
805 LP	BR8EIX	

EYQUEM	→ NGK	Quick
850 LS	BP7ES	Q206
883 LJP	B8EFS	
C 32	B5HS	
C 32 LS	BP5ES	
C 32 S	BP5HS	
C 42 LJS 3	BP6EFS	
C 42 S	BP6HS	
C 52 LS	BP5ES	
C 62	B7HS	Q204
C 62 LJS	BP6EFS	
C 62 LS	BP6ES	
C 62 LS 3 X	BP5ET	
C 62 S	BP7HS	
C 72 LJS	BP7EFS	
C 72 LS	BP7ES	Q206
C 72 LS 3 X	BUR6ET	
C 82 LJS	BP7EFS	
C 82 LS	BP7ES	Q206
C 82 LS 3 X	BP7ET	
C 92 LS	BP8ES	
D 1000	D8HA	
D 1000 L	D9EA	
D 1050 L	D9EA	
D 775	D6HA	
D 800 L	D7EA	
D 900 L	D8EA	Q216
FC 42 LS	BCP5ES	
FC 52 LS	BCP5ES	
FC 58 LS	BCP6ES	
FC 62 LS	BCP6ES	
FC 62 LS 2	BCP6ES	
FC 62 LS 3	BCP6ET	
FC 62 LS 3 X	BCP6ET	
FC 72 LS	BCP7ES	
FC 82 LS	BCPR7E	
FC 82 LS 1	BCP7ES	
FC 82 LS 2	BCP7ES	
FN 52 LS	BK5ESZ	
K 200 M	AB-6	
K 300 JS	AP5FS	
K 300 M	AB-6	
K 350 JS	AP5FS	
K 450 JS	AP5FS	
K 500 M	AB-6	
K 550 JS	AP6FS	
K 600 M	AB-6	
K 750 M	AB-7	
KC 62 JS	AP6FS	
R 1000	BR8HS	Q212
R 1000 L	BR8ES	Q207
R 850	BR7HS	Q211
RC 32 LS 5	BPR4ES-11	



EYQUEM	→ NGK	Quick
RC 42 S	BPR6HS	Q214
RC 42 S	BPR6HS	Q214
RC 42 S	BPR6HS	Q214
RC 52 LS	BPR5EY	
RC 52 LS 5	BPR5EY-11	
RC 52 LZ 3 EX	BUR5ET	
RC 52 LZE	ZGR5A	
RC 58 LZ 3 EX	BUR6ET	
RC 62 HJSDP	PTR5A-13	
RC 62 LJS	BPR6EFS	
RC 62 LS	BPR6ES	
RC 62 LS 5	BPR6ES-11	
RC 62 S	BPR7HS	Q215
RC 82 LS	BPR7ES	
RC 82 LS 5	BPR7EY-11	
RFC 42 LS	BKR5ES	
RFC 42 LS 2 E	BKR5EK	
RFC 42 LZ 2 E	BKR6EK	
RFC 50 LZ 2 E	BKR5EK	
RFC 52 LS	BKR5ES	
RFC 52 LS 3	BKR6ETUC	
RFC 52 LS 5	BKR5ES-11	
RFC 52 LSP	BKR6EK	
RFC 52 LZ 3 EX	BKUR5ET	
RFC 52 LZE	ZFR5F	
RFC 52 LZK	BKR5EZ	
RFC 57 LS 3	BCPR6ET	
RFC 58 LS	BKR6ES	
RFC 58 LS 2 E	BKR6EK	
RFC 58 LS 3	BCPR6ET	
RFC 58 LS 5	BKR6ES-11	
RFC 58 LSP	BKR6EZ	
RFC 58 LZ	BKR6EY	
RFC 58 LZ 2	BKR6EKC	
RFC 58 LZ 2 E	BKR6EK	
RFC 58 LZ 3 EX	BKUR6ET	
RFC 58 LZ 5	BKR6EY-11	
RFC 58 LZDP	PFR6G-9	
RFC 58 LZE 5	ZFR6F-11	
RFC 62 LS 3	BKR6ES-11	
RFC 62 LS 3 X	BCPR6ET	
RFC 62 LS 5	BKR6ES-11	
RFC 62 LZ 3 X	BKUR7ET	
RFC 82 LS	BCPR7ES	
RFC 82 LS 5	BCPR7ES-11	
RFCLZ 3 X	BKUR7ET	
RFN 52 HZ	LFR5B	
RFN 52 HZ 3 A	LFR5B	
RFN 58 HZ	LFR6B	
RFN 58 LZ	BKR6EK	
T 850	C7HSA	
XKC 62 JS	APR6FS	

HARLEY-DAVIDSON	→ NGK	Quick
3	B-6L	
4	B-6L	
5	B6S	Q302
8	B10EGV	
34	BP5S	
45	BP7HS	
10 R 12 A	DCPR8E	
4 R	B-6L	
4 R 5	BPR7HS-10	
5 A 6	BP5EY	
5 R 6	BPR5EY	
5 R 6 A	BPR5EY-11	
5 RL	ZGR5C	
6 R 12	DCPR8E	
HONDA	→ NGK	Quick
1 633 098	R0409B-10	
12260-RL6-G010	ILZKR7B11GS	
12290-P5M-A000	PZFR6F-11	
12290-P73-J001	PFR7G-11	
12290-PCX-0000	PFR7G-11S	
12290-PCX-9999-TA	PFR7G-11S	
12290-PCX-J000	PFR7G-11S	
12290-PFD-J000	IFR6C	
12290-PGE-A01	PZFR6F-11	
12290-PNA-0030	IZFR6K13	
12290-PND-A01	IZFR6K11	
12290-PND-A010-M1	IZFR6K11	
12290-PNE-0030	ZFR6K-11	
12290-PRB-A010-M1	IFR7G-11KS	
12290-R60-U010-M1	IZFR6K11NS	
12290-RB0-J01	DIFR6D13	
12290-RB0-J110-M1	DIFR6D13	
12290-RB0-JB11	DIFR6D13	
12290-RB1-0030	IZFR6K13	
12290-RB1-0031	IZFR6K13	
12290-RL6-G01	ILZKR7B11GS	
12290-RL6-G010-M1	ILZKR7B11GS	
12290-RMX-0030	ILFR6J-11K	
12290-RMX-0130	ILFR6J-11K	
12290-RSH-0030	IFR6G-11K	
12290-RW0-003	DILFR6J11	
12290-RW0-003	DILFR6J11	
30700-NX5-0031	TRS1225-B	
30717002 / 0	DR9EA	Q219
31901-NN2-0030	BR6ES	
31901-NX4-7020-M1	R7376-10	
31901-NX4-9010	R7376-10	
31908-KRN-A41	R0451B-8	
31908-KRN-A410-M1	R0451B-8	
31908-KTW-901	LMAR8A-9	
31908-KTW-9010-M1	LMAR8A-9	



HONDA	→ NGK	Quick
31908-KTW-9011-M1	LMAR8A-9	
31908-MGC-003	LMAR8A-9S	
31908-MGC-0031	LMAR8A-9S	
31908-MGC-A0000	LMAR8A-9S	
31908-ZZ3-0030	LMAR6C-9	
31908-ZZ3-A0031	LMAR6C-9	
31909-MEN-A31	SILMAR9A9S	
31909-MEN-A310-M1	SILMAR9A9S	
31909-MGC-0031	LMAR8A-9S	
31910-MEE-R110-M1	R0409B-10	
31910-MEN-A31	SILMAR10A9S	
31911-HW1-671	IMR9D-9H	
31911-HW1-6710-M1	IMR9D-9H	
31911-KRN-731	R0409B-8	
31911-KRN-7310-M1	R0409B-8	
31911-KSK-731	BR9EG-N-8	
31911-KSK-7310-M1	BR9EG-N-8	
31911-MBT-F21	IJR8B9	
31911-MBT-F210-M1	IJR8B9	
31911-MBW-E11	IMR8C-9H	
31911-MBW-E111-M1	IMR8C-9H	
31911-MBW-E112-M1	IMR8C-9H	
31911-MEE-J01	IMR8C-9HES	
31911-MEE-J010-M1	IMR8C-9HES	
31911-MEE-J011-M1	IMR8C-9HES	
31912-KRN-731	R0409B-9	
31912-MBW-E11	IMR9C-9H	
31912-MBW-E110	IMR9C-9H	
31912-MBW-E111-M1	IMR9C-9H	
31912-MBW-E112-M1	IMR9C-9H	
31912-MCW-0030	IMR9B-9H	
31912-MEE-0000	IMR9C-9H	
31912-MEE-J01	IMR8C-9HES	
31912-MEL-0030	IMR9C-9HES	
31912-MEL-A	IMR9C-9HES	
31912-MFL-0030	IMR9E-9HES	
31912-MGH-641	IMR8E-9HES	
31914-Z8Y-0030	LR4C-E	
31914-Z8Y-A0030	LR4C-E	
31915-Z0H-0030	CMR5H	
31915-Z0H-0031	CMR5H	
31916-KPH-901	CPR6EA-9	
31916-KPH-9010-M1	CPR6EA-9	
31916-KRM-841	CPR8EA-9	
31916-KRM-8410-M1	CPR8EA-9	
31916-KRM-8413-M1	CPR8EA-9	
31916-KWB-601	CPR6EA-9S	
31916-MEH-0030	SIMR8A9	
31916-Z0H-003	CMR6H	
31916-Z0H-003	CMR6H	
31916-ZY3-0030	IZFR6F11	
31916-ZY3-0032	IZFR6F11	

HONDA	→ NGK	Quick
31916-ZY3-004	IZFR6F11	
31917-KPH-901	CPR7EA-9	
31918-MEB-671	IFR8H11	
31918-MEB-6710-M1	IFR8H11	
31918-MEB-672	IFR9H11	
31919-MEB-671	IFR9H11	
31919-MEB-6710-M1	IFR9H11	
31919-MEB-672	IFR8H11	
31919-ZX2-0030	ZFR6K-11E	
3191W-Z0M-5400	BPR4ES	
3191W-Z0M-5500	BPR5ES	
3191W-Z0M-5600	BPR6ES	
31921-MBW-E12	IMR8C-9H	
31922-MBW-E12	IMR9C-9H	
31922-MEL-003	IMR9C-9HES	
31922-MFL-003	IMR9E-9HES	
31922-MOW-004	IMR9B-9H	
31926-KRM-841	CPR9EA-9	
31940-NX5-7520-M1	R7282-105	
31940-NX5-9410	R7282-105	
31988-GEV-761	ER8EH-N	
31988-GEV-7611-M1	ER8EH-N	
31999-KW6-6500	B9ECS	
89819-99010	BPR5ES	
89839-99010	BPR6ES	
94701-00408	CR9EIA-9	
98049-58716	ER8EH	
98049-59716	ER9EH	
98049-59726	ER9EH	
98049-60716	ER10EH	
98052-56471	CM-6	
98056-54718	CR4HSA	
98056-54750	C4HSB	
98056-54757	CR4HSB	
98056-54770	C4HSB	
98056-54777	CR4HSB	
98056-55713	C5HSA	
98056-55718	CR5HSA	
98056-55726	CR5HSA	
98056-55750	C5HSB	
98056-55757	CR5HSB	
98056-55770	C5HSB	
98056-55777	CR5HSB	
98056-56713	C6HSA	
98056-56713-00	C6HSA	
98056-56713-01	C6HSA	
98056-56716	CR6HS	Q223
98056-56717	C6HA	
98056-56717-00	CR6HSA	
98056-56718	CR6HSA	
98056-5671R-00	CR6HSA	
98056-56723	C6HSA	



HONDA	→ NGK	Quick
98056-56726	CR6HSA	
98056-57713	C7HSA	
98056-57713-00	C7HSA	
98056-57713-0A	C7HSA	
98056-57716	CR7HS	
98056-57718	CR7HSA	
98056-5771R-00	CR7HSA	
98056-57726	CR7HSA	
98056-57918	CR7HSA-9	
98056-58713	C8HSA	
98056-58716	CR8HS	
98056-58717	C8HA	
98056-58718	CR8HSA	
98059-55916	CR5EH-9	
98059-56916	CR6EH-9	
98059-57717	DR7ES	
98059-57817-00	CR7E	Q225
98059-57910	CR7EH-9	
98059-57916	CR7EH-9	
98059-57916-00	CR7E	Q225
98059-57926	CR7EH-9	
98059-58816	CR8E	Q226
98059-58816-H0	CR8E	Q226
98059-58817-00	CR8E	Q226
98059-58910	C8EH-9	
98059-58916	CR8EH-9	Q228
98059-58916-00	CR8E	Q226
98059-5891F	CR8EHIX-9	
98059-58920	C8EH-9	
98059-58926	CR8EH-9	Q228
98059-5892D	IMR8C-9H	
98059-589J6	CR8EH-9S	
98059-589K6	CR8EH-9S	
98059-59816	CR9E	Q227
98059-59816-H0	CR9E	Q227
98059-59910	C9EH-9	
98059-59916	CR9EH-9	Q229
98059-5991F	CR9EHIX-9	
98059-5991U	IMR9A-9H	
98059-5992U	IMR9C-9H	
98059-599U	CR9EHI-9	
98059-60916	CR10EH-9	
98061-57611	DPR7Z	
98061-57616	DPR7Z	
98061-58611	DP8Z	
98061-58616	DPR8Z	
98061-59611	DP9Z	
98061-59616	DPR9Z	
98066-54710	DR4HS	
98066-54716	DR4HS	
98066-55710	D5HS	
98066-55716	DR5HS	

HONDA	→ NGK	Quick
98066-55740	D5HS	
98066-56710	D6HA	
98066-56716	DR6HS	
98066-56717	D6HA	
98066-56726	DR6HS	
98066-58710	D8HA	
98066-58714	D8HA	
98066-58716	DR8HS	
98066-58717	D8HA	
98069-38716	DR8ES-L	Q218
98069-38719	DR8ES-L	Q218
98069-55911	DPR5EA-9	
98069-55916	DPR5EA-9	
98069-56717	D6EA	
98069-56911	DP6EA-9	
98069-56916	DPR6EA-9	
98069-5691U	IJR6A9	
98069-5697Q	DCPR6E	
98069-5697Q-HE	DCPR6EIX	
98069-57716	DR7ES	
98069-57717	D7EA	
98069-57717-00	D7EA	
98069-57717-02	D7EA	
98069-57719	DR7ES	
98069-5771P	DR7EA	
98069-5771P-00	DR7EA	
98069-5771R	DR8EA	
98069-57726	DR7EA	
98069-5777P	DR7EB	
98069-57911	DP7EA-9	
98069-57912	DPR7EIX-9	
98069-57916	DPR7EA-9	Q220
98069-57916-00	DPR7EA-9	Q220
98069-5791U	IJR7A9	
98069-57922	DPR7EIX-9	
98069-5792U	IJR7A9	
98069-5797Q	DCPR7E	
98069-58517	D8EA	Q216
98069-58716	DR8ES	Q217
98069-58717	D8EA	Q216
98069-58717-01	D8EA	Q216
98069-58719	DR8ES	Q217
98069-5871P	DR8EA	
98069-5871P-00	DR8EA	
98069-58726	DR8EA	
98069-58911	DP8EA-9	
98069-58912	DPR8EIX-9	
98069-58916	DPR8EA-9	Q221
98069-58916-03	DPR8EA-9	Q221
98069-5891F	DPR8EIX-9	
98069-58922	DPR8EIX-9	
98069-58926	DPR7EA-9	Q220



HONDA	→ NGK	Quick
98069-59717	D9EA	
98069-59726	DR8ES	Q217
98069-59911	DP9EA-9	
98069-59912	DPR9EIX-9	
98069-59916	DPR9EA-9	Q222
98069-5991F	DPR9EIX-9	
98069-59926	DPR7EA-9	Q220
98069-60717	D10EA	
98073-52710	B-2	
98073-54710	B-4	
98073-54740	BM4A	
98073-54744	BMR4A	Q306
98073-54750	BM4A	
98073-54754	BMR4A	Q306
98073-54771	BPM4A	
98073-54776	BPMR4A	
98073-54941	BPM4A-10	
98073-54944	BPMR4A-10	
98073-54951	BPM4A-10	
98073-56740	BM6A	Q303
98073-56741	BPM6A	Q304
98073-56744	BMR6A	Q307
98073-56750	BM6A	Q303
98073-56941	BPM6A-10	
98073-56944	BPMR6A-10	
98073-57944	BPMR7A	Q309
98076-52711	BP2HS	
98076-52716	BPR2HS	
98076-52717	BPR2HS	
98076-52719	BP2HS	
98076-54710	B-4H	
98076-54711	BP4HS	
98076-54713	BP4HSA	
98076-54715	BPR4HSA	
98076-54716	BR4HS	
98076-54716-00	BR4HS	
98076-54717	BPR4HS	
98076-54719	BP4HS	
98076-5471G	BR4HSA	
98076-54720	BR4HS	
98076-54746	BR4HS	
98076-54747	BPR4HS	
98076-54770	B-4H	
98076-54780	B-4H	
98076-54821-CDI	BR4HS	
98076-54911	BP4HS-10	
98076-54911-CDI	BR4HS	
98076-54914	BPR4HS-10	
98076-54917	BPR4HS-10	
98076-54919	BP4HS-10	
98076-54921	BP4HS-10	
98076-54921-CDI	BR4HS	

HONDA	→ NGK	Quick
98076-54944	BPR4HS-10	
98076-54947	BPR4HS-10	
98076-55711	BP5HS	
98076-55716	BR5HS	
98076-55717	BPR5HS	
98076-55719	BP5HS	
98076-55747	BPR5HS	
98076-56710	B6HS	Q203
98076-56711	B6HS	Q203
98076-56711-00	BP6HSA	
98076-56713	BP6HSA	
98076-56715	BPR6HSA	
98076-56716	BR6HS	Q209
98076-56717	BPR6HS	Q214
98076-56717	BPR6HS	Q214
98076-56717	BPR6HS	Q214
98076-56719	BP6HS	
98076-56719-02	BP6HS	
98076-5671G	BR6HSA	Q210
98076-5671G-00	BR6HSA	Q210
98076-5671M	B6HSA	
98076-56721	BP6HS	
98076-56725	BPR6HSA	
98076-56729	BPR6HS	Q214
98076-56729	BPR6HS	Q214
98076-56729	BPR6HS	Q214
98076-5672G	BR6HSA	Q210
98076-56740	B6HS	Q203
98076-56741	B6HS	Q203
98076-56747	BPR6HS	Q214
98076-56747	BPR6HS	Q214
98076-56747	BPR6HS	Q214
98076-56756	BPR6HS	Q214
98076-56756	BPR6HS	Q214
98076-56756	BPR6HS	Q214
98076-56917	BPR6HS-10	
98076-56927	BPR6HS-10	
98076-57710	B7HS	Q204
98076-57711	BP7HS	
98076-57716	BR7HS	Q211
98076-57717	BPR7HS	Q215
98076-57719	BP7HS	
98076-57719-01	BP7HS	
98076-57740	B7HS	Q204
98076-58710	B8HS	Q205
98076-58711	BP8HS	
98076-58713	BPR8HSA	
98076-58715	BPR8HSA	
98076-58716	BR8HS	Q212
98076-58717	BPR8HS	
98076-58719	BP8HS	
98076-5871G	BR8HSA	



HONDA	→ NGK	Quick
98076-5871G-00	BR8HSA	
98076-5871G-01	BR8HSA	
98076-5872G	BR8HSA	
98076-58740	B8HS	Q205
98076-58747	BPR8HS	
98076-59710	B9HS	
98076-59716	BR9HS	
98076-59740	B9HS	
98078-561BW	IZFR6K-11S	
98078-561CW	IZFR6K-11S	
98079-52876	BPR2ES	
98079-54148	BCPR4ES-11	
98079-5414G	ZFR4F-11	
98079-54173	BUR4EB-11	
98079-54817	BPR4ES	
98079-54841	BP4ES	
98079-54846	BPR4ES	
98079-55132	BPR5EY-11	
98079-55140	BCPR5EY-11	
98079-55141	BP5EY-11	
98079-55144	BP5ES-11	
98079-55145	BPR5ES-11	
98079-55146	BPR5EY-11	
98079-55147	BCPR5ES-11	
98079-55148	BCPR5E-11	
98079-55149	BCPR5EY-11	
98079-5514B	BCPR5E-11	
98079-5514E	BKR5E-11	
98079-5514E-H0	BKR5E-11	
98079-5514F	BCPR5EIX-11	
98079-5514G	ZFR5F-11	
98079-5514G-01	ZFR5F-11	
98079-5514H	PFR5G-11	
98079-5514J	BKR5E-N-11	
98079-5514N	PZFR5F-11	
98079-5514N-01	PZFR5F-11	
98079-5514P	ZFR5J-11	
98079-5514P-H0	ZFR5J-11	
98079-55155	BPR5E-11	
98079-55158	BCPR5E-11	
98079-5515E	BKR5E-11	
98079-5515G	ZFR6F-11	
98079-5515H	PFR5G-11	
98079-5515J	BKR5E-N-11	
98079-5515N	PZFR5F-11	
98079-5515U	IFR5L11	
98079-55173	BUR5EB-11	
98079-55174	BUR5EB-11	
98079-55176	BUR5EB-11	
98079-55178	BUR5EB-11	
98079-5517S	PFR5L-11	
98079-5517U	IFR5L11	

HONDA	→ NGK	Quick
98079-5517V	IFR5G-11K	
98079-55183	BUR5EB-11	
98079-55810	B5ES	
98079-55811	BP5ES	
98079-55816	BR5ES	
98079-55817	BPR5ES	
98079-55840	B5ES	
98079-55841	BP5ES	
98079-55841-03	BP5ES	
98079-55844	BPR5EIX	
98079-55846	BPR5ES	
98079-55847	BR5ES	
98079-55848	BR5ES	
98079-55849	BR5ES	
98079-55855	BPR5E	
98079-5585C	BKR5E	
98079-5585V	ZGR5A	
98079-55876	BPR5ES	
98079-55876-H0	BPR5ES	
98079-5587G	ZFR5F	
98079-5587V	ZGR5A	
98079-55941	BP5EY	
98079-55946	BPR5EY	
98079-55A4N	PZFR5F-13	
98079-55A5N	PZFR5F-13	
98079-56115	BPR6ES-11	
98079-5611R-00	ZFR6F-11	
98079-56132	BPR6EY-11	
98079-56140	BKR6E-11	
98079-56144	BP6ES-11	
98079-56145	BPR6ES-11	
98079-56146	BPR6EY-11	
98079-56147	BCPR6ES-11	
98079-56148	BCPR6E-11	
98079-56149	BCPR6EY-11	
98079-5614A	BCPR6EY-N-11	
98079-5614B	BKR6E-11	
98079-5614E	BKR6E-11	
98079-5614F	BCPR6EIX-11	
98079-5614G	ZFR6F-11	
98079-5614G-01	ZFR6F-11	
98079-5614H	PFR6G-11	
98079-5614J	BKR6E-N-11	
98079-5614J-01	BKR6E-N-11	
98079-5614N	PZFR6F-11	
98079-5614P	ZFR6J-11	
98079-5614P-00	ZFR6J-11	
98079-56155	BPR6ES-11	
98079-56158	BCPR6EY-11	
98079-5615E	BKR6E-11	
98079-5615F	BCPR6EIX-11	
98079-5615G	ZFR6F-11	



HONDA	→ NGK	Quick
98079-5615H	PFR6G-11	
98079-5615J	BKR6E-N-11	
98079-5615N	PZFR6F-11	
98079-5615U	IFR6L11	
98079-56173	BUR6EB-11	
98079-56174	BUR6EB-11	
98079-56175	BP6EY-11	
98079-56179	BUR6EB-11	
98079-5617S	PFR6L-11	
98079-5617T	PFR6N-11	
98079-5617U	IFR6L11	
98079-5617V	IFR6G-11K	
98079-56183	BUR6EB-11	
98079-56810	B6ES	
98079-56811	BP6ES	
98079-56817	BR6ES	
98079-56832	BPR6EY	
98079-56840	B6ES	
98079-56841	BP6ES	
98079-56844	BPR6EIX	
98079-56846	BPR6ES	
98079-56847	BR6ES	
98079-56849	BR6ES	
98079-56854	BP6ES	
98079-56855	BPR6ES	
98079-5685C	BKR6E	
98079-56871-H0	BP6ES	
98079-56876-H0	BPR6ES	
98079-56941	BP6EY	
98079-56946	BPR6EY	
98079-5695U	IFR6C	
98079-5697U	IFR6C	
98079-569BE	BKR6E-9S	
98079-569CE	BKR6E-9S	
98079-56A7H	PFR6G-13	
98079-56A7S	PFR6L-13	
98079-57144	BP7ES-11	
98079-57145	BPR7ES-11	
98079-57146	BPR7EY-11	
98079-57147	BCPR7ES-11	
98079-57148	BCPR7E-11	
98079-57149	BCPR7EY-11	
98079-5714A	BCPR7EY-N-11	
98079-5714B	BCPR7E-11	
98079-5714E	BKR7E-11	
98079-5714F	BKR7EIX-11	
98079-5714G	ZFR7F-11	
98079-5714H	PFR7G-11	
98079-5714J	BKR7E-N-11	
98079-5714P	ZFR7J-11	
98079-57155-01	BPR7ES-11	
98079-57158	BCPR7E-11	

HONDA	→ NGK	Quick
98079-5715E	BKR7E-11	
98079-5715F	BKR7EIX-11	
98079-5715G	ZFR7F-11	
98079-5715H	PFR7G-11	
98079-5715J	BKR7E-N-11	
98079-5715V	IFR7G-11KS	
98079-57171	BPR7EY-11	
98079-57173	BUR7EB-11	
98079-57174	BUR7EB-11	
98079-57175	BR6EB-L-11	
98079-57176	BR6ES	
98079-57177	BUR7EB-11	
98079-57178	BUR7EB-11	
98079-57179	BPR7EY-11	
98079-5717V	IFR7G-11KS	
98079-57183	BUR7EB-11	
98079-571BH	PFR7G-11S	
98079-571BV	IFR7G-11KS	
98079-571CH	PFR7G-11S	
98079-571CV	IFR7G-11KS	
98079-57614	BR7EIX	
98079-57810	B7ES	
98079-57811	BP7ES	Q206
98079-57811-01	BP7ES	Q206
98079-57816	BR7ES	
98079-57840	B7ES	
98079-57841	BP7ES	Q206
98079-57846	BPR7ES	
98079-57847	BR7ES	
98079-57848	BR7ES	
98079-57849	BR7ES	
98079-57855	BPR7ES	
98079-5785C	BKR7E	
98079-5785G	ZFR7F	
98079-57874	BR7EIX	
98079-57876	BR7ES	
98079-57877	BR7ES	
98079-5787G	ZFR7F	
98079-5787T	PFR7N-D	
98079-57941	BP7EY	
98079-57946	BPR7EIX	
98079-5814E	BKR8E-11	
98079-5815E	BKR8E-11	
98079-5815U	FR8BI-11	
98079-5817U	FR8BI-11	
98079-58644	BR8EIX	
98079-58646	BR8EIX	
98079-58648	B8EG	
98079-58649	BR8EG	
98079-58678	B8EG	
98079-58679	BR8EG	
98079-58810	B8ES	Q201



ISOLATOR	→ NGK	Quick
FM 14200 / 2	BP6ES	
FM 14225 / 2	BP7ES	Q206
M 14145	B5HS	
M 14175	B6HS	Q203
M 14175 / 2	B6ES	
M 14225	B7HS	Q204
M 14240	B8HS	Q205
M 14260	B9HS	
M 1495	B-4H	
M 18225	AB-7	
M 18240	AB-7	
PM 14225	BP7HS	
U 7 D	BCP6ES	
U 8 D	BCP5ES	
ZM 14-260	B8HS	Q205
ITALJET	→ NGK	Quick
94 004	BR7HS	Q211
94 015	DR8EA	
94 025	BR8HS	Q212
94 029	BR9ES	Q208
94 032	CR7E	Q225
KAWASAKI	→ NGK	Quick
E 92070-0001	CR8EB	
E 92070-0007	IZFR6F11	
E 92070-001	B7HS	Q204
E 92070-0010	R6918B-9	
E 92070-0014	CR9EIA-9	
E 92070-0015	BR8ECMIX	
E 92070-0016	BR9ECMIX	
E 92070-0019	CR8E	Q226
E 92070-0020	CPR8EB-9	
E 92070-0022	CPR7EA-9	
E 92070-0023	CR6HSA	
E 92070-0029	CPR8EA-9	
E 92070-0036	ILZKAR7B11	
E 92070-007	B6HS	Q203
E 92070-014	B6ES	
E 92070-015	B7ES	
E 92070-019	B6ES	
E 92070-036	B9HS	
E 92070-037	B8ES	Q201
E 92070-053	B8ES	Q201
E 92070-0534	B8ES	Q201
E 92070-054	B9ES	Q202
E 92070-1002	B7ES	
E 92070-1011	D8EA	Q216
E 92070-1014	BP8ES	
E 92070-1014 B	BP8ES	

KAWASAKI	→ NGK	Quick
E 92070-1019	DR8ES	Q217
E 92070-1021	BR8ES	Q207
E 92070-1024	BP6ES	
E 92070-1025	BPR6ES	
E 92070-1026	BP7ES	Q206
E 92070-1027	BPR7ES	
E 92070-1034	D9EA	
E 92070-1044	BPR8ES	Q213
E 92070-1058	B9EG	
E 92070-1063	BR9EG	
E 92070-1064	BR8EG	
E 92070-1065	DPR8EA-9	Q221
E 92070-1066	DP8EA-9	
E 92070-1067	DP9EA-9	
E 92070-1068	DPR9EA-9	Q222
E 92070-1071	C6HA	
E 92070-1107	C7HSA	
E 92070-1109	BR9ES	Q208
E 92070-1113	DR7ES	
E 92070-1114	C6HSA	
E 92070-1114 C	C6HSA	
E 92070-1116	DR8ES-L	Q218
E 92070-1124	DP7EA-9	
E 92070-1125	DPR7EA-9	Q220
E 92070-1131	C8HA	
E 92070-1133	BR10EG	
E 92070-1138	DPR6EA-9	
E 92070-1140 C	BP8ES	
E 92070-1141 C	BP7HS	
E 92070-1142	C9E	
E 92070-1143	CR9E	Q227
E 92070-1145	CR9EK	Q230
E 92070-1149	BPR8ES	Q213
E 92070-1152	BP7ES	Q206
E 92070-1152 C	BP7ES	Q206
E 92070-1153	CR6HSA	
E 92070-1154	CR7HSA	
E 92070-1155	CR8HSA	
E 92070-1157	BR9ES	Q208
E 92070-1158	CR8EK	
E 92070-1165	DR7EA	
E 92070-1167	BP5ES	
E 92070-1168	C8E	
E 92070-1168 B	C8E	
E 92070-1169	CR8E	Q226
E 92070-1169 B	CR8E	Q226
E 92070-1173	BR10ES	
E 92070-1185	R4630A-105	
E 92070-1189	DR9EA	Q219
E 92070-1197	R6252E-9	
E 92070-1199	DR8EA	
E 92070-1202 B	BP7HS	



KAWASAKI	→ NGK	Quick
E 92070-1204	R6254K-105	
E 92070-1205	R6252K-105	
E 92070-1209	CR7E	Q225
E 92070-1210	B9ES	Q202
E 92070-1213	BR9EIX	
E 92070-1218	C8HSA	
E 92070-1221	B10EG	
E 92070-1222	B8EG	
E 92070-1223	B9EG	
E 92070-1224	B9EG	
E 92070-1227	BR9EIX	
E 92070-1228	BR9EIX	
E 92070-1230	BR8EIX	
E 92070-1231	BR8EIX	
E 92070-1232	C6HSA	
E 92070-1241	R6252K-105	
E 92070-1250	DPR5EA-9	
E 92070-1253 C	B9ECS	
E 92070-1254	CR9EKPA	
E 92070-1255	CR8EKPA	
E 92070-1263	BP8HS	
E 92070-1264	CR9EK	Q230
E 92070-1266	CR9E	Q227
E 92070-1270	BR8EIX	
E 92070-1271	BR9EIX	
E 92070-2051	BM6A	Q303
E 92070-2052	BP4HS	
E 92070-2055	B2-LM	
E 92070-2056	BM4A	
E 92070-2059	BM6	
E 92070-2060	BMR6A	Q307
E 92070-2061	BPR4HS	
E 92070-2062	BR6S	
E 92070-2064	BM7	
E 92070-2066	BM7A	
E 92070-2070	BR4HS	
E 92070-2072	BMR4A	Q306
E 92070-2074	BMR7A	
E 92070-2077	BPR5ES	
E 92070-2078	BR8ES	Q207
E 92070-2086	B-2H	
E 92070-2090	B-4H	
E 92070-2097	BPR2HS	
E 92070-2098	BR4-LM	
E 92070-2100	BMR2A	
E 92070-2102	BPM7A	Q305
E 92070-2103	BMR2A-10	
E 92070-2106	BPMR4A	
E 92070-2107	BPMR7A	Q309
E 92070-2108	BPMR6A	Q308
E 92070-2109	BPM6A	Q304
E 92070-2110	BPR2ES	

KAWASAKI	→ NGK	Quick
E 92070-2112	BPR4ES	
E 92070-2115	BPMR8Y	
E 92070-2116	B6HS	Q203
E 92070-2117	BR6HS	Q209
E 92070-2118	PGR5A	
E 92070-3701	BR7ES	
E 92070-3702	BR8ES	Q207
E 92070-3707	PMR9B	
E 92070-7004 D	BPR4ES	
E 92070-S001	CR8E	Q226
E 92070-S006	CR7E	Q225
E 92070-S014	DR8EA	
E 92070-S015	BPR4HS	
E 92070-S017	BPR7HS	Q215
E 92070-S022	BPR4HS	
E 92070-Y002	CR7HSA	
E 92070-Y003	DPR7EA-9	Q220
E 9270-2077 C	BPR5ES	
J 4520 IU 0127	R0373A-9	
J 4520 IU 0131	R0373A-10	
J 4520 IU 0134	R0373A-11	
J 4520 IU 22	CR7EIX	
J 4520 IU 24	CR8EIX	
J 4520 IU 27	B8HCS	
J 4520 IUF 22	CR7HIX	
J 4520 IUF 24	CR8HIX	
J 4520 IUH 24	CR8EHIX-9	
J 4520 IUH 27	CR9EHIX-9	
J 4520 IW 0124	R7376-8	
J 4520 IW 0127	R7376-9	
J 4520 IW 0131	R7376-10	
J 4520 IW 16	BPR5EIX-11	
J 4520 IW 20	BPR6EIX-11	
J 4520 IW 22	BPR7EIX	
J 4520 IW 24	BR8EIX	
J 4520 IW 27	BR9EIX	
J 4520 IW 31	BR10EIX	
J 4520 IWF 22	BR7HIX	
J 4520 IWF 24	BR8HIX	
J 4520 IWF 27	BR9HIX	
J 4520 IX 22 B	DPR7EIX-9	
J 4520 IX 24	DR8EIX	
J 4520 IX 24 B	DPR8EIX-9	
J 4520 IX 27	DR9EIX	
J 4520 IX 27 B	DPR9EIX-9	
J 4520 IXU 0127	R2525-9	
J 4520 IXU 0131	R2525-10	
J 4520 IXU 0134	R2349-11	
J 4520 IXU 22	DCPR7EIX	
J 4520 TR 24	BR8HS	Q212
J 4520 U20 FSRU	CR6HSA	
J 4520 U22 ESRN	CR7E	Q225

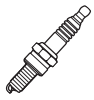

KAWASAKI	→ NGK	Quick
J 4520 U22 FSL	C7HSA	
J 4520 U22 FSRU	CR7HSA	
J 4520 U24 ESRN	CR8E	Q226
J 4520 U27 ESRN	CR9E	Q227
J 4520 U27 ETR	CR9EK	Q230
J 4520 W20 EPRU	BPR6ES	
J 4520 W20 EPU	BP6ES	
J 4520 W20 FPRU	BPR6HS	Q214
J 4520 W20 FPRU	BPR6HS	Q214
J 4520 W20 FPRU	BPR6HS	Q214
J 4520 W22 FPRU	BPR7HS	Q215
J 4520 W24 ESRU	BR8ES	Q207
J 4520 W24 FSU 10	B8HS-10	
J 4520 W27 ESRU	BR9ES	Q208
J 4520 W27 ESU	B9ES	Q202
J 4520 W31 ESRU	BR10ES	
J 4520 X20 EPRU 9	DPR6EA-9	
J 4520 X20 FSU	D6HA	
J 4520 X22 EPRU 9	DPR7EA-9	Q220
J 4520 X24 EPRU 9	DPR7EA-9	Q220
J 4520 X24 EPU 9	DP8EA-9	
J 4520 X24 ESRU	DR8EA	
J 4520 X24 ESU	D8EA	Q216
J 4520 X24 GPU	DP8Z	
J 4520 X27 EPRU 9	DPR7EA-9	Q220

KIORITZ	→ NGK	Quick
159010-00130	B6S	Q302
159010-00131	B7S	
159010-00830	BM7A	
159010-01110	BR6S	
159010-01820	B-4	
159010-03520	B5HS	
159010-03920	BP-2H	
159010-04120	B6HS	Q203
159010-04530	D5HS	
159010-10050	B-4H	
159026-00830	BM7A	
159026-12330	BPM6A	Q304
A 425213-0010	BM6A	Q303
A 425300-0210	BPM6Y	
A 425303-0010	BPM7Y	
A 425306-0310	BMR6A	Q307
A 425306-0311	BMR6A	Q307
A 425306-0400	BPMR6A	Q308
A 425306-0401	BPMR6A	Q308
A 425307-0010	BPM6A	Q304
A 425308-0010	BM6A	Q303
A 425309-0010	BPM7A	Q305
A 425309-0210	BPMR7A	Q309
A 425309-0211	BPMR7A	Q309

KIORITZ	→ NGK	Quick
A 425309-0301	BPMR7A	Q309
A 425312-0010	BPM7A	Q305
A 425314-0010	BPM8Y	

KOHLER	→ NGK	Quick
12 132 02-S	BKR5ES	
20 132 02-S	BKR5ES	
25 132 12-S	BKR5EIX	
25 132 14-S	BKR5ES	
66 132 01-S	BKR5ES	

KTM	→ NGK	Quick
452 39 093 000	LR8B	
470 39 090 000	TB05EMA	
470 39 093 000	BR10ECMIX	
503 39 093 100	BR9EIX	
515 39 093 000	BR9ECMIX	
543 31 093 210	BR10EG	
543 31 093 310	BR8EG	
543 31 093 410	BR8ECM	
590 39 090 100	VD05EG	
590 39 093 000	CR8EK	
590 39 093 100	DCPR8E	
601 39 093 000	LKAR8BI9	
610 39 093 000	DCPR8E	
611 39 093 000	KR8DI	
612 39 093 200	LKAR9BI9	
750 39 093 000	LKAR8AI-9	
770 39 093 000	CR9EKB	
772 39 093 000	LMAR9AI-8	
778 39 093 000	LMAR9AI-10	
780 39 093 000	LKAR8A-9	

MAGNETI MARELLI	→ NGK	Quick
061 830 072 304	BCPR7ES	
061 830 085 304	BPR7ES	
061 830 086 304	BKR6E	
061 830 175 304	BP7ES	Q206
061 830 176 304	BP6HS	
061 830 210 304	BP6ES	
061 830 211 304	BPR6ES	
061 830 215 304	BP6EFS	
061 830 254 304	BKR6E	
061 830 257 304	BPR6HS	Q214
061 830 257 304	BPR6HS	Q214
061 830 257 304	BPR6HS	Q214
061 830 258 304	BP5HS	
061 830 262 304	BPR6EFS	
061 830 263 304	BPR7EFS	
061 850 023 304	PTR5A-13	



MAGNETI MARELLI → NGK		Quick
062 000 611 304	B6HS	Q203
062 000 654 304	BP6HS	
062 000 739 304	BP6ES	
062 000 740 304	BPR6ES	
062 000 754 304	BP6HS	
7 LCR	BKR6E	
7 LPR	BKR6E	
8 LCR	BCPR7ES	
8 LDCR	PTR5A-13	
8 LPR	BCPR7ES	
AW 5 C	BM6A	Q303
AW 56 C	BM7A	
CM 1 N	AB-2	
CM 2 N	AB-2	
CM 3 N	AB-6	
CM 4 N	AB-6	
CM 5 N	AB-6	
CM 6 N	AB-7	
CU 7 N	C7HSA	
CW 10 L	B8EG	
CW 101 L	B85EGV	
CW 11 L	B9EG	
CW 112 L	B9EG	
CW 12 L	B9EG	
CW 12 NV	BUH	
CW 13 L	B10EG	
CW 14 L	B10EG	
CW 2 C	B-2	
CW 2 CJ	B-2	
CW 2 L	B4ES	
CW 2 N	B-4H	
CW 225 A	B6HS	Q203
CW 25 N	B-4H	
CW 250 A	B7HS	Q204
CW 260 N	B7HS	Q204
CW 3 C	B-4	
CW 3 CJ	B-4	
CW 3 CP	BP-4	
CW 3 L	B4ES	
CW 3 N	B-4H	
CW 4 A	B5ES	
CW 4 C	B-4	
CW 4 CJ	B-4	
CW 4 CP	BP-4	
CW 4 L	B4ES	
CW 4 LP	BP4ES	
CW 4 N	B-4H	
CW 4 NJ	B-4H	
CW 5 C	B-4	
CW 5 CP	BP5S	
CW 5 L	B5ES	
CW 5 LJ	B5ES	

MAGNETI MARELLI → NGK		Quick
CW 5 LP	BP5ES	
CW 5 LS	B5ES	
CW 5 LSZ	B5ES	
CW 5 N	B5HS	
CW 5 NJ	B5HS	
CW 5 NP	BP5HS	
CW 5 NR	BR5HS	
CW 5 NS	B5HS	
CW 5 NSZ	B5HS	
CW 55 N	B5HS	
CW 6 C	B6S	Q302
CW 6 CE	BM6A	Q303
CW 6 CJ	B6S	Q302
CW 6 L	B5ES	
CW 6 LJ	B5ES	
CW 6 LP	BP5ES	
CW 6 LR	BR5ES	
CW 6 LS	B5ES	
CW 6 LSZ	B5ES	
CW 6 N	B6HS	Q203
CW 6 NE	BM6A	Q303
CW 6 NJ	B6HS	Q203
CW 6 NP	BP6HS	
CW 6 NPR	BPR6HS	Q214
CW 6 NPR	BPR6HS	Q214
CW 6 NPR	BPR6HS	Q214
CW 6 NR	BR6HS	Q209
CW 67 L	B6ES	
CW 67 LP	BP6ES	
CW 67 N	BP6HS	
CW 67 NJ	B6HS	Q203
CW 67 NR	BR6HS	Q209
CW 67 P	BP5ES	
CW 7 C	B6S	Q302
CW 7 L	B6ES	
CW 7 LCR	BKR6E	
CW 7 LJ	B6ES	
CW 7 LP	BP6ES	
CW 7 LPH	BP6ES	
CW 7 LPR	BPR6ES	
CW 7 LR	BR6ES	
CW 7 N	B6HS	Q203
CW 7 NJ	B6HS	Q203
CW 7 NP	BP6HS	
CW 7 NPR	BPR6HS	Q214
CW 7 NPR	BPR6HS	Q214
CW 7 NPR	BPR6HS	Q214
CW 7 NR	BR6HS	Q209
CW 75 LP	BP6ES	
CW 78 L	B6ES	
CW 78 LP	BP6ES	
CW 78 LPR	BPR6ES	



MAGNETI MARELLI → NGK		Quick
CW 78 LPS	BP6ES	
CW 8 CJ	B7S	
CW 8 L	B7ES	
CW 8 LCR	BCPR7ES	
CW 8 LJ	B7ES	
CW 8 LP	BP7ES	Q206
CW 8 LPR	BPR7ES	
CW 8 LPS	BP7ES	Q206
CW 8 N	B7HS	Q204
CW 8 NP	BP7HS	
CW 8 NR	BR7HS	Q211
CW 89 LP	BP7ES	Q206
CW 9 L	B8ES	Q201
CW 9 LJ	B8ES	Q201
CW 9 LP	BP8ES	
CW 9 N	B8HS	Q205
CWC 12 NJ	B8HS	Q205
CWC 6 NJ	B6HS	Q203
CWC 67 NJ	B6HS	Q203
CWC 7 NJ	B6HS	Q203
CWC 9 NJ	B7HS	Q204
CWF 11 L	BR8EIX	
CWP 10 L	BR9EIX	
CWP 10 N	BR9HIX	
CWP 11 L	B10EGV	
CWP 5 N	BR6HIX	
CWP 6 N	BR6HIX	
CWP 7 L	B6EVX	
CWP 7 N	BR6HIX	
CWP 8 L	BR7EIX	
CWP 8 N	BR7HIX	
CWP 9 L	BR8EIX	
CWP 9 N	BR8HIX	
CX 6 N	D6HA	
CX 8 L	D8EA	Q216
CX 8 N	D8HA	
DW 4 CJR	BR6S	
F 6 NC	BP5HS	
F 6 NCR	BPR5HS	
F 7 LC	BP6ES	
F 7 LCR	BPR6ES	
F 7 NC	BP6HS	
F 7 NCR	BPR6HS	Q214
F 7 NCR	BPR6HS	Q214
F 7 NCR	BPR6HS	Q214
F 8 LC	BP7ES	Q206
F 8 LCR	BPR7ES	
FC 6 N	B5HS	
FC 7 N	B6HS	Q203
FC 9 L	BP8ES	
SW 5 C	BM6F	
T 7 LC	BP6EFS	

MAGNETI MARELLI → NGK		Quick
T 7 LCR	BPR6EFS	
T 8 LC	BP7EFS	
T 8 LCR	BPR7EFS	
TM 2 NP	AP5FS	
TM 3 N	A5FS	
TM 3 NP	A5FS	
TM 4 N	A5FS	
TM 4 NP	AP6FS	
TW 4 LP	BP5EFS	
TW 5 NP	BP5FS	
TW 6 NP	BP6FS	
TW 7 LP	BP6EFS	
TW 7 LPR	BPR6EFS	
TW 7 NP	BP6FS	
TW 78 LP	BP6EFS	
TW 78 LPR	BPR6EFS	
TW 78 NPR	BPR6FS	
MARCHAL / VALEO → NGK		Quick
35	B6HS	Q203
36	B5HS	
11 720	B8HS	Q205
12 086	B8HS	Q205
17 C	AB-7	
19 C	AB-7	
19 E	AB-7	
19 L	AB-7	
2 / 32 H	B8ES	Q201
2 / 33 H	B7ES	
20 C	AB-6	
20 E	AB-6	
20 L	AB-6	
21 C	AB-6	
21 E	AB-6	
21 L	AB-6	
22 L	AB-2	
22 LM	AB-2	
23 F	A6FS	
32 LM	AB-2	
34 / 5 HS	BP6ES	
34 C	B7S	
34 CM	B7S	
34 HS	B7ES	
34 HSM	B7ES	
34 S	B7HS	Q204
35 / 1	BP6HS	
35 / 1 B	BP6HS	
35 / 1 D	BP6HS	
35 / 36 D	B6HS	Q203
35 / 36 P	B6HS	Q203
35 / 36 R	B6HS	Q203



MARCHAL / VALEO → NGK		Quick
35 B	B6HS	Q203
35 C	B6S	Q302
35 CM	B6S	Q302
35 HA	BP6ES	
35 HS	B6ES	
35 M	B6HS	Q203
35 P	B6HS	Q203
36 B	B5HS	
36 C	B-4	
36 CM	B-4	
36 D	B5HS	
36 HS	B5ES	
36 M	B5HS	
36 P	B5HS	
37 S	B5HS	
4 N	B7HS	Q204
41 306	AB-8	
5 H	B7ES	
5 N	BP6HS	
5 NCYCLO	BP6HS	
6 H	BP7ES	Q206
6 N	BP5HS	
64 H	BP7ES	Q206
67 HP	BR8EIX	
7 H	BP6ES	
70 H	BP6ES	
76 H	BP5ES	
8 H	BP6ES	
84 H	BP5ES	
88 N	B5HS	
9 H	BP5ES	
C 64 H	BP6EFS	
C 68 H	BP6EFS	
C 7 H	BP6EFS	
F 70 H	BCP7ES	
F 74 H	BCP6ES	
F 80 H	BCP7ES	
GT 34	BP7HS	
GT 34 / 2 H	BP6ES	
GT 34 / 5	BP6HS	
GT 34 / 5 D	BP6HS	
GT 34 / 5 H	BP6ES	
GT 34 / 5 HA	BP6ES	
GT 34 / 5 HD	BP6ES	
GT 34 D	BP7HS	
GT 34 H	BP7ES	Q206
GT 34 HD	BP6ES	
GT 35	BP5HS	
GT 35 D	BP5HS	
GT 35 H	BP5ES	
GT 35 HD	BP5ES	
H 32 RG	B9EG	

MARCHAL / VALEO → NGK		Quick
H 33 RG	B8EG	
H 34 F	B8ES	Q201
HA 32 / 2	B8ES	Q201
HA 32 RS	B9EG	
HF 34	B7ES	
HF 34 F	B8ES	Q201
RR 31 HS	B10EG	
RR 32 HS	B9EGV	
RR 33 HSS	B8EGV	
SCGT 34 / 5H	BP6EFS	
SCGT 35 H	BP6EFS	
V 36 A	B5HS	
V 6 NSOLEX	B5HS	
MBK	→ NGK	Quick
9079Q-04155 00	B6HS	Q203
9079Q-04156 00	B7HS	Q204
9079Q-04157 00	B8HS	Q205
9079Q-04158 00	B7ES	
9079Q-04159 00	B8ES	Q201
9079Q-04160 00	B9ES	Q202
9079Q-04161 00	BPR6HS	Q214
9079Q-04161 00	BPR6HS	Q214
9079Q-04161 00	BPR6HS	Q214
9079Q-04162 00	BPR7HS	Q215
9079Q-04163 00	BR7HS	Q211
9079Q-04164 00	BR9ES	Q208
9079Q-04913 00	B9HS	
9079Q-05072 00	BR8HS	Q212
9079Q-05790 00	BR8ES	Q207
9079Q-05791 00	BR9HS	
9079Q-05792 00	CR7E	Q225
9079Q-05793 00	CR8E	Q226
9079Q-30501 00	CPR9EA-9	
94702-00372 1	CR6HSB	
MOTO GUZZI	→ NGK	Quick
887 016	LMAR8F-9	
MV AGUSTA	→ NGK	Quick
800 99561	CR9EKB	
8000 B7884	CR9EIB-9	
PIAGGIO	→ NGK	Quick
638 852	CR7EB	
638 853	CR8EB	
639 687	CR8EKB	
641 387	ER9EH-6N	
828 209	CR9EB	
829 981	CR7EKB	



PIAGGIO	→ NGK	Quick
847 085	B8ES	Q201
861 612	BR8ES	Q207
887 016	LMAR8F-9	
896 472	PMR9B	
AP 0297 542	DR8EA	
AP 0297 547	DR8EB	
AP 0297 830	BR10EG	
AP 0297 942	DCPR9E	
AP 2BEN 000088	BPR7HS	Q215
AP 2BEN 000276	CPR8E	
AP 2BEN 000319	ZMR7AP	
AP 8176 075	BPR4HS	
AP 8206 870	BR7HS	Q211
AP 8206 871	BR8HS	Q212
AP 8206 915	BR9ES	Q208
AP 8520 007	CR7E	Q225
AP 8600 008	BR9ECM	

POLARIS	→ NGK	Quick
0451967	PFR7G-9	
3 021 559	BPR4EY	
3 021 671	BKR7E	
3 022 082	BPR9ES	
3 022 332	GR9A-EG	
3 022 559	CPR8E	
3 070 156	BR8ES	Q207
3 070 163	BR9ES	Q208
3 070 165	BR9ES	Q208
3 070 166	BR8ES	Q207
3 070 167	BPR8ES	Q213
3 070 172	BKR5E	
3 070 172	BKR6E	
3 070 175	BKR5E	
3 070 185	BR6ES	
3 070 190	BR10EG	

PSA	→ NGK	Quick
11 737 027 00	BPR5HS	
16 075 776 80	DILFR5A11	
5960.14	LFR5B	
5960.81	PLFR5A-11	
5960.92	PLZKBR7B8DG	Q216
5960.93	PLZKBR7B8DG	Q216
5960.A5	PLZKBR7B8DG	Q216
5960.C2	FR5EI	
5960.C3	FR5EI	
5960.E1	PLZKBR7B8DG	Q216
5960.E2	PLZKBR7B8DG	Q216
5960.F3	LFR6B	
5960.G4	PLZKBR7B8DG	Q216
5960.H9	PLZKBR7B8DG	Q216

PSA	→ NGK	Quick
5960.L0	PLZKBR7B8DG	Q216
5960.L5	ILZKBR7B8DG	
5962.00	BCP6ES	
5962.05	BP6EFS	
5962.09	BP6EFS	
5962.13	BP6ES	
5962.14	BP6EFS	
5962.15	BP6EFS	
5962.16	BP6ES	
5962.21	BUR6ET	
5962.22	BPR6EIX	
5962.2A	BPR6ES	
5962.2T	BKR6EKC	
5962.2X	BKR6ES	
5962.5G	BKR6EZ	
5962.71	BKR6ES	
5962.72	BP6EFS	
5962.7S	BKR6EZ	
5962.7W	LFR6B	
5962.7Y	LFR6B	
5962.80	BP6HS	
5962.82	BP6ES	
5962.87	BP6EFS	
5962.88	BP8ES	
5962.90	BP6HS	
5962.94	BP7ES	Q206
5962.98	BP7ES	Q206
5962.A1	BP7ES	Q206
5962.A2	BP6ES	
5962.A3	BP6HS	
5962.A5	PLZKBR7B8DG	Q216
5962.A0	BP7ES	Q206
5962.C5	BKR6ES	
5962.C6	BKR6ES	
5962.C0	BP5EFS	
5962.F7	BCP6ES	
5962.F8	BCP6ES	
5962.G8	BP7ES	Q206
5962.H2	BKR6ES	
5962.H8	BKR5ES	
5962.H9	BKR5ES	
5962.IA	BP5ET	
5962.IK	BKR6EK	
5962.IL	BKR5EK	
5962.J9	BKR6ES	
5962.J0	BCP6ES	
5962.K1	BCPR7ES	
5962.K3	BCP7ET	
5962.K4	BKR6ES	
5962.K6	BKR6ES	
5962.K7	BCPR6ET	
5962.K0	BCPR7ES	



PSA	→ NGK	Quick
5962.OE	BKR6EK	
5962.R5	BCPR6ET	
5962.R9	BKR6ES	
5962.S2	BKR6ES	
5962.S4	BKR5ES	
5962.S7	BP5ES	
5962.T8	BKR6ES	
5962.T0	BKR6ES	
5962.V6	BKR5ES	
5962.V7	BKR6ES	
5962.V8	BCPR7ES	
5962.W1	BKR5ES	
5962.W4	BCPR6ET	
5962.W6	BCPR7ES	
5962.W7	BCPR7ES	
5962.W9	BKR5EK	
5962.X5	BCP6ES	
5962.X8	BCP6ES	
5962.Y2	BKR5EK	
5962.Y8	BKR6EK	
5962.Z1	BKR6EK	
5962.Z6	BKR5EK	
5962.Z0	BKR6EK	
7267.52	BR6HSA	Q210
7343.71	BR8HS	Q212
7355.92	BPR6HS	Q214
7355.92	BPR6HS	Q214
7355.92	BPR6HS	Q214
7369.54	BR7HS	Q211
7369.75	BR7ES	
7370.27	BPR5HS	
7381.55	BR8ES	Q207
7423.80	CR7E	Q225
7443.61	CPR8E	
7461.74	CR7EB	
7540.50	BR9ES	Q208
7567.56	DPR7EA-9	Q220
7567.57	B6HS	Q203
7567.58	BP5HS	
7567.59	B7HS	Q204
7567.60	B8HS	Q205
7567.61	BP6HS	
7567.62	B9ES	Q202
7567.63	B9HS	
7567.66	B8ES	Q201
7567.67	CPR8EB-9	
7567.68	BR9HS	
7567.70	B6ES	
7581.44	CR7HSA	
7598.74	CR7EKB	
7604.64	BPR7ES	
7616.05	CR9EB	

PSA	→ NGK	Quick
7664.20	CR7EKA	
7682.28	CR8EKB	
7696.18	CR8EB	
95 496 692	BP6HS	
95 605 398	B6HS	Q203
95 611 941	BP6EFS	
95 619 043	BP6ES	
96 000 090	BCP5ES	
96 037 952	BCP5ES	
96 039 962	BCP6ET	
96 064 890	BKR5ES	
96 097 486	BCP7ET	
96 145 071	BCPR6ET	
96 762 881 80	LZKR6AI-10G	
97 533 994	BP7EFS	
AM 212 207 A	B6HS	Q203
MKP 00073	BP7ES	Q206
V7 534 226 80	PLZKBR7B8DG	Q216
V7 534 226 80-03	PLZKBR7B8DG	Q216
V7 570 106 80	ILZKBR7B8DG	
ZC 986 209 0U	BP5ES	
ZCT 000 011	BP6HS	
ZCT 000 012	BP7ES	Q206

SPLITFIRE	→ NGK	Quick
SF 406 B	B9EGV	
SF 413 B	D9EA	
SF 419 D	C6HSA	
SF 426 C	BPR6ES	
TP 006 A	BPR8EIX	
TP 006 B	BPR7EIX	
TP 006 C	BPR6EIX	
TP 006 D	BPR5EIX	
TP 006 E	BPR5EIX	
TP 406 B	BR9EIX	
TP 406 C	BR8EIX	
TP 416 B	DPR9EIX-9	
TP 416 C	DPR8EIX-9	
TP 430 B	CR9EIX	
TP 430 C	CR8EIX	

SUZUKI	→ NGK	Quick
09482-00006	B-4	
09482-00011	B-4H	
09482-00036	BP-4H	
09482-00051	B6S	Q302
09482-00053	B7S	
09482-00054	B6ES	
09482-00056	B8ES	Q201
09482-00059	BP6HS	



SUZUKI	→ NGK	Quick
09482-00060	BP7HS	
09482-00064	BR6HIX	
09482-00065	BR7HIX	
09482-00066	B9ES	Q202
09482-00074	BP6HS	
09482-00079	BR6ES	
09482-00082	B7HS	Q204
09482-00083	B7HS	Q204
09482-00084	BP6HS	
09482-00088	BR6HS	Q209
09482-00089	B7ES	
09482-00091	B8ES	Q201
09482-00095	B6HS	Q203
09482-00096	BR8EIX	
09482-00097	BR9EIX	
09482-00098	BR9ES	Q208
09482-00102	BR8HS	Q212
09482-00105	BP7HS	
09482-00114	BR8EIX	
09482-00115	BR9EIX	
09482-00116	BR7HS	Q211
09482-00117	BR7ES	
09482-00118	BP6ES	
09482-00120	BP5HS	
09482-00121	BR8ES	Q207
09482-00123	BP5EY	
09482-00124	BP5HS	
09482-00125	BPR-4H	
09482-00127	BR9ES	Q208
09482-00128	B6ES	
09482-00129	BP4EY	
09482-00130	BP4EY	
09482-00131	BP5ES	
09482-00136	BPR-4H	
09482-00139	BP7ES	Q206
09482-00141	BPR6HS	Q214
09482-00141	BPR6HS	Q214
09482-00141	BPR6HS	Q214
09482-00142	B-4H	
09482-00143	BR5HS	
09482-00144	D8EA	Q216
09482-00145	D8EA	Q216
09482-00147	BPR5HS	
09482-00149	DR8ES-L	Q218
09482-00151	B8HS	Q205
09482-00153	B7HS	Q204
09482-00155	BPR5ES	
09482-00157	BR8HS	Q212
09482-00159	BPR4EY	
09482-00161	BP4HS	
09482-00163	BP5HA	
09482-00167-000	BPR5EY	

SUZUKI	→ NGK	Quick
09482-00167-001	BPR5ES	
09482-00170	BP4HA	
09482-00171	BP4HS	
09482-00172	BP2HS	
09482-00175	BP8ES	
09482-00177	BP6ES	
09482-00182	D7EA	
09482-00183	D7EA	
09482-00184	D9EA	
09482-00185	D9EA	
09482-00186	BP-4H	
09482-00188	BP6HS	
09482-00189	BP7HS	
09482-00190	B6HS	Q203
09482-00191	B7HS	Q204
09482-00192	B8HS	Q205
09482-00195	B7ES	
09482-00196	B8ES	Q201
09482-00198	B8HS	Q205
09482-00205	BPR4HS	
09482-00206	BPR4HS	
09482-00208	B8EGV	
09482-00209	B9EGV	
09482-00210	B10EGV	
09482-00216	BP4EY-11	
09482-00217	BP5EY-11	
09482-00218	BP4EY-11	
09482-00219	BP5EY-11	
09482-00220	DR7ES	
09482-00221	DR8ES	Q217
09482-00222	DR7EA	
09482-00223	DR8EA	
09482-00225	B8ES	Q201
09482-00226	BP7ES	Q206
09482-00227	CM-6	
09482-00228	BP5HS	
09482-00229	BPR6HS	Q214
09482-00229	BPR6HS	Q214
09482-00229	BPR6HS	Q214
09482-00230	BR8HS	Q212
09482-00233-111	BR9ES	Q208
09482-00234	DR9EA	Q219
09482-00237	B8HS	Q205
09482-00239	BPR8ES	Q213
09482-00240-111	BPR8ES	Q213
09482-00244-111	BPR7HS	Q215
09482-00247-111	BR8ES	Q207
09482-00255	BPR7HS	Q215
09482-00258	BPMR6A	Q308
09482-00259	BP6HS	
09482-00260	BPM4A	
09482-00261	BPMR4A	



SUZUKI	→ NGK	Quick
09482-00262	BP5HS-10	
09482-00263	BP5HS-10	
09482-00264	BP6HS-10	
09482-00265	BP6HS-10	
09482-00268	BP8HS	
09482-00269	B7HS-10	
09482-00277	BR7HS-10	
09482-00278	B8HS-10	
09482-00279	B8HS-10	
09482-00280	BR8HS-10	
09482-00281	BPR6HS	Q214
09482-00281	BPR6HS	Q214
09482-00281	BPR6HS	Q214
09482-00282	B5HS	
09482-00284	BP6EY-11	
09482-00285	BPR6ES-11	
09482-00286	BPR6EY-11	
09482-00287	BP5ES-11	
09482-00288	BP4ES	
09482-00289	B-4H	
09482-00290	BP-4H	
09482-00291	BP4HS	
09482-00294	C6HA	
09482-00295	C6HSA	
09482-00299	BPR6ES	
09482-00302-111	BPR6HS	Q214
09482-00302-111	BPR6HS	Q214
09482-00302-111	BPR6HS	Q214
09482-00303	BP6EY-11	
09482-00305	BP5HS	
09482-00306	BPR6HS	Q214
09482-00306	BPR6HS	Q214
09482-00306	BPR6HS	Q214
09482-00308	BR5HS	
09482-00309	B5HS	
09482-00312	BPR5EY-11	
09482-00314	CR7HSA	
09482-00316	BPR5HS	
09482-00317	C8HA	
09482-00320-111	CR8HSA	
09482-00321	C8HSA	
09482-00322	BPR5EIX	
09482-00325	BR8EIX	
09482-00327	BR6HS-10	
09482-00328	DP9EA-9	
09482-00330	DPR9EA-9	Q222
09482-00331-111	DPR7EA-9	Q220
09482-00332	DP8EA-9	
09482-00333-111	DP8EA-9	
09482-00334	DPR8EA-9	Q221
09482-00335-111	DPR7EA-9	Q220
09482-00338	B6HS-10	

SUZUKI	→ NGK	Quick
09482-00339	B6HS-10	
09482-00340	CR6HS	Q223
09482-00341	BR6HS-10	
09482-00348	BR8ES	Q207
09482-00349	BR9ES	Q208
09482-00351	B9ES	Q202
09482-00352	DP7EA-9	
09482-00354	DPR7EA-9	Q220
09482-00355-111	DPR7EA-9	Q220
09482-00358	BR4HS	
09482-00359	BPR5HS	
09482-00360	BR10ES	
09482-00362	ZGR5A	
09482-00363	BPR5EY	
09482-00365	J9A	
09482-00366	JR9B	Q224
09482-00367	BPR4HS	
09482-00368	DCP7E	
09482-00369	DCP7E	
09482-00370	BR8HS-10	
09482-00371	J10A	
09482-00372	JR10B	
09482-00375	B8HS-10	
09482-00376	B8HS	Q205
09482-00378	DCPR8E	
09482-00379	DCPR8E	
09482-00381	PJR7A	
09482-00383	DCPR8EIX	
09482-00384	DCPR8EIX	
09482-00385	BP7ES	Q206
09482-00388	JR9B	Q224
09482-00389	JR9B	Q224
09482-00390	JR10B	
09482-00391	JR10B	
09482-00392	BP6ES	
09482-00393	DCP6E	
09482-00394	DCP6E	
09482-00395	ZG5E	
09482-00397	JR9C	
09482-00398	DR7EA	
09482-00399	DR8EA	
09482-00400	DR9EA	Q219
09482-00401	JR8C	
09482-00404	LR8A	
09482-00406	CR6HSA	
09482-00407	CR6HSA	
09482-00408	CR7HSA	
09482-00409	BPR6ES	
09482-00410	CR9EK	Q230
09482-00411	CR9EK	Q230
09482-00412	CR8EK	
09482-00413	CR8EK	



SUZUKI	→ NGK	Quick
09482-00414	CR7EK	
09482-00416-111	BPR5HS	
09482-00420-111	BPR-4H	
09482-00421	BPR6ES-11	
09482-00423	R5184-10	
09482-00424	R5184-105	
09482-00426	BK6E	
09482-00427	BKR6E	
09482-00429	BKR6E	
09482-00430	R0373A-10	
09482-00431	R0373A-11	
09482-00432	BPR5E	
09482-00433	BPR5EY-11	
09482-00434	BP7ES	Q206
09482-00446	DCPR6E	
09482-00447	DCPR6E	
09482-00448	DCPR7E	
09482-00449	DCPR7E	
09482-00450	DCPR8E	
09482-00452	ZGR5A	
09482-00456	CR8E	Q226
09482-00457	CR8E	Q226
09482-00458	CR9E	Q227
09482-00459	CR9E	Q227
09482-00460	CR10E	
09482-00461	CR10E	
09482-00462	CR10EK	
09482-00463	CR10EK	
09482-00464	BR8HCS-10	
09482-00467	BR9HS-10	
09482-00468	BPR5E	
09482-00470	BR8ECM	
09482-00472	BR9ECM	
09482-00473	BR9ECM	
09482-00474	BR10ECM	
09482-00476	BKR5E	
09482-00477	BKR5E	
09482-00478	B10ES	
09482-00481	DCPR8EIX	
09482-00484	DCPR8EIX	
09482-00485	CR8HSA	
09482-00486	BR8HCS-10	
09482-00487	BPR6ES	
09482-00488	DCPR7E	
09482-00491	JR8B	
09482-00493	BPR5E-11	
09482-00494	BKR6E-11	
09482-00495	BPR7ES	
09482-00496	BPR5E-11	
09482-00497	BKR5E-11	
09482-00498	BPR7ES	
09482-00499	R4118S-8	

SUZUKI	→ NGK	Quick
09482-00500	R4118S-9	
09482-00501	BPR6EY	
09482-00502	BP5EY	
09482-00504	BPR5EY	
09482-00508	BKR6E-11	
09482-00509	R6918B-8	
09482-00511	R6918B-7	
09482-00513	R0045J-10	
09482-00514	R0045J-11	
09482-00515	CR7E	Q225
09482-00516	CR7E	Q225
09482-00519	BR9EYA	
09482-00521	PGR5A	
09482-00522	BPR7HS-10	
09482-00523	BPR8HS	
09482-00525	IKR7A	
09482-00526	BR10EYA	
09482-00527	KR7AI	
09482-00528	CR6E	
09482-00530	BPR6HS	Q214
09482-00530	BPR6HS	Q214
09482-00530	BPR6HS	Q214
09482-00531	BP6HS	
09482-00532	B7HS-10	
09482-00533	BR7HS-10	
09482-00534	B6HS-10	
09482-00535	BR6HS-10	
09482-00537	DCPR9EIX	
09482-00540	PFR5G-11	
09482-00546	GR5AI-10	
09482-00547	IFR5E11	
09482-00548	IFR6E11	
09482-00549	IFR5J11	
09482-00550	IFR6J11	
09482-00556	CR8EIA-9	
09482-00557	CR9EIA-9	
09482-00558	CR9EIA-9	
09482-00561	BR8EG	
09482-00562	IFR5E11	
09482-00564	BR9EYA	
09482-00565	KR8AI	
09482-00566	BKR5E-11	
09482-00570	CR8EB	
09482-00581	CR8EKB	
09482-00582	CR9EKB	
09482-00584	CR8EIB-10	
09482-00597	CR8EIA-10	
09482-00600-000	DIMR8A10	
09482-00602	IKR6G11	
09482-00603	IKR6G11	
09482-00606	SILFR6A11	
09482-00612	MR8AI9	

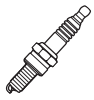

TACTI	→ NGK	Quick
V 9110 2003	BKR5EYA-11	
V 9110 2004	BCPR5EY	
V 9110 2005	BRE529Y	
V 9110 2006	BPR4EY-11	
V 9110 2007	BPR6EY	
V 9110 2008	BCPR5EY-11	
V 9110 2009	BRE527Y-11	
V 9110 2010	BKR6EYA-11	
V 9110 2011	DCPR7E	
V 9110 2012	BCPR6EY-11	
V 9110 2013	BPR6EK-A	
V 9110 2014	BCPR4EY-11	
V 9110 2015	BPR4EY	
V 9110 2016	BPR6EKB	
V 9110 2017	BPR6EY-11	
V 9110 2018	BCPR6ED	
V 9110 2019	BKR6E-N-11	
V 9110 2020	ZFR6G	
V 9110 2021	BCPR7EKD	
V 9110 2022	BPR5EJ	
V 9110 2023	ZFR6F-11	
V 9110 2024	BPR7ES	
V 9110 2025	BKR6EYA	
V 9110 2026	BKR5EYA	
V 9110 2027	BCPR6EY	
V 9110 2028	ZFR5F-11	
V 9110 2029	ZFR6A-11	
V 9110 2030	DCPR8E	
V 9110 2031	ZFR5J-11	
V 9110 2032	ZFR6J-11	
V 9110 2033	BKR5E-N-11	
V 9110 2034	BKR7EKC-N-11	
V 9110 2035	BKR7E-11	
V 9110 2036	BUR5ET-10	
V 9110 2037	BKUR6ET-10	
V 9110 2037	BKUR6ET-10	
V 9110 2038	BKUR6EK	
V 9110 2039	BKUR7EK	
V 9110 2040	BKR5EKB-11	
V 9110 2041	BKR6EKB-11	
V 9110 2042	BKR5E-11	
V 9110 2043	BKR6E-11	
V 9110 2044	BPR5E	
V 9110 2045	BCPR6EY-11	
V 9110 2046	BCPR5EY-11	
V 9110 2047	BKR6E	
V 9110 2048	ZFR5F-11	
V 9110 2049	BKUR6EK-9	
V 9110 2109	PFR7B-11	
V 9110 2110	PZFR5F-11	
V 9110 2111	PZFR6F-11	
V 9110 2201	BCPR5EIX-11	

TACTI	→ NGK	Quick
V 9110 2202	BCPR6EIX-11	
V 9110 2203	BKR5EIX-11	
V 9110 2204	BKR6EIX-11	
V 9110 2205	BKR7EIX-11	
V 9110 2206	BPR5EIX	
V 9110 2207	BPR6EIX	
V 9110 2209	DCPR8EIX	
V 9110 2210	BR8EIX	
V 9110 2211	BR9EIX	
V 9110 2212	BR9EIX	
V 9110 2213	BPR7EIX	
V 9110 2301	BCPR5EIX-11	
V 9110 2302	BCPR6EIX-11	
V 9110 2303	BKR5EIX-11	
V 9110 2304	BKR6EIX-11	
V 9110 2305	BPR5EIX-11	
V 9110 2306	BPR6EIX-11	
V 9110 2307	BPR7EIX	
V 9110 2308	DCPR7EIX	
V 9110 2343	LFR5AIX-11	
V 9110 2601	BCPR5EIX-11P	
V 9110 2602	BCPR6EIX-11P	
V 9110 2603	BKR5EIX-11P	
V 9110 2604	BKR6EIX-11P	
V 9110 2608	DCPR7EIX-P	
V 9110 2610	BKR7EIX-P	
V 9110 2617	LFR5AIX-11P	
V 9110 3000	BRE527Y-11	
V 9110 3001	BRE529Y	
V 9110 3002	BRE529Y-11	
V 9110 3006	BCPR5EY-11	
V 9110 3007	BCPR6E	
V 9110 3009	BCPR6EY-11	
V 9110 3012	BP4EY-11	
V 9110 3013	BPR4EY	
V 9110 3014	BPR4EY-11	
V 9110 3016	BUR5EB-11	
V 9110 3018	BP5EY	
V 9110 3021	BPR5E	
V 9110 3025	B5ES	
V 9110 3029	BP5ES-13	
V 9110 3030	BPR5EIX	
V 9110 3032	BPR5EY-11	
V 9110 3033	BR5HS	
V 9110 3034	B5HS	
V 9110 3035	B-6L	
V 9110 3037	BP5S	
V 9110 3041	BUR6EB-11	
V 9110 3043	BP6ES	
V 9110 3046	BUR6EA-11	
V 9110 3047	BPR6ES	
V 9110 3049	BPR6ES-11	



TACTI	→ NGK	Quick
V 9110 3051	B6ES	
V 9110 3057	BR6ES	
V 9110 3059	BPR6EK-A	
V 9110 3060	BPR6EK-A	
V 9110 3065	BPR6EIX	
V 9110 3068	BP6HS	
V 9110 3072	BR6HS	Q209
V 9110 3073	B6HS	Q203
V 9110 3075	B6S	Q302
V 9110 3076	BR6S	
V 9110 3085	BP7ES	Q206
V 9110 3087	BUR7EA-11	
V 9110 3088	BPR7ES	
V 9110 3093	B7ES	
V 9110 3095	BR7EIX	
V 9110 3098	BR7ES	
V 9110 3105	BR9EQ-14	
V 9110 3109	BP6ES-11	
V 9110 3110	BR5ES	
V 9110 3112	ZFR6A-11	
V 9110 3114	PGR5A-11	
V 9110 3115	PGR6A-11	
V 9110 3119	BKR5EYA	
V 9110 3120	BKR5EYA-11	
V 9110 3121	BKR6E-11	
V 9110 3122	BKR6EYA	
V 9110 3129	BCPR5EY	
V 9110 3130	BKR5E-11	
V 9110 3131	ZFR5J-11	
V 9110 3132	ZFR5F-11	
V 9110 3133	ZFR6J-11	
V 9110 3135	ZFR5E-11	
V 9110 3137	BCPR5E	
V 9110 3139	BKR6EYA-11	
V 9110 3140	BCPR6EY	
V 9110 3141	PFR6J-11	
V 9110 3142	PFR6G-11	
V 9110 3143	BKR5E-N-11	
V 9110 3144	BKR6E-N-11	
V 9110 3145	BKR6E	
V 9110 3152	BCPR5EIX-11	
V 9110 3153	BCPR6EIX-11	
V 9110 3154	BCPR5EIX-11	
V 9110 3155	BCPR6EIX-11	
V 9110 3160	BKR5EIX-11	
V 9110 3162	BKR6EIX-11	
V 9110 3166	BKR5EIX-11	
V 9110 3167	ZFR4F-11	
V 9110 3168	PFR6B-11	
V 9110 3169	ZFR6F-11	
V 9110 3170	BUR7EB-11	
V 9110 3173	PZFR6F	

TACTI	→ NGK	Quick
V 9110 3174	PFR5J-11	
V 9110 3175	PZFR5F	
V 9110 3176	DCP7E	
V 9110 3177	DCPR8E	
V 9110 3178	DCPR6E	
V 9110 3179	DCPR7E	
V 9110 3180	DCPR8E	
V 9110 3181	BCPR5E-11	
V 9110 3182	BKR6E-11	
V 9110 3183	BCPR4EY-11	
V 9110 3184	BCPR5E-11	
V 9110 3185	BKR6E-11	
V 9110 3186	BCPR5EY-11	
V 9110 3187	BCPR6EY-11	
V 9110 3188	BCPR6ED	
V 9110 3189	BCPR6EKD	
V 9110 3190	BCPR7EKD	
V 9110 3191	BKR5E	
V 9110 3192	BKR7E-11	
V 9110 3194	BKR5EKB-11	
V 9110 3195	BKR6EKB-11	
V 9110 3196	BKUR6EK	
V 9110 3197	BKUR7EK	
V 9110 3198	ZFR6G	
V 9110 3199	BP5EY-11	
V 9110 3200	BP7ES-11	
V 9110 3201	BPR5E-11	
V 9110 3202	BP4EY	
V 9110 3203	BP5EY	
V 9110 3204	BP6EY	
V 9110 3205	BP5EY-11	
V 9110 3206	BP6EY-11	
V 9110 3208	BPR6EY	
V 9110 3210	BPR5EY	
V 9110 3211	BPR6EY	
V 9110 3212	BPR6EY-11	
V 9110 3213	BPR5ES-13	
V 9110 3214	BP6EY	
V 9110 3216	BPR5EIX-11	
V 9110 3217	BPR5EKB	
V 9110 3218	BPR6EKB	
V 9110 3219	BPR6EKB-L	
V 9110 3220	BE527Y-11	
V 9110 3221	BE529Y-11	
V 9110 3222	BPR5EY-11	
V 9110 3225	BCPR6EIX-11	
V 9110 3230	GR4IX	
V 9110 3231	BPR5EIX	
V 9110 3232	BP5HS-10	
V 9110 3234	DCPR8EIX	
V 9110 3235	BCRE527Y	
V 9110 3237	ZFR4F-11	



TACTI	→ NGK	Quick
V 9110 3239	BPR5EP-11	
V 9110 3240	GR4IX	
V 9110 3241	BPR6EIX	
V 9110 3243	DCPR8EIX	
V 9110 3245	PFR6J	
V 9110 3246	PZFR5F-11	
V 9110 3247	PZFR6F-11	
V 9110 3248	ZFR5G	
V 9110 3249	BKR7EKC-N-11	
V 9110 3250	BUR6EA-11	
V 9110 3251	BUR7EA-11	
V 9110 3252	SD10A	
V 9110 3258	BUR5EB-11	
V 9110 3259	BUR6EB-11	
V 9110 3260	BUR7EB-11	
V 9110 3261	BPR5EJ	
V 9110 3262	BKR6EIX-11	
V 9110 3263	BK7EK-N-11	
V 9110 3264	PFR5B-11	
V 9110 3265	PFR7B-11	
V 9110 3266	BCPR5EIX-11	
V 9110 3268	BPR6HS-10	
V 9110 3270	PGR5A	
V 9110 3272	BPR7EKN	
V 9110 3293	BKR5EIX-11	
V 9110 3304	BKR6EKC	
V 9110 3305	BKUR6EK-9	
V 9110 3311	ZFR5F-11	
V 9110 3374	ZFR6K-11	
V 9110 3381	LFR6C-11	
V 9110 4000	C5HSA	
V 9110 4002	C6HSA	
V 9110 4004	CR6HSA	
V 9110 4006	C7HSA	
V 9110 4008	CR7HSA	
V 9110 4011	BP-2H	
V 9110 4012	B-4H	
V 9110 4013	BP-4H	
V 9110 4014	BP4HS	
V 9110 4019	BP5HS	
V 9110 4021	BP7HS	
V 9110 4024	BR7HS	Q211
V 9110 4025	B7HS	Q204
V 9110 4027	B7S	
V 9110 4028	BP8ES	
V 9110 4030	B8ES	Q201
V 9110 4032	BR8EIX	
V 9110 4033	BR8ES	Q207
V 9110 4034	B8EG	
V 9110 4037	BR8HS	Q212
V 9110 4038	B8HS	Q205
V 9110 4045	BR9ES	Q208

TACTI	→ NGK	Quick
V 9110 4046	B9ES	Q202
V 9110 4047	B9EG	
V 9110 4048	BR9EIX	
V 9110 4052	B9HS	
V 9110 4054	BR9HS	
V 9110 4057	BR10EIX	
V 9110 4062	B10ES	
V 9110 4063	BR10EIX	
V 9110 4075	DR5HS	
V 9110 4076	D6EA	
V 9110 4078	D6HA	
V 9110 4080	DR6HS	
V 9110 4086	DPR7EA-9	Q220
V 9110 4089	DR7EIX	
V 9110 4090	D7EA	
V 9110 4091	DR7EA	
V 9110 4096	DPR7EA-9	Q220
V 9110 4099	D8EA	Q216
V 9110 4100	DR8EIX	
V 9110 4101	DR8EA	
V 9110 4103	D8HA	
V 9110 4111	DPR7EA-9	Q220
V 9110 4114	D9EA	
V 9110 4115	DR9EIX	
V 9110 4116	DR9EA	Q219
V 9110 4119	D10EA	
V 9110 4122	DR9EIX	
V 9110 4126	CR8E	Q226
V 9110 4127	CR8EH-9	Q228
V 9110 4129	CR9EH-9	Q229
V 9110 4131	CR9E	Q227
V 9110 4149	BP6HSA	
V 9110 4150	DP8Z	
V 9110 4152	BP2HS	
V 9110 4155	CR9EK	Q230
V 9110 4157	D6EA	
V 9110 4158	CR8EK	
V 9110 4159	BR9ECM	
V 9110 4160	BR10ECM	
V 9110 5008	APR5FS	
V 9110 5013	APR6FS	
V 9110 5014	AR6FS	
V 9110 5020	BPR4FS	
V 9110 5022	BPR5EFS	
V 9110 5026	BPR5FS-11	
V 9110 5032	BPR6EFS	
V 9110 5033	BPR6EFS-15	
V 9110 5040	BP7EFS	
V 9110 5046	BP6S	
V 9110 5060	BKUR6ET	
V 9110 5061	BKUR6ET-10	
V 9110 5061	BKUR6ET-10	



TACTI	→ NGK	Quick
V 9110 5062	BKUR7ET	
V 9110 5063	BKR6EKUB	
V 9110 5064	BP5ET-10	
V 9110 5065	BUR6ET	
V 9110 5066	BP7ET	
V 9110 5068	PTR5A-13	
V 9110 5070	PTR5C-13	
V 9110 5301	BCPR5EIX-11	
V 9110 5302	BCPR6EIX-11	
V 9110 5303	BKR5EIX-11	
V 9110 5304	BKR6EIX-11	
V 9110 5305	BPR5EIX-11	
V 9110 5306	BPR6EIX-11	
V 9110 5307	BPR7EIX	
V 9110 5308	DCPR7EIX	
V 9110 5310	IRIWAY7	
V 9110 5311	IRIWAY8	
V 9110 5312	IRIWAY9	
V 9110 5313	IRITOP7	
V 9110 5314	IRITOP8	
V 9110 5315	IRITOP9	
V 9110 5316	BR8EIX	
V 9110 5317	BR9EIX	
V 9110 5319	BR10EIX	
V 9110 5325	TR5IX	
V 9110 5326	TR6IX	
V 9110 5327	TR7IX	
V 9110 5328	TR8IX	
V 9110 5330	UR5IX	
V 9110 5331	UR6IX	
V 9110 5343	LFR5AIX-11	
V 9110 5344	LFR6AIX-11	
V 9110 5361	CR7EIX	
V 9110 5362	CR8EIX	
V 9110 5363	B8HCS	
V 9110 5368	CR8EHIX-9	
V 9110 5369	CR9EHIX-9	
V 9110 5372	DR8EIX	
V 9110 5373	DR9EIX	
V 9110 5375	DPR7EIX-9	
V 9110 5376	DPR8EIX-9	
V 9110 5377	DPR9EIX-9	
V 9110 5379	BR7HIX	
V 9110 5380	BR8HIX	
V 9110 5381	BR9HIX	
V 9110 5383	CR7HIX	
V 9110 5384	CR8HIX	
V 9110 5391	BR8ECMIX	
V 9110 5392	BR9ECMIX	
V 9110 5393	BR10ECMIX	
V 9110 5501	LPG1	
V 9110 5502	LPG2	

TACTI	→ NGK	Quick
V 9110 5601	BCPR5EIX-11P	
V 9110 5602	BCPR6EIX-11P	
V 9110 5603	BKR5EIX-11P	
V 9110 5604	BKR6EIX-11P	
V 9110 5608	DCPR7EIX-P	
V 9110 5610	BKR7EIX-P	
V 9110 5617	LFR5AIX-11P	
V 9110 5618	LFR6AIX-11P	
V 9110 5619	LFR7AIX-P	
V 9110 5620	BKR6EIX-P	
V 9110 5623	HB6AIX-11P	
V 9110 5625	HB6BIX-11P	
V 9110 5636	BKR7EIX-11PS	
V 9110 5639	LFR6AIX-P	
V 9110 5722	R7420-11	
V 9110 6004	B-2	
V 9110 6006	BP-4	
V 9110 6008	B-4	
V 9110 6009	B4ES	
V 9110 6021	BP-4	
V 9110 6022	BM6A	Q303
V 9110 6023	BPM6A	Q304
V 9110 6026	BM7A	
V 9110 6027	BPM7A	Q305
V 9110 6028	B9HS-10	
V 9110 6037	BP6HS-10	
V 9110 6044	BPR2ES	
V 9110 6045	BP-2E	
V 9110 6046	BPR2ES	
V 9110 6047	B8HS-10	
V 9110 6050	CR5HSB	
V 9110 6076	LFR5A-11	
TORCH	→ NGK	Quick
5 580	BUR6ET	
8 012	BPR6EIX	
A 6 RTC	CR6HSA	
A 6 TC	C6HSA	
A 7 RTC	CR7HSA	
A 7 T	C7HSA	
A 7 TC	C7HSA	
A 8 RTC	CR8HSA	
A 8 TC	C8HSA	
B 8 RC	CR8E	Q226
C 6 RTC	D6HA	
CMR 7 H	CMR7H	
D 6 RTC 9	DPR6EA-9	
D 7	D7EA	
D 7 CA	D7EA	
D 7 RC	D7EA	
D 7 RTC	DPR7EA-9	Q220
D 7 RTC 9	DPR7EA-9	Q220



TORCH	→ NGK	Quick
D 7 TC	DP7EA-9	
D 8 C	D8EA	Q216
D 8 RC	DR8EA	
D 8 RTC	DR8EA	
D 8 T	D8EA	Q216
DK 7 RTC	DCPR7E	
E 4 RTC	BPR4HS	
E 4 TC	BP4HS	
E 5 RTC	BPR5HS	
E 5 T	BP-4H	
E 5 TC	BP5HS	
E 6 RC	BR6HS	Q209
E 6 RTC	BPR6HS	Q214
E 6 RTC	BPR6HS	Q214
E 6 RTC	BPR6HS	Q214
E 6 T	BP4HS	
E 7 C	B6HS	Q203
E 7 TJC	BUR6ET	
E 8 RC	BR8HS	Q212
E 8 RTC	BPR8HS	
F 5 C	B4ES	
F 5 RF	BPR5EY	
F 5 RTC	BPR5ES	
F 5 T	BP4ES	
F 5 TC	BP5ES	
F 6 RF	BPR6EY	
F 6 RTC	BPR6ES	
F 6 T	BP6ES	
F 7 C	B7ES	
F 7 RC	BR7ES	
F 7 RTC	BPR7ES	
F 7 RTJC	BUR6ET	
F 8 RC	BR8ES	Q207
F 8 RTC	BP8ES	
G 3 F	B-4	
G 3 TC	BP-4	
G 4 C	B-4	
G 4 RC	B-4	
G 5 RC	BR6S	
G 6	B6S	Q302
G 6 C	B6S	Q302
G 6 RC	BR6S	
GL 4	B4-LM	Q301
H 5	B6S	Q302
K 4 RTC 3	ZFR5F	
K 5 RF 11	BKR5E-11	
K 5 RTC 11	BKR5ES-11	
K 5 RTS	ZFR5P-G	
K 5 TC	BKR5ES-11	
K 6 RF	BKR6ES	
K 6 RF 11	BKR6E-11	
K 6 RTC	BKR5E-11	

TORCH	→ NGK	Quick
K 6 RTC 11	BKR6ES-11	
K 7 RTC	BKR6ES	
K 7 TC	BCP6ES	
K 7 TJC	BCP6ET	
L 5 C	BM4A	
L 5 T	BPM4A	
L 6	BM6A	Q303
L 6 C	BM6A	Q303
L 6 RC	BMR6A	Q307
L 6 RTC	BPMR6A	Q308
L 6 T	BPM6A	Q304
L 6 TC	BPM6A	Q304
L 7	BM7A	
L 7 RTC	BPMR7A	Q309
L 7 T	BPM7A	Q305
L 7 TC	BPM7A	Q305
L 7 Y	BM7A	
L 8 RT	BPMR7A	Q309
L 9	BM7A	
L 9 T	BPM7A	Q305
N 6	BM6F	
N 6 C	BM6F	
N 6 RC	BMR6F	
N 6 RTC	BPMR6F	
N 6 TC	BPM6F	
N 7 C	BM7F	
N 7 RC	BM7F	
N 9	BM7F	
P 5 RTC	BPR5FS	
P 5 TC	BP5FS	
P 6 RTC	BPR6FS	
P 6 TC	BP6FS	
P 7 RTC	BP7FS	
P 7 TC	BP7FS	
Q 5 RTC	BPR5EFS	
Q 5 TC	BP5EFS	
Q 6 RTC	BPR6EFS	
Q 6 TC	BP6EFS	
Q 7 TC	BP5EFS	
R 4 C	AB-6	
T 1137 C	C7HSA	
T 5 TC	AP5FS	
T 6 RTC	APR6FS	
T 6 TC	AP6FS	
YAMAHA	→ NGK	Quick
22401-AA670	IFR6B11	
7YK-82370-00	TB05EMA	
90793-20001	BR7EIX	
90793-20002	BR8EIX	
90793-20003	BR9EIX	
90793-20004	BR10EIX	



YAMAHA	→ NGK	Quick
90793-20005	BR6HIX	
90793-20006	BR7HIX	
90793-20007	BR8HIX	
90793-20008	BPR8EIX	
90793-20010	DR7EIX	
90793-20011	DR8EIX	
90793-20012	DR9EIX	
90793-20013	DPR8EIX-9	
90793-20014	DPR9EIX-9	
90793-20015	CR7HIX	
90793-20017	BR10HIX	
90793-20018	BR10EIX	
90793-20021	DR7EIX	
90793-20022	DR8EIX	
90793-20023	DR9EIX	
90793-20024	BPR5EIX	
90793-20025	BPR8EIX	
90793-20026	BPR9EIX	
90793-20028	B85EGV	
90793-20029	B95EGV	
90793-20030	B105EGV	
90793-20031	B11EGV	
90793-20032	B10EG	
90793-20035	BP-4H	
90793-20036	BP4HSA	
90793-20037	BP4HS-10	
90793-20038	BP5HS-10	
90793-20039	BP6HSA	
90793-20040	BP5ES-11	
90793-20045	BP6ES-11	
90793-20051	D8HA	
90793-20053	D10EA	
90793-20054	DP6EA-9	
90793-20057	BR6HS	Q209
90793-20058	BR7HS-10	
90793-20060	BR6ES	
90793-20062	BPR8ES	Q213
90793-20065	BPR5EY	
90793-20066	BPR5EY-11	
90793-20067	BPR6EY	
90793-20068	BPR6EY-11	
90793-20069	BPR7EY-11	
90793-20071	CR7HS	
90793-20072	CR8HS	
90793-20075	DR8HS	
90793-20076	DR7ES	
90793-20077	DR8ES	Q217
90793-20080	DPR7EA-9	Q220
90793-20081	CR7HIX	
90793-20083	DPR8EIX-9	
90793-20084	DPR9EIX-9	
90793-20085	BPR6HIX	

YAMAHA	→ NGK	Quick
90793-20086	BPR7HIX	
90793-20090	BPM7A	Q305
90793-20091	BPM4A	
90793-20092	BPM4A-10	
90793-20093	BPM6A-10	
90793-20094	BPMR4A	
90793-20095	BPMR4A-10	
90793-20096	BPMR6A-10	
90793-20098	BPMR7A	Q309
90793-20099	BR9HIX	
90793-20100	BR10HIX	
90793-20101	BPR6HIX	
90793-20102	BPR7HIX	
90793-20103	BPR8HIX	
90793-20106	BPR5EIX	
90793-20107	BPR6EIX	
90793-20108	BPR5EIX-11	
90793-20110	BPR7EIX	
90793-20112	BR8EIX	
90793-20113	BP8HS-10	
90793-20116	BPR5EIX	
90793-20117	BPR6EIX	
90793-20118	BR9EIX	
90793-20119	DPR8EIX-9	
90793-20120	DPR9EIX-9	
90793-20121	BR6FS	
90793-20122	CR8EIX	
90793-20123	CR9EIX	
90793-20124	CR8EIX	
90793-20125	CR9EIX	
90793-20127	BPR7ES-11	
90793-20128	BR4ES	
90793-20129	BPR7HS-10	
90793-20130	BR4HS	
90793-20131	BR5HS	
90793-20132	CR6HSA	
90793-20133	CR7HSA	
90793-20134	BR8EG	
90793-20135	BR9EG	
90793-20136	BR10EG	
90793-20138	BPR6EIX	
90793-20139	BR8ECM	
90793-20140	BR10ECM	
90793-20149	R0373A-10	
90793-20150	CR8EIX	
90793-20151	B8HCS	
90793-20152	DR8EIX	
90793-20153	DR9EIX	
90793-20154	DPR8EIX-9	
90793-20155	DPR9EIX-9	
90793-20156	BPR6HIX	
90793-20157	BPR7HIX	



YAMAHA	→ NGK	Quick
90793-20158	BR6HIX	
90793-20159	BR7HIX	
90793-20160	BR8EIX	
90793-20161	BR9EIX	
90793-20162	CR8EHIX-9	
90793-20163	CR9EHIX-9	
90793-20164	BR8HIX	
90793-20165	BR10EIX	
90793-20166	BPR8HIX	
90793-20167	BPR5EIX	
90793-20168	BPR6EIX	
90793-20169	CR5HIX	
90793-20170	CR6HIX	
90793-20171	CR7HIX	
90793-20172	CR7EIX	
90793-20173	DPR7EIX-9	
90793-20174	CR8HIX	
90793-20175	BPR7EIX	
90793-22001	BR8HIX	
90793-22003	DPR7EIX-9	
90793-22008	B5ES	
90793-22010	B9ES	Q202
90793-22031	BR7HS	Q211
90793-22032	BR8HS	Q212
90793-22033	BR7HS-10	
90793-22034	BR8HS-10	
90793-22035	BR6ES	
90793-22036	BR7ES	
90793-22037	BR9ES	Q208
90793-22039	BR8HS	Q212
90793-22045	BPR6EY-11	
90793-22047	DPR7EA-9	Q220
90793-22059	CR7HIX	
90793-22064	BR9EIX	
90793-22065	BR9EIX	
90793-22086	CR9EIX	
90793-22088	BR8EIX	
90793-22089	BR9EIX	
90793-22091	BR10EIX	
90793-22093	CR7EIX	
90793-22094	CR8EIX	
90793-22095	B8HCS	
90793-22096	CR8EHIX-9	
90793-22097	CR9EHIX-9	
90793-22098	DPR7EIX-9	
90793-22099	DPR8EIX-9	
90793-22100	DPR9EIX-9	
90793-22101	BPR7EIX	
90793-22107	DR8EIX	
90793-22108	DR9EIX	
90793-22109	BR7HIX	
90793-22110	BR8HIX	

YAMAHA	→ NGK	Quick
90793-22111	BR9HIX	
90793-22112	BPR5EIX-11	
90793-22114	CR7HIX	
90793-22115	CR8HIX	
9079E-NG001	BR8EIX	
9079E-NG002	BR9EIX	
9079E-NG003	BR10EIX	
9079E-NG004	BR8EIX	
9079E-NG005	BR9EIX	
9079Q-04574-00	LB05E	
9079Q-17675-00	LB05F	
9079Q-20800-00	LB05EH	
90890-78064	C8HA	
90890-78065	D6HA	
90890-78066	D6EA	
90890-78068	DP9EA-9	
90890-78070	B9HS-10	
90890-78071	BP8HS	
90890-78072	BP9ES	
90890-78073	BP4HA	
90890-78074	BM6A	Q303
90890-78075	BM7A	
90890-78076	BPM6A	Q304
90890-78077	BR9HS	
90890-78078	BPR7EIX	
90890-78079	BPR6EIX	
90890-78082	B10EGV	
90890-78086	BR8ES	Q207
90890-78094	B6HS	Q203
90890-78097	BP4HS	
90890-78102	BM6A	Q303
90890-78106	BPR7EIX	
90890-78108	BR7EIX	
90890-78110	BR9EIX	
90890-78111	BR10EIX	
90890-78112	BR10EIX	
90890-78115	BR9HIX	
90890-78116	BR10HIX	
90890-78118	DR8EIX	
90893-22113	BPR6EIX-11	
94700-00039	B6HS	Q203
94700-00040	B7HS	Q204
94700-00041	B8HS	Q205
94700-00043	B6ES	
94700-00044	B7ES	
94700-00045	B8ES	Q201
94700-00050	BP7HS	
94700-00108	BP6HS	
94700-00110	BR7HS	Q211
94700-00111	BR6ES	
94700-00117	BP7ES	Q206
94700-00118	BP8ES	



YAMAHA	→ NGK	Quick
94700-00157	D8EA	Q216
94700-00159	BP4HS	
94700-00168	BP5HS	
94700-00189	D7EA	
94700-00195	BR8HS	Q212
94700-00198	BPR6HS	Q214
94700-00198	BPR6HS	Q214
94700-00198	BPR6HS	Q214
94700-00203	DR8ES-L	Q218
94700-00204	BR8ES	Q207
94700-00208	DR7ES	
94700-00213	C6HA	
94700-00218	BPR7ES	
94700-00219	BPR8ES	Q213
94700-00227	BPR7HS	Q215
94700-00232	BP6HS-10	
94700-00234	BPR6ES	
94700-00241	DPR8EA-9	Q221
94700-00248	BR6HS	Q209
94700-00250	CR7HS	
94700-00254	C7HSA	
94700-00256	C6HSA	
94700-00258	BPR4HS	
94700-00261	BR9ES	Q208
94700-00262	DPR7EA-9	Q220
94700-00263	DP7EA-9	
94700-00268	BP8HS	
94700-00275	DP8EA-9	
94700-00280	BPR8HS	
94700-00282	CR6HS	Q223
94700-00292	BPR6HS-10	
94700-00318	CR9E	Q227
94700-00330	CR8E	Q226
94700-00333	DR8EA	
94700-00336	BPR5HS	
94700-00340	DR9EA	Q219
94700-00345	DR7EA	
94700-00353	CR7E	Q225
94700-00361	DPR9EA-9	Q222
94700-00366	CR7HSA	
94700-00372	CR6HSA	
94700-00375	DPR6EA-9	
94700-00381	CR6E	
94700-00394	R0373A-10	
94700-00397	B9HS	
94700-00402	CR10EK	
94700-00403	CR9EK	Q230
94700-00406	DPR5EA-9	
94700-00408	CR9EIA-9	
94700-00410	CR9E	Q227
94700-00411	CR8E	Q226
94700-00420	CPR7EA-9	

YAMAHA	→ NGK	Quick
94700-00424	LMAR9E-J	
94700-00825	BP7HS-10	
94700-00835	C7HSA	
94700-00835-00IV	C7HSA	
94700-00840	CR7E	Q225
94700-00841	C6HSA	
94700-00850	C6HSA	
94700-00850-00IV	C6HSA	
94700-00856	CR7HSA	
94700-00866	CPR8EA-9	
94700-00871	CPR9EA-9	
94700-00879	CR6HSA	
94701-00039	B6HS	Q203
94701-00040	B7HS	Q204
94701-00041	B8HS	Q205
94701-00042	B9HS	
94701-00043	B6ES	
94701-00044	B7ES	
94701-00045	B8ES	Q201
94701-00046	B9ES	Q202
94701-00048	B8HCS	
94701-00050	BP7HS	
94701-00061	BR8EIX	
94701-00063	BR9EIX	
94701-00069	B5HS	
94701-00078	B5ES	
94701-00108	BP6HS	
94701-00110	BR7HS	Q211
94701-00111	BR6ES	
94701-00112	BR7ES	
94701-00113	BR8EIX	
94701-00116	BP6ES	
94701-00117	BP7ES	Q206
94701-00118	BP8ES	
94701-00148	BR8HIX	
94701-00157	D8EA	Q216
94701-00159	BP4HS	
94701-00160	B8HS-10	
94701-00168	BP5HS	
94701-00188	BR9ES	Q208
94701-00189	D7EA	
94701-00190	BP5HA	
94701-00193	BR9EIX	
94701-00194	BPR5HS	
94701-00195	BR8HS	Q212
94701-00198	BPR6HS	Q214
94701-00198	BPR6HS	Q214
94701-00198	BPR6HS	Q214
94701-00203	DR8ES-L	Q218
94701-00204	DR8ES	Q217
94701-00208	DR7ES	
94701-00211	BPMR6A	Q308



YAMAHA	→ NGK	Quick
94701-00217	B7HS-10	
94701-00218	BPR7ES	
94701-00219	BPR8ES	Q213
94701-00227	BPR7HS	Q215
94701-00232	BP6HS-10	
94701-00234	BPR6ES	
94701-00237	BP8HS-10	
94701-00241	DPR8EA-9	Q221
94701-00247	BR8HS-10	
94701-00248	BR6HS	Q209
94701-00250	CR7HS	
94701-00251	BR9HS	
94701-00254	C7HSA	
94701-00256	C6HSA	
94701-00258	BPR4HS	
94701-00262	DPR7EA-9	Q220
94701-00263	DP7EA-9	
94701-00264	BP7HS-10	
94701-00266	D9EA	
94701-00267	BP8ES	
94701-00268	BP8HS	
94701-00273	B6HS-10	
94701-00274	BR6HS-10	
94701-00275	DP8EA-9	
94701-00280	BPR8HS	
94701-00282	CR6HS	Q223
94701-00284	BPR6EIX	
94701-00285	BPR6EIX	
94701-00287	DR8ES	Q217
94701-00292	BPR6HS-10	
94701-00300	CR5HS	
94701-00309	BR9HS-10	
94701-00310	C2H	
94701-00311	BR5ES	
94701-00315	C9E	
94701-00318	CR9E	Q227
94701-00324	BR9EG	
94701-00325	B9EG	
94701-00328	BPR5ES	
94701-00330	CR8E	Q226
94701-00332	R5184-105	
94701-00333	DR8EA	
94701-00340	DR9EA	Q219
94701-00345	DR7EA	
94701-00349	BR7ES	
94701-00353	CR7E	Q225
94701-00354	CR4HSA	
94701-00356	BR10ES	
94701-00358	C7E	
94701-00361	DPR9EA-9	Q222
94701-00365	BR6FS	
94701-00366	CR7HSA	

YAMAHA	→ NGK	Quick
94701-00371	BR7HS-10	
94701-00372	CR6HSA	
94701-00375	DPR6EA-9	
94701-00381	CR6E	
94701-00386	CR10EK	
94701-00395	CR9EK	Q230
94701-00402	CR10EK	
94701-00403	CR9EK	Q230
94701-00406	DPR5EA-9	
94701-00407	CR9EIA-9	
94701-00408	CR9EIA-9	
94701-00410	CR9E	Q227
94701-00411	CR8E	Q226
94701-00415	CPR8EA-9	
94701-00420	CPR7EA-9	
94701-00422	LMAR7A-9	
94701-00423	LMAR6A-9	
94701-00424	LMAR9E-J	
94701-00434	LMAR8G	
94701-00N02	B9EGV	
94702-00039	B6HS	Q203
94702-00040	B7HS	Q204
94702-00041	B8HS	Q205
94702-00044	B7ES	
94702-00045	B8ES	Q201
94702-00046	B9ES	Q202
94702-00069	B5HS	
94702-00111	BR6ES	
94702-00149	B7HS	Q204
94702-00160	B8HS-10	
94702-00188	BR9ES	Q208
94702-00193	BR9EIX	
94702-00195	BR8HS	Q212
94702-00204	BR8ES	Q207
94702-00211	BPMR6A	Q308
94702-00217	B7HS-10	
94702-00217-1	B7HS-10	
94702-00227	BPR7HS	Q215
94702-00234	BPR6ES	
94702-00247	BR8HS-10	
94702-00248	BR6HS	Q209
94702-00249	BR5HS	
94702-00251	BR9HS	
94702-00271	BR7HS-10	
94702-00272	BR7HS	Q211
94702-00273	B6HS-10	
94702-00274	BR6HS-10	
94702-00309	BR9HS-10	
94702-00317	B9HS-10	
94702-00323	B8EG	
94702-00324	BR9EG	
94702-00325	B9EG	



YAMAHA	→ NGK	Quick
94702-00326	BR8EG	
94702-00331	BPR4ES	
94702-00343	BR4ES	
94702-00348	BPR2ES	
94702-00349	BR7ES	
94702-00351	BP8ES	
94702-00356	BR10ES	
94702-00357	BR9ECM	
94702-00367	B10EG	
94702-00368	BR10EG	
94702-00372	CR6HSB	
94702-00373	R7376-10	
94702-00383	BR9ECS	
94702-00384	BR10ECS	
94702-00391	LFR5A-11	
94702-00391-0	B6HS	Q203
94702-00396	BR8ES-11	
94702-00399	BKR7ES-11	
94702-00400	LFR6A-11	
94702-00401	BKR6ES-11	
94702-00403	CR9EKB	
94702-00404	BKR7EKU	
94702-00405	BKR6EKU	
94702-00409	CR9EB	
94702-00412	BKR6E	
94702-00418	DPR6EB-9	
94702-00419	CR4HSB	
94702-00427	LFR6A	
94702-00428	CPR8EB-9	
94702-00429	LKR7E	
94702-00803	BP7HS-10	
94702-00808	BR8ES	Q207
94703-00001	B-4H	
94703-00039	B6HS	Q203
94703-00040	B7HS	Q204
94703-00041	B8HS	Q205
94703-00042	B9HS	
94703-00043	B6ES	
94703-00044	B7ES	
94703-00045	B8ES	Q201
94703-00046	B9ES	Q202
94703-00050	BP7HS	
94703-00059	BR7HIX	
94703-00060	BR9HIX	
94703-00062	BR6HIX	
94703-00065	BR7EIX	
94703-00069	B5HS	
94703-00074	BR8EIX	
94703-00075	BR9EIX	
94703-00078	B5ES	
94703-00108	BP6HS	
94703-00109	BP-2E	

YAMAHA	→ NGK	Quick
94703-00110	BR7HS	Q211
94703-00112	BR7ES	
94703-00113	BR8EIX	
94703-00114	BR9EIX	
94703-00116	BP6ES	
94703-00117	BP7ES	Q206
94703-00118	BP8ES	
94703-00133	BP5ES	
94703-00143	BR8HIX	
94703-00148	BR8HIX	
94703-00157	D8EA	Q216
94703-00159	BP4HS	
94703-00160	B8HS-10	
94703-00168	BP5HS	
94703-00181	D8EA	Q216
94703-00188	BR9ES	Q208
94703-00189	D7EA	
94703-00190	BP5HA	
94703-00191	BP4ES	
94703-00194	BPR5HS	
94703-00198	BPR6HS	Q214
94703-00198	BPR6HS	Q214
94703-00198	BPR6HS	Q214
94703-00203	DR8ES-L	Q218
94703-00204	BR8ES	Q207
94703-00207	B4ES	
94703-00213	C6HA	
94703-00214	C6HSA	
94703-00216	C7HSA	
94703-00217	B7HS-10	
94703-00218	BPR7ES	
94703-00220	BPR7ES	
94703-00221	BP2HS	
94703-00222	DR8EA	
94703-00223	BP6HS	
94703-00227	BPR7HS	Q215
94703-00232	BP6HS-10	
94703-00234	BPR6ES	
94703-00235	BPR6HS-10	
94703-00241	DPR7EA-9	Q220
94703-00254	C7HSA	
94703-00256	C6HSA	
94703-00258	BPR4HS	
94703-00262	DPR7EA-9	Q220
94703-00263	DP7EA-9	
94703-00264	BP7HS-10	
94703-00265	CR7HSA	
94703-00266	D9EA	
94703-00267	BP8ES	
94703-00273	B6HS-10	
94703-00275	DP8EA-9	
94703-00277	B9EGV	



BERU	→ NGK	D-Power
0 100 220 103	Y-204RS	
0 100 220 113	Y-112M1	
0 100 220 114	Y-112R1	
0 100 220 115	Y-705RS	
0 100 220 118	Y-208T	
0 100 221 102	Y-208T	
0 100 221 103	Y-918J	DP2
0 100 221 105	Y-208T	
0 100 221 106	Y-924J	DP1
0 100 221 107	Y-907R	
0 100 221 132	Y-924J	DP1
0 100 221 133	Y-924J	DP1
0 100 221 135	Y-909R	
0 100 221 141	Y-910J	DP3
0 100 221 144	Y-924J	DP1
0 100 221 145	Y-910J	DP3
0 100 221 146	Y-115T1	
0 100 221 147	Y-128T	
0 100 221 148	Y-117RS	
0 100 221 149	Y-118T1	
0 100 221 151	Y-204TS1	
0 100 221 152	Y-107R	
0 100 221 154	Y-924J	DP1
0 100 221 163	Y-739R	
0 100 221 170	Y-306R	
0 100 221 186	Y-118R	
0 100 222 101	Y-508J	
0 100 222 106	Y-810	
0 100 222 301	Y-810	
0 100 222 302	Y-729U	DP34
0 100 226 129	Y-913J	
0 100 226 163	Y-933J	DP25
0 100 226 164	Y-712RS	
0 100 226 170	Y-712RS	
0 100 226 171	Y-918J	DP2
0 100 226 173	Y-146R	
0 100 226 180	Y-147T	
0 100 226 182	Y-115R1	
0 100 226 183	Y-730U	DP17
0 100 226 184	Y-924J	DP1
0 100 226 185	Y-924J	DP1
0 100 226 186	Y-503J	DP10
0 100 226 188	Y-924J	DP1
0 100 226 189	Y-707RS	
0 100 226 194	Y-910J	DP3
0 100 226 198	Y-604J	
0 100 226 206	Y-710J	
0 100 226 207	Y-711J	DP28
0 100 226 208	Y-307R	
0 100 226 209	Y-732J	DP4
0 100 226 227	Y-924J	DP1
0 100 226 229	Y-722JS	

BERU	→ NGK	D-Power
0 100 226 233	Y-916J	DP6
0 100 226 234	Y-925J	DP16
0 100 226 235	Y-933J	DP25
0 100 226 237	Y-740U	DP22
0 100 226 238	Y-703R	
0 100 226 242	Y-715R	
0 100 226 243	Y-506J	DP7
0 100 226 245	Y-738U	
0 100 226 246	Y-928U	DP29
0 100 226 249	Y-929U	DP41
0 100 226 250	Y-605J	
0 100 226 255	Y-930U	DP30
0 100 226 258	Y-927J	DP19
0 100 226 299	Y-748U	DP14
0 100 226 300	CZ261	
0 100 226 302	Y1038J	
0 100 226 312	Y-701J	DP39
0 100 226 336	Y-501U	DP31
0 100 226 338	Y-741U	DP20
0 100 226 343	Y-504J	DP24
0 100 226 344	Y-517J	
0 100 226 351	Y-530J	
0 100 226 352	Y-502R	
0 100 226 354	Y-507J	DP32
0 100 226 362	Y-746J	DP38
0 100 226 365	Y-924J	DP1
0 100 226 366	Y-503J	DP10
0 100 226 371	Y-747U	DP26
0 100 226 372	Y-732J	DP4
0 100 226 373	Y-516J	DP12
0 100 226 375	Y-745U	DP11
0 100 226 379	Y-937J	
0 100 226 381	Y-524J	DP27
0 100 226 384	Y-548J	DP75
0 100 226 385	Y-939J	DP43
0 100 226 391	Y-543J	DP46
0 100 226 392	Y-523J	DP37
0 100 226 417	Y-749J	
0 100 226 422	Y-926U	
0 100 226 432	Y-534J	DP36
0 100 226 436	Y-532J	
0 100 226 475	Y-542J	DP45
0 100 226 480	Y-741U	DP20
0 100 226 482	Y1005J	DP56
0 100 226 492	Y1031J	DP71
0 100 226 494	Y-603J	DP60
0 100 226 495	Y-541J	DP42
0 100 226 497	Y-732J	DP4
0 100 226 504	Y-733J	DP13
0 100 226 511	CY52	
0 100 226 513	CY51	
0 100 226 514	Y-536J	DP81



BERU	→ NGK	D-Power
0 100 226 517	Y-904M1	
0 100 226 520	Y-527J	DP67
0 100 226 522	Y-529J	
0 100 226 526	Y-531J	DP44
0 100 226 527	Y1012J	DP65
0 100 226 538	Y1013J	DP63
0 100 226 568	Y1001J1	
0 100 226 577	Y1030J	DP70
0 100 226 639	Y-181T	
0 100 230 101	Y-162R1	
0 100 230 102	Y-755RS	
0 100 230 107	Y-157R	
0 100 231 104	Y-197R	
0 100 231 107	Y-757RS	
0 100 231 109	Y-197T	
0 100 231 114	Y-547AS	DP47
0 100 266 002	Y-607AS	DP50
0 100 266 008	YE14	DP48
0 100 266 009	Y8002AS	DP51
0 100 266 011	Y-609AS	DP49
0 100 266 016	Y1035AS	DP77
0 100 266 032	Y1036AS	
0 100 266 033	Y9003AS	DP78
0 100 266 034	Y1039AS	DP80
0 100 266 037	Y-609AS	DP49
0 100 266 040	Y8001AS	DP58
0 100 266 068	Y8005J	DP64
0 100 276 003	YE04	DP40
0 100 276 004	YE12	
0 100 276 005	Y8003J	DP62
0 100 276 008	YE05	DP73
0 100 276 012	YE13	
0 100 276 014	YE07	
0 100 276 015	YE08	
0 100 276 024	Y-519J	DP61
0 100 800 031	CZ258	
0 100 800 035	Y8001AS	DP58
105MN	Y-208T	
107MJ	Y-810	
108MJ	Y-810	
141MJ	Y-207T	
151MJ	Y-208T	
161MJ	Y-208T	
162MJ	Y-207T	
171MJ	Y-810	
601MJ	Y-918J	DP2
602MJ	Y-208T	
603MJ	Y-924J	DP1
609MJ	Y-924J	DP1
613MJ	Y-924J	DP1
624MJ	Y-924J	DP1
631MJ	Y-907R	

BERU	→ NGK	D-Power
633MJ	Y-924J	DP1
636MJ	Y-924J	DP1
642MJ	Y-924J	DP1
657MJ	Y-909R	
661MJ	Y-910J	DP3
663MJ	Y-924J	DP1
666MJ	Y-910J	DP3
673MJ	Y-115T1	
678MJ	Y-128T	
685MJ	Y-117RS	
688MJ	Y-118T1	
689MJ	Y-204TS1	
705MJ	Y-107R	
719MJ	Y-924J	DP1
730MJ	Y-739R	
749MJ	Y-306R	
783MJ	Y-729U	DP34
844MJ	Y-933J	DP25
852MJ	Y-913J	
853MJ	Y-712RS	
854MJ	Y-712RS	
855MJ	Y-732J	DP4
857MJ	Y-918J	DP2
858MJ	Y-916J	DP6
860MJ	Y-930U	DP30
880MJ	Y-157R	
886MJ	Y-146R	
887MJ	Y-181T	
888MJ	Y-204RS	
889MJ	Y-112M1	
890MJ	Y-162R1	
892MJ	Y-112R1	
894MJ	Y-118R	
895MJ	Y-197R	
897MJ	Y-147T	
898MJ	Y-115R1	
905MJ	Y-730U	DP17
908MJ	Y-924J	DP1
909MJ	Y-924J	DP1
912MJ	Y-503J	DP10
917MJ	Y-924J	DP1
920MJ	Y-705RS	
921MJ	Y-707RS	
922MJ	Y-757RS	
925MJ	Y-926U	
927MJ	Y-910J	DP3
944MJ	Y-604J	
945MJ	Y-307R	
946MJ	Y-710J	
947MJ	Y-711J	DP28
948MJ	Y-925J	DP16
950MJ	Y-732J	DP4



BERU	→ NGK	D-Power
954MJ	Y-924J	DP1
955MJ	Y-722JS	
959MJ	Y-933J	DP25
961MJ	Y-929U	DP41
963MJ	Y-506J	DP7
964MJ	Y-738U	
967MJ	Y-703R	
968MJ	Y-715R	
969MJ	Y-197T	
970MJ	Y-928U	DP29
991MJ	Y-927J	DP19
999MJ	Y-740U	DP22
GE100	Y-607AS	DP50
GE101	YE14	DP48
GE102	Y-547AS	DP47
GE105	Y8002AS	DP51
GE108	Y-609AS	DP49
GE110	Y1035AS	DP77
GE111	Y1036AS	
GE114	Y9003AS	DP78
GE115	Y-609AS	DP49
GE118	Y1039AS	DP80
GE121	Y8001AS	DP58
GE121A	Y8001AS	DP58
GN003	Y-745U	DP11
GN005	Y-701J	DP39
GN007	Y-741U	DP20
GN008	Y-501U	DP31
GN010	Y-746J	DP38
GN012	Y-502R	
GN013	Y-924J	DP1
GN015	Y-543J	DP46
GN016	Y-503J	DP10
GN017	Y-747U	DP26
GN018	Y-732J	DP4
GN019	Y-516J	DP12
GN022	Y-937J	
GN024	Y-507J	DP32
GN026	Y-517J	
GN027	Y-504J	DP24
GN030	Y-939J	DP43
GN033	Y-523J	DP37
GN035	Y-749J	
GN037	Y8005J	DP64
GN039	Y-530J	
GN041	Y-534J	DP36
GN042	Y-542J	DP45
GN043	Y-532J	
GN044	Y-755RS	
GN045	YE12	
GN046	Y-741U	DP20
GN047	YE04	DP40

BERU	→ NGK	D-Power
GN053	Y8003J	DP62
GN054	Y1005J	DP56
GN055	Y1031J	DP71
GN056	YE05	DP73
GN057	Y-508J	
GN058	YE13	
GN059	YE07	
GN060	Y-536J	DP81
GN061	Y-904M1	
GN062	Y-527J	DP67
GN063	YE08	
GN064	Y-529J	
GN065	Y-531J	DP44
GN072	CZ258	
GN095	Y1001J1	
GN097	Y1030J	DP70
GN101	CY51	
GN102	CY52	
GN103	Y-603J	DP60
GN104	Y-541J	DP42
GN107	Y-733J	DP13
GN108	Y1012J	DP65
GN109	Y-519J	DP61
GN110	Y1013J	DP63
GN853	Y-712RS	
GN854	Y-712RS	
GN855	Y-732J	DP4
GN857	Y-918J	DP2
GN858	Y-916J	DP6
GN860	Y-930U	DP30
GN905	Y-730U	DP17
GN908	Y-924J	DP1
GN909	Y-924J	DP1
GN912	Y-503J	DP10
GN917	Y-924J	DP1
GN925	Y-926U	
GN927	Y-910J	DP3
GN939	Y-548J	DP75
GN944	Y-604J	
GN948	Y-925J	DP16
GN954	Y-924J	DP1
GN955	Y-722JS	
GN959	Y-933J	DP25
GN961	Y-929U	DP41
GN963	Y-506J	DP7
GN964	Y-738U	
GN970	Y-928U	DP29
GN985	Y-605J	
GN991	Y-927J	DP19
GN992	Y-748U	DP14
GN993	Y-524J	DP27
GN994	CZ261	



BERU	→ NGK	D-Power
GN997	Y1038J	
GN999	Y-740U	DP22
GV105	Y-208T	
GV107	Y-810	
GV108	Y-810	
GV602	Y-208T	
GV603	Y-924J	DP1
GV631	Y-907R	
GV636	Y-924J	DP1
GV642	Y-924J	DP1
GV657	Y-909R	
GV661	Y-910J	DP3
GV663	Y-924J	DP1
GV666	Y-910J	DP3
GV673	Y-115T1	
GV678	Y-128T	
GV685	Y-117RS	
GV688	Y-118T1	
GV689	Y-204TS1	
GV705	Y-107R	
GV719	Y-924J	DP1
GV730	Y-739R	
GV749	Y-306R	
GV783	Y-729U	DP34
GV844	Y-933J	DP25
GV852	Y-913J	
GV880	Y-157R	
GV886	Y-146R	
GV887	Y-181T	
GV888	Y-204RS	
GV889	Y-112M1	
GV890	Y-162R1	
GV892	Y-112R1	
GV894	Y-118R	
GV895	Y-197R	
GV897	Y-147T	
GV898	Y-115R1	
GV920	Y-705RS	
GV921	Y-707RS	
GV922	Y-757RS	
GV945	Y-307R	
GV946	Y-710J	
GV947	Y-711J	DP28
GV967	Y-703R	
GV968	Y-715R	
GV969	Y-197T	
BMW	→ NGK	D-Power
12 23 1 288 245	Y-924J	
12 23 2 241 389	Y-924J	
12 23 2 248 059	Y-507J	
12 23 7 786 869	Y-547AS	

BMW	→ NGK	D-Power
12 23 7 798 001	Y1039AS	
BOSCH	→ NGK	D-Power
0 250 200 014	Y-810	
0 250 200 020	Y-810	
0 250 200 049	Y-207T	
0 250 200 052	Y-207T	
0 250 200 053	Y-909R	
0 250 200 054	Y-208T	
0 250 200 055	Y-810	
0 250 200 056	Y-208T	
0 250 200 058	Y-208T	
0 250 200 059	Y-208T	
0 250 200 060	Y-208T	
0 250 200 063	Y-207T	
0 250 200 065	Y-208T	
0 250 200 068	Y-208T	
0 250 200 069	Y-924J	DP1
0 250 200 420	Y-810	
0 250 200 454	Y-208T	
0 250 200 456	Y-208T	
0 250 200 465	Y-208T	
0 250 200 468	Y-208T	
0 250 201 001	Y-924J	DP1
0 250 201 004	Y-918J	DP2
0 250 201 005	Y-924J	DP1
0 250 201 006	Y-924J	DP1
0 250 201 008	Y-924J	DP1
0 250 201 009	Y-924J	DP1
0 250 201 011	Y-918J	DP2
0 250 201 012	Y-909R	
0 250 201 013	Y-924J	DP1
0 250 201 015	Y-918J	DP2
0 250 201 017	Y-907R	
0 250 201 019	Y-924J	DP1
0 250 201 021	Y-918J	DP2
0 250 201 026	Y-916J	DP6
0 250 201 027	Y-924J	DP1
0 250 201 029	Y-913J	
0 250 201 032	Y-918J	DP2
0 250 201 033	Y-924J	DP1
0 250 201 034	Y-909R	
0 250 201 035	Y-930U	DP30
0 250 201 038	Y-925J	DP16
0 250 201 039	Y-924J	DP1
0 250 201 041	Y-916J	DP6
0 250 201 042	Y-924J	DP1
0 250 201 043	Y-913J	
0 250 201 049	Y-937J	
0 250 201 050	Y-933J	DP25
0 250 201 053	Y-939J	DP43



BOSCH	→ NGK	D-Power
0 250 201 054	Y-925J	DP16
0 250 201 055	Y-916J	DP6
0 250 201 405	Y-924J	DP1
0 250 201 415	Y-918J	DP2
0 250 202 001	Y-910J	DP3
0 250 202 002	Y-739R	
0 250 202 003	Y-115T1	
0 250 202 004	Y-128T	
0 250 202 005	Y-117RS	
0 250 202 006	Y-118T1	
0 250 202 007	Y-107R	
0 250 202 008	Y-306R	
0 250 202 009	Y-732J	DP4
0 250 202 013	Y-204RS	
0 250 202 015	Y-103	
0 250 202 017	Y-112R1	
0 250 202 018	Y-910J	DP3
0 250 202 020	Y-503J	DP10
0 250 202 022	Y-732J	DP4
0 250 202 023	Y-741U	DP20
0 250 202 024	Y-927J	DP19
0 250 202 025	Y-730U	DP17
0 250 202 026	Y-929U	DP41
0 250 202 027	Y-604J	
0 250 202 028	Y-747U	DP26
0 250 202 029	Y-745U	DP11
0 250 202 032	Y-504J	DP24
0 250 202 033	Y-910J	DP3
0 250 202 034	Y-928U	DP29
0 250 202 035	Y-506J	DP7
0 250 202 036	Y-534J	DP36
0 250 202 038	Y1031J	DP71
0 250 202 039	Y-745U	DP11
0 250 202 040	Y-729U	DP34
0 250 202 041	Y-746J	DP38
0 250 202 042	Y-748U	DP14
0 250 202 043	Y-523J	DP37
0 250 202 045	Y-745U	DP11
0 250 202 046	Y-741U	DP20
0 250 202 048	Y1005J	DP56
0 250 202 051	Y-146R	
0 250 202 054	Y-118R	
0 250 202 058	Y-147T	
0 250 202 064	Y-755RS	
0 250 202 065	Y-904M1	
0 250 202 069	Y-162R1	
0 250 202 071	Y-181T	
0 250 202 076	Y-197R	
0 250 202 077	Y-705RS	
0 250 202 085	Y-710J	
0 250 202 086	Y-307R	
0 250 202 087	Y-711J	DP28

BOSCH	→ NGK	D-Power
0 250 202 089	Y-701J	DP39
0 250 202 090	Y1006J	
0 250 202 092	Y-733J	DP13
0 250 202 093	Y-712RS	
0 250 202 094	Y-115T1	
0 250 202 095	Y-532J	
0 250 202 096	Y-118T1	
0 250 202 097	Y-197T	
0 250 202 102	Y-501U	DP31
0 250 202 103	Y-507J	DP32
0 250 202 107	Y-157R	
0 250 202 110	Y-112T	
0 250 202 119	Y-178T	
0 250 202 124	Y1007J	DP59
0 250 202 125	Y-531J	DP44
0 250 202 128	Y-517J	
0 250 202 129	Y-516J	DP12
0 250 202 130	Y-548J	DP75
0 250 202 131	Y-524J	DP27
0 250 202 132	Y1030J	DP70
0 250 202 135	Y1005J	DP56
0 250 202 137	Y-541J	DP42
0 250 202 140	Y-929U	DP41
0 250 202 141	Y-745U	DP11
0 250 202 142	Y-745U	DP11
0 250 202 143	Y-605J	
0 250 203 001	YE07	
0 250 203 002	Y8003J	DP62
0 250 203 004	YE12	
0 250 203 009	Y8005J	DP64
0 250 203 012	YE08	
0 250 204 001	YE04	DP40
0 250 204 002	YE05	DP73
0 250 212 006	Y-749J	
0 250 212 009	Y-732J	DP4
0 250 212 011	Y-527J	DP67
0 250 312 001	CY51	
0 250 312 002	CY52	
0 250 312 003	Y-603J	DP60
0 250 402 001	Y-607AS	DP50
0 250 402 002	Y-547AS	DP47
0 250 402 005	Y-607AS	DP50
0 250 403 001	Y8008AS	DP74
0 250 403 002	YE14	DP48
0 250 403 007	Y1002AS	DP57
0 250 403 008	Y8002AS	DP51
0 250 403 009	Y1002AS	DP57
0 250 403 010	Y8009AS	
0 250 403 011	Y9003AS	DP78
0 250 403 012	Y1035AS	DP77
0 250 403 013	Y1036AS	
0 250 404 001	Y8001AS	DP58



BOSCH	→ NGK	D-Power
F 01 G 00000 P	Y1012J	DP65
GLP001	Y-924J	DP1
GLP002	Y-918J	DP2
GLP003	Y-732J	DP4
GLP004	Y-503J	DP10
GLP005	Y-924J	DP1
GLP006	Y-916J	DP6
GLP006	Y-916J	DP6
GLP007	Y-534J	DP36
GLP008	Y-745U	DP11
GLP008	Y-745U	DP11
GLP009	Y-506J	DP7
GLP010	Y-910J	DP3
GLP011	Y-516J	DP12
GLP012	Y-937J	
GLP013	Y-504J	DP24
GLP014	Y-730U	DP17
GLP015	Y-924J	DP1
GLP016	Y8003J	DP62
GLP017	Y-925J	DP16
GLP019	Y-748U	DP14
GLP020	Y-927J	DP19
GLP021	Y-929U	DP41
GLP021	Y-929U	DP41
GLP022	Y-745U	DP11
GLP023	Y-741U	DP20
GLP024	Y-524J	DP27
GLP025	Y-930U	DP30
GLP026	Y-928U	DP29
GLP030	Y-523J	DP37
GLP031	Y-501U	DP31
GLP032	Y-747U	DP26
GLP033	Y-741U	DP20
GLP034	Y-115T1	
GLP035	Y-603J	DP60
GLP036	Y-933J	DP25
GLP037	Y-913J	
GLP038	Y-701J	DP39
GLP040	Y-507J	DP32
GLP041	Y-739R	
GLP042	Y-118T1	
GLP043	YE07	
GLP045	Y-939J	DP43
GLP046	Y-711J	DP28
GLP047	Y-909R	
GLP048	Y-729U	DP34
GLP049	Y-712RS	
GLP050	Y-607AS	DP50
GLP051	Y-548J	DP75
GLP054	Y-733J	DP13
GLP055	Y1005J	DP56
GLP057	Y-517J	

BOSCH	→ NGK	D-Power
GLP059	YE04	DP40
GLP063	Y-810	
GLP066	Y1030J	DP70
GLP070	Y-547AS	DP47
GLP072	Y-710J	
GLP074	Y-532J	
GLP078	Y-604J	
GLP092	Y-541J	DP42
GLP093	YE14	DP48
GLP094	YE05	DP73
GLP096	Y-306R	
GLP098	Y-755RS	
GLP101	Y-531J	DP44
GLP102	Y-746J	DP38
GLP103	Y-904M1	
GLP105	CY52	
GLP108	CY51	
GLP109	Y1031J	DP71
GLP111	Y1005J	DP56
GLP115	YE12	
GLP116	Y-118R	
GLP117	Y-107R	
GLP120	Y-307R	
GLP121	Y-910J	DP3
GLP124	Y-146R	
GLP125	Y-103	
GLP127	Y-705RS	
GLP132	Y-197T	
GLP136	Y-197R	
GLP137	Y1007J	DP59
GLP138	Y-162R1	
GLP142	Y-147T	
GLP144	Y8008AS	DP74
GLP148	Y-112R1	
GLP152	Y-178T	
GLP155	Y-112T	
GLP156	Y1006J	
GLP159	Y-128T	
GLP167	Y-117RS	
GLP169	Y-157R	
GLP179	Y8009AS	
GLP185	Y-181T	
GLP186	Y-907R	
GLP194	Y1002AS	DP57
GLP196	Y9003AS	DP78
GLP202	Y8002AS	DP51
GLP203	Y-749J	
GLP205	Y8005J	DP64
GLP210	YE08	
GLP212	Y1012J	DP65
GLP221	Y1035AS	DP77
GLP222	Y1036AS	



BOSCH	→ NGK	D-Power
GLP224	Y-732J	DP4
GLP225	Y-605J	
GSA101	Y-810	
GSA91	Y-810	
BRISK	→ NGK	D-Power
21 N 21	Y-208T	
21 N 22	Y-208T	
21 N 51	Y-909R	
21 R 01	Y-918J	
21 R 02	Y-907R	
21 R 06	Y-918J	
21 R 21	Y-924J	
21 R 22	Y-924J	
21 R 23	Y-924J	
21 R 26	Y-913J	
21 R 51	Y-909R	
21 R 71	Y-910J	
CHAMPION	→ NGK	D-Power
CH 101 /002	Y-115R1	
CH 102 /002	Y-112M1	
CH 103 /002	Y-118T1	
CH 104 /002	Y-197R	
CH 121 /002	Y-118T1	
CH 137 /002	Y-924J	DP1
CH 147 /002	Y-910J	DP3
CH 154 /002	Y-715R	
CH 158 /002	Y-711J	DP28
CH 159 /002	Y-924J	DP1
CH 160 /002	Y-918J	DP2
CH 161 /002	Y-755RS	
CH 162 /002	Y-707RS	
CH 163 /002	Y-924J	DP1
CH 166 /002	Y-747U	DP26
CH 167 /002	Y-928U	DP29
CH 169 /002	Y-730U	DP17
CH 170 /002	Y-504J	DP24
CH 171 /002	Y-732J	DP4
CH 172 /002	Y-740U	DP22
CH 173 /002	Y-913J	
CH 174 /002	Y-924J	DP1
CH 175 /002	Y-930U	DP30
CH 176 /002	Y-916J	DP6
CH 177 /002	Y-925J	DP16
CH 178 /002	Y-729U	DP34
CH 179 /002	Y-933J	DP25
CH 181 /002	Y-741U	DP20
CH 184 /002	Y-732J	DP4
CH 185 /002	Y-503J	DP10
CH 189 /002	Y-924J	DP1
CH 196 /002	Y-524J	DP27

CHAMPION	→ NGK	D-Power
CH 203 /002	Y-507J	DP32
CH 204 /002	Y-929U	DP41
CH 205 /002	Y-937J	
CH 206 /002	Y-927J	DP19
CH 207 /002	Y-748U	DP14
CH 208 /002	Y-738U	
CH 215 /002	Y-501U	DP31
CH 216 /002	Y-502R	
CH 217 /002	Y-506J	DP7
CH 218 /002	Y-745U	DP11
CH 219 /002	Y-746J	DP38
CH 221 /002	Y-115T1	
CH 223 /002	Y8003J	DP62
CH 224 /002	YE07	
CH 263 /002	Y1007J	DP59
CH 268 /002	Y1005J	DP56
CH 60 /002	Y-207T	
CH 600 /002	CY52	
CH 601 /002	Y-603J	DP60
CH 63 /002	Y-208T	
CH 65 /002	Y-810	
CH 68 /002	Y-523J	DP37
CH 69 /002	Y-918J	DP2
CH 70 /002	Y-909R	
CH 79 /002	Y-907R	
CH 87 /002	Y-208T	
CH 88 /002	Y-924J	DP1
CH 90 /002	Y-739R	
CH 94 /002	Y-115T1	
CH 95 /002	Y-146R	
CH 96 /002	Y-204RS	
CH 97 /002	Y-107R	
CH 98 /002	Y-117RS	
CH101	Y-115R1	
CH102	Y-112M1	
CH103	Y-118T1	
CH104	Y-197R	
CH121	Y-118T1	
CH137	Y-924J	DP1
CH147	Y-910J	DP3
CH154	Y-715R	
CH158	Y-711J	DP28
CH159	Y-924J	DP1
CH160	Y-918J	DP2
CH161	Y-755RS	
CH162	Y-707RS	
CH163	Y-924J	DP1
CH166	Y-747U	DP26
CH167	Y-928U	DP29
CH169	Y-730U	DP17
CH170	Y-504J	DP24
CH171	Y-732J	DP4



CHAMPION	→ NGK	D-Power
CH172	Y-740U	DP22
CH173	Y-913J	
CH174	Y-924J	DP1
CH175	Y-930U	DP30
CH176	Y-916J	DP6
CH177	Y-925J	DP16
CH178	Y-729U	DP34
CH179	Y-933J	DP25
CH181	Y-741U	DP20
CH184	Y-732J	DP4
CH185	Y-503J	DP10
CH189	Y-924J	DP1
CH196	Y-524J	DP27
CH203	Y-507J	DP32
CH204	Y-929U	DP41
CH205	Y-937J	
CH206	Y-927J	DP19
CH207	Y-748U	DP14
CH208	Y-738U	
CH215	Y-501U	DP31
CH216	Y-502R	
CH217	Y-506J	DP7
CH218	Y-745U	DP11
CH219	Y-746J	DP38
CH221	Y-115T1	
CH223	Y8003J	DP62
CH224	YE07	
CH263	Y1007J	DP59
CH268	Y1005J	DP56
CH60	Y-207T	
CH600	CY52	
CH601	Y-603J	DP60
CH63	Y-208T	
CH65	Y-810	
CH68	Y-523J	DP37
CH69	Y-918J	DP2
CH70	Y-909R	
CH78	Y-208T	
CH79	Y-907R	
CH88	Y-924J	DP1
CH90	Y-739R	
CH94	Y-115T1	
CH95	Y-146R	
CH96	Y-204RS	
CH97	Y-107R	
CH98	Y-117RS	
DENSO	→ NGK	D-Power
067100-1042	Y-402-2	
067100-1043	Y-452-1	
067100-1070	Y-176	
067100-1071	Y-176	

DENSO	→ NGK	D-Power
067100-1090	Y-108	
067100-1120	Y-178	
067100-1130	Y-128	
067100-1161	Y-178T	
067100-1170	Y-128T	
067100-1171	Y-128T	
067100-1270	Y-118T1	
067100-1330	Y-147T	
067100-1340	Y-197T	
067100-1350	Y-128T	
067100-1360	Y-178T	
067100-1370	Y-118R	
067100-1430	Y-146R	
067100-1460	Y-197R	
067100-1530	Y-146R	
067100-1630	Y-118T1	
067100-1690	Y-703R	
067100-1710	Y-715R	
067100-1860	Y-532J	
DG001	Y-924J	DP1
DG002	Y-204TS1	
DG003	Y-503J	DP10
DG004	Y-910J	DP3
DG005	Y-732J	DP4
DG006	Y-913J	
DG007	Y-937J	
DG008	Y-506J	DP7
DG009	Y-927J	DP19
DG010	Y-916J	DP6
DG012	Y-918J	DP2
DG101	Y-740U	DP22
DG102	Y-928U	DP29
DG103	Y-933J	DP25
DG105	Y-115T1	
DG106	Y-925J	DP16
DG108	Y-904M1	
DG109	Y-741U	DP20
DG110	Y-929U	DP41
DG111	Y-502R	
DG112	Y-516J	DP12
DG113	YE04	DP40
DG114	Y-107R	
DG115	Y-729U	DP34
DG116	Y-504J	DP24
DG117	Y-925J	DP16
DG118	Y-748U	DP14
DG119	Y-930U	DP30
DG120	Y-707RS	
DG121	Y-524J	DP27
DG122	Y-534J	DP36
DG123	Y-907R	
DG124	Y-710J	



DENSO	→ NGK	D-Power
DG126	Y-517J	
DG127	Y-747U	DP26
DG129	Y-939J	DP43
DG130	Y-548J	DP75
DG133	Y-604J	
DG137	Y-712RS	
DG140	YE12	
DG142	Y-523J	DP37
DG144	Y-732J	DP4
DG145	Y-507J	DP32
DG146	Y-701J	DP39
DG155	Y-746J	DP38
DG157	Y-705RS	
DG159	Y-307R	
DG161	Y-924J	DP1
DG170	YE07	
DG171	Y8003J	DP62
DG172	Y-722JS	
DG173	Y-749J	
DG176	Y1031J	DP71
DG177	Y-607AS	DP50
DG178	Y-547AS	DP47
DG180	YE05	DP73
DG181	Y1005J	DP56
DG182	Y-605J	
DG184	Y-543J	DP46
DG185	Y-910J	DP3
DG186	Y1038J	
DG187	Y1007J	DP59
DG188	Y-536J	DP81
DG189	Y-508J	
DG190	YE14	DP48
DG193	Y1002AS	DP57
DG194	Y8002AS	DP51
DG195	Y8005J	DP64
DG196	Y1030J	DP70
DG197	Y-519J	DP61
DG202	Y-909R	
DG211	Y-715R	
DG214	Y-532J	
DG215	Y-118R	
DG216	Y-703R	
DG217	Y-531J	DP44
DG221	Y-118T1	
DG222	Y-197R	
DG223	Y-146R	
DG226	Y-178	
DG227	Y-128	
DG232	Y-147T	
DG233	Y-197T	
DG234	Y-128T	
DG235	Y-178T	

DENSO	→ NGK	D-Power
DG240	Y-542J	DP45
DG245	Y-531J	DP44
DG300	Y-603J	DP60
DG304	CY52	
DG305	Y1013J	DP63
DG306	CZ256	
DG307	CY51	
DG502	Y-529J	
KAWASAKI	→ NGK	D-Power
49036-1051	Y-706R	
MAGNETI MARELLI	→ NGK	D-Power
061 830 024 304	Y-918J	DP2
061 830 025 304	Y-924J	DP1
061 830 078 304	Y-924J	DP1
TIX 1 A	Y-207T	
TIX 2 A	Y-208T	
TIX 4 A	Y-208T	
TIX 6 A	Y-208T	
UX 1 A	Y-918J	DP2
UX 2 A	Y-924J	DP1
UX 4 A	Y-924J	DP1
PSA	→ NGK	D-Power
5960.12	YE05	DP73
5960.19	YE05	DP73
5960.64	Y1005J	DP56
5960.65	Y1005J	DP56
5960.66	Y-504J	DP24
5960.67	Y-504J	DP24
5960.76	YE12	
5960.77	YE12	
5960.78	YE05	DP73
5960.79	YE05	DP73
5960.88	Y-548J	DP75
5960.89	Y-548J	DP75
5960.99	YE08	
5960.A0	YE08	
5960.A3	Y8005J	DP64
5960.A4	Y8005J	DP64
5960.E6	Y8001AS	DP58
5960.E9	YE05	DP73
5960.F4	Y-504J	DP24
5960.F5	Y-504J	DP24
5960.F8	YE12	
5960.F9	YE05	DP73
5960.G6	YE08	
5960.K4	Y8005J	DP64
5961.22	Y-810	
5961.35	Y-810	

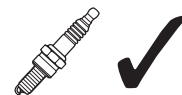
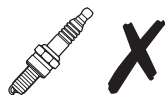
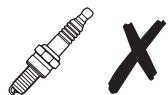

A-6	AB-6
A6FS	A6FS
A-7	AB-7
A7FS	A7FS
A-8	AB-8
A-8F	A8FS
A8FS	A8FS
A-9F	A9FS
A9FS	A9FS
AP5FS	AP5FS
AP6FS	AP6FS
AP6FS	AP6FS
AP7FS	AP7FS
AP8FS	AP8FS
AP9FS	AP9FS
APR5FS	APR5FS
APR5FS-11	APR5FS
APR6FS	APR6FS
AR6FS	AR6FS
B10EV	BR10EIX
B10EVX	BR10EIX
B10H	B10HS
B10HN	R5525-10
B10HP	R5530-10
B10HV	BR10HIX
B10HVX	BR10HIX
B11EN	B11EGV
B11HN	R5525-11
B11HP	R5525-11
B5ES-11	B5ES
B6EB-L-11	BR6ES
B6EFS	BR6EF
B6EMV	B6EM
B6ET	B6EM
B6EV	B6EVX
B6HV	BR6HIX
B6HVX	BR6HIX
B7EB	BR7ES
B7EB-11	BUR7EB-11
B7ET	BR7ET
B7EV	BR7EIX
B7EVX	BR7EIX
B7HV	BR7HIX
B7HVX	BR7HIX
B8EM	BR8EM
B8EMV	BR8ET
B8EN	B8EGV
B8ES-11	B8ES
B8ET	BR8ET
B8EV	BR8EIX
B8EVX	BR8EIX
B8HN	R5525-8
B8HV	BR8HIX

B8HVX	BR8HIX
B9EGP	BR9EIX
B9EN	B9EGV
B9EV	BR9EIX
B9EVX	BR9EIX
B9HCV	BR9HIX
B9HN	R5525-9
B9HP	R5530-9
B9HV	BR9HIX
B9HVX	BR9HIX
BCP4ES	BCPR4ES-11
BCP5E-11	BCPR5E-11
BCP5EV	BCP5EVX
BCP5EV-11	BCPR5EIX-11
BCP5EVX	-
BCP5EVX-11	BCPR5EIX-11
BCP5EY-11	BCPR5EY-11
BCP6E-11	BKR6E-11
BCP6EV	BCP6EVX
BCP6EV-11	BCPR6EIX-11
BCP6EVX	-
BCP6EVX-11	BCPR6EIX-11
BCP7E	BCPR7E
BCP7EV	BCP7EVX
BCPR5EP-11	BCPR5EIX-11
BCPR5EP-11	BCPR5EIX-11
BCPR5EP-13	BCPR5EIX-11
BCPR5EP-13	BCPR5EIX-11
BCPR5EP-8	BCPR5EP-8
BCPR5EVX-11	BCPR5EIX-11
BCPR6EP-11	BCPR6EP-11
BCPR6EP-13	BCPR6EIX-11
BCPR6EP-13	BCPR6EIX-11
BCPR6EP-8	BCPR6EP-8
BCPR6EP-N-11	BCPR6EIX-11
BCPR6EP-N-11	BCPR6EIX-11
BCPR6EP-N-8	BCPR6EP-N-8
BCPR6ER	BKR6EK
BCPR6EVX-11	BCPR6EIX-11
BCPR7ER	BKR6EK
BCPR7EVX-11	BKR7EIX-11
BCPR7EY	BCPR7E
BK5EKU	BKR5EKU
BK7EKU	BKR7EKU
BKR5EIX	BKR5EIX
BKR5EIX-11	BKR5EIX-11
BKR5EKUP	BKR5EKUP
BKR5EP-11	BKR5EP-11
BKR5EVX	BKR5EIX
BKR5EVX-11	BKR5EIX-11
BKR6EIX	BKR6EIX
BKR6EIX-11	BKR6EIX-11
BKR6EIX-LPG	LPG1

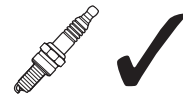
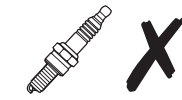
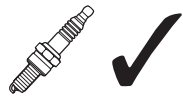
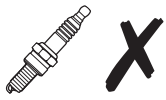

BKR6EKPA	BKR6EKPA
BKR6EKPB-11	BKR6EKPB-11
BKR6EP-11	BKR6EP-11
BKR6EP-13	BKR6EP-13
BKR6EP-8	BKR6EP-8
BKR6EVX	BKR6EIX
BKR6EVX-11	BKR6EIX-11
BKR6EVXA-11	BKR6EIX-11
BKR7EIX-11	BKR7EIX-11
BKR7EVX	BKR7EIX
BKR7EVX-11	BKR7EIX-11
BM6A	BM6A
BM7A	BM7A
BMR6A	BMR6A
BP10EV	BPR10EVX
BP4EFS	TR4
BP4ES-13	BPR4ES-13
BP5EA	BP4EY
BP5EA-11	BP4EY-11
BP5EA-L	BP5EY
BP5EA-L	BP5EY
BP5EA-L-11	BP5EY-11
BP5EJ	BPR5EY-11
BP5EKN	BPR5EY
BP5EV	BPR5EIX
BP5EVX	BPR5EIX
BP5EVX-11	BPR5EIX-11
BP6EA	BP6EY
BP6EA-11	BP6EY-11
BP6EF	BP6EF
BP6EK	BPR6EK-A
BP6EK-A	BPR6EK-A
BP6EKA-V	BPR6EK-A
BP6EKN	BPR6EKN
BP6EV	BPR6EIX
BP6EVX	BPR6EIX
BP6EVX-11	BPR6EIX-11
BP6HV	BPR6HIX
BP6HVX	BPR6HIX
BP7E	BPR7E
BP7EFVX	TR7IX
BP7EKN	BPR7EKN
BP7EV	BPR7EIX
BP7EVX	BPR7EIX
BP7EY-11	BPR7EY-11
BP7HV	BPR7HIX
BP7HVX	BPR7HIX
BP8ES-11	BP8ES
BP8EV	BPR8EIX
BP8EVX	BPR8EIX
BP8FS	R5674-8
BP8HSA	BPR8HSA
BP8HVX	BPR8HIX

BP9EV	BPR9EIX
BPM6A	BPM6A
BPM7A	BPM7A
BPMR6A	BPMR6A
BPMR7A	BPMR7A
BPR-2E	BPR2ES
BPR4EVX	GR4IX
BPR4S	BP-4
BPR4S-15	BP-4
BPR5EA	BPR5EY
BPR5EA-11	BPR5EY-11
BPR5EA-L	BPR5EY
BPR5EF-13	BPR5EFS-13
BPR5EFVX	TR5IX
BPR5EIX-11	BPR5EIX-11
BPR5EK-A	BPR5EIX-11
BPR5EKU	BPR5EKU
BPR5EP-11	BPR5EP-11
BPR5EP-13	BPR5EP-11
BPR5EV	BPR5EIX
BPR5EVX	BPR5EIX
BPR5EVX-11	BPR5EIX-11
BPR5S	BP5S
BPR6EA	BPR5EY
BPR6EF	BPR6EF
BPR6EFIX-10	BPR6EFIX-10
BPR6EP-8	BPR6EP-8
BPR6EV	BPR6EIX
BPR6EVX	BPR6EIX
BPR6FS-15	BPR6FS
BPR6HVX	BPR6HIX
BPR6S	BP6S
BPR7EVX	BPR7EIX
BPR7HVX	BPR7HIX
BPR9EVX	BPR9EIX
BR10ECMVX	BR10ECMIX
BR10EV	BR10EIX
BR5EB	BR5ES
BR5EB-11	BUR5EB-11
BR5ES-11	BR5ES
BR5FS-15	BR5FS
BR6EB	BR6ES
BR6EB-11	BUR6EB-11
BR6ET	B6EM
BR7EB	BR7ES
BR7EB-11	BUR7EB-11
BR7ES-11	BR7ES
BR7EVX	BR7EIX
BR8ECMVX	BR8ECMIX
BR8EV	BR8EIX
BR8EVX	BR8EIX
BR8EVX	BR8EIX
BR8HV	BR8HIX

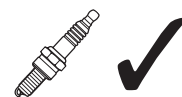
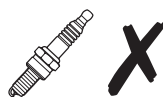
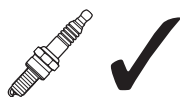
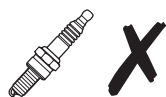

BR8HVX	BR8HIX
BR9ECMVX	BR9ECMIX
BR9EV	BR9EIX
BR9EVX	BR9EIX
BR9EVX	BR9EIX
BU6EA-11	BUR6EA-11
BU6EB-11	BUR6EB-11
BU7EA-11	BUR7EA-11
BUEW	BUE
BUR5EBVX-11	BUR5EB-11
BZ8ES	BR8ES
C10H	R0161-10
C6H	C6HSA
C6M	C6HSA
C7EH-9	CR7EH-9
C7HV	CR7HIX
C7HVX	CR7HIX
C8EHVX-9	CR8EHIX-9
C8EVX	CR8EIX
C8HV	CR8HIX
C9EHVX-9	CR9EHIX-9
C9EVX	CR9EIX
C9H	C8HSA
CPR7EAIX-9	CPR7EAIX-9
CR8EHVX-9	CR8EHIX-9
CR8EVX	CR8EIX
CR9EHVX-9	CR9EHIX-9
CR9EVX	CR9EIX
D12E	R2349-11
D-4H	DR4HS
D6ES	D6EA
D6HS	D6HA
D6HV	D6HA
D7EV	DR7EIX
D7EVX	DR7EIX
D8EV	DR8EIX
D8EVX	DR8EIX
D8HS	D8HA
D8HV	D8HA
D9EV	DR9EIX
D9EVX	DR9EIX
DCP8E	DCPR8E
DCP8EVX	DCPR8EIX
DCPR7E-N	DCPR7E-N-10
DCPR8EVX	DCPR8EIX
DCPR9EVX	DCPR9EIX
DIMR8B10	DIMR8A10
DP5EA-9	DPR5EA-9
DP7Z	DPR7Z
DP8EV-9	DPR8EIX-9
DP8EVX-9	DPR8EIX-9
DP9EV-9	DPR9EIX-9
DP9EVX-9	DPR9EIX-9

DPR7EIX-9	DPR7EIX-9
DPR7EV-9	DPR7EIX-9
DPR7EVX-9	DPR7EIX-9
DPR8EV-9	DPR8EIX-9
DPR8EVX-9	DPR8EIX-9
DPR9EV-9	DPR9EIX-9
DPR9EVX-9	DPR9EIX-9
DR8EVX	DR8EIX
DR9EVX	DR9EIX
ER8EHIX	ER8EHIX
FR4	FR4
FR4	FR4
FR45	FR45
FR45	FR45
FR5	FR5
FR5	FR5
FR5-1	FR5-1
GR4	GR4
GR4	GR4
GR45	GR45
GR45	GR45
GR4VX	GR4
GR5	GR5
GR55	GR55
IFR7G-11K	IFR7G-11KS
IGR7A	IGR7A
IKR9F8	IKR9J8
ILKAR6C10	ILKAR7C10
ILZKBR7A-8G	ILZKBR7B8DG
ITR5F13	TR5AI-13
IZFR5B	IZFR5B
IZFR6B	IZFR6B
JR10A	JR10B
JR9A	JR9B
LFR5AIX-11	LFR5AIX-11
LFR6AIX-11	LFR6AIX-11
LKR9CI-8	ILKR9G8
PFR5A-11	PFR5A-11
PFR5B	PFR5B-9
PFR5B	PFR5B-9
PFR5B-11	PFR5B-11
PFR5B-11B	PFR5B-11B
PFR5B-11C	-
PFR5B-11C	PFR5B-11C
PFR5C-11	PFR5C-11
PFR5G-11	PFR5G-11
PFR6A-11	PFR6A-11
PFR6B	PFR6B
PFR6B-11	PFR6B-11
PFR6B-11B	PFR6B-11B
PFR6B-11C	PFR6B-11C
PFR6B-9	PFR6B-9
PFR6G	PFR6G

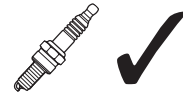
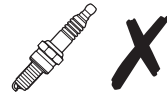
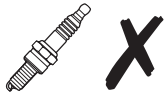

PFR6G-11	PFR6G-11
PFR6J-11	PFR6J-11
PFR6N-11	PFR6N-11
PFR7B	PFR7B
PFR7B-11	PFR7B-11
PFR7B-9	PFR7B-9
PFR7G-11	PFR7G-11
PFR8B	PFR8B
PFR8B-9	PFR8B-9
PGR5A-11	PGR5A-11
PGR6A	PGR6A
PGR6A-11	PGR6A-11
PGR6B	PGR6A-11
PGR6B	PGR6A-11
PGR7A-11	PGR7A-11
PJR7A	PJR7A
PKR7A	PKR7A
PLZKBR7A-G	PLZKBR7B8DG
PMR7A	PMR7A
PMR8A	PMR8A
PTR5A-13	PTR5A-13
PZFR5F	PZFR5F
PZFR5F-13	PZFR5F-13
PZFR6B	IZFR6B
PZFR6F	PZFR6F
PZFR6F-11	PZFR6F-11
PZFR6R8EG	SIZFR6B8EG
R0045A-10	R0045J-10
R0045A-11	R0045J-11
R0045G-9	-
R015-10	R0373A-10
R015-8	CR8EIX
R015-9	R0373A-10
R015-95	R0373A-10
R016-10	R0373A-10
R016-105	R0373A-9
R016-11	R0373A-11
R016-11	R0373A-11
R016-8	CR8EIX
R016-8	CR8EIX
R016-9	R0373A-10
R016E-11P	R0373A-11
R017-10	R0373A-10
R017-11	R0373A-11
R017-8	CR8EIX
R017-9	R0373A-9
R017-S11	R0373A-11
R017-S12	R017-12
R018 G8	-
R0256K-11	R0373A-11
R0256R-10	R0373A-10
R2097-11P	R2525-10
R216-10	R2525-10

R216-11	R2525-10
R216-12	R2349-11
R216-9	R2525-9
R217-10	R2525-10
R217-11	R2525-10
R217-12	R2349-11
R217-9	R2525-9
R2198-12P	R2349-11
R2270-11	R2349-11
R2270-9	R2349-9
R2430-10	R2349-10
R2430-9	R2349-9
R4118M-10	R4118S-10
R4118-M8	R4118S-8
R4118-M9	R4118S-9
R4339-9	B9EG
R4452D-10	B10EGP
R4452D-105	B105EGP
R4452D-11	B11EGP
R4452D-8	B8EGP
R4452D-85	B85EGP
R4452D-9	BR9EIX
R4452D-95	B95EGP
R4468A-11	R6725-11
R4468A-115	R6725-115
R4630A-10	R7376-10
R4630A-105	R7376-10
R4630A-11	R7376-10
R4630A-8	R7376-8
R4630A-9	R7376-9
R5184-11	R7282-11
R5300A-105	R7282-105
R5300A-11	R7282-11
R5300A-9	R7282-9
R5300N-105	R7282-105
R5400-10	R7435-10
R5400-7	BCPR7EIX
R5400-8	R7435-8
R5400-9	R7435-9
R5540-10	R5540F-10
R5540F-11	R7282-11
R5649-10	R6712-10
R5649-9	R6712-9
R5671-8	R5671A-8
R5671-9	R5671A-9
R5672-8	R5672A-8
R5672-9	R5672A-9
R5686-10	R7436-10
R5686-11	R7436-10
R5686-8	R7436-8
R5686-9	R7436-9
R5687-10	R7436-10
R5687-8	R7436-8

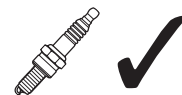
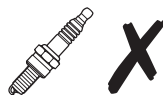
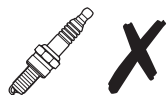

R5687-9	R7436-9
R5796-8	R7436-8
R5830-10	R7436-10
R5830-9	R7436-9
R6120-10	R7282-10
R6120-10	R7282-10
R6120-105	R7282-105
R6120-11	R7282-11
R6120-11	R7282-11
R6120A-105	R7282A-105
R6120A-105	R7282A-105
R6120A-11	R7282A-11
R6120C-105	R7282-105
R6120C-11	R7282-11
R6120M-105	R7282-105
R6120M-11	R7282M-11
R6179A-105P	R7282-105
R6205-9	R7433-9
R6242-10	R7434-10
R6242-10	R7434-10
R6252E-8	R7376-8
R6254E-8	R6254E-9
R6255-9	R7433-9
R6326-9	R7433-9
R6385-105P	R7376-10
R6385-105P	R7376-10
R6385-10P	R7376-10
R6385-11P	R7376-10
R6385-8P	R7376-8
R6385-9P	R7376-9
R6385-9P	R7376-9
R7112-9	R7433-9
R7113-9	R7433-9
R7114-9	R7433-9
R7115-10	R7433-10
R7115-8	R7433-8
R7115-9	R7433-9
R7116-10	R7434-10
R7116-8	R7434-8
R7116-9	R7434-9
R7117-10	R7434-10
R7117-8	R7434-8
R7117-9	R7434-9
R7118-10	R7434-10
R7118-8	R7434-8
R7119-8	R7434-8
R7119-9	R7434-9
R7232-7	BCPR7EIX
R7232-8	R7435-8
R7232-9	R7435-9
R7234-10	R7436-10
R7234-8	R7436-8
R7234-9	R7436-9

R7236-9	R7436-9
R7279-10	R7434-10
R7279-9	R7434-9
R7282C-105	R7282-105
R7282C-11	R7282-11
R7282M-105	R7282-105
R8102-10	R8102A-10
R8102-9	R8102A-9
R8108-10	R8108A-10
R8108-95	R8108A-10
RE8A-L	RE8C-L
SR5	TR5-1
TR4	TR4
TR4	TR4
TR4-2	TR4
TR5	TR5
TR5	TR5
TR5-1	TR5-1
TR5-1	TR5-1
TR55	TR55
TR55	TR55
TR55-1	TR55-1
TR55GP	TR55IX
TR55VX	TR55IX
TR5A-10	TR5A-10
TR5VX	TR5
TR6	TR6
UR4	UR4
UR4	UR4
UR40	UR45
UR45	UR45
UR45	UR45
UR5	UR5
UR5	UR5
UR55	UR55
UR55	UR55
UR5VX	UR5IX
UR6	UR6
WR5	WR5
WR5	WR5
WR5	WR5
WR5GP	WR5IX
XR4	XR4
XR4	XR4
XR40	XR45
XR45	XR45
XR5	XR5
XR5	XR5
YR5	YR5
YR5	YR5
YR55	YR55
ZF4A-11	ZFR4F-11
ZF5A-11	ZFR5F-11

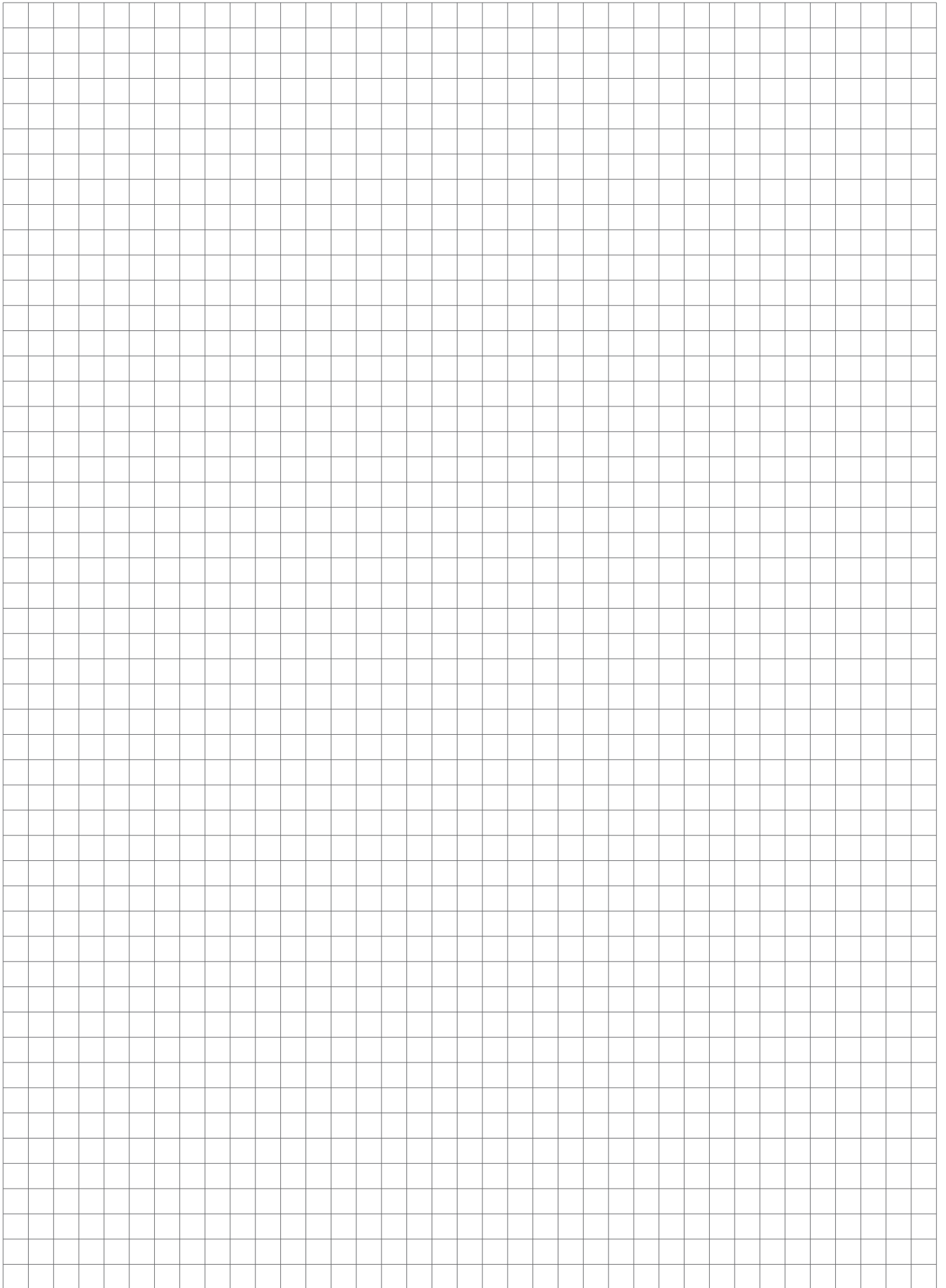

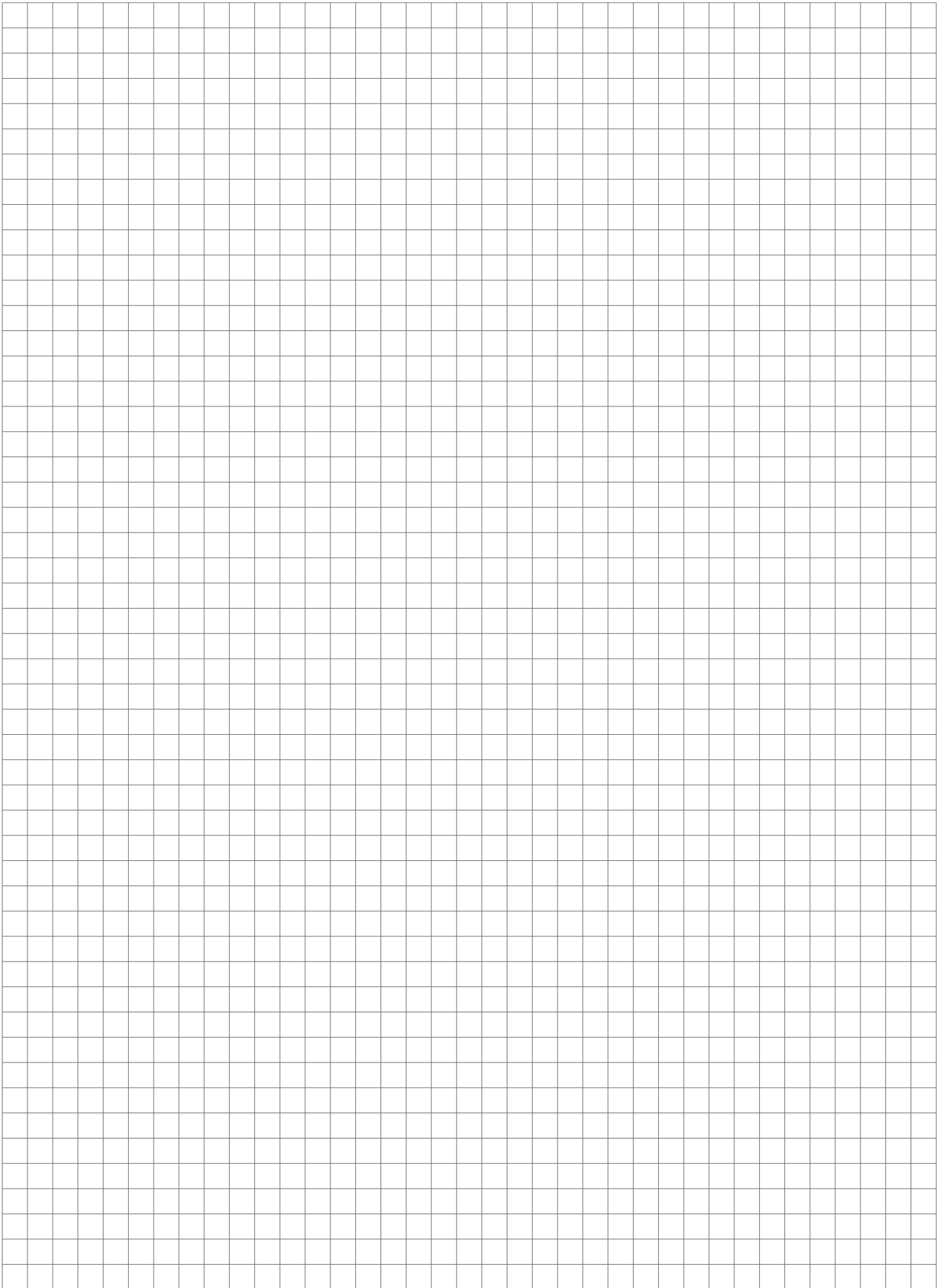

WHEN
PERFORMANCE
MEETS
PRECISION



IGNITION
PARTS



VEHICLE
ELECTRONICS



NGK SPARK PLUG EUROPE GmbH

Harkortstraße 41 // 40880 Ratingen // Germany
Tel.: +49 (0) 2102 974-000 // Fax.: +49 (0) 2102 974-149
www.ngk-europe.com



GR. 4 CANDELE

Candele "NGK"

DUCATI

59.97516 Candela NGK KR8C-G

Adattabile su:

DUCATI 400 Scrambler Sixty2 (KA00AA - 16/20)

Rif. orig.: 67040491A



HONDA

59.90312 Candela NGK MR7G-9E

Di primo equipaggiamento su:

HONDA 125 SH i (JF68B - 17/19) • 150 SH i (17/19)

Rif. Honda: 31917K77V01

Rif. NGK: MR7G-9E



59.7901 Candela NGK IJR7A9

Adattabile su:

HONDA 500 TRX FA Fourtrax Foreman Rubicon (FA1/FAA - 01/10)

Rif. NGK: IJR7A9



HUSQVARNA

59.90908 Candela NGK GR8DI-12

Adattabile su:

HUSQVARNA 150 TE 2T (20)

Rif. orig.: 51739193000



GR. 4 CANDELE

PIAGGIO

59.92499 Candela NGK LMAR8EI-7

Di primo equipaggiamento su:

PIAGGIO 150 Medley 4T IE (RP8MA0220 - 16/17)

125 Medley 4T IE ABS E4 (RP8MA0120 - 16/17)

125 Vespa GTS IE ABS E4 (MA3100 - 16/17)

150 Vespa GTS Super IE ABS E4 (MA3200 - 16/17)

Rif. NGK: LMAR8EI-7

Rif. Piaggio: 1D001003



UNIVERSALE

59.1316 Candela NGK MAR9B-JDS

Per:

UNIVERSALE (00)

Rif. NGK: MAR9B-JDS



59.92038 Candela NGK LFR7A

Per:

UNIVERSALE (00)

Rif. NGK: LFR7A



VARI

59.94422 Candela NGK ZFR6K-9E



Rif. NGK: ZFR6K-9E

GR. 4 CANDELE

59.95680 Candela NGK LZMAR8BI-10

Adattabile su:

HUSQVARNA 450 FE 4T (21) • 501 FE 4T (20/21)

KTM 450 EXC R / EXC F 4T (21) • 500 EXC 4T (20/21)

Rif. Husqvarna: 79739093000

Rif. KTM: 79739093000

