













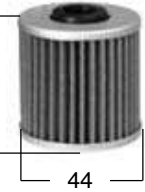



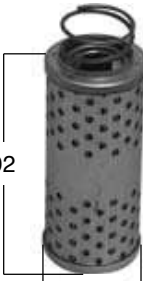

## Figurato filtri olio e filtri gasolio in ordine di codice

<p><b>26.0152</b></p>  <p>70 56</p> <p>Aprilia · Bombardier</p>	<p><b>26.0159</b></p>  <p>Ducati</p>	<p><b>26.0175</b></p>  <p>Harley Davidson</p>	<p><b>26.0186</b></p>  <p>35 41</p> <p>Aprilia</p>
<p><b>26.0567</b></p>  <p>MV Agusta</p>	<p><b>26.0568</b></p>  <p>44 44</p> <p>Kymco</p>	<p><b>26.0651</b></p>  <p>53 41,5</p> <p>KTM</p>	<p><b>26.0655</b> c/O'Ring</p>  <p>67 41</p> <p>Husqvarna · Husaberg · KTM</p>
<p><b>26.3959</b></p>  <p>52 50</p> <p>Ducati · Italjet</p>	<p><b>26.4134</b></p>  <p>87 45</p> <p>Moto Guzzi</p>	<p><b>26.4200</b></p>  <p>50,5 55</p> <p>Cagiva</p>	<p><b>26.4204</b> 3/4"-16UNF</p>  <p>61 76 Ø 17,5</p> <p>Cagiva · Ducati · Gilera · Laverda</p>
<p><b>26.4211</b></p>  <p>102 45</p> <p>Moto Guzzi</p>	<p><b>26.4221</b> filtro gasolio</p>  <p>M16x1,5 115 Ø 14,5 87</p> <p>Piaggio</p>	<p><b>26.4224</b></p>  <p>Ø 17,5 95 3/4"-16UNF 98</p> <p>Piaggio</p>	
<p><b>26.4352</b></p>  <p>65 68 Ø 17,5</p> <p>3/4"-16UNF</p> <p>Piaggio (Daihatsu)</p>	<p><b>26.4387</b> <b>26.43871</b> M20x1,5</p>  <p>60 76 Ø 18,5</p> <p>Casalini · Chatenet · Ligier Microcar · Piaggio (Lombardini)</p>	<p><b>26.4389</b> filtro gasolio <b>26.43891</b> filtro gasolio</p>  <p>M16x1,5 75 Ø 14,5 76</p> <p>Casalini · Chatenet Ligier · Microcar Piaggio (Lombardini)</p>	
<p><b>26.4503</b></p>  <p>Ø 18,5 92 M20x1,5 76</p> <p>Lombardini · Piaggio</p>	<p><b>26.4504</b> filtro gasolio</p>  <p>Ø 14,5 M16x1,5 125 84,5</p> <p>Lombardini Piaggio</p>	<p><b>26.4509</b></p>  <p>3/4"-16UNF Ø 17,5 95 93</p> <p>Piaggio</p>	

N.B.: misure in millimetri.

**26.4511** filtro gasolio



Aixam · Bellier · JDM (Kubota)

**26.4512** filtro gasolio



Aixam (Kubota)

**26.4513** M20x1,5

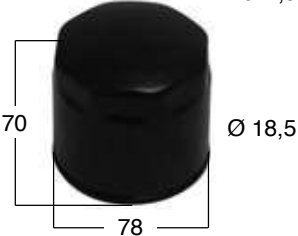

70  
Ø 18,5  
78

Aixam · Bellier · JDM (Kubota)

**26.4514** M20x1,5



70  
Ø 18,5  
66,5

Aixam · Bellier · JDM · Microcar (Kubota-Yanmar)

**26.4515** filtro gasolio



Bellier · JDM · Microcar (Yanmar)

**26.4516** filtro gasolio



Casalini · Piaggio (Mitsubishi)

**26.4517**



17,5  
58  
50

Moto Morini

**26.4518**



Piaggio

**26.6005** c/O'Ring

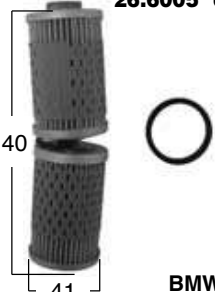

140  
41

BMW

**26.6006** 3/4"-16UNF  
**26.8163**  
**26.0163**



Ø 17,5  
83  
76

BMW

**26.6007**  
**26.8151**  
**26.0151**



52  
56

Aprilia · BMW  
Bombardier · KTM · Java  
Muz · Puch · SWM

**26.6009** in 2 pezzi  
**26.8161** pezzo unico  
**26.0161** pezzo unico



125  
41

BMW

**26.6025**  
**26.8164**  
**26.0164**



54  
Ø 17,5  
76

3/4"-16UNF

BMW

**26.6026** 3/4"-16UNF  
**26.8160**  
**26.0160**



62  
Ø 17,5  
76

BMW · Husqvarna

**26.6195** filtro gasolio



M16x1,5  
Ø 14,5  
148  
84,5

Piaggio

**26.8111**  
**26.0111**



45  
69

Honda

**26.8112**  
**26.0112**



35  
50

Gas Gas · Honda  
Kawasaki  
Polaris · Suzuki

**26.8113**  
**26.0113**

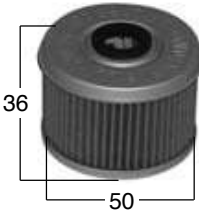

36  
50

Honda

**26.8114**  
**26.0114**



47  
69

Honda

**26.8116**  
**26.0116**



34  
38

Honda · HM · Husqvarna

**26.8123**  
**26.0123**



57  
55

Kawasaki

**26.8126**

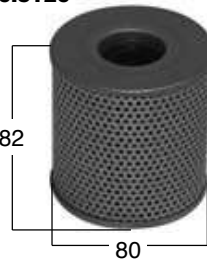

82  
80













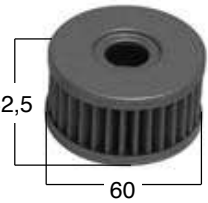

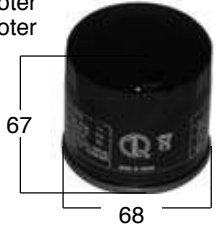



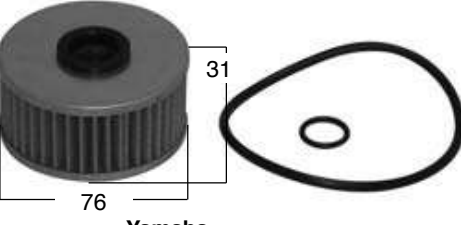

Kawasaki

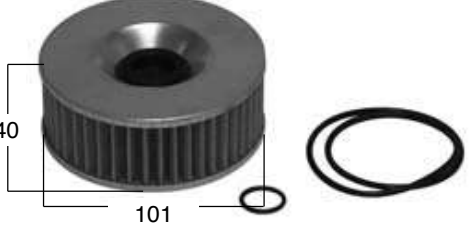



**26.8131**  
**26.0131**  
**26.8971** filtro scooter  
**26.0971** filtro scooter

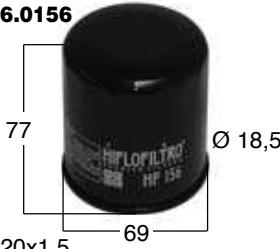

40,5  
44

Hyosung  
Suzuki

<p><b>26.8132</b> <b>26.0132</b> <b>26.8972</b> filtro scooter <b>26.0972</b> filtro scooter</p>  <p>Artic Cat · Beta Kawasaki Suzuki · Yamaha</p>	<p><b>26.8133</b> c/O'Ring <b>26.0133</b> c/2 O'Ring</p>  <p>Suzuki</p>	<p><b>26.8134</b> <b>26.0134</b> 3/4"-16UNF</p>  <p>Suzuki</p>	
<p><b>26.8136</b> <b>26.0136</b></p>  <p>Beta · Suzuki</p>	<p><b>26.8137</b> <b>26.0137</b></p>  <p>Suzuki</p>	<p><b>26.8138</b> <b>26.0138</b> <b>26.8975</b> filtro scooter <b>26.0975</b> filtro scooter</p>  <p>Ø 19 M20x1 Aprilia · Artic Cat Cagiva · Kawasaki · Suzuki</p>	<p><b>26.8139</b> <b>26.0139</b></p>  <p>Artic Cat Kawasaki · Suzuki</p>
<p><b>26.8140</b> <b>26.0140</b></p>  <p>Gas Gas · Yamaha</p>	<p><b>26.8141</b> <b>26.0141</b> <b>26.8981</b> filtro scooter <b>26.0981</b> filtro scooter</p>  <p>Beta · Fantic Gas Gas · HM Husqvarna MBK · TM · Yamaha</p>	<p><b>26.8142</b> <b>26.0142</b></p>  <p>TM · Yamaha</p>	<p><b>26.8143</b> <b>26.0143</b></p>  <p>MBK · Yamaha</p>
<p><b>26.8144</b> c/2 O'Ring <b>26.0144</b> s/O'Ring</p>  <p>Yamaha</p>	<p><b>26.8145</b> <b>26.0145</b></p>  <p>Aprilia · Muz · Yamaha</p>	<p><b>26.8146</b> c/2 O'Ring</p>  <p>Yamaha</p>	
<p><b>26.8147</b> <b>26.0147</b> <b>26.8985</b> filtro scooter <b>26.0985</b> filtro scooter</p>  <p>Ø 18,5 M20x1,5 Kymco · Yamaha</p>	<p><b>26.8148</b></p>  <p>Ø 18,5 M20x1,5 TGB · Yamaha</p>	<p><b>26.8153</b> <b>26.4100</b> <b>26.0153</b></p>  <p>Ø 14,5 M16x1,5 Bimota Cagiva · Ducati · Gilera</p>	
<p><b>26.8154</b> <b>26.4393</b> <b>26.0154</b></p>  <p>Aprilia · Husqvarna</p>	<p><b>26.8155</b> <b>26.0155</b></p>  <p>Beta · Husaberg · KTM · Polaris</p>	<p><b>26.8156</b> <b>26.0156</b></p>  <p>Ø 18,5 M20x1,5 KTM</p>	<p><b>26.8157</b> <b>26.0157</b> c/O'Ring</p>  <p>Beta · KTM · Polaris</p>

<p><b>26.8158</b> <b>26.0158</b></p>  <p>130 41</p> <p>KTM</p>	<p><b>26.8165</b> <b>26.0165</b></p>  <p>57 76 Ø 17,5</p> <p>3/4"-16UNF</p> <p>BMW • Husqvarna</p>	<p><b>26.8167</b> <b>26.0167</b></p>  <p>36,4 38</p> <p>Daelim</p>	<p><b>26.8168</b> <b>26.0168</b></p>  <p>47 41</p> <p>Daelim</p>
<p><b>26.8169</b> <b>26.0169</b></p>  <p>57 38</p> <p>Daelim</p>	<p><b>26.8171</b> nero <b>26.81713</b> cromato <b>26.0171</b> nero <b>26.01713</b> cromato</p>  <p>3/4"-16UNF 92 Ø 17,5 77</p> <p>Buell Harley Davidson</p>	<p><b>26.81723</b> cromato <b>26.01723</b> cromato</p>  <p>68 80 Ø 14,5</p> <p>M16x1,5 Harley Davidson</p>	
<p><b>26.81733</b> cromato <b>26.01733</b> cromato</p>  <p>Ø 17,5 142 3/4"-16UNF 80</p> <p>Harley Davidson</p>	<p><b>26.81743</b> cromato <b>26.01743</b> cromato</p>  <p>M16x16 86 Ø 19,5 76</p> <p>Harley Davidson</p>	<p><b>26.8177</b> <b>26.0177</b></p>  <p>73,5 65,5 Ø 17,5 3/4"-16UNF</p> <p>Buell</p>	
<p><b>26.8181</b> <b>26.0181</b></p>  <p>36 33</p> <p>Aprilia Cagiva • Italjet • Piaggio</p>	<p><b>26.8183</b> <b>26.0183</b></p>  <p>Ø 12,5 67 52 M14x1,5</p> <p>Aprilia Benelli • Derbi • Gilera Italjet • Malaguti • Piaggio • Peugeot</p>	<p><b>26.8184</b> <b>26.0184</b></p>  <p>3/4"-16UNF 57 76 Ø 17,5</p> <p>Aprilia • Gilera Malaguti • Peugeot • Piaggio</p>	<p><b>26.8185</b> <b>26.0185</b></p>  <p>33 41</p> <p>Aprilia • BMW • Peugeot</p>
<p><b>26.8191</b> <b>26.0191</b></p>  <p>M20x1,5 66 Ø 18,5 71,5</p> <p>Triumph</p>	<p><b>26.8197</b> <b>26.0197</b></p>  <p>70 52 M14x1,5 Ø 12,5</p> <p>Aeon • Benelli Hyosung • Polaris • PGO</p>	<p><b>26.8198</b> <b>26.0198</b></p>  <p>85 65 M20x1,5 Ø 18,5</p> <p>Polaris</p>	
<p><b>26.8199</b> <b>26.0199</b></p>  <p>67 65</p> <p>Polaris</p>	<p><b>26.8202</b> <b>26.0202</b></p>  <p>M20x1,5 82 80 Ø 18,5</p> <p>Honda • Kawasaki</p>	<p><b>26.8204</b> <b>26.0204</b> <b>26.8951</b> filtro scooter <b>26.0951</b> filtro scooter</p>  <p>Ø 18,5 67 M20x1,5 65,5</p> <p>Honda • Kawasaki • Suzuki • Yamaha</p>	

N.B.: misure in millimetri.

**26.8207**  
**26.0207**



Beta • Kawasaki • Suzuki

**26.8303**  
**26.0303**

M20x1,5  
Ø 18,5



Honda  
Kawasaki • Yamaha

**26.8401** s/O'Ring  
**26.0401** c/2 O'Ring

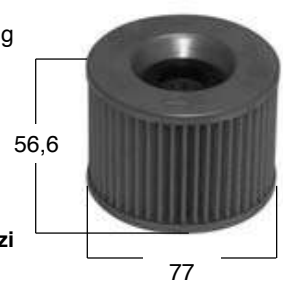

Benelli • Moto Guzzi  
Honda • Kawasaki  
Triumph • Yamaha

**26.8551** nero  
**26.4311** bianco  
**26.0551** nero

3/4"-16UNF

91  
Ø 17,5

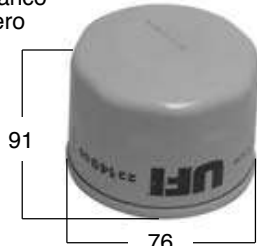

Moto Guzzi

**26.8552** nero  
**26.4101** bianco  
**26.0552** nero

M16x1,5

61  
Ø 14,5

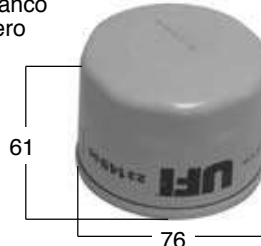

Benelli • Moto Guzzi

**26.8553**  
**26.0553**

65

M20x1,5

Ø 18,5

65



Benelli

**26.8554**  
**26.0554**

65

Ø 18,5



M20x1,5

MV Agusta

**26.8556**  
**26.0556**

105



Bombardier  
John Deere

**26.8557**  
**26.0557**

75

Ø 17,5

3/4"-16UNF

85



Bombardier • John Deere

**26.8559**  
**26.0559**

32

41



Bombardier • Cam-Am

**26.8560**  
**26.0560**

45

41



Bombardier • Cam-Am

**26.8561**  
**26.0561**

45

69



Kymco

**26.8562**  
**26.4506**  
**26.0562**

73



Kymco

**26.8563**  
**26.0563**

45,5

45



Aprilia • Derbi • Husqvarna  
Piaggio

**26.8564**  
**26.0564**

96

56

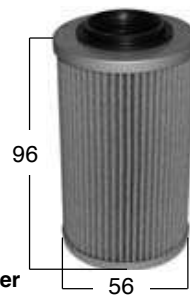

Aprilia  
Bombardier  
Buell

**26.8565**  
**26.0565**

3/4"-16UNF

54

Ø 17,5

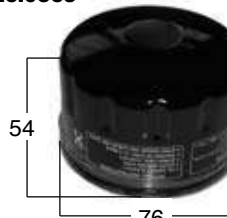

Aprilia • Gilera

**26.8566**  
**26.0566**

44

42



Kymco

**26.8575**  
**26.0575**

39

45



Aprilia

**26.8611**  
**26.0611**

87

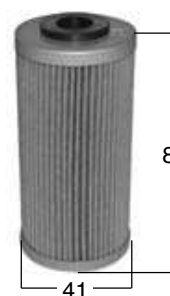

Sherco  
BMW  
Husqvarna

**26.8621**  
**26.0621**

85

65



Artic Cat

**26.8631**  
**26.0631**

120

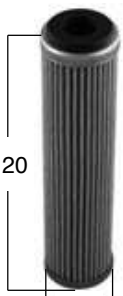

Beta

**26.8652**  
**26.0652**

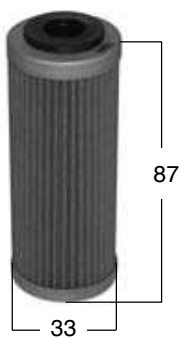

Husaberg  
Husqvarna · KTM

**26.8658**  
**26.0658**

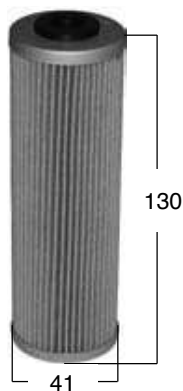

KTM

**26.8681**  
**26.0681**



Hyosung

**26.8682**  
**26.0682**

3/4"-16UNF

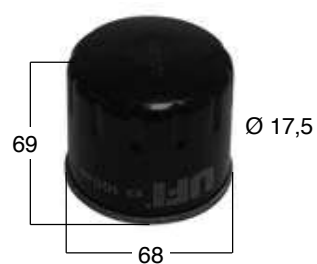

Hyosung · CF Moto

*N.B.: misure in millimetri.*

