



CAMPIONI 2019  
PRIMO LOGO

LeoVince  
RIDE. DOMINATE. ROAR.



ANONIMO  
WATCHES

LEOPARD

DOVIT

DAINESE

LEOPARD

DALLA

DAINESE

GOLDCAR

Leoline

ANONIMO  
WATCHES

LEOPARD  
NATURAL

DOVIT

MILNERSTAL  
PORTOPICCOLO

PADOCK  
ZONE 888  
HONDA

DID  
NGK  
Leoline  
GALFER

DUNLOP



LEOVINCE

# LV-10 TITANIUM



 **pass**



## RACING DNA

Sviluppato in collaborazione con il Reparto Corse LeoVince ed applicando l'esperienza maturata nei campionati Moto 2 e Moto 3, **LV-10 Titanium** esprime il massimo della tecnologia racing applicata ad un terminale di scarico destinato alle moto di serie. Il terminale ed il collettore sono realizzati utilizzando Titanio Grado 1, un materiale puro che oltre a garantire una riduzione di peso pari al 30% rispetto all'acciaio inox, possiede elevate caratteristiche di duttilità, robustezza e resistenza alla corrosione. Le saldature TIG, eseguite interamente a mano, esaltano la cura artigianale del prodotto rimarcandone il DNA racing.

- ✓ **Interamente realizzato in Titanio Grado 1**
- ✓ **Peso ridotto del 30% rispetto alla versione in acciaio inox**
- ✓ **Saldatura TIG**
- ✓ **Logo LeoVince marchiato al laser**
- ✓ **Staffa tagliata al laser**

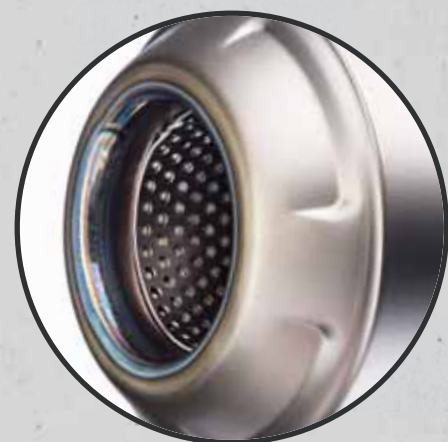

Disponibile per

BMW

HONDA

KAWASAKI

YAMAHA

LEOVINCE

# LV-10



ACCIAIO  
INOX

e pass



## BACK TO RACING

Con LV-10 in acciaio inox LeoVince ha sviluppato, grazie alla sua esperienza nelle competizioni internazionali, un silenziatore dalle dimensioni estremamente compatte per garantire la massima leggerezza, le migliori performance e l'inconfondibile suono racing di LeoVince. Interamente realizzato in acciaio inox AISI 304, lo scarico LV-10 ha una finitura opaca ed il logo LeoVince è marchiato al laser. La coppa finale sabbata è dotata di una speciale rete sul fondello di uscita per infondere al silenziatore un look estremamente racing.

- ✓ Acciaio inox AISI 304
- ✓ Coppa finale sabbata
- ✓ Finitura opaca
- ✓ Rete frangifiamme sul fondello di uscita
- ✓ Logo LeoVince marchiato al laser
- ✓ Staffa tagliata al laser



Disponibile per

BENELLI

BMW

DUCATI

HONDA

HUSQVARNA

KAWASAKI

SUZUKI

YAMAHA

**LeoVince**  
RIDE. DOMINATE. RACE.

LEOVINCE

ACCIAIO  
INOX

e pass

# LV-10 BLACK EDITION



## RACING POWER

Il silenziatore LeoVince LV-10 BLACK EDITION, di derivazione racing, è contraddistinto dall'elegante finitura nera opaca realizzata utilizzando una speciale vernice a base ceramica resistente alle alte temperature e per la presenza del logo LeoVince marchiato al laser. La rete frangifiamme in acciaio inossidabile esalta l'aspetto racing della tua moto. L'interno del silenziatore viene riempito con della fibra di vetro resistente alle alte temperature (900°C), applicata mediante l'uso di un filato testurizzato e volumizzato che permette al materiale fonoassorbente di espandersi liberamente, senza che le fibre perdano integrità, garantendo miglior rendimento e massima durata.

- ✓ Acciaio inox AISI 304
- ✓ Verniciatura nera a base ceramica
- ✓ Coppa finale sabbiata
- ✓ Rete frangifiamme sul fondello di uscita
- ✓ Logo LeoVince marchiato al laser
- ✓ Staffa tagliata al laser



Disponibile per

BENELLI

BMW

DUCATI

HONDA

HUSQVARNA

KAWASAKI

SUZUKI

YAMAHA

LeoVince  
RIDE. DOMINATE. ROAD.

LEOVINCE

# CLASSIC RACER

ACCIAIO  
INOX

e pass



## CAFÈ RACER

Con il **CLASSIC RACER** LeoVince ha dato vita ad un prodotto esclusivo che ben si adatta allo stile Urban Racer moderno. **CLASSIC RACER** è un omaggio alla cultura caffè, con il suo stile "classic trumpet", che, unito ai materiali innovativi ed alla esperienza LeoVince, regala alla tua moto il suono retrò unico e inconfondibile.

- ✓ Acciaio inox AISI 304
- ✓ Coppa finale con finitura "scotch brite"
- ✓ Logo LeoVince in rilievo
- ✓ Sound Classico "Retrò"
- ✓ Facile installazione



Disponibile per

MOTO GUZZI

TRIUMPH

LEOVINCE

ACCIAIO  
INOX

# CLASSIC RACER

## BLACK EDITION



e pass



## STILE "VINTAGE"

Lo scarico **CLASSIC RACER BLACK EDITION** è completamente fabbricato in acciaio inox AISI 304, che ne garantisce la durata nel tempo. La nuova coppa d'uscita spazzolata e il logo LeoVince in rilievo danno al prodotto un classico stile Café. Omologato e facile da installare, il **CLASSIC RACER BLACK EDITION** è lo scarico ideale per riscoprire il fascino delle moto classiche senza rinunciare alla qualità LeoVince, nel pieno rispetto delle norme vigenti.

- ✓ Acciaio inox AISI 304
- ✓ Verniciatura nera a base ceramica
- ✓ Sound classico "Vintage"
- ✓ Coppa di uscita in acciaio inox spazzolato
- ✓ Logo LeoVince in rilievo



Disponibile per

HONDA

MOTO GUZZI

TRIUMPH



LEOVINCE



# GP DUALS

e pass



## TWICE THE SOUL

GP DUALS è il silenziatore LeoVince ispirato allo stile "GP", appositamente studiato per chi ama personalizzare la propria moto con un prodotto esclusivo. LeoVince ha sviluppato con materiali di altissima qualità uno scarico dal sound inconfondibile e dal design aggressivo.

- ✓ Acciaio inox AISI 304
- ✓ Verniciatura nera a base ceramica
- ✓ Finitura opaca
- ✓ Coppa finale sabbiata
- ✓ Logo LeoVince marchiato al laser



Disponibile per

BMW

DUCATI

HONDA

HUSQVARNA

KAWASAKI

SUZUKI

YAMAHA





LEOVINCE

# GP ONE



e pass



## RACING LOOK

Lo scarico **GP ONE** è il silenziatore LeoVince ispirato al mondo delle competizioni. Il design compatto è arricchito di preziosi elementi come la verniciatura a base ceramica, il logo LeoVince marchiato al laser e la coppa finale dal design moderno, dettagli dall'elevato contenuto tecnico che uniti ad un sound inconfondibile donano alla vostra moto un look estremamente racing.

- ✓ Acciaio inox AISI 304
- ✓ Verniciatura nera a base ceramica
- ✓ Finitura opaca
- ✓ Coppa finale sabbiata
- ✓ Logo LeoVince marchiato al laser
- ✓ Staffa tagliata al laser



Disponibile per

BENELLI

DUCATI

HONDA

HUSQVARNA

KTM



e pass

LEOVINCE

# LV PRO



ROAD



SCOOTER



ADVENTURE



## COMPACT POWER

Con la linea LV PRO LeoVince sintetizza look racing e compattezza. Figlio della ricerca dei migliori materiali e delle lavorazioni artigianali, LV PRO in fibra di carbonio presenta una nuova coppa "Shark Cut" aggressiva e dal look sportivo, che, combinata alle ridotte dimensioni, valorizza appieno l'estetica della tua moto.

- ✓ Corpo in "full carbon"
- ✓ Coppa finale "Shark Cut" in "full carbon"
- ✓ Finitura opaca
- ✓ Lane ad alta resistenza termica (900° C)
- ✓ Staffa di fissaggio regolabile in "full carbon"



Disponibile per

DUCATI

HONDA

KAWASAKI

KTM

SUZUKI

YAMAHA



e pass

LEOVINCE

# LV PRO



## COMPACT POWER

Con la linea LV PRO LeoVince sintetizza look racing e compattezza. Figlio della ricerca dei migliori materiali e delle lavorazioni artigianali, LV PRO in acciaio inox presenta una nuova coppa "Shark Cut" aggressiva e dal look sportivo, che, combinata alle ridotte dimensioni, valorizza appieno l'estetica della tua moto.

- ✓ Corpo in acciaio inox AISI 304
- ✓ Coppa finale "Shark Cut" in "full carbon"
- ✓ Lane ad alta resistenza termica (900° C)
- ✓ Staffa di fissaggio regolabile in "full carbon"
- ✓ Logo LeoVince marchiato al laser



Disponibile per

DUCATI

HONDA

KAWASAKI

KTM

KYMCO

SUZUKI

YAMAHA



LEOVINCE

# LV ONE EVO

e pass



## TRADIZIONE E INNOVAZIONE

LeoVince LV ONE EVO in fibra di carbonio è la sintesi tra tradizione e modernità. Coniuga lo stile classico del look LeoVince con l'innovazione nella ricerca dei materiali più performanti e leggeri.

- ✓ Due strati di carbonio pre-impregnato
- ✓ Coppa finale in "full carbon"
- ✓ Finitura opaca
- ✓ Lane ad alta resistenza termica (900° C)
- ✓ Staffa di fissaggio regolabile in "full carbon"

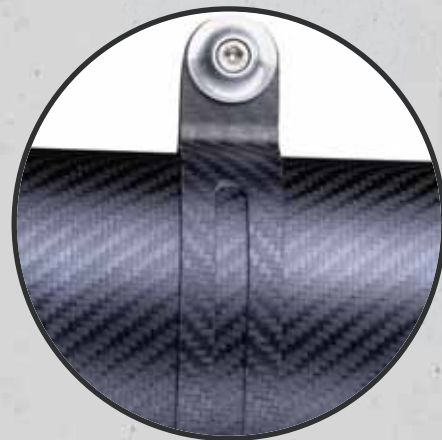

Disponibile per

BMW

DUCATI

HONDA

KAWASAKI

KTM

SUZUKI

TRIUMPH

YAMAHA



e pass

LEOVINCE

# LV ONE EVO



## TRADIZIONE E INNOVAZIONE

LV ONE EVO in acciaio inox è la sintesi tra tradizione e modernità. Coniuga lo stile classico LeoVince nel look e l'innovazione nella ricerca dei materiali più performanti e leggeri.

- ✓ Acciaio inox AISI 304
- ✓ Coppa finale in "full carbon"
- ✓ Lane ad alta resistenza termica (900° C)
- ✓ Staffa di fissaggio regolabile in "full carbon"
- ✓ Logo LeoVince marchiato al laser



Disponibile per

APRILIA	BENELLI	BMW	DUCATI	GILERA	HONDA	HUSQVARNA	KAWASAKI
KTM	MBK	PEUGEOT	PIAGGIO	SUZUKI	SYM	TRIUMPH	VESPA
							YAMAHA



LEOVINCE

# FACTORY S

e pass



## RACING ATTITUDE

Spirito italiano e anima guerriera. Il tutto unito a un look dark. Il terminale LeoVince **FACTORY S** in carbonio è l'essenza della ricerca LeoVince, che adatta il know-how sviluppato nelle competizioni ad ogni modello a cui **FACTORY S** è destinato.

- ✓ Forma conica
- ✓ Due strati di carbonio pre-impregnato
- ✓ Finitura opaca
- ✓ Coppa finale in "full carbon"
- ✓ Lane ad alta resistenza termica (900° C)
- ✓ Staffa di fissaggio regolabile in "full carbon"

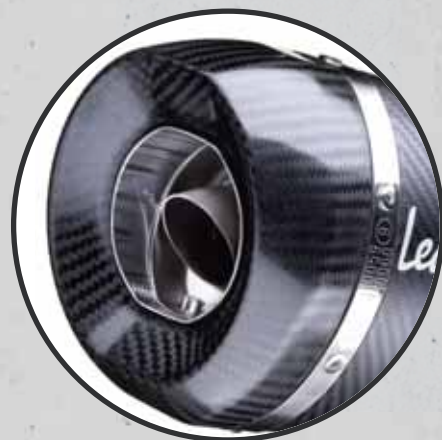

Disponibile per\*

APRILIA

BMW

HONDA

KAWASAKI

KTM

SUZUKI

TRIUMPH

YAMAHA

LEOVINCE

ACCIAIO  
INOX

e pass

# FACTORY S



## STAINLESS PASSION

Spirito italiano e anima guerriera. Il tutto unito ad un titanium look. Il terminale LeoVince **FACTORY S** in acciaio inox è l'essenza della ricerca LeoVince, che adatta il know-how sviluppato nelle competizioni ad ogni modello a cui **FACTORY S** è destinato.

- ✓ **Forma conica**
- ✓ **Acciaio inox AISI 304**
- ✓ **Coppa finale in "full carbon"**
- ✓ **Lane ad alta resistenza termica (900° C)**
- ✓ **Staffa di fissaggio regolabile in "full carbon"**
- ✓ **Logo LeoVince marchiato al laser**



Disponibile per

APRILIA

BMW

HONDA

KAWASAKI

KTM

KYMCO

SUZUKI

TRIUMPH

YAMAHA

LEOVINCE

ACCIAIO  
INOX

e pass



# GP STYLE



## FROM MOTOGP WITH LOVE

Il design della linea GP STYLE è frutto dell'esperienza maturata da LeoVince con i maggiori team della classe MotoGP, e rappresenta il corretto equilibrio tra look, prestazioni e prezzo, per chi desidera personalizzare la propria moto intervenendo velocemente e con poche modifiche, nel pieno rispetto del codice della strada.

- ✓ Acciaio inox AISI 304
- ✓ Staffa di fissaggio in "full carbon"
- ✓ Sabbiatura rivestimento e coppa con graniglia in acciaio inox per un "Titanium Look"
- ✓ Lane ad alta resistenza termica (900° C)
- ✓ Logo LeoVince marchiato al laser



Disponibile per

DUCATI

KAWASAKI

KTM

SUZUKI

TRIUMPH

YAMAHA



LEOVINCE

ACCIAIO  
INOX

e pass

# GP STYLE

## BLACK EDITION



### FROM MOTOGP WITH DARK LOVE

Con la **BLACK EDITION**, vesti di dark la tua moto. LeoVince introduce un meraviglioso nero, con una finitura opaca, realizzato con una verniciatura a base ceramica resistente alle alte temperature. Il design della linea **GP STYLE BLACK EDITION** è frutto dell'esperienza maturata da LeoVince con i maggiori team della classe MotoGP, e rappresenta il corretto equilibrio tra look, prestazioni e prezzo.

- ✓ Acciaio inox AISI 304
- ✓ Staffa di fissaggio in "full carbon"
- ✓ Verniciatura nera opaca a base ceramica
- ✓ Lane ad alta resistenza termica (900° C)
- ✓ Logo LeoVince marchiato al laser



Disponibile per

DUCATI

KAWASAKI

KTM

SUZUKI

TRIUMPH

YAMAHA

LEOVINCE

# GP CORSA

CARBONIO

RACING



## SLASH CUT

I terminali LeoVince **GP CORSA** rappresentano il perfetto equilibrio tra look, prestazioni e prezzo per i motocicli fino a 500cc 4 tempi. Ispirandosi all'esperienza LeoVince in MotoGP, il design riprende il taglio Slash Cut comune agli scarichi della classe regina. Ad impreziosire il silenziatore, è stato applicato il logo LeoVince in alluminio che esalta il design italiano del prodotto.

- ✓ Doppio strato di carbonio pre-impregnato
- ✓ Staffa di fissaggio in acciaio inox con protezione in gomma
- ✓ Coppa finale con taglio "Slash Cut"
- ✓ Finitura lucida



Disponibile per

HONDA

KAWASAKI

SUZUKI

YAMAHA

LEOVINCE

CARBONIO

RACING

# GP CORSA EVO



## MATTE CARBON

I terminali LeoVince GP CORSA EVO rappresentano il perfetto equilibrio tra look, prestazioni e prezzo per i motocicli fino a 500cc 4 tempi. Ispirandosi all'esperienza in MotoGP, LeoVince ha sviluppato il design del silenziatore in full carbon con finitura opaca e coppa posteriore in tecnopolimero. Ad impreziosire il silenziatore, è stato applicato il logo LeoVince in alluminio che esalta il design italiano del prodotto.

- ✓ Doppio strato di carbonio pre-impregnato
- ✓ Coppa finale in tecnopolimero ad alta resistenza
- ✓ Staffa di fissaggio in acciaio inox con protezione in gomma
- ✓ Finitura opaca

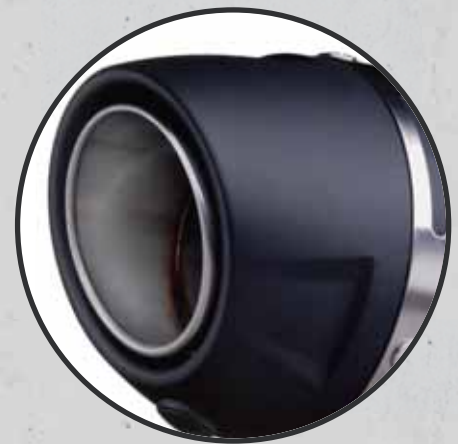

Disponibile per

HONDA

KAWASAKI

SUZUKI

YAMAHA

LEOVINCE

# UNDERBODY

ACCIAIO  
INOX

e pass



## SOTTOMOTORE, SOPRA LE RIGHE

LeoVince **UNDERBODY** è stato concepito per portare in primo piano la struttura di ogni moto. LeoVince **UNDERBODY** viene collocato sotto il basamento, con la bocca di uscita verso l'esterno, così da ottimizzare la distribuzione dei pesi e sfruttare al massimo il baricentro della moto.

- ✓ Acciaio inox AISI 304
- ✓ Coppa finale in "full carbon"
- ✓ Lane ad alta resistenza termica (900° C)
- ✓ Logo LeoVince marchiato al laser
- ✓ Mantiene l'originale distribuzione dei pesi sulla moto



Disponibile per

KAWASAKI

KTM

YAMAHA



LEOVINCE

# NERO

e pass



## JOIN THE DARK SIDE

Stile aggressivo e linee decise. LeoVince **NERO** è il nuovo silenziatore adatto a moto e maxi-scooter dal look dark e moderno, frutto della incessante ricerca LeoVince su acciai di qualità e lavorazioni esclusive.

- ✓ Rivestimento e staffa in acciaio inox AISI 304
- ✓ Coppa finale in "full carbon"
- ✓ Verniciatura nera a base ceramica
- ✓ Finitura opaca
- ✓ Logo LeoVince marchiato al laser



Disponibile per

BMW	DUCATI	HONDA	KAWASAKI	KTM	KYMCO	PEUGEOT	PIAGGIO
SUZUKI	TRIUMPH	YAMAHA					



LEOVINCE



# GRANTURISMO

e pass



## MAXI-SCOOTER TAILOR MADE

All'insegna di un'italianità tutta ricercata, LeoVince ha realizzato con il **GRANTURISMO** un nuovo prodotto dal carattere sportivo, competitivo e assolutamente inedito. Il binomio silenziatore e collettore **GRANTURISMO** rappresenta infatti una sintesi perfetta tra design innovativo, resistenza e durata nel tempo.

- ✓ **Corpo e carter para-calore realizzati in acciaio inox AISI 304**
- ✓ **Sabbiatura superficiale con graniglia in acciaio inox per un "Titanium Look"**
- ✓ **Progettato a camere meccaniche e con lane ad alta resistenza termica (900 °C)**
- ✓ **Staffa di fissaggio in acciaio inox con protezione in gomma**



Disponibile per

GILERA	HONDA	KAWASAKI	KYMCO	MBK	PEUGEOT	PIAGGIO	SUZUKI
VESPA	YAMAHA						

LEOVINCE

ACCIAIO  
INOX

# GRANTURISMO

## BLACK EDITION



e pass



## ANIMA E CORPO

Il corpo silenziante della **GRAN TURISMO BLACK EDITION** è ricoperto da uno scudo termico in acciaio inossidabile rifinito con verniciatura nera opaca a base ceramica ed il logo LeoVince marchiato al laser. Questa soluzione, oltre a conferire un look eccezionale al silenziatore, lo protegge dall'usura e dal surriscaldamento, garantendo al tuo maxi-scooter migliori prestazioni.

- ✔ **Corpo e carter para-calore realizzati in acciaio inox AISI 304**
- ✔ **Verniciatura nera a base ceramica**
- ✔ **Finitura opaca**
- ✔ **Progettato a camere meccaniche e con lane ad alta resistenza termica (900 °C)**
- ✔ **Logo LeoVince marchiato al laser**

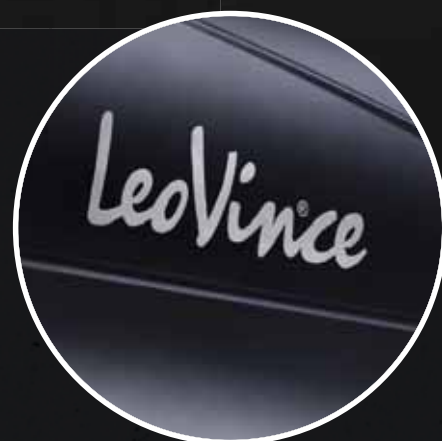

Disponibile per

GILERA

HONDA

KAWASAKI

KYMCO

MBK

PEUGEOT

PIAGGIO

SUZUKI

VESPA

YAMAHA

**LeoVince**  
RIDE. DOMINATE. ROAD.



LEOVINCE

X3



e pass



## SON OF MUD

LeoVince è da sempre presente nel mondo off-road con i suoi prodotti ed i terminali enduro della linea LeoVince X3 sfruttano la tecnologia e il know-how degli impianti completi acquisiti nelle competizioni.

- ✔ **Struttura interna semi-diretta a camere**
- ✔ **Involucro in alluminio ad alta resistenza**
- ✔ **Staffa di fissaggio in "full carbon"**
- ✔ **Logo LeoVince marchiato al laser**



Disponibile per

BMW

KAWASAKI

KTM

SUZUKI

YAMAHA





ALLUMINIO

e pass

LEOVINCE

# HAND MADE TT



## DESIGN E QUALITÀ PER IL TUO SCOOTER

Nato dall'esperienza nel mondo degli scooter, LeoVince **HAND MADE TT** rappresenta il primo livello dell'ampia gamma di scarichi sportivi che abbina prestazioni e design ad un prezzo contenuto.

- ✓ **Camera ad espansione in acciaio con verniciatura trasparente**
- ✓ **Silenziatore in inox con rivestimento in alluminio**
- ✓ **Saldature a TIG realizzate a mano**
- ✓ **Rulli e molle per variatore inclusi**  
\*quando indicato nel manuale utente
- ✓ **Progettato per migliorare le prestazioni dei motori 2 tempi**



Disponibile per

APRILIA	CPI	EXPLORER	GENERIC	GILERA	KEEWAY	KYMCO	MALAGUTI
MBK	PEUGEOT	PIAGGIO	QJ	RIDE	YAMAHA		



LEOVINCE



# HAND MADE TT

## BLACK EDITION

e pass



### ACCIAIO E ALLUMINIO

Lo scarico **HAND MADE TT BLACK EDITION**, omologato CE, è dotato di un'espansione realizzata in acciaio 10/10 mm con architettura di tipo "aperto" a doppia camera, combinata con un silenziatore di forma rotonda realizzato in acciaio con verniciatura nera opaca a base ceramica ed il logo Leovince marchiato al laser. Se specificato nel manuale utente, viene fornito in confezione un apposito kit di molle e rulli per ottenere il miglior rendimento del variatore, combinando le caratteristiche dello scarico con quelle del motore per il quale è stato sviluppato.



- ✓ **Camera ad espansione in acciaio con verniciatura trasparente**
- ✓ **Silenziatore in inox con rivestimento in alluminio**
- ✓ **Sviluppato per migliorare il rendimento dei motori 2 tempi**
- ✓ **Verniciatura nera a base ceramica**
- ✓ **Rulli e molle per variatore inclusi**  
\*quando indicato nel manuale utente
- ✓ **Finitura opaca**

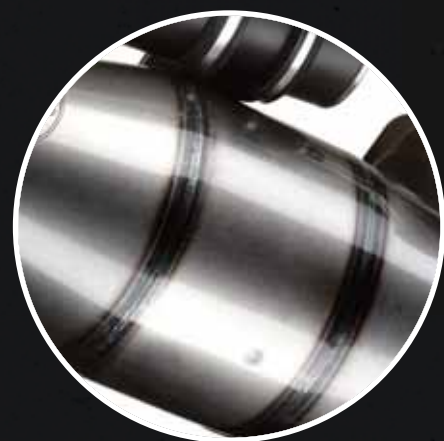

Disponibile per

APRILIA	CPI	EXPLORER	GENERIC	GILERA	KEEWAY	KYMCO	MALAGUTI
MBK	PEUGEOT	PIAGGIO	QJ	RIDE	YAMAHA		



e pass

LEOVINCE

# X-FIGHT



## 50CC, STRADA E FUORI

Per tutti i motori due tempi 50cc a marce destinati all'off-road ed all'utilizzo stradale, LeoVince ha sviluppato la nuova X-FIGHT, un impianto omologato CE, perfetto per tutti coloro che vorranno ottimizzare le prestazioni del proprio mezzo personalizzandolo con un scarico dallo stile nuovo ed aggressivo.

- ✓ Camera ad espansione in acciaio con verniciatura trasparente
- ✓ Silenziatore in inox con rivestimento in alluminio
- ✓ Saldature a TIG realizzate a mano
- ✓ Staffa di fissaggio in "full carbon"
- ✓ Logo LeoVince marchiato al laser



Disponibile per

APRILIA

BETA

DERBI

GILERA

HM

MBK

RIEJU

YAMAHA

LEOVINCE

ACCIAIO  
INOX

e pass

# X-FIGHT

## BLACK EDITION



## REALIZZATO A MANO IN ACCIAIO INOX

Prodotto a mano con cura artigianale, lo scarico X-FIGHT BLACK EDITION è interamente realizzato in acciaio inox con saldature TIG, verniciatura nera opaca a base ceramica resistente alle alte temperature ed il logo LeoVince marchiato al laser. L'impiego delle fascette ed i rivetti per l'assemblaggio del silenziatore richiama il design degli scarichi LeoVince destinati ai modelli fuoristrada. Il terminale viene fissato al telaio tramite una fascetta in fibra di carbonio che garantisce una formidabile resistenza contro le sollecitazioni meccaniche ed un notevole risparmio di peso.



- ✓ Camera ad espansione in acciaio con verniciatura trasparente
- ✓ Silenziatore in inox con rivestimento in alluminio
- ✓ Verniciatura nera a base ceramica
- ✓ Finitura opaca
- ✓ Staffa di fissaggio in "full carbon"
- ✓ Logo LeoVince marchiato al laser



Disponibile per

APRILIA

BETA

DERBI

GILERA

HM

MBK

RIEJU

YAMAHA

LeoVince  
RIDE. DOMINATE. RAR.



e pass

LEOVINCE

# LV ONE



## CUORE IN CARBONIO

Con la linea di terminali LV ONE, LeoVince prosegue la tradizione nella gamma di prodotti SBK. Stile, materiali, durata nel tempo sono i temi sviluppati dai tecnici LeoVince, che dalle precedenti serie di silenziatori hanno mantenuto il concetto di prestazioni a norma di legge, estrapolando le soluzioni tecniche per ottenere una linea di prodotti innovativa e d'avanguardia.

- ✓ **Corpo in "full carbon"**
- ✓ **Finitura opaca**
- ✓ **Coppa finale in tecnopolimero ad alta resistenza**
- ✓ **Lane ad alta resistenza termica (900 °C)**
- ✓ **Staffa di fissaggio in "full carbon"**

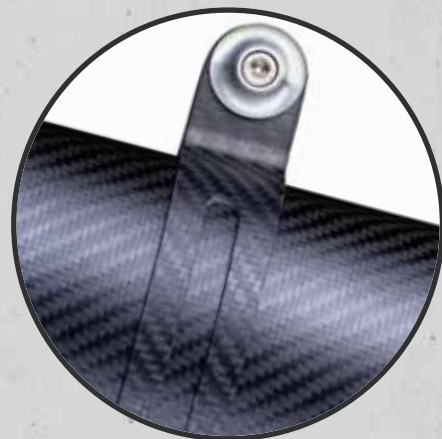

Disponibile per

HONDA

YAMAHA

LEOVINCE

# LV ONE

ACCIAIO  
INOX

e pass



## CUORE IN ACCIAIO INOX

Con la linea di terminali LV ONE, LeoVince prosegue la tradizione nella gamma di prodotti SBK. Stile, materiali, durata nel tempo sono i temi sviluppati dai tecnici LeoVince, che dalle precedenti serie di silenziatori hanno mantenuto il concetto di prestazioni a norma di legge, estrapolando le soluzioni tecniche per ottenere una linea di prodotti innovativa e d'avanguardia.

- ✓ Corpo in acciaio inox AISI 304
- ✓ Coppa finale in tecnopolimero ad alta resistenza
- ✓ Lane ad alta resistenza termica (900° C)
- ✓ Staffa di fissaggio in "full carbon"
- ✓ Logo LeoVince marchiato al laser



Disponibile per

HONDA

KTM

YAMAHA



LEOVINCE



# SILVERTAIL K02

e pass

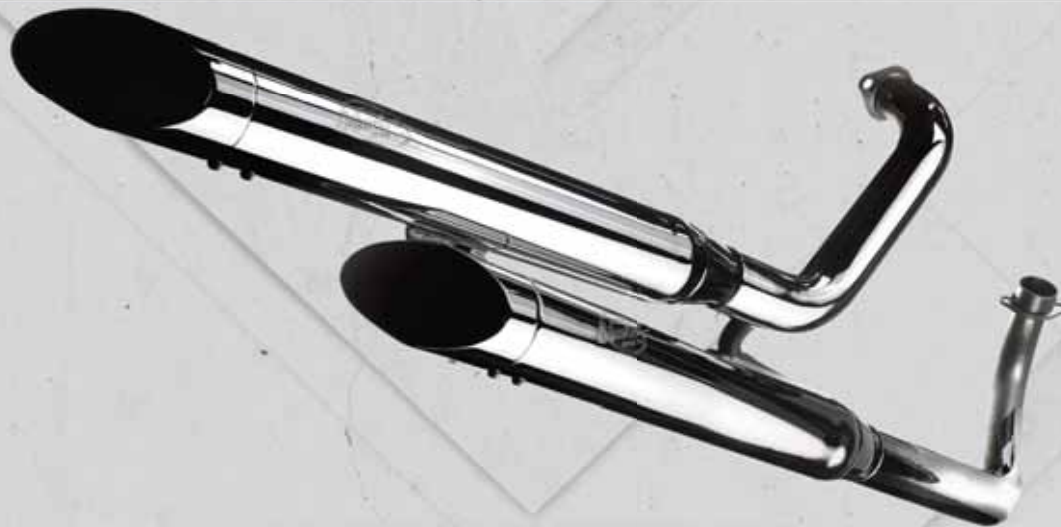

## STILE E PERFORMANCE

Tutti gli impianti **SILVERTAIL** sono realizzati in acciaio, con copri carter cromato. La finitura viene realizzata mediante un processo di cromatura computerizzato, deponendo uno strato di cinque micron di cromo e di cinquanta micron di nickel, per garantire la qualità nel tempo. **SILVERTAIL** dà un'interpretazione ancora più ampia del mondo "custom", inteso come prodotto di design ma con elevate prestazioni. Con la linea custom, **SILVERTAIL** porta in Europa lo stile USA delle "metric cruisers"

- ✓ Realizzato in acciaio cromato
- ✓ Interno del silenziatore smontabile
- ✓ Carter para-calore cromati



Disponibile per

HONDA

HYOSUNG

KAWASAKI

SUZUKI

YAMAHA

LEOVINCE



ACCIAIO

e pass

# TOURING



## UN GRANDE CLASSICO

LeoVince **TOURING** è una delle più complete gamme di scarichi mai realizzate per il settore scooter. Un grande classico, grazie al design futurista e sempre pratico, grazie al carter para-calore in materiale plastico ed allo stile moderno.

- ✓ **Struttura conica ad espansione**
- ✓ **Carter di protezione in nylon PA66**
- ✓ **Corpo d'espansione in acciaio 10/10**
- ✓ **Vernice nera opaca ad alta resistenza termica**



Disponibile per

APRILIA

GILERA

KYMCO

MALAGUTI

MBK

PEUGEOT

PIAGGIO

VESPA

YAMAHA





e pass

SITO

# SITO



## TWIN CHAMBER

SITO è una linea di marmitte di ricambio del tutto simile alle originali, ma costruite con i materiali e la qualità Sito.

- ✓ Silenziatore di ricambio in acciaio realizzato con la riconosciuta qualità SITO
- ✓ Vernice nera opaca ad alta resistenza termica
- ✓ Carter para-calore in nylon PA66



Disponibile per

APRILIA	BAOTIAN	BENELLI	CPI	DERBI	EXPLORER	GENERIC	GILERA
HONDA	KEEWAY	KYMCO	MALAGUTI	MBK	PEUGEOT	PIAGGIO	QINGQI
QJ	REX MOTO	RIDE	ROOK	SUKIDA	SUZUKI	VESPA	YAMAHA



e pass

SITO

# SITOPPLUS



## RENDIMENTO SUPERIORE

SITOPPLUS è la linea di impianti destinati ai ciclomotori ed agli scooter più venduti in Europa che, pur essendo esteticamente identici a quelli montati all'origine, sono totalmente riprogettati nella struttura interna e garantiscono ai motori un rendimento superiore, soprattutto ai regimi medio-bassi.

- ✓ Silenziatore di ricambio in acciaio per massime prestazioni
- ✓ Look delle marmitte originali
- ✓ Carter para-calore in nylon PA66
- ✓ Trattamento di verniciatura elettrostatico resistente alle alte temperature



Disponibile per

APRILIA	BETA	GILERA	HONDA	ITALJET	LML	MALAGUTI	MBK
PEUGEOT	PIAGGIO	TOMOS	VESPA	YAMAHA			

LEOVINCE

# KIT SILENZIATORI UNIVERSALI



## CUSTOMIZZA LA TUA MOTO

LeoVince ha creato una speciale gamma di silenziatori universali dedicati a soddisfare le esigenze dei migliori preparatori ma anche degli appassionati che desiderano **customizzare la propria special**.

Il kit silenziatore, disponibile in diverse forme, finiture e diametri, viene fornito senza collettore di raccordo ma completo di staffa e kit minuteria.

- ✓ Disponibile in diversi diametri
- ✓ Staffa e kit minuteria incluse nel kit
- ✓ Collettore di raccordo non fornito
- ✓ Provvisto di adesivo LeoVince resistente ad alte temperature







## Indice

APRILIA	3
BAOTIAN	5
BENELLI	6
BETA	6
BMW	6
CPI	9
DERBI	9
DUCATI	10
EXPLORER	11
GENERIC	12
GILERA	12
HM	14
HONDA	14
HUSQVARNA	23
HYOSUNG	24
ITALJET	24
KAWASAKI	24
KEEWAY	31
KTM	31
KYMCO	35
LML	38
MALAGUTI	39
MBK	39
MOTO GUZZI	41
PEUGEOT	41
PIAGGIO	44
QINGQI	49
QJ	50
REX MOTO	50
RIDE	50
RIEJU	50
ROOK	50
SUKIDA	51
SUZUKI	51
SYM	55
TOMOS	55
TRIUMPH	56
VESPA	57
YAMAHA	61
ELENCO ARTICOLI PER CODICE E RICAMBI	73
RICAMBI E ACCESSORI	194
SCHEMA PESI PER KIT RULLI	199

## ELENCO ARTICOLI PER CASA COSTRUTTRICE

### OMOLOGAZIONI

e-approved	Dispositivo di scarico omologato secondo la direttiva EC 97/24 cap.9 relativa al rumore. Verificare l'eventuale disponibilità del catalizzatore al fine di rispettare la direttiva EC 97/24 cap.5 relativa alle emissioni inquinanti.
e*-approved	Dispositivo di scarico omologato secondo la direttiva EC 97/24 cap.9 relativa al rumore. Soddisfa anche la direttiva EC 97/24 cap.5 in quanto mantiene il catalizzatore originale.
ECE-Approved	Dispositivo di scarico omologato secondo la direttiva ECE-R92 relativa al rumore. Soddisfa anche la direttiva EU 134/2014 in quanto mantiene il catalizzatore originale.
EU-Approved	Componente omologato secondo la direttiva EU 134/2014 relativa alle emissioni inquinanti.
ECE/EU-Approved	Il dispositivo di scarico è omologato secondo la direttiva ECE-R92 relativa al rumore ed alla direttiva EU 134/2014 riguardante le emissioni inquinanti.
EC-Approved	Componente omologato secondo la direttiva EC 97/24 cap.5 relativa alle emissioni inquinanti.
Db (A) Compliant	Ai fini della validità dell'omologazione secondo le direttive ECE-R92 ed EU 134/2014 relative a rumore ed emissioni inquinanti è richiesta l'installazione del raccordo catalizzato opzionale.
Racing use only	Componente destinato esclusivamente ad uso agonistico utilizzabile solo in pista, circuiti privati o delimitati e su strade chiuse al traffico.

### CONFIGURAZIONE

SLIP-ON	= silenziatore completo di tubo di raccordo al collettore originale
FULL SYSTEM	= impianto completo di collettori primari

### MATERIALI

CARBON FIBER = CARBONIO

STAINLESS STEEL = ACCIAIO INOX

TECHNOPOLYMER TECNO-POLIMERO

ALUMINUM = ALLUMINIO

STEEL = ACCIAIO

CC. MODELLO	ANNO									
50 HABANA 50 KAT	1999-2003									
GAMMA	LINEA	TIPO	MATERIALE	COPPA	STANDARD	TYPE	HOM.	2T/4T	ART.	
SITO	SITO	FULL SYSTEM	STEEL	N/A			e-approved	2T	<b>0594</b>	
50 MOJITO 50	2004-									
GAMMA	LINEA	TIPO	MATERIALE	COPPA	STANDARD	TYPE	HOM.	2T/4T	ART.	
SITO	SITOPPLUS	FULL SYSTEM	STEEL	N/A			e-approved	2T	<b>0264</b>	
50 RALLY air/liquid cooled	-									
GAMMA	LINEA	TIPO	MATERIALE	COPPA	STANDARD	TYPE	HOM.	2T/4T	ART.	
SITO	SITOPPLUS	FULL SYSTEM	STEEL	N/A			e-approved	2T	<b>0571</b>	
50 RS4 50	2011-2013									
GAMMA	LINEA	TIPO	MATERIALE	COPPA	STANDARD	TYPE	HOM.	2T/4T	ART.	
LEOVINCE	X-FIGHT	FULL SYSTEM	STAINLESS STEEL	N/A			e-approved	2T	<b>3278</b>	
LEOVINCE	X-FIGHT BLACK	FULL SYSTEM	STAINLESS STEEL	N/A			e-approved	2T	<b>3278B</b>	
50 RX 50 (perimeter frame)	2005-2015									
GAMMA	LINEA	TIPO	MATERIALE	COPPA	STANDARD	TYPE	HOM.	2T/4T	ART.	
LEOVINCE	X-FIGHT	FULL SYSTEM	STAINLESS STEEL	N/A		PV	e-approved	2T	<b>3280</b>	
LEOVINCE	X-FIGHT BLACK	FULL SYSTEM	STAINLESS STEEL	N/A			e-approved	2T	<b>3280B</b>	
50 SCARABEO 50	1993-1997									
GAMMA	LINEA	TIPO	MATERIALE	COPPA	STANDARD	TYPE	HOM.	2T/4T	ART.	
SITO	SITOPPLUS	FULL SYSTEM	STEEL	N/A			e-approved	2T	<b>0573</b>	
50 SCARABEO 50 (rear brake rotor)	1998-									
GAMMA	LINEA	TIPO	MATERIALE	COPPA	STANDARD	TYPE	HOM.	2T/4T	ART.	
SITO	SITOPPLUS	FULL SYSTEM	STEEL	N/A			e-approved	2T	<b>0575</b>	
50 SCARABEO 50 STREET air cooled Piaggio engine	2006-2007									
GAMMA	LINEA	TIPO	MATERIALE	COPPA	STANDARD	TYPE	HOM.	2T/4T	ART.	
LEOVINCE	TOURING	FULL SYSTEM	STEEL	N/A			e-approved	2T	<b>5565</b>	
SITO	SITO	FULL SYSTEM	STEEL	N/A			e-approved	2T	<b>0586</b>	
50 SR 50 horizontal cylinder air/liquid cooled	1997-2002									
GAMMA	LINEA	TIPO	MATERIALE	COPPA	STANDARD	TYPE	HOM.	2T/4T	ART.	
SITO	SITOPPLUS	FULL SYSTEM	STEEL	N/A			e-approved	2T	<b>0571</b>	
50 SR 50 MOTARD 2 stroke	2012-									
GAMMA	LINEA	TIPO	MATERIALE	COPPA	STANDARD	TYPE	HOM.	2T/4T	ART.	
LEOVINCE	HAND MADE TT	FULL SYSTEM	ALUMINUM	N/A			e-approved	2T	<b>4065</b>	
LEOVINCE	HAND MADE TT BLACK	FULL SYSTEM	ALUMINUM	N/A			e-approved	2T	<b>4065B</b>	
LEOVINCE	TOURING	FULL SYSTEM	STEEL	N/A			e-approved	2T	<b>5565</b>	
SITO	SITOPPLUS	FULL SYSTEM	STEEL	N/A			e-approved	2T	<b>0579</b>	
50 SR 50 NETSCAPER air cooled	1997-2000									
GAMMA	LINEA	TIPO	MATERIALE	COPPA	STANDARD	TYPE	HOM.	2T/4T	ART.	
SITO	SITOPPLUS	FULL SYSTEM	STEEL	N/A			e-approved	2T	<b>0571</b>	

CC.	MODELLO	ANNO								
50	SR 50 R FACTORY carburetor Piaggio engine	2004-2012								
	GAMMA	LINEA	TIPO	MATERIALE	COPPA	STANDARD	TYPE	HOM.	2T/4T	ART.
	LEOVINCE	HAND MADE TT	FULL SYSTEM	ALUMINUM	N/A			e-approved	2T	4075
	LEOVINCE	HAND MADE TT BLACK	FULL SYSTEM	ALUMINUM	N/A			e-approved	2T	4075B
50	SR 50 R FACTORY i.e. (Di-tech engine, liquid cooled)	2005-								
	GAMMA	LINEA	TIPO	MATERIALE	COPPA	STANDARD	TYPE	HOM.	2T/4T	ART.
	SITO	SITO	FULL SYSTEM	STEEL	N/A			e-approved	2T	0712
50	SR 50 R FACTORY Piaggio engine	2004-2012								
	GAMMA	LINEA	TIPO	MATERIALE	COPPA	STANDARD	TYPE	HOM.	2T/4T	ART.
	LEOVINCE	TOURING	FULL SYSTEM	STEEL	N/A			e-approved	2T	7447
	SITO	SITO	FULL SYSTEM	STEEL	N/A			e-approved	2T	0732
50	SR 50 SPORT PRO injection Piaggio engine	2003-2004								
	GAMMA	LINEA	TIPO	MATERIALE	COPPA	STANDARD	TYPE	HOM.	2T/4T	ART.
	SITO	SITO	FULL SYSTEM	STEEL	N/A			e-approved	2T	0712
50	SR 50 SPORT PRO injection Piaggio engine	2003-								
	GAMMA	LINEA	TIPO	MATERIALE	COPPA	STANDARD	TYPE	HOM.	2T/4T	ART.
	LEOVINCE	HAND MADE TT	FULL SYSTEM	ALUMINUM	N/A			e-approved	2T	4075
	LEOVINCE	HAND MADE TT BLACK	FULL SYSTEM	ALUMINUM	N/A			e-approved	2T	4075B
50	SR 50 WWW air cooled	1997-2002								
	GAMMA	LINEA	TIPO	MATERIALE	COPPA	STANDARD	TYPE	HOM.	2T/4T	ART.
	SITO	SITOPPLUS	FULL SYSTEM	STEEL	N/A			e-approved	2T	0571
50	SR RACING liquid cooled	-								
	GAMMA	LINEA	TIPO	MATERIALE	COPPA	STANDARD	TYPE	HOM.	2T/4T	ART.
	SITO	SITOPPLUS	FULL SYSTEM	STEEL	N/A			e-approved	2T	0571
50	SR STEALTH horizontal cylinder liquid cooled	1998-2002								
	GAMMA	LINEA	TIPO	MATERIALE	COPPA	STANDARD	TYPE	HOM.	2T/4T	ART.
	SITO	SITOPPLUS	FULL SYSTEM	STEEL	N/A			e-approved	2T	0571
50	SR STEALTH/RACING horizontal cylinder liquid cooled	1998-2002								
	GAMMA	LINEA	TIPO	MATERIALE	COPPA	STANDARD	TYPE	HOM.	2T/4T	ART.
	LEOVINCE	HAND MADE TT	FULL SYSTEM	ALUMINUM	N/A			e-approved	2T	4039
	LEOVINCE	HAND MADE TT BLACK	FULL SYSTEM	ALUMINUM	N/A			e-approved	2T	4039B
50	SX 50 (perimeter frame)	2006-2015								
	GAMMA	LINEA	TIPO	MATERIALE	COPPA	STANDARD	TYPE	HOM.	2T/4T	ART.
	LEOVINCE	X-FIGHT	FULL SYSTEM	STAINLESS STEEL	N/A		PV	e-approved	2T	3280
	LEOVINCE	X-FIGHT BLACK	FULL SYSTEM	STAINLESS STEEL	N/A			e-approved	2T	3280B
125	RS4 125	2011-2016								
	GAMMA	LINEA	TIPO	MATERIALE	COPPA	STANDARD	TYPE	HOM.	2T/4T	ART.
	LEOVINCE	LV ONE EVO	SLIP-ON	STAINLESS STEEL	CARBON FIBER	EURO 3	TW	e-approved	4T	8712E



# APRILIA

CC. MODELLO		ANNO								
300 SR 300 MAX		2012-2015								
GAMMA	LINEA	TIPO	MATERIALE	COPPA	STANDARD	TYPE	HOM.	2T/4T	ART.	
LEOVINCE	LV ONE EVO	FULL SYSTEM 1/1	STAINLESS STEEL	CARBON FIBER	EURO 3		e-approved	4T	8489E	
850 SRV 850		2012-2016								
GAMMA	LINEA	TIPO	MATERIALE	COPPA	STANDARD	TYPE	HOM.	2T/4T	ART.	
LEOVINCE	LV ONE EVO	SLIP-ON	STAINLESS STEEL	CARBON FIBER	EURO 3		e-approved	4T	8565E	
1000 RSV4		2009-2015								
GAMMA	LINEA	TIPO	MATERIALE	COPPA	STANDARD	TYPE	HOM.	2T/4T	ART.	
LEOVINCE	FACTORY S	SLIP-ON	CARBON FIBER	CARBON FIBER	EURO 3		e-approved	4T	8438S	
LEOVINCE	FACTORY S	SLIP-ON	STAINLESS STEEL	CARBON FIBER	EURO 3		e-approved	4T	8439S	
1000 RSV4 FACTORY		2009-2011								
GAMMA	LINEA	TIPO	MATERIALE	COPPA	STANDARD	TYPE	HOM.	2T/4T	ART.	
LEOVINCE	FACTORY S	SLIP-ON	CARBON FIBER	CARBON FIBER	EURO 3	RKA00	e-approved	4T	8438S	
LEOVINCE	FACTORY S	SLIP-ON	STAINLESS STEEL	CARBON FIBER	EURO 3	RKA00	e-approved	4T	8439S	
1000 RSV4 FACTORY APRC SE		2011-2012								
GAMMA	LINEA	TIPO	MATERIALE	COPPA	STANDARD	TYPE	HOM.	2T/4T	ART.	
LEOVINCE	FACTORY S	SLIP-ON	CARBON FIBER	CARBON FIBER	EURO 3		e-approved	4T	8438S	
LEOVINCE	FACTORY S	SLIP-ON	STAINLESS STEEL	CARBON FIBER	EURO 3		e-approved	4T	8439S	
1000 RSV4 R		2009-2011								
GAMMA	LINEA	TIPO	MATERIALE	COPPA	STANDARD	TYPE	HOM.	2T/4T	ART.	
LEOVINCE	FACTORY S	SLIP-ON	CARBON FIBER	CARBON FIBER	EURO 3	RK000	e-approved	4T	8438S	
LEOVINCE	FACTORY S	SLIP-ON	STAINLESS STEEL	CARBON FIBER	EURO 3	RK000	e-approved	4T	8439S	
1000 TUONO V4 R/APRC		2009-2015								
GAMMA	LINEA	TIPO	MATERIALE	COPPA	STANDARD	TYPE	HOM.	2T/4T	ART.	
LEOVINCE	FACTORY S	SLIP-ON	CARBON FIBER	CARBON FIBER	EURO 3	TY	e-approved	4T	8438S	
LEOVINCE	FACTORY S	SLIP-ON	STAINLESS STEEL	CARBON FIBER	EURO 3	TY	e-approved	4T	8439S	

# BAOTIAN

CC. MODELLO		ANNO								
50 139QMB engine 4 stroke		2007-								
GAMMA	LINEA	TIPO	MATERIALE	COPPA	STANDARD	TYPE	HOM.	2T/4T	ART.	
LEOVINCE	LEOVINCE	FULL SYSTEM	STAINLESS STEEL	N/A			Not approved	4T	7470	
SITO	SITO	FULL SYSTEM	STEEL	N/A			Not approved	4T	0736	
50 REBEL 49 R12 - 139QMA engine 4 stroke		2007-								
GAMMA	LINEA	TIPO	MATERIALE	COPPA	STANDARD	TYPE	HOM.	2T/4T	ART.	
LEOVINCE	LEOVINCE	FULL SYSTEM	STAINLESS STEEL	N/A			Not approved	4T	7473	
SITO	SITO	FULL SYSTEM	STEEL	N/A		TY	e-approved	4T	0737	

## BENELLI

CC. MODELLO	ANNO									
50 BENELLI 491 RR liquid cooled	2003-									
GAMMA	LINEA	TIPO	MATERIALE	COPPA	STANDARD	TYPE	HOM.	2T/4T	ART.	
SITO	SITO	FULL SYSTEM	STEEL	N/A			e-approved	2T	<b>0587</b>	
50 BENELLI 491 ST air cooled	2003-2004									
GAMMA	LINEA	TIPO	MATERIALE	COPPA	STANDARD	TYPE	HOM.	2T/4T	ART.	
SITO	SITO	FULL SYSTEM	STEEL	N/A			e-approved	2T	<b>0587</b>	
500 TRK 502	2017-2018									
GAMMA	LINEA	TIPO	MATERIALE	COPPA	STANDARD	TYPE	HOM.	2T/4T	ART.	
LEOVINCE	LV ONE EVO	SLIP-ON	STAINLESS STEEL	CARBON FIBER	EURO 4	P16 var.0 var.0	ECE-Approved	4T	<b>14230E</b>	

## BETA

CC. MODELLO	ANNO									
50 RR 50 ENDURO	2012-									
GAMMA	LINEA	TIPO	MATERIALE	COPPA	STANDARD	TYPE	HOM.	2T/4T	ART.	
LEOVINCE	X-FIGHT	FULL SYSTEM	STAINLESS STEEL	N/A			e-approved	2T	<b>3259</b>	
LEOVINCE	X-FIGHT BLACK	FULL SYSTEM	STAINLESS STEEL	N/A			e-approved	2T	<b>3259B</b>	
50 TEMPO 50	1994-1998									
GAMMA	LINEA	TIPO	MATERIALE	COPPA	STANDARD	TYPE	HOM.	2T/4T	ART.	
SITO	SITOPPLUS	FULL SYSTEM	STEEL	N/A			TPSi approved	2T	<b>0556</b>	

## BMW

CC. MODELLO	ANNO									
650 G 650 GS (fits with original panniers)	2011-2016									
GAMMA	LINEA	TIPO	MATERIALE	COPPA	STANDARD	TYPE	HOM.	2T/4T	ART.	
LEOVINCE	LV ONE EVO	SLIP-ON	STAINLESS STEEL	CARBON FIBER	EURO 3	E650G	e-approved	4T	<b>8572E</b>	
650 G 650 GS SERTAO (fits with original panniers)	2012-2014									
GAMMA	LINEA	TIPO	MATERIALE	COPPA	STANDARD	TYPE	HOM.	2T/4T	ART.	
LEOVINCE	LV ONE EVO	SLIP-ON	STAINLESS STEEL	CARBON FIBER	EURO 3	E650G	e-approved	4T	<b>8572E</b>	
650 G 650 X-CHALLENGE	2007-2011									
GAMMA	LINEA	TIPO	MATERIALE	COPPA	STANDARD	TYPE	HOM.	2T/4T	ART.	
LEOVINCE	X3	SLIP-ON	ALUMINUM	N/A			e-approved	4T	<b>3606</b>	
650 G 650 X-COUNTRY	2007-2011									
GAMMA	LINEA	TIPO	MATERIALE	COPPA	STANDARD	TYPE	HOM.	2T/4T	ART.	
LEOVINCE	X3	SLIP-ON	ALUMINUM	N/A			e-approved	4T	<b>3606</b>	
650 G 650 X-MOTO	2007-2011									
GAMMA	LINEA	TIPO	MATERIALE	COPPA	STANDARD	TYPE	HOM.	2T/4T	ART.	
LEOVINCE	X3	SLIP-ON	ALUMINUM	N/A			e-approved	4T	<b>3606</b>	

CC. MODELLO		ANNO								
800 F 650 GS (fits with original panniers)		2008-2012								
GAMMA	LINEA	TIPO	MATERIALE	COPPA	STANDARD	TYPE	HOM.	2T/4T	ART.	
LEOVINCE	LV ONE EVO	SLIP-ON	STAINLESS STEEL	CARBON FIBER	EURO 3	WVB102 - E8GS	e*-approved	4T	8287E	
LEOVINCE	LV ONE EVO	SLIP-ON	CARBON FIBER	CARBON FIBER	EURO 3	WVB102 - E8GS	e*-approved	4T	8288E	
800 F 700 GS (fits with original panniers)		2013-2016								
GAMMA	LINEA	TIPO	MATERIALE	COPPA	STANDARD	TYPE	HOM.	2T/4T	ART.	
LEOVINCE	LV ONE EVO	SLIP-ON	STAINLESS STEEL	CARBON FIBER	EURO 3	E8GS	e*-approved	4T	8287E	
LEOVINCE	LV ONE EVO	SLIP-ON	CARBON FIBER	CARBON FIBER	EURO 3	E8GS	e*-approved	4T	8288E	
800 F 800 GS/ADVENTURE (fits with original panniers)		2008-2016								
GAMMA	LINEA	TIPO	MATERIALE	COPPA	STANDARD	TYPE	HOM.	2T/4T	ART.	
LEOVINCE	LV ONE EVO	SLIP-ON	STAINLESS STEEL	CARBON FIBER	EURO 3	WVB102 - E8GS	e*-approved	4T	8287E	
LEOVINCE	LV ONE EVO	SLIP-ON	CARBON FIBER	CARBON FIBER	EURO 3	WVB102 - E8GS	e*-approved	4T	8288E	
800 F 800 GT (fits with original panniers)		2013-2016								
GAMMA	LINEA	TIPO	MATERIALE	COPPA	STANDARD	TYPE	HOM.	2T/4T	ART.	
LEOVINCE	LV ONE EVO	SLIP-ON	STAINLESS STEEL	CARBON FIBER	EURO 3	E8ST	e*-approved	4T	8289E	
LEOVINCE	LV ONE EVO	SLIP-ON	CARBON FIBER	CARBON FIBER	EURO 3	E8ST	e*-approved	4T	8290E	
800 F 800 R (fits with original panniers)		2009-2016								
GAMMA	LINEA	TIPO	MATERIALE	COPPA	STANDARD	TYPE	HOM.	2T/4T	ART.	
LEOVINCE	LV ONE EVO	SLIP-ON	STAINLESS STEEL	CARBON FIBER	EURO 3	E8ST	e*-approved	4T	8289E	
LEOVINCE	LV ONE EVO	SLIP-ON	CARBON FIBER	CARBON FIBER	EURO 3	E8ST	e*-approved	4T	8290E	
1000 S 1000 RR		2009-2014								
GAMMA	LINEA	TIPO	MATERIALE	COPPA	STANDARD	TYPE	HOM.	2T/4T	ART.	
LEOVINCE	FACTORY S	FULL SYSTEM 4/2/1	CARBON FIBER	CARBON FIBER	EURO 3	K10	Racing use only	4T	8471S	
LEOVINCE	FACTORY S	FULL SYSTEM 4/2/1	STAINLESS STEEL	CARBON FIBER	EURO 3	K10	Racing use only	4T	8472S	
1000 S 1000 RR		2017-2018								
GAMMA	LINEA	TIPO	MATERIALE	COPPA	STANDARD	TYPE	HOM.	2T/4T	ART.	
LEOVINCE	FACTORY S	FULL SYSTEM 4/2/1	STAINLESS STEEL	CARBON FIBER	EURO 4	2R10 var.0D50 ver.AG	Racing use only	4T	14233S	
LEOVINCE	FACTORY S	FULL SYSTEM 4/2/1	CARBON FIBER	CARBON FIBER	EURO 4	2R10 var.0D50 ver.AG	Racing use only	4T	14234S	
LEOVINCE	LV-10	SLIP-ON	STAINLESS STEEL	STAINLESS STEEL	EURO 4	2R10 var.0D50 ver.AG	Racing use only	4T	15217	
LEOVINCE	LV-10 BLACK	SLIP-ON	STAINLESS STEEL	STAINLESS STEEL	EURO 4	2R10 var.0D50 ver.AG	Racing use only	4T	15217B	
1000 S 1000 XR (fits with original panniers)		2015-2016								
GAMMA	LINEA	TIPO	MATERIALE	COPPA	STANDARD	TYPE	HOM.	2T/4T	ART.	
LEOVINCE	FACTORY S	SLIP-ON	STAINLESS STEEL	CARBON FIBER	EURO 3	K10	e*-approved	4T	14140S	
LEOVINCE	FACTORY S	SLIP-ON	CARBON FIBER	CARBON FIBER	EURO 3	K10	e*-approved	4T	14141S	
1000 S 1000 XR (fits with original panniers)		2017-2018								
GAMMA	LINEA	TIPO	MATERIALE	COPPA	STANDARD	TYPE	HOM.	2T/4T	ART.	
LEOVINCE	FACTORY S	SLIP-ON	STAINLESS STEEL	CARBON FIBER	EURO 4	2X10 var.0D03 ver.A;AC	ECE-Approved	4T	14241S	
LEOVINCE	FACTORY S	SLIP-ON	CARBON FIBER	CARBON FIBER	EURO 4	2X10 var.0D03 ver.A;AC	ECE-Approved	4T	14242S	

CC. MODELLO			ANNO							
1170 R NINE T			2014-2016							
GAMMA	LINEA	TIPO	MATERIALE	COPPA	STANDARD	TYPE	HOM.	2T/4T	ART.	
LEOVINCE	GP DUALS	SLIP-ON	STAINLESS STEEL	STAINLESS STEEL	EURO 3	R1ST var.0A06 ver.A	e*-approved	4T	15100	
1170 R NINE T (HIGH)			2014-2016							
GAMMA	LINEA	TIPO	MATERIALE	COPPA	STANDARD	TYPE	HOM.	2T/4T	ART.	
LEOVINCE	GP DUALS	SLIP-ON	STAINLESS STEEL	STAINLESS STEEL	EURO 3	R1ST var.0A06 ver.A	e*-approved	4T	15112	
1200 R 1200 GS (fits with original panniers)			2010-2012							
GAMMA	LINEA	TIPO	MATERIALE	COPPA	STANDARD	TYPE	HOM.	2T/4T	ART.	
LEOVINCE	LV ONE EVO	SLIP-ON	STAINLESS STEEL	CARBON FIBER	EURO 3	R12	e*-approved	4T	8291E	
1200 R 1200 GS (fits with original panniers)			2013-2016							
GAMMA	LINEA	TIPO	MATERIALE	COPPA	STANDARD	TYPE	HOM.	2T/4T	ART.	
LEOVINCE	LV ONE EVO	SLIP-ON	STAINLESS STEEL	CARBON FIBER	EURO 3	R12W	e*-approved	4T	8786E	
LEOVINCE	LV ONE EVO	SLIP-ON	CARBON FIBER	CARBON FIBER	EURO 3	R12W	e*-approved	4T	8787E	
1200 R 1200 GS (fits with original panniers)			2017-2018							
GAMMA	LINEA	TIPO	MATERIALE	COPPA	STANDARD	TYPE	HOM.	2T/4T	ART.	
LEOVINCE	LV ONE EVO	SLIP-ON	STAINLESS STEEL	CARBON FIBER	EURO 4	1G12 var. 0A01 ver.A;AC -TYPE 1G12 var. 0A02 ver.A;AC -TYPE 1G12 var. 0A51 ver.A;AC;AF	ECE-Approved	4T	14216E	
LEOVINCE	LV ONE EVO	SLIP-ON	CARBON FIBER	CARBON FIBER	EURO 4	1G12 var. 0A01 ver.A;AC -TYPE 1G12 var. 0A02 ver.A;AC -TYPE 1G12 var. 0A51 ver.A;AC;AF	ECE-Approved	4T	14217E	
LEOVINCE	NERO	SLIP-ON	STAINLESS STEEL	CARBON FIBER	EURO 4	1G12 var. 0A01 ver.A;AC -TYPE 1G12 var. 0A02 ver.A;AC -TYPE 1G12 var. 0A51 ver.A;AC;AF	ECE-Approved	4T	14053	
1200 R 1200 GS ADVENTURE (fits with original panniers)			2010-2012							
GAMMA	LINEA	TIPO	MATERIALE	COPPA	STANDARD	TYPE	HOM.	2T/4T	ART.	
LEOVINCE	LV ONE EVO	SLIP-ON	STAINLESS STEEL	CARBON FIBER	EURO 3	R12	e*-approved	4T	8291E	
1200 R 1200 GS ADVENTURE (fits with original panniers)			2013-2016							
GAMMA	LINEA	TIPO	MATERIALE	COPPA	STANDARD	TYPE	HOM.	2T/4T	ART.	
LEOVINCE	LV ONE EVO	SLIP-ON	STAINLESS STEEL	CARBON FIBER	EURO 3	R12W	e*-approved	4T	8786E	
LEOVINCE	LV ONE EVO	SLIP-ON	CARBON FIBER	CARBON FIBER	EURO 3	R12W	e*-approved	4T	8787E	
1200 R 1200 GS ADVENTURE (fits with original panniers)			2017-2018							
GAMMA	LINEA	TIPO	MATERIALE	COPPA	STANDARD	TYPE	HOM.	2T/4T	ART.	
LEOVINCE	LV ONE EVO	SLIP-ON	STAINLESS STEEL	CARBON FIBER	EURO 4	1G12 var. 0A01 ver.A;AC -TYPE 1G12 var. 0A02 ver.A;AC -TYPE 1G12 var. 0A51 ver.A;AC;AF	ECE-Approved	4T	14216E	
LEOVINCE	LV ONE EVO	SLIP-ON	CARBON FIBER	CARBON FIBER	EURO 4	1G12 var. 0A01 ver.A;AC -TYPE 1G12 var. 0A02 ver.A;AC -TYPE 1G12 var. 0A51 ver.A;AC;AF	ECE-Approved	4T	14217E	
LEOVINCE	NERO	SLIP-ON	STAINLESS STEEL	CARBON FIBER	EURO 4	1G12 var. 0A01 ver.A;AC -TYPE 1G12 var. 0A02 ver.A;AC -TYPE 1G12 var. 0A51 ver.A;AC;AF	ECE-Approved	4T	14053	

# BMW

CC. MODELLO		ANNO								
1200 R 1200 R (fits with original panniers)		2015-2016								
GAMMA	LINEA	TIPO	MATERIALE	COPPA	STANDARD	TYPE	HOM.	2T/4T	ART.	
LEOVINCE	FACTORY S	SLIP-ON	STAINLESS STEEL	CARBON FIBER	EURO 3	R12WR	e <sup>+</sup> -approved	4T	14137S	
LEOVINCE	FACTORY S	SLIP-ON	CARBON FIBER	CARBON FIBER	EURO 3	R12WR	e <sup>+</sup> -approved	4T	14138S	
1200 R 1200 RS (fits with original panniers)		2015-2016								
GAMMA	LINEA	TIPO	MATERIALE	COPPA	STANDARD	TYPE	HOM.	2T/4T	ART.	
LEOVINCE	FACTORY S	SLIP-ON	STAINLESS STEEL	CARBON FIBER	EURO 3	R12WR	e <sup>+</sup> -approved	4T	14137S	
LEOVINCE	FACTORY S	SLIP-ON	CARBON FIBER	CARBON FIBER	EURO 3	R12WR	e <sup>+</sup> -approved	4T	14138S	

# CPI

CC. MODELLO		ANNO								
50 HUSSAR 50		-								
GAMMA	LINEA	TIPO	MATERIALE	COPPA	STANDARD	TYPE	HOM.	2T/4T	ART.	
LEOVINCE	HAND MADE TT	FULL SYSTEM	ALUMINUM	N/A			e-approved	2T	7404	
LEOVINCE	HAND MADE TT BLACK	FULL SYSTEM	ALUMINUM	N/A			e-approved	2T	7404B	
SITO	SITO	FULL SYSTEM	STEEL	N/A			e-approved	2T	0718	
50 OLIVER 50		-								
GAMMA	LINEA	TIPO	MATERIALE	COPPA	STANDARD	TYPE	HOM.	2T/4T	ART.	
LEOVINCE	HAND MADE TT	FULL SYSTEM	ALUMINUM	N/A			e-approved	2T	7404	
LEOVINCE	HAND MADE TT BLACK	FULL SYSTEM	ALUMINUM	N/A			e-approved	2T	7404B	
SITO	SITO	FULL SYSTEM	STEEL	N/A			e-approved	2T	0718	
50 POPCORN 50		2004-								
GAMMA	LINEA	TIPO	MATERIALE	COPPA	STANDARD	TYPE	HOM.	2T/4T	ART.	
LEOVINCE	HAND MADE TT	FULL SYSTEM	ALUMINUM	N/A			e-approved	2T	7404	
LEOVINCE	HAND MADE TT BLACK	FULL SYSTEM	ALUMINUM	N/A			e-approved	2T	7404B	
SITO	SITO	FULL SYSTEM	STEEL	N/A			e-approved	2T	0718	

# DERBI

CC. MODELLO		ANNO								
50 ATLANTIS 50 KAT air cooled Piaggio engine		2003-2006								
GAMMA	LINEA	TIPO	MATERIALE	COPPA	STANDARD	TYPE	HOM.	2T/4T	ART.	
SITO	SITO	FULL SYSTEM	STEEL	N/A			e-approved	2T	0586	
50 DRD SM/R		2003-								
GAMMA	LINEA	TIPO	MATERIALE	COPPA	STANDARD	TYPE	HOM.	2T/4T	ART.	
LEOVINCE	X-FIGHT	FULL SYSTEM	STAINLESS STEEL	N/A			e-approved	2T	3228	
LEOVINCE	X-FIGHT BLACK	FULL SYSTEM	STAINLESS STEEL	N/A			e-approved	2T	3228B	
50 GP1 50 liquid cooled		2001-2002								
GAMMA	LINEA	TIPO	MATERIALE	COPPA	STANDARD	TYPE	HOM.	2T/4T	ART.	
SITO	SITO	FULL SYSTEM	STEEL	N/A			e-approved	2T	0705	
50 SENDA DRD PRO R/SM 50		2005-2012								
GAMMA	LINEA	TIPO	MATERIALE	COPPA	STANDARD	TYPE	HOM.	2T/4T	ART.	
LEOVINCE	X-FIGHT	FULL SYSTEM	STAINLESS STEEL	N/A			e-approved	2T	3286	
LEOVINCE	X-FIGHT BLACK	FULL SYSTEM	STAINLESS STEEL	N/A			e-approved	2T	3286B	

# DERBI

CC. MODELLO	ANNO									
50 SENDA RACER SM/ENDURO	2004-2009									
GAMMA	LINEA	TIPO	MATERIALE	COPPA	STANDARD	TYPE	HOM.	2T/4T	ART.	
LEOVINCE	X-FIGHT	FULL SYSTEM	STAINLESS STEEL	N/A			e-approved	2T	3228	
LEOVINCE	X-FIGHT BLACK	FULL SYSTEM	STAINLESS STEEL	N/A			e-approved	2T	3228B	
50 SENDA SM	2001-									
GAMMA	LINEA	TIPO	MATERIALE	COPPA	STANDARD	TYPE	HOM.	2T/4T	ART.	
LEOVINCE	X-FIGHT	FULL SYSTEM	STAINLESS STEEL	N/A			e-approved	2T	3228	
LEOVINCE	X-FIGHT BLACK	FULL SYSTEM	STAINLESS STEEL	N/A			e-approved	2T	3228B	
50 SENDA X-TREME SM/R	2004-2012									
GAMMA	LINEA	TIPO	MATERIALE	COPPA	STANDARD	TYPE	HOM.	2T/4T	ART.	
LEOVINCE	X-FIGHT	FULL SYSTEM	STAINLESS STEEL	N/A			e-approved	2T	3228	
LEOVINCE	X-FIGHT BLACK	FULL SYSTEM	STAINLESS STEEL	N/A			e-approved	2T	3228B	

# DUCATI

CC. MODELLO	ANNO									
696 MONSTER 696	2008-2014									
GAMMA	LINEA	TIPO	MATERIALE	COPPA	STANDARD	TYPE	HOM.	2T/4T	ART.	
LEOVINCE	LV ONE EVO	2 SLIP-ON	STAINLESS STEEL	CARBON FIBER	EURO 3	ZDMM500AA	e-approved	4T	8281E	
LEOVINCE	LV ONE EVO	2 SLIP-ON	CARBON FIBER	CARBON FIBER	EURO 3	ZDMM500AA	e-approved	4T	8282E	
796 HYPERMOTARD 796	2009-2012									
GAMMA	LINEA	TIPO	MATERIALE	COPPA	STANDARD	TYPE	HOM.	2T/4T	ART.	
LEOVINCE	CAT ELIMINATOR	N/A	N/A	N/A	EURO 3	B1	Racing use only	4T	8053	
796 MONSTER 796	2010-2014									
GAMMA	LINEA	TIPO	MATERIALE	COPPA	STANDARD	TYPE	HOM.	2T/4T	ART.	
LEOVINCE	LV ONE EVO	2 SLIP-ON	STAINLESS STEEL	CARBON FIBER	EURO 3	M5	e-approved	4T	8281E	
LEOVINCE	LV ONE EVO	2 SLIP-ON	CARBON FIBER	CARBON FIBER	EURO 3	M5	e-approved	4T	8282E	
800 SCRAMBLER 800 DESERT SLED	2017-2018									
GAMMA	LINEA	TIPO	MATERIALE	COPPA	STANDARD	TYPE	HOM.	2T/4T	ART.	
LEOVINCE	GP DUALS	SLIP-ON	STAINLESS STEEL	STAINLESS STEEL	EURO 4	KB var.00 ver.AA	dB(A) Compliant	4T	15117	
LEOVINCE	GP DUALS	SLIP-ON	STAINLESS STEEL	STAINLESS STEEL	EURO 4	KB var.00 ver.AA	ECE/EU-Approved	4T	15117K	
LEOVINCE	GP ONE	SLIP-ON	STAINLESS STEEL	STAINLESS STEEL	EURO 4	KB var.00 ver.AA	Racing use only	4T	15118	
LEOVINCE	LV-10	SLIP-ON	STAINLESS STEEL	STAINLESS STEEL	EURO 4		Racing use only	4T	15202	
LEOVINCE	LV-10 BLACK	SLIP-ON	STAINLESS STEEL	STAINLESS STEEL	EURO 4		Racing use only	4T	15202B	
800 SCRAMBLER 800 ICON/CLASSIC	2015-2016									
GAMMA	LINEA	TIPO	MATERIALE	COPPA	STANDARD	TYPE	HOM.	2T/4T	ART.	
LEOVINCE	GP DUALS	SLIP-ON	STAINLESS STEEL	STAINLESS STEEL	EURO 3	K1 VAR.00 VER.AA	dB(A) Compliant	4T	15101	
LEOVINCE	GP DUALS	SLIP-ON	STAINLESS STEEL	STAINLESS STEEL	EURO 3	K1 VAR.00 VER.AA	e-approved	4T	15101K	
LEOVINCE	GP DUALS	SLIP-ON	STAINLESS STEEL	STAINLESS STEEL	EURO 3	K1 VAR.00 VER.AA	Racing use only	4T	15101US	
LEOVINCE	GP STYLE	SLIP-ON	STAINLESS STEEL	N/A	EURO 3	K1	e-approved	4T	14118	
LEOVINCE	GP STYLE BLACK	SLIP-ON	STAINLESS STEEL	N/A	EURO 3	K1 var. 00/02/03 ver. AA - K1 var. 01 ver. JA	e-approved	4T	14118B	
LEOVINCE	LV ONE EVO	SLIP-ON	STAINLESS STEEL	CARBON FIBER	EURO 3	K1	e-approved	4T	14116E	
LEOVINCE	LV-10	SLIP-ON	STAINLESS STEEL	STAINLESS STEEL	EURO 3		Racing use only	4T	15206	
LEOVINCE	LV-10 BLACK	SLIP-ON	STAINLESS STEEL	STAINLESS STEEL	EURO 3		Racing use only	4T	15206B	

# DUCATI

CC. MODELLO		ANNO								
800 SCRAMBLER 800 ICON/CLASSIC		2017-2018								
GAMMA	LINEA	TIPO	MATERIALE	COPPA	STANDARD	TYPE	HOM.	2T/4T	ART.	
LEOVINCE	LV-10	SLIP-ON	STAINLESS STEEL	STAINLESS STEEL	EURO 4		Racing use only	4T	15206	
LEOVINCE	LV-10 BLACK	SLIP-ON	STAINLESS STEEL	STAINLESS STEEL	EURO 4		Racing use only	4T	15206B	
821 HYPERMOTARD/HYPERSTRADA 821		2013-2016								
GAMMA	LINEA	TIPO	MATERIALE	COPPA	STANDARD	TYPE	HOM.	2T/4T	ART.	
LEOVINCE	NERO	SLIP-ON	STAINLESS STEEL	CARBON FIBER	EURO 3	B1/B2/B3	e-approved	4T	14014	
821 MONSTER 821		2014-2016								
GAMMA	LINEA	TIPO	MATERIALE	COPPA	STANDARD	TYPE	HOM.	2T/4T	ART.	
LEOVINCE	LV ONE EVO	SLIP-ON	STAINLESS STEEL	CARBON FIBER	EURO 3	M6	e-approved	4T	14133E	
LEOVINCE	LV ONE EVO	SLIP-ON	CARBON FIBER	CARBON FIBER	EURO 3	M6	e-approved	4T	14134E	
1100 MONSTER 1100/S		2009-2010								
GAMMA	LINEA	TIPO	MATERIALE	COPPA	STANDARD	TYPE	HOM.	2T/4T	ART.	
LEOVINCE	LV ONE EVO	2 SLIP-ON	STAINLESS STEEL	CARBON FIBER	EURO 3	M502	e-approved	4T	8281E	
LEOVINCE	LV ONE EVO	2 SLIP-ON	CARBON FIBER	CARBON FIBER	EURO 3	M502	e-approved	4T	8282E	
1200 MULTISTRADA 1200/S/SPORT/TOURING		2010-2013								
GAMMA	LINEA	TIPO	MATERIALE	COPPA	STANDARD	TYPE	HOM.	2T/4T	ART.	
LEOVINCE	CAT ELIMINATOR (LINK PIPE)	N/A	N/A	N/A	EURO 3	A2 - A3	Racing use only	4T	8065	
LEOVINCE	dB KILLER	N/A	N/A	N/A	EURO 3	A2 - A3	N/A	4T	8075	
1200 MULTISTRADA 1200S D/AIR (fits with original panniers)		2015-2017								
GAMMA	LINEA	TIPO	MATERIALE	COPPA	STANDARD	TYPE	HOM.	2T/4T	ART.	
LEOVINCE	LV PRO	SLIP-ON	STAINLESS STEEL	CARBON FIBER	EURO 4	AA var. 00 ver. AA; A1; A2; A3	ECE-Approved	4T	14129E	
LEOVINCE	LV PRO	SLIP-ON	CARBON FIBER	CARBON FIBER	EURO 4	AA var. 00 ver. AA; A1; A2; A3	ECE-Approved	4T	14130E	

# EXPLORER

CC. MODELLO		ANNO								
50 CRACKER 50 (B05)		-								
GAMMA	LINEA	TIPO	MATERIALE	COPPA	STANDARD	TYPE	HOM.	2T/4T	ART.	
LEOVINCE	HAND MADE TT	FULL SYSTEM	ALUMINUM	N/A			e-approved	2T	7404	
LEOVINCE	HAND MADE TT BLACK	FULL SYSTEM	ALUMINUM	N/A			e-approved	2T	7404B	
SITO	SITO	FULL SYSTEM	STEEL	N/A			e-approved	2T	0718	
50 RACE GT 50 (B92)		-								
GAMMA	LINEA	TIPO	MATERIALE	COPPA	STANDARD	TYPE	HOM.	2T/4T	ART.	
LEOVINCE	HAND MADE TT	FULL SYSTEM	ALUMINUM	N/A			e-approved	2T	7404	
LEOVINCE	HAND MADE TT BLACK	FULL SYSTEM	ALUMINUM	N/A			e-approved	2T	7404B	
SITO	SITO	FULL SYSTEM	STEEL	N/A			e-approved	2T	0718	
50 SPIN GE 50 (B05)		-								
GAMMA	LINEA	TIPO	MATERIALE	COPPA	STANDARD	TYPE	HOM.	2T/4T	ART.	
LEOVINCE	HAND MADE TT	FULL SYSTEM	ALUMINUM	N/A			e-approved	2T	7404	
LEOVINCE	HAND MADE TT BLACK	FULL SYSTEM	ALUMINUM	N/A			e-approved	2T	7404B	
SITO	SITO	FULL SYSTEM	STEEL	N/A			e-approved	2T	0718	

## EXPLORER

CC. MODELLO	ANNO									
50 TWISTER 50 (B92)	-									
GAMMA	LINEA	TIPO	MATERIALE	COPPA	STANDARD	TYPE	HOM.	2T/4T	ART.	
LEOVINCE	HAND MADE TT	FULL SYSTEM	ALUMINUM	N/A			e-approved	2T	7404	
LEOVINCE	HAND MADE TT BLACK	FULL SYSTEM	ALUMINUM	N/A			e-approved	2T	7404B	
SITO	SITO	FULL SYSTEM	STEEL	N/A			e-approved	2T	0718	

## GENERIC

CC. MODELLO	ANNO									
50 CRACKER 50 (B05)	-									
GAMMA	LINEA	TIPO	MATERIALE	COPPA	STANDARD	TYPE	HOM.	2T/4T	ART.	
LEOVINCE	HAND MADE TT	FULL SYSTEM	ALUMINUM	N/A			e-approved	2T	7404	
LEOVINCE	HAND MADE TT BLACK	FULL SYSTEM	ALUMINUM	N/A			e-approved	2T	7404B	
SITO	SITO	FULL SYSTEM	STEEL	N/A			e-approved	2T	0718	

50 IDEO 50 (B93)	-									
GAMMA	LINEA	TIPO	MATERIALE	COPPA	STANDARD	TYPE	HOM.	2T/4T	ART.	
LEOVINCE	HAND MADE TT	FULL SYSTEM	ALUMINUM	N/A			e-approved	2T	7404	
LEOVINCE	HAND MADE TT BLACK	FULL SYSTEM	ALUMINUM	N/A			e-approved	2T	7404B	
SITO	SITO	FULL SYSTEM	STEEL	N/A			e-approved	2T	0718	

50 RACE GT 50 (B92)	-									
GAMMA	LINEA	TIPO	MATERIALE	COPPA	STANDARD	TYPE	HOM.	2T/4T	ART.	
LEOVINCE	HAND MADE TT	FULL SYSTEM	ALUMINUM	N/A			e-approved	2T	7404	
LEOVINCE	HAND MADE TT BLACK	FULL SYSTEM	ALUMINUM	N/A			e-approved	2T	7404B	
SITO	SITO	FULL SYSTEM	STEEL	N/A			e-approved	2T	0718	

50 SPIN GE 50 (B05)	-									
GAMMA	LINEA	TIPO	MATERIALE	COPPA	STANDARD	TYPE	HOM.	2T/4T	ART.	
LEOVINCE	HAND MADE TT	FULL SYSTEM	ALUMINUM	N/A			e-approved	2T	7404	
LEOVINCE	HAND MADE TT BLACK	FULL SYSTEM	ALUMINUM	N/A			e-approved	2T	7404B	
SITO	SITO	FULL SYSTEM	STEEL	N/A			e-approved	2T	0718	

50 XOR 50 (BNOT)	-									
GAMMA	LINEA	TIPO	MATERIALE	COPPA	STANDARD	TYPE	HOM.	2T/4T	ART.	
LEOVINCE	HAND MADE TT	FULL SYSTEM	ALUMINUM	N/A			e-approved	2T	7404	
LEOVINCE	HAND MADE TT BLACK	FULL SYSTEM	ALUMINUM	N/A			e-approved	2T	7404B	
SITO	SITO	FULL SYSTEM	STEEL	N/A		B05-B92	e-approved	2T	0718	

## GILERA

CC. MODELLO	ANNO									
50 GILERA RCR 50	2003-2004									
GAMMA	LINEA	TIPO	MATERIALE	COPPA	STANDARD	TYPE	HOM.	2T/4T	ART.	
LEOVINCE	X-FIGHT	FULL SYSTEM	STAINLESS STEEL	N/A			e-approved	2T	3228	
LEOVINCE	X-FIGHT BLACK	FULL SYSTEM	STAINLESS STEEL	N/A			e-approved	2T	3228B	

50 GILERA SMT 50	2003-2004									
GAMMA	LINEA	TIPO	MATERIALE	COPPA	STANDARD	TYPE	HOM.	2T/4T	ART.	
LEOVINCE	X-FIGHT	FULL SYSTEM	STAINLESS STEEL	N/A			e-approved	2T	3228	
LEOVINCE	X-FIGHT BLACK	FULL SYSTEM	STAINLESS STEEL	N/A			e-approved	2T	3228B	



# GILERA

CC.	MODELLO	ANNO								
50	ICE 50 KAT	2001-								
	GAMMA	LINEA	TIPO	MATERIALE	COPPA	STANDARD	TYPE	HOM.	2T/4T	ART.
	LEOVINCE	HAND MADE TT	FULL SYSTEM	ALUMINUM	N/A			e-approved	2T	4065
	LEOVINCE	HAND MADE TT BLACK	FULL SYSTEM	ALUMINUM	N/A			e-approved	2T	4065B
	LEOVINCE	TOURING	FULL SYSTEM	STEEL	N/A			e-approved	2T	5565
50	RUNNER 50	1997-2000								
	GAMMA	LINEA	TIPO	MATERIALE	COPPA	STANDARD	TYPE	HOM.	2T/4T	ART.
	SITO	SITOPPLUS	FULL SYSTEM	STEEL	N/A	EURO 1	C14000 - C14100	e-approved	2T	0572
50	RUNNER 50	-								
	GAMMA	LINEA	TIPO	MATERIALE	COPPA	STANDARD	TYPE	HOM.	2T/4T	ART.
	LEOVINCE	HAND MADE TT	FULL SYSTEM	ALUMINUM	N/A			e-approved	2T	4060
	LEOVINCE	HAND MADE TT BLACK	FULL SYSTEM	ALUMINUM	N/A			e-approved	2T	4060B
	LEOVINCE	TOURING	FULL SYSTEM	STEEL	N/A			e-approved	2T	5562
50	RUNNER 50 SP (carburetor)	2005-2012								
	GAMMA	LINEA	TIPO	MATERIALE	COPPA	STANDARD	TYPE	HOM.	2T/4T	ART.
	LEOVINCE	HAND MADE TT	FULL SYSTEM	ALUMINUM	N/A			e-approved	2T	4075
	LEOVINCE	HAND MADE TT BLACK	FULL SYSTEM	ALUMINUM	N/A			e-approved	2T	4075B
	SITO	SITO	FULL SYSTEM	STEEL	N/A			e-approved	2T	0712
50	STALKER 50	1997-2004								
	GAMMA	LINEA	TIPO	MATERIALE	COPPA	STANDARD	TYPE	HOM.	2T/4T	ART.
	LEOVINCE	HAND MADE TT	FULL SYSTEM	ALUMINUM	N/A			e-approved	2T	4060
	LEOVINCE	HAND MADE TT BLACK	FULL SYSTEM	ALUMINUM	N/A			e-approved	2T	4060B
	SITO	SITOPPLUS	FULL SYSTEM	STEEL	N/A	EURO 1		e-approved	2T	0572
50	STORM 50	1994-2001								
	GAMMA	LINEA	TIPO	MATERIALE	COPPA	STANDARD	TYPE	HOM.	2T/4T	ART.
	SITO	SITOPPLUS	FULL SYSTEM	STEEL	N/A			e-approved	2T	0554
50	TYPHOON 50	1994-2001								
	GAMMA	LINEA	TIPO	MATERIALE	COPPA	STANDARD	TYPE	HOM.	2T/4T	ART.
	SITO	SITOPPLUS	FULL SYSTEM	STEEL	N/A			e-approved	2T	0554
125	RUNNER ST 125	2008-2016								
	GAMMA	LINEA	TIPO	MATERIALE	COPPA	STANDARD	TYPE	HOM.	2T/4T	ART.
	LEOVINCE	LV ONE EVO	FULL SYSTEM 1/1	STAINLESS STEEL	CARBON FIBER	EURO 3	ZAPM463	e-approved	4T	8541E
125	RUNNER VX 125	2006-2007								
	GAMMA	LINEA	TIPO	MATERIALE	COPPA	STANDARD	TYPE	HOM.	2T/4T	ART.
	LEOVINCE	LV ONE EVO	FULL SYSTEM 1/1	STAINLESS STEEL	CARBON FIBER	EURO 3	ZAPM46100	e-approved	4T	8541E
200	RUNNER ST 200	2008-2014								
	GAMMA	LINEA	TIPO	MATERIALE	COPPA	STANDARD	TYPE	HOM.	2T/4T	ART.
	LEOVINCE	LV ONE EVO	FULL SYSTEM 1/1	STAINLESS STEEL	CARBON FIBER	EURO 3	ZAPM464	e-approved	4T	8541E

## GILERA

CC. MODELLO	ANNO									
200 RUNNER VXR 200	2006-2008									
GAMMA	LINEA	TIPO	MATERIALE	COPPA	STANDARD	TYPE	HOM.	2T/4T	ART.	
LEOVINCE	LV ONE EVO	FULL SYSTEM 1/1	STAINLESS STEEL	CARBON FIBER	EURO 3	ZAPM46200	e-approved	4T	8541E	
250 NEXUS 250	2006-2008									
GAMMA	LINEA	TIPO	MATERIALE	COPPA	STANDARD	TYPE	HOM.	2T/4T	ART.	
LEOVINCE	LV ONE EVO	FULL SYSTEM 1/1	STAINLESS STEEL	CARBON FIBER	EURO 3	M35	e-approved	4T	8489E	
300 NEXUS 300	2008-2014									
GAMMA	LINEA	TIPO	MATERIALE	COPPA	STANDARD	TYPE	HOM.	2T/4T	ART.	
LEOVINCE	LV ONE EVO	FULL SYSTEM 1/1	STAINLESS STEEL	CARBON FIBER	EURO 3		e-approved	4T	8489E	
500 FUOCO 500	2007-2015									
GAMMA	LINEA	TIPO	MATERIALE	COPPA	STANDARD	TYPE	HOM.	2T/4T	ART.	
LEOVINCE	GRANTURISMO	SLIP-ON	STAINLESS STEEL	N/A	EURO 3		e-approved	4T	3496	
LEOVINCE	GRANTURISMO BLACK	SLIP-ON	STAINLESS STEEL	N/A	EURO 3		e-approved	4T	3496B	
500 NEXUS 500 carburetor/injection	2003-2012									
GAMMA	LINEA	TIPO	MATERIALE	COPPA	STANDARD	TYPE	HOM.	2T/4T	ART.	
LEOVINCE	LV ONE EVO	FULL SYSTEM 1/1	STAINLESS STEEL	CARBON FIBER	EURO 2/3		e-approved	4T	8488E	
800 GP 800	2008-2015									
GAMMA	LINEA	TIPO	MATERIALE	COPPA	STANDARD	TYPE	HOM.	2T/4T	ART.	
LEOVINCE	LV ONE EVO	SLIP-ON	STAINLESS STEEL	CARBON FIBER	EURO 3		e-approved	4T	8565E	

## HM

CC. MODELLO	ANNO									
50 CRE 50 DERAPAGE RR/BAJA 50 RR	2007-2013									
GAMMA	LINEA	TIPO	MATERIALE	COPPA	STANDARD	TYPE	HOM.	2T/4T	ART.	
LEOVINCE	X-FIGHT	FULL SYSTEM	STAINLESS STEEL	N/A			e-approved	2T	3258	
LEOVINCE	X-FIGHT BLACK	FULL SYSTEM	STAINLESS STEEL	N/A			e-approved	2T	3258B	
50 CRE 50 DERAPAGE/BAJA	2006-2013									
GAMMA	LINEA	TIPO	MATERIALE	COPPA	STANDARD	TYPE	HOM.	2T/4T	ART.	
LEOVINCE	X-FIGHT	FULL SYSTEM	STAINLESS STEEL	N/A			e-approved	2T	3258	
LEOVINCE	X-FIGHT BLACK	FULL SYSTEM	STAINLESS STEEL	N/A			e-approved	2T	3258B	

## HONDA

CC. MODELLO	ANNO									
50 PK50 WALLAROO ferrule	-									
GAMMA	LINEA	TIPO	MATERIALE	COPPA	STANDARD	TYPE	HOM.	2T/4T	ART.	
SITO	SITOPUS	FULL SYSTEM	STEEL	N/A			Not approved	2T	0536	
50 PK50 WALLAROO flange	-									
GAMMA	LINEA	TIPO	MATERIALE	COPPA	STANDARD	TYPE	HOM.	2T/4T	ART.	
SITO	SITOPUS	FULL SYSTEM	STEEL	N/A			e-approved	2T	0535	

CC. MODELLO		ANNO								
50 SFX 50		-								
GAMMA	LINEA	TIPO	MATERIALE	COPPA	STANDARD	TYPE	HOM.	2T/4T	ART.	
SITO	SITOPPLUS	FULL SYSTEM	STEEL	N/A			e-approved	2T	0564	
50 SH FIFTY mod. 96		1996-								
GAMMA	LINEA	TIPO	MATERIALE	COPPA	STANDARD	TYPE	HOM.	2T/4T	ART.	
SITO	SITOPPLUS	FULL SYSTEM	STEEL	N/A			e-approved	2T	0569	
50 SJ 50 BALI		-								
GAMMA	LINEA	TIPO	MATERIALE	COPPA	STANDARD	TYPE	HOM.	2T/4T	ART.	
SITO	SITOPPLUS	FULL SYSTEM	STEEL	N/A			e-approved	2T	0562	
50 X8R-S/X 50		-								
GAMMA	LINEA	TIPO	MATERIALE	COPPA	STANDARD	TYPE	HOM.	2T/4T	ART.	
SITO	SITO	FULL SYSTEM	STEEL	N/A			e-approved	2T	0592	
125 CB 125 R		2018-								
GAMMA	LINEA	TIPO	MATERIALE	COPPA	STANDARD	TYPE	HOM.	2T/4T	ART.	
LEOVINCE	GP ONE	FULL SYSTEM 1/1	STAINLESS STEEL	STAINLESS STEEL	EURO 4	JC79; var.1 ver.1	Racing use only	4T	15120	
LEOVINCE	GP ONE	FULL SYSTEM 1/1	STAINLESS STEEL	STAINLESS STEEL	EURO 4	JC79; var.1 ver.1	ECE/EU-Approved	4T	15120K	
LEOVINCE	LV ONE EVO	FULL SYSTEM 1/1	STAINLESS STEEL	CARBON FIBER	EURO 4	JC79; var.1 ver.1	dB(A) Compliant	4T	14245E	
LEOVINCE	LV ONE EVO	FULL SYSTEM 1/1	STAINLESS STEEL	CARBON FIBER	EURO 4	JC79; var.1 ver.1	ECE/EU-Approved	4T	14245EK	
LEOVINCE	LV ONE EVO	FULL SYSTEM 1/1	CARBON FIBER	CARBON FIBER	EURO 4	JC79; var.1 ver.1	dB(A) Compliant	4T	14246E	
LEOVINCE	LV ONE EVO	FULL SYSTEM 1/1	CARBON FIBER	CARBON FIBER	EURO 4	JC79; var.1 ver.1	ECE/EU-Approved	4T	14246EK	
LEOVINCE	LV-10	FULL SYSTEM 1/1	STAINLESS STEEL	STAINLESS STEEL	EURO 4	JC79; var.1 ver.1	Racing use only	4T	15221	
LEOVINCE	LV-10 BLACK	FULL SYSTEM 1/1	STAINLESS STEEL	STAINLESS STEEL	EURO 4	JC79; var.1 ver.1	Racing use only	4T	15221B	
125 FORZA 125/NSS 125/ABS		2015-2016								
GAMMA	LINEA	TIPO	MATERIALE	COPPA	STANDARD	TYPE	HOM.	2T/4T	ART.	
LEOVINCE	LV ONE EVO	FULL SYSTEM 1/1	STAINLESS STEEL	CARBON FIBER	EURO 3	JF60	e-approved	4T	14111E	
LEOVINCE	NERO	FULL SYSTEM 1/1	STAINLESS STEEL	CARBON FIBER	EURO 3	JF60	e-approved	4T	14021	
125 FORZA 125/NSS 125/ABS		2017-2018								
GAMMA	LINEA	TIPO	MATERIALE	COPPA	STANDARD	TYPE	HOM.	2T/4T	ART.	
LEOVINCE	LV ONE EVO	FULL SYSTEM 1/1	STAINLESS STEEL	CARBON FIBER	EURO 4	JF69 var.1 ver.1	dB(A) Compliant	4T	14215E	
LEOVINCE	LV ONE EVO	FULL SYSTEM 1/1	STAINLESS STEEL	CARBON FIBER	EURO 4	JF69 var.1 ver.1	ECE/EU-Approved	4T	14215EK	
LEOVINCE	NERO	FULL SYSTEM 1/1	STAINLESS STEEL	CARBON FIBER	EURO 4	JF69 var.1 ver.1	dB(A) Compliant	4T	14052	
LEOVINCE	NERO	FULL SYSTEM 1/1	STAINLESS STEEL	CARBON FIBER	EURO 4	JF69 var.1 ver.1	ECE/EU-Approved	4T	14052K	
125 MSX 125/GROM		2013-2015								
GAMMA	LINEA	TIPO	MATERIALE	COPPA	STANDARD	TYPE	HOM.	2T/4T	ART.	
LEOVINCE	GP CORSA	SLIP-ON	CARBON FIBER	N/A	EURO 3		Racing use only	4T	9726	
125 PCX 125		2012-2016								
GAMMA	LINEA	TIPO	MATERIALE	COPPA	STANDARD	TYPE	HOM.	2T/4T	ART.	
LEOVINCE	GP CORSA	FULL SYSTEM 1/1	CARBON FIBER	N/A	EURO 3	KF12 - KF19	Racing use only	4T	9702	
LEOVINCE	GRANTURISMO	FULL SYSTEM	STAINLESS STEEL	N/A	EURO 3	JF2812-JF57	e-approved	4T	9700	
LEOVINCE	GRANTURISMO BLACK	FULL SYSTEM	STAINLESS STEEL	N/A	EURO 3		e-approved	4T	9700B	
LEOVINCE	NERO	FULL SYSTEM 1/1	STAINLESS STEEL	CARBON FIBER	EURO 3	JF28 var.1 ver.2 JF47 var.1 ver.1 JF57 var.1 ver.1 JF56	e-approved	4T	14015	

# HONDA

CC. MODELLO		ANNO								
125 PS 125i		2006-2011								
GAMMA	LINEA	TIPO	MATERIALE	COPPA	STANDARD	TYPE	HOM.	2T/4T	ART.	
LEOVINCE	GRANTURISMO	FULL SYSTEM	STAINLESS STEEL	N/A	EURO 3	KF1211	e-approved	4T	3208	
LEOVINCE	GRANTURISMO BLACK	FULL SYSTEM	STAINLESS STEEL	N/A	EURO 3		e-approved	4T	3208B	
125 SH 125i		2005-2012								
GAMMA	LINEA	TIPO	MATERIALE	COPPA	STANDARD	TYPE	HOM.	2T/4T	ART.	
LEOVINCE	GRANTURISMO	FULL SYSTEM	STAINLESS STEEL	N/A	EURO 3		e-approved	4T	3208	
LEOVINCE	GRANTURISMO BLACK	FULL SYSTEM	STAINLESS STEEL	N/A	EURO 3		e-approved	4T	3208B	
125 SH 125i		2017-								
GAMMA	LINEA	TIPO	MATERIALE	COPPA	STANDARD	TYPE	HOM.	2T/4T	ART.	
LEOVINCE	NERO	FULL SYSTEM 1/1	STAINLESS STEEL	CARBON FIBER	EURO 4		dB(A) Compliant	4T	14048	
LEOVINCE	NERO	FULL SYSTEM 1/1	STAINLESS STEEL	CARBON FIBER	EURO 4	JF68 var.1 ver.1	ECE/EU-Approved	4T	14048K	
125 SH 125i/ABS		2013-2016								
GAMMA	LINEA	TIPO	MATERIALE	COPPA	STANDARD	TYPE	HOM.	2T/4T	ART.	
LEOVINCE	GRANTURISMO	FULL SYSTEM	STAINLESS STEEL	N/A	EURO 3	JF41	e-approved	4T	9704	
LEOVINCE	GRANTURISMO BLACK	FULL SYSTEM	STAINLESS STEEL	N/A	EURO 3		e-approved	4T	9704B	
LEOVINCE	NERO	FULL SYSTEM 1/1	STAINLESS STEEL	CARBON FIBER	EURO 3	JF41	e-approved	4T	14121	
125 VT 125 C SHADOW		1999-2003								
GAMMA	LINEA	TIPO	MATERIALE	COPPA	STANDARD	TYPE	HOM.	2T/4T	ART.	
SILVERTAIL	K02	FULL SYSTEM	CHROMED STEEL	N/A			e-approved	4T	2238	
125 XL 125 V VARADERO carburetor/injection		2001-2013								
GAMMA	LINEA	TIPO	MATERIALE	COPPA	STANDARD	TYPE	HOM.	2T/4T	ART.	
LEOVINCE	LV ONE	SLIP-ON	STAINLESS STEEL	TECHNOPOLYMER	EURO 2/3		e*-approved	4T	8722	
150 PCX 150		2012-2016								
GAMMA	LINEA	TIPO	MATERIALE	COPPA	STANDARD	TYPE	HOM.	2T/4T	ART.	
LEOVINCE	GP CORSA	FULL SYSTEM 1/1	CARBON FIBER	N/A	EURO 3	KF12 - KF19	Racing use only	4T	9702	
LEOVINCE	GRANTURISMO	FULL SYSTEM	STAINLESS STEEL	N/A	EURO 3	KF12 - KF19	e-approved	4T	9700	
LEOVINCE	GRANTURISMO BLACK	FULL SYSTEM	STAINLESS STEEL	N/A	EURO 3		e-approved	4T	9700B	
LEOVINCE	NERO	FULL SYSTEM 1/1	STAINLESS STEEL	CARBON FIBER	EURO 3	KF12 var.1 ver.1 - KF19 var.1 ver.1 - KF15	e-approved	4T	14015	
150 PS 150i		2006-2011								
GAMMA	LINEA	TIPO	MATERIALE	COPPA	STANDARD	TYPE	HOM.	2T/4T	ART.	
LEOVINCE	GRANTURISMO	FULL SYSTEM	STAINLESS STEEL	N/A	EURO 3	KF1211	e-approved	4T	3208	
LEOVINCE	GRANTURISMO BLACK	FULL SYSTEM	STAINLESS STEEL	N/A	EURO 3		e-approved	4T	3208B	
150 SH 150i		2005-2012								
GAMMA	LINEA	TIPO	MATERIALE	COPPA	STANDARD	TYPE	HOM.	2T/4T	ART.	
LEOVINCE	GRANTURISMO	FULL SYSTEM	STAINLESS STEEL	N/A	EURO 3	KF1211	e-approved	4T	3208	
LEOVINCE	GRANTURISMO BLACK	FULL SYSTEM	STAINLESS STEEL	N/A	EURO 3		e-approved	4T	3208B	
150 SH 150i		2017-								
GAMMA	LINEA	TIPO	MATERIALE	COPPA	STANDARD	TYPE	HOM.	2T/4T	ART.	
LEOVINCE	NERO	FULL SYSTEM 1/1	STAINLESS STEEL	CARBON FIBER	EURO 4		dB(A) Compliant	4T	14048	
LEOVINCE	NERO	FULL SYSTEM 1/1	STAINLESS STEEL	CARBON FIBER	EURO 4	KF23	ECE/EU-Approved	4T	14048K	

# HONDA

CC. MODELLO		ANNO								
150 SH 150i/ABS		2013-2016								
GAMMA	LINEA	TIPO	MATERIALE	COPPA	STANDARD	TYPE	HOM.	2T/4T	ART.	
LEOVINCE	GRANTURISMO	FULL SYSTEM	STAINLESS STEEL	N/A	EURO 3	KF13	e-approved	4T	9704	
LEOVINCE	GRANTURISMO BLACK	FULL SYSTEM	STAINLESS STEEL	N/A	EURO 3		e-approved	4T	9704B	
LEOVINCE	NERO	FULL SYSTEM 1/1	STAINLESS STEEL	CARBON FIBER	EURO 3	KF13	e-approved	4T	14121	
250 CBR 250 R		2011-2013								
GAMMA	LINEA	TIPO	MATERIALE	COPPA	STANDARD	TYPE	HOM.	2T/4T	ART.	
LEOVINCE	GP CORSA	SLIP-ON	CARBON FIBER	N/A	EURO 3		Racing use only	4T	3469	
LEOVINCE	LV-10	SLIP-ON	STAINLESS STEEL	STAINLESS STEEL	EURO 3		Racing use only	4T	15210	
LEOVINCE	LV-10 BLACK	SLIP-ON	STAINLESS STEEL	STAINLESS STEEL	EURO 3		Racing use only	4T	15210B	
250 CRF 250 L		2012-2013								
GAMMA	LINEA	TIPO	MATERIALE	COPPA	STANDARD	TYPE	HOM.	2T/4T	ART.	
LEOVINCE	LV ONE EVO	SLIP-ON	STAINLESS STEEL	CARBON FIBER	EURO 3		Racing use only	4T	8773E	
300 CBR 300 R		2014-2017								
GAMMA	LINEA	TIPO	MATERIALE	COPPA	STANDARD	TYPE	HOM.	2T/4T	ART.	
LEOVINCE	LV ONE EVO	SLIP-ON	STAINLESS STEEL	CARBON FIBER	EURO 3	NC51	e-approved	4T	14109E	
LEOVINCE	LV-10	SLIP-ON	STAINLESS STEEL	STAINLESS STEEL	EURO 3		Racing use only	4T	15211	
LEOVINCE	LV-10 BLACK	SLIP-ON	STAINLESS STEEL	STAINLESS STEEL	EURO 3		Racing use only	4T	15211B	
LEOVINCE	LV ONE EVO	SLIP-ON	CARBON FIBER	CARBON FIBER	EURO 3	NC51	e-approved	4T	14110E	
LEOVINCE	NERO	SLIP-ON	STAINLESS STEEL	CARBON FIBER	EURO 3	NC51	e-approved	4T	14020	
300 SH 300i		2007-2015								
GAMMA	LINEA	TIPO	MATERIALE	COPPA	STANDARD	TYPE	HOM.	2T/4T	ART.	
LEOVINCE	GRANTURISMO	FULL SYSTEM	STAINLESS STEEL	N/A	EURO 3		e-approved	4T	3475	
LEOVINCE	GRANTURISMO BLAK	FULL SYSTEM	STAINLESS STEEL	N/A	EURO 3		e-approved	4T	3475B	
300 SH 300i ABS		2016-2017								
GAMMA	LINEA	TIPO	MATERIALE	COPPA	STANDARD	TYPE	HOM.	2T/4T	ART.	
LEOVINCE	NERO	SLIP-ON	STAINLESS STEEL	CARBON FIBER	EURO 4	NF08 VAR.1 VER.1	dB(A) Compliant	4T	14035	
LEOVINCE	NERO	SLIP-ON	STAINLESS STEEL	CARBON FIBER	EURO 4	NF08 VAR.1 VER.1	ECE/EU-Approved	4T	14035K	
400 SILVER WING 400		2006-2008								
GAMMA	LINEA	TIPO	MATERIALE	COPPA	STANDARD	TYPE	HOM.	2T/4T	ART.	
LEOVINCE	LV ONE EVO	SLIP-ON	STAINLESS STEEL	CARBON FIBER	EURO 3	NF01	e-approved	4T	8552E	
400 SW-T 400		2009-2016								
GAMMA	LINEA	TIPO	MATERIALE	COPPA	STANDARD	TYPE	HOM.	2T/4T	ART.	
LEOVINCE	LV ONE EVO	SLIP-ON	STAINLESS STEEL	CARBON FIBER	EURO 3	NF03	e-approved	4T	8552E	
500 CB 500 F (do not fit with centre stand)		2016-2018								
GAMMA	LINEA	TIPO	MATERIALE	COPPA	STANDARD	TYPE	HOM.	2T/4T	ART.	
LEOVINCE	GP CORSA	SLIP-ON	CARBON FIBER	N/A	EURO 4	PC44/PC45/PC46	Racing use only	4T	3384	
LEOVINCE	GP CORSA EVO	SLIP-ON	CARBON FIBER	TECHNOPOLYMER	EURO 4	PC44/PC45/PC46	Racing use only	4T	3384E	
500 CB 500 F (do not fit with original centre stand)		2013-2015								
GAMMA	LINEA	TIPO	MATERIALE	COPPA	STANDARD	TYPE	HOM.	2T/4T	ART.	
LEOVINCE	GP CORSA	SLIP-ON	CARBON FIBER	N/A	EURO 3	PC45	Racing use only	4T	8760	
LEOVINCE	LV ONE EVO	SLIP-ON	STAINLESS STEEL	CARBON FIBER	EURO 3	PC45	e*-approved	4T	8757E	
LEOVINCE	LV ONE EVO	SLIP-ON	CARBON FIBER	CARBON FIBER	EURO 3	PC45	e*-approved	4T	8758E	

CC. MODELLO		ANNO								
500 CB 500 F (do not fit with original centre stand)		2016-2016								
GAMMA	LINEA	TIPO	MATERIALE	COPPA	STANDARD	TYPE	HOM.	2T/4T	ART.	
LEOVINCE	LV ONE EVO	SLIP-ON	STAINLESS STEEL	CARBON FIBER	EURO 3	PC44 - PC45	e*-approved	4T	14160E	
LEOVINCE	LV ONE EVO	SLIP-ON	CARBON FIBER	CARBON FIBER	EURO 3	PC44 - PC45	e*-approved	4T	14161E	
LEOVINCE	LV-10	SLIP-ON	STAINLESS STEEL	STAINLESS STEEL	EURO 3		Racing use only	4T	15208	
LEOVINCE	LV-10 BLACK	SLIP-ON	STAINLESS STEEL	STAINLESS STEEL	EURO 3		Racing use only	4T	15208B	
LEOVINCE	NERO	SLIP-ON	STAINLESS STEEL	CARBON FIBER	EURO 3	PC44 - PC45	e*-approved	4T	14034	
500 CB 500 F (do not fit with original centre stand)		2016-2018								
GAMMA	LINEA	TIPO	MATERIALE	COPPA	STANDARD	TYPE	HOM.	2T/4T	ART.	
LEOVINCE	LV-10	SLIP-ON	STAINLESS STEEL	STAINLESS STEEL	EURO 4		Racing use only	4T	15208	
LEOVINCE	LV-10 BLACK	SLIP-ON	STAINLESS STEEL	STAINLESS STEEL	EURO 4		Racing use only	4T	15208B	
500 CB 500 F (fits with original centre stand)		2016-2018								
GAMMA	LINEA	TIPO	MATERIALE	COPPA	STANDARD	TYPE	HOM.	2T/4T	ART.	
LEOVINCE	GP DUALS	SLIP-ON	STAINLESS STEEL	STAINLESS STEEL	EURO 4		ECE-Approved	4T	15102	
LEOVINCE	LV ONE EVO	SLIP-ON	STAINLESS STEEL	CARBON FIBER	EURO 4	PC58 var.1 ver.1	ECE-Approved	4T	14210E	
LEOVINCE	LV ONE EVO	SLIP-ON	CARBON FIBER	CARBON FIBER	EURO 4	PC58 var.1 ver.1	ECE-Approved	4T	14211E	
LEOVINCE	NERO	SLIP-ON	STAINLESS STEEL	CARBON FIBER	EURO 4	PC58 var.1 ver.1	ECE-Approved	4T	14050	
500 CB 500 X (do not fit with original centre stand)		2013-2016								
GAMMA	LINEA	TIPO	MATERIALE	COPPA	STANDARD	TYPE	HOM.	2T/4T	ART.	
LEOVINCE	GP CORSA	SLIP-ON	CARBON FIBER	N/A	EURO 3	PC46	Racing use only	4T	8760	
LEOVINCE	LV ONE EVO	SLIP-ON	STAINLESS STEEL	CARBON FIBER	EURO 3	PC46	e*-approved	4T	8757E	
LEOVINCE	LV ONE EVO	SLIP-ON	CARBON FIBER	CARBON FIBER	EURO 3	PC46	e*-approved	4T	8758E	
500 CB 500 X (do not fit with original centre stand)		2017-2018								
GAMMA	LINEA	TIPO	MATERIALE	COPPA	STANDARD	TYPE	HOM.	2T/4T	ART.	
LEOVINCE	LV-10	SLIP-ON	STAINLESS STEEL	STAINLESS STEEL	EURO 4		Racing use only	4T	15208	
LEOVINCE	LV-10 BLACK	SLIP-ON	STAINLESS STEEL	STAINLESS STEEL	EURO 4		Racing use only	4T	15208B	
500 CB 500 X (fits with original centre stand)		2017-2018								
GAMMA	LINEA	TIPO	MATERIALE	COPPA	STANDARD	TYPE	HOM.	2T/4T	ART.	
LEOVINCE	GP DUALS	SLIP-ON	STAINLESS STEEL	STAINLESS STEEL	EURO 4		ECE-Approved	4T	15102	
LEOVINCE	LV ONE EVO	SLIP-ON	STAINLESS STEEL	CARBON FIBER	EURO 4	PC59 var.1 ver.1	ECE-Approved	4T	14210E	
LEOVINCE	LV ONE EVO	SLIP-ON	CARBON FIBER	CARBON FIBER	EURO 4	PC59 var.1 ver.1	ECE-Approved	4T	14211E	
LEOVINCE	NERO	SLIP-ON	STAINLESS STEEL	CARBON FIBER	EURO 4	PC59 var.1 ver.1	ECE-Approved	4T	14050	
500 CBR 500 R		2013-2015								
GAMMA	LINEA	TIPO	MATERIALE	COPPA	STANDARD	TYPE	HOM.	2T/4T	ART.	
LEOVINCE	GP CORSA	SLIP-ON	CARBON FIBER	N/A	EURO 3	PC44	Racing use only	4T	8760	
LEOVINCE	LV ONE EVO	SLIP-ON	STAINLESS STEEL	CARBON FIBER	EURO 3	PC44	e*-approved	4T	8757E	
LEOVINCE	LV ONE EVO	SLIP-ON	CARBON FIBER	CARBON FIBER	EURO 3	PC44	e*-approved	4T	8758E	
500 CBR 500 R		2016-2016								
GAMMA	LINEA	TIPO	MATERIALE	COPPA	STANDARD	TYPE	HOM.	2T/4T	ART.	
LEOVINCE	LV ONE EVO	SLIP-ON	STAINLESS STEEL	CARBON FIBER	EURO 3	PC44 - PC45	e*-approved	4T	14160E	
LEOVINCE	LV ONE EVO	SLIP-ON	CARBON FIBER	CARBON FIBER	EURO 3	PC44 - PC45	e*-approved	4T	14161E	
LEOVINCE	NERO	SLIP-ON	STAINLESS STEEL	CARBON FIBER	EURO 3	PC44 - PC45	e*-approved	4T	14034	

CC. MODELLO		ANNO								
500 CBR 500 R		2016-2018								
GAMMA	LINEA	TIPO	MATERIALE	COPPA	STANDARD	TYPE	HOM.	2T/4T	ART.	
LEOVINCE	GP CORSA	SLIP-ON	CARBON FIBER	N/A	EURO 4	PC44/PC45/PC46	Racing use only	4T	3384	
LEOVINCE	GP CORSA EVO	SLIP-ON	CARBON FIBER	TECHNOPOLYMER	EURO 4	PC44/PC45/PC46	Racing use only	4T	3384E	
LEOVINCE	GP DUALS	SLIP-ON	STAINLESS STEEL	STAINLESS STEEL	EURO 4		ECE-Approved	4T	15102	
LEOVINCE	LV ONE EVO	SLIP-ON	STAINLESS STEEL	CARBON FIBER	EURO 4	PC57 var.1 ver.1	ECE-Approved	4T	14210E	
LEOVINCE	LV ONE EVO	SLIP-ON	CARBON FIBER	CARBON FIBER	EURO 4	PC57 var.1 ver.1	ECE-Approved	4T	14211E	
LEOVINCE	LV-10	SLIP-ON	STAINLESS STEEL	STAINLESS STEEL	EURO 3		Racing use only	4T	15208	
LEOVINCE	LV-10 BLACK	SLIP-ON	STAINLESS STEEL	STAINLESS STEEL	EURO 3		Racing use only	4T	15208B	
LEOVINCE	NERO	SLIP-ON	STAINLESS STEEL	CARBON FIBER	EURO 4	PC57 var.1 ver.1	ECE-Approved	4T	14050	
500 CBR 500 R		2017-2018								
GAMMA	LINEA	TIPO	MATERIALE	COPPA	STANDARD	TYPE	HOM.	2T/4T	ART.	
LEOVINCE	LV-10	SLIP-ON	STAINLESS STEEL	STAINLESS STEEL	EURO 4		Racing use only	4T	15208	
LEOVINCE	LV-10 BLACK	SLIP-ON	STAINLESS STEEL	STAINLESS STEEL	EURO 4		Racing use only	4T	15208B	
600 CB 600 F HORNET		2007-2013								
GAMMA	LINEA	TIPO	MATERIALE	COPPA	STANDARD	TYPE	HOM.	2T/4T	ART.	
LEOVINCE	LV ONE EVO	SLIP-ON	STAINLESS STEEL	CARBON FIBER	EURO 3	PC41	e*-approved	4T	8400E	
LEOVINCE	LV ONE EVO	SLIP-ON	CARBON FIBER	CARBON FIBER	EURO 3	PC41	e*-approved	4T	8401E	
600 CBF 600 N		2005-2011								
GAMMA	LINEA	TIPO	MATERIALE	COPPA	STANDARD	TYPE	HOM.	2T/4T	ART.	
LEOVINCE	LV ONE EVO	SLIP-ON	STAINLESS STEEL	CARBON FIBER	EURO 3	PC38 - PC43	e-approved	4T	8295E	
600 CBF 600 S		2004-2012								
GAMMA	LINEA	TIPO	MATERIALE	COPPA	STANDARD	TYPE	HOM.	2T/4T	ART.	
LEOVINCE	LV ONE EVO	SLIP-ON	STAINLESS STEEL	CARBON FIBER	EURO 3	PC38 - PC43	e-approved	4T	8295E	
600 CBR 600 F		2011-2013								
GAMMA	LINEA	TIPO	MATERIALE	COPPA	STANDARD	TYPE	HOM.	2T/4T	ART.	
LEOVINCE	LV ONE EVO	SLIP-ON	STAINLESS STEEL	CARBON FIBER	EURO 3		e*-approved	4T	8400E	
LEOVINCE	LV ONE EVO	SLIP-ON	CARBON FIBER	CARBON FIBER	EURO 3		e*-approved	4T	8401E	
600 CBR 600 RR/ABS		2007-2012								
GAMMA	LINEA	TIPO	MATERIALE	COPPA	STANDARD	TYPE	HOM.	2T/4T	ART.	
LEOVINCE	LV ONE	SLIP-ON	STAINLESS STEEL	TECHNOPOLYMER	EURO 3		e-approved	4T	8279E	
LEOVINCE	LV ONE	SLIP-ON	CARBON FIBER	TECHNOPOLYMER	EURO 3		e-approved	4T	8280E	
600 CBR 600 RR/ABS		2013-2016								
GAMMA	LINEA	TIPO	MATERIALE	COPPA	STANDARD	TYPE	HOM.	2T/4T	ART.	
LEOVINCE	LV ONE	SLIP-ON	STAINLESS STEEL	TECHNOPOLYMER	EURO 3	PC40	e-approved	4T	8790E	
LEOVINCE	LV ONE	SLIP-ON	CARBON FIBER	TECHNOPOLYMER	EURO 3	PC40	e-approved	4T	8791E	
600 SILVER WING 600		2002-2010								
GAMMA	LINEA	TIPO	MATERIALE	COPPA	STANDARD	TYPE	HOM.	2T/4T	ART.	
LEOVINCE	LV ONE EVO	SLIP-ON	STAINLESS STEEL	CARBON FIBER	EURO 2/3		e-approved	4T	8552E	
600 SW-T 600		2011-2016								
GAMMA	LINEA	TIPO	MATERIALE	COPPA	STANDARD	TYPE	HOM.	2T/4T	ART.	
LEOVINCE	LV ONE EVO	SLIP-ON	STAINLESS STEEL	CARBON FIBER	EURO 3		e-approved	4T	8552E	

# HONDA

CC. MODELLO			ANNO							
600 VT 600 C SHADOW			1988-2000							
GAMMA	LINEA	TIPO	MATERIALE	COPPA	STANDARD	TYPE	HOM.	2T/4T	ART.	
SILVERTAIL	K02	FULL SYSTEM	CHROMED STEEL	N/A			e-approved	4T	2228	
650 CB 650 F			2014-2016							
GAMMA	LINEA	TIPO	MATERIALE	COPPA	STANDARD	TYPE	HOM.	2T/4T	ART.	
LEOVINCE	NERO	FULL SYSTEM 4/2/1	STAINLESS STEEL	CARBON FIBER	EURO 3	RC75	e-approved	4T	14016	
LEOVINCE	LV ONE EVO	FULL SYSTEM 4/2/1	STAINLESS STEEL	CARBON FIBER	EURO 3	RC75	e-approved	4T	14100E	
LEOVINCE	LV ONE EVO	FULL SYSTEM 4/2/1	CARBON FIBER	CARBON FIBER	EURO 3	RC75	e-approved	4T	14101E	
650 CBR 650 F			2014-2016							
GAMMA	LINEA	TIPO	MATERIALE	COPPA	STANDARD	TYPE	HOM.	2T/4T	ART.	
LEOVINCE	NERO	FULL SYSTEM 4/2/1	STAINLESS STEEL	CARBON FIBER	EURO 3	RC74	e-approved	4T	14016	
LEOVINCE	LV ONE EVO	FULL SYSTEM 4/2/1	STAINLESS STEEL	CARBON FIBER	EURO 3	RC74	e-approved	4T	14100E	
LEOVINCE	LV ONE EVO	FULL SYSTEM 4/2/1	CARBON FIBER	CARBON FIBER	EURO 3	RC74	e-approved	4T	14101E	
700 INTEGRA 700/DCT/ABS			2012-2013							
GAMMA	LINEA	TIPO	MATERIALE	COPPA	STANDARD	TYPE	HOM.	2T/4T	ART.	
LEOVINCE	HEADERS PIPES	N/A	N/A	N/A	EURO 3	RC61-RC62-RC63	Racing use only	4T	8069	
LEOVINCE	LV ONE EVO	SLIP-ON	STAINLESS STEEL	CARBON FIBER	EURO 3	RC61-RC62-RC63	e*-approved	4T	8700E	
LEOVINCE	LV ONE EVO	SLIP-ON	CARBON FIBER	CARBON FIBER	EURO 3	RC61-RC62-RC63	e*-approved	4T	8701E	
LEOVINCE	NERO	SLIP-ON	STAINLESS STEEL	CARBON FIBER	EURO 3	RC61-RC62-RC63	e*-approved	4T	14009	
700 NC 700 S/X/DCT/ABS			2012-2013							
GAMMA	LINEA	TIPO	MATERIALE	COPPA	STANDARD	TYPE	HOM.	2T/4T	ART.	
LEOVINCE	HEADERS PIPES	N/A	N/A	N/A	EURO 3	RC61-RC62-RC63	Racing use only	4T	8069	
LEOVINCE	LV ONE EVO	SLIP-ON	STAINLESS STEEL	CARBON FIBER	EURO 3	RC61-RC62-RC63	e*-approved	4T	8700E	
LEOVINCE	LV ONE EVO	SLIP-ON	CARBON FIBER	CARBON FIBER	EURO 3	RC61-RC62-RC63	e*-approved	4T	8701E	
LEOVINCE	NERO	SLIP-ON	STAINLESS STEEL	CARBON FIBER	EURO 3	RC61-RC62-RC63	e*-approved	4T	14009	
700 XL 700 V TRANSALP			2008-2013							
GAMMA	LINEA	TIPO	MATERIALE	COPPA	STANDARD	TYPE	HOM.	2T/4T	ART.	
LEOVINCE	CAT ELIMINATOR (LINK PIPE)	N/A	N/A	N/A	EURO 3		Racing use only	4T	8015	
700 XL 700 V TRANSALP (fits with original panniers)			2008-2013							
GAMMA	LINEA	TIPO	MATERIALE	COPPA	STANDARD	TYPE	HOM.	2T/4T	ART.	
LEOVINCE	LV ONE EVO	SLIP-ON	STAINLESS STEEL	CARBON FIBER	EURO 3		e*-approved	4T	8402E	
750 INTEGRA 750/DCT/ABS			2014-2015							
GAMMA	LINEA	TIPO	MATERIALE	COPPA	STANDARD	TYPE	HOM.	2T/4T	ART.	
LEOVINCE	HEADERS PIPES	N/A	N/A	N/A	EURO 3	RC70-RC71-RC72-RC82-RC88-RC89-RC90	Racing use only	4T	8069	
LEOVINCE	LV ONE EVO	SLIP-ON	STAINLESS STEEL	CARBON FIBER	EURO 3	RC70-RC71-RC72-RC82	e*-approved	4T	8700E	
LEOVINCE	LV ONE EVO	SLIP-ON	CARBON FIBER	CARBON FIBER	EURO 3	RC70-RC71-RC72-RC82	e*-approved	4T	8701E	
LEOVINCE	NERO	SLIP-ON	STAINLESS STEEL	CARBON FIBER	EURO 3	RC70-RC71-RC72-RC82	e*-approved	4T	14009	
750 INTEGRA 750/DCT/ABS (also fits 35Kw version)			2016-2018							
GAMMA	LINEA	TIPO	MATERIALE	COPPA	STANDARD	TYPE	HOM.	2T/4T	ART.	
LEOVINCE	HEADERS PIPES	N/A	N/A	N/A	EURO 4	RC89	Racing use only	4T	8069	
LEOVINCE	LV ONE EVO	SLIP-ON	STAINLESS STEEL	CARBON FIBER	EURO 4	RC89 var.1 ver.1	ECE-Approved	4T	14189E	
LEOVINCE	LV ONE EVO	SLIP-ON	CARBON FIBER	CARBON FIBER	EURO 4	RC89 var.1 ver.1	ECE-Approved	4T	14190E	
LEOVINCE	NERO	SLIP-ON	STAINLESS STEEL	CARBON FIBER	EURO 4	RC89 var.1 ver.1	ECE-Approved	4T	14042	



CC. MODELLO			ANNO							
750 NC 750 S/X/DCT/ABS			2014-2015							
GAMMA	LINEA	TIPO	MATERIALE	COPPA	STANDARD	TYPE	HOM.	2T/4T	ART.	
LEOVINCE	LV ONE EVO	SLIP-ON	STAINLESS STEEL	CARBON FIBER	EURO 3	RC70 - RC71 - RC72 - RC82	e*-approved	4T	8700E	
LEOVINCE	LV ONE EVO	SLIP-ON	CARBON FIBER	CARBON FIBER	EURO 3	RC70 - RC71 - RC72 - RC82	e*-approved	4T	8701E	
LEOVINCE	NERO	SLIP-ON	STAINLESS STEEL	CARBON FIBER	EURO 3	RC70 - RC71 - RC72 - RC82	e*-approved	4T	14009	
750 NC 750 S/X/DCT/ABS (also fits 35Kw version)			2016-2018							
GAMMA	LINEA	TIPO	MATERIALE	COPPA	STANDARD	TYPE	HOM.	2T/4T	ART.	
LEOVINCE	HEADERS PIPES	N/A	N/A	N/A	EURO 4	RC88 - RC90	Racing use only	4T	8069	
LEOVINCE	LV ONE EVO	SLIP-ON	STAINLESS STEEL	CARBON FIBER	EURO 4	RC88/RC90 var.1/2.ver.1/1	ECE-Approved	4T	14189E	
LEOVINCE	LV ONE EVO	SLIP-ON	CARBON FIBER	CARBON FIBER	EURO 4	RC88/RC90 var.1/2.ver.1/1	ECE-Approved	4T	14190E	
LEOVINCE	NERO	SLIP-ON	STAINLESS STEEL	CARBON FIBER	EURO 4	RC88/RC90 var.1/2.ver.1/1	ECE-Approved	4T	14042	
750 VT 750 C2 ACE SHADOW			1997-2001							
GAMMA	LINEA	TIPO	MATERIALE	COPPA	STANDARD	TYPE	HOM.	2T/4T	ART.	
SILVERTAIL	K02	FULL SYSTEM	CHROMED STEEL	N/A			e-approved	4T	2212	
750 X-ADV			2017-2018							
GAMMA	LINEA	TIPO	MATERIALE	COPPA	STANDARD	TYPE	HOM.	2T/4T	ART.	
LEOVINCE	FACTORY S	SLIP-ON	STAINLESS STEEL	CARBON FIBER	EURO 4	RC95 var.1;1 ver.1;2	ECE-Approved	4T	14195S	
LEOVINCE	FACTORY S	SLIP-ON	CARBON FIBER	CARBON FIBER	EURO 4	RC95 var.1;1 ver.1;2	ECE-Approved	4T	14196S	
LEOVINCE	HEADERS PIPES	N/A	N/A	N/A	EURO 4	RC95 var.1;1 ver.1;2	Racing use only	4T	8095	
LEOVINCE	LV PRO	SLIP-ON	STAINLESS STEEL	CARBON FIBER	EURO 4	RC95 var.1;1 ver.1;2	ECE-Approved	4T	14193E	
LEOVINCE	LV PRO	SLIP-ON	CARBON FIBER	CARBON FIBER	EURO 4	RC95 var.1;1 ver.1;2	ECE-Approved	4T	14194E	
LEOVINCE	NERO	SLIP-ON	STAINLESS STEEL	CARBON FIBER	EURO 4	RC95 var.1;1 ver.1;2	ECE-Approved	4T	14046	
750 XRV 750 AFRICA TWIN			1995-2005							
GAMMA	LINEA	TIPO	MATERIALE	COPPA	STANDARD	TYPE	HOM.	2T/4T	ART.	
LEOVINCE	LV ONE EVO	SLIP-ON	STAINLESS STEEL	CARBON FIBER			e-approved	4T	8424E	
1000 CB 1000 R			2008-2016							
GAMMA	LINEA	TIPO	MATERIALE	COPPA	STANDARD	TYPE	HOM.	2T/4T	ART.	
LEOVINCE	CARTER	N/A	N/A	N/A	EURO 3		N/A	4T	8035	
LEOVINCE	CAT ELIMINATOR (LINK PIPE)	N/A	N/A	N/A	EURO 3		Racing use only	4T	8057	
LEOVINCE	LV ONE EVO	SLIP-ON	STAINLESS STEEL	CARBON FIBER	EURO 3		e*-approved	4T	8555E	
LEOVINCE	LV ONE EVO	SLIP-ON	CARBON FIBER	CARBON FIBER	EURO 3		e*-approved	4T	8556E	
1000 CB 1000 R			2018-							
GAMMA	LINEA	TIPO	MATERIALE	COPPA	STANDARD	TYPE	HOM.	2T/4T	ART.	
LEOVINCE	FACTORY S	SLIP-ON	STAINLESS STEEL	CARBON FIBER	EURO 4	SC80 var.1/1 ver.1/2	ECE-Approved	4T	14249S	
LEOVINCE	FACTORY S	SLIP-ON	CARBON FIBER	CARBON FIBER	EURO 4	SC80 var.1/1 ver.1/2	ECE-Approved	4T	14250S	
LEOVINCE	GP DUALS	SLIP-ON	STAINLESS STEEL	STAINLESS STEEL	EURO 4	SC80 var.1/1 ver.1/2	ECE-Approved	4T	15123	
LEOVINCE	LV-10	SLIP-ON	STAINLESS STEEL	STAINLESS STEEL	EURO 4	SC80 var.1/1 ver.1/2	Racing use only	4T	15222	
LEOVINCE	LV-10 BLACK	SLIP-ON	STAINLESS STEEL	STAINLESS STEEL	EURO 4	SC80 var.1/1 ver.1/2	Racing use only	4T	15222B	

# HONDA

CC. MODELLO		ANNO								
1000 CBF 1000/ST		2010-2013								
GAMMA	LINEA	TIPO	MATERIALE	COPPA	STANDARD	TYPE	HOM.	2T/4T	ART.	
LEOVINCE	LV ONE EVO	SLIP-ON	STAINLESS STEEL	CARBON FIBER	EURO 3		e-approved	4T	8404E	
LEOVINCE	LV ONE EVO	SLIP-ON	CARBON FIBER	CARBON FIBER	EURO 3		e-approved	4T	8405E	
1000 CBR 1000 RR FIREBLADE/SP/SP2		2017-2018								
GAMMA	LINEA	TIPO	MATERIALE	COPPA	STANDARD	TYPE	HOM.	2T/4T	ART.	
LEOVINCE	LV PRO	SLIP-ON	STAINLESS STEEL	CARBON FIBER	EURO 4	SC 77 var.2 ver.1	Racing use only	4T	14218E	
LEOVINCE	LV PRO	SLIP-ON	CARBON FIBER	CARBON FIBER	EURO 4	SC 77 var.2 ver.1	Racing use only	4T	14219E	
LEOVINCE	LV-10	SLIP-ON	STAINLESS STEEL	STAINLESS STEEL	EURO 4		Racing use only	4T	1520T	
LEOVINCE	LV-10 BLACK	SLIP-ON	STAINLESS STEEL	STAINLESS STEEL	EURO 4		Racing use only	4T	15207B	
1000 CBR 1000 RR/ABS		2008-2012								
GAMMA	LINEA	TIPO	MATERIALE	COPPA	STANDARD	TYPE	HOM.	2T/4T	ART.	
LEOVINCE	FACTORY S	SLIP-ON	CARBON FIBER	CARBON FIBER	EURO 3		e-approved	4T	8444S	
LEOVINCE	FACTORY S	SLIP-ON	STAINLESS STEEL	CARBON FIBER	EURO 3		e-approved	4T	8445S	
1000 CBR 1000 RR/SP/ABS		2014-2016								
GAMMA	LINEA	TIPO	MATERIALE	COPPA	STANDARD	TYPE	HOM.	2T/4T	ART.	
LEOVINCE	FACTORY S	SLIP-ON	CARBON FIBER	CARBON FIBER	EURO 3	SC59	e-approved	4T	14126S	
LEOVINCE	FACTORY S	SLIP-ON	STAINLESS STEEL	CARBON FIBER	EURO 3	SC59	e-approved	4T	8798S	
LEOVINCE	LV ONE EVO	SLIP-ON	STAINLESS STEEL	CARBON FIBER	EURO 3	SC59	e-approved	4T	14106E	
LEOVINCE	LV ONE EVO	SLIP-ON	CARBON FIBER	CARBON FIBER	EURO 3	SC59	e-approved	4T	14107E	
1000 CRF 1000 L AFRICA TWIN ABS EURO 4 (fits with original panniers) 2016-2017										
GAMMA	LINEA	TIPO	MATERIALE	COPPA	STANDARD	TYPE	HOM.	2T/4T	ART.	
LEOVINCE	LV ONE EVO	SLIP-ON	STAINLESS STEEL	CARBON FIBER	EURO 4	SD06:1/1-SD06:2/1	ECE-Approved	4T	14191E	
LEOVINCE	NERO	SLIP-ON	STAINLESS STEEL	CARBON FIBER	EURO 4	SD06:1/1-SD06:2/1	ECE-Approved	4T	1404A	
1000 CRF 1000 L AFRICA TWIN EURO 3 (fits with original panniers) 2016-2017										
GAMMA	LINEA	TIPO	MATERIALE	COPPA	STANDARD	TYPE	HOM.	2T/4T	ART.	
LEOVINCE	LV ONE EVO	SLIP-ON	STAINLESS STEEL	CARBON FIBER	EURO 3	SD04	e*-approved	4T	14139E	
LEOVINCE	NERO	SLIP-ON	STAINLESS STEEL	CARBON FIBER	EURO 3	SD04	e*-approved	4T	1402B	
1000 CRF 1000 L AFRICA TWIN/ABS (fits with original panniers) 2016-2017										
GAMMA	LINEA	TIPO	MATERIALE	COPPA	STANDARD	TYPE	HOM.	2T/4T	ART.	
LEOVINCE	LV ONE EVO	FULL SYSTEM 2/1	STAINLESS STEEL	N/A	EURO 3/4	SD04 var.2:3 ver.1:1 - SD06 var.1:2;1;3:2:4 ver.1:1;2;1;2:1	Racing use only	4T	14220E	
1000 CRF 1000 L AFRICA TWIN/ABS (fits with original panniers) (compatible with original exhaust, not compatible with LeoVince) 2016-2017										
GAMMA	LINEA	TIPO	MATERIALE	COPPA	STANDARD	TYPE	HOM.	2T/4T	ART.	
LEOVINCE	HEADERS PIPES	N/A	N/A	N/A	EURO 3/4		Racing use only	4T	8089	
1200 VFR 1200 X CROSSTOURER/DCT/XD (fits with original panniers and centre stand) 2012-2015										
GAMMA	LINEA	TIPO	MATERIALE	COPPA	STANDARD	TYPE	HOM.	2T/4T	ART.	
LEOVINCE	LV ONE EVO	SLIP-ON	STAINLESS STEEL	CARBON FIBER	EURO 3		e*-approved	4T	8704E	
LEOVINCE	LV ONE EVO	SLIP-ON	CARBON FIBER	CARBON FIBER	EURO 3		e*-approved	4T	8705E	

CC. MODELLO		ANNO								
401 SVARTPILEN 401		2018-								
GAMMA	LINEA	TIPO	MATERIALE	COPPA	STANDARD	TYPE	HOM.	2T/4T	ART.	
LEOVINCE	CAT ELIMINATOR (LINK PIPE)	N/A	N/A	N/A	EURO 4	HQV 401 var.A1/-, B1/-	Racing use only	4T	8092	
LEOVINCE	GP ONE	SLIP-ON	STAINLESS STEEL	STAINLESS STEEL	EURO 4	HQV 401 var.A1/-, B1/-	ECE-Approved	4T	15121	
LEOVINCE	LV-10	SLIP-ON	STAINLESS STEEL	STAINLESS STEEL	EURO 4	HQV 401 var.A1/-, B1/-	Racing use only	4T	15219	
LEOVINCE	LV-10 BLACK	SLIP-ON	STAINLESS STEEL	STAINLESS STEEL	EURO 4	HQV 401 var.A1/-, B1/-	Racing use only	4T	15219B	
401 VITPILEN 401		2018-								
GAMMA	LINEA	TIPO	MATERIALE	COPPA	STANDARD	TYPE	HOM.	2T/4T	ART.	
LEOVINCE	CAT ELIMINATOR (LINK PIPE)	N/A	N/A	N/A	EURO 4	HQV 401 var.A1/-, B1/-	Racing use only	4T	8092	
LEOVINCE	GP ONE	SLIP-ON	STAINLESS STEEL	STAINLESS STEEL	EURO 4	HQV 401 var.A1/-, B1/-	ECE-Approved	4T	15121	
LEOVINCE	LV-10	SLIP-ON	STAINLESS STEEL	STAINLESS STEEL	EURO 4	HQV 401 var.A1/-, B1/-	Racing use only	4T	15219	
LEOVINCE	LV-10 BLACK	SLIP-ON	STAINLESS STEEL	STAINLESS STEEL	EURO 4	HQV 401 var.A1/-, B1/-	Racing use only	4T	15219B	
701 701 ENDURO		2015-2016								
GAMMA	LINEA	TIPO	MATERIALE	COPPA	STANDARD	TYPE	HOM.	2T/4T	ART.	
LEOVINCE	LV ONE EVO	SLIP-ON	STAINLESS STEEL	CARBON FIBER	EURO 3		e-approved	4T	8299E	
701 701 ENDURO		2017-2018								
GAMMA	LINEA	TIPO	MATERIALE	COPPA	STANDARD	TYPE	HOM.	2T/4T	ART.	
LEOVINCE	LV ONE EVO	FULL SYSTEM 1/1	STAINLESS STEEL	CARBON FIBER	EURO 4	Husqvarna 701 var.A;B	dB(A) Compliant	4T	14232E	
LEOVINCE	LV ONE EVO	FULL SYSTEM 1/1	STAINLESS STEEL	CARBON FIBER	EURO 4	Husqvarna 701 var.A;B	ECE/EU-Approved	4T	14232EK	
LEOVINCE	LV ONE EVO	SLIP-ON	STAINLESS STEEL	CARBON FIBER	EURO 4	Husqvarna 701; A;B	Racing use only	4T	8299E	
701 701 SUPERMOTO		2015-2016								
GAMMA	LINEA	TIPO	MATERIALE	COPPA	STANDARD	TYPE	HOM.	2T/4T	ART.	
LEOVINCE	LV ONE EVO	SLIP-ON	STAINLESS STEEL	CARBON FIBER	EURO 3		e-approved	4T	8299E	
701 701 SUPERMOTO		2017-2018								
GAMMA	LINEA	TIPO	MATERIALE	COPPA	STANDARD	TYPE	HOM.	2T/4T	ART.	
LEOVINCE	LV ONE EVO	FULL SYSTEM 1/1	STAINLESS STEEL	CARBON FIBER	EURO 4	Husqvarna 701 var.A;B	dB(A) Compliant	4T	14232E	
LEOVINCE	LV ONE EVO	FULL SYSTEM 1/1	STAINLESS STEEL	CARBON FIBER	EURO 4	Husqvarna 701 var.A;B	ECE/EU-Approved	4T	14232EK	
LEOVINCE	LV ONE EVO	SLIP-ON	STAINLESS STEEL	CARBON FIBER	EURO 4	Husqvarna 701; A;B	Racing use only	4T	8299E	
701 VITPILEN 701		2018-								
GAMMA	LINEA	TIPO	MATERIALE	COPPA	STANDARD	TYPE	HOM.	2T/4T	ART.	
LEOVINCE	GP DUALS	SLIP-ON	STAINLESS STEEL	STAINLESS STEEL	EURO 4	HQV 701 var.A/-	ECE-Approved	4T	15122	
LEOVINCE	LV-10	SLIP-ON	STAINLESS STEEL	STAINLESS STEEL	EURO 4	HQV 701 var.A/-	Racing use only	4T	15220	
LEOVINCE	LV-10 BLACK	SLIP-ON	STAINLESS STEEL	STAINLESS STEEL	EURO 4	HQV 701 var.A/-	Racing use only	4T	15220B	
LEOVINCE	CAT ELIMINATOR (LINK PIPE)	N/A	N/A	N/A	EURO 4	HQV 701 var.A/-	Racing use only	4T	8070	

## HYOSUNG

CC. MODELLO	ANNO									
125 AQUILA GV 125 (injection)	2008-2015									
GAMMA	LINEA	TIPO	MATERIALE	COPPA	STANDARD	TYPE	HOM.	2T/4T	ART.	
SILVERTAIL	K02	SLIP-ON	CHROMED STEEL	N/A			e-approved	4T	2425	
250 AQUILA GV 250 (injection)	2008-2015									
GAMMA	LINEA	TIPO	MATERIALE	COPPA	STANDARD	TYPE	HOM.	2T/4T	ART.	
SILVERTAIL	K02	SLIP-ON	CHROMED STEEL	N/A			e-approved	4T	2425	
650 AQUILA GV 650 (carburetor/injection)	2005-2011									
GAMMA	LINEA	TIPO	MATERIALE	COPPA	STANDARD	TYPE	HOM.	2T/4T	ART.	
SILVERTAIL	K02	FULL SYSTEM	CHROMED STEEL	N/A		KM4VP51A	e-approved	4T	2418	

## ITALJET

CC. MODELLO	ANNO									
50 PISTA	1993-1993									
GAMMA	LINEA	TIPO	MATERIALE	COPPA	STANDARD	TYPE	HOM.	2T/4T	ART.	
SITO	SITOPPLUS	FULL SYSTEM	STEEL	N/A			e-approved	2T	0559	
50 SCOOP	1993-1993									
GAMMA	LINEA	TIPO	MATERIALE	COPPA	STANDARD	TYPE	HOM.	2T/4T	ART.	
SITO	SITOPPLUS	FULL SYSTEM	STEEL	N/A			e-approved	2T	0559	

## KAWASAKI

CC. MODELLO	ANNO									
125 J125/SE	2016-									
GAMMA	LINEA	TIPO	MATERIALE	COPPA	STANDARD	TYPE	HOM.	2T/4T	ART.	
LEOVINCE	GRANTURISMO	FULL SYSTEM	STAINLESS STEEL	N/A	EURO 3	C6	e-approved	4T	3253	
LEOVINCE	GRANTURISMO BLACK	FULL SYSTEM	STAINLESS STEEL	N/A	EURO 3		e-approved	4T	3253B	
250 NINJA 250 R	2008-2012									
GAMMA	LINEA	TIPO	MATERIALE	COPPA	STANDARD	TYPE	HOM.	2T/4T	ART.	
LEOVINCE	GP CORSA	SLIP-ON	CARBON FIBER	N/A	EURO 3		Racing use only	4T	3463	
LEOVINCE	LV ONE EVO	SLIP-ON	STAINLESS STEEL	CARBON FIBER	EURO 3		e-approved	4T	8406E	
250 NINJA 250 R	2013-2016									
GAMMA	LINEA	TIPO	MATERIALE	COPPA	STANDARD	TYPE	HOM.	2T/4T	ART.	
LEOVINCE	GP CORSA	SLIP-ON	CARBON FIBER	N/A	EURO 3	EX250L	Racing use only	4T	3293	
LEOVINCE	GP CORSA	FULL SYSTEM 2/1	CARBON FIBER	N/A	EURO 3	EX250L	Racing use only	4T	3296	
LEOVINCE	LV ONE EVO	SLIP-ON	STAINLESS STEEL	CARBON FIBER	EURO 3	EX250L	e*-approved	4T	8740E	
LEOVINCE	LV ONE EVO	SLIP-ON	CARBON FIBER	CARBON FIBER	EURO 3	EX250L	e*-approved	4T	8741E	
LEOVINCE	LV-10	SLIP-ON	STAINLESS STEEL	STAINLESS STEEL	EURO 3		Racing use only	4T	15205	
LEOVINCE	LV-10 BLACK	SLIP-ON	STAINLESS STEEL	STAINLESS STEEL	EURO 3		Racing use only	4T	15205B	

CC. MODELLO		ANNO								
250 Z 250		2015-2016								
GAMMA	LINEA	TIPO	MATERIALE	COPPA	STANDARD	TYPE	HOM.	2T/4T	ART.	
LEOVINCE	LV-10	SLIP-ON	STAINLESS STEEL	STAINLESS STEEL	EURO 3		Racing use only	4T	15205	
LEOVINCE	LV-10 BLACK	SLIP-ON	STAINLESS STEEL	STAINLESS STEEL	EURO 3		Racing use only	4T	15205B	
LEOVINCE	GP CORSA	SLIP-ON	CARBON FIBER	N/A	EURO 3		Racing use only	4T	3293	
LEOVINCE	LV ONE EVO	SLIP-ON	STAINLESS STEEL	CARBON FIBER	EURO 3		e*-approved	4T	8740E	
LEOVINCE	LV ONE EVO	SLIP-ON	CARBON FIBER	CARBON FIBER	EURO 3		e*-approved	4T	8741E	
300 J300		2014-2016								
GAMMA	LINEA	TIPO	MATERIALE	COPPA	STANDARD	TYPE	HOM.	2T/4T	ART.	
LEOVINCE	GRANTURISMO	FULL SYSTEM	STAINLESS STEEL	N/A	EURO 3	C4	e-approved	4T	3206	
LEOVINCE	GRANTURISMO BLACK	FULL SYSTEM	STAINLESS STEEL	N/A	EURO 3		e-approved	4T	3206B	
300 NINJA 300 R/ABS		2013-2016								
GAMMA	LINEA	TIPO	MATERIALE	COPPA	STANDARD	TYPE	HOM.	2T/4T	ART.	
LEOVINCE	GP CORSA	SLIP-ON	CARBON FIBER	N/A	EURO 3	EX300A	Racing use only	4T	3293	
LEOVINCE	GP CORSA	FULL SYSTEM 2/1	CARBON FIBER	N/A		EX300A	Racing use only	4T	3296	
LEOVINCE	LV ONE EVO	SLIP-ON	STAINLESS STEEL	CARBON FIBER	EURO 3	EX300A	e*-approved	4T	8740E	
LEOVINCE	LV ONE EVO	SLIP-ON	CARBON FIBER	CARBON FIBER	EURO 3	EX300A	e*-approved	4T	8741E	
LEOVINCE	LV-10	SLIP-ON	STAINLESS STEEL	STAINLESS STEEL	EURO 3		Racing use only	4T	15205	
LEOVINCE	LV-10 BLACK	SLIP-ON	STAINLESS STEEL	STAINLESS STEEL	EURO 3		Racing use only	4T	15205B	
300 Z 300 / ABS		2015-2016								
GAMMA	LINEA	TIPO	MATERIALE	COPPA	STANDARD	TYPE	HOM.	2T/4T	ART.	
LEOVINCE	GP CORSA	SLIP-ON	CARBON FIBER	N/A	EURO 3	EX300A	Racing use only	4T	3293	
LEOVINCE	LV ONE EVO	SLIP-ON	STAINLESS STEEL	CARBON FIBER	EURO 3	ER300A	e*-approved	4T	8740E	
LEOVINCE	LV ONE EVO	SLIP-ON	CARBON FIBER	CARBON FIBER	EURO 3	ER300A	e*-approved	4T	8741E	
LEOVINCE	LV-10	SLIP-ON	STAINLESS STEEL	STAINLESS STEEL	EURO 3		Racing use only	4T	15205	
LEOVINCE	LV-10 BLACK	SLIP-ON	STAINLESS STEEL	STAINLESS STEEL	EURO 3		Racing use only	4T	15205B	
400 KFX 400		2003-2006								
GAMMA	LINEA	TIPO	MATERIALE	COPPA	STANDARD	TYPE	HOM.	2T/4T	ART.	
LEOVINCE	X3	SLIP-ON	ALUMINUM	N/A			e-approved	4T	3914E	
400 NINJA 400		2018-								
GAMMA	LINEA	TIPO	MATERIALE	COPPA	STANDARD	TYPE	HOM.	2T/4T	ART.	
LEOVINCE	FACTORY S	FULL SYSTEM 2/1	STAINLESS STEEL	CARBON FIBER	EURO 4	EX400G var.G1 ver.E	Racing use only	4T	14239S	
LEOVINCE	FACTORY S	FULL SYSTEM 2/1	CARBON FIBER	CARBON FIBER	EURO 4	EX400G var.G1 ver.E	Racing use only	4T	14240S	
LEOVINCE	GP CORSA	SLIP-ON	CARBON FIBER	N/A	EURO 4	EX400G var.G1 ver.E	Racing use only	4T	3389	
LEOVINCE	GP CORSA EVO	SLIP-ON	CARBON FIBER	TECHNOPOLYMER	EURO 4	EX400G var.G1 ver.E	Racing use only	4T	3389E	
LEOVINCE	LV ONE EVO	SLIP-ON	STAINLESS STEEL	CARBON FIBER	EURO 4	EX400G var.G1 ver.E	ECE-Approved	4T	14259E	
LEOVINCE	LV ONE EVO	SLIP-ON	CARBON FIBER	CARBON FIBER	EURO 4	EX400G var.G1 ver.E	ECE-Approved	4T	14260E	
LEOVINCE	LV-10	SLIP-ON	STAINLESS STEEL	STAINLESS STEEL	EURO 4	EX400G var.G1 ver.E	Racing use only	4T	15218	
LEOVINCE	LV-10 BLACK	SLIP-ON	STAINLESS STEEL	STAINLESS STEEL	EURO 4	EX400G var.G1 ver.E	Racing use only	4T	15218B	
600 ZX-6R NINJA		2009-2016								
GAMMA	LINEA	TIPO	MATERIALE	COPPA	STANDARD	TYPE	HOM.	2T/4T	ART.	
LEOVINCE	CAT ELIMINATOR (LINK PIPE)	N/A	N/A	N/A	EURO 3	ZX600R	Racing use only	4T	8074	
LEOVINCE	LV ONE EVO	SLIP-ON	STAINLESS STEEL	CARBON FIBER	EURO 3	ZX600R	e*-approved	4T	8746E	
LEOVINCE	LV ONE EVO	SLIP-ON	CARBON FIBER	CARBON FIBER	EURO 3	ZX600R	e*-approved	4T	8747E	

CC. MODELLO		ANNO								
636 ZX-6R 636 NINJA		2013-2016								
GAMMA	LINEA	TIPO	MATERIALE	COPPA	STANDARD	TYPE	HOM.	2T/4T	ART.	
LEOVINCE	LV ONE EVO	SLIP-ON	CARBON FIBER	CARBON FIBER	EURO 3	ZX636E	e*-approved	4T	8747E	
LEOVINCE	CAT ELIMINATOR (LINK PIPE)	N/A	N/A	N/A	EURO 3	ZX636E	Racing use only	4T	8074	
LEOVINCE	LV ONE EVO	SLIP-ON	STAINLESS STEEL	CARBON FIBER	EURO 3	ZX636E	e*-approved	4T	8746E	
650 ER-6N/F/NINJA 650R		2006-2011								
GAMMA	LINEA	TIPO	MATERIALE	COPPA	STANDARD	TYPE	HOM.	2T/4T	ART.	
LEOVINCE	GP STYLE	SLIP-ON	STAINLESS STEEL	N/A	EURO 3		e-approved	4T	7918	
LEOVINCE	GP STYLE BLACK	SLIP-ON	STAINLESS STEEL	N/A	EURO 3		e-approved	4T	7918B	
LEOVINCE	UNDERBODY	SLIP-ON	STAINLESS STEEL	CARBON FIBER	EURO 3		e-approved	4T	8242	
650 ER-6N/F/NINJA 650R		2012-2016								
GAMMA	LINEA	TIPO	MATERIALE	COPPA	STANDARD	TYPE	HOM.	2T/4T	ART.	
LEOVINCE	UNDERBODY	FULL SYSTEM 2/1	STAINLESS STEEL	CARBON FIBER	EURO 3	ER650A/LE650E	e-approved	4T	8579	
650 KLR 650		1997-2018								
GAMMA	LINEA	TIPO	MATERIALE	COPPA	STANDARD	TYPE	HOM.	2T/4T	ART.	
LEOVINCE	X3	SLIP-ON	ALUMINUM	N/A			e-approved	4T	3549	
650 NINJA 650		2017-2018								
GAMMA	LINEA	TIPO	MATERIALE	COPPA	STANDARD	TYPE	HOM.	2T/4T	ART.	
LEOVINCE	GP DUALS	FULL SYSTEM 2/1	STAINLESS STEEL	STAINLESS STEEL	EURO 4	EX650K; K1/X - EX650KA2; KA2/X	dB(A) Compliant (35kW)	4T	15113	
LEOVINCE	GP DUALS	FULL SYSTEM 2/1	STAINLESS STEEL	STAINLESS STEEL	EURO 4	EX650K; K1/X - EX650KA2; KA2/X	ECE/EU-Approved (35kW)	4T	15113K	
LEOVINCE	LV ONE EVO	FULL SYSTEM 2/1	STAINLESS STEEL	CARBON FIBER	EURO 4	EX650K; K1/X - EX650KA2; KA2/X	ECE/EU-Approved (35kW)	4T	14181EK	
LEOVINCE	LV ONE EVO	FULL SYSTEM 2/1	CARBON FIBER	CARBON FIBER	EURO 4	EX650K; K1/X - EX650KA2; KA2/X	ECE/EU-Approved (35kW)	4T	14182EK	
LEOVINCE	UNDERBODY	FULL SYSTEM 2/1	STAINLESS STEEL	CARBON FIBER	EURO 4	EX650K; K1/X - EX650KA2; KA2/X	dB(A) Compliant (35kW)	4T	14170	
LEOVINCE	UNDERBODY	FULL SYSTEM 2/1	STAINLESS STEEL	CARBON FIBER	EURO 4	EX650K; K1/X - EX650KA2; KA2/X	ECE/EU-Approved (35kW)	4T	14170K	
LEOVINCE	LV ONE EVO	FULL SYSTEM 2/1	STAINLESS STEEL	CARBON FIBER	EURO 4	EX650K; K1/X - EX650KA2; KA2/X	dB(A) Compliant (35kW)	4T	14181E	
LEOVINCE	LV ONE EVO	FULL SYSTEM 2/1	CARBON FIBER	CARBON FIBER	EURO 4	EX650K; K1/X - EX650KA2; KA2/X	dB(A) Compliant (35kW)	4T	14182E	
650 VERSYS 650		2007-2014								
GAMMA	LINEA	TIPO	MATERIALE	COPPA	STANDARD	TYPE	HOM.	2T/4T	ART.	
LEOVINCE	GP STYLE	SLIP-ON	STAINLESS STEEL	N/A	EURO 3		e-approved	4T	7918	
LEOVINCE	GP STYLE BLACK	SLIP-ON	STAINLESS STEEL	N/A	EURO 3		e-approved	4T	7918B	
LEOVINCE	UNDERBODY	SLIP-ON	STAINLESS STEEL	CARBON FIBER	EURO 3		e-approved	4T	8242	
650 VERSYS 650		2015-2016								
GAMMA	LINEA	TIPO	MATERIALE	COPPA	STANDARD	TYPE	HOM.	2T/4T	ART.	
LEOVINCE	UNDERBODY	FULL SYSTEM 2/1	STAINLESS STEEL	CARBON FIBER	EURO 3	ER650A/LE650E	e-approved	4T	8579	

CC. MODELLO		ANNO								
650 Z 650		2017-2018								
GAMMA	LINEA	TIPO	MATERIALE	COPPA	STANDARD	TYPE	HOM.	2T/4T	ART.	
LEOVINCE	GP DUALS	FULL SYSTEM 2/1	STAINLESS STEEL	STAINLESS STEEL	EURO 4	ER650H; H1/X - ER650HA2; HA2/X (35kW)	dB(A) Compliant	4T	15113	
LEOVINCE	GP DUALS	FULL SYSTEM 2/1	STAINLESS STEEL	STAINLESS STEEL	EURO 4	ER650H; H1/X - ER650HA2; HA2/X (35kW)	ECE/EU-Approved	4T	15113K	
LEOVINCE	LV ONE EVO	FULL SYSTEM 2/1	STAINLESS STEEL	CARBON FIBER	EURO 4	ER650H; H1/X - ER650HA2; HA2/X (35kW)	ECE/EU-Approved	4T	14181EK	
LEOVINCE	LV ONE EVO	FULL SYSTEM 2/1	CARBON FIBER	CARBON FIBER	EURO 4	ER650H; H1/X - ER650HA2; HA2/X (35kW)	ECE/EU-Approved	4T	14182EK	
LEOVINCE	UNDERBODY	FULL SYSTEM 2/1	STAINLESS STEEL	CARBON FIBER	EURO 4	ER650H; H1/X - ER650HA2; HA2/X (35kW)	dB(A) Compliant	4T	14170	
LEOVINCE	UNDERBODY	FULL SYSTEM 2/1	STAINLESS STEEL	CARBON FIBER	EURO 4	ER650H; H1/X - ER650HA2; HA2/X (35kW)	ECE/EU-Approved	4T	14170K	
LEOVINCE	LV ONE EVO	FULL SYSTEM 2/1	STAINLESS STEEL	CARBON FIBER	EURO 4	ER650H; H1/X - ER650HA2; HA2/X (35kW)	dB(A) Compliant	4T	14181E	
LEOVINCE	LV ONE EVO	FULL SYSTEM 2/1	CARBON FIBER	CARBON FIBER	EURO 4	ER650H; H1/X - ER650HA2; HA2/X (35kW)	dB(A) Compliant	4T	14182E	
750 Z 750		2007-2014								
GAMMA	LINEA	TIPO	MATERIALE	COPPA	STANDARD	TYPE	HOM.	2T/4T	ART.	
LEOVINCE	NERO	SLIP-ON	STAINLESS STEEL	CARBON FIBER	EURO 3	ZR750J	e-approved	4T	14007	
LEOVINCE	LV ONE EVO	SLIP-ON	STAINLESS STEEL	CARBON FIBER	EURO 3	ZR750J	e-approved	4T	8410E	
LEOVINCE	LV ONE EVO	SLIP-ON	CARBON FIBER	CARBON FIBER	EURO 3	ZR750J	e-approved	4T	8411E	
LEOVINCE	GP STYLE	SLIP-ON	STAINLESS STEEL	N/A	EURO 3	ZR750J	e-approved	4T	7917	
LEOVINCE	GP STYLE BLACK	SLIP-ON	STAINLESS STEEL	N/A	EURO 3		e-approved	4T	7917B	
750 Z 750 R		2011-2014								
GAMMA	LINEA	TIPO	MATERIALE	COPPA	STANDARD	TYPE	HOM.	2T/4T	ART.	
LEOVINCE	GP STYLE	SLIP-ON	STAINLESS STEEL	N/A	EURO 3	ZR750N	e-approved	4T	7917	
LEOVINCE	GP STYLE BLACK	SLIP-ON	STAINLESS STEEL	N/A	EURO 3		e-approved	4T	7917B	
LEOVINCE	LV ONE EVO	SLIP-ON	STAINLESS STEEL	CARBON FIBER	EURO 3	ZR750N	e-approved	4T	8410E	
LEOVINCE	NERO	SLIP-ON	STAINLESS STEEL	CARBON FIBER	EURO 3	ZR750N	e-approved	4T	14007	
750 Z 750 R		2011-2014								
GAMMA	LINEA	TIPO	MATERIALE	COPPA	STANDARD	TYPE	HOM.	2T/4T	ART.	
LEOVINCE	LV ONE EVO	SLIP-ON	CARBON FIBER	CARBON FIBER	EURO 3	ZR750N	e-approved	4T	8411E	
800 VN 800 CLASSIC		1996-2006								
GAMMA	LINEA	TIPO	MATERIALE	COPPA	STANDARD	TYPE	HOM.	2T/4T	ART.	
SILVERTAIL	K02	FULL SYSTEM	CHROMED STEEL	N/A			e-approved	4T	2207	
800 Z 800		2013-2016								
GAMMA	LINEA	TIPO	MATERIALE	COPPA	STANDARD	TYPE	HOM.	2T/4T	ART.	
LEOVINCE	GP DUALS	SLIP-ON	STAINLESS STEEL	STAINLESS STEEL	EURO 3	ZR800A var.A/B ver.1/1 - ZR800F var.F1 ver.X	e*-approved	4T	15103	
LEOVINCE	LV-10	SLIP-ON	STAINLESS STEEL	STAINLESS STEEL	EURO 3		Racing use only	4T	15214	
LEOVINCE	LV-10 BLACK	SLIP-ON	STAINLESS STEEL	STAINLESS STEEL	EURO 3		Racing use only	4T	15214B	
LEOVINCE	LV ONE EVO	SLIP-ON	STAINLESS STEEL	CARBON FIBER	EURO 3	ZR800A	e*-approved	4T	8777E	
LEOVINCE	LV ONE EVO	SLIP-ON	CARBON FIBER	CARBON FIBER	EURO 3	ZR800A	e*-approved	4T	8778E	
LEOVINCE	NERO	SLIP-ON	STAINLESS STEEL	CARBON FIBER	EURO 3	ZR800A	e*-approved	4T	14008	

CC. MODELLO			ANNO							
800 Z 800 E			2013-2016							
GAMMA	LINEA	TIPO	MATERIALE	COPPA	STANDARD	TYPE	HOM.	2T/4T	ART.	
LEOVINCE	GP DUALS	SLIP-ON	STAINLESS STEEL	STAINLESS STEEL	EURO 3	ZR800C var.C1/D1 ver.X/X	e*-approved	4T	15104	
LEOVINCE	LV ONE EVO	SLIP-ON	STAINLESS STEEL	CARBON FIBER	EURO 3	ZR800A	e*-approved	4T	8782E	
LEOVINCE	LV ONE EVO	SLIP-ON	CARBON FIBER	CARBON FIBER	EURO 3	ZR800A	e*-approved	4T	8783E	
LEOVINCE	NERO	SLIP-ON	STAINLESS STEEL	CARBON FIBER	EURO 3	ZR800A	e*-approved	4T	14017	
900 VN 900 CLASSIC			2006-2016							
GAMMA	LINEA	TIPO	MATERIALE	COPPA	STANDARD	TYPE	HOM.	2T/4T	ART.	
SILVERTAIL	K02	FULL SYSTEM	CHROMED STEEL	N/A			e-approved	4T	2404	
900 VN 900 CUSTOM			2007-2016							
GAMMA	LINEA	TIPO	MATERIALE	COPPA	STANDARD	TYPE	HOM.	2T/4T	ART.	
SILVERTAIL	K02	FULL SYSTEM	CHROMED STEEL	N/A			e-approved	4T	2404	
900 Z 900 (also fit 35Kw & 70Kw versions)			2017-2018							
GAMMA	LINEA	TIPO	MATERIALE	COPPA	STANDARD	TYPE	HOM.	2T/4T	ART.	
LEOVINCE	CARTER	N/A	N/A	N/A	EURO 4		N/A	4T	8085	
LEOVINCE	FACTORY S	SLIP-ON	STAINLESS STEEL	CARBON FIBER	EURO 4	ZR900B var. B1 ver.X;X1;X2 - ZR900D var.D1 ver.E - ZR900DA2 var.DA2 ver.E	ECE-Approved	4T	14173S	
LEOVINCE	FACTORY S	SLIP-ON	CARBON FIBER	CARBON FIBER	EURO 4	ZR900B var. B1 ver.X;X1;X2 - ZR900D var.D1 ver.E - ZR900DA2 var.DA2 ver.E	ECE-Approved	4T	14174S	
LEOVINCE	LV PRO	SLIP-ON	STAINLESS STEEL	CARBON FIBER	EURO 4	ZR900B var. B1 ver.X;X1;X2 - ZR900D var.D1 ver.E - ZR900DA2 var.DA2 ver.E	ECE-Approved	4T	14171E	
LEOVINCE	LV PRO	SLIP-ON	CARBON FIBER	CARBON FIBER	EURO 4	ZR900B var. B1 ver.X;X1;X2 - ZR900D var.D1 ver.E - ZR900DA2 var.DA2 ver.E	ECE-Approved	4T	14172E	
LEOVINCE	NERO	SLIP-ON	STAINLESS STEEL	CARBON FIBER	EURO 4	ZR900B var. B1 ver.X;X1;X2 - ZR900D var.D1 ver.E - ZR900DA2 var.DA2 ver.E	ECE-Approved	4T	14039	
LEOVINCE	GP DUALS	SLIP-ON	STAINLESS STEEL	STAINLESS STEEL	EURO 4	ZR900B var. B1 ver.X;X1;X2 - ZR900D var.D1 ver.E - ZR900DA2 var.DA2 ver.E	ECE-Approved	4T	15114	
LEOVINCE	LV-10	SLIP-ON	STAINLESS STEEL	STAINLESS STEEL	EURO 4	ZR900B var. B1 ver.X;X1;X2 - ZR900D var.D1 ver.E - ZR900DA2 var.DA2 ver.E	ECE-Approved	4T	15204	
LEOVINCE	LV-10 BLACK	SLIP-ON	STAINLESS STEEL	STAINLESS STEEL	EURO 4	ZR900B var. B1 ver.X;X1;X2 - ZR900D var.D1 ver.E - ZR900DA2 var.DA2 ver.E	ECE-Approved	4T	15204B	
900 Z 900 (compatible with original and LeoVince exhaust)			2017-2018							
GAMMA	LINEA	TIPO	MATERIALE	COPPA	STANDARD	TYPE	HOM.	2T/4T	ART.	
SILVERTAIL	HEADERS PIPES	N/A	N/A	N/A	EURO 4		Racing use only	4T	8091	
900 Z 900 RS/CAFE (compatible with original and LeoVince exhaust) (fits with original centre stand)			2018-							
GAMMA	LINEA	TIPO	MATERIALE	COPPA	STANDARD	TYPE	HOM.	2T/4T	ART.	
LEOVINCE	HEADERS PIPES	N/A	N/A	N/A	EURO 4		Racing use only	4T	8090	



CC. MODELLO		ANNO								
900 Z 900 RS/CAFE (fits with original centre stand)		2018-								
GAMMA	LINEA	TIPO	MATERIALE	COPPA	STANDARD	TYPE	HOM.	2T/4T	ART.	
LEOVINCE	GP DUALS	SLIP-ON	STAINLESS STEEL	STAINLESS STEEL	EURO 4	ZR900C var.C1/E1 ver.E/B	ECE-Approved	4T	15119	
LEOVINCE	LV-10	SLIP-ON	STAINLESS STEEL	STAINLESS STEEL	EURO 4	ZR900C var.C1/E1 ver.E/B	ECE-Approved	4T	15216	
LEOVINCE	LV-10 BLACK	SLIP-ON	STAINLESS STEEL	STAINLESS STEEL	EURO 4	ZR900C var.C1/E1 ver.E/B	ECE-Approved	4T	15216B	
1000 Z 1000		2010-2016								
GAMMA	LINEA	TIPO	MATERIALE	COPPA	STANDARD	TYPE	HOM.	2T/4T	ART.	
LEOVINCE	LV-10	2 SLIP-ON	STAINLESS STEEL	STAINLESS STEEL	EURO 3		Racing use only	4T	15209	
LEOVINCE	LV-10 BLACK	2 SLIP-ON	STAINLESS STEEL	STAINLESS STEEL	EURO 3		Racing use only	4T	15209B	
LEOVINCE	LV ONE EVO	2 SLIP-ON	STAINLESS STEEL	CARBON FIBER	EURO 3		e*-approved	4T	8412E	
LEOVINCE	LV ONE EVO	2 SLIP-ON	CARBON FIBER	CARBON FIBER	EURO 3		e*-approved	4T	8413E	
1000 Z 1000		2017-2018								
GAMMA	LINEA	TIPO	MATERIALE	COPPA	STANDARD	TYPE	HOM.	2T/4T	ART.	
LEOVINCE	FACTORY S	2 SLIP-ON	STAINLESS STEEL	CARBON FIBER	EURO 4	ZRT00H var.H1/J1 ver.X/X	ECE-Approved	4T	14223S	
LEOVINCE	FACTORY S	2 SLIP-ON	CARBON FIBER	CARBON FIBER	EURO 4	ZRT00H var.H1/J1 ver.X/X	ECE-Approved	4T	14224S	
LEOVINCE	LV PRO	2 SLIP-ON	STAINLESS STEEL	CARBON FIBER	EURO 4	ZRT00H var.H1/J1 ver.X/X	ECE-Approved	4T	14221E	
LEOVINCE	LV PRO	2 SLIP-ON	CARBON FIBER	CARBON FIBER	EURO 4	ZRT00H var.H1/J1 ver.X/X	ECE-Approved	4T	14222E	
LEOVINCE	LV-10	2 SLIP-ON	STAINLESS STEEL	STAINLESS STEEL	EURO 4	ZXT00W var.W1 ver.X	ECE-Approved	4T	15209	
LEOVINCE	LV-10 BLACK	2 SLIP-ON	STAINLESS STEEL	STAINLESS STEEL	EURO 4	ZXT00W var.W1 ver.X	ECE-Approved	4T	15209B	
LEOVINCE	NERO	2 SLIP-ON	STAINLESS STEEL	CARBON FIBER	EURO 4	ZRT00H var.H1/J1 ver.X/X	ECE-Approved	4T	14049	
1000 Z 1000 SX (do not fit with original panniers)		2017-2018								
GAMMA	LINEA	TIPO	MATERIALE	COPPA	STANDARD	TYPE	HOM.	2T/4T	ART.	
LEOVINCE	LV PRO	2 SLIP-ON	STAINLESS STEEL	CARBON FIBER	EURO 4	ZXT00W var.W1 ver.X	ECE-Approved	4T	14221E	
LEOVINCE	LV PRO	2 SLIP-ON	CARBON FIBER	CARBON FIBER	EURO 4	ZXT00W var.W1 ver.X	ECE-Approved	4T	14222E	
1000 Z 1000 SX (do not fit with panniers)		2010-2016								
GAMMA	LINEA	TIPO	MATERIALE	COPPA	STANDARD	TYPE	HOM.	2T/4T	ART.	
LEOVINCE	LV-10	2 SLIP-ON	STAINLESS STEEL	STAINLESS STEEL	EURO 3		Racing use only	4T	15209	
LEOVINCE	LV-10 BLACK	2 SLIP-ON	STAINLESS STEEL	STAINLESS STEEL	EURO 3		Racing use only	4T	15209B	
1000 Z 1000 SX (do not fit with panniers)		2017-2018								
GAMMA	LINEA	TIPO	MATERIALE	COPPA	STANDARD	TYPE	HOM.	2T/4T	ART.	
LEOVINCE	LV-10	2 SLIP-ON	STAINLESS STEEL	STAINLESS STEEL	EURO 4	ZXT00W var.W1 ver.X	ECE-Approved	4T	15209	
LEOVINCE	LV-10 BLACK	2 SLIP-ON	STAINLESS STEEL	STAINLESS STEEL	EURO 4	ZXT00W var.W1 ver.X	ECE-Approved	4T	15209B	
1000 Z 1000 SX (fits with original panniers)		2010-2013								
GAMMA	LINEA	TIPO	MATERIALE	COPPA	STANDARD	TYPE	HOM.	2T/4T	ART.	
LEOVINCE	LV ONE EVO	2 SLIP-ON	STAINLESS STEEL	CARBON FIBER	EURO 3		e*-approved	4T	8496E	
LEOVINCE	LV ONE EVO	2 SLIP-ON	CARBON FIBER	CARBON FIBER	EURO 3		e*-approved	4T	8497E	

CC. MODELLO		ANNO								
1000 Z 1000 SX (fits with original panniers)		2014-2016								
GAMMA	LINEA	TIPO	MATERIALE	COPPA	STANDARD	TYPE	HOM.	2T/4T	ART.	
LEOVINCE	FACTORY S	2 SLIP-ON	STAINLESS STEEL	CARBON FIBER	EURO 3	ZXT00L	e*-approved	4T	14146S	
LEOVINCE	FACTORY S	2 SLIP-ON	CARBON FIBER	CARBON FIBER	EURO 3	ZXT00L	e*-approved	4T	14147S	
LEOVINCE	LV ONE EVO	2 SLIP-ON	STAINLESS STEEL	CARBON FIBER	EURO 3	ZXT00L	e*-approved	4T	14144E	
LEOVINCE	LV ONE EVO	2 SLIP-ON	CARBON FIBER	CARBON FIBER	EURO 3	ZXT00L	e*-approved	4T	14145E	
LEOVINCE	NERO	2 SLIP-ON	STAINLESS STEEL	CARBON FIBER	EURO 3	ZXT00L	e*-approved	4T	14029	
1000 Z 1000 SX (fits with original panniers)		2017-2018								
GAMMA	LINEA	TIPO	MATERIALE	COPPA	STANDARD	TYPE	HOM.	2T/4T	ART.	
LEOVINCE	FACTORY S	2 SLIP-ON	STAINLESS STEEL	CARBON FIBER	EURO 4	ZXT00W var.W1 ver.X	ECE-Approved	4T	14223S	
LEOVINCE	FACTORY S	2 SLIP-ON	CARBON FIBER	CARBON FIBER	EURO 4	ZXT00W var.W1 ver.X	ECE-Approved	4T	14224S	
LEOVINCE	NERO	2 SLIP-ON	STAINLESS STEEL	CARBON FIBER	EURO 4	c	ECE-Approved	4T	14049	
1000 ZX-10R NINJA		2011-2015								
GAMMA	LINEA	TIPO	MATERIALE	COPPA	STANDARD	TYPE	HOM.	2T/4T	ART.	
LEOVINCE	CAT ELIMINATOR (LINK PIPE)	N/A	N/A	N/A	EURO 3		Racing use only	4T	8058	
LEOVINCE	FACTORY S	SLIP-ON	STAINLESS STEEL	CARBON FIBER	EURO 3		e*-approved	4T	8421S	
1000 ZX-10R NINJA		2016-2018								
GAMMA	LINEA	TIPO	MATERIALE	COPPA	STANDARD	TYPE	HOM.	2T/4T	ART.	
LEOVINCE	CAT ELIMINATOR (LINK PIPE)	N/A	N/A	N/A	EURO 4	ZXT00S	Racing use only	4T	8081	
LEOVINCE	FACTORY S	SLIP-ON	STAINLESS STEEL	CARBON FIBER	EURO 4	ZXT00S	ECE-Approved	4T	14142S	
LEOVINCE	FACTORY S	SLIP-ON	CARBON FIBER	CARBON FIBER	EURO 4	ZXT00S	ECE-Approved	4T	14143S	
1000 ZX-10R NINJA (low & high mount)		2016-2018								
GAMMA	LINEA	TIPO	MATERIALE	COPPA	STANDARD	TYPE	HOM.	2T/4T	ART.	
LEOVINCE	LV-10	SLIP-ON	STAINLESS STEEL	STAINLESS STEEL	EURO 4		Racing use only	4T	15200	
LEOVINCE	LV-10 BLACK	SLIP-ON	STAINLESS STEEL	STAINLESS STEEL	EURO 4		Racing use only	4T	15200B	
1000 ZX-10RR NINJA		2017-2018								
GAMMA	LINEA	TIPO	MATERIALE	COPPA	STANDARD	TYPE	HOM.	2T/4T	ART.	
LEOVINCE	CAT ELIMINATOR (LINK PIPE)	N/A	N/A	N/A	EURO 4	ZXT00S	Racing use only	4T	8081	
LEOVINCE	FACTORY S	SLIP-ON	STAINLESS STEEL	CARBON FIBER	EURO 4	ZXT00S	ECE-Approved	4T	14142S	
LEOVINCE	FACTORY S	SLIP-ON	CARBON FIBER	CARBON FIBER	EURO 4	ZXT00S	ECE-Approved	4T	14143S	
1000 ZX-10RR NINJA (low & high mount)		2017-2018								
GAMMA	LINEA	TIPO	MATERIALE	COPPA	STANDARD	TYPE	HOM.	2T/4T	ART.	
LEOVINCE	LV-10	SLIP-ON	STAINLESS STEEL	STAINLESS STEEL	EURO 4		Racing use only	4T	15200	
LEOVINCE	LV-10 BLACK	SLIP-ON	STAINLESS STEEL	STAINLESS STEEL	EURO 4		Racing use only	4T	15200B	
1400 ZZR 1400/ZX 14 R		2012-2015								
GAMMA	LINEA	TIPO	MATERIALE	COPPA	STANDARD	TYPE	HOM.	2T/4T	ART.	
LEOVINCE	FACTORY S	2 SLIP-ON	STAINLESS STEEL	CARBON FIBER	EURO 3		e-approved	4T	8718S	
LEOVINCE	FACTORY S	2 SLIP-ON	CARBON FIBER	CARBON FIBER	EURO 3		e-approved	4T	8717S	
1500 VN 1500 CLASSIC		1996-1999								
GAMMA	LINEA	TIPO	MATERIALE	COPPA	STANDARD	TYPE	HOM.	2T/4T	ART.	
SILVERTAIL	K02	FULL SYSTEM	CHROMED STEEL	N/A			e-approved	4T	2286	

# KAWASAKI

CC. MODELLO	ANNO									
1600 VN 1600 CLASSIC	2003-2005									
GAMMA	LINEA	TIPO	MATERIALE	COPPA	STANDARD	TYPE	HOM.	2T/4T	ART.	
SILVERTAIL	K02	FULL SYSTEM	CHROMED STEEL	N/A			e-approved	4T	2286	

# KEEWAY

CC. MODELLO	ANNO									
50 FACT 50 (TABM)	-									
GAMMA	LINEA	TIPO	MATERIALE	COPPA	STANDARD	TYPE	HOM.	2T/4T	ART.	
LEOVINCE	HAND MADE TT	FULL SYSTEM	ALUMINUM	N/A			e-approved	2T	7404	
LEOVINCE	HAND MADE TT BLACK	FULL SYSTEM	ALUMINUM	N/A			e-approved	2T	7404B	
SITO	SITO	FULL SYSTEM	STEEL	N/A			Not approved	2T	0718	

50 FOCUS 50	-									
GAMMA	LINEA	TIPO	MATERIALE	COPPA	STANDARD	TYPE	HOM.	2T/4T	ART.	
LEOVINCE	HAND MADE TT	FULL SYSTEM	ALUMINUM	N/A			e-approved	2T	4039	
LEOVINCE	HAND MADE TT BLACK	FULL SYSTEM	ALUMINUM	N/A			e-approved	2T	4039B	

50 MATRIX 50	-									
GAMMA	LINEA	TIPO	MATERIALE	COPPA	STANDARD	TYPE	HOM.	2T/4T	ART.	
LEOVINCE	HAND MADE TT	FULL SYSTEM	ALUMINUM	N/A			e-approved	2T	4039	
LEOVINCE	HAND MADE TT BLACK	FULL SYSTEM	ALUMINUM	N/A			e-approved	2T	4039B	

# KTM

CC. MODELLO	ANNO									
125 DUKE 125	2011-2016									
GAMMA	LINEA	TIPO	MATERIALE	COPPA	STANDARD	TYPE	HOM.	2T/4T	ART.	
LEOVINCE	GP STYLE	SLIP-ON	STAINLESS STEEL	N/A	EURO 3		e-approved	4T	8566	
LEOVINCE	GP STYLE BLACK	SLIP-ON	STAINLESS STEEL	N/A	EURO 3		e-approved	4T	8566B	
LEOVINCE	LV ONE	SLIP-ON	STAINLESS STEEL	TECHNOPOLYMER	EURO 3		e-approved	4T	8725	

125 DUKE 125	2017-2018									
GAMMA	LINEA	TIPO	MATERIALE	COPPA	STANDARD	TYPE	HOM.	2T/4T	ART.	
LEOVINCE	CAT ELIMINATOR (LINK PIPE)	N/A	N/A	N/A	EURO 4		Racing use only	4T	8086	
LEOVINCE	GP ONE	SLIP-ON	STAINLESS STEEL	STAINLESS STEEL	EURO 4	KTM IS Duke; KTM 125 Duke/-	ECE-Approved	4T	15116	
LEOVINCE	LV ONE EVO	SLIP-ON	STAINLESS STEEL	CARBON FIBER	EURO 4	KTM IS Duke; KTM 125 Duke/-	ECE-Approved	4T	14185E	
LEOVINCE	LV ONE EVO	SLIP-ON	CARBON FIBER	CARBON FIBER	EURO 4	KTM IS Duke; KTM 125 Duke/-	ECE-Approved	4T	14186E	
LEOVINCE	LV PRO	SLIP-ON	STAINLESS STEEL	CARBON FIBER	EURO 4	KTM IS Duke; KTM 125 Duke/-	Racing use only	4T	14183E	
LEOVINCE	LV PRO	SLIP-ON	CARBON FIBER	CARBON FIBER	EURO 4	KTM IS Duke; KTM 125 Duke/-	Racing use only	4T	14184E	

125 RC 125	2014-2016									
GAMMA	LINEA	TIPO	MATERIALE	COPPA	STANDARD	TYPE	HOM.	2T/4T	ART.	
LEOVINCE	GP STYLE	SLIP-ON	STAINLESS STEEL	N/A	EURO 3	RC; A1/-	e-approved	4T	14169	
LEOVINCE	GP STYLE BLACK	SLIP-ON	STAINLESS STEEL	N/A	EURO 3	RC; A1/-	e-approved	4T	14169B	
LEOVINCE	LV ONE EVO	SLIP-ON	STAINLESS STEEL	CARBON FIBER	EURO 3	RC; A1/-	e-approved	4T	14167E	
LEOVINCE	LV ONE EVO	SLIP-ON	CARBON FIBER	CARBON FIBER	EURO 3	RC; A1/-	e-approved	4T	14168E	
LEOVINCE	NERO	SLIP-ON	STAINLESS STEEL	CARBON FIBER	EURO 3	RC; A1/-	e-approved	4T	14038	

CC. MODELLO		ANNO								
125 RC 125		2017-2018								
GAMMA	LINEA	TIPO	MATERIALE	COPPA	STANDARD	TYPE	HOM.	2T/4T	ART.	
LEOVINCE	CAT ELIMINATOR (LINK PIPE)	N/A	N/A	N/A	EURO 4		Racing use only	4T	8086	
LEOVINCE	GP ONE	SLIP-ON	STAINLESS STEEL	STAINLESS STEEL	EURO 4	KTM IS RC; KTM RC 125/-	ECE-Approved	4T	15116	
LEOVINCE	LV ONE EVO	SLIP-ON	STAINLESS STEEL	CARBON FIBER	EURO 4	KTM IS RC; KTM RC 125/-	ECE-Approved	4T	14185E	
LEOVINCE	LV ONE EVO	SLIP-ON	CARBON FIBER	CARBON FIBER	EURO 4	KTM IS RC; KTM RC 125/-	ECE-Approved	4T	14186E	
LEOVINCE	LV PRO	SLIP-ON	STAINLESS STEEL	CARBON FIBER	EURO 4	KTM IS RC; KTM RC 125/-	Racing use only	4T	14183E	
LEOVINCE	LV PRO	SLIP-ON	CARBON FIBER	CARBON FIBER	EURO 4	KTM IS RC; KTM RC 125/-	Racing use only	4T	14184E	
200 DUKE 200		2012-2014								
GAMMA	LINEA	TIPO	MATERIALE	COPPA	STANDARD	TYPE	HOM.	2T/4T	ART.	
LEOVINCE	GP STYLE	SLIP-ON	STAINLESS STEEL	N/A	EURO 3		e-approved	4T	8566	
LEOVINCE	GP STYLE BLACK	SLIP-ON	STAINLESS STEEL	N/A	EURO 3		e-approved	4T	8566B	
LEOVINCE	LV ONE	SLIP-ON	STAINLESS STEEL	TECHNOPOLYMER	EURO 3		e-approved	4T	8725	
390 DUKE 390		2013-2016								
GAMMA	LINEA	TIPO	MATERIALE	COPPA	STANDARD	TYPE	HOM.	2T/4T	ART.	
LEOVINCE	GP STYLE	SLIP-ON	STAINLESS STEEL	N/A	EURO 3	Duke; C2/-, C3/-	e-approved	4T	14166	
LEOVINCE	GP STYLE BLACK	SLIP-ON	STAINLESS STEEL	N/A	EURO 3	Duke; C2/-, C3/-	e-approved	4T	14166B	
LEOVINCE	LV ONE EVO	SLIP-ON	STAINLESS STEEL	CARBON FIBER	EURO 3	Duke; C2/-, C3/-	e-approved	4T	14164E	
LEOVINCE	LV ONE EVO	SLIP-ON	CARBON FIBER	CARBON FIBER	EURO 3	Duke; C2/-, C3/-	e-approved	4T	14165E	
LEOVINCE	NERO	SLIP-ON	STAINLESS STEEL	CARBON FIBER	EURO 3	Duke; C2/-, C3/-	e-approved	4T	14037	
390 DUKE 390		2017-2018								
GAMMA	LINEA	TIPO	MATERIALE	COPPA	STANDARD	TYPE	HOM.	2T/4T	ART.	
LEOVINCE	CAT ELIMINATOR (LINK PIPE)	N/A	N/A	N/A	EURO 4		Racing use only	4T	8086	
LEOVINCE	GP ONE	SLIP-ON	STAINLESS STEEL	STAINLESS STEEL	EURO 4	KTM IS Duke/A/N.a.	ECE-Approved	4T	15116	
LEOVINCE	LV ONE EVO	SLIP-ON	STAINLESS STEEL	CARBON FIBER	EURO 4	KTM IS Duke/A/N.a.	ECE-Approved	4T	14185E	
LEOVINCE	LV ONE EVO	SLIP-ON	CARBON FIBER	CARBON FIBER	EURO 4	KTM IS Duke/A/N.a.	ECE-Approved	4T	14186E	
LEOVINCE	LV PRO	SLIP-ON	STAINLESS STEEL	CARBON FIBER	EURO 4	KTM IS Duke/A/N.a.	Racing use only	4T	14183E	
LEOVINCE	LV PRO	SLIP-ON	CARBON FIBER	CARBON FIBER	EURO 4	KTM IS Duke/A/N.a.	Racing use only	4T	14184E	
390 RC 390		2017-2018								
GAMMA	LINEA	TIPO	MATERIALE	COPPA	STANDARD	TYPE	HOM.	2T/4T	ART.	
LEOVINCE	CAT ELIMINATOR (LINK PIPE)	N/A	N/A	N/A	EURO 4		Racing use only	4T	8086	
LEOVINCE	GP ONE	SLIP-ON	STAINLESS STEEL	STAINLESS STEEL	EURO 4	KTM IS RC; KTM RC 390/-	ECE-Approved	4T	15116	
LEOVINCE	LV ONE EVO	SLIP-ON	STAINLESS STEEL	CARBON FIBER	EURO 4	KTM IS RC; KTM RC 390/-	ECE-Approved	4T	14185E	
LEOVINCE	LV ONE EVO	SLIP-ON	CARBON FIBER	CARBON FIBER	EURO 4	KTM IS RC; KTM RC 390/-	ECE-Approved	4T	14186E	
LEOVINCE	LV PRO	SLIP-ON	STAINLESS STEEL	CARBON FIBER	EURO 4	KTM IS RC; KTM RC 390/-	Racing use only	4T	14183E	
LEOVINCE	LV PRO	SLIP-ON	CARBON FIBER	CARBON FIBER	EURO 4	KTM IS RC; KTM RC 390/-	Racing use only	4T	14184E	
640 LC4 640 SM/ENDURO		2003-2004								
GAMMA	LINEA	TIPO	MATERIALE	COPPA	STANDARD	TYPE	HOM.	2T/4T	ART.	
LEOVINCE	X3	SLIP-ON	ALUMINUM	N/A			e-approved	4T	3940E	

CC. MODELLO		ANNO								
660 LC4 660 SM/ENDURO		2004-2005								
GAMMA	LINEA	TIPO	MATERIALE	COPPA	STANDARD	TYPE	HOM.	2T/4T	ART.	
LEOVINCE	X3	SLIP-ON	ALUMINUM	N/A			e-approved	4T	3940E	
690 690 DUKE		2012-2015								
GAMMA	LINEA	TIPO	MATERIALE	COPPA	STANDARD	TYPE	HOM.	2T/4T	ART.	
LEOVINCE	LV ONE EVO	SLIP-ON	CARBON FIBER	CARBON FIBER	EURO 3		e*-approved	4T	8703E	
LEOVINCE	CAT ELIMINATOR (LINK PIPE)	N/A	N/A	N/A	EURO 3		Racing use only	4T	8070	
LEOVINCE	LV ONE EVO	SLIP-ON	STAINLESS STEEL	CARBON FIBER	EURO 3		e*-approved	4T	8702E	
690 690 DUKE LC4		2008-2011								
GAMMA	LINEA	TIPO	MATERIALE	COPPA	STANDARD	TYPE	HOM.	2T/4T	ART.	
LEOVINCE	UNDERBODY	SLIP-ON	STAINLESS STEEL	CARBON FIBER	EURO 3		e-approved	4T	8258	
690 690 DUKE R LC4		2009-2011								
GAMMA	LINEA	TIPO	MATERIALE	COPPA	STANDARD	TYPE	HOM.	2T/4T	ART.	
LEOVINCE	UNDERBODY	SLIP-ON	STAINLESS STEEL	CARBON FIBER	EURO 3		e-approved	4T	8258	
690 690 ENDURO		2008-2011								
GAMMA	LINEA	TIPO	MATERIALE	COPPA	STANDARD	TYPE	HOM.	2T/4T	ART.	
LEOVINCE	LV ONE EVO	SLIP-ON	STAINLESS STEEL	CARBON FIBER	EURO 3	LC4	e-approved	4T	8299E	
690 690 ENDURO R		2009-2016								
GAMMA	LINEA	TIPO	MATERIALE	COPPA	STANDARD	TYPE	HOM.	2T/4T	ART.	
LEOVINCE	LV ONE EVO	SLIP-ON	STAINLESS STEEL	CARBON FIBER	EURO 3		e-approved	4T	8299E	
690 690 SMC		2008-2011								
GAMMA	LINEA	TIPO	MATERIALE	COPPA	STANDARD	TYPE	HOM.	2T/4T	ART.	
LEOVINCE	LV ONE EVO	SLIP-ON	STAINLESS STEEL	CARBON FIBER	EURO 3	LC4	e-approved	4T	8299E	
690 690 SMC R		2012-2016								
GAMMA	LINEA	TIPO	MATERIALE	COPPA	STANDARD	TYPE	HOM.	2T/4T	ART.	
LEOVINCE	LV ONE EVO	SLIP-ON	STAINLESS STEEL	CARBON FIBER	EURO 3		e-approved	4T	8299E	
790 790 DUKE		2018-								
GAMMA	LINEA	TIPO	MATERIALE	COPPA	STANDARD	TYPE	HOM.	2T/4T	ART.	
LEOVINCE	CAT ELIMINATOR (LINK PIPE)	N/A	N/A	N/A	EURO 4		Racing use only	4T	8094	
790 790 DUKE (do not fit with original panniers)		2018-								
GAMMA	LINEA	TIPO	MATERIALE	COPPA	STANDARD	TYPE	HOM.	2T/4T	ART.	
LEOVINCE	FACTORY S	SLIP-ON	STAINLESS STEEL	CARBON FIBER	EURO 4	KTM 790 Duke; KTM 790 Duke L	ECE-Approved	4T	14255S	
LEOVINCE	FACTORY S	SLIP-ON	CARBON FIBER	CARBON FIBER	EURO 4	KTM 790 Duke; KTM 790 Duke L	ECE-Approved	4T	14256S	
LEOVINCE	LV ONE EVO	SLIP-ON	STAINLESS STEEL	CARBON FIBER	EURO 4	KTM 790 Duke; KTM 790 Duke L	ECE-Approved	4T	14253E	
LEOVINCE	LV ONE EVO	SLIP-ON	CARBON FIBER	CARBON FIBER	EURO 4	KTM 790 Duke; KTM 790 Duke L	ECE-Approved	4T	14254E	
950 950 LC8 ADVENTURE S		2003-2005								
GAMMA	LINEA	TIPO	MATERIALE	COPPA	STANDARD	TYPE	HOM.	2T/4T	ART.	
LEOVINCE	LV ONE EVO	2 SLIP-ON	STAINLESS STEEL	CARBON FIBER	EURO 2/3	VBKVA440	e-approved	4T	8430E	

CC. MODELLO		ANNO								
950 950 SM SUPERMOTO		2005-2008								
GAMMA	LINEA	TIPO	MATERIALE	COPPA	STANDARD	TYPE	HOM.	2T/4T	ART.	
LEOVINCE	LV ONE EVO	2 SLIP-ON	CARBON FIBER	CARBON FIBER	EURO 3	LC8SM	e-approved	4T	8585E	
LEOVINCE	LV ONE EVO	2 SLIP-ON	STAINLESS STEEL	CARBON FIBER	EURO 2/3	LC8SM	e-approved	4T	8414E	
990 990 LC8 ADVENTURE		2006-2012								
GAMMA	LINEA	TIPO	MATERIALE	COPPA	STANDARD	TYPE	HOM.	2T/4T	ART.	
LEOVINCE	LV ONE EVO	2 SLIP-ON	STAINLESS STEEL	CARBON FIBER	EURO 3		e-approved	4T	8430E	
990 990 LC8 ADVENTURE R		2009-2012								
GAMMA	LINEA	TIPO	MATERIALE	COPPA	STANDARD	TYPE	HOM.	2T/4T	ART.	
LEOVINCE	LV ONE EVO	2 SLIP-ON	STAINLESS STEEL	CARBON FIBER	EURO 3	LC8SM	e-approved	4T	8430E	
990 990 SM R SUPERMOTO R		2009-2012								
GAMMA	LINEA	TIPO	MATERIALE	COPPA	STANDARD	TYPE	HOM.	2T/4T	ART.	
LEOVINCE	LV ONE EVO	2 SLIP-ON	STAINLESS STEEL	CARBON FIBER	EURO 3	LC8SM	e-approved	4T	8414E	
LEOVINCE	LV ONE EVO	2 SLIP-ON	CARBON FIBER	CARBON FIBER	EURO 3	LC8SM	e-approved	4T	8585E	
990 990 SM SUPERMOTO		2008-2010								
GAMMA	LINEA	TIPO	MATERIALE	COPPA	STANDARD	TYPE	HOM.	2T/4T	ART.	
LEOVINCE	LV ONE EVO	2 SLIP-ON	CARBON FIBER	CARBON FIBER	EURO 3	L3E	e-approved	4T	8585E	
LEOVINCE	LV ONE EVO	2 SLIP-ON	STAINLESS STEEL	CARBON FIBER	EURO 3	L3E	e-approved	4T	8414E	
1050 1050 ADVENTURE (Fits with rails for original and Givi panniers)		2015-2016								
GAMMA	LINEA	TIPO	MATERIALE	COPPA	STANDARD	TYPE	HOM.	2T/4T	ART.	
LEOVINCE	LV ONE EVO	SLIP-ON	STAINLESS STEEL	CARBON FIBER	EURO 3	KTM Adventure var. C1 / C2 - KTM Adventure var. A1/ A2/B1/B2 - KTM Adventure var. D1 / D2	e*-approved	4T	14159E	
LEOVINCE	NERO	SLIP-ON	STAINLESS STEEL	CARBON FIBER	EURO 3	KTM Adventure var. C1 / C2 - KTM Adventure var. A1/ A2/B1/B2 - KTM Adventure var. D1 / D2	e*-approved	4T	14033	
1050 1090 ADVENTURE/R (fits with rails for original and Givi panniers)		2017-2018								
GAMMA	LINEA	TIPO	MATERIALE	COPPA	STANDARD	TYPE	HOM.	2T/4T	ART.	
LEOVINCE	LV ONE EVO	SLIP-ON	STAINLESS STEEL	CARBON FIBER	EURO 4	KTM Adventure; A1/-, A2/-	ECE-Approved	4T	14192E	
LEOVINCE	NERO	SLIP-ON	STAINLESS STEEL	CARBON FIBER	EURO 4	KTM Adventure; A1/-, A2/-	ECE-Approved	4T	14045	
1190 1190/R ADVENTURE (Fits with rails for original and Givi panniers)		2013-2016								
GAMMA	LINEA	TIPO	MATERIALE	COPPA	STANDARD	TYPE	HOM.	2T/4T	ART.	
LEOVINCE	LV ONE EVO	SLIP-ON	STAINLESS STEEL	CARBON FIBER	EURO 3	KTM Adventure var. C1 / C2 - KTM Adventure var. A1/ A2/B1/B2 - KTM Adventure var. D1 / D2	e*-approved	4T	14159E	
LEOVINCE	NERO	SLIP-ON	STAINLESS STEEL	CARBON FIBER	EURO 3	KTM Adventure var. C1 / C2 - KTM Adventure var. A1/ A2/B1/B2 - KTM Adventure var. D1 / D2	e*-approved	4T	14033	

CC. MODELLO		ANNO								
1290 1290 SUPER ADVENTURE (fits with rails for original and Givi panniers) 2015-2016										
GAMMA	LINEA	TIPO	MATERIALE	COPPA	STANDARD	TYPE	HOM.	2T/4T	ART.	
LEOVINCE	LV ONE EVO	SLIP-ON	STAINLESS STEEL	CARBON FIBER	EURO 3	KTM Adventure var. C1 / C2 - KTM Adventure var. A1/ A2/B1/B2 - KTM Adventure var. D1 / D2	e*-approved	4T	14159E	
LEOVINCE	NERO	SLIP-ON	STAINLESS STEEL	CARBON FIBER	EURO 3	KTM Adventure var. C1 / C2 - KTM Adventure var. A1/ A2/B1/B2 - KTM Adventure var. D1 / D2	e*-approved	4T	14033	
1290 1290 SUPER ADVENTURE R/S/T (fits with rails for original and Givi panniers) 2017-2018										
GAMMA	LINEA	TIPO	MATERIALE	COPPA	STANDARD	TYPE	HOM.	2T/4T	ART.	
LEOVINCE	LV ONE EVO	SLIP-ON	STAINLESS STEEL	CARBON FIBER	EURO 4	KTM Adventure; B1/-, C1/-, D1/-	ECE-Approved	4T	14192E	
LEOVINCE	NERO	SLIP-ON	STAINLESS STEEL	CARBON FIBER	EURO 4	KTM Adventure; B1/-, C1/-, D1/-	ECE-Approved	4T	14045	

**KYMCO**

CC. MODELLO		ANNO								
50 AGILITY 50 2 RT 16" 2 stroke 2010-2012										
GAMMA	LINEA	TIPO	MATERIALE	COPPA	STANDARD	TYPE	HOM.	2T/4T	ART.	
LEOVINCE	HAND MADE TT	FULL SYSTEM	ALUMINUM	N/A			e-approved	2T	4048	
LEOVINCE	HAND MADE TT BLACK	FULL SYSTEM	ALUMINUM	N/A			e-approved	2T	4048B	
50 AGILITY 50 2T RT 16 2010-2012										
GAMMA	LINEA	TIPO	MATERIALE	COPPA	STANDARD	TYPE	HOM.	2T/4T	ART.	
LEOVINCE	TOURING	FULL SYSTEM	STEEL	N/A			e-approved	2T	4135	
SITO	SITO	FULL SYSTEM	STEEL	N/A			e-approved	2T	0701	
50 AGILITY 50 R10 4 stroke 2007-2012										
GAMMA	LINEA	TIPO	MATERIALE	COPPA	STANDARD	TYPE	HOM.	2T/4T	ART.	
LEOVINCE	LEOVINCE	FULL SYSTEM	STAINLESS STEEL	N/A			e-approved	4T	7470	
SITO	SITO	FULL SYSTEM	STEEL	N/A			e-approved	4T	0736	
50 AGILITY 50 R12 4 stroke 2007-2010										
GAMMA	LINEA	TIPO	MATERIALE	COPPA	STANDARD	TYPE	HOM.	2T/4T	ART.	
LEOVINCE	LEOVINCE	FULL SYSTEM	STAINLESS STEEL	N/A			e-approved	4T	7473	
50 AGILITY 50 R16 4 stroke 2010-2012										
GAMMA	LINEA	TIPO	MATERIALE	COPPA	STANDARD	TYPE	HOM.	2T/4T	ART.	
LEOVINCE	LEOVINCE	FULL SYSTEM	STAINLESS STEEL	N/A			e-approved	4T	7470	
50 AGILITY 50 RT 12 4 strokes 2007-2012										
GAMMA	LINEA	TIPO	MATERIALE	COPPA	STANDARD	TYPE	HOM.	2T/4T	ART.	
SITO	SITO	FULL SYSTEM	STEEL	N/A			e-approved	4T	0737	
50 AGILITY CITY 50 R16 4 stroke 2010-2012										
GAMMA	LINEA	TIPO	MATERIALE	COPPA	STANDARD	TYPE	HOM.	2T/4T	ART.	
LEOVINCE	LEOVINCE	FULL SYSTEM	STAINLESS STEEL	N/A			e-approved	4T	7470	

CC. MODELLO	ANNO									
50	AGILITY RS 50 4 stroke				2009-2013					
	GAMMA	LINEA	TIPO	MATERIALE	COPPA	STANDARD	TYPE	HOM.	2T/4T	ART.
	LEOVINCE	LEOVINCE	FULL SYSTEM	STAINLESS STEEL	N/A			e-approved	4T	3418
50	BET & WIN 50 liquid cooled				-					
	GAMMA	LINEA	TIPO	MATERIALE	COPPA	STANDARD	TYPE	HOM.	2T/4T	ART.
	LEOVINCE	HAND MADE TT	FULL SYSTEM	ALUMINUM	N/A			e-approved	2T	4048
	LEOVINCE	HAND MADE TT BLACK	FULL SYSTEM	ALUMINUM	N/A			e-approved	2T	4048B
	LEOVINCE	TOURING	FULL SYSTEM	STEEL	N/A			e-approved	2T	4135
	SITO	SITO	FULL SYSTEM	STEEL	N/A			e-approved	2T	0701
50	DINK II 50 4 stroke				-					
	GAMMA	LINEA	TIPO	MATERIALE	COPPA	STANDARD	TYPE	HOM.	2T/4T	ART.
	LEOVINCE	LEOVINCE	FULL SYSTEM	STAINLESS STEEL	N/A			e-approved	4T	7470
50	DJ S 50 4 stroke				-					
	GAMMA	LINEA	TIPO	MATERIALE	COPPA	STANDARD	TYPE	HOM.	2T/4T	ART.
	LEOVINCE	LEOVINCE	FULL SYSTEM	STAINLESS STEEL	N/A			e-approved	4T	7470
50	LA POSTE 50 4 stroke				-					
	GAMMA	LINEA	TIPO	MATERIALE	COPPA	STANDARD	TYPE	HOM.	2T/4T	ART.
	LEOVINCE	LEOVINCE	FULL SYSTEM	STAINLESS STEEL	N/A			e-approved	4T	7470
50	PEOPLE 50 ECO KAT				2003-2004					
	GAMMA	LINEA	TIPO	MATERIALE	COPPA	STANDARD	TYPE	HOM.	2T/4T	ART.
	LEOVINCE	HAND MADE TT	FULL SYSTEM	ALUMINUM	N/A			e-approved	2T	4048
	LEOVINCE	HAND MADE TT BLACK	FULL SYSTEM	ALUMINUM	N/A			e-approved	2T	4048B
	LEOVINCE	TOURING	FULL SYSTEM	STEEL	N/A			e-approved	2T	4135
	SITO	SITO	FULL SYSTEM	STEEL	N/A			e-approved	2T	0701
50	PEOPLE S 50 4 stroke				-					
	GAMMA	LINEA	TIPO	MATERIALE	COPPA	STANDARD	TYPE	HOM.	2T/4T	ART.
	LEOVINCE	LEOVINCE	FULL SYSTEM	STAINLESS STEEL	N/A			e-approved	4T	7470
50	SUPER 8 50 2 stroke				2009-2012					
	GAMMA	LINEA	TIPO	MATERIALE	COPPA	STANDARD	TYPE	HOM.	2T/4T	ART.
	LEOVINCE	HAND MADE TT	FULL SYSTEM	ALUMINUM	N/A			e-approved	2T	4048
	LEOVINCE	HAND MADE TT BLACK	FULL SYSTEM	ALUMINUM	N/A			e-approved	2T	4048B
	LEOVINCE	TOURING	FULL SYSTEM	STEEL	N/A			e-approved	2T	4135
	SITO	SITO	FULL SYSTEM	STEEL	N/A			e-approved	2T	0701
50	SUPER 8 50 4 stroke				-					
	GAMMA	LINEA	TIPO	MATERIALE	COPPA	STANDARD	TYPE	HOM.	2T/4T	ART.
	LEOVINCE	LEOVINCE	FULL SYSTEM	STAINLESS STEEL	N/A			e-approved	4T	7470
50	SUPER 9 50 air cooled				2004-2004					
	GAMMA	LINEA	TIPO	MATERIALE	COPPA	STANDARD	TYPE	HOM.	2T/4T	ART.
	LEOVINCE	HAND MADE TT	FULL SYSTEM	ALUMINUM	N/A			e-approved	2T	4048
	LEOVINCE	HAND MADE TT BLACK	FULL SYSTEM	ALUMINUM	N/A			e-approved	2T	4048B
	LEOVINCE	TOURING	FULL SYSTEM	STEEL	N/A			e-approved	2T	4135
	SITO	SITO	FULL SYSTEM	STEEL	N/A			e-approved	2T	0701



CC. MODELLO	ANNO									
50 TOP BOY 50 ON/OFF	-									
GAMMA	LINEA	TIPO	MATERIALE	COPPA	STANDARD	TYPE	HOM.	2T/4T	ART.	
LEOVINCE	HAND MADE TT	FULL SYSTEM	ALUMINUM	N/A			e-approved	2T	4048	
LEOVINCE	HAND MADE TT BLACK	FULL SYSTEM	ALUMINUM	N/A			e-approved	2T	4048B	
LEOVINCE	TOURING	FULL SYSTEM	STEEL	N/A			e-approved	2T	4135	
SITO	SITO	FULL SYSTEM	STEEL	N/A			e-approved	2T	0701	
50 VITALITY 50	-2008									
GAMMA	LINEA	TIPO	MATERIALE	COPPA	STANDARD	TYPE	HOM.	2T/4T	ART.	
LEOVINCE	HAND MADE TT	FULL SYSTEM	ALUMINUM	N/A			e-approved	2T	4048	
LEOVINCE	HAND MADE TT BLACK	FULL SYSTEM	ALUMINUM	N/A			e-approved	2T	4048B	
LEOVINCE	TOURING	FULL SYSTEM	STEEL	N/A			e-approved	2T	4135	
SITO	SITO	FULL SYSTEM	STEEL	N/A			e-approved	2T	0701	
50 YAGER GR 50 4 stroke	-									
GAMMA	LINEA	TIPO	MATERIALE	COPPA	STANDARD	TYPE	HOM.	2T/4T	ART.	
LEOVINCE	LEOVINCE	FULL SYSTEM	STAINLESS STEEL	N/A			e-approved	4T	7470	
50 YUP 50	2004-2005									
GAMMA	LINEA	TIPO	MATERIALE	COPPA	STANDARD	TYPE	HOM.	2T/4T	ART.	
LEOVINCE	HAND MADE TT	FULL SYSTEM	ALUMINUM	N/A			e-approved	2T	4048	
LEOVINCE	HAND MADE TT BLACK	FULL SYSTEM	ALUMINUM	N/A			e-approved	2T	4048B	
LEOVINCE	TOURING	FULL SYSTEM	STEEL	N/A			e-approved	2T	4135	
SITO	SITO	FULL SYSTEM	STEEL	N/A			e-approved	2T	0701	
125 DINK STREET 125i	2009-2016									
GAMMA	LINEA	TIPO	MATERIALE	COPPA	STANDARD	TYPE	HOM.	2T/4T	ART.	
LEOVINCE	GRANTURISMO	FULL SYSTEM	STAINLESS STEEL	N/A	EURO 3	V2 var.10 / 11 ver. 00 / 10	e-approved	4T	3253	
LEOVINCE	GRANTURISMO BLACK	FULL SYSTEM	STAINLESS STEEL	N/A	EURO 3		e-approved	4T	3253B	
LEOVINCE	NERO	FULL SYSTEM	STAINLESS STEEL	CARBON FIBER	EURO 3	V2 var. 10 / 11 ver. 00 / 10	e-approved	4T	14036	
125 DOWNTOWN 125i	2009-2016									
GAMMA	LINEA	TIPO	MATERIALE	COPPA	STANDARD	TYPE	HOM.	2T/4T	ART.	
LEOVINCE	GRANTURISMO	FULL SYSTEM	STAINLESS STEEL	N/A	EURO 3	V2 var.10 / 11 ver. 00 / 10	e-approved	4T	3253	
LEOVINCE	GRANTURISMO BLACK	FULL SYSTEM	STAINLESS STEEL	N/A	EURO 3		e-approved	4T	3253B	
LEOVINCE	NERO	FULL SYSTEM	STAINLESS STEEL	CARBON FIBER	EURO 3	V2 var. 10 / 11 ver. 00 / 10	e-approved	4T	14036	
125 SUPERDINK 125i	2009-2016									
GAMMA	LINEA	TIPO	MATERIALE	COPPA	STANDARD	TYPE	HOM.	2T/4T	ART.	
LEOVINCE	GRANTURISMO	FULL SYSTEM	STAINLESS STEEL	N/A	EURO 3	V2 var.10 / 11 ver. 00 / 10	e-approved	4T	3253	
LEOVINCE	GRANTURISMO BLACK	FULL SYSTEM	STAINLESS STEEL	N/A	EURO 3		e-approved	4T	3253B	
LEOVINCE	NERO	FULL SYSTEM	STAINLESS STEEL	CARBON FIBER	EURO 3	V2 var. 10 / 11 ver. 00 / 10	e-approved	4T	14036	
300 DINK STREET 300i	2009-2016									
GAMMA	LINEA	TIPO	MATERIALE	COPPA	STANDARD	TYPE	HOM.	2T/4T	ART.	
LEOVINCE	GRANTURISMO	FULL SYSTEM	STAINLESS STEEL	N/A	EURO 3	V2 var.00 ver.00	e-approved	4T	3206	
LEOVINCE	GRANTURISMO BLACK	FULL SYSTEM	STAINLESS STEEL	N/A	EURO 3		e-approved	4T	3206B	

# KYMCO

CC. MODELLO		ANNO								
300 DOWNTOWN 300i		2009-2016								
GAMMA	LINEA	TIPO	MATERIALE	COPPA	STANDARD	TYPE	HOM.	2T/4T	ART.	
LEOVINCE	GRANTURISMO	FULL SYSTEM	STAINLESS STEEL	N/A	EURO 3	V2 var.00 ver.00	e-approved	4T	3206	
LEOVINCE	GRANTURISMO BLACK	FULL SYSTEM	STAINLESS STEEL	N/A	EURO 3		e-approved	4T	3206B	
300 SUPERDINK 300i		2009-2016								
GAMMA	LINEA	TIPO	MATERIALE	COPPA	STANDARD	TYPE	HOM.	2T/4T	ART.	
LEOVINCE	GRANTURISMO	FULL SYSTEM	STAINLESS STEEL	N/A	EURO 3	V2 var.00 ver.00	e-approved	4T	3206	
LEOVINCE	GRANTURISMO BLACK	FULL SYSTEM	STAINLESS STEEL	N/A	EURO 3		e-approved	4T	3206B	
400 XCITING 400i		2012-2016								
GAMMA	LINEA	TIPO	MATERIALE	COPPA	STANDARD	TYPE	HOM.	2T/4T	ART.	
LEOVINCE	NERO	SLIP-ON	STAINLESS STEEL	CARBON FIBER	EURO 3		e-approved	4T	14011	
500 XCITING 500 carburetor/injection		2005-2014								
GAMMA	LINEA	TIPO	MATERIALE	COPPA	STANDARD	TYPE	HOM.	2T/4T	ART.	
LEOVINCE	GRANTURISMO	FULL SYSTEM	STAINLESS STEEL	N/A	EURO 2/3		e-approved	4T	3210	
LEOVINCE	GRANTURISMO BLACK	FULL SYSTEM	STAINLESS STEEL	N/A	EURO 2/3		e-approved	4T	3210B	
550 AK550 ABS		2017-2018								
GAMMA	LINEA	TIPO	MATERIALE	COPPA	STANDARD	TYPE	HOM.	2T/4T	ART.	
LEOVINCE	FACTORY S	SLIP-ON	STAINLESS STEEL	CARBON FIBER	EURO 4	E1-A3 var.00 ver.00	dB(A) Compliant	4T	14212S	
LEOVINCE	FACTORY S	SLIP-ON	STAINLESS STEEL	CARBON FIBER	EURO 4	E1-A3 var.00 ver.00	ECE/EU-Approved	4T	14212SK	
LEOVINCE	FACTORY S	FULL SYSTEM 2/1	STAINLESS STEEL	CARBON FIBER	EURO 4	E1-A3 var.00 ver.00	dB(A) Compliant	4T	14231S	
LEOVINCE	FACTORY S	FULL SYSTEM 2/1	STAINLESS STEEL	CARBON FIBER	EURO 4	E1-A3 var.00 ver.00	ECE/EU-Approved	4T	14231SK	
LEOVINCE	LV PRO	SLIP-ON	STAINLESS STEEL	CARBON FIBER	EURO 4	E1-A3 var.00 ver.00	Racing use only	4T	14213E	
550 AK550 ABS (compatible with original and LeoVince exhaust)		2017-2018								
GAMMA	LINEA	TIPO	MATERIALE	COPPA	STANDARD	TYPE	HOM.	2T/4T	ART.	
LEOVINCE	HEADERS PIPES	N/A	N/A	N/A	EURO 4		Racing use only	4T	8087	

# LML

CC. MODELLO		ANNO								
151 STAR 4 151		2013-2015								
GAMMA	LINEA	TIPO	MATERIALE	COPPA	STANDARD	TYPE	HOM.	2T/4T	ART.	
SITO	SITOPPLUS	FULL SYSTEM	STEEL	N/A			e-approved	4T	0746	
200 STAR 200		2012-2015								
GAMMA	LINEA	TIPO	MATERIALE	COPPA	STANDARD	TYPE	HOM.	2T/4T	ART.	
SITO	SITOPPLUS	FULL SYSTEM	STEEL	N/A			e-approved	4T	0744	

# MALAGUTI

CC. MODELLO		ANNO								
50	CENTRO	-								
	GAMMA	LINEA	TIPO	MATERIALE	COPPA	STANDARD	TYPE	HOM.	2T/4T	ART.
	SITO	SITOPPLUS	FULL SYSTEM	STEEL	N/A			TPSi approved	2T	0556
50	F12 PHANTOM air/liquid cooled	1994-1998								
	GAMMA	LINEA	TIPO	MATERIALE	COPPA	STANDARD	TYPE	HOM.	2T/4T	ART.
	LEOVINCE	HAND MADE TT	FULL SYSTEM	ALUMINUM	N/A			e-approved	2T	4051
	LEOVINCE	HAND MADE TT BLACK	FULL SYSTEM	ALUMINUM	N/A			e-approved	2T	4051B
	SITO	SITOPPLUS	FULL SYSTEM	STEEL	N/A			e-approved	2T	0565
50	F12 PHANTOM KAT air/liquid cooled	1999-								
	GAMMA	LINEA	TIPO	MATERIALE	COPPA	STANDARD	TYPE	HOM.	2T/4T	ART.
	LEOVINCE	HAND MADE TT	FULL SYSTEM	ALUMINUM	N/A			e-approved	2T	4051
	LEOVINCE	HAND MADE TT BLACK	FULL SYSTEM	ALUMINUM	N/A			e-approved	2T	4051B
50	F12 PHANTOM KAT liquid cooled	2000-								
	GAMMA	LINEA	TIPO	MATERIALE	COPPA	STANDARD	TYPE	HOM.	2T/4T	ART.
	LEOVINCE	HAND MADE TT	FULL SYSTEM	ALUMINUM	N/A			e-approved	2T	4051
	LEOVINCE	HAND MADE TT BLACK	FULL SYSTEM	ALUMINUM	N/A			e-approved	2T	4051B
50	F12 R PHANTOM KAT liquid cooled	2007-2010								
	GAMMA	LINEA	TIPO	MATERIALE	COPPA	STANDARD	TYPE	HOM.	2T/4T	ART.
	SITO	SITO	FULL SYSTEM	STEEL	N/A			e-approved	2T	0587
50	F15 FIREFOX	1996-1998								
	GAMMA	LINEA	TIPO	MATERIALE	COPPA	STANDARD	TYPE	HOM.	2T/4T	ART.
	LEOVINCE	TOURING	FULL SYSTEM	STEEL	N/A			e-approved	2T	5517
	SITO	SITO	FULL SYSTEM	STEEL	N/A			e-approved	2T	0587

# MBK

CC. MODELLO		ANNO								
50	BOOSTER 50	1998-1999								
	GAMMA	LINEA	TIPO	MATERIALE	COPPA	STANDARD	TYPE	HOM.	2T/4T	ART.
	SITO	SITOPPLUS	FULL SYSTEM	STEEL	N/A			e-approved	2T	0559
50	BOOSTER 50	2004-2012								
	GAMMA	LINEA	TIPO	MATERIALE	COPPA	STANDARD	TYPE	HOM.	2T/4T	ART.
	LEOVINCE	HAND MADE TT	FULL SYSTEM	ALUMINUM	N/A			e-approved	2T	4091
	LEOVINCE	HAND MADE TT BLACK	FULL SYSTEM	ALUMINUM	N/A			e-approved	2T	4091B
	SITO	SITOPPLUS	FULL SYSTEM	STEEL	N/A			e-approved	2T	0715
50	BOOSTER KAT/NEXT GENERATION KAT air cooled	1999-2001								
	GAMMA	LINEA	TIPO	MATERIALE	COPPA	STANDARD	TYPE	HOM.	2T/4T	ART.
	LEOVINCE	HAND MADE TT	FULL SYSTEM	ALUMINUM	N/A			e-approved	2T	4053
	LEOVINCE	HAND MADE TT BLACK	FULL SYSTEM	ALUMINUM	N/A			e-approved	2T	4053B
	LEOVINCE	TOURING	FULL SYSTEM	STEEL	N/A			e-approved	2T	5516

CC. MODELLO		ANNO								
50	<b>BOOSTER/NEXT GENERATION</b>	1988-1999								
	<b>GAMMA</b>	<b>LINEA</b>	<b>TIPO</b>	<b>MATERIALE</b>	<b>COPPA</b>	<b>STANDARD</b>	<b>TYPE</b>	<b>HOM.</b>	<b>2T/4T</b>	<b>ART.</b>
	LEOVINCE	HAND MADE TT	FULL SYSTEM	ALUMINUM	N/A			e-approved	2T	4053
	LEOVINCE	HAND MADE TT BLACK	FULL SYSTEM	ALUMINUM	N/A			e-approved	2T	4053B
	LEOVINCE	TOURING	FULL SYSTEM	STEEL	N/A			e-approved	2T	5516
50	<b>BUXI M</b>	1994-1997								
	<b>GAMMA</b>	<b>LINEA</b>	<b>TIPO</b>	<b>MATERIALE</b>	<b>COPPA</b>	<b>STANDARD</b>	<b>TYPE</b>	<b>HOM.</b>	<b>2T/4T</b>	<b>ART.</b>
	LEOVINCE	HAND MADE TT	FULL SYSTEM	ALUMINUM	N/A			e-approved	2T	4055
	LEOVINCE	HAND MADE TT BLACK	FULL SYSTEM	ALUMINUM	N/A			e-approved	2T	4055B
50	<b>EVOLIS</b>	1992-1998								
	<b>GAMMA</b>	<b>LINEA</b>	<b>TIPO</b>	<b>MATERIALE</b>	<b>COPPA</b>	<b>STANDARD</b>	<b>TYPE</b>	<b>HOM.</b>	<b>2T/4T</b>	<b>ART.</b>
	SITO	SITOPUS	FULL SYSTEM	STEEL	N/A			TPSi approved	2T	0556
50	<b>FIZZ</b>	1994-1997								
	<b>GAMMA</b>	<b>LINEA</b>	<b>TIPO</b>	<b>MATERIALE</b>	<b>COPPA</b>	<b>STANDARD</b>	<b>TYPE</b>	<b>HOM.</b>	<b>2T/4T</b>	<b>ART.</b>
	SITO	SITOPUS	FULL SYSTEM	STEEL	N/A			TPSi approved	2T	0556
50	<b>FORTE</b>	1994-1998								
	<b>GAMMA</b>	<b>LINEA</b>	<b>TIPO</b>	<b>MATERIALE</b>	<b>COPPA</b>	<b>STANDARD</b>	<b>TYPE</b>	<b>HOM.</b>	<b>2T/4T</b>	<b>ART.</b>
	SITO	SITOPUS	FULL SYSTEM	STEEL	N/A			TPSi approved	2T	0556
50	<b>NITRO</b>	1998-1999								
	<b>GAMMA</b>	<b>LINEA</b>	<b>TIPO</b>	<b>MATERIALE</b>	<b>COPPA</b>	<b>STANDARD</b>	<b>TYPE</b>	<b>HOM.</b>	<b>2T/4T</b>	<b>ART.</b>
	LEOVINCE	HAND MADE TT	FULL SYSTEM	ALUMINUM	N/A			e-approved	2T	4054
	LEOVINCE	HAND MADE TT BLACK	FULL SYSTEM	ALUMINUM	N/A			e-approved	2T	4054B
50	<b>NITRO 50</b>	1997-								
	<b>GAMMA</b>	<b>LINEA</b>	<b>TIPO</b>	<b>MATERIALE</b>	<b>COPPA</b>	<b>STANDARD</b>	<b>TYPE</b>	<b>HOM.</b>	<b>2T/4T</b>	<b>ART.</b>
	SITO	SITO	FULL SYSTEM	STEEL	N/A			e-approved	2T	0587
50	<b>NITRO KAT</b>	2000-2001								
	<b>GAMMA</b>	<b>LINEA</b>	<b>TIPO</b>	<b>MATERIALE</b>	<b>COPPA</b>	<b>STANDARD</b>	<b>TYPE</b>	<b>HOM.</b>	<b>2T/4T</b>	<b>ART.</b>
	LEOVINCE	TOURING	FULL SYSTEM	STEEL	N/A			e-approved	2T	5576
50	<b>OVETTO 50</b>	2002-2012								
	<b>GAMMA</b>	<b>LINEA</b>	<b>TIPO</b>	<b>MATERIALE</b>	<b>COPPA</b>	<b>STANDARD</b>	<b>TYPE</b>	<b>HOM.</b>	<b>2T/4T</b>	<b>ART.</b>
	LEOVINCE	TOURING	FULL SYSTEM	STEEL	N/A			e-approved	2T	5515
	SITO	SITO	FULL SYSTEM	STEEL	N/A			e-approved	2T	0734
	SITO	SITOPUS	FULL SYSTEM	STEEL	N/A			e-approved	2T	0574
50	<b>ROCKET</b>	1996-1998								
	<b>GAMMA</b>	<b>LINEA</b>	<b>TIPO</b>	<b>MATERIALE</b>	<b>COPPA</b>	<b>STANDARD</b>	<b>TYPE</b>	<b>HOM.</b>	<b>2T/4T</b>	<b>ART.</b>
	LEOVINCE	HAND MADE TT	FULL SYSTEM	ALUMINUM	N/A			e-approved	2T	4053
	LEOVINCE	HAND MADE TT BLACK	FULL SYSTEM	ALUMINUM	N/A			e-approved	2T	4053B
	LEOVINCE	TOURING	FULL SYSTEM	STEEL	N/A			e-approved	2T	5516

# MBK

CC. MODELLO	ANNO									
50 SPIRIT	1999-2002									
GAMMA	LINEA	TIPO	MATERIALE	COPPA	STANDARD	TYPE	HOM.	2T/4T	ART.	
LEOVINCE	HAND MADE TT	FULL SYSTEM	ALUMINUM	N/A			e-approved	2T	4053	
LEOVINCE	HAND MADE TT BLACK	FULL SYSTEM	ALUMINUM	N/A			e-approved	2T	4053B	
LEOVINCE	TOURING	FULL SYSTEM	STEEL	N/A			e-approved	2T	5516	
50 STUNT	2000-2002									
GAMMA	LINEA	TIPO	MATERIALE	COPPA	STANDARD	TYPE	HOM.	2T/4T	ART.	
LEOVINCE	HAND MADE TT	FULL SYSTEM	ALUMINUM	N/A			e-approved	2T	4053	
LEOVINCE	HAND MADE TT BLACK	FULL SYSTEM	ALUMINUM	N/A			e-approved	2T	4053B	
LEOVINCE	TOURING	FULL SYSTEM	STEEL	N/A			e-approved	2T	5516	
SITO	SITO	FULL SYSTEM	STEEL	N/A			e-approved	2T	0590	
50 X-LIMIT 50	2003-2006									
GAMMA	LINEA	TIPO	MATERIALE	COPPA	STANDARD	TYPE	HOM.	2T/4T	ART.	
LEOVINCE	X-FIGHT	FULL SYSTEM	STAINLESS STEEL	N/A			e-approved	2T	3260	
LEOVINCE	X-FIGHT BLACK	FULL SYSTEM	STAINLESS STEEL	N/A			e-approved	2T	3260B	
125 SKYCRUISER 125	2006-2016									
GAMMA	LINEA	TIPO	MATERIALE	COPPA	STANDARD	TYPE	HOM.	2T/4T	ART.	
LEOVINCE	LV ONE EVO	FULL SYSTEM 1/1	STAINLESS STEEL	CARBON FIBER	EURO 3		e-approved	4T	8537E	
300 KILIBRE 300	2003-2004									
GAMMA	LINEA	TIPO	MATERIALE	COPPA	STANDARD	TYPE	HOM.	2T/4T	ART.	
LEOVINCE	GRANTURISMO	FULL SYSTEM	STAINLESS STEEL	N/A	EURO 2		e-approved	4T	3477	
LEOVINCE	GRANTURISMO BLACK	FULL SYSTEM	STAINLESS STEEL	N/A	EURO 2		e-approved	4T	3477B	
50 X-POWER 50	2003-2012									
GAMMA	LINEA	TIPO	MATERIALE	COPPA	STANDARD	TYPE	HOM.	2T/4T	ART.	
LEOVINCE	X-FIGHT	FULL SYSTEM	STAINLESS STEEL	N/A			e-approved	2T	3282	
LEOVINCE	X-FIGHT BLACK	FULL SYSTEM	STAINLESS STEEL	N/A			e-approved	2T	3282B	

# MOTO GUZZI

CC. MODELLO	ANNO									
750 V7 III / STONE / SPECIAL / ANNIVERSARIO	2017-2018									
GAMMA	LINEA	TIPO	MATERIALE	COPPA	STANDARD	TYPE	HOM.	2T/4T	ART.	
LEOVINCE	CLASSIC RACER	2 SLIP-ON	STAINLESS STEEL	STAINLESS STEEL	EURO 4		LD var.0 ver.00;01 - var.E ver.00; 01 - var.B ver.00; 01 - var.A ver.00; 01	dB(A) Compliant	4T	15000
LEOVINCE	CLASSIC RACER	2 SLIP-ON	STAINLESS STEEL	STAINLESS STEEL	EURO 4		LD var.0 ver.00;01 - var.E ver.00; 01 - var.B ver.00; 01 - var.A ver.00; 01	ECE/EU-Approved	4T	15000K

# PEUGEOT

CC. MODELLO	ANNO									
50 LUDIX BLASTER 50 liquid cooled	2005-									
GAMMA	LINEA	TIPO	MATERIALE	COPPA	STANDARD	TYPE	HOM.	2T/4T	ART.	
SITO	SITO	FULL SYSTEM	STEEL	N/A			e-approved	2T	0723	

# PEUGEOT

CC. MODELLO	ANNO									
50 FOX	-									
GAMMA	LINEA	TIPO	MATERIALE	COPPA	STANDARD	TYPE	HOM.	2T/4T	ART.	
SITO	SITOPPLUS	FULL SYSTEM	STEEL	N/A			TPSI approved	2T	0560	
50 JET FORCE 50 TDSI injection	2003-2006									
GAMMA	LINEA	TIPO	MATERIALE	COPPA	STANDARD	TYPE	HOM.	2T/4T	ART.	
LEOVINCE	HAND MADE TT	FULL SYSTEM	ALUMINUM	N/A			e-approved	2T	4059	
LEOVINCE	HAND MADE TT BLACK	FULL SYSTEM	ALUMINUM	N/A			e-approved	2T	4059B	
50 JET FORCE C-TECH 50 injection liquid cooled	2005-									
GAMMA	LINEA	TIPO	MATERIALE	COPPA	STANDARD	TYPE	HOM.	2T/4T	ART.	
LEOVINCE	HAND MADE TT	FULL SYSTEM	ALUMINUM	N/A			e-approved	2T	4059	
LEOVINCE	HAND MADE TT BLACK	FULL SYSTEM	ALUMINUM	N/A			e-approved	2T	4059B	
SITO	SITO	FULL SYSTEM	STEEL	N/A			e-approved	2T	0723	
50 KISBEE	2011-2015									
GAMMA	LINEA	TIPO	MATERIALE	COPPA	STANDARD	TYPE	HOM.	2T/4T	ART.	
LEOVINCE	TOURING	FULL SYSTEM	STEEL	N/A			e-approved	2T	3434	
SITO	SITO	FULL SYSTEM	STEEL	N/A			e-approved	2T	0714	
50 LOOXOR 50 injection	2004-2005									
GAMMA	LINEA	TIPO	MATERIALE	COPPA	STANDARD	TYPE	HOM.	2T/4T	ART.	
SITO	SITOPPLUS	FULL SYSTEM	STEEL	N/A			e-approved	2T	0568	
50 LUDIX 50 2 ONE/TREND	2004-2012									
GAMMA	LINEA	TIPO	MATERIALE	COPPA	STANDARD	TYPE	HOM.	2T/4T	ART.	
LEOVINCE	HAND MADE TT	FULL SYSTEM	ALUMINUM	N/A			e-approved	2T	4088	
LEOVINCE	HAND MADE TT BLACK	FULL SYSTEM	ALUMINUM	N/A			e-approved	2T	4088B	
LEOVINCE	TOURING	FULL SYSTEM	STEEL	N/A			e-approved	2T	3434	
SITO	SITO	FULL SYSTEM	STEEL	N/A			e-approved	2T	0714	
50 LUDIX 50 ONE air cooled	2004-									
GAMMA	LINEA	TIPO	MATERIALE	COPPA	STANDARD	TYPE	HOM.	2T/4T	ART.	
LEOVINCE	HAND MADE TT	FULL SYSTEM	ALUMINUM	N/A			e-approved	2T	4088	
LEOVINCE	HAND MADE TT BLACK	FULL SYSTEM	ALUMINUM	N/A			e-approved	2T	4088B	
LEOVINCE	TOURING	FULL SYSTEM	STEEL	N/A			e-approved	2T	3434	
SITO	SITO	FULL SYSTEM	STEEL	N/A			e-approved	2T	0714	
50 LUDIX BLASTER 50 liquid cooled	2005-									
GAMMA	LINEA	TIPO	MATERIALE	COPPA	STANDARD	TYPE	HOM.	2T/4T	ART.	
LEOVINCE	HAND MADE TT	FULL SYSTEM	ALUMINUM	N/A			e-approved	2T	4059	
LEOVINCE	HAND MADE TT BLACK	FULL SYSTEM	ALUMINUM	N/A			e-approved	2T	4059B	
50 METAL-X 50	2003-									
GAMMA	LINEA	TIPO	MATERIALE	COPPA	STANDARD	TYPE	HOM.	2T/4T	ART.	
LEOVINCE	HAND MADE TT	FULL SYSTEM	ALUMINUM	N/A			e-approved	2T	4055	
LEOVINCE	HAND MADE TT BLACK	FULL SYSTEM	ALUMINUM	N/A			e-approved	2T	4055B	
LEOVINCE	TOURING	FULL SYSTEM	STEEL	N/A			e-approved	2T	5513	
SITO	SITOPPLUS	FULL SYSTEM	STEEL	N/A			e-approved	2T	0568	

# PEUGEOT

CC. MODELLO		ANNO								
50	NEW VIVACITY	2008-2012								
	GAMMA	LINEA	TIPO	MATERIALE	COPPA	STANDARD	TYPE	HOM.	2T/4T	ART.
	LEOVINCE	HAND MADE TT	FULL SYSTEM	ALUMINUM	N/A			e-approved	2T	4088
	LEOVINCE	HAND MADE TT BLACK	FULL SYSTEM	ALUMINUM	N/A			e-approved	2T	4088B
	LEOVINCE	TOURING	FULL SYSTEM	STEEL	N/A			e-approved	2T	3434
	SITO	SITO	FULL SYSTEM	STEEL	N/A			e-approved	2T	0714
50	SPEEDFIGHT 2 50 air/liquid cooled	-								
	GAMMA	LINEA	TIPO	MATERIALE	COPPA	STANDARD	TYPE	HOM.	2T/4T	ART.
	LEOVINCE	HAND MADE TT	FULL SYSTEM	ALUMINUM	N/A			e-approved	2T	4058
	LEOVINCE	HAND MADE TT BLACK	FULL SYSTEM	ALUMINUM	N/A			e-approved	2T	4058B
	SITO	SITO	FULL SYSTEM	STEEL	N/A			e-approved	2T	0711
50	SPEEDFIGHT 3 50 liquid cooled	2009-2011								
	GAMMA	LINEA	TIPO	MATERIALE	COPPA	STANDARD	TYPE	HOM.	2T/4T	ART.
	LEOVINCE	HAND MADE TT	FULL SYSTEM	ALUMINUM	N/A			e-approved	2T	4059
	LEOVINCE	HAND MADE TT BLACK	FULL SYSTEM	ALUMINUM	N/A			e-approved	2T	4059B
50	SPEEDFIGHT 3 50 liquid cooled only	2009-2011								
	GAMMA	LINEA	TIPO	MATERIALE	COPPA	STANDARD	TYPE	HOM.	2T/4T	ART.
	SITO	SITO	FULL SYSTEM	STEEL	N/A			e-approved	2T	0723
50	SPEEDFIGHT 50 air/liquid cooled	1997-1999								
	GAMMA	LINEA	TIPO	MATERIALE	COPPA	STANDARD	TYPE	HOM.	2T/4T	ART.
	LEOVINCE	HAND MADE TT	FULL SYSTEM	ALUMINUM	N/A			e-approved	2T	4056
	LEOVINCE	HAND MADE TT BLACK	FULL SYSTEM	ALUMINUM	N/A			e-approved	2T	4056B
	SITO	SITO	FULL SYSTEM	STEEL	N/A			e-approved	2T	0588
	LEOVINCE	TOURING	FULL SYSTEM	STEEL	N/A			e-approved	2T	5513
50	SQUAB	1995-1997								
	GAMMA	LINEA	TIPO	MATERIALE	COPPA	STANDARD	TYPE	HOM.	2T/4T	ART.
	LEOVINCE	HAND MADE TT	FULL SYSTEM	ALUMINUM	N/A			e-approved	2T	4055
	LEOVINCE	HAND MADE TT BLACK	FULL SYSTEM	ALUMINUM	N/A			e-approved	2T	4055B
	LEOVINCE	TOURING	FULL SYSTEM	STEEL	N/A			e-approved	2T	5513
	SITO	SITOPPLUS	FULL SYSTEM	STEEL	N/A			e-approved	2T	0568
50	TREKKER 50	1998-2000								
	GAMMA	LINEA	TIPO	MATERIALE	COPPA	STANDARD	TYPE	HOM.	2T/4T	ART.
	LEOVINCE	HAND MADE TT	FULL SYSTEM	ALUMINUM	N/A			e-approved	2T	4055
	LEOVINCE	HAND MADE TT BLACK	FULL SYSTEM	ALUMINUM	N/A			e-approved	2T	4055B
	SITO	SITOPPLUS	FULL SYSTEM	STEEL	N/A			e-approved	2T	0568
50	V-CLICK 4 stroke	2007-2012								
	GAMMA	LINEA	TIPO	MATERIALE	COPPA	STANDARD	TYPE	HOM.	2T/4T	ART.
	SITO	SITO	FULL SYSTEM	STEEL	N/A			Not approved	4T	0736
50	V-CLICK 50 4 stroke	-								
	GAMMA	LINEA	TIPO	MATERIALE	COPPA	STANDARD	TYPE	HOM.	2T/4T	ART.
	LEOVINCE	LEOVINCE	FULL SYSTEM	STAINLESS STEEL	N/A			Not Approved	4T	7470

# PEUGEOT

CC. MODELLO	ANNO									
50 VIVACITY 50 air cooled	1999-2002									
GAMMA	LINEA	TIPO	MATERIALE	COPPA	STANDARD	TYPE	HOM.	2T/4T	ART.	
LEOVINCE	HAND MADE TT	FULL SYSTEM	ALUMINUM	N/A			e-approved	2T	4055	
LEOVINCE	HAND MADE TT BLACK	FULL SYSTEM	ALUMINUM	N/A			e-approved	2T	4055B	
SITO	SITO	FULL SYSTEM	STEEL	N/A			e-approved	2T	0703	
50 VIVACITY 50 air cooled 25 Km/h	-									
GAMMA	LINEA	TIPO	MATERIALE	COPPA	STANDARD	TYPE	HOM.	2T/4T	ART.	
SITO	SITO	FULL SYSTEM	STEEL	N/A			e-approved	2T	0726	
50 X-FIGHT 50 KAT liquid cooled	2001-									
GAMMA	LINEA	TIPO	MATERIALE	COPPA	STANDARD	TYPE	HOM.	2T/4T	ART.	
LEOVINCE	HAND MADE TT	FULL SYSTEM	ALUMINUM	N/A			e-approved	2T	4055	
LEOVINCE	HAND MADE TT BLACK	FULL SYSTEM	ALUMINUM	N/A			e-approved	2T	4055B	
LEOVINCE	TOURING	FULL SYSTEM	STEEL	N/A			e-approved	2T	5513	
SITO	SITO	FULL SYSTEM	STEEL	N/A			e-approved	2T	0588	
50 X-FIGHT 50 WRC liquid cooled	2002-2003									
GAMMA	LINEA	TIPO	MATERIALE	COPPA	STANDARD	TYPE	HOM.	2T/4T	ART.	
LEOVINCE	HAND MADE TT	FULL SYSTEM	ALUMINUM	N/A			e-approved	2T	4058	
LEOVINCE	HAND MADE TT BLACK	FULL SYSTEM	ALUMINUM	N/A			e-approved	2T	4058B	
SITO	SITO	FULL SYSTEM	STEEL	N/A			e-approved	2T	0711	
125 CITYSTAR 125	2011-2012									
GAMMA	LINEA	TIPO	MATERIALE	COPPA	STANDARD	TYPE	HOM.	2T/4T	ART.	
LEOVINCE	GRANTURISMO	SLIP-ON	STAINLESS STEEL	N/A	EURO 3		e-approved	4T	3488	
LEOVINCE	GRANTURISMO BLACK	SLIP-ON	STAINLESS STEEL	N/A	EURO 3		e-approved	4T	3488B	
125 SATELIS 125/SATELIS 2	2006-2013									
GAMMA	LINEA	TIPO	MATERIALE	COPPA	STANDARD	TYPE	HOM.	2T/4T	ART.	
LEOVINCE	GRANTURISMO	SLIP-ON	STAINLESS STEEL	N/A	EURO 3		e-approved	4T	3488	
LEOVINCE	GRANTURISMO BLACK	SLIP-ON	STAINLESS STEEL	N/A	EURO 3		e-approved	4T	3488B	
400 METROPOLIS 400i	2013-2016									
GAMMA	LINEA	TIPO	MATERIALE	COPPA	STANDARD	TYPE	HOM.	2T/4T	ART.	
LEOVINCE	LV ONE EVO	SLIP-ON	STAINLESS STEEL	CARBON FIBER	EURO 3	X1AA	e-approved	4T	14108E	
LEOVINCE	NERO	SLIP-ON	STAINLESS STEEL	CARBON FIBER	EURO 3	X1AA	e-approved	4T	14019	

# PIAGGIO

CC. MODELLO	ANNO									
50 APE 50	-									
GAMMA	LINEA	TIPO	MATERIALE	COPPA	STANDARD	TYPE	HOM.	2T/4T	ART.	
LEOVINCE	LEOVINCE	FULL SYSTEM	STEEL	N/A			Not approved	2T	4221	
SITO	SITO	FULL SYSTEM	STEEL	N/A			Not approved	2T	0220	
50 APE TMP 50/EUROPA/MIX/MIX KAT	-									
GAMMA	LINEA	TIPO	MATERIALE	COPPA	STANDARD	TYPE	HOM.	2T/4T	ART.	
SITO	SITO	FULL SYSTEM	STEEL	N/A			Not approved	2T	0244	



# PIAGGIO

CC.	MODELLO	ANNO								
50	CIAO/P/PX	-								
	GAMMA	LINEA	TIPO	MATERIALE	COPPA	STANDARD	TYPE	HOM.	2T/4T	ART.
	SITO	SITO	FULL SYSTEM	STEEL	N/A			DGM/TPSI/ABE approved	2T	0218
50	CIAO/P/PX/CIAO FL 50	-								
	GAMMA	LINEA	TIPO	MATERIALE	COPPA	STANDARD	TYPE	HOM.	2T/4T	ART.
	SITO	SITOPPLUS	FULL SYSTEM	STEEL	N/A			e-approved	2T	0248
50	FL	1995-2000								
	GAMMA	LINEA	TIPO	MATERIALE	COPPA	STANDARD	TYPE	HOM.	2T/4T	ART.
	SITO	SITOPPLUS	FULL SYSTEM	STEEL	N/A			e-approved	2T	0261
50	FLY 50 air cooled	2005-2005								
	GAMMA	LINEA	TIPO	MATERIALE	COPPA	STANDARD	TYPE	HOM.	2T/4T	ART.
	LEOVINCE	HAND MADE TT	FULL SYSTEM	ALUMINUM	N/A			e-approved	2T	4065
	LEOVINCE	HAND MADE TT BLACK	FULL SYSTEM	ALUMINUM	N/A			e-approved	2T	4065B
	SITO	SITOPPLUS	FULL SYSTEM	STEEL	N/A			e-approved	2T	0579
50	FREE	1992-1994								
	GAMMA	LINEA	TIPO	MATERIALE	COPPA	STANDARD	TYPE	HOM.	2T/4T	ART.
	SITO	SITOPPLUS	FULL SYSTEM	STEEL	N/A			e-approved	2T	0261
50	LIBERTY 50	1995-								
	GAMMA	LINEA	TIPO	MATERIALE	COPPA	STANDARD	TYPE	HOM.	2T/4T	ART.
	SITO	SITOPPLUS	FULL SYSTEM	STEEL	N/A			e-approved	2T	0233
50	LIBERTY 50 4 stroke	2000-2006								
	GAMMA	LINEA	TIPO	MATERIALE	COPPA	STANDARD	TYPE	HOM.	2T/4T	ART.
	SITO	SITOPPLUS	FULL SYSTEM	STEEL	N/A			e-approved	4T	0713
50	NRG	1994-1996								
	GAMMA	LINEA	TIPO	MATERIALE	COPPA	STANDARD	TYPE	HOM.	2T/4T	ART.
	LEOVINCE	TOURING	FULL SYSTEM	STEEL	N/A			e-approved	2T	5512
50	NRG 50 POWER DD (carburetor)	2005-2006								
	GAMMA	LINEA	TIPO	MATERIALE	COPPA	STANDARD	TYPE	HOM.	2T/4T	ART.
	LEOVINCE	HAND MADE TT	FULL SYSTEM	ALUMINUM	N/A			e-approved	2T	4075
	LEOVINCE	HAND MADE TT BLACK	FULL SYSTEM	ALUMINUM	N/A			e-approved	2T	4075B
	SITO	SITO	FULL SYSTEM	STEEL	N/A			e-approved	2T	0712
50	NRG=mc2	1997-1998								
	GAMMA	LINEA	TIPO	MATERIALE	COPPA	STANDARD	TYPE	HOM.	2T/4T	ART.
	LEOVINCE	TOURING	FULL SYSTEM	STEEL	N/A			e-approved	2T	5512
	SITO	SITOPPLUS	FULL SYSTEM	STEEL	N/A	EURO 1		e-approved	2T	0572
50	NRG=mc2 air/liquid cooled	1999-								
	GAMMA	LINEA	TIPO	MATERIALE	COPPA	STANDARD	TYPE	HOM.	2T/4T	ART.
	LEOVINCE	TOURING	FULL SYSTEM	STEEL	N/A			e-approved	2T	5512

CC.	MODELLO	ANNO								
50	NRG=mc2 EXTREME liquid cooled	2000-								
	GAMMA	LINEA	TIPO	MATERIALE	COPPA	STANDARD	TYPE	HOM.	2T/4T	ART.
	LEOVINCE	TOURING	FULL SYSTEM	STEEL	N/A			e-approved	2T	5512
	SITO	SITO	FULL SYSTEM	STEEL	N/A			e-approved	2T	0586
50	NRG=mc2 liquid cooled	1999-								
	GAMMA	LINEA	TIPO	MATERIALE	COPPA	STANDARD	TYPE	HOM.	2T/4T	ART.
	SITO	SITOPPLUS	FULL SYSTEM	STEEL	N/A	EURO 1		e-approved	2T	0572
50	NRG=mc2 rotor rear brake	1998-								
	GAMMA	LINEA	TIPO	MATERIALE	COPPA	STANDARD	TYPE	HOM.	2T/4T	ART.
	LEOVINCE	TOURING	FULL SYSTEM	STEEL	N/A			e-approved	2T	5512
50	NRG=mc3 KAT	2001-								
	GAMMA	LINEA	TIPO	MATERIALE	COPPA	STANDARD	TYPE	HOM.	2T/4T	ART.
	LEOVINCE	HAND MADE TT	FULL SYSTEM	ALUMINUM	N/A			e-approved	2T	4063
	LEOVINCE	HAND MADE TT BLACK	FULL SYSTEM	ALUMINUM	N/A			e-approved	2T	4063B
50	NTT	1994-1996								
	GAMMA	LINEA	TIPO	MATERIALE	COPPA	STANDARD	TYPE	HOM.	2T/4T	ART.
	LEOVINCE	TOURING	FULL SYSTEM	STEEL	N/A			e-approved	2T	5512
50	SFERA 50 1st edition	1994-								
	GAMMA	LINEA	TIPO	MATERIALE	COPPA	STANDARD	TYPE	HOM.	2T/4T	ART.
	SITO	SITOPPLUS	FULL SYSTEM	STEEL	N/A			e-approved	2T	0256
50	SFERA 50 2nd edition	1995-								
	GAMMA	LINEA	TIPO	MATERIALE	COPPA	STANDARD	TYPE	HOM.	2T/4T	ART.
	SITO	SITOPPLUS	FULL SYSTEM	STEEL	N/A			e-approved	2T	0233
50	SI/KS/FL2/BOSS	-								
	GAMMA	LINEA	TIPO	MATERIALE	COPPA	STANDARD	TYPE	HOM.	2T/4T	ART.
	SITO	SITOPPLUS	FULL SYSTEM	STEEL	N/A			e-approved	2T	0249
50	SI/KS/FL2/BOSS round shape	-								
	GAMMA	LINEA	TIPO	MATERIALE	COPPA	STANDARD	TYPE	HOM.	2T/4T	ART.
	SITO	SITO	FULL SYSTEM	STEEL	N/A			e-approved	2T	0246
50	TYPHOON 50	2002-2008								
	GAMMA	LINEA	TIPO	MATERIALE	COPPA	STANDARD	TYPE	HOM.	2T/4T	ART.
	LEOVINCE	HAND MADE TT	FULL SYSTEM	ALUMINUM	N/A			e-approved	2T	4064
	LEOVINCE	HAND MADE TT BLACK	FULL SYSTEM	ALUMINUM	N/A			e-approved	2T	4064B
	LEOVINCE	TOURING	FULL SYSTEM	STEEL	N/A			e-approved	2T	5512
50	TYPHOON 50	2009-								
	GAMMA	LINEA	TIPO	MATERIALE	COPPA	STANDARD	TYPE	HOM.	2T/4T	ART.
	LEOVINCE	HAND MADE TT	FULL SYSTEM	ALUMINUM	N/A			e-approved	2T	4064
	LEOVINCE	HAND MADE TT BLACK	FULL SYSTEM	ALUMINUM	N/A			e-approved	2T	4064B
	LEOVINCE	TOURING	FULL SYSTEM	STEEL	N/A			e-approved	2T	5512
	SITO	SITO	FULL SYSTEM	STEEL	N/A			e-approved	2T	0586

CC. MODELLO		ANNO								
50	TYPHOON 50 2 stroke	2012-								
	GAMMA	LINEA	TIPO	MATERIALE	COPPA	STANDARD	TYPE	HOM.	2T/4T	ART.
	LEOVINCE	HAND MADE TT	FULL SYSTEM	ALUMINUM	N/A			e-approved	2T	4065
	LEOVINCE	HAND MADE TT BLACK	FULL SYSTEM	ALUMINUM	N/A			e-approved	2T	4065B
	LEOVINCE	TOURING	FULL SYSTEM	STEEL	N/A			e-approved	2T	5565
	SITO	SITOPPLUS	FULL SYSTEM	STEEL	N/A			e-approved	2T	0579
50	ZIP 4 stroke	2000-								
	GAMMA	LINEA	TIPO	MATERIALE	COPPA	STANDARD	TYPE	HOM.	2T/4T	ART.
	SITO	SITOPPLUS	FULL SYSTEM	STEEL	N/A			e-approved	4T	0582
50	ZIP 50 2 stroke	2009-2012								
	GAMMA	LINEA	TIPO	MATERIALE	COPPA	STANDARD	TYPE	HOM.	2T/4T	ART.
	LEOVINCE	HAND MADE TT	FULL SYSTEM	ALUMINUM	N/A			e-approved	2T	4065
	LEOVINCE	HAND MADE TT BLACK	FULL SYSTEM	ALUMINUM	N/A			e-approved	2T	4065B
	LEOVINCE	TOURING	FULL SYSTEM	STEEL	N/A			e-approved	2T	5565
	SITO	SITOPPLUS	FULL SYSTEM	STEEL	N/A			e-approved	2T	0579
50	ZIP FAST RIDER	-								
	GAMMA	LINEA	TIPO	MATERIALE	COPPA	STANDARD	TYPE	HOM.	2T/4T	ART.
	LEOVINCE	HAND MADE TT	FULL SYSTEM	ALUMINUM	N/A			e-approved	2T	4064
	LEOVINCE	HAND MADE TT BLACK	FULL SYSTEM	ALUMINUM	N/A			e-approved	2T	4064B
	LEOVINCE	TOURING	FULL SYSTEM	STEEL	N/A			e-approved	2T	5562
50	ZIP KAT air cooled	1999-								
	GAMMA	LINEA	TIPO	MATERIALE	COPPA	STANDARD	TYPE	HOM.	2T/4T	ART.
	LEOVINCE	HAND MADE TT	FULL SYSTEM	ALUMINUM	N/A			e-approved	2T	4064
	LEOVINCE	HAND MADE TT BLACK	FULL SYSTEM	ALUMINUM	N/A			e-approved	2T	4064B
50	ZIP KAT air cooled	2000-								
	GAMMA	LINEA	TIPO	MATERIALE	COPPA	STANDARD	TYPE	HOM.	2T/4T	ART.
	LEOVINCE	HAND MADE TT	FULL SYSTEM	ALUMINUM	N/A			e-approved	2T	4065
	LEOVINCE	HAND MADE TT BLACK	FULL SYSTEM	ALUMINUM	N/A			e-approved	2T	4065B
	LEOVINCE	TOURING	FULL SYSTEM	STEEL	N/A			e-approved	2T	5565
	SITO	SITOPPLUS	FULL SYSTEM	STEEL	N/A			e-approved	2T	0579
50	ZIP SP	-								
	GAMMA	LINEA	TIPO	MATERIALE	COPPA	STANDARD	TYPE	HOM.	2T/4T	ART.
	LEOVINCE	TOURING	FULL SYSTEM	STEEL	N/A			e-approved	2T	5512
50	ZIP SP	1996-2004								
	GAMMA	LINEA	TIPO	MATERIALE	COPPA	STANDARD	TYPE	HOM.	2T/4T	ART.
	SITO	SITOPPLUS	FULL SYSTEM	STEEL	N/A	EURO 1		e-approved	2T	0572
125	FLY	2005-2005								
	GAMMA	LINEA	TIPO	MATERIALE	COPPA	STANDARD	TYPE	HOM.	2T/4T	ART.
	SITO	SITOPPLUS	FULL SYSTEM	STEEL	N/A			e-approved	2T	0265
125	LIBERTY	2000-								
	GAMMA	LINEA	TIPO	MATERIALE	COPPA	STANDARD	TYPE	HOM.	2T/4T	ART.
	SITO	SITOPPLUS	FULL SYSTEM	STEEL	N/A			e-approved	2T	0265

CC. MODELLO		ANNO								
125 LIBERTY 125 4 stroke		2006-2007								
GAMMA	LINEA	TIPO	MATERIALE	COPPA	STANDARD	TYPE	HOM.	2T/4T	ART.	
SITO	SITOPPLUS	FULL SYSTEM	STEEL	N/A			e-approved	4T	0265	
125 LIBERTY RST/PTT		2004-2006								
GAMMA	LINEA	TIPO	MATERIALE	COPPA	STANDARD	TYPE	HOM.	2T/4T	ART.	
SITO	SITOPPLUS	FULL SYSTEM	STEEL	N/A			e-approved	4T	0265	
125 MP3 125		2007-								
GAMMA	LINEA	TIPO	MATERIALE	COPPA	STANDARD	TYPE	HOM.	2T/4T	ART.	
LEOVINCE	GRANTURISMO	FULL SYSTEM	STAINLESS STEEL	N/A	EURO 3	M473	e-approved	4T	3499	
LEOVINCE	GRANTURISMO BLACK	FULL SYSTEM	STAINLESS STEEL	N/A	EURO 3		e-approved	4T	3499B	
125 SKIPPER 125		-								
GAMMA	LINEA	TIPO	MATERIALE	COPPA	STANDARD	TYPE	HOM.	2T/4T	ART.	
SITO	SITOPPLUS	FULL SYSTEM	STEEL	N/A			Not approved	2T	0229	
125 X7 125		2008-								
GAMMA	LINEA	TIPO	MATERIALE	COPPA	STANDARD	TYPE	HOM.	2T/4T	ART.	
LEOVINCE	GRANTURISMO	FULL SYSTEM	STAINLESS STEEL	N/A	EURO 3	M36	e-approved	4T	3499	
LEOVINCE	GRANTURISMO BLACK	FULL SYSTEM	STAINLESS STEEL	N/A	EURO 3		e-approved	4T	3499B	
125 X8 125		2004-2006								
GAMMA	LINEA	TIPO	MATERIALE	COPPA	STANDARD	TYPE	HOM.	2T/4T	ART.	
LEOVINCE	GRANTURISMO	FULL SYSTEM	STAINLESS STEEL	N/A	EURO 3	M36	e-approved	4T	3499	
LEOVINCE	GRANTURISMO BLACK	FULL SYSTEM	STAINLESS STEEL	N/A	EURO 3		e-approved	4T	3499B	
125 X-EVO 125		2008-								
GAMMA	LINEA	TIPO	MATERIALE	COPPA	STANDARD	TYPE	HOM.	2T/4T	ART.	
LEOVINCE	GRANTURISMO	FULL SYSTEM	STAINLESS STEEL	N/A	EURO 3	M36	e-approved	4T	3499	
LEOVINCE	GRANTURISMO BLACK	FULL SYSTEM	STAINLESS STEEL	N/A	EURO 3		e-approved	4T	3499B	
150 SKIPPER 150		-								
GAMMA	LINEA	TIPO	MATERIALE	COPPA	STANDARD	TYPE	HOM.	2T/4T	ART.	
SITO	SITOPPLUS	FULL SYSTEM	STEEL	N/A			Not approved	2T	0229	
200 LIBERTY 200 4 stroke		2006-2007								
GAMMA	LINEA	TIPO	MATERIALE	COPPA	STANDARD	TYPE	HOM.	2T/4T	ART.	
SITO	SITOPPLUS	FULL SYSTEM	STEEL	N/A			e-approved	4T	0265	
300 BEVERLY 300		2010-2016								
GAMMA	LINEA	TIPO	MATERIALE	COPPA	STANDARD	TYPE	HOM.	2T/4T	ART.	
LEOVINCE	NERO	SLIP-ON	STAINLESS STEEL	CARBON FIBER	EURO 3	M69	e-approved	4T	14024	
350 BEVERLY 350 SPORT TOURING EURO 3		2011-2016								
GAMMA	LINEA	TIPO	MATERIALE	COPPA	STANDARD	TYPE	HOM.	2T/4T	ART.	
LEOVINCE	NERO	SLIP-ON	STAINLESS STEEL	CARBON FIBER	EURO 3	M69	e-approved	4T	14025	

# PIAGGIO

CC. MODELLO		ANNO								
400 MP3 400/LT/RST		2007-2012								
GAMMA	LINEA	TIPO	MATERIALE	COPPA	STANDARD	TYPE	HOM.	2T/4T	ART.	
LEOVINCE	LV ONE EVO	SLIP-ON	STAINLESS STEEL	CARBON FIBER	EURO 3		e-approved	4T	8490E	
LEOVINCE	NERO	SLIP-ON	STAINLESS STEEL	CARBON FIBER	EURO 3	M64/M86/M59/ M61	e-approved	4T	14005	
LEOVINCE	GRANTURISMO	SLIP-ON	STAINLESS STEEL	N/A	EURO 3		e-approved	4T	3496	
LEOVINCE	GRANTURISMO BLACK	SLIP-ON	STAINLESS STEEL	N/A	EURO 3		e-approved	4T	3496B	
500 MP3 500/BUSINESS/LT/SPORT		2011-2016								
GAMMA	LINEA	TIPO	MATERIALE	COPPA	STANDARD	TYPE	HOM.	2T/4T	ART.	
LEOVINCE	LV ONE EVO	SLIP-ON	STAINLESS STEEL	CARBON FIBER	EURO 3		e-approved	4T	8490E	
LEOVINCE	GRANTURISMO	SLIP-ON	STAINLESS STEEL	N/A	EURO 3		e-approved	4T	3496	
LEOVINCE	GRANTURISMO BLACK	SLIP-ON	STAINLESS STEEL	N/A	EURO 3		e-approved	4T	3496B	
LEOVINCE	NERO	SLIP-ON	STAINLESS STEEL	CARBON FIBER	EURO 3	M64/M86/M59/ M61	e-approved	4T	14005	
N/A APE CAR/APE 601 (flat shape)		-								
GAMMA	LINEA	TIPO	MATERIALE	COPPA	STANDARD	TYPE	HOM.	2T/4T	ART.	
SITO	SITO	FULL SYSTEM	STEEL	N/A			Not approved	2T	0226	
N/A APE TM 703		-								
GAMMA	LINEA	TIPO	MATERIALE	COPPA	STANDARD	TYPE	HOM.	2T/4T	ART.	
SITO	SITO	FULL SYSTEM	STEEL	N/A	Not approved		Not approved	2T	0245	
50 NRG		1994-1996								
GAMMA	LINEA	TIPO	MATERIALE	COPPA	STANDARD	TYPE	HOM.	2T/4T	ART.	
LEOVINCE	HAND MADE TT	FULL SYSTEM	ALUMINUM	N/A			e-approved	2T	4060	
LEOVINCE	HAND MADE TT BLACK	FULL SYSTEM	ALUMINUM	N/A			e-approved	2T	4060B	
50 NTT		1994-1996								
GAMMA	LINEA	TIPO	MATERIALE	COPPA	STANDARD	TYPE	HOM.	2T/4T	ART.	
LEOVINCE	HAND MADE TT	FULL SYSTEM	ALUMINUM	N/A			e-approved	2T	4060	
LEOVINCE	HAND MADE TT BLACK	FULL SYSTEM	ALUMINUM	N/A			e-approved	2T	4060B	

# QINGQI

CC. MODELLO		ANNO								
50 50QT 4 stroke		2007-2012								
GAMMA	LINEA	TIPO	MATERIALE	COPPA	STANDARD	TYPE	HOM.	2T/4T	ART.	
SITO	SITO	FULL SYSTEM	STEEL	N/A			e-approved	4T	0736	
50 QT 50 4 stroke		-								
GAMMA	LINEA	TIPO	MATERIALE	COPPA	STANDARD	TYPE	HOM.	2T/4T	ART.	
LEOVINCE	LEOVINCE	FULL SYSTEM	STAINLESS STEEL	N/A			e-approved	4T	7470	

## QJ

CC. MODELLO	ANNO									
50 RACE GT 50 (B92)	-									
GAMMA	LINEA	TIPO	MATERIALE	COPPA	STANDARD	TYPE	HOM.	2T/4T	ART.	
LEOVINCE	HAND MADE TT	FULL SYSTEM	ALUMINUM	N/A			e-approved	2T	7404	
LEOVINCE	HAND MADE TT BLACK	FULL SYSTEM	ALUMINUM	N/A			e-approved	2T	7404B	
SITO	SITO	FULL SYSTEM	STEEL	N/A			e-approved	2T	0718	
50 RACE GT 50 Limited (B05)	-									
GAMMA	LINEA	TIPO	MATERIALE	COPPA	STANDARD	TYPE	HOM.	2T/4T	ART.	
LEOVINCE	HAND MADE TT	FULL SYSTEM	ALUMINUM	N/A			e-approved	2T	7404	
LEOVINCE	HAND MADE TT BLACK	FULL SYSTEM	ALUMINUM	N/A			e-approved	2T	7404B	
SITO	SITO	FULL SYSTEM	STEEL	N/A			e-approved	2T	0718	

## REX MOTO

CC. MODELLO	ANNO									
50 RS 500 - 139QMB engine 4 stroke	2007-2008									
GAMMA	LINEA	TIPO	MATERIALE	COPPA	STANDARD	TYPE	HOM.	2T/4T	ART.	
LEOVINCE	LEOVINCE	FULL SYSTEM	STAINLESS STEEL	N/A			e-approved	4T	7470	
50 RS 500 4 stroke	2007-2012									
GAMMA	LINEA	TIPO	MATERIALE	COPPA	STANDARD	TYPE	HOM.	2T/4T	ART.	
SITO	SITO	FULL SYSTEM	STEEL	N/A			e-approved	4T	0736	

## RIDE

CC. MODELLO	ANNO									
50 TWISTER 50	-									
GAMMA	LINEA	TIPO	MATERIALE	COPPA	STANDARD	TYPE	HOM.	2T/4T	ART.	
LEOVINCE	HAND MADE TT	FULL SYSTEM	ALUMINUM	N/A			e-approved	2T	7404	
LEOVINCE	HAND MADE TT BLACK	FULL SYSTEM	ALUMINUM	N/A			e-approved	2T	7404B	
SITO	SITO	FULL SYSTEM	STEEL	N/A			e-approved	2T	0718	

## RIEJU

CC. MODELLO	ANNO									
50 MRT 50/PRO/SM	2009-2012									
GAMMA	LINEA	TIPO	MATERIALE	COPPA	STANDARD	TYPE	HOM.	2T/4T	ART.	
LEOVINCE	X-FIGHT	FULL SYSTEM	STAINLESS STEEL	N/A			e-approved	2T	3281	
LEOVINCE	X-FIGHT BLACK	FULL SYSTEM	STAINLESS STEEL	N/A			e-approved	2T	3281B	

## ROOK

CC. MODELLO	ANNO									
50 TRAVEL CITY 50 - 139QMB engine 4 stroke	-									
GAMMA	LINEA	TIPO	MATERIALE	COPPA	STANDARD	TYPE	HOM.	2T/4T	ART.	
LEOVINCE	LEOVINCE	FULL SYSTEM	STAINLESS STEEL	N/A			Not Approved	4T	7470	

## ROOK

CC. MODELLO	ANNO									
50 TRAVEL CITY/VICTORY 50 - 139QMB engine 4 stroke	2007-2012									
GAMMA	LINEA	TIPO	MATERIALE	COPPA	STANDARD	TYPE	HOM.	2T/4T	ART.	
SITO	SITO	FULL SYSTEM	STEEL	N/A			Not approved	4T	0736	
50 VICTORY - 139QMB engine 4 stroke	-									
GAMMA	LINEA	TIPO	MATERIALE	COPPA	STANDARD	TYPE	HOM.	2T/4T	ART.	
LEOVINCE	LEOVINCE	FULL SYSTEM	STAINLESS STEEL	N/A			Not Approved	4T	7470	

## SUKIDA

CC. MODELLO	ANNO									
50 GOS - 139QMB engine 4 stroke	-									
GAMMA	LINEA	TIPO	MATERIALE	COPPA	STANDARD	TYPE	HOM.	2T/4T	ART.	
LEOVINCE	LEOVINCE	FULL SYSTEM	STAINLESS STEEL	N/A			Not Approved	4T	7470	
50 SUKIDA TOP 1 - 139QMB engine 4 stroke	-									
GAMMA	LINEA	TIPO	MATERIALE	COPPA	STANDARD	TYPE	HOM.	2T/4T	ART.	
LEOVINCE	LEOVINCE	FULL SYSTEM	STAINLESS STEEL	N/A			Not Approved	4T	7470	
50 TOP/GOS - 139QMB engine 4 stroke	2007-2012									
GAMMA	LINEA	TIPO	MATERIALE	COPPA	STANDARD	TYPE	HOM.	2T/4T	ART.	
SITO	SITO	FULL SYSTEM	STEEL	N/A			Not approved	4T	0736	

## SUZUKI

CC. MODELLO	ANNO									
50 AY 50 KATANA air/liquid cooled	-2002									
GAMMA	LINEA	TIPO	MATERIALE	COPPA	STANDARD	TYPE	HOM.	2T/4T	ART.	
SITO	SITO	FULL SYSTEM	STEEL	N/A			e-approved	2T	0589	
125 AN 125 BURGMAN	2010-2013									
GAMMA	LINEA	TIPO	MATERIALE	COPPA	STANDARD	TYPE	HOM.	2T/4T	ART.	
LEOVINCE	GRANTURISMO	FULL SYSTEM	STAINLESS STEEL	N/A	EURO 3		e-approved	4T	3490	
LEOVINCE	GRANTURISMO BLACK	FULL SYSTEM	STAINLESS STEEL	N/A	EURO 3		e-approved	4T	3490B	
125 UH 125 BURGMAN	2002-2006									
GAMMA	LINEA	TIPO	MATERIALE	COPPA	STANDARD	TYPE	HOM.	2T/4T	ART.	
LEOVINCE	GRANTURISMO	FULL SYSTEM	STAINLESS STEEL	N/A	EURO 2		e-approved	4T	3227	
LEOVINCE	GRANTURISMO BLACK	FULL SYSTEM	STAINLESS STEEL	N/A	EURO 2		e-approved	4T	3227B	
125 UH 125 BURGMAN	2007-2009									
GAMMA	LINEA	TIPO	MATERIALE	COPPA	STANDARD	TYPE	HOM.	2T/4T	ART.	
LEOVINCE	GRANTURISMO	FULL SYSTEM	STAINLESS STEEL	N/A	EURO 3		e-approved	4T	3490	
LEOVINCE	GRANTURISMO BLACK	FULL SYSTEM	STAINLESS STEEL	N/A	EURO 3		e-approved	4T	3490B	
150 UH 150 BURGMAN	2002-2006									
GAMMA	LINEA	TIPO	MATERIALE	COPPA	STANDARD	TYPE	HOM.	2T/4T	ART.	
LEOVINCE	GRANTURISMO	FULL SYSTEM	STAINLESS STEEL	N/A	EURO 2		e-approved	4T	3227	
LEOVINCE	GRANTURISMO BLACK	FULL SYSTEM	STAINLESS STEEL	N/A	EURO 2		e-approved	4T	3227B	

CC. MODELLO		ANNO								
200 UH 200 BURGMAN		2007-2013								
GAMMA	LINEA	TIPO	MATERIALE	COPPA	STANDARD	TYPE	HOM.	2T/4T	ART.	
LEOVINCE	GRANTURISMO	FULL SYSTEM	STAINLESS STEEL	N/A	EURO 3		e-approved	4T	3490	
LEOVINCE	GRANTURISMO BLACK	FULL SYSTEM	STAINLESS STEEL	N/A	EURO 3		e-approved	4T	3490B	
250 AN 250 BURGMAN		1998-2002								
GAMMA	LINEA	TIPO	MATERIALE	COPPA	STANDARD	TYPE	HOM.	2T/4T	ART.	
LEOVINCE	GRANTURISMO	FULL SYSTEM	STAINLESS STEEL	N/A			e-approved	4T	3495	
LEOVINCE	GRANTURISMO BLACK	FULL SYSTEM	STAINLESS STEEL	N/A			e-approved	4T	3495B	
250 GSX 250 R/ABS		2017-2018								
GAMMA	LINEA	TIPO	MATERIALE	COPPA	STANDARD	TYPE	HOM.	2T/4T	ART.	
LEOVINCE	GP CORSA	SLIP-ON	CARBON FIBER	N/A	EURO 4	WDNO var.1 ver.1	Racing use only	4T	3387	
LEOVINCE	GP CORSA EVO	SLIP-ON	CARBON FIBER	TECHNOPOLYMER	EURO 4	WDNO var.1 ver.1	Racing use only	4T	3387E	
LEOVINCE	LV-10	SLIP-ON	STAINLESS STEEL	STAINLESS STEEL	EURO 4	WDNO; 1/1	Racing use only	4T	15213	
LEOVINCE	LV-10 BLACK	SLIP-ON	STAINLESS STEEL	STAINLESS STEEL	EURO 4	WDNO; 1/1	Racing use only	4T	15213B	
400 AN 400 BURGMAN		1999-2002								
GAMMA	LINEA	TIPO	MATERIALE	COPPA	STANDARD	TYPE	HOM.	2T/4T	ART.	
LEOVINCE	GRANTURISMO	FULL SYSTEM	STAINLESS STEEL	N/A	EURO 1		e-approved	4T	3495	
LEOVINCE	GRANTURISMO BLACK	FULL SYSTEM	STAINLESS STEEL	N/A	EURO 1		e-approved	4T	3495B	
400 AN 400 BURGMAN K7		2007-2013								
GAMMA	LINEA	TIPO	MATERIALE	COPPA	STANDARD	TYPE	HOM.	2T/4T	ART.	
LEOVINCE	GRANTURISMO	SLIP-ON	STAINLESS STEEL	N/A	EURO 3		e-approved	4T	3474	
LEOVINCE	GRANTURISMO BLACK	SLIP-ON	STAINLESS STEEL	N/A	EURO 3		e-approved	4T	3474B	
400 DR-Z 400 S		2001-2008								
GAMMA	LINEA	TIPO	MATERIALE	COPPA	STANDARD	TYPE	HOM.	2T/4T	ART.	
LEOVINCE	X3	SLIP-ON	ALUMINUM	N/A			e-approved	4T	3836	
400 LTZ 400		2003-2008								
GAMMA	LINEA	TIPO	MATERIALE	COPPA	STANDARD	TYPE	HOM.	2T/4T	ART.	
LEOVINCE	X3	SLIP-ON	ALUMINUM	N/A			e-approved	4T	3914E	
600 GSX-R 600		2006-2007								
GAMMA	LINEA	TIPO	MATERIALE	COPPA	STANDARD	TYPE	HOM.	2T/4T	ART.	
LEOVINCE	GP STYLE	SLIP-ON	STAINLESS STEEL	N/A	EURO 3		e-approved	4T	7906	
LEOVINCE	GP STYLE BLACK	SLIP-ON	STAINLESS STEEL	N/A	EURO 3		e-approved	4T	7906B	
600 GSX-R 600		2011-2016								
GAMMA	LINEA	TIPO	MATERIALE	COPPA	STANDARD	TYPE	HOM.	2T/4T	ART.	
LEOVINCE	FACTORY S	SLIP-ON	CARBON FIBER	CARBON FIBER	EURO 3		e*-approved	4T	8525S	
LEOVINCE	FACTORY S	SLIP-ON	STAINLESS STEEL	CARBON FIBER	EURO 3		e*-approved	4T	8526S	
650 AN 650 BURGMAN		2003-2012								
GAMMA	LINEA	TIPO	MATERIALE	COPPA	STANDARD	TYPE	HOM.	2T/4T	ART.	
LEOVINCE	GRANTURISMO	FULL SYSTEM	STAINLESS STEEL	N/A	EURO 2/3		e-approved	4T	3479	
LEOVINCE	GRANTURISMO BLACK	FULL SYSTEM	STAINLESS STEEL	N/A	EURO 2/3		e-approved	4T	3479B	



CC. MODELLO		ANNO								
650 BURGMAN 650		2013-2016								
GAMMA	LINEA	TIPO	MATERIALE	COPPA	STANDARD	TYPE	HOM.	2T/4T	ART.	
LEOVINCE	LV ONE EVO	FULL SYSTEM 2/1	STAINLESS STEEL	CARBON FIBER	EURO 3		e-approved	4T	8788E	
LEOVINCE	NERO	FULL SYSTEM 2/1	STAINLESS STEEL	CARBON FIBER	EURO 3		e-approved	4T	14002	
650 DR 650 SE		1996-2015								
GAMMA	LINEA	TIPO	MATERIALE	COPPA	STANDARD	TYPE	HOM.	2T/4T	ART.	
LEOVINCE	X3	SLIP-ON	ALUMINUM	N/A			Not approved	4T	3378	
650 GSF 650 BANDIT/S		2007-2015								
GAMMA	LINEA	TIPO	MATERIALE	COPPA	STANDARD	TYPE	HOM.	2T/4T	ART.	
LEOVINCE	LV ONE EVO	SLIP-ON	STAINLESS STEEL	CARBON FIBER	EURO 3	JS1CZ	e-approved	4T	8415E	
LEOVINCE	LV ONE EVO	SLIP-ON	CARBON FIBER	CARBON FIBER	EURO 3	JS1CZ	e-approved	4T	8416E	
650 GSX-F 650		2008-2015								
GAMMA	LINEA	TIPO	MATERIALE	COPPA	STANDARD	TYPE	HOM.	2T/4T	ART.	
LEOVINCE	LV ONE EVO	SLIP-ON	STAINLESS STEEL	CARBON FIBER	EURO 3	CJ135 - CJ225	e-approved	4T	8415E	
LEOVINCE	LV ONE EVO	SLIP-ON	CARBON FIBER	CARBON FIBER	EURO 3	CJ135 - CJ225	e-approved	4T	8416E	
650 LS 650 SAVAGE		1986-1997								
GAMMA	LINEA	TIPO	MATERIALE	COPPA	STANDARD	TYPE	HOM.	2T/4T	ART.	
SILVERTAIL	K02	SLIP-ON	CHROMED STEEL	N/A			e-approved	4T	2226	
650 SFV 650 GLADIUS		2009-2015								
GAMMA	LINEA	TIPO	MATERIALE	COPPA	STANDARD	TYPE	HOM.	2T/4T	ART.	
LEOVINCE	GP STYLE	SLIP-ON	STAINLESS STEEL	N/A	EURO 3		e*-approved	4T	8207	
LEOVINCE	GP STYLE BLACK	SLIP-ON	STAINLESS STEEL	N/A	EURO 3		e*-approved	4T	8207B	
650 SV 650 X ABS		2018-								
GAMMA	LINEA	TIPO	MATERIALE	COPPA	STANDARD	TYPE	HOM.	2T/4T	ART.	
LEOVINCE	GP DUALS	SLIP-ON	STAINLESS STEEL	STAINLESS STEEL	EURO 4	WCX0 var. 1 ver. 2	ECE-Approved	4T	15105	
LEOVINCE	LV ONE EVO	SLIP-ON	STAINLESS STEEL	CARBON FIBER	EURO 4	WCX0 VAR1 VER.4 - WCX1 VAR.1 VER.4 35 KW	ECE-Approved	4T	14152E	
LEOVINCE	LV ONE EVO	SLIP-ON	CARBON FIBER	CARBON FIBER	EURO 4	WCX0 VAR1 VER.4 - WCX1 VAR.1 VER.4 35 KW	ECE-Approved	4T	14153E	
LEOVINCE	NERO	SLIP-ON	STAINLESS STEEL	CARBON FIBER	EURO 4	WCX0 VAR1 VER.4 - WCX1 VAR.1 VER.4 35 KW	ECE-Approved	4T	14031	
650 SV 650/ABS		2016-2018								
GAMMA	LINEA	TIPO	MATERIALE	COPPA	STANDARD	TYPE	HOM.	2T/4T	ART.	
LEOVINCE	GP DUALS	SLIP-ON	STAINLESS STEEL	STAINLESS STEEL	EURO 4	WCX0 var. 1 ver. 2	ECE-Approved	4T	15105	
LEOVINCE	LV ONE EVO	SLIP-ON	STAINLESS STEEL	CARBON FIBER	EURO 4	WCX0 1.2	ECE-Approved	4T	14152E	
LEOVINCE	LV ONE EVO	SLIP-ON	CARBON FIBER	CARBON FIBER	EURO 4	WCX0 1.2	ECE-Approved	4T	14153E	
LEOVINCE	NERO	SLIP-ON	STAINLESS STEEL	CARBON FIBER	EURO 4	WCX0 1.2	ECE-Approved	4T	14031	

CC. MODELLO		ANNO								
750 GSR/GSX-S 750		2011-2016								
GAMMA	LINEA	TIPO	MATERIALE	COPPA	STANDARD	TYPE	HOM.	2T/4T	ART.	
LEOVINCE	FACTORY S	SLIP-ON	CARBON FIBER	CARBON FIBER	EURO 3		e*-approved	4T	8545S	
LEOVINCE	FACTORY S	SLIP-ON	STAINLESS STEEL	CARBON FIBER	EURO 3		e*-approved	4T	8546S	
LEOVINCE	GP DUALS	SLIP-ON	STAINLESS STEEL	STAINLESS STEEL	EURO 3		e*-approved	4T	15106	
LEOVINCE	LV ONE EVO	SLIP-ON	STAINLESS STEEL	CARBON FIBER	EURO 3		e*-approved	4T	8543E	
LEOVINCE	LV ONE EVO	SLIP-ON	CARBON FIBER	CARBON FIBER	EURO 3		e*-approved	4T	8544E	
LEOVINCE	NERO	SLIP-ON	STAINLESS STEEL	CARBON FIBER	EURO 3	C5	e*-approved	4T	14010	
750 GSX-R 750		2006-2007								
GAMMA	LINEA	TIPO	MATERIALE	COPPA	STANDARD	TYPE	HOM.	2T/4T	ART.	
LEOVINCE	GP STYLE	SLIP-ON	STAINLESS STEEL	N/A	EURO 3		e-approved	4T	7906	
LEOVINCE	GP STYLE BLACK	SLIP-ON	STAINLESS STEEL	N/A	EURO 3		e-approved	4T	7906B	
750 GSX-R 750		2011-2016								
GAMMA	LINEA	TIPO	MATERIALE	COPPA	STANDARD	TYPE	HOM.	2T/4T	ART.	
LEOVINCE	FACTORY S	SLIP-ON	CARBON FIBER	CARBON FIBER	EURO 3		e*-approved	4T	8525S	
LEOVINCE	FACTORY S	SLIP-ON	STAINLESS STEEL	CARBON FIBER	EURO 3		e*-approved	4T	8526S	
750 GSX-S 750/Z ABS		2017-2018								
GAMMA	LINEA	TIPO	MATERIALE	COPPA	STANDARD	TYPE	HOM.	2T/4T	ART.	
LEOVINCE	FACTORY S	SLIP-ON	STAINLESS STEEL	CARBON FIBER	EURO 4	WC50; 1/1	ECE-Approved	4T	14177S	
LEOVINCE	FACTORY S	SLIP-ON	CARBON FIBER	CARBON FIBER	EURO 4	WC50; 1/1	ECE-Approved	4T	14178S	
LEOVINCE	GP DUALS	SLIP-ON	STAINLESS STEEL	STAINLESS STEEL	EURO 4		ECE-Approved	4T	15106	
LEOVINCE	LV ONE EVO	SLIP-ON	STAINLESS STEEL	CARBON FIBER	EURO 4	WC50; 1/1	ECE-Approved	4T	14175E	
LEOVINCE	LV ONE EVO	SLIP-ON	CARBON FIBER	CARBON FIBER	EURO 4	WC50; 1/1	ECE-Approved	4T	14176E	
LEOVINCE	NERO	SLIP-ON	STAINLESS STEEL	CARBON FIBER	EURO 4	WC50; 1/1	ECE-Approved	4T	14040	
800 VL 800 INTRUDER VOLUSIA		2001-2005								
GAMMA	LINEA	TIPO	MATERIALE	COPPA	STANDARD	TYPE	HOM.	2T/4T	ART.	
SILVERTAIL	K02	FULL SYSTEM	CHROMED STEEL	N/A			e-approved	4T	2401	
800 VL INTRUDER C 800		2006-2012								
GAMMA	LINEA	TIPO	MATERIALE	COPPA	STANDARD	TYPE	HOM.	2T/4T	ART.	
SILVERTAIL	K02	FULL SYSTEM	CHROMED STEEL	N/A			e-approved	4T	2401	
800 VL INTRUDER M 800		2005-2012								
GAMMA	LINEA	TIPO	MATERIALE	COPPA	STANDARD	TYPE	HOM.	2T/4T	ART.	
SILVERTAIL	K02	FULL SYSTEM	CHROMED STEEL	N/A			e-approved	4T	2401	
1000 GSX-R 1000		2012-2016								
GAMMA	LINEA	TIPO	MATERIALE	COPPA	STANDARD	TYPE	HOM.	2T/4T	ART.	
LEOVINCE	FACTORY S	SLIP-ON	CARBON FIBER	CARBON FIBER	EURO 3		e*-approved	4T	8598S	
1000 GSX-R 1000		2012-2016								
GAMMA	LINEA	TIPO	MATERIALE	COPPA	STANDARD	TYPE	HOM.	2T/4T	ART.	
LEOVINCE	FACTORY S	SLIP-ON	STAINLESS STEEL	CARBON FIBER	EURO 3		e*-approved	4T	8599S	
1000 GSX-S 1000		2015-2016								
GAMMA	LINEA	TIPO	MATERIALE	COPPA	STANDARD	TYPE	HOM.	2T/4T	ART.	
LEOVINCE	LV ONE EVO	SLIP-ON	STAINLESS STEEL	CARBON FIBER	EURO 3	DG	e*-approved	4T	14112E	
LEOVINCE	NERO	SLIP-ON	STAINLESS STEEL	CARBON FIBER	EURO 3	DG	e*-approved	4T	14022	

# SUZUKI

CC. MODELLO	ANNO									
1000 GSX-S 1000 F	2015-2016									
GAMMA	LINEA	TIPO	MATERIALE	COPPA	STANDARD	TYPE	HOM.	2T/4T	ART.	
LEOVINCE	LV ONE EVO	SLIP-ON	STAINLESS STEEL	CARBON FIBER	EURO 3	DG	e*-approved	4T	14112E	
LEOVINCE	NERO	SLIP-ON	STAINLESS STEEL	CARBON FIBER	EURO 3	DG	e-approved	4T	14022	
1000 V-STROM 1000 (fits with original panniers)	2014-2016									
GAMMA	LINEA	TIPO	MATERIALE	COPPA	STANDARD	TYPE	HOM.	2T/4T	ART.	
LEOVINCE	NERO	SLIP-ON	STAINLESS STEEL	CARBON FIBER	EURO 3	DD var.1 ver.1	e*-approved	4T	14012	
1000 V-STROM 1000/1000 XT ABS (fits with original panniers)	2017-2018									
GAMMA	LINEA	TIPO	MATERIALE	COPPA	STANDARD	TYPE	HOM.	2T/4T	ART.	
LEOVINCE	NERO	SLIP-ON	STAINLESS STEEL	CARBON FIBER	EURO 4	WDDO var.1 ver.1	ECE-Approved	4T	14047	
1250 BANDIT 1250 (fits with original panniers)	2007-2016									
GAMMA	LINEA	TIPO	MATERIALE	COPPA	STANDARD	TYPE	HOM.	2T/4T	ART.	
LEOVINCE	LV ONE EVO	SLIP-ON	STAINLESS STEEL	CARBON FIBER	EURO 3	WVCH	e*-approved	4T	8417E	
LEOVINCE	LV ONE EVO	SLIP-ON	CARBON FIBER	CARBON FIBER	EURO 3	WVCH	e*-approved	4T	8418E	
1250 GSX 1250 FA (fits with original panniers)	2010-2016									
GAMMA	LINEA	TIPO	MATERIALE	COPPA	STANDARD	TYPE	HOM.	2T/4T	ART.	
LEOVINCE	LV ONE EVO	SLIP-ON	STAINLESS STEEL	CARBON FIBER	EURO 3		e*-approved	4T	8417E	
LEOVINCE	LV ONE EVO	SLIP-ON	CARBON FIBER	CARBON FIBER	EURO 3		e*-approved	4T	8418E	
1400 VS GL 1400 INTRUDER	1987-2000									
GAMMA	LINEA	TIPO	MATERIALE	COPPA	STANDARD	TYPE	HOM.	2T/4T	ART.	
SILVERTAIL	K02	SLIP-ON	CHROMED STEEL	N/A			e-approved	4T	2203	

# SYM

CC. MODELLO	ANNO									
300 GTS 300	2010-2011									
GAMMA	LINEA	TIPO	MATERIALE	COPPA	STANDARD	TYPE	HOM.	2T/4T	ART.	
LEOVINCE	LV ONE EVO	SLIP-ON	STAINLESS STEEL	CARBON FIBER	EURO 3		e-approved	4T	8562E	
300 JOYMAX 300 EVO/GTS	2010-2011									
GAMMA	LINEA	TIPO	MATERIALE	COPPA	STANDARD	TYPE	HOM.	2T/4T	ART.	
LEOVINCE	LV ONE EVO	SLIP-ON	STAINLESS STEEL	CARBON FIBER	EURO 3		e-approved	4T	8562E	

# TOMOS

CC. MODELLO	ANNO									
50 FLEXTER 25/45 km/h	2005-2006									
GAMMA	LINEA	TIPO	MATERIALE	COPPA	STANDARD	TYPE	HOM.	2T/4T	ART.	
SITO	SITOPUS	FULL SYSTEM	STEEL	N/A			e-approved	2T	0730	

CC. MODELLO		ANNO								
675 STREET TRIPLE 675		2007-2012								
GAMMA	LINEA	TIPO	MATERIALE	COPPA	STANDARD	TYPE	HOM.	2T/4T	ART.	
LEOVINCE	GP STYLE	2 SLIP-ON	STAINLESS STEEL	N/A	EURO 3	Type D67LD	e*-approved	4T	7940	
LEOVINCE	GP STYLE BLACK	2 SLIP-ON	STAINLESS STEEL	N/A	EURO 3		e*-approved	4T	7940B	
LEOVINCE	LV ONE EVO	2 SLIP-ON	STAINLESS STEEL	CARBON FIBER	EURO 3	Type D67LD	e*-approved	4T	8567E	
675 STREET TRIPLE 675		2007-2012								
GAMMA	LINEA	TIPO	MATERIALE	COPPA	STANDARD	TYPE	HOM.	2T/4T	ART.	
LEOVINCE	LV ONE EVO	2 SLIP-ON	CARBON FIBER	CARBON FIBER	EURO 3	Type D67LD	e*-approved	4T	8568E	
675 STREET TRIPLE 675 R		2009-2012								
GAMMA	LINEA	TIPO	MATERIALE	COPPA	STANDARD	TYPE	HOM.	2T/4T	ART.	
LEOVINCE	LV ONE EVO	2 SLIP-ON	CARBON FIBER	CARBON FIBER	EURO 3		e*-approved	4T	8568E	
LEOVINCE	GP STYLE	2 SLIP-ON	STAINLESS STEEL	N/A	EURO 3		e*-approved	4T	7940	
LEOVINCE	GP STYLE BLACK	2 SLIP-ON	STAINLESS STEEL	N/A	EURO 3		e*-approved	4T	7940B	
LEOVINCE	LV ONE EVO	2 SLIP-ON	STAINLESS STEEL	CARBON FIBER	EURO 3		e*-approved	4T	8567E	
675 STREET TRIPLE 675/R		2013-2016								
GAMMA	LINEA	TIPO	MATERIALE	COPPA	STANDARD	TYPE	HOM.	2T/4T	ART.	
LEOVINCE	FACTORY S	SLIP-ON	CARBON FIBER	CARBON FIBER	EURO 3		e-approved	4T	8771S	
LEOVINCE	FACTORY S	SLIP-ON	STAINLESS STEEL	CARBON FIBER	EURO 3		e-approved	4T	8772S	
800 TIGER 800 XC/XCA/XCX/XR/XRX (fits with original panniers)		2011-2016								
GAMMA	LINEA	TIPO	MATERIALE	COPPA	STANDARD	TYPE	HOM.	2T/4T	ART.	
LEOVINCE	LV ONE EVO	SLIP-ON	STAINLESS STEEL	CARBON FIBER	EURO 3		e*-approved	4T	8491E	
LEOVINCE	LV ONE EVO	SLIP-ON	CARBON FIBER	CARBON FIBER	EURO 3		e*-approved	4T	8492E	
LEOVINCE	NERO	SLIP-ON	STAINLESS STEEL	CARBON FIBER	EURO 3	A08/A082	e*-approved	4T	14006	
900 BONNEVILLE T100		2016-2017								
GAMMA	LINEA	TIPO	MATERIALE	COPPA	STANDARD	TYPE	HOM.	2T/4T	ART.	
LEOVINCE	CLASSIC RACER	2 SLIP-ON	STAINLESS STEEL	STAINLESS STEEL	EURO 4	DBO1: 1/1, -/2, -/3, -/4 - DBO2: 1/1, -/2, -/3, -/4	ECE-Approved	4T	15002	
900 STREET TWIN		2016-2017								
GAMMA	LINEA	TIPO	MATERIALE	COPPA	STANDARD	TYPE	HOM.	2T/4T	ART.	
LEOVINCE	CLASSIC RACER	2 SLIP-ON	STAINLESS STEEL	STAINLESS STEEL	EURO 4	DP01: 1/1, -/2, -/3, -/4, -/5, -/6 - DP02: 1/1, -/2, -/3 35kW	ECE-Approved	4T	15004	
1050 SPEED TRIPLE 1050 R/S		2016-2017								
GAMMA	LINEA	TIPO	MATERIALE	COPPA	STANDARD	TYPE	HOM.	2T/4T	ART.	
LEOVINCE	FACTORY S	SLIP-ON	STAINLESS STEEL	CARBON FIBER	EURO 4	NN01 var.1	ECE-Approved	4T	14237S	
LEOVINCE	FACTORY S	SLIP-ON	CARBON FIBER	CARBON FIBER	EURO 4	NN01 var.1	ECE-Approved	4T	14238S	
LEOVINCE	LV ONE EVO	2 SLIP-ON	STAINLESS STEEL	CARBON FIBER	EURO 4	NN01 var.1	ECE-Approved	4T	14235E	
LEOVINCE	LV ONE EVO	2 SLIP-ON	CARBON FIBER	CARBON FIBER	EURO 4	NN01 var.1	ECE-Approved	4T	14236E	
1050 SPEED TRIPLE 1050/R (low side mount)		2011-2013								
GAMMA	LINEA	TIPO	MATERIALE	COPPA	STANDARD	TYPE	HOM.	2T/4T	ART.	
LEOVINCE	FACTORY S	SLIP-ON	CARBON FIBER	CARBON FIBER	EURO 3		e*-approved	4T	8514S	
LEOVINCE	FACTORY S	SLIP-ON	STAINLESS STEEL	CARBON FIBER	EURO 3		e*-approved	4T	8515S	

# TRIUMPH

CC. MODELLO	ANNO									
1200 BONNEVILLE T120	2016-2017									
GAMMA	LINEA	TIPO	MATERIALE	COPPA	STANDARD	TYPE	HOM.	2T/4T	ART.	
LEOVINCE	CLASSIC RACER	2 SLIP-ON	STAINLESS STEEL	STAINLESS STEEL	EURO 4	DUO1; 1/1, -/2, -/3, -/4	ECE-Approved	4T	15003	
1200 THRUXTON water cooled	2016-2017									
GAMMA	LINEA	TIPO	MATERIALE	COPPA	STANDARD	TYPE	HOM.	2T/4T	ART.	
LEOVINCE	CLASSIC RACER	2 SLIP-ON	STAINLESS STEEL	STAINLESS STEEL	EURO 4	DEOT; 1/?	ECE-Approved	4T	15005	
1200 TIGER EXPLORER (fits with original panniers)	2012-2015									
GAMMA	LINEA	TIPO	MATERIALE	COPPA	STANDARD	TYPE	HOM.	2T/4T	ART.	
LEOVINCE	LV ONE EVO	SLIP-ON	STAINLESS STEEL	CARBON FIBER	EURO 3		e*-approved	4T	8720E	
LEOVINCE	NERO	SLIP-ON	STAINLESS STEEL	CARBON FIBER	EURO 3		e*-approved	4T	14004	
1200 TIGER EXPLORER XR/XCX/XCX LOW/XCA (fits with original panniers)	2016-2017									
GAMMA	LINEA	TIPO	MATERIALE	COPPA	STANDARD	TYPE	HOM.	2T/4T	ART.	
LEOVINCE	LV ONE EVO	SLIP-ON	STAINLESS STEEL	CARBON FIBER	EURO 4	V201 var.1 ver.1; 2; 3; 4; 5; 6; 7; 8; 9; 10; 11; 12; 13; 14; 15; 16	ECE-Approved	4T	14214E	
LEOVINCE	NERO	SLIP-ON	STAINLESS STEEL	CARBON FIBER	EURO 4	V201 var.1 ver.1; 2; 3; 4; 5; 6; 7; 8; 9; 10; 11; 12; 13; 14; 15; 16	ECE-Approved	4T	14051	

# VESPA

CC. MODELLO	ANNO									
50 50 ET2	1997-2005									
GAMMA	LINEA	TIPO	MATERIALE	COPPA	STANDARD	TYPE	HOM.	2T/4T	ART.	
LEOVINCE	TOURING	FULL SYSTEM	STEEL	N/A			e-approved	2T	5511	
50 50 ET2	1997-2005									
GAMMA	LINEA	TIPO	MATERIALE	COPPA	STANDARD	TYPE	HOM.	2T/4T	ART.	
SITO	SITOPPLUS	FULL SYSTEM	STEEL	N/A			e-approved	2T	0264	
50 50/90	-									
GAMMA	LINEA	TIPO	MATERIALE	COPPA	STANDARD	TYPE	HOM.	2T/4T	ART.	
LEOVINCE	LEOVINCE	FULL SYSTEM	STEEL	N/A			Not approved	2T	4205	
50 50/SPECIAL	-									
GAMMA	LINEA	TIPO	MATERIALE	COPPA	STANDARD	TYPE	HOM.	2T/4T	ART.	
SITO	SITO	FULL SYSTEM	STEEL	N/A	EURO 0 (DGM)		DGM approved	2T	0208	
50 ET4 4 stroke	-									
GAMMA	LINEA	TIPO	MATERIALE	COPPA	STANDARD	TYPE	HOM.	2T/4T	ART.	
SITO	SITOPPLUS	FULL SYSTEM	STEEL	N/A			e-approved	4T	0713	
50 HP/PK 50/XL/RUSH/N/FL2	-									
GAMMA	LINEA	TIPO	MATERIALE	COPPA	STANDARD	TYPE	HOM.	2T/4T	ART.	
SITO	SITO	FULL SYSTEM	STEEL	N/A			e-approved	2T	0230	
SITO	SITOPPLUS	FULL SYSTEM	STEEL	N/A			e-approved	2T	0250	

CC. MODELLO		ANNO								
50	LX 50 4T 4 VALVES	2009-2014								
	GAMMA	LINEA	TIPO	MATERIALE	COPPA	STANDARD	TYPE	HOM.	2T/4T	ART.
	SITO	SITOPPLUS	FULL SYSTEM	STEEL	N/A			e-approved	4T	0745
50	LX 50/S 50 2 stroke	2005-2012								
	GAMMA	LINEA	TIPO	MATERIALE	COPPA	STANDARD	TYPE	HOM.	2T/4T	ART.
	SITO	SITOPPLUS	FULL SYSTEM	STEEL	N/A			e-approved	2T	0264
50	PRIMAVERA 50 2 stroke	2013-2017								
	GAMMA	LINEA	TIPO	MATERIALE	COPPA	STANDARD	TYPE	HOM.	2T/4T	ART.
	SITO	SITOPPLUS	FULL SYSTEM	STEEL	N/A		ZAPC53200	Not approved	2T	0264
50	SPRINT 50 2 stroke	2014-2017								
	GAMMA	LINEA	TIPO	MATERIALE	COPPA	STANDARD	TYPE	HOM.	2T/4T	ART.
	SITO	SITOPPLUS	FULL SYSTEM	STEEL	N/A		ZAPC53201	Not approved	2T	0264
80	80 PX	-								
	GAMMA	LINEA	TIPO	MATERIALE	COPPA	STANDARD	TYPE	HOM.	2T/4T	ART.
	SITO	SITO	FULL SYSTEM	STEEL	N/A			e-approved	2T	0231
125	125 ET3 MOD. 50/90	-								
	GAMMA	LINEA	TIPO	MATERIALE	COPPA	STANDARD	TYPE	HOM.	2T/4T	ART.
	SITO	SITO	FULL SYSTEM	STEEL	N/A			Not approved	2T	0238
125	125 ET3/125 PRIMAVERA (manifold included)	-								
	GAMMA	LINEA	TIPO	MATERIALE	COPPA	STANDARD	TYPE	HOM.	2T/4T	ART.
	LEOVINCE	LEOVINCE	FULL SYSTEM	STEEL	N/A			Not approved	2T	4206
	SITO	SITO	FULL SYSTEM	STEEL	N/A		Not approved	Not approved	2T	0237
125	125 ET4	1999-2002								
	GAMMA	LINEA	TIPO	MATERIALE	COPPA	STANDARD	TYPE	HOM.	2T/4T	ART.
	SITO	SITOPPLUS	FULL SYSTEM	STEEL	N/A			e-approved	2T	0265
125	125 PX	-								
	GAMMA	LINEA	TIPO	MATERIALE	COPPA	STANDARD	TYPE	HOM.	2T/4T	ART.
	SITO	SITO	FULL SYSTEM	STEEL	N/A			e-approved	2T	0231
	SITO	SITOPPLUS	FULL SYSTEM	STEEL	N/A			Not approved	2T	0254
125	125 T5	-								
	GAMMA	LINEA	TIPO	MATERIALE	COPPA	STANDARD	TYPE	HOM.	2T/4T	ART.
	SITO	SITO	FULL SYSTEM	STEEL	N/A			Not approved	2T	0243
125	GRANTURISMO 125	2006-2007								
	GAMMA	LINEA	TIPO	MATERIALE	COPPA	STANDARD	TYPE	HOM.	2T/4T	ART.
	LEOVINCE	GRANTURISMO	FULL SYSTEM	STAINLESS STEEL	N/A		EURO 3	e-approved	4T	3226
	LEOVINCE	GRANTURISMO BLACK	FULL SYSTEM	STAINLESS STEEL	N/A		EURO 3	e-approved	4T	3226B

CC. MODELLO	ANNO									
125 GTS 125 SUPER	2009-2015									
GAMMA	LINEA	TIPO	MATERIALE	COPPA	STANDARD	TYPE	HOM.	2T/4T	ART.	
LEOVINCE	LV ONE EVO	SLIP-ON	STAINLESS STEEL	CARBON FIBER	EURO 3		e-approved	4T	8571E	
125 LIBERTY 125 4 stroke	2009-2012									
GAMMA	LINEA	TIPO	MATERIALE	COPPA	STANDARD	TYPE	HOM.	2T/4T	ART.	
SITO	SITOPPLUS	FULL SYSTEM	STEEL	N/A	EURO 3		Not approved	4T	0743	
125 LX 125 4 stroke carburetor	2006-2009									
GAMMA	LINEA	TIPO	MATERIALE	COPPA	STANDARD	TYPE	HOM.	2T/4T	ART.	
SITO	SITOPPLUS	FULL SYSTEM	STEEL	N/A			e-approved	4T	0265	
125 LX-V 125	2005-2006									
GAMMA	LINEA	TIPO	MATERIALE	COPPA	STANDARD	TYPE	HOM.	2T/4T	ART.	
SITO	SITOPPLUS	FULL SYSTEM	STEEL	N/A			e-approved	4T	0265	
125 PK 125	-									
GAMMA	LINEA	TIPO	MATERIALE	COPPA	STANDARD	TYPE	HOM.	2T/4T	ART.	
SITO	SITO	FULL SYSTEM	STEEL	N/A			Not approved	2T	0234	
125 PK 125/125 XL	-									
GAMMA	LINEA	TIPO	MATERIALE	COPPA	STANDARD	TYPE	HOM.	2T/4T	ART.	
SITO	SITOPPLUS	FULL SYSTEM	STEEL	N/A			Not approved	2T	0251	
125 PRIMAVERA 125	-									
GAMMA	LINEA	TIPO	MATERIALE	COPPA	STANDARD	TYPE	HOM.	2T/4T	ART.	
SITO	SITO	FULL SYSTEM	STEEL	N/A	EURO 0 (DGM)		DGM approved	2T	0208	
125 VESPA LX 125 i.e. 4 stroke	2009-2012									
GAMMA	LINEA	TIPO	MATERIALE	COPPA	STANDARD	TYPE	HOM.	2T/4T	ART.	
SITO	SITOPPLUS	FULL SYSTEM	STEEL	N/A	EURO 3	M68	e-approved	4T	0743	
150 150 ET4	1999-2002									
GAMMA	LINEA	TIPO	MATERIALE	COPPA	STANDARD	TYPE	HOM.	2T/4T	ART.	
SITO	SITOPPLUS	FULL SYSTEM	STEEL	N/A			e-approved	2T	0265	
150 150 PX	-									
GAMMA	LINEA	TIPO	MATERIALE	COPPA	STANDARD	TYPE	HOM.	2T/4T	ART.	
SITO	SITO	FULL SYSTEM	STEEL	N/A			e-approved	2T	0231	
SITO	SITOPPLUS	FULL SYSTEM	STEEL	N/A			Not approved	2T	0254	
150 LIBERTY 150 4 stroke	2009-2012									
GAMMA	LINEA	TIPO	MATERIALE	COPPA	STANDARD	TYPE	HOM.	2T/4T	ART.	
SITO	SITOPPLUS	FULL SYSTEM	STEEL	N/A	EURO 3		Not approved	4T	0743	
150 LX-V 150	2005-2006									
GAMMA	LINEA	TIPO	MATERIALE	COPPA	STANDARD	TYPE	HOM.	2T/4T	ART.	
SITO	SITOPPLUS	FULL SYSTEM	STEEL	N/A			e-approved	4T	0265	

CC. MODELLO		ANNO								
150 VESPA LX 150 i.e. 4 stroke		2009-2012								
GAMMA	LINEA	TIPO	MATERIALE	COPPA	STANDARD	TYPE	HOM.	2T/4T	ART.	
SITO	SITOPPLUS	FULL SYSTEM	STEEL	N/A	EURO 3	M68	e-approved	4T	0743	
200 200 PE		-								
GAMMA	LINEA	TIPO	MATERIALE	COPPA	STANDARD	TYPE	HOM.	2T/4T	ART.	
SITO	SITO	FULL SYSTEM	STEEL	N/A			e-approved	2T	0232	
SITO	SITOPPLUS	FULL SYSTEM	STEEL	N/A			Not approved	2T	0259	
200 GRANTURISMO 200		2003-2007								
GAMMA	LINEA	TIPO	MATERIALE	COPPA	STANDARD	TYPE	HOM.	2T/4T	ART.	
LEOVINCE	GRANTURISMO	FULL SYSTEM	STAINLESS STEEL	N/A	EURO 2		e-approved	4T	3226	
LEOVINCE	GRANTURISMO BLACK	FULL SYSTEM	STAINLESS STEEL	N/A	EURO 2		e-approved	4T	3226B	
250 GTS 250		2005-2013								
GAMMA	LINEA	TIPO	MATERIALE	COPPA	STANDARD	TYPE	HOM.	2T/4T	ART.	
LEOVINCE	GRANTURISMO	SLIP-ON	STAINLESS STEEL	N/A	EURO 3		e-approved	4T	3204	
LEOVINCE	GRANTURISMO BLACK	SLIP-ON	STAINLESS STEEL	N/A	EURO 3		e-approved	4T	3204B	
LEOVINCE	LV ONE EVO	SLIP-ON	STAINLESS STEEL	CARBON FIBER	EURO 3		e-approved	4T	8571E	
250 GTV 250		2006-2013								
GAMMA	LINEA	TIPO	MATERIALE	COPPA	STANDARD	TYPE	HOM.	2T/4T	ART.	
LEOVINCE	GRANTURISMO	SLIP-ON	STAINLESS STEEL	N/A	EURO 3		e-approved	4T	3204	
LEOVINCE	GRANTURISMO BLACK	SLIP-ON	STAINLESS STEEL	N/A	EURO 3		e-approved	4T	3204B	
LEOVINCE	LV ONE EVO	SLIP-ON	STAINLESS STEEL	CARBON FIBER	EURO 3		e-approved	4T	8571E	
250 GTV 250 NAVY		2008-2008								
GAMMA	LINEA	TIPO	MATERIALE	COPPA	STANDARD	TYPE	HOM.	2T/4T	ART.	
LEOVINCE	GRANTURISMO	SLIP-ON	STAINLESS STEEL	N/A	EURO 3		e-approved	4T	3204	
LEOVINCE	GRANTURISMO BLACK	SLIP-ON	STAINLESS STEEL	N/A	EURO 3		e-approved	4T	3204B	
LEOVINCE	LV ONE EVO	SLIP-ON	STAINLESS STEEL	CARBON FIBER	EURO 3		e-approved	4T	8571E	
300 GTS 300 SUPER		2008-2015								
GAMMA	LINEA	TIPO	MATERIALE	COPPA	STANDARD	TYPE	HOM.	2T/4T	ART.	
LEOVINCE	GRANTURISMO	SLIP-ON	STAINLESS STEEL	N/A	EURO 3		e-approved	4T	3204	
LEOVINCE	GRANTURISMO BLACK	SLIP-ON	STAINLESS STEEL	N/A	EURO 3		e-approved	4T	3204B	
LEOVINCE	LV ONE EVO	SLIP-ON	STAINLESS STEEL	CARBON FIBER	EURO 3		e-approved	4T	8571E	
300 GTS 300 SUPERSPORT		2010-2015								
GAMMA	LINEA	TIPO	MATERIALE	COPPA	STANDARD	TYPE	HOM.	2T/4T	ART.	
LEOVINCE	GRANTURISMO	SLIP-ON	STAINLESS STEEL	N/A	EURO 3		e-approved	4T	3204	
LEOVINCE	GRANTURISMO BLACK	SLIP-ON	STAINLESS STEEL	N/A	EURO 3		e-approved	4T	3204B	
LEOVINCE	LV ONE EVO	SLIP-ON	STAINLESS STEEL	CARBON FIBER	EURO 3		e-approved	4T	8571E	
300 GTV 300 VIA MONTENAPOLEONE		2010-2013								
GAMMA	LINEA	TIPO	MATERIALE	COPPA	STANDARD	TYPE	HOM.	2T/4T	ART.	
LEOVINCE	GRANTURISMO	SLIP-ON	STAINLESS STEEL	N/A	EURO 3		e-approved	4T	3204	
LEOVINCE	GRANTURISMO BLACK	SLIP-ON	STAINLESS STEEL	N/A	EURO 3		e-approved	4T	3204B	
LEOVINCE	LV ONE EVO	SLIP-ON	STAINLESS STEEL	CARBON FIBER	EURO 3		e-approved	4T	8571E	



# VESPA

CC. MODELLO	ANNO									
N/A GL	-									
GAMMA	LINEA	TIPO	MATERIALE	COPPA	STANDARD	TYPE	HOM.	2T/4T	ART.	
SITO	SITO	FULL SYSTEM	STEEL	N/A			Not approved	2T	0204	
N/A SPRINT	-									
GAMMA	LINEA	TIPO	MATERIALE	COPPA	STANDARD	TYPE	HOM.	2T/4T	ART.	
SITO	SITO	FULL SYSTEM	STEEL	N/A			Not approved	2T	0211	
N/A VESPA 1953 - 1956	1953-1956									
GAMMA	LINEA	TIPO	MATERIALE	COPPA	STANDARD	TYPE	HOM.	2T/4T	ART.	
SITO	SITO	FULL SYSTEM	STEEL	N/A			Not approved	2T	0201	
N/A VESPA 1958	1958-									
GAMMA	LINEA	TIPO	MATERIALE	COPPA	STANDARD	TYPE	HOM.	2T/4T	ART.	
SITO	SITO	FULL SYSTEM	STEEL	N/A			Not approved	2T	0203	

# YAMAHA

CC. MODELLO	ANNO									
50 AEROX 50	1997-1999									
GAMMA	LINEA	TIPO	MATERIALE	COPPA	STANDARD	TYPE	HOM.	2T/4T	ART.	
SITO	SITO	FULL SYSTEM	STEEL	N/A			e-approved	2T	0587	
50 AEROX 50	1998-1999									
GAMMA	LINEA	TIPO	MATERIALE	COPPA	STANDARD	TYPE	HOM.	2T/4T	ART.	
LEOVINCE	TOURING	FULL SYSTEM	STEEL	N/A			e-approved	2T	5517	
LEOVINCE	HAND MADE TT	FULL SYSTEM	ALUMINUM	N/A			e-approved	2T	4054	
LEOVINCE	HAND MADE TT BLACK	FULL SYSTEM	ALUMINUM	N/A			e-approved	2T	4054B	
50 AEROX 50 KAT	2000-2001									
GAMMA	LINEA	TIPO	MATERIALE	COPPA	STANDARD	TYPE	HOM.	2T/4T	ART.	
LEOVINCE	TOURING	FULL SYSTEM	STEEL	N/A			e-approved	2T	5576	
LEOVINCE	HAND MADE TT	FULL SYSTEM	ALUMINUM	N/A			e-approved	2T	4039	
LEOVINCE	HAND MADE TT BLACK	FULL SYSTEM	ALUMINUM	N/A			e-approved	2T	4039B	
50 AEROX 50 KAT liquid cooled	2004-2012									
GAMMA	LINEA	TIPO	MATERIALE	COPPA	STANDARD	TYPE	HOM.	2T/4T	ART.	
LEOVINCE	TOURING	FULL SYSTEM	STEEL	N/A			e-approved	2T	4094	
LEOVINCE	HAND MADE TT	FULL SYSTEM	ALUMINUM	N/A			e-approved	2T	4054	
LEOVINCE	HAND MADE TT BLACK	FULL SYSTEM	ALUMINUM	N/A			e-approved	2T	4054B	
SITO	SITO	FULL SYSTEM	STEEL	N/A			e-approved	2T	0716	
50 AEROX 50 R/NAKED	2013-									
GAMMA	LINEA	TIPO	MATERIALE	COPPA	STANDARD	TYPE	HOM.	2T/4T	ART.	
LEOVINCE	TOURING	FULL SYSTEM	STEEL	N/A			e-approved	2T	4094	
LEOVINCE	HAND MADE TT	FULL SYSTEM	ALUMINUM	N/A			e-approved	2T	4054	
LEOVINCE	HAND MADE TT BLACK	FULL SYSTEM	ALUMINUM	N/A			e-approved	2T	4054B	

CC. MODELLO		ANNO								
50 AXIS		1994-1995								
GAMMA	LINEA	TIPO	MATERIALE	COPPA	STANDARD	TYPE	HOM.	2T/4T	ART.	
SITO	SITOPPLUS	FULL SYSTEM	STEEL	N/A			TPSi approved	2T	0556	
50 BREEZE		1994-1995								
GAMMA	LINEA	TIPO	MATERIALE	COPPA	STANDARD	TYPE	HOM.	2T/4T	ART.	
SITO	SITOPPLUS	FULL SYSTEM	STEEL	N/A			TPSi approved	2T	0556	
50 BW'S 50		1998-1999								
GAMMA	LINEA	TIPO	MATERIALE	COPPA	STANDARD	TYPE	HOM.	2T/4T	ART.	
SITO	SITOPPLUS	FULL SYSTEM	STEEL	N/A			e-approved	2T	0559	
50 BW'S 50/BW'S 50 NAKED		2004-2013								
GAMMA	LINEA	TIPO	MATERIALE	COPPA	STANDARD	TYPE	HOM.	2T/4T	ART.	
SITO	SITOPPLUS	FULL SYSTEM	STEEL	N/A			e-approved	2T	0715	
50 BW'S 50/NAKED		2004-2013								
GAMMA	LINEA	TIPO	MATERIALE	COPPA	STANDARD	TYPE	HOM.	2T/4T	ART.	
LEOVINCE	HAND MADE TT	FULL SYSTEM	ALUMINUM	N/A			e-approved	2T	4091	
LEOVINCE	HAND MADE TT BLACK	FULL SYSTEM	ALUMINUM	N/A			e-approved	2T	4091B	
50 BW'S 50/NEXT GENERATION		1988-1999								
GAMMA	LINEA	TIPO	MATERIALE	COPPA	STANDARD	TYPE	HOM.	2T/4T	ART.	
LEOVINCE	HAND MADE TT	FULL SYSTEM	ALUMINUM	N/A			e-approved	2T	4053	
LEOVINCE	HAND MADE TT BLACK	FULL SYSTEM	ALUMINUM	N/A			e-approved	2T	4053B	
50 BW'S NEXT GENERATION 50 KAT		2002-								
GAMMA	LINEA	TIPO	MATERIALE	COPPA	STANDARD	TYPE	HOM.	2T/4T	ART.	
SITO	SITO	FULL SYSTEM	STEEL	N/A			e-approved	2T	0590	
50 BW'S NEXT GENERATION 50 KAT air cooled		2002-								
GAMMA	LINEA	TIPO	MATERIALE	COPPA	STANDARD	TYPE	HOM.	2T/4T	ART.	
LEOVINCE	TOURING	FULL SYSTEM	STEEL	N/A			e-approved	2T	5516	
50 BW'S/NEXT GENERATION		1988-1999								
GAMMA	LINEA	TIPO	MATERIALE	COPPA	STANDARD	TYPE	HOM.	2T/4T	ART.	
LEOVINCE	TOURING	FULL SYSTEM	STEEL	N/A			e-approved	2T	5516	
50 DT 50/X/R		2003-2011								
GAMMA	LINEA	TIPO	MATERIALE	COPPA	STANDARD	TYPE	HOM.	2T/4T	ART.	
LEOVINCE	X-FIGHT	FULL SYSTEM	STAINLESS STEEL	N/A			e-approved	2T	3260	
LEOVINCE	X-FIGHT BLACK	FULL SYSTEM	STAINLESS STEEL	N/A			e-approved	2T	3260B	
50 JOG		1994-1995								
GAMMA	LINEA	TIPO	MATERIALE	COPPA	STANDARD	TYPE	HOM.	2T/4T	ART.	
SITO	SITOPPLUS	FULL SYSTEM	STEEL	N/A			TPSi approved	2T	0556	
50 JOG R 50 air cooled		2004-								
GAMMA	LINEA	TIPO	MATERIALE	COPPA	STANDARD	TYPE	HOM.	2T/4T	ART.	
SITO	SITO	FULL SYSTEM	STEEL	N/A			e-approved	2T	0597	

CC. MODELLO		ANNO								
50 NEO'S 50		2002-2012								
GAMMA	LINEA	TIPO	MATERIALE	COPPA	STANDARD	TYPE	HOM.	2T/4T	ART.	
LEOVINCE	TOURING	FULL SYSTEM	STEEL	N/A			e-approved	2T	5515	
SITO	SITO	FULL SYSTEM	STEEL	N/A			e-approved	2T	0734	
SITO	SITOPUS	FULL SYSTEM	STEEL	N/A			e-approved	2T	0574	
50 SLIDER		2000-2002								
GAMMA	LINEA	TIPO	MATERIALE	COPPA	STANDARD	TYPE	HOM.	2T/4T	ART.	
LEOVINCE	HAND MADE TT	FULL SYSTEM	ALUMINUM	N/A			e-approved	2T	4053	
LEOVINCE	HAND MADE TT BLACK	FULL SYSTEM	ALUMINUM	N/A			e-approved	2T	4053B	
LEOVINCE	TOURING	FULL SYSTEM	STEEL	N/A			e-approved	2T	5516	
SITO	SITO	FULL SYSTEM	STEEL	N/A			e-approved	2T	0590	
50 SPY		1995-1998								
GAMMA	LINEA	TIPO	MATERIALE	COPPA	STANDARD	TYPE	HOM.	2T/4T	ART.	
LEOVINCE	HAND MADE TT	FULL SYSTEM	ALUMINUM	N/A			e-approved	2T	4053	
LEOVINCE	HAND MADE TT BLACK	FULL SYSTEM	ALUMINUM	N/A			e-approved	2T	4053B	
LEOVINCE	TOURING	FULL SYSTEM	STEEL	N/A			e-approved	2T	5516	
SITO	SITO	FULL SYSTEM	STEEL	N/A			e-approved	2T	0590	
50 TZR 50		2003-2013								
GAMMA	LINEA	TIPO	MATERIALE	COPPA	STANDARD	TYPE	HOM.	2T/4T	ART.	
LEOVINCE	X-FIGHT	FULL SYSTEM	STAINLESS STEEL	N/A			e-approved	2T	3282	
LEOVINCE	X-FIGHT BLACK	FULL SYSTEM	STAINLESS STEEL	N/A			e-approved	2T	3282B	
50 WHY 50 KAT air cooled		1998-								
GAMMA	LINEA	TIPO	MATERIALE	COPPA	STANDARD	TYPE	HOM.	2T/4T	ART.	
SITO	SITO	FULL SYSTEM	STEEL	N/A			e-approved	2T	0597	
50 YE 50 ZEST		1994-1995								
GAMMA	LINEA	TIPO	MATERIALE	COPPA	STANDARD	TYPE	HOM.	2T/4T	ART.	
SITO	SITOPUS	FULL SYSTEM	STEEL	N/A			TPSI approved	2T	0556	
125 MT-125/ABS		2014-2016								
GAMMA	LINEA	TIPO	MATERIALE	COPPA	STANDARD	TYPE	HOM.	2T/4T	ART.	
LEOVINCE	LV ONE	FULL SYSTEM 1/1	STAINLESS STEEL	TECHNOPOLYMER	EURO 3	RE11	e-approved	4T	8799	
125 TRICITY 125		2014-2016								
GAMMA	LINEA	TIPO	MATERIALE	COPPA	STANDARD	TYPE	HOM.	2T/4T	ART.	
LEOVINCE	NERO	SLIP-ON	STAINLESS STEEL	CARBON FIBER	EURO 3	SE78	e-approved	4T	14027	
125 WR 125 R/X		2009-2016								
GAMMA	LINEA	TIPO	MATERIALE	COPPA	STANDARD	TYPE	HOM.	2T/4T	ART.	
LEOVINCE	LV ONE	SLIP-ON	STAINLESS STEEL	TECHNOPOLYMER	EURO 3	DE07	e*-approved	4T	8724	
125 X-CITY 125		2006-2016								
GAMMA	LINEA	TIPO	MATERIALE	COPPA	STANDARD	TYPE	HOM.	2T/4T	ART.	
LEOVINCE	NERO	SLIP-ON	STAINLESS STEEL	CARBON FIBER	EURO 3	SE43	e-approved	4T	14023	

CC. MODELLO		ANNO								
125 X-CITY 125		2008-2016								
GAMMA	LINEA	TIPO	MATERIALE	COPPA	STANDARD	TYPE	HOM.	2T/4T	ART.	
LEOVINCE	LV ONE EVO	FULL SYSTEM 1/1	STAINLESS STEEL	CARBON FIBER	EURO 3	SE43	e-approved	4T	8537E	
125 X-MAX 125		2006-2016								
GAMMA	LINEA	TIPO	MATERIALE	COPPA	STANDARD	TYPE	HOM.	2T/4T	ART.	
LEOVINCE	LV ONE EVO	FULL SYSTEM 1/1	STAINLESS STEEL	CARBON FIBER	EURO 3	SE32	e-approved	4T	8537E	
LEOVINCE	NERO	SLIP-ON	STAINLESS STEEL	CARBON FIBER	EURO 3	SE32	e-approved	4T	14023	
125 YZF-R 125		2008-2013								
GAMMA	LINEA	TIPO	MATERIALE	COPPA	STANDARD	TYPE	HOM.	2T/4T	ART.	
LEOVINCE	GP STYLE	FULL SYSTEM 1/1	STAINLESS STEEL	N/A	EURO 3	RE061	e-approved	4T	8124	
LEOVINCE	GP STYLE BLACK	FULL SYSTEM 1/1	STAINLESS STEEL	N/A	EURO 3		e-approved	4T	8124B	
LEOVINCE	LV ONE	FULL SYSTEM 1/1	STAINLESS STEEL	TECHNOPOLYMER	EURO 3	RE061	e-approved	4T	8726	
125 YZF-R 125/ABS		2014-2016								
GAMMA	LINEA	TIPO	MATERIALE	COPPA	STANDARD	TYPE	HOM.	2T/4T	ART.	
LEOVINCE	LV ONE	FULL SYSTEM 1/1	STAINLESS STEEL	TECHNOPOLYMER	EURO 3	RE11	e-approved	4T	8799	
250 MT-25		2015-2017								
GAMMA	LINEA	TIPO	MATERIALE	COPPA	STANDARD	TYPE	HOM.	2T/4T	ART.	
LEOVINCE	GP CORSA	FULL SYSTEM 2/1	CARBON FIBER	N/A	N/A		Racing use only	4T	3380	
LEOVINCE	GP CORSA EVO	FULL SYSTEM 2/1	CARBON FIBER	TECHNOPOLYMER	N/A		Racing use only	4T	3380E	
LEOVINCE	LV ONE EVO	FULL SYSTEM 2/1	STAINLESS STEEL	CARBON FIBER	N/A	RH07/RG10	e-approved	4T	14122E	
LEOVINCE	LV ONE EVO	FULL SYSTEM 2/1	CARBON FIBER	CARBON FIBER	N/A	RH07/RG10	e-approved	4T	14123E	
LEOVINCE	LV PRO	SLIP-ON	STAINLESS STEEL	CARBON FIBER	N/A	RH07/RG10	e'-approved	4T	14124E	
LEOVINCE	LV PRO	SLIP-ON	CARBON FIBER	CARBON FIBER	N/A	RH07/RG10	e'-approved	4T	14125E	
LEOVINCE	LV-10	SLIP-ON	STAINLESS STEEL	STAINLESS STEEL	N/A		Racing use only	4T	15212	
LEOVINCE	LV-10 BLACK	SLIP-ON	STAINLESS STEEL	STAINLESS STEEL	N/A		Racing use only	4T	15212B	
250 WR 250 R/X		2008-2016								
GAMMA	LINEA	TIPO	MATERIALE	COPPA	STANDARD	TYPE	HOM.	2T/4T	ART.	
LEOVINCE	X3	SLIP-ON	ALUMINUM	N/A			e-approved	4T	3688	
250 X-CITY 250 carburetor/injection		2006-2016								
GAMMA	LINEA	TIPO	MATERIALE	COPPA	STANDARD	TYPE	HOM.	2T/4T	ART.	
LEOVINCE	GRANTURISMO	FULL SYSTEM	STAINLESS STEEL	N/A	EURO 3		e-approved	4T	3477	
LEOVINCE	GRANTURISMO BLACK	FULL SYSTEM	STAINLESS STEEL	N/A	EURO 3		e-approved	4T	3477B	
LEOVINCE	LV ONE EVO	FULL SYSTEM 1/1	STAINLESS STEEL	CARBON FIBER	EURO 3		e-approved	4T	8519E	
250 X-MAX 250 carburetor/injection		2006-2016								
GAMMA	LINEA	TIPO	MATERIALE	COPPA	STANDARD	TYPE	HOM.	2T/4T	ART.	
LEOVINCE	GRANTURISMO	FULL SYSTEM	STAINLESS STEEL	N/A	EURO 3	SG161-SC162-SG22-SG25-SG26	e-approved	4T	3477	
LEOVINCE	GRANTURISMO BLACK	FULL SYSTEM	STAINLESS STEEL	N/A	EURO 3		e-approved	4T	3477B	
LEOVINCE	LV ONE EVO	FULL SYSTEM 1/1	STAINLESS STEEL	CARBON FIBER	EURO 3	SG161-SC162-SG22-SG25-SG26	e-approved	4T	8519E	
LEOVINCE	NERO	FULL SYSTEM 1/1	STAINLESS STEEL	CARBON FIBER	EURO 3	SG161-SC162-SG22-SG25-SG26	e-approved	4T	14026	

CC. MODELLO		ANNO								
250 YZF-R25		2014-2017								
GAMMA	LINEA	TIPO	MATERIALE	COPPA	STANDARD	TYPE	HOM.	2T/4T	ART.	
LEOVINCE	GP CORSA	FULL SYSTEM 2/1	CARBON FIBER	N/A	N/A		Racing use only	4T	3380	
LEOVINCE	GP CORSA EVO	FULL SYSTEM 2/1	CARBON FIBER	TECHNOPOLYMER	N/A		Racing use only	4T	3380E	
LEOVINCE	LV ONE EVO	FULL SYSTEM 2/1	STAINLESS STEEL	CARBON FIBER	N/A	RG10	e-approved	4T	14122E	
LEOVINCE	LV ONE EVO	FULL SYSTEM 2/1	CARBON FIBER	CARBON FIBER	N/A	RG10	e-approved	4T	14123E	
LEOVINCE	LV PRO	SLIP-ON	STAINLESS STEEL	CARBON FIBER	N/A	RG10	e*-approved	4T	14124E	
LEOVINCE	LV PRO	SLIP-ON	CARBON FIBER	CARBON FIBER	N/A	RG10	e*-approved	4T	14125E	
LEOVINCE	LV-10	SLIP-ON	STAINLESS STEEL	STAINLESS STEEL	N/A		Racing use only	4T	15212	
LEOVINCE	LV-10 BLACK	SLIP-ON	STAINLESS STEEL	STAINLESS STEEL	N/A		Racing use only	4T	15212B	
300 MT-03		2016-2017								
GAMMA	LINEA	TIPO	MATERIALE	COPPA	STANDARD	TYPE	HOM.	2T/4T	ART.	
LEOVINCE	GP CORSA	FULL SYSTEM 2/1	CARBON FIBER	N/A	EURO 3		Racing use only	4T	3380	
LEOVINCE	GP CORSA EVO	FULL SYSTEM 2/1	CARBON FIBER	TECHNOPOLYMER	EURO 3		Racing use only	4T	3380E	
LEOVINCE	LV ONE EVO	FULL SYSTEM 2/1	STAINLESS STEEL	CARBON FIBER	EURO 3	RH07/RG10	e-approved	4T	14122E	
LEOVINCE	LV ONE EVO	FULL SYSTEM 2/1	CARBON FIBER	CARBON FIBER	EURO 3	RH07/RG10	e-approved	4T	14123E	
LEOVINCE	LV PRO	SLIP-ON	STAINLESS STEEL	CARBON FIBER	EURO 3	RH07/RG10	e*-approved	4T	14124E	
LEOVINCE	LV PRO	SLIP-ON	CARBON FIBER	CARBON FIBER	EURO 3	RH07/RG10	e*-approved	4T	14125E	
LEOVINCE	LV-10	SLIP-ON	STAINLESS STEEL	STAINLESS STEEL	EURO 3		Racing use only	4T	15212	
LEOVINCE	LV-10 BLACK	SLIP-ON	STAINLESS STEEL	STAINLESS STEEL	EURO 3		Racing use only	4T	15212B	
300 MT-03		2018-								
GAMMA	LINEA	TIPO	MATERIALE	COPPA	STANDARD	TYPE	HOM.	2T/4T	ART.	
LEOVINCE	GP CORSA	FULL SYSTEM 2/1	CARBON FIBER	N/A	EURO 4	RH12	Racing use only	4T	3380	
LEOVINCE	GP CORSA EVO	FULL SYSTEM 2/1	CARBON FIBER	TECHNOPOLYMER	EURO 4	RH12	Racing use only	4T	3380E	
LEOVINCE	LV ONE EVO	FULL SYSTEM 2/1	STAINLESS STEEL	CARBON FIBER	EURO 4	RH12	Racing use only	4T	14122E	
LEOVINCE	LV ONE EVO	FULL SYSTEM 2/1	CARBON FIBER	CARBON FIBER	EURO 4	RH12	Racing use only	4T	14123E	
LEOVINCE	LV PRO	SLIP-ON	STAINLESS STEEL	CARBON FIBER	EURO 4	RH12	ECE-Approved	4T	14257E	
LEOVINCE	LV PRO	SLIP-ON	CARBON FIBER	CARBON FIBER	EURO 4	RH12	ECE-Approved	4T	14258E	
LEOVINCE	LV-10	SLIP-ON	STAINLESS STEEL	STAINLESS STEEL	EURO 4	RH12	Racing use only	4T	15212	
LEOVINCE	LV-10 BLACK	SLIP-ON	STAINLESS STEEL	STAINLESS STEEL	EURO 4		Racing use only	4T	15212B	
300 VERSITY 300		2003-2005								
GAMMA	LINEA	TIPO	MATERIALE	COPPA	STANDARD	TYPE	HOM.	2T/4T	ART.	
LEOVINCE	GRANTURISMO	FULL SYSTEM	STAINLESS STEEL	N/A	EURO 2		e-approved	4T	3477	
LEOVINCE	GRANTURISMO BLACK	FULL SYSTEM	STAINLESS STEEL	N/A	EURO 2		e-approved	4T	3477B	
300 YZF-R3		2015-2017								
GAMMA	LINEA	TIPO	MATERIALE	COPPA	STANDARD	TYPE	HOM.	2T/4T	ART.	
LEOVINCE	LV-10	SLIP-ON	STAINLESS STEEL	STAINLESS STEEL	EURO 3		Racing use only	4T	15212	
LEOVINCE	LV-10 BLACK	SLIP-ON	STAINLESS STEEL	STAINLESS STEEL	EURO 3		Racing use only	4T	15212B	
LEOVINCE	GP CORSA	FULL SYSTEM 2/1	CARBON FIBER	N/A	EURO 3		Racing use only	4T	3380	
LEOVINCE	GP CORSA EVO	FULL SYSTEM 2/1	CARBON FIBER	TECHNOPOLYMER	EURO 3		Racing use only	4T	3380E	
LEOVINCE	LV ONE EVO	FULL SYSTEM 2/1	STAINLESS STEEL	CARBON FIBER	EURO 3	RH07	e-approved	4T	14122E	
LEOVINCE	LV ONE EVO	FULL SYSTEM 2/1	CARBON FIBER	CARBON FIBER	EURO 3	RH07	e-approved	4T	14123E	
LEOVINCE	LV PRO	SLIP-ON	STAINLESS STEEL	CARBON FIBER	EURO 3	RH07	e*-approved	4T	14124E	
LEOVINCE	LV PRO	SLIP-ON	CARBON FIBER	CARBON FIBER	EURO 3	RH07	e*-approved	4T	14125E	

CC. MODELLO		ANNO								
300 YZF-R3		2018-								
GAMMA	LINEA	TIPO	MATERIALE	COPPA	STANDARD	TYPE	HOM.	2T/4T	ART.	
LEOVINCE	LV-10	SLIP-ON	STAINLESS STEEL	STAINLESS STEEL	EURO 4	RH12	Racing use only	4T	15212	
LEOVINCE	LV-10 BLACK	SLIP-ON	STAINLESS STEEL	STAINLESS STEEL	EURO 4		Racing use only	4T	15212B	
LEOVINCE	GP CORSA	FULL SYSTEM 2/1	CARBON FIBER	N/A	EURO 4	RH12	Racing use only	4T	3380	
LEOVINCE	GP CORSA EVO	FULL SYSTEM 2/1	CARBON FIBER	TECHNOPOLYMER	EURO 4	RH12	Racing use only	4T	3380E	
LEOVINCE	LV ONE EVO	FULL SYSTEM 2/1	STAINLESS STEEL	CARBON FIBER	EURO 4	RH12	Racing use only	4T	14122E	
LEOVINCE	LV ONE EVO	FULL SYSTEM 2/1	CARBON FIBER	CARBON FIBER	EURO 4	RH12	Racing use only	4T	14123E	
LEOVINCE	LV PRO	SLIP-ON	STAINLESS STEEL	CARBON FIBER	EURO 4	RH12	ECE-Approved	4T	14257E	
LEOVINCE	LV PRO	SLIP-ON	CARBON FIBER	CARBON FIBER	EURO 4	RH12	ECE-Approved	4T	14258E	
400 X-MAX 400		2013-2016								
GAMMA	LINEA	TIPO	MATERIALE	COPPA	STANDARD	TYPE	HOM.	2T/4T	ART.	
LEOVINCE	NERO	SLIP-ON	STAINLESS STEEL	CARBON FIBER	EURO 3	SH07	e-approved	4T	14001	
500 T-MAX 500		2008-2011								
GAMMA	LINEA	TIPO	MATERIALE	COPPA	STANDARD	TYPE	HOM.	2T/4T	ART.	
LEOVINCE	NERO	FULL SYSTEM 2/1	STAINLESS STEEL	CARBON FIBER	EURO 3	SH07	e-approved	4T	14013	
530 T-MAX 530		2012-2016								
GAMMA	LINEA	TIPO	MATERIALE	COPPA	STANDARD	TYPE	HOM.	2T/4T	ART.	
LEOVINCE	NERO	FULL SYSTEM 2/1	STAINLESS STEEL	CARBON FIBER	EURO 3	SJ09	e-approved	4T	14000	
LEOVINCE	LV ONE EVO	FULL SYSTEM 2/1	STAINLESS STEEL	CARBON FIBER	EURO 3	SJ09	e-approved	4T	8588E	
530 TMAX 530 ABS/DX/SX		2017-2018								
GAMMA	LINEA	TIPO	MATERIALE	COPPA	STANDARD	TYPE	HOM.	2T/4T	ART.	
LEOVINCE	LV ONE EVO	FULL SYSTEM 2/1	STAINLESS STEEL	CARBON FIBER	EURO 4	SJ14 var.A ver.03	dB(A) Compliant	4T	14187E	
LEOVINCE	LV ONE EVO	FULL SYSTEM 2/1	STAINLESS STEEL	CARBON FIBER	EURO 4	SJ14 var.A ver.03	ECE/EU-Approved	4T	14187EK	
LEOVINCE	NERO	FULL SYSTEM 2/1	STAINLESS STEEL	CARBON FIBER	EURO 4	SJ14 var.A ver.03	dB(A) Compliant	4T	14043	
LEOVINCE	NERO	FULL SYSTEM 2/1	STAINLESS STEEL	CARBON FIBER	EURO 4	SJ14 var.A ver.03	ECE/EU-Approved	4T	14043K	
535 XV 535 VIRAGO		1988-2001								
GAMMA	LINEA	TIPO	MATERIALE	COPPA	STANDARD	TYPE	HOM.	2T/4T	ART.	
SILVERTAIL	K02	FULL SYSTEM	CHROMED STEEL	N/A			e-approved	4T	2201	
600 FZ6 FAZER S2/ABS (also fits 57 Kw version)		2007-2011								
GAMMA	LINEA	TIPO	MATERIALE	COPPA	STANDARD	TYPE	HOM.	2T/4T	ART.	
LEOVINCE	LV ONE	2 SLIP-ON	STAINLESS STEEL	TECHNOPOLYMER	EURO 3		e-approved	4T	8283E	
LEOVINCE	LV ONE	2 SLIP-ON	CARBON FIBER	TECHNOPOLYMER	EURO 3		e-approved	4T	8284E	
600 FZ6 S2/ABS (also fits 57 Kw version)		2007-2011								
GAMMA	LINEA	TIPO	MATERIALE	COPPA	STANDARD	TYPE	HOM.	2T/4T	ART.	
LEOVINCE	LV ONE	2 SLIP-ON	STAINLESS STEEL	TECHNOPOLYMER	EURO 3		e-approved	4T	8283E	
LEOVINCE	LV ONE	2 SLIP-ON	CARBON FIBER	TECHNOPOLYMER	EURO 3		e-approved	4T	8284E	
600 FZ6-S 600/FAZER		2004-2006								
GAMMA	LINEA	TIPO	MATERIALE	COPPA	STANDARD	TYPE	HOM.	2T/4T	ART.	
LEOVINCE	LV ONE	2 SLIP-ON	STAINLESS STEEL	TECHNOPOLYMER	EURO 3		e-approved	4T	8422E	
600 TT 600 R		1998-2005								
GAMMA	LINEA	TIPO	MATERIALE	COPPA	STANDARD	TYPE	HOM.	2T/4T	ART.	
LEOVINCE	X3	SLIP-ON	ALUMINUM	N/A			e-approved	4T	5123E	

CC.	MODELLO		ANNO							
600	TTE 600		1994-2002							
	GAMMA	LINEA	TIPO	MATERIALE	COPPA	STANDARD	TYPE	HOM.	2T/4T	ART.
	LEOVINCE	X3	SLIP-ON	ALUMINUM	N/A			e-approved	4T	5123E
600	XJ6/DIVERSION/FZ6R		2009-2015							
	GAMMA	LINEA	TIPO	MATERIALE	COPPA	STANDARD	TYPE	HOM.	2T/4T	ART.
	LEOVINCE	EXHAUST TIP	ADDITIONAL SLIP-ON STAINLESS STEEL	N/A		EURO 3		N/A	4T	8240
600	XJ6/DIVERSION/FZ6R (fits with original centre stand)		2009-2015							
	GAMMA	LINEA	TIPO	MATERIALE	COPPA	STANDARD	TYPE	HOM.	2T/4T	ART.
	LEOVINCE	UNDERBODY	FULL SYSTEM 4/2/1 STAINLESS STEEL	CARBON FIBER		EURO 3		e-approved	4T	8232
600	YZF-R6		2006-2016							
	GAMMA	LINEA	TIPO	MATERIALE	COPPA	STANDARD	TYPE	HOM.	2T/4T	ART.
	LEOVINCE	FACTORY	FULL SYSTEM 4/2/1 CARBON FIBER	CARBON FIBER		EURO 3		e-approved	4T	8482S
	LEOVINCE	FACTORY	FULL SYSTEM 4/2/1 STAINLESS STEEL	CARBON FIBER		EURO 3		e-approved	4T	8483S
600	YZF-R6		2006-2018							
	GAMMA	LINEA	TIPO	MATERIALE	COPPA	STANDARD	TYPE	HOM.	2T/4T	ART.
	LEOVINCE	LV-10	SLIP-ON	STAINLESS STEEL	STAINLESS STEEL	EURO 3/4	RJ11 - RJ15 - RJ111 - RJ27	Racing use only	4T	15215
	LEOVINCE	LV-10 BLACK	SLIP-ON	STAINLESS STEEL	STAINLESS STEEL	EURO 3/4	RJ11 - RJ15 - RJ111 - RJ27	Racing use only	4T	15215B
600	YZF-R6		2017-2018							
	GAMMA	LINEA	TIPO	MATERIALE	COPPA	STANDARD	TYPE	HOM.	2T/4T	ART.
	LEOVINCE	FACTORY S	FULL SYSTEM 4/21	STAINLESS STEEL	CARBON FIBER	EURO 4	RJ27 var.A ver.02	Racing use only	4T	14226S
	LEOVINCE	FACTORY S	FULL SYSTEM 4/21	CARBON FIBER	CARBON FIBER	EURO 4	RJ27 var.A ver.02	Racing use only	4T	14227S
	LEOVINCE	FACTORY S	SLIP-ON	STAINLESS STEEL	CARBON FIBER	EURO 4	RJ27 var.A ver.02	ECE-Approved	4T	14247S
	LEOVINCE	FACTORY S	SLIP-ON	CARBON FIBER	CARBON FIBER	EURO 4	RJ27 var.A ver.02	ECE-Approved	4T	14248S
650	XVS 650 DRAG STAR		1997-2003							
	GAMMA	LINEA	TIPO	MATERIALE	COPPA	STANDARD	TYPE	HOM.	2T/4T	ART.
	SILVERTAIL	K02	SLIP-ON	CHROMED STEEL	N/A			e-approved	4T	2209
650	XVS 650 DRAG STAR CLASSIC		1998-2003							
	GAMMA	LINEA	TIPO	MATERIALE	COPPA	STANDARD	TYPE	HOM.	2T/4T	ART.
	SILVERTAIL	K02	SLIP-ON	CHROMED STEEL	N/A			e-approved	4T	2209
660	XT 660 R/X		2004-2016							
	GAMMA	LINEA	TIPO	MATERIALE	COPPA	STANDARD	TYPE	HOM.	2T/4T	ART.
	LEOVINCE	X3	2 SLIP-ON	ALUMINUM	N/A			e-approved	4T	3968E
700	MT-07 (also fits 35Kw version)		2017-2018							
	GAMMA	LINEA	TIPO	MATERIALE	COPPA	STANDARD	TYPE	HOM.	2T/4T	ART.
	LEOVINCE	LV ONE EVO	FULL SYSTEM 2/1	STAINLESS STEEL	CARBON FIBER	EURO 4	RM17 var.A:A ver.01;03	dB(A) Compliant	4T	14251E
	LEOVINCE	LV ONE EVO	FULL SYSTEM 2/1	STAINLESS STEEL	CARBON FIBER	EURO 4	RM17 var.A:A ver.01;03	ECE/EU-Approved	4T	14251EK
	LEOVINCE	LV ONE EVO	FULL SYSTEM 2/1	CARBON FIBER	CARBON FIBER	EURO 4	RM17 var.A:A ver.01;03	dB(A) Compliant	4T	14252E
	LEOVINCE	LV ONE EVO	FULL SYSTEM 2/1	CARBON FIBER	CARBON FIBER	EURO 4	RM17 var.A:A ver.01;03	ECE/EU-Approved	4T	14252EK

CC. MODELLO		ANNO								
700 MT-07 TRACER (also fits 35Kw version)		2016-2018								
GAMMA	LINEA	TIPO	MATERIALE	COPPA	STANDARD	TYPE	HOM.	2T/4T	ART.	
LEOVINCE	LV ONE EVO	FULL SYSTEM 2/1	STAINLESS STEEL	CARBON FIBER	EURO 4	RM14 var.A. ver.01	dB(A) Compliant	4T	14251E	
LEOVINCE	LV ONE EVO	FULL SYSTEM 2/1	STAINLESS STEEL	CARBON FIBER	EURO 4	RM14 var.A. ver.01	ECE/EU-Approved	4T	14251EK	
LEOVINCE	LV ONE EVO	FULL SYSTEM 2/1	CARBON FIBER	CARBON FIBER	EURO 4	RM14 var.A. ver.01	dB(A) Compliant	4T	14252E	
LEOVINCE	LV ONE EVO	FULL SYSTEM 2/1	CARBON FIBER	CARBON FIBER	EURO 4	RM14 var.A. ver.01	ECE/EU-Approved	4T	14252EK	
700 MT-07/FZ-07/ABS		2014-2016								
GAMMA	LINEA	TIPO	MATERIALE	COPPA	STANDARD	TYPE	HOM.	2T/4T	ART.	
LEOVINCE	GP DUALS	FULL SYSTEM 2/1	STAINLESS STEEL	STAINLESS STEEL	EURO 3		dB(A) Compliant	4T	15107	
LEOVINCE	GP DUALS	FULL SYSTEM 2/1	STAINLESS STEEL	STAINLESS STEEL	EURO 3		e-approved	4T	15107K	
LEOVINCE	LV ONE EVO	FULL SYSTEM 2/1	STAINLESS STEEL	CARBON FIBER	EURO 3	RM04	e-approved	4T	14104E	
LEOVINCE	LV ONE EVO	FULL SYSTEM 2/1	CARBON FIBER	CARBON FIBER	EURO 3	RM04	e-approved	4T	14105E	
LEOVINCE	NERO	FULL SYSTEM 2/1	STAINLESS STEEL	CARBON FIBER	EURO 3	RM04	e-approved	4T	14018	
LEOVINCE	UNDERBODY	FULL SYSTEM 2/1	STAINLESS STEEL	CARBON FIBER	EURO 3	RM04	e-approved	4T	8796	
700 MT-07/FZ-07/ABS		2017-2018								
GAMMA	LINEA	TIPO	MATERIALE	COPPA	STANDARD	TYPE	HOM.	2T/4T	ART.	
LEOVINCE	GP DUALS	FULL SYSTEM 2/1	STAINLESS STEEL	STAINLESS STEEL	EURO 4		dB(A) Compliant	4T	15107	
LEOVINCE	GP DUALS	FULL SYSTEM 2/1	STAINLESS STEEL	STAINLESS STEEL	EURO 4		ECE/EU-Approved	4T	15107K	
700 XSR 700 (also fits 35Kw version)		2016-2018								
GAMMA	LINEA	TIPO	MATERIALE	COPPA	STANDARD	TYPE	HOM.	2T/4T	ART.	
LEOVINCE	LV ONE EVO	FULL SYSTEM 2/1	STAINLESS STEEL	CARBON FIBER	EURO 4	RM11 var.A. ver.01	dB(A) Compliant	4T	14251E	
LEOVINCE	LV ONE EVO	FULL SYSTEM 2/1	STAINLESS STEEL	CARBON FIBER	EURO 4	RM11 var.A. ver.01	ECE/EU-Approved	4T	14251EK	
LEOVINCE	LV ONE EVO	FULL SYSTEM 2/1	CARBON FIBER	CARBON FIBER	EURO 4	RM11 var.A. ver.01	dB(A) Compliant	4T	14252E	
LEOVINCE	LV ONE EVO	FULL SYSTEM 2/1	CARBON FIBER	CARBON FIBER	EURO 4	RM11 var.A. ver.01	ECE/EU-Approved	4T	14252EK	
700 XSR 700 ABS		2016-2018								
GAMMA	LINEA	TIPO	MATERIALE	COPPA	STANDARD	TYPE	HOM.	2T/4T	ART.	
LEOVINCE	GP DUALS	FULL SYSTEM 2/1	STAINLESS STEEL	STAINLESS STEEL	EURO 4	RM11	dB(A) Compliant	4T	15109	
LEOVINCE	GP DUALS	FULL SYSTEM 2/1	STAINLESS STEEL	STAINLESS STEEL	EURO 4	RM11	ECE/EU-Approved	4T	15109K	
LEOVINCE	UNDERBODY	FULL SYSTEM 2/1	STAINLESS STEEL	CARBON FIBER	EURO 4	RM11	e-approved	4T	14148	
700 YFM 700 R RAPTOR		2006-2012								
GAMMA	LINEA	TIPO	MATERIALE	COPPA	STANDARD	TYPE	HOM.	2T/4T	ART.	
LEOVINCE	X3	SLIP-ON	ALUMINUM	N/A		0	Not approved	4T	3894	
750 XV VIRAGO 750		1992-2000								
GAMMA	LINEA	TIPO	MATERIALE	COPPA	STANDARD	TYPE	HOM.	2T/4T	ART.	
SILVERTAIL	K02	SLIP-ON	CHROMED STEEL	N/A			e-approved	4T	2243	
779 FZ8/FAZER 8		2010-2015								
GAMMA	LINEA	TIPO	MATERIALE	COPPA	STANDARD	TYPE	HOM.	2T/4T	ART.	
LEOVINCE	LV ONE EVO	SLIP-ON	STAINLESS STEEL	CARBON FIBER	EURO 3		e*-approved	4T	8277E	
LEOVINCE	LV ONE EVO	SLIP-ON	CARBON FIBER	CARBON FIBER	EURO 3		e*-approved	4T	8278E	
900 MT-09 ABS		2017-2018								
GAMMA	LINEA	TIPO	MATERIALE	COPPA	STANDARD	TYPE	HOM.	2T/4T	ART.	
LEOVINCE	LV ONE EVO	FULL SYSTEM 3/1	STAINLESS STEEL	CARBON FIBER	EURO 4	RN43 B 01	dB(A) Compliant	4T	14228E	
LEOVINCE	LV ONE EVO	FULL SYSTEM 3/1	STAINLESS STEEL	CARBON FIBER	EURO 4	RN43 B 01	ECE/EU-Approved	4T	14228EK	
LEOVINCE	LV ONE EVO	FULL SYSTEM 3/1	CARBON FIBER	CARBON FIBER	EURO 4	RN43 B 01	dB(A) Compliant	4T	14229E	
LEOVINCE	LV ONE EVO	FULL SYSTEM 3/1	CARBON FIBER	CARBON FIBER	EURO 4	RN43 B 01	ECE/EU-Approved	4T	14229EK	



CC. MODELLO		ANNO								
900 MT-09 SP		2018-								
GAMMA	LINEA	TIPO	MATERIALE	COPPA	STANDARD	TYPE	HOM.	2T/4T	ART.	
LEOVINCE	LV ONE EVO	FULL SYSTEM 3/1	STAINLESS STEEL	CARBON FIBER	EURO 4	RN43 B 05	dB(A) Compliant	4T	14228E	
LEOVINCE	LV ONE EVO	FULL SYSTEM 3/1	STAINLESS STEEL	CARBON FIBER	EURO 4	RN43 B 05	ECE/EU-Approved	4T	14228EK	
LEOVINCE	LV ONE EVO	FULL SYSTEM 3/1	CARBON FIBER	CARBON FIBER	EURO 4	RN43 B 05	dB(A) Compliant	4T	14229E	
LEOVINCE	LV ONE EVO	FULL SYSTEM 3/1	CARBON FIBER	CARBON FIBER	EURO 4	RN43 B 05	ECE/EU-Approved	4T	14229EK	
900 MT-09 TRACER GT/FJ-09 GT (fits with original centre stand)		2018-								
GAMMA	LINEA	TIPO	MATERIALE	COPPA	STANDARD	TYPE	HOM.	2T/4T	ART.	
LEOVINCE	LV ONE EVO	FULL SYSTEM 3/1	STAINLESS STEEL	CARBON FIBER	EURO 4	RN57 C 05	dB(A) Compliant	4T	14228E	
LEOVINCE	LV ONE EVO	FULL SYSTEM 3/1	STAINLESS STEEL	CARBON FIBER	EURO 4	RN57 C 05	ECE/EU-Approved	4T	14228EK	
LEOVINCE	LV ONE EVO	FULL SYSTEM 3/1	CARBON FIBER	CARBON FIBER	EURO 4	RN57 C 05	dB(A) Compliant	4T	14229E	
LEOVINCE	LV ONE EVO	FULL SYSTEM 3/1	CARBON FIBER	CARBON FIBER	EURO 4	RN57 C 05	ECE/EU-Approved	4T	14229EK	
900 MT-09 TRACER/FJ-09 (fits also with centre stand)		2015-2016								
GAMMA	LINEA	TIPO	MATERIALE	COPPA	STANDARD	TYPE	HOM.	2T/4T	ART.	
LEOVINCE	LV ONE EVO	FULL SYSTEM 3/1	STAINLESS STEEL	CARBON FIBER	EURO 3	RN29	e-approved	4T	14102E	
LEOVINCE	LV ONE EVO	FULL SYSTEM 3/1	CARBON FIBER	CARBON FIBER	EURO 3	RN29	e-approved	4T	14103E	
900 MT-09 TRACER/FJ-09 (fits also with centre stand)		2017-2018								
GAMMA	LINEA	TIPO	MATERIALE	COPPA	STANDARD	TYPE	HOM.	2T/4T	ART.	
LEOVINCE	LV ONE EVO	FULL SYSTEM 3/1	STAINLESS STEEL	CARBON FIBER	EURO 4	RN43 C 01 - RN57 01	dB(A) Compliant	4T	14228E	
LEOVINCE	LV ONE EVO	FULL SYSTEM 3/1	STAINLESS STEEL	CARBON FIBER	EURO 4	RN43 C 01 - RN57 01	ECE/EU-Approved	4T	14228EK	
LEOVINCE	LV ONE EVO	FULL SYSTEM 3/1	CARBON FIBER	CARBON FIBER	EURO 4	RN43 C 01 - RN57 01	dB(A) Compliant	4T	14229E	
LEOVINCE	LV ONE EVO	FULL SYSTEM 3/1	CARBON FIBER	CARBON FIBER	EURO 4	RN43 C 01 - RN57 01	ECE/EU-Approved	4T	14229EK	
900 MT-09/FZ-09/ABS		2013-2016								
GAMMA	LINEA	TIPO	MATERIALE	COPPA	STANDARD	TYPE	HOM.	2T/4T	ART.	
LEOVINCE	GP DUALS	FULL SYSTEM 3/1	STAINLESS STEEL	STAINLESS STEEL	EURO 3		dB(A) Compliant	4T	15108	
LEOVINCE	GP DUALS	FULL SYSTEM 3/1	STAINLESS STEEL	STAINLESS STEEL	EURO 3		e-approved	4T	15108K	
LEOVINCE	GP DUALS	FULL SYSTEM 3/1	STAINLESS STEEL	STAINLESS STEEL	EURO 3		Racing use only	4T	15108US	
LEOVINCE	UNDERBODY	FULL SYSTEM 3/1	STAINLESS STEEL	CARBON FIBER	EURO 3	RN29	e-approved	4T	8797	
900 MT-09/FZ-09/ABS		2017-2018								
GAMMA	LINEA	TIPO	MATERIALE	COPPA	STANDARD	TYPE	HOM.	2T/4T	ART.	
LEOVINCE	GP DUALS	FULL SYSTEM 3/1	STAINLESS STEEL	STAINLESS STEEL	EURO 4		dB(A) Compliant	4T	15108	
LEOVINCE	GP DUALS	FULL SYSTEM 3/1	STAINLESS STEEL	STAINLESS STEEL	EURO 4		ECE/EU-Approved	4T	15108K	
LEOVINCE	GP DUALS	FULL SYSTEM 3/1	STAINLESS STEEL	STAINLESS STEEL	EURO 4		Racing use only	4T	15108US	
900 XSR 900 ABS		2016-2018								
GAMMA	LINEA	TIPO	MATERIALE	COPPA	STANDARD	TYPE	HOM.	2T/4T	ART.	
LEOVINCE	GP DUALS	FULL SYSTEM 3/1	STAINLESS STEEL	STAINLESS STEEL	EURO 4		dB(A) Compliant	4T	15108	
LEOVINCE	GP DUALS	FULL SYSTEM 3/1	STAINLESS STEEL	STAINLESS STEEL	EURO 4		ECE/EU-Approved	4T	15108K	
LEOVINCE	GP DUALS	FULL SYSTEM 3/1	STAINLESS STEEL	STAINLESS STEEL	EURO 4		Racing use only	4T	15108US	
LEOVINCE	LV ONE EVO	FULL SYSTEM 3/1	STAINLESS STEEL	CARBON FIBER	EURO 4	RN57 var.A:A ver.01;05	dB(A) Compliant	4T	14228E	
LEOVINCE	LV ONE EVO	FULL SYSTEM 3/1	STAINLESS STEEL	CARBON FIBER	EURO 4	RN57 var.A:A ver.01;05	ECE/EU-Approved	4T	14228EK	
LEOVINCE	LV ONE EVO	FULL SYSTEM 3/1	CARBON FIBER	CARBON FIBER	EURO 4	RN57 var.A:A ver.01;05	dB(A) Compliant	4T	14229E	
LEOVINCE	LV ONE EVO	FULL SYSTEM 3/1	CARBON FIBER	CARBON FIBER	EURO 4	RN57 var.A:A ver.01;05	ECE/EU-Approved	4T	14229EK	
LEOVINCE	UNDERBODY	FULL SYSTEM 3/1	STAINLESS STEEL	CARBON FIBER	EURO 4	RN43 A 01	e-approved	4T	14156	

CC. MODELLO		ANNO								
1000 FAZER/GT (fits with original center stand)		2006-2015								
GAMMA	LINEA	TIPO	MATERIALE	COPPA	STANDARD	TYPE	HOM.	2T/4T	ART.	
LEOVINCE	LV ONE	SLIP-ON	STAINLESS STEEL	TECHNOPOLYMER	EURO 3		e-approved	4T	8297E	
LEOVINCE	LV ONE	SLIP-ON	CARBON FIBER	TECHNOPOLYMER	EURO 3		e-approved	4T	8298E	
1000 FZ1		2006-2015								
GAMMA	LINEA	TIPO	MATERIALE	COPPA	STANDARD	TYPE	HOM.	2T/4T	ART.	
LEOVINCE	LV ONE	SLIP-ON	STAINLESS STEEL	TECHNOPOLYMER	EURO 3		e-approved	4T	8297E	
LEOVINCE	LV ONE	SLIP-ON	CARBON FIBER	TECHNOPOLYMER	EURO 3		e-approved	4T	8298E	
1000 MT-10 SP		2017-2018								
GAMMA	LINEA	TIPO	MATERIALE	COPPA	STANDARD	TYPE	HOM.	2T/4T	ART.	
LEOVINCE	FACTORY S	SLIP-ON	STAINLESS STEEL	CARBON FIBER	EURO 4	RN45	ECE-Approved	4T	14162S	
LEOVINCE	FACTORY S	SLIP-ON	CARBON FIBER	CARBON FIBER	EURO 4	RN45	ECE-Approved	4T	14163S	
LEOVINCE	LV-10	SLIP-ON	STAINLESS STEEL	STAINLESS STEEL	EURO 4		Racing use only	4T	15203	
LEOVINCE	LV-10 BLACK	SLIP-ON	STAINLESS STEEL	STAINLESS STEEL	EURO 4		Racing use only	4T	15203B	
1000 MT-10/FZ-10/MTN1000		2016-2018								
GAMMA	LINEA	TIPO	MATERIALE	COPPA	STANDARD	TYPE	HOM.	2T/4T	ART.	
LEOVINCE	FACTORY S	SLIP-ON	STAINLESS STEEL	CARBON FIBER	EURO 4	RN45	ECE-Approved	4T	14162S	
LEOVINCE	FACTORY S	SLIP-ON	CARBON FIBER	CARBON FIBER	EURO 4	RN45	ECE-Approved	4T	14163S	
LEOVINCE	LV-10	SLIP-ON	STAINLESS STEEL	STAINLESS STEEL	EURO 4		Racing use only	4T	15203	
LEOVINCE	LV-10 BLACK	SLIP-ON	STAINLESS STEEL	STAINLESS STEEL	EURO 4		Racing use only	4T	15203B	
1000 MT-10/FZ-10/MTN1000 (not compatible with Art.15203-15203B)		2016-2018								
GAMMA	LINEA	TIPO	MATERIALE	COPPA	STANDARD	TYPE	HOM.	2T/4T	ART.	
LEOVINCE	CAT ELIMINATOR (LINK PIPE)	N/A	N/A	N/A	EURO 4	RN45	Racing use only	4T	8082	
1000 XV VIRAGO 1000		1986-1988								
GAMMA	LINEA	TIPO	MATERIALE	COPPA	STANDARD	TYPE	HOM.	2T/4T	ART.	
SILVERTAIL	K02	SLIP-ON	CHROMED STEEL	N/A			e-approved	4T	2243	
1000 YZF 1000 R1		2009-2014								
GAMMA	LINEA	TIPO	MATERIALE	COPPA	STANDARD	TYPE	HOM.	2T/4T	ART.	
LEOVINCE	CAT ELIMINATOR (LINK PIPE)	N/A	N/A	N/A	EURO 3		Racing use only	4T	8036	
LEOVINCE	LV ONE EVO	2 SLIP-ON	STAINLESS STEEL	CARBON FIBER	EURO 3		e*-approved	4T	8293E	
LEOVINCE	LV ONE EVO	2 SLIP-ON	CARBON FIBER	CARBON FIBER	EURO 3		e*-approved	4T	8294E	
1000 YZF 1000 R1		2015-2016								
GAMMA	LINEA	TIPO	MATERIALE	COPPA	STANDARD	TYPE	HOM.	2T/4T	ART.	
LEOVINCE	FACTORY S	SLIP-ON	STAINLESS STEEL	CARBON FIBER	EURO 3	RN32	e*-approved	4T	14119S	
LEOVINCE	FACTORY S	SLIP-ON	CARBON FIBER	CARBON FIBER	EURO 3	RN32	e*-approved	4T	14120S	
LEOVINCE	LV-10	SLIP-ON	STAINLESS STEEL	STAINLESS STEEL	EURO 3		Racing use only	4T	15201	
LEOVINCE	LV-10 BLACK	SLIP-ON	STAINLESS STEEL	STAINLESS STEEL	EURO 3		Racing use only	4T	15201B	
1000 YZF 1000 R1		2016-2018								
GAMMA	LINEA	TIPO	MATERIALE	COPPA	STANDARD	TYPE	HOM.	2T/4T	ART.	
LEOVINCE	LV-10	SLIP-ON	STAINLESS STEEL	STAINLESS STEEL	EURO 4		Racing use only	4T	15201	
LEOVINCE	LV-10 BLACK	SLIP-ON	STAINLESS STEEL	STAINLESS STEEL	EURO 4		Racing use only	4T	15201B	

CC. MODELLO		ANNO								
1000 YZF 1000 R1 (not compatible with Art.15201-15201B)		2015-2016								
GAMMA	LINEA	TIPO	MATERIALE	COPPA	STANDARD	TYPE	HOM.	2T/4T	ART.	
LEOVINCE	CAT ELIMINATOR (LINK PIPE)	N/A	N/A	N/A	EURO 3		Racing use only	4T	8088	
1000 YZF 1000 R1/M		2017-2018								
GAMMA	LINEA	TIPO	MATERIALE	COPPA	STANDARD	TYPE	HOM.	2T/4T	ART.	
LEOVINCE	FACTORY S	SLIP-ON	STAINLESS STEEL	CARBON FIBER	EURO 4	RN49 var.A:B ver.01;01	ECE-Approved	4T	14243S	
LEOVINCE	FACTORY S	SLIP-ON	CARBON FIBER	CARBON FIBER	EURO 4	RN49 var.A:B ver.01;01	ECE-Approved	4T	14244S	
1000 YZF 1000 R1/M (not compatible with Art.15201-15201B)		2017-2018								
GAMMA	LINEA	TIPO	MATERIALE	COPPA	STANDARD	TYPE	HOM.	2T/4T	ART.	
LEOVINCE	CAT ELIMINATOR (LINK PIPE)	N/A	N/A	N/A	EURO 4		Racing use only	4T	8088	
1100 XV VIRAGO 1100		1989-1998								
GAMMA	LINEA	TIPO	MATERIALE	COPPA	STANDARD	TYPE	HOM.	2T/4T	ART.	
SILVERTAIL	K02	SLIP-ON	CHROMED STEEL	N/A			e-approved	4T	2243	
1100 XVS 1100 DRAG STAR		1999-2003								
GAMMA	LINEA	TIPO	MATERIALE	COPPA	STANDARD	TYPE	HOM.	2T/4T	ART.	
SILVERTAIL	K02	SLIP-ON	CHROMED STEEL	N/A			e-approved	4T	2244	
1200 XT 1200 Z SUPER TENERE' (fits with original panniers)		2010-2016								
GAMMA	LINEA	TIPO	MATERIALE	COPPA	STANDARD	TYPE	HOM.	2T/4T	ART.	
LEOVINCE	LV ONE EVO	SLIP-ON	STAINLESS STEEL	CARBON FIBER	EURO 3		e*-approved	4T	8275E	
1300 FJR 1300 A/AS		2001-2015								
GAMMA	LINEA	TIPO	MATERIALE	COPPA	STANDARD	TYPE	HOM.	2T/4T	ART.	
LEOVINCE	LV ONE EVO	2 SLIP-ON	STAINLESS STEEL	CARBON FIBER	EURO 1/2/3	RP23	e-approved	4T	8784E	



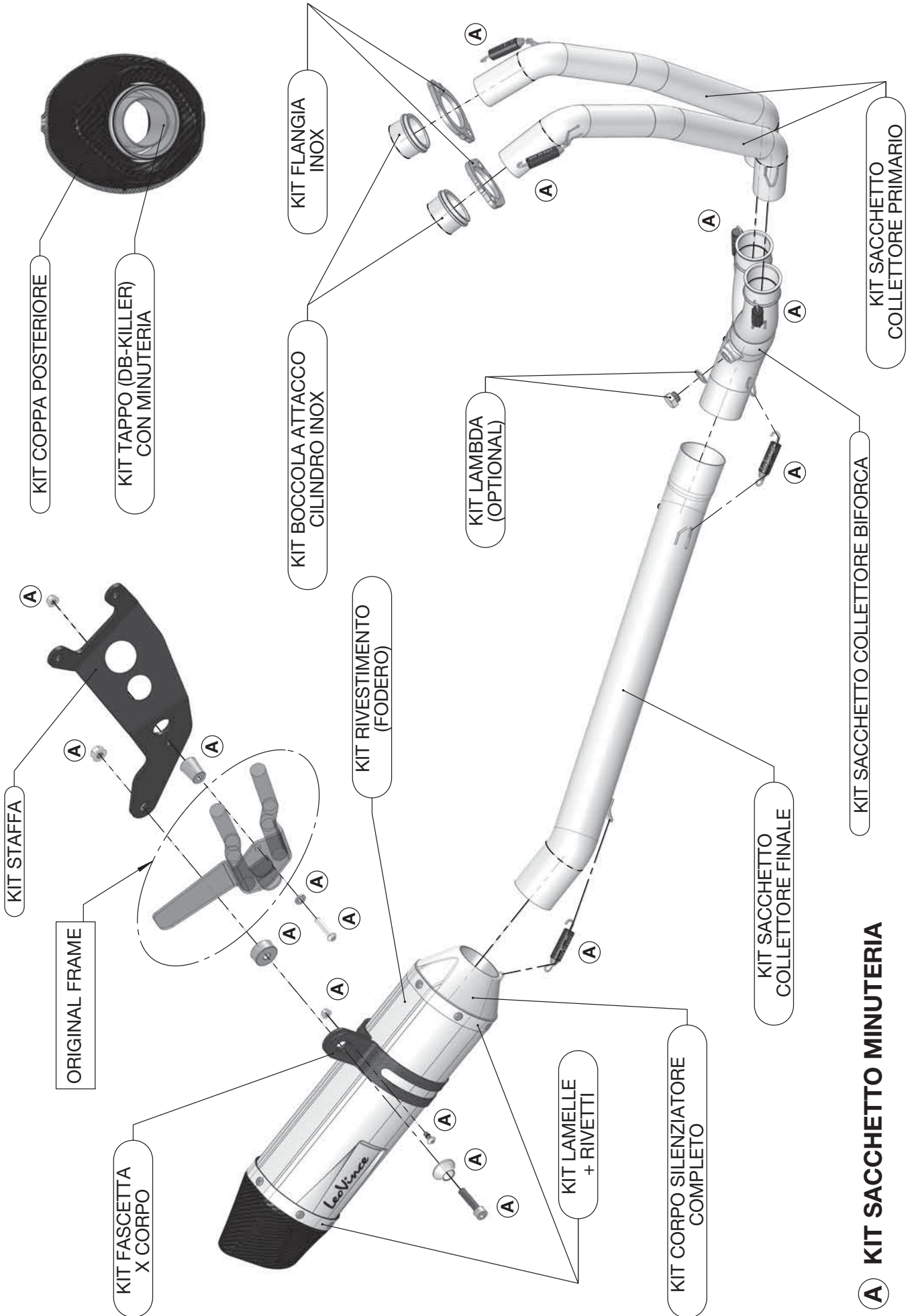

**A KIT SACCHETTO MINUTERIA**

ART.	MARCA	MODELLO		TIPOLOGIA
2201	YAMAHA	XV 535 VIRAGO	1988 - 2001	Sivertail K02 - 2 silenziatori + 2 collettori - OMOLOGATO
RICAMBI	2314	K02 - KIT RICAMBIO OMOLOGATO (PER 1 SILENZIATORE) L=515		
	2301	K02 CODA SLASH-CUT (DESTRA)		
	302228750R	CARTER CROM.DX+1 FASCETTA		
	302201780R	KIT COLLETTORI PER ART.2201		
	<b>Contiene:</b>			
	302201221	N. 1 COLLETTORE N0100 INF.	302201222	N. 1 COLLETTORE N0101 SUP.
	302201770R	KIT SILENZIATORI PER ART.2201		
	<b>Contiene:</b>			
	302201741	N. 1 SILENZIATORE INF.	302201742	N. 1 SILENZIATORE SUP.
	302201790R	KIT CARTER PER ART.2201		
	<b>Contiene:</b>			
	302201750	N. 1 CARTER N.9 CROM.LUNGO SUP.	302201753	N. 1 CARTER N.11CROM.CORTO INF.
	302201751	N. 1 CARTER N.7 CROM.CORTO SUP.	302201754	N. 1 CARTER N.8 CROM.CORTO SUP.
	302201752	N. 1 CARTER N10 CROM.LUNGO INF.		
2203	SUZUKI	VS GL 1400 INTRUDER	1987 - 2000	Sivertail K02 - 2 silenziatori - OMOLOGATO
RICAMBI	2314	K02 - KIT RICAMBIO OMOLOGATO (PER 1 SILENZIATORE) L=515		
	2301	K02 CODA SLASH-CUT (DESTRA)		
	2302	K02 CODA SLASH-CUT (SINISTRA)		
	302203790R	KIT CARTER PER ART.2203		
	<b>Contiene:</b>			
	302203750	N. 1 CARTER CROM. CORTO	302203751	N. 1 CARTER CROM. LUNGO
	302203770R	KIT SILENZIATORI PER ART.2203		
	<b>Contiene:</b>			
	302203741	N. 1 SILENZIATORE SX	302203742	N. 1 SILENZIATORE DX
	302203780R	KIT COLLETTORI PER ART.2203		
	<b>Contiene:</b>			
	302203221	N. 1 COLLETTORE N0109 DX	302203222	N. 1 COLLETTORE N0110 SX
	302203601R	SACCH. MINUTERIA SUZ. 1400 INTRUDER		
	<b>Contiene:</b>			
	082203005	N. 1 STAFFA X SILENZ. DX	201002	N. 2 BRUGOLA M8X35 T.C.E.I. INOX
	082203006	N. 1 STAFFA X SILENZ. SX	201171	N. 6 RONDELLA 8X17 PIANA INOX
	200610	N. 4 FASCETTA 30-50 INOX	300038525	N. 1 FASCETTA 38 CROMATA
	200774	N. 4 BULLONE 8X12 T.E.INOX	300043525	N. 2 FASCETTA 43 CROMATA
	200931	N. 2 RONDELLA 8X24 PIANA INOX	300045525	N. 2 FASCETTA 45 CROMATA
	200990	N. 2 DADO 8 FLANGIATO ZIGR. INOX		
2207	KAWASAKI	VN 800 CLASSIC	1996 - 2006	Sivertail K02 - 2 silenziatori + 2 collettori - OMOLOGATO
RICAMBI	2314	K02 - KIT RICAMBIO OMOLOGATO (PER 1 SILENZIATORE) L=515		
	2301	K02 CODA SLASH-CUT (DESTRA)		
	302228750R	CARTER CROM.DX+1 FASCETTA 2228		
	<b>Contiene:</b>			
	302228501	N. 2 CARTER PARAC.CON FASCETTA		
	302207780R	KIT COLLETTORI PER ART.2207		
	<b>Contiene:</b>			
	302207221	N. 1 COLLETTORE N0104 INF.	302207222	N. 1 COLLETTORE N0105 SUP.
	302207770R	KIT SILENZIATORI PER ART.2207		
	<b>Contiene:</b>			
	302207741	N. 1 SILENZIATORE SUP.CORTO L.435	302207742	N. 1 SILENZIATORE INF.LUNGO L.515
	302207601R	SACCH. MINUTERIA KAW. VN 800 CLASSIC		
	<b>Contiene:</b>			
	201118	N. 3 BRUGOLA M8X25 T.C.E.I. INOX	201171	N. 3 RONDELLA 8X17 PIANA INOX
2209	YAMAHA	XVS 650 DRAG STAR	1997 - 2002	Sivertail K02 - 2 silenziatori + 1 COLLETTORE - OMOLOGATO
	YAMAHA	XVS 650 DRAG STAR CLASSIC	1998 - 2002	
RICAMBI	2314	K02 - KIT RICAMBIO OMOLOGATO (PER 1 SILENZIATORE) L=515		

ART.	MARCA	MODELLO	TIPOLOGIA
		2301 K02 CODA SLASH-CUT (DESTRA)	
		302228750R CARTER CROM.DX+1 FASCETTA 2228	
		<b>Contiene:</b>	
		302228501 N. 2 CARTER PARAC.CON FASCETTA	
		302209780R KIT COLLETTORE PER ART.2209	
		<b>Contiene:</b>	
		302209221 N. 1 COLLETTORE N0106 COMP.	
		302209770R KIT SILENZIATORI PER ART.2209	
		<b>Contiene:</b>	
		302209741 N. 1 SILENZIATORE INF. 302209902	302209742 N. 1 SILENZIATORE SUP. 302209903
		302209790R KIT CARTER COLLETTORI PER ART.2209	
		<b>Contiene:</b>	
		302209750 N. 1 CARTER CROM. DIRITTO	302209751 N. 1 CARTER CROM.PIEGATO
		302209601R SACCH. MINUTERIA YAM. XVS DRAG STAR	
		<b>Contiene:</b>	
		082209016 N. 1 STAFFA IN FERRO SIL.INF.	200873 N. 2 RONDELLA 10 PIANA INOX
		082209037 N. 1 STAFFA FE SUP.	201118 N. 2 BRUGOLA M8X25 T.C.E.I. INOX
		200506 N. 1 BOCCOLA 35X28,75X30 LGR/F D.032/99	201171 N. 4 RONDELLA 8X17 PIANA INOX
		200610 N. 3 FASCETTA 30-50 INOX	203529 N. 2 BOCCOLA 40X35X30 LGR/F DIS.133/03
		200621 N. 1 FASCETTA 25-40 INOX	300038525 N. 1 FASCETTA 38 CROMATA
		200774 N. 4 BULLONE 8X12 T.E.INOX	
<b>2212</b>	HONDA	VT 750 C2 ACE SHADOW	1997 - 2001 Sivertail K02 - 2 silenzianti + 2 collettori - OMOLOGATO
RICAMBI		2314 K02 - KIT RICAMBIO OMOLOGATO (PER 1 SILENZIATORE) L=515	
		2301 K02 CODA SLASH-CUT (DESTRA)	
		302212780R KIT COLLETTORI PER ART.2212	
		<b>Contiene:</b>	
		302212221 N. 1 COLLETTORE N0102 INF.	302212222 N. 1 COLLETTORE N0103 SUP.
		302212770R KIT 2 SILENZIATORI PER ART.2212	
		<b>Contiene:</b>	
		302212741 N. 1 SILENZIATORE INF.	302212742 N. 1 SILENZIATORE SUP.
		302212790R KIT CARTER PER ART.2212	
		<b>Contiene:</b>	
		302212750 N. 1 CARTER CROM.PIEGATO SUP.	302212752 N. 1 CARTER CROM. DIR. INF. LUNGO
		302212751 N. 1 CARTER CROM.DIR.SUP.CORTO	302212753 N. 1 CARTER CROM. PIEGATO INF.
		302212601R SACCH. MINUTERIA HONDA VT 750	
		<b>Contiene:</b>	
		200610 N. 8 FASCETTA 30-50 INOX	201171 N. 2 RONDELLA 8X17 PIANA INOX
		200931 N. 2 RONDELLA 8X24 PIANA INOX	202421 N. 2 BRUGOLA M8X16 T.C.E.I. INOX
		200990 N. 2 DADO 8 FLANGIATO ZIGR. INOX	300043525 N. 2 FASCETTA 43 CROMATA
<b>2226</b>	SUZUKI	LS 650 SAVAGE	1986 - 1997 Sivertail K02 - 1 silenziatore - OMOLOGATO
RICAMBI		2315 K02 - KIT RICAMBIO OMOLOGATO (PER 1 SILENZIATORE) L=435	
		2301 K02 CODA SLASH-CUT (DESTRA)	
		302226790R KIT CARTER PER ART.2226	
		<b>Contiene:</b>	
		302226750 N. 1 CARTER CROM.CORTO	
		302226770R KIT SILENZIATORE PER ART.2226	
		<b>Contiene:</b>	
		302226741 N. 1 SILENZIATORE CROMATO	
		302226780R KIT COLLETTORE PER ART.2226	
		<b>Contiene:</b>	
		302226221 N. 1 COLLETTORE N0107	
		302226601R SACCH. MINUTERIA SUZ. LS 650 SAVAGE	
		<b>Contiene:</b>	
		200610 N. 2 FASCETTA 30-50 INOX	300043525 N. 1 FASCETTA 43 CROMATA
		200931 N. 2 RONDELLA 8X24 PIANA INOX	300045525 N. 1 FASCETTA 45 CROMATA
		204875 N. 2 BULLONE 8X20 T.E.INOX	

ART.	MARCA	MODELLO	TIPOLOGIA			
2228	HONDA	VT 600 C SHADOW	1988 - 2000	Sivertail	K02 - 2 silenziatori + 2 collettori - OMOLOGATO	
RICAMBI	2314	K02 - KIT RICAMBIO OMOLOGATO (PER 1 SILENZIATORE) L=515				
	2301	K02 CODA SLASH-CUT (DESTRA)				
	302228750R	CARTER CROM.DX+1 FASCETTA 2228				
	<b>Contiene:</b>					
	302228501	N. 2	CARTER PARAC. CON FASCETTA			
	302228790R	KIT CARTER COLLETTORI PER ART.2228				
	<b>Contiene:</b>					
	302228751	N. 1	CARTER CROM. ANTERIORE	302228752	N. 1	CARTER CROM. POSTERIORE
	302228770R	KIT SILENZIATORI PER ART.2228				
	<b>Contiene:</b>					
	302228741	N. 1	SILENZIATORE SUPERIORE 302228901	302228742	N. 1	SILENZIATORE INFERIORE 302228902
	302228780R	KIT COLLETTORI PER ART.2228				
	<b>Contiene:</b>					
	302228221	N. 1	COLLETTORE N0111 INF.	302228222	N. 1	COLLETTORE N0112 SUP.
	302228601R	SACCH. MINUTERIA HONDA VT 600 C				
	<b>Contiene:</b>					
	200610	N. 4	FASCETTA 30-50 INOX	203529	N. 2	BOCCOLA 40X35X30 LGR/F
	200990	N. 1	DADO 8 FLANGIATO ZIGR. INOX	204874	N. 6	BULLONE 8X16 T.E.INOX
	201171	N. 6	RONDELLA 8X17 PIANA INOX	302228511	N. 1	STAFFA X CORPO INF.
2238	HONDA	VT 125 C SHADOW	1999 - 2003	Sivertail	K02 - 2 silenziatori + 2 collettori - OMOLOGATO	
RICAMBI	2314	K02 - KIT RICAMBIO OMOLOGATO (PER 1 SILENZIATORE) L=515				
	2301	K02 CODA SLASH-CUT (DESTRA)				
	302228750R	CARTER CROM.DX+1 FASCETTA 2228				
	<b>Contiene:</b>					
	302228501	N. 2	CARTER PARAC. CON FASCETTA			
	302238770R	KIT SILENZIATORI PER ART.2238				
	<b>Contiene:</b>					
	302238741	N. 1	SILENZIATORE INF. L.435 302238901	302238742	N. 1	SILENZIATORE SUP. L.435 302238902
	302238780R	KIT COLLETTORI PER ART.2238				
	<b>Contiene:</b>					
	302238221	N. 1	COLLETTORE 0218 ANT.	302238222	N. 1	COLLETTORE 219 POST.
	302238601R	SACCH. MINUTERIA HONDA VT 125 SHADOW				
	<b>Contiene:</b>					
	082238001	N. 1	STAFFA	201171	N. 6	RONDELLA 8X17 PIANA INOX
	082258003	N. 1	STAFFA GIUNZ.FE DX	203529	N. 2	BOCCOLA 40X35X30 LGR/F
	200774	N. 6	BULLONE 8X12 T.E.INOX			
2243	YAMAHA	XV 750 VIRAGO	1992 - 2000	Sivertail	K02 - 2 silenziatori - OMOLOGATO	
	YAMAHA	XV 1000 VIRAGO	1986 - 1988			
	YAMAHA	XV 1100 VIRAGO	1989 - 1998			
RICAMBI	2314	K02 - KIT RICAMBIO OMOLOGATO (PER 1 SILENZIATORE) L=515				
	2301	K02 CODA SLASH-CUT (DESTRA)				
	302228750R	CARTER CROM.DX+1 FASCETTA 2228				
	<b>Contiene:</b>					
	302228501	N. 2	CARTER PARAC. CON FASCETTA			
	302243790R	KIT CARTER COLLETTORI PER ART.2243				
	<b>Contiene:</b>					
	302243750	N. 1	CARTER CROM. INF.CORTO	302243751	N. 1	CARTER CROM.SUP.LUNGO
	302243770R	KIT SILENZIATORI PER ART.2243				
	<b>Contiene:</b>					
	302243741	N. 1	SILENZIATORE INF.CORTO L=435	302243742	N. 1	SILENZIATORE SUP.LUNGO L=515
	302243780R	KIT COLLETTORI PER ART.2243				
	<b>Contiene:</b>					
	302243221	N. 1	COLLETTORE N192 ANT.	302243222	N. 1	COLLETTORE N193 POST.



ART.	MARCA	MODELLO			TIPOLOGIA
		302243601R SACCH. MINUTERIA YAM.XV 750 VIRAGO			
		<b>Contiene:</b>			
		082243001 N. 1 STAFFA FE SUP.	200990 N. 1		DADO 8 FLANGIATO ZIGR. INOX
		082243002 N. 1 STAFFA FE INF.	201171 N. 6		RONDELLA 8X17 PIANA INOX
		200267 N. 1 TAPPO PEDUNC.CONICO 4T	203529 N. 1		BOCCOLA 40X35X30 LGR/F
		200415 N. 1 PL. DISTANZIALE 20X5X8,5 ALL.	300043525 N. 1		FASCETTA 43 CROMATA
		200610 N. 4 FASCETTA 30-50 INOX	300045525 N. 1		FASCETTA 45 FERRO CROMATA
		200774 N. 6 BULLONE 8X12 T.E.INOX	302243501 N. 1		STAFFA SALD. PER CAVALLETT
<b>2244</b>	YAMAHA	XVS 1100 DRAG STAR	1999 - 2002	Sivertail	K02 - 2 silenziatori + 1 COLLETTORE - OMOLOGATO
RICAMBI		2314 K02 - KIT RICAMBIO OMOLOGATO (PER 1 SILENZIATORE) L=515			
		2301 K02 CODA SLASH-CUT (DESTRA)			
		302228750R CARTER CROM.DX+1 FASCETTA 2228			
		<b>Contiene:</b>			
		302228501 N. 2 CARTER PARAC. CON FASCETTA			
		302244790R KIT CARTER COLLETTORI PER ART.2244			
		<b>Contiene:</b>			
		302244750 N. 1 CARTER CROM. CORTO	302244751 N. 1		CARTER CROM. LUNGO
		302244770R KIT SILENZIATORI PER ART.2244			
		<b>Contiene:</b>			
		302244741 N. 1 SILENZIATORE SUPERIORE	302244742 N. 1		SILENZIATORE INFERIORE
		302244780R KIT COLLETTORI PER ART.2244			
		<b>Contiene:</b>			
		302244221 N. 1 COLLETTORE N145 INF.	302244222 N. 1		COLLETTORE N146 SUP.
		302244601R SACCH. MINUTERIA YAMAHA XVS 1000			
		<b>Contiene:</b>			
		082244007 N. 1 STAFFA IN FERRO SUP.	201171 N. 4		RONDELLA 8X17 PIANA INOX
		082244008 N. 1 STAFFA FE X YAMAHA XVS 1100	203529 N. 2		BOCCOLA 40X35X30 LGR/F
		200610 N. 2 FASCETTA 30-50 INOX	300035525 N. 1		FASCETTA 35 CROMATA
		200774 N. 4 BULLONE 8X12 T.E.INOX	300038525 N. 1		FASCETTA 38 CROMATA
		200873 N. 2 RONDELLA 10 PIANA INOX			
<b>2286</b>	KAWASAKI	VN 1500 CLASSIC	1996 - 1999	Sivertail	K02 - 2 silenziatori + 2 collettori - OMOLOGATO
	KAWASAKI	VN 1600 CLASSIC	2003 - 2005		
RICAMBI		2314 K02 - KIT RICAMBIO OMOLOGATO (PER 1 SILENZIATORE) L=515			
		2301 K02 CODA SLASH-CUT (DESTRA)			
		302228750R CARTER CROM.DX+1 FASCETTA 2228			
		<b>Contiene:</b>			
		302228501 N. 2 CARTER PARAC.CON FASCETTA			
		302283790R KIT CARTER COLLETTORI CROMATI PER ART.2286			
		<b>Contiene:</b>			
		302283750 N. 1 CARTER CROM. ANTER. LUNG	302283752 N. 1		CARTER CROM. POST.CORTO
		302283751 N. 1 CARTER CROM. COMPENSATORE			
		302283770R KIT SILENZIATORI PER ART.2286			
		<b>Contiene:</b>			
		302283741 N. 1 SILENZIATORE SUPERIORE L.515-2281 302283901	302283742 N. 1		SILENZIAT INFERIORE L.515 302283902
		302283780R KIT COLLETTORI PER ART.2286			
		<b>Contiene:</b>			
		302283201 N. 1 COLLETTORE N 291 ANTERIORE	302283204 N. 1		COLLETTORE N 404 COMPENSATORE
		302283203 N. 1 COLLETTORE N 293 POSTERIORE			
		302286601R SACCH. MINUTERIA KAW. VN 1500			
		<b>Contiene:</b>			
		082283001 N. 1 STAFFA FE INF. VN 1500 CLASSIC	200774 N. 4		BULLONE 8X12 T.E.INOX
		200610 N. 5 FASCETTA 30-50 INOX	201171 N. 6		RONDELLA 8X17 PIANA INOX
		200621 N. 2 FASCETTA 25-40 INOX	204874 N. 2		BULLONE 8X16 T.E.INOX
<b>2401</b>	SUZUKI	VL INTRUDER C 800 i.e.	2006 - 2012	Sivertail	K02 - 2 silenziatori + 2 collettori - OMOLOGATO
	SUZUKI	VZ INTRUDER M 800 i.e.	2005 - 2012		

ART.	MARCA	MODELLO	TIPOLOGIA			
	SUZUKI	VL 800 INTRUDER VOLUSIA	2001 - 2005			
RICAMBI	2314	K02 - KIT RICAMBIO OMOLOGATO (PER 1 SILENZIATORE) L=515				
	2301	K02 CODA SLASH-CUT (DESTRA)				
	302228750R	CARTER CROM.DX+1 FASCETTA 2228				
	<b>Contiene:</b>					
	302228501	N. 2 CARTER PARAC.CON FASCETTA				
	302401790R	KIT CARTER COLLETTORI CROMATI PER ART.2401				
	<b>Contiene:</b>					
	302401751	N. 1 CARTER CROM. ANTERIORE LUNGO	302401752	N. 1	CARTER CROM. POSTERIORE LUNGO	
	302401770R	KIT SILENZIATORI PER ART.2401				
	<b>Contiene:</b>					
	302401741	N. 1 SILENZIATORE INF. 302401901	302401742	N. 1	SILENZIATORE SUP. 302401902	
	302401780R	KIT COLLETTORI PER ART.2401				
	<b>Contiene:</b>					
	302401221	N. 1 COLLETTORE N°402 ANT.	302401222	N. 1	COLLETTORE N°403 POST.	
	302401601R	SACCH. MINUTERIA VL 800 INTRUDER				
	<b>Contiene:</b>					
	082401001	N. 1 STAFFA FE SUZ.INTRUDER 800M	201041	N. 2	BRUGOLA M8X45 T.C.E.I. INOX	
	082401002	N. 1 STAFFA FE X SUZ.INTRUDER 800M	201171	N. 4	RONDELLA 8X17 PIANA INOX	
	200610	N. 5 FASCETTA 30-50 INOX	204091	N. 2	GUARNIZIONE 17,85X12,3X1,5AL	
	200774	N. 4 BULLONE 8X12 T.E.INOX	205123	N. 2	TAPPO M12X1.25X9 INOX	
	200931	N. 2 RONDELLA 8X24 PIANA INOX	300028525	N. 1	FASCETTA 28 CROMATA	
	200990	N. 2 DADO 8 FLANGIATO ZIGR. INOX				
<b>2404</b>	KAWASAKI	VN 900 CLASSIC i.e.	<b>2006 - 2016</b>	<b>Sivertail</b>	K02 - 2 silenziautori + 2 collettori - OMOLOGATO	
	KAWASAKI	VN 900 CUSTOM i.e.	2007 - 2016			
RICAMBI	2314	K02 - KIT RICAMBIO OMOLOGATO (PER 1 SILENZIATORE) L=515				
	2301	K02 CODA SLASH-CUT (DESTRA)				
	302228750R	CARTER CROM.DX+1 FASCETTA 2228				
	<b>Contiene:</b>					
	302228501	N. 2 CARTER PARAC.CON FASCETTA				
	302404790R	KIT CARTER COLLETTORI CROMATI PER ART.2404				
	<b>Contiene:</b>					
	302404751	N. 1 CARTER CROM. ANTERIORE 302404001	302404752	N. 1	CARTER CROM. POST. SUP. 302404002	
	302404770R	KIT SILENZIATORI PER ART.2404				
	<b>Contiene:</b>					
	302404741	N. 1 SILENZIATORE ANT.INF.	302404742	N. 1	SILENZIATORE POST.SUP.	
	302404780R	KIT COLLETTORI PER ART.2404				
	<b>Contiene:</b>					
	302404221	N. 1 COLLETTORE N°536 ANT. 302404201	302404222	N. 1	COLLETTORE N°537 ANT. 302404202	
	302404601R	SACCH. MINUTERIA KAWASAKI VN 900				
	<b>Contiene:</b>					
	082404001	N. 1 STAFFA FE X KAWA EN 500	201171	N. 4	RONDELLA 8X17 PIANA INOX	
	200412	N. 2 PL DISTANZIALE 20X18X10,5 AL.	201287	N. 1	BRUGOLA M8X40 T.C.E.I. INOX	
	200610	N. 5 FASCETTA 30-50 INOX	202421	N. 1	BRUGOLA M8X16 T.C.E.I. INOX	
	200774	N. 2 BULLONE 8X12 T.E. INOX	204091	N. 2	GUARNIZIONE 17,85X12,3X1,5AL	
	200873	N. 1 RONDELLA 10 PIANA INOX	204109	N. 1	BRUGOLA M10X40X1.25 Z.B.	
	200990	N. 1 DADO 8 FLANGIATO ZIGR. INOX	205123	N. 2	TAPPO M12X1.25X9 INOX D.156/11	
<b>2418</b>	HYOSUNG	AQUILA GV 650 carb.	<b>2005 - 2007</b>	<b>Sivertail</b>	K02 - 2 silenziautori + 2 collettori - OMOLOGATO	
	HYOSUNG	AQUILA GV 650 i.e.	2008 - 2011			
RICAMBI	2314	K02 - KIT RICAMBIO OMOLOGATO (PER 1 SILENZIATORE) L=515				
	2301	K02 CODA SLASH-CUT (DESTRA)				
	302228750R	KIT 2 CARTER CROM.DX+1 FASCETTA				
	<b>Contiene:</b>					
	302228501	N. 2 CARTER PARAC. CON FASCETTA				

ART.	MARCA	MODELLO	TIPOLOGIA		
		<b>302418790R KIT CARTER COLLETTORI CROMATI PER ART.2418</b>			
		<b>Contiene:</b>			
		302418750 N. 1 CARTER CROM.ANT. / INF.	302418751 N.	1	CARTER CROM.POSTER. / SUP.
		<b>302418770R KIT SILENZIATORI PER ART.2418</b>			
		<b>Contiene:</b>			
		302418741 N. 1 SILENZIATORE INF.1 STAFFA 302418901	302418742 N.	1	SILENZIATORE SUP. 302418902
		<b>302418780R KIT COLLETTORI PER ART.2418</b>			
		<b>Contiene:</b>			
		302418201 N. 1 COLLETTORE 840 ANT.	302418202 N.	1	COLLETTORE 841 POST.
		<b>302418601R SACCH. MINUTERIA HYOSUNG AQUILA 650</b>			
		<b>Contiene:</b>			
		082418001 N. 1 STAFFA FERRO AQUILA GV 650	202185 N.	1	GUARNIZIONE 23,85X18,3X1,5 AL
		200610 N. 4 FASCETTA 30-50 INOX	204874 N.	2	BULLONE 8X16 T.E.INOX
		200774 N. 4 BULLONE 8X12 T.E.INOX	204888 N.	1	BULLONE M18X9 INOX
		201171 N. 6 RONDELLA 8X17 PIANA INOX			
<b>2425</b>	HYOSUNG	<b>AQUILA GV 125</b>	<b>2008 - 2015</b>	<b>Sivertail</b>	<b>K02 - 2 silenziatori + 2 collettori - OMOLOGATO</b>
	HYOSUNG	<b>AQUILA GV 250 i.e.</b>	<b>2008 - 2015</b>		
<b>RICAMBI</b>		<b>2314 K02 - KIT RICAMBIO OMOLOGATO (PER 1 SILENZIATORE) L=515</b>			
		<b>2301 K02 CODA SLASH-CUT (DESTRA)</b>			
		<b>302228750R KIT 2 CARTER CROM.DX+1 FASCETTA</b>			
		<b>Contiene:</b>			
		302228501 N. 2 CARTER PARAC.CON FASCETTA			
		<b>302425770R KIT SILENZIATORI PER ART.2425</b>			
		<b>Contiene:</b>			
		302425741 N. 1 SILENZIATORE INF. 302425901	302425742 N.	1	SILENZIATORE SUP. 302425902
		<b>302425780R KIT COLLETTORI PER ART.2425</b>			
		<b>Contiene:</b>			
		302425221 N. 1 COLLETTORE N°939 INF.	302425222 N.	1	COLLETTORE N° 940 SUP.
		<b>302425601R SACCH. MINUTERIA HIOSUNG AQUILA 125</b>			
		<b>Contiene:</b>			
		82425001 N. 1 STAFFA FERRO AQUILA GV 250	202421 N.	4	BRUGOLA M8X16 T.C.E.I. INOX
		200774 N. 2 BULLONE 8X12 T.E.INOX	203529 N.	2	BOCCOLA 40X35X30 LGR/F
		201171 N. 6 RONDELLA 8X17 PIANA INOX	204888 N.	1	BULLONE M18X9 INOX
		202185 N. 1 GUARNIZIONE 23,85X18,3X1,5	300028525 N.	1	FASCETTA 28 FERRO CROMATA
<b>3204</b>	VESPA	<b>GTS 250 i.e.</b>	<b>2005 - 2013</b>	<b>Leovince</b>	<b>GRANTURISMO</b>
	VESPA	<b>GTV 250 i.e.</b>	<b>2006 - 2013</b>		
	VESPA	<b>GTV 250 NAVY i.e.</b>	<b>2008</b>		
	VESPA	<b>GTS 300 Super i.e.</b>	<b>2008 - 2015</b>		
	VESPA	<b>GTS 300 Supersport i.e.</b>	<b>2010 - 2015</b>		
	VESPA	<b>GTV 300 i.e. VIA MONTENAPOLEONE</b>	<b>2010 - 2013</b>		
<b>RICAMBI</b>		<b>5608D49 FASCETTA Ø 49 INOX (300049533)</b>			
		<b>205984R BOCCOLA IN GRAFITE LGR/F Øe.46 Øi.40 h30</b>			
		<b>303428471R SILENZIATORE GT STAFFA ARRETRATA</b>			
		<b>303204201R COLLETTORE GT N° 954</b>			
		<b>303204601R SACCH. MINUTERIA 3204</b>			
		<b>Contiene:</b>			
		200321 N. 6 PL-RONDELLA 8X24 PIANA Z.B.	202491 N.	2	BRUGOLA M8X30 T.C.E.I. Z.B.
		200361 N. 6 RONDELLA 8X14 GROWER Z.B.	203335 N.	3	BULLONE 8X30 Z.B.
		200414 N. 2 PL DISTANZIALE 20X10X8,5	203532 N.	1	BOCCOLA 40X32X30 LGR/F
		200722 N. 1 BRUGOLA M8X20 T.C.Z.B.	303226502 N.	1	STAFFA INOX
<b>3206</b>	KYMCO	<b>DINK 300 STREET i.e.</b>	<b>2009 - 2016</b>	<b>Leovince</b>	<b>GRANTURISMO</b>
	KYMCO	<b>DOWNTOWN 300 i.e.</b>	<b>2009 - 2016</b>		
	KYMCO	<b>SUPERDINK 300 i.e.</b>	<b>2009 - 2016</b>		
	KAWASAKI	<b>J300 i.e.</b>	<b>2014 - 2016</b>		
<b>RICAMBI</b>		<b>5608D49 FASCETTA Ø 49 INOX (300049533)</b>			
		<b>205984R BOCCOLA IN GRAFITE LGR/F Øe.46 Øi.40 h30</b>			
		<b>303428471R SILENZIATORE GT STAFFA ARRETRATA</b>			

ART.	MARCA	MODELLO	TIPOLOGIA		
303419201R		COLLETTORE 4-ROAD SALD N° 806			
303419601R		SACCH. MINUTERIA 3419C			
<b>Contiene:</b>					
200321	N.	3 PL-RONDELLA 8X24 PIANA Z.B.	204089	N.	3 VITE M10X25 PASSO 1.25 T.E.Z.B
200361	N.	3 RONDELLA 8X14 GROWER Z.B.	204091	N.	1 GUARNIZIONE 17,85X12,3X1,5AL
203335	N.	3 BULLONE 8X30 Z.B.	205123	N.	1 TAPPO M12X1.25X9 INOX D.156/11
203518	N.	3 RONDELLA 10X20 PIANA Z.B.	303419502	N.	1 STAFFA INOX SALD E PULIT 3419
<b>3208</b>	HONDA	SH 125 i.e.	2005 - 2012	Leovince	GRANTURISMO
	HONDA	PS 125 i.e.	2006 - 2011		
	HONDA	SH 150 i.e.	2005 - 2012		
	HONDA	PS 150 i.e.	2006 - 2011		
<b>RICAMBI</b>	5608D49	FASCETTA Ø 49 INOX (300049533)			
	205984R	BOCCOLA IN GRAFITE LGR/F Øe.46 Øi.40 h30			
	303491471R	SILENZIATORE GT STAFFA AVANZATA			
	307419201R	COLLETTORE 4 ROAD N°577			
	303208601R	SACCH. MINUTERIA 3208			
<b>Contiene:</b>					
200267	N.	1 TAPPO PEDUNC.CONICO 4T	202185	N.	1 GUARNIZIONE 23,85X18,3X1,5 AL
200294	N.	2 PL-RONDELLA 8X17 PIANA Z.B.	203335	N.	3 BULLONE 8X30 Z.B.
200298	N.	2 DADO 8 FLANGIATO Z.B.ZIGRINATO	203518	N.	3 RONDELLA 10X20 PIANA Z.B.
200321	N.	3 PL-RONDELLA 8X24 PIANA Z.B.	204089	N.	3 VITE M10X25 PASSO 1.25 T.E.Z.B
200360	N.	2 BRUGOLA M8X16 T.C.Z.B.	204888	N.	1 BULLONE M18X9 INOX
200361	N.	3 RONDELLA 8X14 GROWER Z.B.	303208502	N.	1 STAFFA INOX
201525	N.	1 GUARNIZIONE 33X26,15X4 SPIR.	304108503	N.	1 STAFFA CAVALL.
<b>3210</b>	KYMCO	XCITING 500	2005 - 2006	Leovince	GRANTURISMO
	KYMCO	XCITING 500 i.e.	2007 - 2014		
<b>RICAMBI</b>	5608D49	FASCETTA Ø 49 INOX (300049533)			
	205984R	BOCCOLA IN GRAFITE LGR/F Øe.46 Øi.40 h30			
	303428471R	SILENZIATORE GT STAFFA ARRETRATA			
	307427201R	COLLETTORE 4 ROAD N°580			
	307427601R	SACCH. MINUTERIA 7427			
<b>Contiene:</b>					
200321	N.	3 PL-RONDELLA 8X24 PIANA Z.B.	204091	N.	1 GUARNIZIONE 17,85X12,3X1,5AL
200361	N.	3 RONDELLA 8X14 GROWER Z.B.	205123	N.	1 TAPPO M12X1.25X9 INOX
203335	N.	3 BULLONE 8X30 Z.B.	307427502	N.	1 STAFFA INOX
203518	N.	3 RONDELLA 10X20 PIANA Z.B.	406393	N.	3 VITE M10X1.25X30
<b>3226</b>	VESPA	GRANTURISMO 125	2006 - 2007	Leovince	GRANTURISMO
	VESPA	GT 125	2003 - 2007		
	VESPA	200 GT	2003 - 2007		
<b>RICAMBI</b>	5608D49	FASCETTA Ø 49 INOX (300049533)			
	205984R	BOCCOLA IN GRAFITE LGR/F Øe.46 Øi.40 h30			
	303428471R	SILENZIATORE GT STAFFA ARRETRATA			
	303226201R	COLLETTORE N°977 VESPA GT 200			
	303226601R	SACCH. MINUTERIA 3226 GT			
<b>Contiene:</b>					
200321	N.	6 PL-RONDELLA 8X24 PIANA Z.B.	202491	N.	2 BRUGOLA M8X30 T.C.E.I. Z.B.
200361	N.	6 RONDELLA 8X14 GROWER Z.B.	203335	N.	3 BULLONE 8X30 Z.B.
200414	N.	2 PL DISTANZIALE 20X10X8,5 ALL.	303226502	N.	1 STAFFA INOX
200722	N.	1 BRUGOLA M8X20 T.C.Z.B.			
<b>3227</b>	SUZUKI	UH 125 BURGMAN	2002 - 2006	Leovince	GRANTURISMO
	SUZUKI	UH 150 BURGMAN	2002 - 2006		
<b>RICAMBI</b>	5608D49	FASCETTA Ø 49 INOX (300049533)			
	205984R	BOCCOLA IN GRAFITE LGR/F Øe.46 Øi.40 h30			
	303491471R	SILENZIATORE GT STAFFA AVANZATA			
	303227201R	COLLETTORE N°976 BURGMAN 150			
	303227601R	SACCH. MINUTERIA 3227 GT			
<b>Contiene:</b>					
200321	N.	3 PL-RONDELLA 8X24 PIANA Z.B.	203335	N.	3 BULLONE 8X30 Z.B.
200349	N.	1 RONDELLA 10 GROWER Z.B.	203518	N.	1 RONDELLA 10X20 PIANA Z.B.

ART.	MARCA	MODELLO	TIPOLOGIA
		200361 N. 3 RONDELLA 8X14 GROWER Z.B.	204482 N. 1 BRUGOLA M10X1.25x60 T.C.Z.B.
		200589 N. 2 BULLONE 8X40 T.E.FLANGIATO Z.B	303227502 N. 1 STAFFA INOX SALD E PULIT 3227
<b>3228</b>	DERBI	DRD SM 50 - DRD R 50	2003 Leovince HAND MADE "X-FIGHT"
	DERBI	SENDA 50 SM	2001
	DERBI	SENDA RACER SM/ENDURO	2004 - 2009
	DERBI	SENDA X-TREME SM 50 - R 50	2004 - 2012
<b>RICAMBI</b>	303828502R	STAFFA FX2 CARB.PIC.SING.DISAS	
	303228201R	PROLUNGA ART.3228	
	303949001R	KIT RICAMBIO MOLLA A TRAZIONE CORTA	
	303228471R	SILENZIATORE X-FIGHT L=300mm INOX	
	303228601R	SACCH. MINUTERIA 3228	
	<b>Contiene:</b>		
	080194001 N. 1	STAFFA ALL. DIR L= 89	201248 N. 1 BOCCHETTONE 39X24X34.5
	200254 N. 1	RONDELLA 6X18 Z.B.	201450 N. 1 BRUGOLA M8X45 T.C.E.I. Z.B.
	200284 N. 2	MANICOTTO 20X22 GOMMA	202497 N. 1 PL DISTANZIALE 20X16X8.5 ALL.
	200295 N. 1	BULLONE 8X25-8.8 Z.B	204078 N. 1 ANTIVIBRANTE 25X20X14 6 MA
	200298 N. 2	DADO 8 FLANGIATO	204321 N. 1 DISTANZIALE AL.SBK Ø27X8.5
	200321 N. 1	PL-RONDELLA 8X24 PIANA Z.B.	303949001 N. 4 MOLLA TRAZ.KTM+TUBETTO MONTATO
	200333 N. 2	DADO 6 FLANGIATO	304113701 N. 1 FLANGIA IN FERRO 57E
<b>3253</b>	KYMCO	DINK STREET 125 i.e.	2009 - 2015 Leovince GRANTURISMO
	KYMCO	DOWNTOWN 125 i.e.	2009 - 2015
	KYMCO	SUPERDINK 125 i.e.	2009 - 2015
	KAWASAKI	J125 ABS	2016 -
<b>RICAMBI</b>	5608D49	FASCETTA Ø 49 INOX (300049533)	
	205984R	BOCCOLA IN GRAFITE LGR/F Øe.46 Øi.40 h30	
	303253201R	COLLETTORE N° 989 KYMCO 125 GT	
	303491471R	SILENZIATORE GT STAFFA AVANZATA	
	303253601R	SACCH. MINUTERIA 3253 GT	
	<b>Contiene:</b>		
	200321 N. 3	PL-RONDELLA 8X24 PIANA Z.B.	204083 N. 3 BULLONE 10X30 PASSO 1.25 TE ZB
	200361 N. 3	RONDELLA 8X14 GROWER Z.B.	204091 N. 1 GUARNIZIONE 17,85X12,3X1,5AL
	203335 N. 3	BULLONE 8X30 Z.B.	205123 N. 1 TAPPO M12X1.25X9 INOX
	203518 N. 3	RONDELLA 10X20 PIANA Z.B.	303419502 N. 1 STAFFA INOX
<b>3258</b>	HM	HM CRE 50 DERAPAGE - BAJA	2006 - 2013 Leovince HAND MADE "X-FIGHT"
	HM	HM CRE 50 DERAPAGE RR - BAJA 50 RR	2007 - 2013
<b>RICAMBI</b>	303828502R	STAFFA FX2 CARB.PIC.SING.DISAS	
	<b>Contiene:</b>		
	204677 N. 1	DISTANZIALE ALL DIS.079/05 ANOD.NERO	
	303258201R	PROLUNGA ART.3258	
	303949001R	KIT RICAMBIO MOLLA A TRAZIONE CORTA	
	303228471R	SILENZIATORE X-FIGHT L=300mm INOX	
	303258601R	SACCH. MINUTERIA 3258	
	<b>Contiene:</b>		
	087436003 N. 1	BOCCHETTONE Øe28x28xØi25,6mm	200414 N. 1 PL DISTANZIALE 20X10X8,5 ALL
	200284 N. 2	MANICOTTO 20X22 GOMMA	200967 N. 1 BRUGOLA M6X35 T.C.Z.B.
	200291 N. 1	PL-RONDELLA 6X12 PIANA Z.B.	205767 N. 1 DISTANZIALE 27X9X10.5/6.5 AL
	200333 N. 1	DADO 6 FLANGIATO	303949001 N. 4 MOLLA TRAZ.KTM+TUBETTO MONTATO
<b>3259</b>	BETAMOTOR	RR 50 ENDURO	2012 Leovince HAND MADE "X-FIGHT"
<b>RICAMBI</b>	303828501R	STAFFA FX1 CARB.PIC.SING.CENTR	
	303259201R	PROLUNGA ART.3259	
	303949001R	KIT RICAMBIO MOLLA A TRAZIONE CORTA	
	303228471R	SILENZIATORE X-FIGHT L=300mm INOX	
	303259601R	SACCH. MINUTERIA 3259	
	<b>Contiene:</b>		
	200254 N. 4	RONDELLA 6X18 Z.B.	203508 N. 2 BRUGOLA M6X20 T.C.Z.B.
	200284 N. 2	MANICOTTO 20X22 GOMMA	204321 N. 1 DISTANZIALE AL.SBK Ø27X8.5
	200314 N. 1	BRUGOLA M8X25 T.C.Z.B.	303949001 N. 4 MOLLA TRAZ.KTM+TUBETTO MONTATO
	200333 N. 2	DADO 6 FLANGIATO	

ART.	MARCA	MODELLO	TIPOLOGIA			
3260	MALAGUTI	XTM - XSM 50	2003 - 2006	Leovince	HAND MADE "X-FIGHT"	
	MBK	X-LIMIT 50	2003 - 2006			
	YAMAHA	DT 50 X - R	2003 - 2011			
RICAMBI	303828502R	STAFFA FX2 CARB.PIC.SING.DISAS				
	303260201R	PROLUNGA ART.3260				
	303949001R	KIT RICAMBIO MOLLA A TRAZIONE CORTA				
	303228471R	SILENZIATORE X-FIGHT L=300mm INOX				
	303260601R	SACCH. MINUTERIA 3260				
	<b>Contiene:</b>					
	200254	N. 2 RONDELLA 6X18 Z.B.	200617	N. 1	PL DISTANZIALE 25X18X8.5 ALL.	
	200284	N. 2 MANICOTTO 20X22 GOMMA	200765	N. 1	BRUGOLA M8X12 T.C.Z.B.	
	200298	N. 1 DADO 8 FLANGIATO Z.B.	203508	N. 1	BRUGOLA M6X20 T.C.Z.B.	
	200321	N. 2 PL-RONDELLA 8X24 PIANA Z.B.	204321	N. 1	DISTANZIALE AL.SBK Ø27X8.5	
	200333	N. 1 DADO 6 FLANGIATO	303949001	N. 4	MOLLA TRAZ.KTM+TUBETTO MONTATO	
	200461	N. 1 BRUGOLA M8X50 T.C.E.I. Z.B.				
3278	APRILIA	RS4 50	2011 - 2013	Leovince	HAND MADE "X-FIGHT"	
RICAMBI	303828501R	STAFFA FX1 CARB.PIC.SING.CENTR				
	303228471R	SILENZIATORE X-FIGHT L=300mm INOX				
	303278601R	SACCH. MINUTERIA 3278				
	<b>Contiene:</b>					
		083458001	N. 1 STAFFA FERRO PIEGATA 20/10mm	200321	N. 2	PL-RONDELLA 8X24 PIANA Z.B.
		084095010	N. 1 STAFFA FERRO CON SILENTBLOCK	200360	N. 1	BRUGOLA M8X16 T.C.Z.B.
	084095014	N. 1 DISTANZIALE IN FERRO X BOCCH.	201219	N. 2	BRUGOLA M6X30 T.C.Z.B.	
	200284	N. 1 MANICOTTO 20X22 GOMMA	201248	N. 1	BOCCHETTONE 39X24X34.5	
	200291	N. 2 PL-RONDELLA 6X12 PIANA Z.B.	204321	N. 1	DISTANZIALE AL.SBK Ø27X8.5	
	200294	N. 1 PL-RONDELLA 8X17 PIANA Z.B.	204386	N. 3	MOLLA INOX TRAZ.ELIC.	
	200296	N. 1 BULLONE 8X35-8.8 Z.B.FLANG.ZIG	205982	N. 2	DIST INO 11.6x22-6.5X7	
	200298	N. 2 DADO 8 FLANGIATO Z.B.	205983	N. 2	DIST IN 11.6x22-6.5XM6	
	200314	N. 1 BRUGOLA M8X25 T.C.Z.B.	304113701	N. 1	FLANGIA IN FERRO 57E	
3280	APRILIA	RX 50 (telaio perimetrale)	2005 - 2015	Leovince	HAND MADE "X-FIGHT"	
	APRILIA	SX 50 (telaio perimetrale)	2006 - 2015			
RICAMBI	303828502R	STAFFA FX2 CARB.PIC.SING.DISAS				
	303228201R	PROLUNGA ART.3228				
	303949001R	KIT RICAMBIO MOLLA A TRAZIONE CORTA				
	303228471R	SILENZIATORE X-FIGHT L=300mm INOX				
	303280601R	SACCH. MINUTERIA 3280				
	<b>Contiene:</b>					
	200284	N. 2 MANICOTTO 20X22 GOMMA	200993	N. 1	BRUGOLA 8X40 T.C.E.I. Z.B.	
	200294	N. 1 PL-RONDELLA 8X17 PIANA Z.B.	201248	N. 1	BOCCHETTONE 39X24X34.5	
	200298	N. 2 DADO 8 FLANGIATO Z.B.ZIGRINATO	204321	N. 1	DISTANZIALE AL.SBK Ø27X8.5	
	200360	N. 1 BRUGOLA M8X16 T.C.Z.B.	303949001	N. 4	MOLLA TRAZ.KTM+TUBETTO MONTATO	
	200414	N. 1 PL DISTANZIALE 20X10X8,5 ALL	304113701	N. 1	FLANGIA IN FERRO 57E	
3281	RIEJU	MRT 50 - MRT PRO 50	2009 - 2012	Leovince	HAND MADE "X-FIGHT"	
	RIEJU	MRT 50 SM - MRT PRO 50 SM	2009 - 2012			
RICAMBI	303828502R	STAFFA FX2 CARB.PIC.SING.DISAS				
	303281201R	PROLUNGA ART.3281				
	303949001R	KIT RICAMBIO MOLLA A TRAZIONE CORTA				
	303228471R	SILENZIATORE X-FIGHT L=300mm INOX				
	303281601R	SACCH. MINUTERIA 3281				
	<b>Contiene:</b>					
	080191001	N. 1 STAFFAALL.DIR L=62 2FORI 8.5	200319	N. 1	BRUGOLA M8X35 T.C.E.I. Z.B.	
	200284	N. 2 MANICOTTO 20X22 GOMMA	204321	N. 1	DISTANZIALE AL.SBK Ø27X8.5	
	200294	N. 1 PL-RONDELLA 8X17 PIANA Z.B.	206008	N. 1	BULLONE 8X16-8.8 Z.B.FLANG.ZIG	
	200298	N. 2 DADO 8 FLANGIATO Z.B.	303949001	N. 4	MOLLA TRAZ.KTM+TUBETTO MONTATO	
	200314	N. 1 BRUGOLA M8X25 T.C.Z.B.				
3282	MBK	X-POWER 50	2003 - 2012	Leovince	HAND MADE "X-FIGHT"	
	YAMAHA	TZR 50	2003 - 2013			
RICAMBI	303828502R	STAFFA FX2 CARB.PIC.SING.DISAS				
	303949001R	KIT RICAMBIO MOLLA A TRAZIONE CORTA				

ART.	MARCA	MODELLO	TIPOLOGIA						
		303228471R	SILENZIATORE X-FIGHT L=300mm INOX						
		303282601R	SACCH. MINUTERIA 3282						
		<b>Contiene:</b>							
		200284	N.	1	MANICOTTO 20X22 GOMMA	201822	N.	1	PL DISTANZIALE 20X14X8.5 ALL.
		200298	N.	1	DADO 8 FLANGIATO Z.B.	204321	N.	1	DISTANZIALE AL.SBK Ø27X8.5
		200321	N.	2	PL-RONDELLA 8X24 PIANA Z.B.	303949001	N.	1	MOLLA TRAZ.KTM+TUBETTO MONTATO
		201450	N.	1	BRUGOLA M8X45 T.C.E.I. Z.B.				
<b>3286</b>	DERBI	SENDA PRO R 50	2005 - 2012		Leovince	HAND MADE "X-FIGHT"			
	DERBI	SENDA PRO SM 50	2005 - 2012						
	<b>RICAMBI</b>	303828501R	STAFFA FX1 CARB.PIC.SING.CENTR						
		303286201R	PROLUNGA ART.3286						
		303949001R	KIT RICAMBIO MOLLA A TRAZIONE CORTA						
		303228471R	SILENZIATORE X-FIGHT L=300mm INOX						
		303286601R	SACCH. MINUTERIA 3286						
		<b>Contiene:</b>							
		200254	N.	2	RONDELLA 6X18 Z.B.	201248	N.	1	BOCCHETTONE 39X24X34.5
		200284	N.	2	MANICOTTO 20X22 GOMMA	203508	N.	1	BRUGOLA M6X20 T.C.Z.B.
		200298	N.	1	DADO 8 FLANGIATO Z.B.	204321	N.	1	DISTANZIALE AL.SBK Ø27X8.5
		200314	N.	1	BRUGOLA M8X25 T.C.Z.B.	303949001	N.	4	MOLLA TRAZ.KTM+TUBETTO MONTATO
		200333	N.	1	DADO 6 FLANGIATO	304113701	N.	1	FLANGIA IN FERRO 57E
<b>3293</b>	KAWASAKI	NINJA 250 R i.e.	2013 - 2016		Leovince	SLIP ON - GP CORSA RACING - CARB.			
	KAWASAKI	Z 250 i.e.	2015 - 2016						
	KAWASAKI	NINJA 300 R i.e.	2013 - 2016						
	KAWASAKI	Z 300 i.e.	2015 - 2016						
	<b>RICAMBI</b>	303439501R	KIT SACCHETTO FASCETTA CON ASOLA X CARB						
		303457802R	KIT SACCHETTO TAPPO Ø25mm X SILENZ. CUB						
		303293202R	KIT SACCHETTO COLLETTORE N° 1004 NINJA 300						
		300038530R	KIT fascetta 38 Inox						
		303293601R	KIT SACCH. MINUT.NINJA 300 '13 LV5						
		303949001R	KIT MOLLA TRAZ.KTM+TUBETTO MONTATO						
		303457473R	KIT CORPO CUB TONDO CARBONIO LANA HT						
		303430711R	KIT COPPA POST. INOX X CUB LV5						
		083457002R	KIT RIVESTIMENTO CUB CARBONIO Ø90mm L=240						
		414205R	KIT RICAMBI LANA HT 800 Plus 850g						
		206721R	KIT TARGHETTA LEOVINCE CARBONIO						
<b>3296</b>	KAWASAKI	NINJA 250 R i.e.	2013 - 2016		Leovince	IMP. C. 2/1 - GP CORSA RACING- CARB.			
	KAWASAKI	NINJA 300 R i.e.	2013 - 2016						
	<b>RICAMBI</b>	303439501R	KIT SACCHETTO FASCETTA CON ASOLA X CARB						
		303457802R	KIT SACCHETTO TAPPO Ø25mm X SILENZ. CUB						
		308743205R	KIT SACCHETTO COLLETTORI PRIM. NINJA 300 '14						
		205295R	KIT RIC FLANGIA INOX 138 A DIS.100/09						
		205296R	KIT RIC BOCCOLA 40X24X29 INOX DIS.101/09						
		308743206R	KIT SACCHETTO BIFORC. SECOND.NINJA 301						
		308743207R	KIT SACCHETTO COLLETTORE FIN. NINJA 301						
		303296601R	KIT SACCH. MINUT.NINJA 300 '14						
		5682	KIT TAPPO SONDA LAMBDA M18 BASE + GUARN						
		304982002R	KIT MOLLA TRAZ.+TUBETTO MONTATO						
		303457473R	KIT CORPO CUB TONDO CARBONIO LANA HT						
		303430711R	KIT COPPA POST. INOX X CUB LV6						
		083457002R	KIT RIVESTIMENTO CUB CARBONIO Ø90mm L=241						
		414205R	KIT RICAMBI LANA HT 800 Plus 850g						
		206721R	KIT TARGHETTA LEOVINCE CARBONIO						
<b>3378</b>	SUZUKI	DR 650 SE	1996-2015		Leovince	X3 - SLIP-ON - ALUMINUM			
	<b>RICAMBI</b>	304972501R	KIT RIC STAFFA-GUARN. GOMMA A1						
		303990602R	KIT RIC TAPPO SACCHETTO TAPPO FORATO X3						
		305074501R	KIT RIC SPARK-ARRESTER X3 NEW FIM						
		305074802R	KIT RIC TAPPO INT.DIRETTO CORTO X ENDURO						
		305074803R	KIT RIC TAPPO INT.FORATO x NEW FIM USA						
		305074804R	KIT RIC TAPPO INT.DIRETTO CORT x FIM USA						
		303378202R	KIT SACCHETTO COLLETTORE N.1070						

ART.	MARCA	MODELLO	TIPOLOGIA
		303378601R KIT SACCH. MINUTERIA SUZUKI DR 650 SE '9	
		303949001R KIT RIC MOLLA-GOMM. ANTIVIB. CORTA	
		303378401R KIT RIC SIL L=400 ALL.BOC.Ø50 INTERNO	
		083378020R KIT LAMELLA E RIVETTI OM.0135 3298	
		204188R KIT GUARNIZ. GRAFITE 3 FORI NEW FIM X3	
		305074702R KIT COPPA POSTERIORE CON 3 FORI D.5MM	
		305074801R KIT RIC TAPPO ENDURO X3 FORATO LUNGO	
		083990002R KIT RIC RIVESTIMENTO OVALE ALL. L=400	
<b>3384</b>	HONDA	CB 400 F	2016- Leovince SLIP-ON-GP CORSA-CARBON FIBER-N/A
	HONDA	CBR 400 R	2016-
	HONDA	CB 500 F	2016-
	HONDA	CBR 500 R	2016-
<b>RICAMBI</b>		303457802R SACCHETTO TAPPO Ø25mm X SILENZ. CUB	
		303439501R SACCHETTO FASCETTA CON ASOLA X CARBONIO	
		3014034202R SACCHETTO COLLETTORE N.1094	
		303384601R SACCH. MINUT. HONDA CB/CBR 400/500 F/R	
		300045530R fascetta 45 Inox	
		304982002R MOLLA TRAZ.+TUBETTO MONTATO	
		303457473R CORPO CUB TONDO CARBONIO LANA HT	
		303430711R COPPA POST. INOX X CUB LV5	
		083457002R RIVESTIMENTO CUB CARBONIO Ø90mm L=240mm	
		414204R KIT LANA	
<b>3384E</b>	HONDA	CB 400 F	2016- Leovince SLIP-ON-GP CORSA EVO-CARBON FIBER-TECHNOPOLYMER
	HONDA	CBR 400 R	2016-
	HONDA	CB 500 F	2016-
	HONDA	CBR 500 R	2016-
<b>RICAMBI</b>		303457802R SACCHETTO TAPPO Ø25mm X SILENZ. CUB	
		303439501R SACCHETTO FASCETTA CON ASOLA X CARBONIO	
		3014034202R SACCHETTO COLLETTORE N.1094	
		303384601R SACCH. MINUT. HONDA CB/CBR 400/500 F/R	
		300045530R fascetta 45 Inox	
		304982002R MOLLA TRAZ.+TUBETTO MONTATO	
		303457474R CORPO CUB EVO TONDO CARBONIO LANA HT	
		083375003R LAMELLA PER RIVETTI 305X15 3375	
		206304R COPPA PLASTICA GP CORSA EVO	
		303430711R COPPA POST. INOX X CUB LV5	
		083457002MR RIVESTIMENTO CUB CARB.OPAC Ø90mm L=240mm	
		414204R KIT LANA	
<b>3389E</b>	KAWASAKI	NINJA 400	2018- Leovince GP CORSA EVO - SLIP-ON - CARBON FIBER
<b>RICAMBI</b>		303430801R KIT TAPPO xSILENZIATORI CUB d.22mm	
		303439501R KIT SACCHETTO FASCETTA CON ASOLA X CARB	
		3015218202R KIT SACCHETT COLLETTORE N.1187	
		3015218601R KIT SACCHET MINUTERIA KAWASAKI NINJA 400	
		303457474R KIT RIC CORPO CUB EVO TONDO CARB LANA HT	
		303430711R KIT COPPA POST. INOX X CUB LV5	
		303430703R KIT CANDELA Ø54 X SILENZ. CUB LV5	
		083457002MR KIT RIC RIVESTIMENTO CUB C OPAC Ø90 L240	
		083375003R KIT LAMELLE E RIVETTI CUB	
		206304R KIT RIC COPPA PLASTICA GP CORSA EVO	
		206733R KIT RIC TARGHETTA LEOVINCE CARB LV PRO	
		414206R KIT RICAMBI LANA GP CORSA L=240	
<b>3389</b>	KAWASAKI	NINJA 400	2018- Leovince GP CORSA - SLIP ON - CARBON FIBER
<b>RICAMBI</b>		303430801R KIT TAPPO xSILENZIATORI CUB d.22mm	
		303439501R KIT SACCHETTO FASCETTA CON ASOLA X CARB	
		3015218202R KIT SACCHETT COLLETTORE N.1187	
		3015218601R KIT SACCHET MINUTERIA KAWASAKI NINJA 400	
		303457473R KIT RIC CORPO CUB TONDO CAR.LANA HT	
		303430711R KIT COPPA POST. INOX X CUB LV5	
		303430703R KIT CANDELA Ø54 X SILENZ. CUB LV5	
		083457002R KIT RIC RIVESTIMENTO CUB CAR Ø90mm L=240	



ART.	MARCA	MODELLO	TIPOLOGIA
		206733R KIT RIC TARGHETTA LEOVINCE CARB LV PRO 414206R KIT RICAMBI LANA GP CORSA L=240	
<b>3434</b>	PEUGEOT	LUDIX 50 2 ONE	2004 - 2012 Leovince TOURING
	PEUGEOT	LUDIX 50 2 TREND	2004 - 2012
	PEUGEOT	LUDIX 50 ONE (air cooled)	2004
	PEUGEOT	NEW VIVACITY	2008 - 2012
	PEUGEOT	KISBEE	2011 - 2015
<b>RICAMBI</b>		203104R KIT MASCHERINA TOURING 304571610R KIT SACCHETTO MOLLE PIAGGIO ROSSE 300714601R KIT SACCHETTO MINUTERIA 3434 0714	
<b>3463</b>	KAWASAKI	NINJA 250 R i.e.	2008 - 2012 Leovince SLIP ON - GP CORSA RACING - CARB.
<b>RICAMBI</b>		303439501R KIT SACCHETTO FASCETTA CON ASOLA X CARB 303457802R KIT SACCHETTO TAPPO Ø25mm X SILENZ. CUB 303463202R KIT SACCHETTO COLLETTORE N° 941 NINJA 250 300043530R KIT fascetta 43 Inox 303463601R KIT SACCH. MIN.KAW. NINJA 250 LV5 203529R KIT RIC BOCCOLA 40X35X30 LGR/F 303949001R KIT MOLLA TRAZ.KTM+TUBETTO MONTATO 303457473R KIT CORPO CUB TONDO CARBONIO LANA HT 303430711R KIT COPPA POST. INOX X CUB LV5 083457002R KIT RIVESTIMENTO CUB CARBONIO Ø90mm L=240 414205R KIT RICAMBI LANA HT 800 Plus 850g 206721R KIT TARGHETTA LEOVINCE CARBONIO	
<b>3469</b>	HONDA	CBR 250 i.e.	2011 - 2013 Leovince SLIP ON - GP CORSA RACING - CARB.
<b>RICAMBI</b>		303439501R KIT SACCHETTO FASCETTA CON ASOLA X CARB 303457802R KIT SACCHETTO TAPPO Ø25mm X SILENZ. CUB 303469202R KIT SACCHETTO COLLETTORE N° 942 CBR 250 R 300041530R KIT fascetta 41 Inox 303469601R KIT SACCH. MINUT.CBR 250 R '12 LV5 303949001R KIT MOLLA TRAZ.KTM+TUBETTO MONTATO 303457473R KIT CORPO CUB TONDO CARBONIO LANA HT 303430711R KIT COPPA POST. INOX X CUB LV5 083457002R KIT RIVESTIMENTO CUB CARBONIO Ø90mm L=240 414205R KIT RICAMBI LANA HT 800 Plus 850g 206721R KIT TARGHETTA LEOVINCE CARBONIO	
<b>3474</b>	SUZUKI	AN 400 BURGMAN (K7)	2007 - 2013 Leovince GRANTURISMO
<b>RICAMBI</b>		205984R BOCCOLA IN GRAFITE LGR/F Øe.46 Øi.40 h30 5608D49 FASCETTA Ø 49 INOX (300049533) 303428471R SILENZIATORE GT STAFFA ARRETRATA 307434201R COLLETTORE 4 ROAD N°585 307434601R SACCH. MINUTERIA 7434	
		Contiene:	
		200294 N. 3 PL-RONDELLA 8X17 PIANA Z.B.	202185 N. 1 GUARNIZIONE 23,85X18,3X1,5 AL-D050/99
		200319 N. 2 BRUGOLA M8X35 T.C.E.I. Z.B.	203335 N. 3 BULLONE 8X30 Z.B.
		200321 N. 3 PL-RONDELLA 8X24 PIANA Z.B.	204888 N. 1 BULLONE M18X9 INOX
		200360 N. 1 BRUGOLA M8X16 T.C.Z.B.	300035530 N. 1 FASCETTA 35 INOX
		200361 N. 6 RONDELLA 8X14 GROWER Z.B.	307434502 N. 1 STAFFA INOX
		201822 N. 2 PL. DISTANZIALE 20X14X8.5 ALL.	
<b>3475</b>	HONDA	SH 300 i.e.	2007 - 2015 Leovince GRANTURISMO
<b>RICAMBI</b>		205984R BOCCOLA IN GRAFITE LGR/F Øe.46 Øi.40 h30 5608D49 FASCETTA Ø 49 INOX (300049533) 303428471R SILENZIATORE GT STAFFA ARRETRATA 307446201R COLLETTORE 4-ROAD SALD N° 590 307446601R SACCH. MINUTERIA 7446	
		Contiene:	
		200321 N. 3 PL-RONDELLA 8X24 PIANA Z.B.	203518 N. 3 RONDELLA 10X20 PIANA Z.B.
		200349 N. 3 RONDELLA 10 GROWER Z.B.	307446502 N. 1 STAFFA INOX
		200361 N. 3 RONDELLA 8X14 GROWER Z.B.	406393 N. 3 VITE M10X1.25X30 BRUGOLA Z.B.
		203335 N. 3 BULLONE 8X30 Z.B.	

ART.	MARCA	MODELLO	TIPOLOGIA		
<b>3477</b>	MBK	KILIBRE 300	2003 - 2004	Leovince	GRANTURISMO
	YAMAHA	X-CITY 250 i.e.	2006 - 2016		
	YAMAHA	X-MAX 250 - X-MAX 250 i.e.	2006 - 2016		
	YAMAHA	VERSITY 300	2003 - 2005		
<b>RICAMBI</b>	205984R	BOCCOLA IN GRAFITE LGR/F Øe.46 Øi.40 h30			
	5608D49	FASCETTA Ø 49 INOX (300049533)			
	303949001R	KIT RICAMBIO MOLLA A TRAZIONE CORTA			
	303428471R	SILENZIATORE GT STAFFA ARRETRATA			
	304174202R	COLLETTORE ANT.4 ROAD N°716			
	304174203R	COLLETTORE POST.4 ROAD N°717			
	303477601R	SACCH. MINUTERIA 3477			
	Contiene:				
	200321	N. 3 PL-RONDELLA 8X24 PIANA Z.B.	203335	N. 3	BULLONE 8X30 Z.B.
	200325	N. 3 RONDELLA 12X24 PIANA Z.B.	204246	N. 3	BULLONE 12X1.25X50 T.E. Z.B.
	200361	N. 3 RONDELLA 8X14 GROWER Z.B.	204888	N. 1	BULLONE M18X9 INOX
	200627	N. 1 GANCIO TIRAMOLLE	303477502	N. 1	STAFFA INOX
	202185	N. 1 GUARNIZIONE 23,85X18,3X1,5 AL	303949001	N. 1	MOLLA TRAZ.KTM+TUBETTO MONTATO
<b>3479</b>	SUZUKI	AN 650 BURGMAN i.e.	2003 - 2012	Leovince	GRANTURISMO
<b>RICAMBI</b>	205984R	BOCCOLA IN GRAFITE LGR/F Øe.46 Øi.40 h30			
	5608D49	FASCETTA Ø 49 INOX (300049533)			
	4682	KIT MOLLA A TRAZIONE LUNGA 304982002			
	303428471R	SILENZIATORE GT STAFFA ARRETRATA			
	304151201R	COLLETTORE 4 ROAD PRIM DX 4151			
	304151202R	COLLETTORE 4 ROAD PRIM SX 4151			
	304151203R	COLLETTORE 4 ROAD SECOND 4151			
	304151204R	COLLETTORE 4 ROAD FINALE 4151			
	304151601R	SACCH. MINUTERIA 4151			
	Contiene:				
	200298	N. 1 DADO 8 FLANGIATO Z.B.	201029	N. 1	TAPPO 22X18X16X18
	200321	N. 5 PL-RONDELLA 8X24 PIANA Z.B.	202185	N. 1	GUARNIZIONE 23,85X18,3X1,5 AL
	200361	N. 4 RONDELLA 8X14 GROWER Z.B.	203335	N. 3	BULLONE 8X30 Z.B.
	200461	N. 1 BRUGOLA M8X50 T.C.E.I. Z.B.	204321	N. 1	DISTANZIALE AL.SBK Ø27X8.5
	200627	N. 1 GANCIO TIRAMOLLE	304114502	N. 1	STAFFA INOX SALD E PULIT 4114
	200722	N. 1 BRUGOLA M8X20 T.C.Z.B.	304982002	N. 4	MOLLA TRAZ.+TUBETTO MONTATO
<b>3488</b>	PEUGEOT	CITYSTAR 125 i.e.	2011 - 2012	Leovince	GRANTURISMO
	PEUGEOT	SATELIS 125 i.e.	2006 - 2011		
	PEUGEOT	SATELIS 2 125 i.e.	2012 - 2013		
<b>RICAMBI</b>	205984R	BOCCOLA IN GRAFITE LGR/F Øe.46 Øi.40 h30			
	5608D49	FASCETTA Ø 49 INOX (300049533)			
	303491471R	SILENZIATORE GT STAFFA AVANZATA			
	303421201R	COLLETTORE 4-ROAD SALD N° 817			
	303488601R	SACCH. MINUTERIA 3488			
	Contiene:				
	200294	N. 3 PL-RONDELLA 8X17 PIANA Z.B.	200993	N. 3	BRUGOLA 8X40 T.C.E.I. Z.B.
	200321	N. 3 PL-RONDELLA 8X24 PIANA Z.B.	203335	N. 3	BULLONE 8X30 Z.B.
	200361	N. 3 RONDELLA 8X14 GROWER Z.B.	303488502	N. 1	STAFFA INOX
<b>3490</b>	SUZUKI	UH 125 BURGMAN	2007 - 2009	Leovince	GRANTURISMO
	SUZUKI	AN 125 BURGMAN	2010 - 2013		
	SUZUKI	UH 200 BURGMAN	2007 - 2013		
<b>RICAMBI</b>	205984R	BOCCOLA IN GRAFITE LGR/F Øe.46 Øi.40 h30			
	5608D49	FASCETTA Ø 49 INOX (300049533)			
	303491471R	SILENZIATORE GT STAFFA AVANZATA			
	303417201R	COLLETTORE 4-ROAD SALD N° 800			
	307442601R	SACCH. MINUTERIA 7442			
	Contiene:				
	200294	N. 3 PL-RONDELLA 8X17 PIANA Z.B.	202491	N. 3	BRUGOLA M8X30 T.C.E.I. Z.B.
	200321	N. 3 PL-RONDELLA 8X24 PIANA Z.B.	203335	N. 3	BULLONE 8X30 Z.B.
	200361	N. 6 RONDELLA 8X14 GROWER Z.B.	204888	N. 1	BULLONE M18X9 INOX
	200414	N. 3 PL DISTANZIALE 20X10X8,5 ALL.	205243	N. 1	GUARNIZIONE 42X26X3 SPIROT.
	202185	N. 1 GUARNIZIONE 23,85X18,3X1,5 ALL.	307442502	N. 1	STAFFA INOX

ART.	MARCA	MODELLO	TIPOLOGIA		
3495	SUZUKI	AN 250 BURGMAN	1998 - 2002	Leovince	GRANTURISMO
	SUZUKI	AN 400 BURGMAN	1999 - 2002		
RICAMBI	205984R	BOCCOLA IN GRAFITE LGR/F Øe.46 Øi.40 h30			
	5608D49	FASCETTA Ø 49 INOX (300049533)			
	303428471R	SILENZIATORE GT STAFFA ARRETRATA			
	305596201R	COLLETTORE 4 ROAD N°573 X ART. 5596			
	305596601R	SACCH. MINUTERIA 5596			
	Contiene:				
	080193001	N. 1 STAFFA ALL. DIR L=136	200363	N. 2	BRUGOLA M8X30 T.C.E.I. INOX
	200255	N. 2 BULLONE 8X20 Z.B.	200607	N. 2	DADO 10 FLANG.ZIGRINATO Z.B.
	200294	N. 2 PL-RONDELLA 8X17 PIANA Z.B.	201171	N. 2	RONDELLA 8X17 PIANA INOX
	200298	N. 1 DADO 8 FLANGIATO Z.B	203335	N. 3	BULLONE 8X30 Z.B.
	200321	N. 3 PL-RONDELLA 8X24 PIANA Z.B.	305596502	N. 1	STAFFA INOX
	200361	N. 3 RONDELLA 8X14 GROWER Z.B.	406392	N. 2	VITE M10X60 BRUGOLA Z.B.
3496	GILERA	FUOCO 500 i.e.	2007 - 2015	Leovince	GRANTURISMO
	PIAGGIO	MP3 400 i.e.	2007		
	PIAGGIO	MP3 LT 400 i.e.	2008 - 2012		
	PIAGGIO	MP3 RST 400 i.e.	2008 - 2012		
	PIAGGIO	MP3 LT 500 SPORT i.e.	2011 - 2016		
	PIAGGIO	MP3 LT 500 BUSINESS i.e.	2011 - 2016		
RICAMBI	205984R	BOCCOLA IN GRAFITE LGR/F Øe.46 Øi.40 h30			
	5608D49	FASCETTA Ø 49 INOX (300049533)			
	303491471R	SILENZIATORE GT STAFFA AVANZATA			
	303496201R	COLLETTORE 4 ROAD N° 948			
	Contiene:				
	300043530	N. 1 FASCETTA 43 INOX			
	303496601R	SACCH. MINUTERIA 3496			
	Contiene:				
	084099001	N. 1 STAFFA INOX PIEGATA	203335	N. 3	BULLONE 8X30 Z.B.
	200321	N. 3 PL-RONDELLA 8X24 PIANA Z.B.	206008	N. 1	BULLONE 8X16-8.8 Z.B FLANG.
	200361	N. 3 RONDELLA 8X14 GROWER Z.B.	206101	N. 1	VITE M8X60 T.E.FLANG.
	200589	N. 1 BULLONE 8X40 T.E.FLANGIATO Z.B	303496502	N. 1	STAFFA INOX
	202896	N. 1 PL DISTANZIALE 20X40X8.5 ALL.	304099501	N. 1	STAFFA INOX CON DADO SALD.
3499	PIAGGIO	MP3 125	2007	Leovince	GRANTURISMO
	PIAGGIO	X7 125	2008		
	PIAGGIO	X8 125	2004 - 2006		
	PIAGGIO	X-EVO 125	2008		
	RICAMBI	205984R	BOCCOLA IN GRAFITE LGR/F Øe.46 Øi.40 h30		
	5608D49	FASCETTA Ø 49 INOX (300049533)			
	303491471R	SILENZIATORE GT STAFFA AVANZATA			
	307410201R	COLLETTORE 4 ROAD N°576			
	304083601R	SACCH. MINUTERIA 4083			
	Contiene:				
	200294	N. 3 PL-RONDELLA 8X17 PIANA Z.B.	203328	N. 2	BRUGOLA M8X80 T.C.E.I. Z.B.
	200321	N. 3 PL-RONDELLA 8X24 PIANA Z.B.	203335	N. 3	BULLONE 8X30 Z.B.
	200361	N. 6 RONDELLA 8X14 GROWER Z.B.	304154502	N. 1	STAFFA INOX SALD E PULIT 4154
	201222	N. 1 BRUGOLA M8X65 T.C.E.I.Z.B.			
3549	KAWASAKI	KLR 650	1997-2018	Leovince	X3 - SLIP-ON - ALUMINUM
	RICAMBI	303722502R	KIT RIC GUARNIZIONE-STAFFA GOMMA Q2		
		303968501R	KIT RIC STAFFA-GUARNIZIONE GOMMA R1		
		303990602R	KIT RIC TAPPO SACCHETTO TAPPO FORATO X3		
		305074501R	KIT RIC SPARK-ARRESTER X3 NEW FIM		
		305074802R	KIT RIC TAPPO INT.DIRETTO CORTO X ENDURO		
		305074803R	KIT RIC TAPPO INT.FORATO x NEW FIM USA		
		305074804R	KIT RIC TAPPO INT.DIRETTO CORT x FIM USA		
		303549202R	KIT SACCHETTO COLLETTORE N° 745		
		300045530R	KIT fascetta 45 Inox		
		303549601R	KIT RICAMBI SACCHETTO MINUTERIA KLR 650		
		303949001R	KIT RIC MOLLA-GOMM. ANTIVIB. CORTA		
		303990401R	KIT RIC CORPO L400 ALL.BOC.Ø50 INTERNO		

ART.	MARCA	MODELLO	TIPOLOGIA
		083928001R KIT LAMELLE E RIVETTI X3 204188R KIT GUARNIZ. GRAFITE 3 FORI NEW FIM X3 305074702R KIT COPPA POSTERIORE CON 3 FORI D.5MM 305074801R KIT RIC TAPPO ENDURO X3 FORATO LUNGO 083990002R KIT RIC RIVESTIMENTO OVALE ALL. L=400	
3606	BMW	G 650 X-CHALLENGE	2007-2011 Leovince X3 - SLIP-ON - ALUMINUM
	BMW	G 650 X-COUNTRY	2007-2011
	BMW	G 650 X-MOTO	2007-2011
RICAMBI		303990502R KIT fascetta 4A CARBONIO 303990602R KIT RIC TAPPO SACCHETTO TAPPO FORATO X3 305074501R KIT RIC SPARK-ARRESTER X3 NEW FIM 305074802R KIT RIC TAPPO INT.DIRETTO CORTO X ENDURO 305074803R KIT RIC TAPPO INT.FORATO x NEW FIM USA 305074804R KIT RIC TAPPO INT.DIRETTO CORT x FIM USA 305074805R KIT RIC TAPPO INT.DIRETTO LUNG x FIM USA 303606202R KIT SACCHETTO COLLETTORE N° 523 SX 300045530R KIT fascetta 45 Inox 303606681R KIT MINUTERIA BMW G 650 X '07 083606001R KIT CARTER CARBONIO BMW G 650 X '07 086684001R KIT CARTER CARBONIO UNIVERSALE PICCOLO 303949001R KIT RIC MOLLA-GOMM. ANTIVIB. CORTA 303990412R KIT RIC CORPO ENDURO SX X3 XT 660 R 083928001R KIT LAMELLE E RIVETTI X3 204188R KIT GUARNIZ. GRAFITE 3 FORI NEW FIM X3 305074702R KIT COPPA POSTERIORE CON 3 FORI D.5MM 305074801R KIT RIC TAPPO ENDURO X3 FORATO LUNGO 083990002R KIT RIC RIVESTIMENTO OVALE ALL. L=400	
3688	YAMAHA	WR 250 R/X	2008-2016 Leovince X3 - SLIP-ON - ALUMINUM
RICAMBI		303990503R KIT fascetta 4AA CARBONIO 303990602R KIT RIC TAPPO SACCHETTO TAPPO FORATO X3 305074501R KIT RIC SPARK-ARRESTER X3 NEW FIM 305074802R KIT RIC TAPPO INT.DIRETTO CORTO X ENDURO 305074803R KIT RIC TAPPO INT.FORATO x NEW FIM USA 305074804R KIT RIC TAPPO INT.DIRETTO CORT x FIM USA 303688202R KIT SACCHETTO COLLETTORE N. 647 DX 5684 KIT TAPPO SONDA LAMBDA M12 BASE + GUARN 300041530R KIT fascetta 41 Inox 303688681R KIT MINUTERIA YAM. WR 250X i.e.'08 083688001R KIT CARTER CARBONIO WR 250 X i.e. '08 303949001R KIT RIC MOLLA-GOMM. ANTIVIB. CORTA 303990401R KIT RIC CORPO L400 ALL.BOC.Ø50 INTERNO 083928001R KIT LAMELLE E RIVETTI X3 204188R KIT GUARNIZ. GRAFITE 3 FORI NEW FIM X3 305074702R KIT COPPA POSTERIORE CON 3 FORI D.5MM 305074801R KIT RIC TAPPO ENDURO X3 FORATO LUNGO 083990002R KIT RIC RIVESTIMENTO OVALE ALL. L=400	
3836	SUZUKI	DR-Z 400 S	2001-2008 Leovince X3 - SLIP-ON - ALUMINUM
RICAMBI		303990502R KIT fascetta 4A CARBONIO 303990602R KIT RIC TAPPO SACCHETTO TAPPO FORATO X3 305074501R KIT RIC SPARK-ARRESTER X3 NEW FIM 305074802R KIT RIC TAPPO INT.DIRETTO CORTO X ENDURO 305074803R KIT RIC TAPPO INT.FORATO x NEW FIM USA 305074804R KIT RIC TAPPO INT.DIRETTO CORT x FIM USA 303836202R KIT SACCHETTO COLLETTORE N. 391 300041530R KIT fascetta 41 Inox 303836601R KIT SACCH.MINUT.X SUZUKI DR-Z 400'05 303949001R KIT RIC MOLLA-GOMM. ANTIVIB. CORTA 303990401R KIT RIC CORPO L400 ALL.BOC.Ø50 INTERNO 083928001R KIT LAMELLE E RIVETTI X3 204188R KIT GUARNIZ. GRAFITE 3 FORI NEW FIM X3 305074702R KIT COPPA POSTERIORE CON 3 FORI D.5MM 305074801R KIT RIC TAPPO ENDURO X3 FORATO LUNGO	

ART.	MARCA	MODELLO	TIPOLOGIA
		08399002R	KIT RIC RIVESTIMENTO OVALE ALL. L=400
<b>3894</b>	YAMAHA	YFM 700 R RAPTOR	2006-2012 Leovince X3 - SLIP-ON - ALUMINUM
RICAMBI		303990501R KIT fascetta 2A CARBONIO 303990502R KIT fascetta 4A CARBONIO 303990602R KIT RIC TAPPO SACCHETTO TAPPO FORATO X3 305074501R KIT RIC SPARK-ARRESTER X3 NEW FIM 305074802R KIT RIC TAPPO INT.DIRETTO CORTO X ENDURO 305074803R KIT RIC TAPPO INT.FORATO x NEW FIM USA 305074804R KIT RIC TAPPO INT.DIRETTO CORT x FIM USA 303895202R KIT SACCHETTO COLLETTOR N. 434 YAM.YFM 70 300045530R KIT fascetta 45 Inox 303895681R KIT MINUTERIA ATV YFM 700R RAPTOR 083896002R KIT CARTER CARBONIO LATER X RAPTOR '06 303949001R KIT RIC MOLLA-GOMM. ANTIVIB. CORTA 303990401R KIT RIC CORPO L400 ALL.BOC.Ø50 INTERNO 083928001R KIT LAMELLE E RIVETTI X3 204188R KIT GUARNIZ. GRAFITE 3 FORI NEW FIM X3 305074702R KIT COPPA POSTERIORE CON 3 FORI D.5MM 305074801R KIT RIC TAPPO ENDURO X3 FORATO LUNGO 083990002R KIT RIC RIVESTIMENTO OVALE ALL. L=400	
<b>3914E</b>	KAWASAKI	KFX 400	2003-2006 Leovince X3 - SLIP-ON - ALUMINUM
	KAWASAKI	LTZ 400	2003-2008
RICAMBI		303990501R KIT fascetta 2A CARBONIO 303990502R KIT fascetta 4A CARBONIO 303990602R KIT RIC TAPPO SACCHETTO TAPPO FORATO X3 305074501R KIT RIC SPARK-ARRESTER X3 NEW FIM 305074802R KIT RIC TAPPO INT.DIRETTO CORTO X ENDURO 305074803R KIT RIC TAPPO INT.FORATO x NEW FIM USA 305074804R KIT RIC TAPPO INT.DIRETTO CORT x FIM USA 303812202R KIT SACCHETTO COLLETTOR N. 368 SX 300041530R KIT fascetta 41 Inox 303812601R KIT SACCH.MINUT.X SUZUKI LTZ 400 '04 303949001R KIT RIC MOLLA-GOMM. ANTIVIB. CORTA 303970401R KIT RIC CORPO L400 ALL.BOC.Ø50 X3 083928001R KIT LAMELLE E RIVETTI X3 204188R KIT GUARNIZ. GRAFITE 3 FORI NEW FIM X3 305074702R KIT COPPA POSTERIORE CON 3 FORI D.5MM 305074801R KIT RIC TAPPO ENDURO X3 FORATO LUNGO 083990002R KIT RIC RIVESTIMENTO OVALE ALL. L=400	
<b>3940E</b>	KTM	LC4 640 SM/ENDURO	2003-2004 Leovince X3 - SLIP-ON - ALUMINUM
	KTM	LC4 660 SM/ENDURO	2004-2005
RICAMBI		303990502R KIT fascetta 4A CARBONIO 303990602R KIT RIC TAPPO SACCHETTO TAPPO FORATO X3 305074501R KIT RIC SPARK-ARRESTER X3 NEW FIM 305074802R KIT RIC TAPPO INT.DIRETTO CORTO X ENDURO 305074803R KIT RIC TAPPO INT.FORATO x NEW FIM USA 305074804R KIT RIC TAPPO INT.DIRETTO CORT x FIM USA 303944204R KIT SACCHETTO COLLETTOR N. 317C HONDA 303940601R KIT SACCH.MINUT.X KTM LC4 640'03-'05 303949001R KIT RIC MOLLA-GOMM. ANTIVIB. CORTA 303940402R KIT RIC CORPO L400 ALL.Ø54 BOC.INT.TAP F 083928001R KIT LAMELLE E RIVETTI X3 204188R KIT GUARNIZ. GRAFITE 3 FORI NEW FIM X3 305074702R KIT COPPA POSTERIORE CON 3 FORI D.5MM 305074801R KIT RIC TAPPO ENDURO X3 FORATO LUNGO 083990002R KIT RIC RIVESTIMENTO OVALE ALL. L=400	
<b>3968E</b>	YAMAHA	XT 660 R/X	2004-2016 Leovince X3 - 2 SLIP-ON - ALUMINUM
RICAMBI		303801501R KIT fascetta 1A CARBONIO 303990602R KIT RIC TAPPO SACCHETTO TAPPO FORATO X3 305074501R KIT RIC SPARK-ARRESTER X3 NEW FIM	

ART.	MARCA	MODELLO		TIPOLOGIA
		305074802R	KIT RIC TAPPO INT.DIRETTO CORTO X ENDURO	
		305074803R	KIT RIC TAPPO INT.FORATO x NEW FIM USA	
		305074804R	KIT RIC TAPPO INT.DIRETTO CORT x FIM USA	
		305074805R	KIT RIC TAPPO INT.DIRETTO LUNG x FIM USA	
		303968207R	KIT SACCHETTO COLLETTORE N°381 DX	
		300038530R	KIT fascetta 38 Inox	
		303968208R	KIT SACCHETTO COLLETTORE N°382 SX	
		303968602R	KIT SACC MINUTERIA XT 660 R - X '04	
		303949001R	KIT RIC MOLLA-GOMM. ANTIVIB. CORTA	
		303990411R	KIT RIC CORPO ENDURO DX X3 XT 660 R	
		303990412R	KIT RIC CORPO ENDURO SX X3 XT 660 R	
		083928001R	KIT LAMELLE E RIVETTI X3	
		204188R	KIT GUARNIZ. GRAFITE 3 FORI NEW FIM X3	
		305074702R	KIT COPPA POSTERIORE CON 3 FORI D.5MM	
		305074801R	KIT RIC TAPPO ENDURO X3 FORATO LUNGO	
		083990002R	KIT RIC RIVESTIMENTO OVALE ALL. L=400	
<b>5123E</b>	YAMAHA	TT 600 R		1998-2005 Leovince X3 - SLIP-ON - ALUMINUM
	YAMAHA	TTE 600		1994-2002
<b>RICAMBI</b>		303801502R	KIT fascetta 3A CARBONIO	
		303990602R	KIT RIC TAPPO SACCHETTO TAPPO FORATO X3	
		305074501R	KIT RIC SPARK-ARRESTER X3 NEW FIM	
		305074802R	KIT RIC TAPPO INT.DIRETTO CORTO X ENDURO	
		305074803R	KIT RIC TAPPO INT.FORATO x NEW FIM USA	
		305074804R	KIT RIC TAPPO INT.DIRETTO CORT x FIM USA	
		305123202R	KIT SACCHETTO COLLET N372 TT600E-TT600R	
		300045530R	KIT fascetta 45 Inox	
		305123601R	KIT SACCH.MIN.YAMAHA TT 600 R 5123E	
		303949001R	KIT RIC MOLLA-GOMM. ANTIVIB. CORTA	
		303970401R	KIT RIC CORPO L400 ALL.BOC.Ø50 X3	
		083928001R	KIT LAMELLE E RIVETTI X3	
		204188R	KIT GUARNIZ. GRAFITE 3 FORI NEW FIM X3	
		305074702R	KIT COPPA POSTERIORE CON 3 FORI D.5MM	
		305074801R	KIT RIC TAPPO ENDURO X3 FORATO LUNGO	
		083990002R	KIT RIC RIVESTIMENTO OVALE ALL. L=400	
<b>7906B</b>	SUZUKI	GSX-R 600		2006-2007 Leovince GP STYLE BLACK - SLIP-ON - STAINLESS STEEL
	SUZUKI	GSX-R 750		2006-2007
<b>RICAMBI</b>		307906202R	KIT SACCHETTO COL.513DX SUZ.GSX R600 '07	
		300051530R	KIT fascetta 51 Inox	
		307906601R	KIT SACCH. MINUTERIA GSX R 600 i.e.'07	
		303949001R	KIT RIC MOLLA-GOMM. ANTIVIB. CORTA	
		307762475R	KIT RIC CORPO DX Ø150 L=295 IN OM0473 BL	
		307762801R	KIT TAPPO X OMOL. EVO2 N. 32B GPSTY	
<b>7906</b>	SUZUKI	GSX-R 600		2006-2007 Leovince GP STYLE - SLIP-ON - STAINLESS STEEL
	SUZUKI	GSX-R 750		2006-2007
	SUZUKI	GSX-R 600		2006-2007
	SUZUKI	GSX-R 750		2006-2007
<b>RICAMBI</b>		307906202R	KIT SACCHETTO COL.513DX SUZ.GSX R600 '07	
		300051530R	KIT fascetta 51 Inox	
		307906601R	KIT SACCH. MINUTERIA GSX R 600 i.e.'07	
		303949001R	KIT RIC MOLLA-GOMM. ANTIVIB. CORTA	
		307762471R	KIT RIC CORPO DX Ø150 L=295 INOX OM.0473	
		307762801R	KIT TAPPO X OMOL. EVO2 N. 32B GPSTY	
<b>7917B</b>	KAWASAKI	Z 750		2007-2014 Leovince GP STYLE BLACK - SLIP-ON - STAINLESS STEEL
	KAWASAKI	Z 750 R		2011-2014
<b>RICAMBI</b>		307915206R	KIT SACCHETTO COL 517C KAWASAKI Z 750'07	
		307917601R	KIT SACCHETTO MINUT. GPstyle Z 750	
		303949001R	KIT RIC MOLLA-GOMM. ANTIVIB. CORTA	
		30777475R	KIT RIC CORPO DX Ø154 L=295 IN OM0474 BL	
		307762801R	KIT TAPPO X OMOL. EVO2 N. 32B GPSTY	

ART.	MARCA	MODELLO		TIPOLOGIA
<b>7917</b>	KAWASAKI	Z 750	2007-2014	Leovince GP STYLE - SLIP-ON - STAINLESS STEEL
	KAWASAKI	Z 750 R	2011-2014	
	KAWASAKI	Z 750	2007-2014	
	KAWASAKI	Z 750 R	2011-2014	
RICAMBI	307915206R	KIT SACCHETTO COL 517C KAWASAKI Z 750'07		
	307917601R	KIT SACCHETTO MINUT. GPstyle Z 750		
	303949001R	KIT RIC MOLLA-GOMM. ANTIVIB. CORTA		
	307777471R	KIT RIC CORPO DX Ø154 L=295 INOX OM.0474		
	307762801R	KIT TAPPO X OMOL. EVO2 N. 32B GPSTY		
<b>7918B</b>	KAWASAKI	ER-6N/F/NINJA 650R	2006-2011	Leovince GP STYLE BLACK - SLIP-ON - STAINLESS STEEL
	KAWASAKI	VERSYS 650	2007-2014	
RICAMBI	307918202R	KIT SACCHETTO COLLETTORE 521 KAW ER 6N		
	300045530R	KIT fascetta 45 Inox		
	307918601R	KIT SACCH. MINUTERIA KAWAS. ER 6N '07		
	5682	KIT TAPPO SONDA LAMBDA M18 BASE + GUARN		
	303949001R	KIT RIC MOLLA-GOMM. ANTIVIB. CORTA		
	307762475R	KIT RIC CORPO DX Ø150 L=295 IN OM0473 BL		
	307762801R	KIT TAPPO X OMOL. EVO2 N. 32B GPSTY		
<b>7918</b>	KAWASAKI	ER-6N/F/NINJA 650R	2006-2011	Leovince GP STYLE - SLIP-ON - STAINLESS STEEL
	KAWASAKI	VERSYS 650	2007-2014	
	KAWASAKI	ER-6N/F/NINJA 650R	2006-2011	
	KAWASAKI	VERSYS 650	2007-2014	
RICAMBI	307918202R	KIT SACCHETTO COLLETTORE 521 KAW ER 6N		
	300045530R	KIT fascetta 45 Inox		
	307918601R	KIT SACCH. MINUTERIA KAWAS. ER 6N '07		
	5682	KIT TAPPO SONDA LAMBDA M18 BASE + GUARN		
	303949001R	KIT RIC MOLLA-GOMM. ANTIVIB. CORTA		
	307762471R	KIT RIC CORPO DX Ø150 L=295 INOX OM.0473		
	307762801R	KIT TAPPO X OMOL. EVO2 N. 32B GPSTY		
<b>7940B</b>	TRIUMPH	STREET TRIPLE 675	2007-2012	Leovince GP STYLE BLACK - 2 SLIP-ON - STAINLESS STEEL
	TRIUMPH	STREET TRIPLE 675 R	2009-2012	
RICAMBI	307940203R	KIT SACCHETTO COLLETT N° 615 TRIUMPH 675		
	307940204R	KIT SACCHETTO COLLETT N° 616 TRIUMPH 675		
	307940601R	KIT SACCH. MINUT. TRIUMPH 675 '07		
	303949001R	KIT RIC MOLLA-GOMM. ANTIVIB. CORTA		
	307762475R	KIT RIC CORPO DX Ø150 L=295 IN OM0473 BL		
	307762476R	KIT RIC CORPO SX Ø150 L=295 IN OM0473 BL		
	307762801R	KIT TAPPO X OMOL. EVO2 N. 32B GPSTY		
<b>7940</b>	TRIUMPH	STREET TRIPLE 675	2007-2012	Leovince GP STYLE - 2 SLIP-ON - STAINLESS STEEL
	TRIUMPH	STREET TRIPLE 675 R	2009-2012	
	TRIUMPH	STREET TRIPLE 675	2007-2012	
	TRIUMPH	STREET TRIPLE 675 R	2009-2012	
RICAMBI	307940203R	KIT SACCHETTO COLLETT N° 615 TRIUMPH 675		
	307940204R	KIT SACCHETTO COLLETT N° 616 TRIUMPH 675		
	307940601R	KIT SACCH. MINUT. TRIUMPH 675 '07		
	303949001R	KIT RIC MOLLA-GOMM. ANTIVIB. CORTA		
	307762471R	KIT RIC CORPO DX Ø150 L=295 INOX OM.0473		
	307762472R	KIT RIC CORPO SX Ø150 L=295 INOX OM.0473		
	307762801R	KIT TAPPO X OMOL. EVO2 N. 32B GPSTY		
<b>8015</b>	HONDA	XL 700 V TRANSALP	2008-2013	Leovince CAT ELIMINATOR (LINK PIPE) - N/A - N/A
RICAMBI	308015202R	KIT SACCHETTO COLLETTORE N.643		
	5682	KIT TAPPO SONDA LAMBDA M18 BASE + GUARN		
	300043530R	KIT fascetta 43 Inox		
	308015601R	KIT SACCH. MINUT. TRANSALP 700 '08		
	203529R	KIT RIC BOCCOLA 40X35X30 LGR/F D.133/03		

ART.	MARCA	MODELLO	TIPOLOGIA
8036	YAMAHA	YZF 1000 R1	2009-2014 Leovince CAT ELIMINATOR (LINK PIPE) - N/A - N/A
RICAMBI	308036204R 5682 300063530R 308036205R 308036206R 308036601R 303949001R	KIT SACCHETTO COLLETTORE BIFORCA N. 724 KIT TAPPO SONDA LAMBDA M18 BASE + GUARN KIT fascetta 63 Inox KIT SACCHETTO COLLETTORE N. 725 DX KIT SACCHETTO COLLETTORE N. 726 SX KIT SACCHETTO MINUTERIA 8036 KIT RIC MOLLA-GOMM. ANTIVIB. CORTA	
8053	DUCATI	HYPERMOTARD 796	2009-2012 Leovince CAT ELIMINATOR (LINK PIPE) - N/A - N/A
RICAMBI	308053204R 5682 308053205R 300043530R 308053206R 306697601R 303949001R	KIT SACCHETTO COLLETTORE N. 803 ANT. KIT TAPPO SONDA LAMBDA M18 BASE + GUARN KIT SACCHETTO COLLETTORE N. 804 KIT fascetta 43 Inox KIT SACCHETTO COLLETTORE BIFORCA N. 805 KIT SACCH. MINUTERIA HYPERM. '07 KIT RIC MOLLA-GOMM. ANTIVIB. CORTA	
8057	HONDA	CB 1000 R	2008-2016 Leovince CAT ELIMINATOR (LINK PIPE) - N/A - N/A
RICAMBI	308057202R 5682 300041530R 308057601R	KIT SACCHETTO COLLETTORE N. 847 KIT TAPPO SONDA LAMBDA M18 BASE + GUARN KIT fascetta 41 Inox KIT SACCH. MINUT. CBR 1000R '08/'10	
8058	KAWASAKI	ZX-10R NINJA	2011-2015 Leovince CAT ELIMINATOR (LINK PIPE) - N/A - N/A
RICAMBI	308058202R 5682 300057530R 308058601R	KIT SACCHETTO COLLETTORE N.856 KIT TAPPO SONDA LAMBDA M18 BASE + GUARN KIT fascetta 57 Inox KIT SACCH. MINUT. ZX 10R NINJA '11	
8065	DUCATI	MULTISTRADA 1200/S/SPORT/TOURING	2010-2013 Leovince CAT ELIMINATOR (LINK PIPE) - N/A - N/A
RICAMBI	308065203R 308065204R 308065601R 304982002R	KIT SACCHETTO BIFORCA. N° 914 KIT SACCHETTO COLLETTORE POSTER N. 915 KIT RICAMBIO MIN DE-KAT MULTISTRADA KIT RIC MOLLA TRAZ.+TUBETTO MONTATO	
8069	HONDA	INTEGRA 700/DCT/ABS	2012-2013 Leovince HEADERS PIPES - N/A - N/A
	HONDA	NC 700 S/X/DCT/ABS	2012-2013
	HONDA	INTEGRA 750/DCT/ABS	2014-2015
	HONDA	INTEGRA 750/DCT/ABS (also fits 35Kw version)	2016-2018
	HONDA	NC 750 S/X/DCT/ABS (also fits 35Kw version)	2016-2018
RICAMBI	308069202R 5684 308069601R	KIT SACCHETTO COLLETTORE N.968 INTEGRA KIT TAPPO SONDA LAMBDA M12 BASE + GUARN KIT SACCH. MINUT. INTEGRA '12	
8070	KTM	690 DUKE	2012-2015 Leovince CAT ELIMINATOR (LINK PIPE) - N/A - N/A
	KTM	VITPILEN 701	2018-
RICAMBI	308070202R 308070601R	KIT SACCHETTO COLLETTORE N.964 DUKE 690 KIT SACCH. MINUT. KTM 690 DUKE '12	
8074	KAWASAKI	ZX-6R NINJA	2009-2016 Leovince CAT ELIMINATOR (LINK PIPE) - N/A - N/A
	KAWASAKI	ZX-6R 636 NINJA	2013-2016
RICAMBI	308074202R 300053530R 308074601R	KIT SACCHETTO COLLETTORE N. 1010 KIT fascetta 53 Inox KIT SACCH. MINUT. ZX-6R 636 '13	
8075	DUCATI	MULTISTRADA 1200/S/SPORT/TOURING	2010-2013 Leovince dB KILLER - N/A - N/A
RICAMBI	8075 IMBT20X40 410059	SBK dB-KILLER ELIMINA CATALIZ. MULISTRAD sacchetto anonimo 200X400 sp0,06 ETICHETTA 95X73 BIANCA OPACA	



ART.	MARCA	MODELLO		TIPOLOGIA
8087	KYMCO	AK550 ABS (compatible with original and LeoVince exhaust)	2017-2018	Leovince HEADERS PIPES - N/A - N/A
RICAMBI	308087202R 5683 308087204R 308087601R 303949001R	KIT SACCHETTO COLLETTORE PRIMARIO N.1158 KIT TAPPO SONDA LAMBDA M12 RACING + GUA KIT SACCHETTO COLLETTORE FINALE N.1159 KIT SACCHETTO MINUT KYMCO AK550 KIT RIC MOLLA-GOMM. ANTIVIB. CORTA		
8089	HONDA	CRF 1000 L AFRICA TWIN/ABS (fits with original panniers) (compatible with original exhaust, not compatible with LeoVince)	2016-2017	Leovince HEADERS PIPES - N/A - N/A
RICAMBI	3014220203R 3014220205R 5683 308089202R 308089601R 303949001R	KIT SACCHETTO COLLETT PRIM N.1165 1166 KIT SACCHETTO COLLETT SECONDARIO N.1167 KIT TAPPO SONDA LAMBDA M12 RACING + GUA KIT SACCHETTO COLLETT FINALE N.1169 KIT SAC MIN.X KIT COLL. 2/1 HONDA 1000L KIT RIC MOLLA-GOMM. ANTIVIB. CORTA		
8090	KAWASAKI	Z 900 RS/CAFE (compatible with original and LeoVince exhaust) (fits with original centre stand)	2018	Leovince HEADERS PIPES - N/A - N/A
RICAMBI	308090205R 308090207R 308090209R 308090211R 308090601R 303949001R 5681 206427R 206428R	KIT SACCHETTO COLLETTORI PRIMARI KIT SACCHETTO BIFORCAZIONE SECONDARIA SX KIT SACCHETTO BIFORCAZIONE SECONDARIA DX KIT SACCHETTO COLLETTORE FINALE 2/1 KIT SACC MINUT FULL SYS KAWA Z900 RS '18 KIT RIC MOLLA-GOMM. ANTIVIB. CORTA KIT TAPPO SONDA LAMBDA M18 RACING + GUA KIT BOCCOLA IN INOX 304 DIS.MF153 KIT FLANGIA INOX 304 SP.5MM DIS.MF154		
8091	KAWASAKI	Z 900 (compatible with original and LeoVince exhaust)	2017-2018	Leovince HEADERS PIPES - N/A - N/A
RICAMBI	308090205R 308090207R 308090209R 308091202R 308091601R 303949001R 5681 206427R 206428R	KIT SACCHETTO COLLETTORI PRIMARI KIT SACCHETTO BIFORCAZIONE SECONDARIA SX KIT SACCHETTO BIFORCAZIONE SECONDARIA DX KIT SACCHETTO COLLETTORE FINALE 2/1 KIT SACC MINUT FULL SYSTEM KAWA Z900 '18 KIT RIC MOLLA-GOMM. ANTIVIB. CORTA KIT TAPPO SONDA LAMBDA M18 RACING + GUA KIT BOCCOLA IN INOX 304 DIS.MF153 KIT FLANGIA INOX 304 SP.5MM DIS.MF154		
8095	HONDA	X-ADV	2017-2018	Leovince HEADERS PIPES - N/A - N/A
RICAMBI	308095202R 5684 308095601R	KIT SACCHETT COLLETTORE N.1201 KIT TAPPO SONDA LAMBDA M12 BASE + GUARN KIT SACCHETTO MINUTERIA HONDA X-ADV 750		
8124B	YAMAHA	YZF-R 125	2008-2013	Leovince GP STYLE BLACK - FULL SYSTEM 1/1 - STAINLESS STEEL
RICAMBI	308124202R 308124601R 303949001R 308124475R 307762801R	KIT SACCHETTO COLLETTORE PRIM N. 8124 KIT RICAMBIO MINUTERIA YAMAHA YZF 125 R KIT RIC MOLLA-GOMM. ANTIVIB. CORTA KIT RIC CORPO DX Ø150 L=295 IN OM0473 BL KIT TAPPO X OMOL. EVO2 N. 32B GPSTY		
8124	YAMAHA	YZF-R 125	2008-2013	Leovince GP STYLE - FULL SYSTEM 1/1 - STAINLESS STEEL
	YAMAHA	YZF-R 125	2008-2013	
RICAMBI	308124202R 308124601R 303949001R 308124471R 307762801R	KIT SACCHETTO COLLETTORE PRIM N. 8124 KIT RICAMBIO MINUTERIA YAMAHA YZF 125 R KIT RIC MOLLA-GOMM. ANTIVIB. CORTA KIT RIC CORPO DX Ø150 L=295 INOX OM.0473 KIT TAPPO X OMOL. EVO2 N. 32B GPSTY		
8207B	SUZUKI	SFV 650 GLADIUS	2009-2015	Leovince GP STYLE BLACK - SLIP-ON - STAINLESS STEEL
RICAMBI	308207202R 300043530R	KIT SACCHETTO COLLETT N° 734 GLADIUS '09 KIT fascetta 43 Inox		

ART.	MARCA	MODELLO		TIPOLOGIA
		308207601R 303949001R 307762475R 307762801R	KIT SACCH MINUTERIA GLADIUS 650 '09 KIT RIC MOLLA-GOMM. ANTIVIB. CORTA KIT RIC CORPO DX Ø150 L=295 IN OM0473 BL KIT TAPPO X OMOL. EVO2 N. 32B GPSTY	
<b>8207</b>	SUZUKI	SFV 650 GLADIUS	2009-2015	Leovince GP STYLE - SLIP-ON - STAINLESS STEEL
	SUZUKI	SFV 650 GLADIUS	2009-2015	
<b>RICAMBI</b>		308207202R 300043530R 308207601R 303949001R 307762471R 307762801R	KIT SACCHETTO COLLETT N° 734 GLADIUS '09 KIT fascetta 43 Inox KIT SACCH MINUTERIA GLADIUS 650 '09 KIT RIC MOLLA-GOMM. ANTIVIB. CORTA KIT RIC CORPO DX Ø150 L=295 INOX OM.0473 KIT TAPPO X OMOL. EVO2 N. 32B GPSTY	
<b>8232</b>	YAMAHA	XJ6/DIVERSION/FZ6R (fits with original centre stand)	2009-2015	Leovince UNDERBODY - FULL SYSTEM 4/2/1 - STAINLESS STEEL
<b>RICAMBI</b>		308210208R 204448R 205752R 308232204R 308232205R 5682 308232601R 303949001R 308232471R 088232014R 308232701R 204790R 308232801R 308232750R 8066	KIT RICAMBI COLLETTORE PRIM U.B. XJ-6 KIT RIC FLANGIA INOX 46 D DIS.086/04 KIT RIC BOCCOLA INOX 47X33X24 D.104/10 KIT SACCHETTO COLLETTORE SECOND.XJ6-IE KIT SACCHETTO BIFORCA FINAL XJ-6 i.e.'09 KIT TAPPO SONDA LAMBDA M18 BASE + GUARN KIT SACCH.MINUTERIA YAMAHA XJ-6 IE 09 KIT RIC MOLLA-GOMM. ANTIVIB. CORTA KIT RIC CORPO Ø150 L=205 OM.10034 10417 KIT LAMELLE E RIVETTI OM.10034/42 10417 KIT COPPA POST.UNDERBODY CARB KIT RIC GOMMINO COPPE CARBONIO D.007/06 KIT TAPPO X OMOL. EVO2 UNDER Xd.50 N. 47 KIT RIC RIVESTIMENTO UNDER CORTO L=205 KIT RICAMBIO MATERIALE FONOASS UNDERBODY	
<b>8240</b>	YAMAHA	XJ6/DIVERSION/FZ6R	2009-2015	Leovince EXHAUST TIP - ADDITIONAL SLIP-ON - STAINLESS STEEL
<b>RICAMBI</b>		308240202R 308240601R	KIT SACCHETTO COLLETTORE N.757 DX KIT RICAMBI SACCH. MINUTERIA YAMAHA XJ6	
<b>8242</b>	KAWASAKI	ER-6N/F/NINJA 650R	2006-2011	Leovince UNDERBODY - SLIP-ON - STAINLESS STEEL
	KAWASAKI	VERSYS 650	2007-2014	
<b>RICAMBI</b>		308242202R 300045531R 5682 308242601R 303949001R 308242471R 088232014R 308232701R 204790R 308232801R 308242750R 8066	KIT SACCHET COLLET N° 809 ER-6N/F '10 KIT Fascetta 45 Inox + Gancio Molla KIT TAPPO SONDA LAMBDA M18 BASE + GUARN KIT SACCH.MINUT.KAW.ER-6N/F '09 KIT RIC MOLLA-GOMM. ANTIVIB. CORTA KIT RIC CORPO INOX D50 L=205 10034 10417 KIT LAMELLE E RIVETTI OM.10034/42 10417 KIT COPPA POST.UNDERBODY CARB KIT RIC GOMMINO COPPE CARBONIO D.007/06 KIT TAPPO X OMOL. EVO2 UNDER Xd.50 N. 47 KIT RIC RIVESTIMENTO UNDER CORTO L=205 KIT RICAMBIO MATERIALE FONOASS UNDERBODY	
<b>8258</b>	KTM	690 DUKE LC4	2008-2011	Leovince UNDERBODY - SLIP-ON - STAINLESS STEEL
	KTM	690 DUKE R LC4	2009-2011	
<b>RICAMBI</b>		308258202R 308258681R 308258501R 308258502R 088258012R 088258014R 303949001R 308258471R 088232015R 308232701R 204790R	KIT SACCHETTO COLLETTORE N. 807 DUKE 690 KIT RICAMBIO MINUTERIA KTM 690 DUKE KIT STAFFA INF SUPPORTO CARENA INOX KIT STAFFA SUP SUPPORTO CARENA INOX KIT CARTER CARBONIO DX KTM 690 DUKE '10 KIT CARTER CARBONIO SX KTM 690 DUKE '10 KIT RIC MOLLA-GOMM. ANTIVIB. CORTA KIT RIC CORPO Ø150 L=300 OM.10042 KIT LAMELLE E RIVETTI OM.10034 10042 KIT COPPA POST.UNDERBODY CARB KIT RIC GOMMINO COPPE CARBONIO D.007/06	

ART.	MARCA	MODELLO	TIPOLOGIA
		308232801R KIT TAPPO X OMOL. EVO2 UNDER Xd.50 N. 47 308258750R KIT RIC RIVESTIMENTO UNDER LUNGO L=300 8066 KIT RICAMBIO MATERIALE FONOASS UNDERBODY	
<b>8275E</b>	YAMAHA	XT 1200 Z SUPER TENERE' (fits with original panniers)	2010-2016 Leovince LV ONE EVO - SLIP-ON - STAINLESS STEEL
<b>RICAMBI</b>		308274802R KIT TAPPO X OMOL. EVO2 N. 51B 306960505R KIT FASCETTA FB1S CARBONIO 308274601R KIT SACCHETTO MINUTERIA YAMAHA XT TENER 308275484R KIT R COR SX EV INOX RETE D.54 OM.0235 086355001R KIT LAMELLE E RIVETTI O.0233 0235 X8275 308274701R KIT RIC COPPA POST.BIG VERTICALE CARB 308274801R KIT TAPPO X OMOL. EVO2 N. 51 308274711R KIT COPPA POST.BIG VERTICALE USCITA D.54 300045530R KIT fascetta 45 Inox 086496003R KIT RIC RIVESTIMENTO BIG INOX L=450mm 414205R KIT RICAMBI LANA HT 800 Plus 850g	
<b>8277E</b>	YAMAHA	FZ8/FAZER 8	2010-2015 Leovince LV ONE EVO - SLIP-ON - STAINLESS STEEL
<b>RICAMBI</b>		306958501R KIT fascetta FM1 Factory Medio Verticale 308271202R KIT RICAMBIO COLLETTORE N° 826 FZ8 FAZER 300057530R KIT fascetta 57 Inox 308271601R KIT SACCH.MINUT.YAMAHA FZ8 '10 303949001R KIT RIC MOLLA-GOMM. ANTIVIB. CORTA 308410481R KIT R COR EV IN D54 MED L300 0457 10410 088280002R KIT KAMELLE E RIVETTI OM.0457 10410 3014008701R KIT RICAMBIO COPPA POST. MEDIA VERT CARB 307762801R KIT TAPPO X OMOL. EVO2 N. 32B GPSTY 308287711R KIT COPPA POST.M.VERT.D.54 EV.2+LUNG 083710014R KIT RIC RIVESTIMENTO DX VERT MEDIO L=300 414205R KIT RICAMBI LANA HT 800 Plus 850g	
<b>8278E</b>	YAMAHA	FZ8/FAZER 8	2010-2015 Leovince LV ONE EVO - SLIP-ON - CARBON FIBER
<b>RICAMBI</b>		306958501R KIT fascetta FM1 Factory Medio Verticale 308271202R KIT RICAMBIO COLLETTORE N° 826 FZ8 FAZER 300057530R KIT fascetta 57 Inox 308271601R KIT SACCH.MINUT.YAMAHA FZ8 '10 303949001R KIT RIC MOLLA-GOMM. ANTIVIB. CORTA 308411481R KIT R COR EV CAR D54 MED L300 0457 10410 088280002R KIT KAMELLE E RIVETTI OM.0457 10410 3014008701R KIT RICAMBIO COPPA POST. MEDIA VERT CARB 307762801R KIT TAPPO X OMOL. EVO2 N. 32B GPSTY 308287711R KIT COPPA POST.M.VERT.D.54 EV.2+LUNG 409117R KIT RIVESTIMENTO MED CARB 100X115 L=300 414205R KIT RICAMBI LANA HT 800 Plus 850g 206721R KIT RIC TARGHETTA LEOVINCE CARBONIO	
<b>8279E</b>	HONDA	CBR 600 RR/ABS	2007-2012 Leovince LV ONE - SLIP-ON - STAINLESS STEEL
<b>RICAMBI</b>		307002503R KIT fascetta FM3 Factory Medio Orizzontale 307730203R KIT SACCHETTO COLLETTORE N. 486 ANTERIOR 300051530R KIT fascetta 51 Inox 307730204R KIT RICAMBI COLL. FINALE CBR 600 RR 07 307730601R KIT SACCHETTO MIN. FACT. CBR600RR 07 303949001R KIT RIC MOLLA-GOMM. ANTIVIB. CORTA 308279481R KIT RIC COR E IN D54 MED L300 0457 10410 088280002R KIT KAMELLE E RIVETTI OM.0457 10410 2057570MR KIT RIC COPPA LV-ONE MEDIA ORIZ. 307762801R KIT TAPPO X OMOL. EVO2 N. 32B GPSTY 308284711R KIT COPPA POST.M.ORIZ.d.54 O6406+LUNG 083710014R KIT RIC RIVESTIMENTO DX VERT MEDIO L=300 414205R KIT RICAMBI LANA HT 800 Plus 850g	
<b>8280E</b>	HONDA	CBR 600 RR/ABS	2007-2012 Leovince LV ONE - SLIP-ON - CARBON FIBER
<b>RICAMBI</b>		307002503R KIT fascetta FM3 Factory Medio Orizzontale 307730203R KIT SACCHETTO COLLETTORE N. 486 ANTERIOR	

ART.	MARCA	MODELLO	TIPOLOGIA
		300051530R KIT fascetta 51 Inox	
		307730204R KIT RICAMBI COLL. FINALE CBR 600 RR 07	
		307730601R KIT SACCHETTO MIN. FACT. CBR600RR 07	
		303949001R KIT RIC MOLLA-GOMM. ANTIVIB. CORTA	
		308280481R KIT RIC COR E CA D54 MED L300 0457 10410	
		085096014R KIT LAMELLE E RIVET 0457 0237 0430 10410	
		205757OMR KIT RIC COPPA LV-ONE MEDIA ORIZ.	
		307762801R KIT TAPPO X OMOL. EVO2 N. 32B GPSTY	
		308284711R KIT COPPA POST.M.ORIZ.d.54 O6406+LUNG	
		409117R KIT RIVESTIMENTO MED CARB 100X115 L=300	
		414205R KIT RICAMBI LANA HT 800 Plus 850g	
		206721R KIT RIC TARGHETTA LEOVINCE CARBONIO	
<b>8281E</b>	DUCATI	MONSTER 696	2008-2014 Leovince LV ONE EVO - 2 SLIP-ON - STAINLESS STEEL
	DUCATI	MONSTER 796	2010-2014
	DUCATI	MONSTER 1100/S	2009-2010
<b>RICAMBI</b>		306958501R KIT fascetta FM1 Factory Medio Verticale	
		308135203R KIT RICAMBIO SACC COLL MONSTER 696 '08	
		300045532R KIT Fascetta 45 Inox + Gancio Mol DX8281	
		300045533R KIT Fascetta 45 Inox + Gancio Mol SX8281	
		308135204R KIT RICAMBIO SACC COLL MONSTER 696 '08	
		308135501R KIT STAFFA CARBONIO DX MONSTER 696 '08	
		308135502R KIT STAFFA CARBONIO SX MONSTER 696 '08	
		308282601R KIT RICAMBIO MINUT DUCATI MONSTER 796'10	
		304982002R KIT RIC MOLLA TRAZ.+TUBETTO MONTATO	
		308406481R KIT R COR EVO IN D50 MED L=270 OM.0430	
		308406482R KIT R COR SX EV IN D50 MED L=270 OM.0430	
		088282002R KIT LAMELLE E RIVETTI OM.0429 0430	
		3014008701R KIT RICAMBIO COPPA POST. MEDIA VERT CARB	
		308287711R KIT COPPA POST.M.VERT.D.54 EV.2+LUNG	
		307762801R KIT TAPPO X OMOL. EVO2 N. 32B GPSTY	
		088406004R KIT RIC RIVESTIMENTO FACT.DX MEDIO L=270	
		088406006R KIT RIC RIVESTIMENTO FACT.SX MEDIO L=270	
		414205R KIT RICAMBI LANA HT 800 Plus 850g	
<b>8282E</b>	DUCATI	MONSTER 696	2008-2014 Leovince LV ONE EVO - 2 SLIP-ON - CARBON FIBER
	DUCATI	MONSTER 796	2010-2014
	DUCATI	MONSTER 1100/S	2009-2010
<b>RICAMBI</b>		306958501R KIT fascetta FM1 Factory Medio Verticale	
		308135203R KIT RICAMBIO SACC COLL MONSTER 696 '08	
		300045532R KIT Fascetta 45 Inox + Gancio Mol DX8281	
		308135204R KIT RICAMBIO SACC COLL MONSTER 696 '08	
		300045533R KIT Fascetta 45 Inox + Gancio Mol SX8281	
		308282601R KIT RICAMBIO MINUT DUCATI MONSTER 796'10	
		304982002R KIT RIC MOLLA TRAZ.+TUBETTO MONTATO	
		308135501R KIT STAFFA CARBONIO DX MONSTER 696 '08	
		308135502R KIT STAFFA CARBONIO SX MONSTER 696 '08	
		308407481R KIT R COR EV CAR D50 MED L=270 OM.0430	
		308407482R KIT R COR SX EV CAR D50 MED L=270 OM0430	
		085096022R KIT LAMELLE E RIVETTI OM.430 014	
		3014008701R KIT RICAMBIO COPPA POST. MEDIA VERT CARB	
		307762801R KIT TAPPO X OMOL. EVO2 N. 32B GPSTY	
		308287711R KIT COPPA POST.M.VERT.D.54 EV.2+LUNG	
		088407002R KIT RIC RIVESTIMENTO FACTORY MEDIO L=270	
		414205R KIT RICAMBI LANA HT 800 Plus 850g	
		206721R KIT RIC TARGHETTA LEOVINCE CARBONIO	
<b>8283E</b>	YAMAHA	FZ6 S2/ABS (also fits 57 Kw version)	2007-2011 Leovince LV ONE - 2 SLIP-ON - STAINLESS STEEL
	YAMAHA	FZ6 FAZER S2/ABS (also fits 57 Kw version)	2007-2011
<b>RICAMBI</b>		306997501R KIT fascetta FM2 Factoy Medio Orizontale	
		307904202R KIT RIC SACCHETTO COLLETTORE N° 514 DX	
		300049530R KIT fascetta 49 Inox	
		308284204R KIT SACCHETTO COLLETTORE N. 857	
		300053530R KIT fascetta 53 Inox	

ART.	MARCA	MODELLO	TIPOLOGIA
------	-------	---------	-----------

308284681R	KIT RICAMBI MINUTERIA YAMAHA FZ6
303949001R	KIT RIC MOLLA-GOMM. ANTIVIB. CORTA
304982002R	KIT RIC MOLLA TRAZ.+TUBETTO MONTATO
307002501R	KIT STAFFA SUPPORTO SILENZIATORE INOX
307002502R	KIT STAFFA PORTA TARGA INOX
308283481R	KIT R. COR.EVO IN D.50MEDIO L=250OM.9633
308283482R	KIT R. COR SX EVO IN D.50MED L=500M.9633
088283006R	KIT RIC RIVESTIMENTO FACT.SX MEDIO L=250
088284014R	KIT LAMELLE E RIVETTI OM.9633
205757OMR	KIT RIC COPPA LV-ONE MEDIA ORIZ.
307919801R	KIT TAPPO X OMOL. EVO2 N. 32BF GPSTY
308284711R	KIT COPPA POST.M.ORIZ.d.54 O6406+LUNG
088283004R	KIT RIC RIVESTIMENTO FACT.DX MEDIO L=250
414205R	KIT RICAMBI LANA HT 800 Plus 850g

<b>8284E</b>	YAMAHA	FZ6 S2/ABS (also fits 57 Kw version)	2007-2011	Leovince LV ONE - 2 SLIP-ON - CARBON FIBER
	YAMAHA	FZ6 FAZER S2/ABS (also fits 57 Kw version)	2007-2011	

**RICAMBI**

306997501R	KIT fascetta FM2 Factoy Medio Orizzontale
307904202R	KIT RIC SACCHETTO COLLETTORE N° 514 DX
300049530R	KIT fascetta 49 Inox
308284204R	KIT SACCHETTO COLLETTORE N. 857
300053530R	KIT fascetta 53 Inox
308284681R	KIT RICAMBI MINUTERIA YAMAHA FZ6
303949001R	KIT RIC MOLLA-GOMM. ANTIVIB. CORTA
304982002R	KIT RIC MOLLA TRAZ.+TUBETTO MONTATO
307002501R	KIT STAFFA SUPPORTO SILENZIATORE INOX
307002502R	KIT STAFFA PORTA TARGA INOX
308284481R	KIT R.COR.EV.CARB.D50 MED. L=250 OM.9633
308284482R	KIT R.COR.SX EVO CAR D50 MEDL=250 OM9633
088284015R	KIT LAMELLA E RIVETTI OM.9633 014
205757OMR	KIT RIC COPPA LV-ONE MEDIA ORIZ.
307919801R	KIT TAPPO X OMOL. EVO2 N. 32BF GPSTY
308284711R	KIT COPPA POST.M.ORIZ.d.54 O6406+LUNG
409118R	KIT RIVESTIMENTO MED CARB 100X115 L=250
414205R	KIT RICAMBI LANA HT 800 Plus 850g
206721R	KIT RIC TARGHETTA LEOVINCE CARBONIO

<b>8287E</b>	BMW	F 650 GS (fits with original panniers)	2008-2012	Leovince LV ONE EVO - SLIP-ON - STAINLESS STEEL
	BMW	F 700 GS (fits with original panniers)	2013-2016	
	BMW	F 800 GS/ADVENTURE (fits with original panniers)	2008-2016	

**RICAMBI**

306958501R	KIT fascetta FM1 Factory Medio Verticale
308117202R	KIT SACCH COLL. FINALE BMW F650/800 GS
308117601R	KIT SACCH. MINUT. BMW F 800 '08
303949001R	KIT RIC MOLLA-GOMM. ANTIVIB. CORTA
308287482R	KIT R.COR SX EVO IN D54 MEDL=370 OM.0237
088288002R	KIT KAMELLE E RIVETTI OM.0237
3014008701R	KIT RICAMBIO COPPA POST. MEDIA VERT CARB
307677801R	KIT TAPPO X OMOL. EVO2 N. 32 BMW
308287711R	KIT COPPA POST.M.VERT.D.54 EV.2+LUNG
083980016R	KIT RIC RIVESTIMENTO VERT.DX MEDIO L=370
083980018R	KIT RIC RIVESTIMENTO VERT.SX MEDIO L=370
414205R	KIT RICAMBI LANA HT 800 Plus 850g

<b>8288E</b>	BMW	F 650 GS (fits with original panniers)	2008-2012	Leovince LV ONE EVO - SLIP-ON - CARBON FIBER
	BMW	F 700 GS (fits with original panniers)	2013-2016	
	BMW	F 800 GS/ADVENTURE (fits with original panniers)	2008-2016	

**RICAMBI**

306958501R	KIT fascetta FM1 Factory Medio Verticale
308117202R	KIT SACCH COLL. FINALE BMW F650/800 GS
308117601R	KIT SACCH. MINUT. BMW F 800 '08
303949001R	KIT RIC MOLLA-GOMM. ANTIVIB. CORTA
308288482R	KIT R.COR SX EVO CAR D54 MEDL=370 OM0237
085096014R	KIT LAMELLE E RIVET 0457 0237 0430 10410
3014008701R	KIT RICAMBIO COPPA POST. MEDIA VERT CARB
307677801R	KIT TAPPO X OMOL. EVO2 N. 32 BMW
308287711R	KIT COPPA POST.M.VERT.D.54 EV.2+LUNG

ART.	MARCA	MODELLO	TIPOLOGIA
		408541R KIT RIVESTIMENTO MED CARB 100X115 L=370	
		414205R KIT RICAMBI LANA HT 800 Plus 850g	
		206721R KIT RIC TARGHETTA LEOVINCE CARBONIO	
<b>8289E</b>	BMW	F 800 GT (fits with original panniers)	2013-2016 Leovince LV ONE EVO - SLIP-ON - STAINLESS STEEL
	BMW	F 800 R (fits with original panniers)	2009-2016
<b>RICAMBI</b>		307659501R KIT FASCETTA FM5 CARBONIO	
		308238202R KIT SACCH COLLETTORE BMW F 800 R	
		308238601R KIT SACCH MINUTERIA BMW F 800 R	
		303949001R KIT RIC MOLLA-GOMM. ANTIVIB. CORTA	
		304982002R KIT RIC MOLLA TRAZ.+TUBETTO MONTATO	
		308287482R KIT R.COR SX EVO IN D54 MEDL=370 OM.0237	
		088288002R KIT KAMELLE E RIVETTI OM.0237	
		3014008701R KIT RICAMBIO COPPA POST. MEDIA VERT CARB	
		307677801R KIT TAPPO X OMOL. EVO2 N. 32 BMW	
		308287711R KIT COPPA POST.M.VERT.D.54 EV.2+LUNG	
		083980016R KIT RIC RIVESTIMENTO VERT.DX MEDIO L=370	
		083980018R KIT RIC RIVESTIMENTO VERT.SX MEDIO L=370	
		414205R KIT RICAMBI LANA HT 800 Plus 850g	
<b>8290E</b>	BMW	F 800 GT (fits with original panniers)	2013-2016 Leovince LV ONE EVO - SLIP-ON - CARBON FIBER
	BMW	F 800 R (fits with original panniers)	2009-2016
<b>RICAMBI</b>		307659501R KIT FASCETTA FM5 CARBONIO	
		308238202R KIT SACCH COLLETTORE BMW F 800 R	
		308238601R KIT SACCH MINUTERIA BMW F 800 R	
		303949001R KIT RIC MOLLA-GOMM. ANTIVIB. CORTA	
		304982002R KIT RIC MOLLA TRAZ.+TUBETTO MONTATO	
		308288482R KIT R.COR SX EVO CAR D54 MEDL=370 OM0237	
		085096014R KIT LAMELLE E RIVET 0457 0237 0430 10410	
		3014008701R KIT RICAMBIO COPPA POST. MEDIA VERT CARB	
		307677801R KIT TAPPO X OMOL. EVO2 N. 32 BMW	
		308287711R KIT COPPA POST.M.VERT.D.54 EV.2+LUNG	
		408541R KIT RIVESTIMENTO MED CARB 100X115 L=370	
		414205R KIT RICAMBI LANA HT 800 Plus 850g	
		206721R KIT RIC TARGHETTA LEOVINCE CARBONIO	
<b>8291E</b>	BMW	R 1200 GS (fits with original panniers)	2010-2012 Leovince LV ONE EVO - SLIP-ON - STAINLESS STEEL
	BMW	R 1200 GS ADVENTURE (fits with original panniers)	2010-2012
<b>RICAMBI</b>		306960505R KIT FASCETTA FB1S CARBONIO	
		308263202R KIT RICAMBI COLLETTORE BMW R1200GS	
		300063530R KIT fascetta 63 Inox	
		308263681R KIT SACCH.MINUT BMW R 1200 GS'10	
		088263001R KIT CARTER CARBONIO BMW 1200GS	
		303949001R KIT RIC MOLLA-GOMM. ANTIVIB. CORTA	
		308291482R KIT R COR SX EV I R 54 BIG 0233/35 10400	
		088292004R KIT LAMELLE E RIVETTI OM.0233 0235 10400	
		3014000701R KIT RICAMBI COPPA POST.BIG VERTICALE CAR	
		307762801R KIT TAPPO X OMOL. EVO2 N. 32B GPSTY	
		307242711R KIT COPPA POST.FACT.VERT. D.54 EV.2	
		088291006R KIT RIC RIVESTIMENTO FACT.SX BIG L=370	
		414205R KIT RICAMBI LANA HT 800 Plus 850g	
<b>8293E</b>	YAMAHA	YZF 1000 R1	2009-2014 Leovince LV ONE EVO - 2 SLIP-ON - STAINLESS STEEL
<b>RICAMBI</b>		308180501R KIT fascetta FM7 Factory Medio Verticale	
		308175203R KIT SACCHETTO COLLETTORE N. 722 DX	
		300049530R KIT fascetta 49 Inox	
		308175204R KIT SACCHETTO COLLETTORE N. 723 SX	
		308175681R KIT SACCH.MINUT.YAMAHA 1000 R1'09	
		088175001R KIT CARTER CARBONIO X COL.DX R1'09	
		088180002R KIT CARTER CARBONIO X COL.SX R1'09	
		303949001R KIT RIC MOLLA-GOMM. ANTIVIB. CORTA	
		308410481R KIT R COR EV IN D54 MED L300 0457 10410	
		308410482R KIT R COR SX EV IN 54 ME L300 0457 10410	

ART.	MARCA	MODELLO	TIPOLOGIA
		088280002R KIT KAMELLE E RIVETTI OM.0457 10410 3014008701R KIT RICAMBIO COPPA POST. MEDIA VERT CARB 307762801R KIT TAPPO X OMOL. EVO2 N. 32B GPSTY 308287711R KIT COPPA POST.M.VERT.D.54 EV.2+LUNG 083710014R KIT RIC RIVESTIMENTO DX VERT MEDIO L=300 083710016R KIT RIC RIVESTIMENTO SX VERT. MEDI L=300 414205R KIT RICAMBI LANA HT 800 Plus 850g	
<b>8294E</b>	YAMAHA	YZF 1000 R1	2009-2014 Leovince LV ONE EVO - 2 SLIP-ON - CARBON FIBER
<b>RICAMBI</b>		308180501R KIT fascetta FM7 Factory Medio Verticale 308175203R KIT SACCHETTO COLLETTORE N. 722 DX 300049530R KIT fascetta 49 Inox 308175204R KIT SACCHETTO COLLETTORE N. 723 SX 308175681R KIT SACCH.MINUT.YAMAHA 1000 R1'09 088175001R KIT CARTER CARBONIO X COL.DX R1'09 088180002R KIT CARTER CARBONIO X COL.SX R1'09 303949001R KIT RIC MOLLA-GOMM. ANTIVIB. CORTA 308411481R KIT R COR EV CAR D54 MED L300 0457 10410 308411482R KIT R COR SX EV C 54 MED L300 0457 10410 088280002R KIT KAMELLE E RIVETTI OM.0457 10410 3014008701R KIT RICAMBIO COPPA POST. MEDIA VERT CARB 307762801R KIT TAPPO X OMOL. EVO2 N. 32B GPSTY 308287711R KIT COPPA POST.M.VERT.D.54 EV.2+LUNG 409117R KIT RIVESTIMENTO MED CARB 100X115 L=300 414205R KIT RICAMBI LANA HT 800 Plus 850g 206721R KIT RIC TARGHETTA LEOVINCE CARBONIO	
<b>8295E</b>	HONDA	CBF 600 N	2005-2011 Leovince LV ONE EVO - SLIP-ON - STAINLESS STEEL
	HONDA	CBF 600 S	2004-2012
<b>RICAMBI</b>		307659501R KIT FASCETTA FM5 CARBONIO 307136204R KIT SACCHETTO COLLETTORE N. 342 300053530R KIT fascetta 53 Inox 307136601R KIT SACCH MINUTERIA CBF 600 S 203531R KIT RIC BOCCOLA 50X42,5X30 LGR/F D135/03 304982002R KIT RIC MOLLA TRAZ.+TUBETTO MONTATO 307187501R KIT STAFFA ARRESTO CAVALLETTO CBF 600 308295481R KIT RIC.COR EVO IN D50MED L=370 OM.0231 088296002R KIT LAMELLE E RIVETTI OM.0231 3014008701R KIT RICAMBIO COPPA POST. MEDIA VERT CARB 307762801R KIT TAPPO X OMOL. EVO2 N. 32B GPSTY 308287711R KIT COPPA POST.M.VERT.D.54 EV.2+LUNG 083980016R KIT RIC RIVESTIMENTO VERT.DX MEDIO L=370 414205R KIT RICAMBI LANA HT 800 Plus 850g	
<b>8297E</b>	YAMAHA	FZ1	2006-2015 Leovince LV ONE - SLIP-ON - STAINLESS STEEL
	YAMAHA	FAZER/GT (fits with original center stand)	2006-2015
<b>RICAMBI</b>		307659501R KIT FASCETTA FM5 CARBONIO 307659202R KIT RICAMBIO SACC COLL FINALE FZ1 FAZER 300063530R KIT fascetta 63 Inox 307659601R KIT SACCH.MINUT.YAMAHA FZ1 '06 307659502R KIT STAFFA ARRESTO CAVALLETTO FZ1 303949001R KIT RIC MOLLA-GOMM. ANTIVIB. CORTA 308297481R KIT RIC COR EV IN 54 MED L300 0457 10410 088280002R KIT KAMELLE E RIVETTI OM.0457 10410 2057570MR KIT RIC COPPA LV-ONE MEDIA ORIZ. 307762801R KIT TAPPO X OMOL. EVO2 N. 32B GPSTY 308284711R KIT COPPA POST.M.ORIZ.d.54 O6406+LUNG 083710012R KIT RIC RIVESTIMENTO VER IN MED L=300mm 414205R KIT RICAMBI LANA HT 800 Plus 850g	
<b>8298E</b>	YAMAHA	FZ1	2006-2015 Leovince LV ONE - SLIP-ON - CARBON FIBER
	YAMAHA	FAZER/GT (fits with original center stand)	2006-2011
<b>RICAMBI</b>		307659501R KIT FASCETTA FM5 CARBONIO 307659202R KIT RICAMBIO SACC COLL FINALE FZ1 FAZER	

ART.	MARCA	MODELLO	TIPOLOGIA
------	-------	---------	-----------

300063530R	KIT fascetta 63 Inox
307659601R	KIT SACCH.MINUT.YAMAHA FZ1 '06
307659502R	KIT STAFFA ARRESTO CAVALLETTO FZ1
303949001R	KIT RIC MOLLA-GOMM. ANTIVIB. CORTA
308298481R	KIT RIC CO EVO CA 54 MED L300 0457 10410
088280002R	KIT KAMELLE E RIVETTI OM.0457 10410
205757OMR	KIT RIC COPPA LV-ONE MEDIA ORIZ.
307762801R	KIT TAPPO X OMOL. EVO2 N. 32B GPSTY
308284711R	KIT COPPA POST.M.ORIZ.d.54 O6406+LUNG
409117R	KIT RIVESTIMENTO MED CARB 100X115 L=300
414205R	KIT RICAMBI LANA HT 800 Plus 850g
206721R	KIT RIC TARGHETTA LEOVINCE CARBONIO

<b>8299E</b>	HUSQVARNA	701 ENDURO	2015-2016	Leovince	LV ONE EVO - SLIP-ON - STAINLESS STEEL
	HUSQVARNA	701 SUPERMOTO	2015-2016		
	HUSQVARNA	701 ENDURO	2017-2018		
	HUSQVARNA	701 SUPERMOTO	2017-2018		
	HUSQVARNA	690 ENDURO	2008-2011		
	HUSQVARNA	690 SMC	2008-2011		
	HUSQVARNA	690 ENDURO R	2009-2016		
	HUSQVARNA	690 SMC R	2012-2016		

<b>RICAMBI</b>	303692502R	KIT RICAMBIO STAFFA T2
	308134202R	KIT SACCHETTO COLLETTORE N.668 SX
	300053530R	KIT fascetta 53 Inox
	308134601R	KIT SACCH. MINUTERIA KTM 690 SMC '08
	303949001R	KIT RIC MOLLA-GOMM. ANTIVIB. CORTA
	308299482R	KIT RIC COR EVO IN D50 MED L=270 OM.0430
	088282002R	KIT LAMELLE E RIVETTI OM.0429 0430
	3014008701R	KIT RICAMBIO COPPA POST. MEDIA VERT CARB
	305432801R	KIT TAPPO X OMOL. EVO2 N. 32C GPSTY
	308287711R	KIT COPPA POST.M.VERT.D.54 EV.2+LUNG
	088406006R	KIT RIC RIVESTIMENTO FACT.SX MEDIO L=270
	414205R	KIT RICAMBI LANA HT 800 Plus 850g

<b>8400E</b>	HONDA	CB 600 F HORNET	2007-2013	Leovince	LV ONE EVO - SLIP-ON - STAINLESS STEEL
	HONDA	CBR 600 F	2011-2013		

<b>RICAMBI</b>	306958505R	KIT FASCETTA FM1S CARB. FACT. MED
	307997202R	KIT SACCHETTO COLLETTORE N. 627
	300045530R	KIT fascetta 45 Inox
	307997601R	KIT SACCH.MINUT.HONDA HORNET '07
	303949001R	KIT RIC MOLLA-GOMM. ANTIVIB. CORTA
	308410481R	KIT R COR EV IN D54 MED L300 0457 10410
	088280002R	KIT KAMELLE E RIVETTI OM.0457 10410
	3014008701R	KIT RICAMBIO COPPA POST. MEDIA VERT CARB
	307762801R	KIT TAPPO X OMOL. EVO2 N. 32B GPSTY
	308287711R	KIT COPPA POST.M.VERT.D.54 EV.2+LUNG
	083710014R	KIT RIC RIVESTIMENTO DX VERT MEDIO L=300
	414205R	KIT RICAMBI LANA HT 800 Plus 850g

<b>8401E</b>	HONDA	CB 600 F HORNET	2007-2013	Leovince	LV ONE EVO - SLIP-ON - CARBON FIBER
	HONDA	CBR 600 F	2011-2013		

<b>RICAMBI</b>	306958505R	KIT FASCETTA FM1S CARB. FACT. MED
	307997202R	KIT SACCHETTO COLLETTORE N. 627
	300045530R	KIT fascetta 45 Inox
	307997601R	KIT SACCH.MINUT.HONDA HORNET '07
	303949001R	KIT RIC MOLLA-GOMM. ANTIVIB. CORTA
	308411481R	KIT R COR EV CAR D54 MED L300 0457 10410
	088280002R	KIT KAMELLE E RIVETTI OM.0457 10410
	3014008701R	KIT RICAMBIO COPPA POST. MEDIA VERT CARB
	307762801R	KIT TAPPO X OMOL. EVO2 N. 32B GPSTY
	308287711R	KIT COPPA POST.M.VERT.D.54 EV.2+LUNG
	409117R	KIT RIVESTIMENTO MED CARB 100X115 L=300
	414205R	KIT RICAMBI LANA HT 800 Plus 850g
	206721R	KIT RIC TARGHETTA LEOVINCE CARBONIO



ART.	MARCA	MODELLO		TIPOLOGIA
8402E	HONDA	XL 700 V TRANSALP (fits with original panniers)	2008-2013	Leovince LV ONE EVO - SLIP-ON - STAINLESS STEEL
RICAMBI	306958501R	KIT fascetta FM1 Factory Medio Verticale		
	308403202R	KIT SACCHETTO COLLETTORE N. 850 HONDA XL		
	300045530R	KIT fascetta 45 Inox		
	308403601R	KIT SACCH. MINUT.TRANSALP 700 '08		
	303949001R	KIT RIC MOLLA-GOMM. ANTIVIB. CORTA		
	308402481R	KIT R COR EV I D50 ME L300 0429/30 10394		
	088282004R	KIT LAMELLE E RIVETTI OM.0430 0457 10394		
	3014008701R	KIT RICAMBIO COPPA POST. MEDIA VERT CARB		
	307762801R	KIT TAPPO X OMOL. EVO2 N. 32B GPSTY		
	308287711R	KIT COPPA POST.M.VERT.D.54 EV.2+LUNG		
	083710014R	KIT RIC RIVESTIMENTO DX VERT MEDIO L=300		
	414205R	KIT RICAMBI LANA HT 800 Plus 850g		
8404E	HONDA	CBF 1000/ST	2010-2013	Leovince LV ONE EVO - SLIP-ON - STAINLESS STEEL
RICAMBI	306958501R	KIT fascetta FM1 Factory Medio Verticale		
	308405202R	KIT SACCHETTO COLLETTORE N.861		
	300051530R	KIT fascetta 51 Inox		
	308405601R	KIT SACCH.MINUT.X HONDA CBF 1000 '10		
	303949001R	KIT RIC MOLLA-GOMM. ANTIVIB. CORTA		
	308295481R	KIT RIC.COR EVO IN D50MED L=370 OM.0231		
	088296002R	KIT LAMELLE E RIVETTI OM.0231		
	3014008701R	KIT RICAMBIO COPPA POST. MEDIA VERT CARB		
	307762801R	KIT TAPPO X OMOL. EVO2 N. 32B GPSTY		
	308287711R	KIT COPPA POST.M.VERT.D.54 EV.2+LUNG		
	083980016R	KIT RIC RIVESTIMENTO VERT.DX MEDIO L=370		
	414205R	KIT RICAMBI LANA HT 800 Plus 850g		
8405E	HONDA	CBF 1000/ST	2010-2013	Leovince LV ONE EVO - SLIP-ON - CARBON FIBER
RICAMBI	306958501R	KIT fascetta FM1 Factory Medio Verticale		
	308405202R	KIT SACCHETTO COLLETTORE N.861		
	300051530R	KIT fascetta 51 Inox		
	308405601R	KIT SACCH.MINUT.X HONDA CBF 1000 '10		
	303949001R	KIT RIC MOLLA-GOMM. ANTIVIB. CORTA		
	308296481R	KIT R COR EVO CARB D50 MED L=370 OM.0231		
	085096016R	KIT LAMELLE E RIVETTI OM.0231 014		
	3014008701R	KIT RICAMBIO COPPA POST. MEDIA VERT CARB		
	307762801R	KIT TAPPO X OMOL. EVO2 N. 32B GPSTY		
	308287711R	KIT COPPA POST.M.VERT.D.54 EV.2+LUNG		
	408541R	KIT RIVESTIMENTO MED CARB 100X115 L=370		
	414205R	KIT RICAMBI LANA HT 800 Plus 850g		
	206721R	KIT RIC TARGHETTA LEOVINCE CARBONIO		
8406E	KAWASAKI	NINJA 250 R	2008-2012	Leovince LV ONE EVO - SLIP-ON - STAINLESS STEEL
RICAMBI	306958501R	KIT fascetta FM1 Factory Medio Verticale		
	307919801R	KIT TAPPO X OMOL. EVO2 N. 32BF GPSTY		
	308407202R	KIT SACCHETTO COLLETTORE N. 851 DX		
	300041530R	KIT fascetta 41 Inox		
	308407601R	KIT SACCH.MINUT.X KAW. NINJA 250 '08		
	203529R	KIT RIC BOCCOLA 40X35X30 LGR/F D.133/03		
	303949001R	KIT RIC MOLLA-GOMM. ANTIVIB. CORTA		
	308406481R	KIT R COR EVO IN D50 MED L=270 OM.0430		
	088282002R	KIT LAMELLE E RIVETTI OM.0429 0430		
	3014008701R	KIT RICAMBIO COPPA POST. MEDIA VERT CARB		
	204790R	KIT RIC GOMMINO COPPE CARBONIO D.007/06		
	307762801R	KIT TAPPO X OMOL. EVO2 N. 32B GPSTY		
	308287711R	KIT COPPA POST.M.VERT.D.54 EV.2+LUNG		
	088406004R	KIT RIC RIVESTIMENTO FACT.DX MEDIO L=270		
	414205R	KIT RICAMBI LANA HT 800 Plus 850g		
8410E	KAWASAKI	Z 750	2007-2014	Leovince LV ONE EVO - SLIP-ON - STAINLESS STEEL
	KAWASAKI	Z 750 R	2011-2014	
RICAMBI	307572505R	KIT fascetta FM4S Fact. Medio		

ART.	MARCA	MODELLO	TIPOLOGIA
		307915206R KIT SACCHETTO COL 517C KAWASAKI Z 750'07	
		307915601R KIT SACCH.MIN.XKAWASAK Z-750 '07	
		303949001R KIT RIC MOLLA-GOMM. ANTIVIB. CORTA	
		308410481R KIT R COR EV IN D54 MED L300 0457 10410	
		088280002R KIT KAMELLE E RIVETTI OM.0457 10410	
		3014008701R KIT RICAMBIO COPPA POST. MEDIA VERT CARB	
		307762801R KIT TAPPO X OMOL. EVO2 N. 32B GPSTY	
		308287711R KIT COPPA POST.M.VERT.D.54 EV.2+LUNG	
		083710014R KIT RIC RIVESTIMENTO DX VERT MEDIO L=300	
		414205R KIT RICAMBI LANA HT 800 Plus 850g	
<b>8411E</b>	KAWASAKI	Z 750	2007-2014 Leovince LV ONE EVO - SLIP-ON - CARBON FIBER
	KAWASAKI	Z 750 R	2011-2014
<b>RICAMBI</b>		307572505R KIT fascetta FM4S Fact. Medio	
		307915206R KIT SACCHETTO COL 517C KAWASAKI Z 750'07	
		307915601R KIT SACCH.MIN.XKAWASAK Z-750 '07	
		303949001R KIT RIC MOLLA-GOMM. ANTIVIB. CORTA	
		308411481R KIT R COR EV CAR D54 MED L300 0457 10410	
		088280002R KIT KAMELLE E RIVETTI OM.0457 10410	
		3014008701R KIT RICAMBIO COPPA POST. MEDIA VERT CARB	
		307762801R KIT TAPPO X OMOL. EVO2 N. 32B GPSTY	
		308287711R KIT COPPA POST.M.VERT.D.54 EV.2+LUNG	
		409117R KIT RIVESTIMENTO MED CARB 100X115 L=300	
		414205R KIT RICAMBI LANA HT 800 Plus 850g	
		206721R KIT RIC TARGHETTA LEOVINCE CARBONIO	
<b>8412E</b>	KAWASAKI	Z 1000	2010-2016 Leovince LV ONE EVO - 2 SLIP-ON - STAINLESS STEEL
<b>RICAMBI</b>		307572505R KIT fascetta FM4S Fact. Medio	
		308249203R KIT RICAMBIO COLLETTORE N°790 DX Z1000	
		308249204R KIT SACCHETTO COLLETTORE N. 791 SX	
		308249601R KIT SACCH.MINUTERIA Z1000 ie10 FAC	
		303949001R KIT RIC MOLLA-GOMM. ANTIVIB. CORTA	
		308412481R KIT R COR EV IN D54 MED L=250 OM.9634	
		308412482R KIT R COR SX EV IN D54 MED L=250 OM.9634	
		088283006R KIT RIC RIVESTIMENTO FACT.SX MEDIO L=250	
		088413002R KIT LAMELLE E RIVETTI OM.9634	
		3014008701R KIT RICAMBIO COPPA POST. MEDIA VERT CARB	
		307677801R KIT TAPPO X OMOL. EVO2 N. 32 BMW	
		308287711R KIT COPPA POST.M.VERT.D.54 EV.2+LUNG	
		088283004R KIT RIC RIVESTIMENTO FACT.DX MEDIO L=250	
		414205R KIT RICAMBI LANA HT 800 Plus 850g	
<b>8413E</b>	KAWASAKI	Z 1000	2010-2016 Leovince LV ONE EVO - 2 SLIP-ON - CARBON FIBER
<b>RICAMBI</b>		307572505R KIT fascetta FM4S Fact. Medio	
		308249203R KIT RICAMBIO COLLETTORE N°790 DX Z1000	
		308249204R KIT SACCHETTO COLLETTORE N. 791 SX	
		308249601R KIT SACCH.MINUTERIA Z1000 ie10 FAC	
		303949001R KIT RIC MOLLA-GOMM. ANTIVIB. CORTA	
		308413481R KIT R COR EV CAR D54 MED L=250 OM.9634	
		308413482R KIT R CO SX EV CARB D54 MED L=250 OM9634	
		085096018R KIT LAMELLE E RIVETTI OM.9634 014	
		3014008701R KIT RICAMBIO COPPA POST. MEDIA VERT CARB	
		307677801R KIT TAPPO X OMOL. EVO2 N. 32 BMW	
		308287711R KIT COPPA POST.M.VERT.D.54 EV.2+LUNG	
		409118R KIT RIVESTIMENTO MED CARB 100X115 L=250	
		414205R KIT RICAMBI LANA HT 800 Plus 850g	
		206721R KIT RIC TARGHETTA LEOVINCE CARBONIO	
<b>8414E</b>	KTM	950 SM SUPERMOTO	2005-2008 Leovince LV ONE EVO - 2 SLIP-ON - STAINLESS STEEL
	KTM	990 SM SUPERMOTO	2008-2010
	KTM	990 SM R SUPERMOTO R	2009-2012
<b>RICAMBI</b>		306958501R KIT fascetta FM1 Factory Medio Verticale	
		307536204R KIT SACCHETTO BIFORCA N° 387	

ART.	MARCA	MODELLO	TIPOLOGIA
		307545203R KIT SACCHETTO COLLETTORE N°408 DX 307545204R KIT SACCHETTO COLLETTORE N°409 SX 307545601R KIT SACCH MINUTERIA SUPERMOTO 950 303949001R KIT RIC MOLLA-GOMM. ANTIVIB. CORTA 308287481R KIT RIC COR EVO IN D54 MED L=370 OM.0237 308287482R KIT R.COR SX EVO IN D54 MEDL=370 OM.0237 088288002R KIT KAMELLE E RIVETTI OM.0237 3014008701R KIT RICAMBIO COPPA POST. MEDIA VERT CARB 307677801R KIT TAPPO X OMOL. EVO2 N. 32 BMW 308287711R KIT COPPA POST.M.VERT.D.54 EV.2+LUNG 083980016R KIT RIC RIVESTIMENTO VERT.DX MEDIO L=370 414205R KIT RICAMBI LANA HT 800 Plus 850g 083980018R KIT RIC RIVESTIMENTO VERT.SX MEDIO L=370	
<b>8415E</b>	SUZUKI	GSF 650 BANDIT/S	2007-2015 Leovince LV ONE EVO - SLIP-ON - STAINLESS STEEL
		GSX-F 650	2008-2015
<b>RICAMBI</b>		307659501R KIT FASCETTA FM5 CARBONIO 308228202R KIT SACCHETTO COLLETTORE N. 751 DX 300057530R KIT fascetta 57 Inox 308416601R KIT SACCH MINUTERIA BANDIT 650 i.e.'09 303949001R KIT RIC MOLLA-GOMM. ANTIVIB. CORTA 308287481R KIT RIC COR EVO IN D54 MED L=370 OM.0237 088288002R KIT KAMELLE E RIVETTI OM.0237 3014008701R KIT RICAMBIO COPPA POST. MEDIA VERT CARB 307677801R KIT TAPPO X OMOL. EVO2 N. 32 BMW 308287711R KIT COPPA POST.M.VERT.D.54 EV.2+LUNG 083980016R KIT RIC RIVESTIMENTO VERT.DX MEDIO L=370 414205R KIT RICAMBI LANA HT 800 Plus 850g	
<b>8416E</b>	SUZUKI	GSF 650 BANDIT/S	2007-2015 Leovince LV ONE EVO - SLIP-ON - CARBON FIBER
	SUZUKI	GSX-F 650	2008-2015
<b>RICAMBI</b>		307659501R KIT FASCETTA FM5 CARBONIO 308228202R KIT SACCHETTO COLLETTORE N. 751 DX 300057530R KIT fascetta 57 Inox 308416601R KIT SACCH MINUTERIA BANDIT 650 i.e.'09 303949001R KIT RIC MOLLA-GOMM. ANTIVIB. CORTA 308288481R KIT R.COR.EV CAR D54 MED L-370 OM.0237 085096014R KIT LAMELLE E RIVET 0457 0237 0430 10410 3014008701R KIT RICAMBIO COPPA POST. MEDIA VERT CARB 307677801R KIT TAPPO X OMOL. EVO2 N. 32 BMW 308287711R KIT COPPA POST.M.VERT.D.54 EV.2+LUNG 408541R KIT RIVESTIMENTO MED CARB 100X115 L=370 414205R KIT RICAMBI LANA HT 800 Plus 850g 206721R KIT RIC TARGHETTA LEOVINCE CARBONIO	
<b>8417E</b>	SUZUKI	BANDIT 1250 (fits with original panniers)	2007-2016 Leovince LV ONE EVO - SLIP-ON - STAINLESS STEEL
	SUZUKI	GSX 1250 FA (fits with original panniers)	2010-2016
<b>RICAMBI</b>		307659501R KIT FASCETTA FM5 CARBONIO 307798202R KIT SACCHETTO COLLETTORE N° 509 DX 300057530R KIT fascetta 57 Inox 307798601R KIT SACCH.MIN.BANDIT 1250 i.e.'07 303949001R KIT RIC MOLLA-GOMM. ANTIVIB. CORTA 308287481R KIT RIC COR EVO IN D54 MED L=370 OM.0237 088288002R KIT KAMELLE E RIVETTI OM.0237 3014008701R KIT RICAMBIO COPPA POST. MEDIA VERT CARB 307677801R KIT TAPPO X OMOL. EVO2 N. 32 BMW 308287711R KIT COPPA POST.M.VERT.D.54 EV.2+LUNG 083980016R KIT RIC RIVESTIMENTO VERT.DX MEDIO L=370 414205R KIT RICAMBI LANA HT 800 Plus 850g	
<b>8418E</b>	SUZUKI	BANDIT 1250 (fits with original panniers)	2007-2016 Leovince LV ONE EVO - SLIP-ON - CARBON FIBER
	SUZUKI	GSX 1250 FA (fits with original panniers)	2010-2016
<b>RICAMBI</b>		307659501R KIT FASCETTA FM5 CARBONIO 307798202R KIT SACCHETTO COLLETTORE N° 509 DX	

ART.	MARCA	MODELLO	TIPOLOGIA
		300057530R KIT fascetta 57 Inox 307798601R KIT SACCH.MIN.BANDIT 1250 i.e.'07 303949001R KIT RIC MOLLA-GOMM. ANTIVIB. CORTA 308288481R KIT R.COR.EV CAR D54 MED L-370 OM.0237 085096014R KIT LAMELLE E RIVET 0457 0237 0430 10410 3014008701R KIT RICAMBIO COPPA POST. MEDIA VERT CARB 307677801R KIT TAPPO X OMOL. EVO2 N. 32 BMW 308287711R KIT COPPA POST.M.VERT.D.54 EV.2+LUNG 408541R KIT RIVESTIMENTO MED CARB 100X115 L=370 414205R KIT RICAMBI LANA HT 800 Plus 850g 206721R KIT RIC TARGHETTA LEOVINCE CARBONIO	
<b>8421S</b>	KAWASAKI	ZX-10R NINJA	2011-2015 Leovince FACTORY S - SLIP-ON - STAINLESS STEEL
RICAMBI		308448501R KIT fascetta FR2 CARBONIO MEDIA 308420202R KIT SACCHETTO COLLETTORE N° 876 DX 308420681R KIT SACCH MINUTERIA ZX-10R NINJA '11 088420008R KIT CARTER CARBONIO ZX10R NINJA '11 303949001R KIT RIC MOLLA-GOMM. ANTIVIB. CORTA 308421481R KIT R CO DX IN C D54 L=270 10057/8 10395 088421026R KIT LAMELLE E RIVETTI OM.10057-58 10395 308420701R KIT RICAMBIO COPPA POST. DX FACT CARB 308421801R KIT TAPPO X OMOL. EVO2 N. 52 FACTORY -R 308421741R KIT COPPA POST.DX VERT. FACTORY-R Ø50 088421046R KIT RIC RIVESTIMENTO FACTORY INOX L=270 416797R KIT RICAMBIO LANA FACTORY L=270	
<b>8422E</b>	YAMAHA	FZ6-S 600/FAZER	2004-2006 Leovince LV ONE - 2 SLIP-ON - STAINLESS STEEL
RICAMBI		306997501R KIT fascetta FM2 Factoy Medio Orizontale 307002205R KIT SACCHETTO COLLETTORE N° 327 300049530R KIT fascetta 49 Inox 308284203R KIT SACCHETTO COLLETTORE N° 848 DX 308284204R KIT SACCHETTO COLLETTORE N. 857 300053530R KIT fascetta 53 Inox 308284681R KIT RICAMBI MINUTERIA YAMAHA FZ6 303949001R KIT RIC MOLLA-GOMM. ANTIVIB. CORTA 304982002R KIT RIC MOLLA TRAZ.+TUBETTO MONTATO 307002501R KIT STAFFA SUPPORTO SILENZIATORE INOX 307002502R KIT STAFFA PORTA TARGA INOX 308283481R KIT R. COR.EVO IN D.50MEDIO L=250OM.9633 308283482R KIT R. COR SX EVO IN D.50MED L=500M.9633 088284014R KIT LAMELLE E RIVETTI OM.9633 2057570MR KIT RIC COPPA LV-ONE MEDIA ORIZ. 307919801R KIT TAPPO X OMOL. EVO2 N. 32BF GPSTY 308284711R KIT COPPA POST.M.ORIZ.d.54 O6406+LUNG 088283004R KIT RIC RIVESTIMENTO FACT.DX MEDIO L=250 088283006R KIT RIC RIVESTIMENTO FACT.SX MEDIO L=250 414205R KIT RICAMBI LANA HT 800 Plus 850g	
<b>8424E</b>	HONDA	XRV 750 AFRICA TWIN	1995-2005 Leovince LV ONE EVO - SLIP-ON - STAINLESS STEEL
RICAMBI		306960505R KIT FASCETTA FB1S CARBONIO 308425202R KIT SACCHETTO COLLETTORE N. 853 300045530R KIT fascetta 45 Inox 308425601R KIT RICAMBIO MINUTERIA XRV 750 303949001R KIT RIC MOLLA-GOMM. ANTIVIB. CORTA 308424481R KIT R COR EV IN RETE D50 BIG 0230 10399 088425010R KIT LAMELLE E RIVETTI OM.0230 10399 3014000701R KIT RICAMBI COPPA POST.BIG VERTICALE CAR 307762801R KIT TAPPO X OMOL. EVO2 N. 32B GPSTY 307242711R KIT COPPA POST.FACT.VERT. D.54 EV.2 088291004R KIT RIC RIVESTIMENTO FACT.DX BIG L=370 414205R KIT RICAMBI LANA HT 800 Plus 850g	
<b>8430E</b>	KTM	950 LC8 ADVENTURE S	2003-2005 Leovince LV ONE EVO - 2 SLIP-ON - STAINLESS STEEL
	KTM	990 LC8 ADVENTURE	2006-2012
	KTM	990 LC8 ADVENTURE R	2009-2012

ART.	MARCA	MODELLO	TIPOLOGIA
RICAMBI	306960501R	KIT fascetta FB1 CARBONIO LV ONE EVO BIG	
	308431203R	KIT SACCHETTO COLLETTORE N. 859	
	300045530R	KIT fascetta 45 Inox	
	308431204R	KIT SACCHETTO COLLETTORE N. 860	
	300053530R	KIT fascetta 53 Inox	
	308431601R	KIT SACCH. MINUT. X KTM LC8 '10	
	304982002R	KIT RIC MOLLA TRAZ.+TUBETTO MONTATO	
	308424481R	KIT R COR EV IN RETE D50 BIG 0230 10399	
	308424482R	KIT R COR SX EV IN RE D50 BIG 0230 10399	
	088425010R	KIT LAMELLE E RIVETTI OM.0230 10399	
	3014000701R	KIT RICAMBI COPPA POST.BIG VERTICALE CAR	
	307762801R	KIT TAPPO X OMOL. EVO2 N. 32B GPSTY	
	307242711R	KIT COPPA POST.FACT.VERT. D.54 EV.2	
	088291006R	KIT RIC RIVESTIMENTO FACT.SX BIG L=370	
	414205R	KIT RICAMBI LANA HT 800 Plus 850g	
8438S	APRILIA	RSV4 FACTORY APRC SE	2011-2012 Leovince FACTORY S - SLIP-ON - CARBON FIBER
	APRILIA	RSV4 FACTORY	2009-2011
	APRILIA	RSV4	2009-2015
	APRILIA	RSV4 R	2009-2011
	APRILIA	TUONO V4 R/APRC	2009-2015
RICAMBI	308476501R	KIT fascetta FR1 CARBONIO GRANDE	
	308438202R	KIT SACCHETTO COL.873 APR. RSV4 '10	
	300057530R	KIT fascetta 57 Inox	
	308438681R	KIT SACCH. MINUT.RSV4 '09/'10	
	088174002R	KIT STAFFA CARBONIO DX DI SOSTEGNO	
	303949001R	KIT RIC MOLLA-GOMM. ANTIVIB. CORTA	
	308420481R	KIT R CO DX CAR D54 L=270 10057/8 10395	
	088421026R	KIT LAMELLE E RIVETTI OM.10057-58 10395	
	308420701R	KIT RICAMBIO COPPA POST. DX FACT CARB	
	308421801R	KIT TAPPO X OMOL. EVO2 N. 52 FACTORY -R	
	308421741R	KIT COPPA POST.DX VERT. FACTORY-R Ø50	
	088420002R	KIT RIC RIVESTIMENTO FACT 270mm CARB	
	416797R	KIT RICAMBIO LANA FACTORY L=270	
206721R	KIT RIC TARGHETTA LEOVINCE CARBONIO		
8439S	APRILIA	RSV4 FACTORY APRC SE	2011-2012 Leovince FACTORY S - SLIP-ON - STAINLESS STEEL
	APRILIA	RSV4 FACTORY	2009-2011
	APRILIA	RSV4	2009-2015
	APRILIA	RSV4 R	2009-2011
	APRILIA	TUONO V4 R/APRC	2009-2015
RICAMBI	308476501R	KIT fascetta FR1 CARBONIO GRANDE	
	308438202R	KIT SACCHETTO COL.873 APR. RSV4 '10	
	300057530R	KIT fascetta 57 Inox	
	308438681R	KIT SACCH. MINUT.RSV4 '09/'10	
	088174002R	KIT STAFFA CARBONIO DX DI SOSTEGNO	
	303949001R	KIT RIC MOLLA-GOMM. ANTIVIB. CORTA	
	308421481R	KIT R CO DX IN C D54 L=270 10057/8 10395	
	088421026R	KIT LAMELLE E RIVETTI OM.10057-58 10395	
	308420701R	KIT RICAMBIO COPPA POST. DX FACT CARB	
	308421801R	KIT TAPPO X OMOL. EVO2 N. 52 FACTORY -R	
	308421741R	KIT COPPA POST.DX VERT. FACTORY-R Ø50	
	088421046R	KIT RIC RIVESTIMENTO FACTORY INOX L=270	
	416797R	KIT RICAMBIO LANA FACTORY L=270	
8444S	HONDA	CBR 1000 RR/ABS	2008-2012 Leovince FACTORY S - SLIP-ON - CARBON FIBER
	HONDA	CBR 1000 RR/ABS (US model only)	2008-2016
RICAMBI	308444501R	KIT fascetta FR3 CARBONIO PICCOLA	
	308444202R	KIT SACCHETTO COLLETTORE N.886	
	300051530R	KIT fascetta 51 Inox	
	308444601R	KIT RICAMBI MINUT. CBR 1000 RR	
	5682	KIT TAPPO SONDA LAMBDA M18 BASE + GUARN	
	303949001R	KIT RIC MOLLA-GOMM. ANTIVIB. CORTA	
	308420481R	KIT R CO DX CAR D54 L=270 10057/8 10395	
	088421026R	KIT LAMELLE E RIVETTI OM.10057-58 10395	

ART.	MARCA	MODELLO		TIPOLOGIA
		308420701R	KIT RICAMBIO COPPA POST. DX FACT CARB	
		308421801R	KIT TAPPO X OMOL. EVO2 N. 52 FACTORY -R	
		308421741R	KIT COPPA POST.DX VERT. FACTORY-R Ø50	
		088420002R	KIT RIC RIVESTIMENTO FACT 270mm CARB	
		416797R	KIT RICAMBIO LANA FACTORY L=270	
		206721R	KIT RIC TARGHETTA LEOVINCE CARBONIO	
<b>8445S</b>	HONDA	CBR 1000 RR/ABS	2008-2012	Leovince FACTORY S - SLIP-ON - STAINLESS STEEL
	HONDA	CBR 1000 RR/ABS (US model only)	2008-2016	
<b>RICAMBI</b>		308444501R	KIT fascetta FR3 CARBONIO PICCOLA	
		308444202R	KIT SACCHETTO COLLETTORE N.886	
		300051530R	KIT fascetta 51 Inox	
		308444601R	KIT RICAMBI MINUT. CBR 1000 RR	
		5682	KIT TAPPO SONDA LAMBDA M18 BASE + GUARN	
		303949001R	KIT RIC MOLLA-GOMM. ANTIVIB. CORTA	
		308421481R	KIT R CO DX IN C D54 L=270 10057/8 10395	
		088421026R	KIT LAMELLE E RIVETTI OM.10057-58 10395	
		308420701R	KIT RICAMBIO COPPA POST. DX FACT CARB	
		308421801R	KIT TAPPO X OMOL. EVO2 N. 52 FACTORY -R	
		308421741R	KIT COPPA POST.DX VERT. FACTORY-R Ø50	
		088421046R	KIT RIC RIVESTIMENTO FACTORY INOX L=270	
		416797R	KIT RICAMBIO LANA FACTORY L=270	
<b>8471S</b>	BMW	S 1000 RR	2009-2014	Leovince FACTORY S - FULL SYSTEM 4/2/1 - CARBON FIBER
<b>RICAMBI</b>		308476501R	KIT fascetta FR1 CARBONIO GRANDE	
		308448501R	KIT fascetta FR2 CARBONIO MEDIA	
		308247208R	KIT SACCHETTO COLLET. PRIM. BMW S1000 RR	
		205670R	KIT RIC FLANGIA INOX 150 A DIS.006/10	
		205669R	KIT RIC BOCCOLA INOX 51X36X23 D.005/10	
		308247209R	KIT SACCHETTO COLLETTORE SEC. BMW S 1000	
		308471202R	KIT SAC BIFORCAZIONE FIN. BMW S1000RR	
		308471681R	KIT RIC SAC.MIN. BMW S1000 RR '10	
		088247004R	KIT STAFFA CARBONIO a "V" BMW S1000 RR	
		5682	KIT TAPPO SONDA LAMBDA M18 BASE + GUARN	
		303949001R	KIT RIC MOLLA-GOMM. ANTIVIB. CORTA	
		308471481R	KIT R CO DX CAR CON D60 L=270 OM10059-60	
		088421020R	KIT LAMELLE E RIVETTI OM. 10059-60	
		308420701R	KIT RICAMBIO COPPA POST. DX FACT CARB	
		308421801R	KIT TAPPO X OMOL. EVO2 N. 52 FACTORY -R	
		308421741R	KIT COPPA POST.DX VERT. FACTORY-R Ø50	
		088420002R	KIT RIC RIVESTIMENTO FACT 270mm CARB	
		416797R	KIT RICAMBIO LANA FACTORY L=270	
		206721R	KIT RIC TARGHETTA LEOVINCE CARBONIO	
<b>8472S</b>	BMW	S 1000 RR	2009-2014	Leovince FACTORY S - FULL SYSTEM 4/2/1 - STAINLESS STEEL
<b>RICAMBI</b>		308476501R	KIT fascetta FR1 CARBONIO GRANDE	
		308448501R	KIT fascetta FR2 CARBONIO MEDIA	
		308247208R	KIT SACCHETTO COLLET. PRIM. BMW S1000 RR	
		205670R	KIT RIC FLANGIA INOX 150 A DIS.006/10	
		205669R	KIT RIC BOCCOLA INOX 51X36X23 D.005/10	
		308247209R	KIT SACCHETTO COLLETTORE SEC. BMW S 1000	
		308471202R	KIT SAC BIFORCAZIONE FIN. BMW S1000RR	
		308471681R	KIT RIC SAC.MIN. BMW S1000 RR '10	
		088247004R	KIT STAFFA CARBONIO a "V" BMW S1000 RR	
		5682	KIT TAPPO SONDA LAMBDA M18 BASE + GUARN	
		303949001R	KIT RIC MOLLA-GOMM. ANTIVIB. CORTA	
		308472481R	KIT R COR DX IN CON D60 L=270 OM10059-60	
		088421020R	KIT LAMELLE E RIVETTI OM. 10059-60	
		308420701R	KIT RICAMBIO COPPA POST. DX FACT CARB	
		308421801R	KIT TAPPO X OMOL. EVO2 N. 52 FACTORY -R	
		308421741R	KIT COPPA POST.DX VERT. FACTORY-R Ø50	
		088421046R	KIT RIC RIVESTIMENTO FACTORY INOX L=270	
		416797R	KIT RICAMBIO LANA FACTORY L=270	

ART.	MARCA	MODELLO		TIPOLOGIA
8482S	YAMAHA	YZF-R6	2006-2016	Leovince FACTORY S - FULL SYSTEM 4/2/1 - CARBON FIBER
	YAMAHA	YZF-R6 (US model only)	2017-2018	
RICAMBI	308448501R	KIT fascetta FR2 CARBONIO MEDIA		
	308241206R	KIT SACCHETTO COL.PRIMARI X R6 '10		
	204448R	KIT RIC FLANGIA INOX 46 D DIS.086/04		
	204851R	KIT RIC BOCCHETTONE INOX DIS. 060/06		
	308241207R	KIT SACCHETTO COL.SECOND.X R6 '10		
	308482202R	KIT SACCHETTO COLLETTORE BIFORC. FIN. R6		
	308482601R	KIT SACCH MINUTERIA YAMAHA R6		
	5684	KIT TAPPO SONDA LAMBDA M12 BASE + GUARN		
	303949001R	KIT RIC MOLLA-GOMM. ANTIVIB. CORTA		
	308420481R	KIT R CO DX CAR D54 L=270 10057/8 10395		
	088421026R	KIT LAMELLE E RIVETTI OM.10057-58 10395		
	308420701R	KIT RICAMBIO COPPA POST. DX FACT CARB		
	308421801R	KIT TAPPO X OMOL. EVO2 N. 52 FACTORY -R		
	308421741R	KIT COPPA POST.DX VERT. FACTORY-R Ø50		
	088420002R	KIT RIC RIVESTIMENTO FACT 270mm CARB		
	416797R	KIT RICAMBIO LANA FACTORY L=270		
	206721R	KIT RIC TARGHETTA LEOVINCE CARBONIO		
8483S	YAMAHA	YZF-R6	2006-2016	Leovince FACTORY S - FULL SYSTEM 4/2/1 - STAINLESS STEEL
	YAMAHA	YZF-R6 (US model only)	2017-2018	
RICAMBI	308448501R	KIT fascetta FR2 CARBONIO MEDIA		
	308241206R	KIT SACCHETTO COL.PRIMARI X R6 '10		
	204448R	KIT RIC FLANGIA INOX 46 D DIS.086/04		
	204851R	KIT RIC BOCCHETTONE INOX DIS. 060/06		
	308241207R	KIT SACCHETTO COL.SECOND.X R6 '10		
	308482202R	KIT SACCHETTO COLLETTORE BIFORC. FIN. R6		
	308482601R	KIT SACCH MINUTERIA YAMAHA R6		
	5684	KIT TAPPO SONDA LAMBDA M12 BASE + GUARN		
	303949001R	KIT RIC MOLLA-GOMM. ANTIVIB. CORTA		
	308421481R	KIT R CO DX IN C D54 L=270 10057/8 10395		
	088421026R	KIT LAMELLE E RIVETTI OM.10057-58 10395		
	308420701R	KIT RICAMBIO COPPA POST. DX FACT CARB		
	308421801R	KIT TAPPO X OMOL. EVO2 N. 52 FACTORY -R		
	308421741R	KIT COPPA POST.DX VERT. FACTORY-R Ø50		
	088421046R	KIT RIC RIVESTIMENTO FACTORY INOX L=270		
	416797R	KIT RICAMBIO LANA FACTORY L=270		
	8488E	GILERA	NEXUS 500 carburator/injection	2003-2012
RICAMBI		306960505R	KIT FASCETTA FB1S CARBONIO	
	308562501R	KIT fascetta FB5AS CARBONIO LVONE		
	307930202R	KIT SACCHETTO COLLETTORE N. 530 DX		
	5682	KIT TAPPO SONDA LAMBDA M18 BASE + GUARN		
	308078804R	KIT RIC TAPPO N.57 x SCOOTERONI		
	308186602R	KIT SACCH.BOCC. RIDUZIONE JASON B.		
	205359R	KIT BOCCOLA INOX 54X50X35 DIS.040/09		
	308488601R	KIT SACCH MINUTERIA NEXUS 500		
	303949001R	KIT RIC MOLLA-GOMM. ANTIVIB. CORTA		
	308488481R	KIT R COR EVO IN R D54 BIG 0233/35 10400		
	088292004R	KIT LAMELLE E RIVETTI OM.0233 0235 10400		
	3014000701R	KIT RICAMBI COPPA POST.BIG VERTICALE CAR		
	307762801R	KIT TAPPO X OMOL. EVO2 N. 32B GPSTY		
	307242711R	KIT COPPA POST.FACT.VERT. D.54 EV2		
	088291004R	KIT RIC RIVESTIMENTO FACT.DX BIG L=370		
	414205R	KIT RICAMBI LANA HT 800 Plus 850g		
8489E	APRILIA	SR 300 MAX	2012-2015	Leovince LV ONE EVO - FULL SYSTEM 1/1 - STAINLESS STEEL
	APRILIA	NEXUS 250	2006-2008	
	APRILIA	NEXUS 300	2008-2014	
RICAMBI	306958505R	KIT FASCETTA FM1S CARB. FACT. MED		
	307708801R	KIT TAPPO X OMOL. EVO2 N. 41 4 FILE da3		

ART.	MARCA	MODELLO	TIPOLOGIA		
		307755202R 5682 308489601R 303949001R 308295481R 088296002R 3014008701R 307762801R 308287711R 083980016R 414205R	KIT SACCHETTO COLLETTORE N. 497 DX KIT TAPPO SONDA LAMBDA M18 BASE + GUARN KIT SACCH.MINUT.GILERA NEXUS 300 '10 KIT RIC MOLLA-GOMM. ANTIVIB. CORTA KIT RIC.COR EVO IN D50MED L=370 OM.0231 KIT LAMELLE E RIVETTI OM.0231 KIT RICAMBIO COPPA POST. MEDIA VERT CARB KIT TAPPO X OMOL. EVO2 N. 32B GPSTY KIT COPPA POST.M.VERT.D.54 EV.2+LUNG KIT RIC RIVESTIMENTO VERT.DX MEDIO L=370 KIT RICAMBI LANA HT 800 Plus 850g		
<b>8490E</b>	PIAGGIO	MP3 400/LT/RST	2007-2012	Leovince LV ONE EVO - SLIP-ON - STAINLESS STEEL	
	PIAGGIO	MP3 500/BUSINESS/LT/SPORT	2011-2016		
<b>RICAMBI</b>		308078804R 308562501R 308186602R 205359R 308490202R 300041530R 308490601R 303949001R 308488481R 088292004R 3014000701R 307762801R 307242711R 088291004R 414205R	KIT RIC TAPPO N.57 x SCOOTERONI KIT fascetta FB5AS CARBONIO LVONE KIT SACCH.BOCC. RIDUZIONE JASON B. KIT BOCCOLA INOX 54X50X35 DIS.040/09 KIT RICAMBI COLLETTORE N°881 DX KIT fascetta 41 Inox KIT SACCHETTO MINUT.X PIAGGIO MP3 400'10 KIT RIC MOLLA-GOMM. ANTIVIB. CORTA KIT R COR EVO IN R D54 BIG 0233/35 10400 KIT LAMELLE E RIVETTI OM.0233 0235 10400 KIT RICAMBI COPPA POST.BIG VERTICALE CAR KIT TAPPO X OMOL. EVO2 N. 32B GPSTY KIT COPPA POST.FACT.VERT. D.54 EV.2 KIT RIC RIVESTIMENTO FACT.DX BIG L=370 KIT RICAMBI LANA HT 800 Plus 850g		
<b>8491E</b>	TRIUMPH	TIGER 800 XC/XCA/XCX/XR/XRX (fits with original panniers)	2011-2016	Leovince LV ONE EVO - SLIP-ON - STAINLESS STEEL	
<b>RICAMBI</b>		306960501R 308492202R 308492601R 303949001R 308424481R 088425010R 3014000701R 307762801R 307242711R 088291004R 414205R	KIT fascetta FB1 CARBONIO LV ONE EVO BIG KIT RICAMBI COLLETTORE TIGER 800 KIT SACCH.MIN.TRIUMPH TIGER 800 '11 KIT RIC MOLLA-GOMM. ANTIVIB. CORTA KIT R COR EV IN RETE D50 BIG 0230 10399 KIT LAMELLE E RIVETTI OM.0230 10399 KIT RICAMBI COPPA POST.BIG VERTICALE CAR KIT TAPPO X OMOL. EVO2 N. 32B GPSTY KIT COPPA POST.FACT.VERT. D.54 EV.2 KIT RIC RIVESTIMENTO FACT.DX BIG L=370 KIT RICAMBI LANA HT 800 Plus 850g		
<b>8492E</b>	TRIUMPH	TIGER 800 XC/XCA/XCX/XR/XRX (fits with original panniers)	2011-2016	Leovince LV ONE EVO - SLIP-ON - CARBON FIBER	
<b>RICAMBI</b>		306960501R 308492202R 308492601R 303949001R 308425481R 088425012R 3014000701R 307762801R 307242711R 408543R 414205R 206721	KIT fascetta FB1 CARBONIO LV ONE EVO BIG KIT RICAMBI COLLETTORE TIGER 800 KIT SACCH.MIN.TRIUMPH TIGER 800 '11 KIT RIC MOLLA-GOMM. ANTIVIB. CORTA KIT R COR EV CAR RE D50 BIG 0230 10399 KIT LAMELLE E RIVETTI OM.0230 010 KIT RICAMBI COPPA POST.BIG VERTICALE CAR KIT TAPPO X OMOL. EVO2 N. 32B GPSTY KIT COPPA POST.FACT.VERT. D.54 EV.2 KIT RIVESTIMENTO BIG CARB 110X125 L=370 KIT RICAMBI LANA HT 800 Plus 850g TARGHETTA LEOVINCE CARBONIO 90x30		
<b>8496E</b>	KAWASAKI	Z 1000 SX (fits with original panniers)	2010-2013	Leovince LV ONE EVO - 2 SLIP-ON - STAINLESS STEEL	
<b>RICAMBI</b>		307659501R 308497203R 308497204R 308497601R 303949001R	KIT FASCETTA FM5 CARBONIO KIT SACCHETTO COLLETTORE N. 884 DX KIT SACCHETTO COLLETTORE N. 885 SX KIT SACCHETTO MINUTERIA Z1000 SX '11 KIT RIC MOLLA-GOMM. ANTIVIB. CORTA		



ART.	MARCA	MODELLO	TIPOLOGIA
		308412481R KIT R COR EV IN D54 MED L=250 OM.9634 308412482R KIT R COR SX EV IN D54 MED L=250 OM.9634 088413002R KIT LAMELLE E RIVETTI OM.9634 3014008701R KIT RICAMBIO COPPA POST. MEDIA VERT CARB 307677801R KIT TAPPO X OMOL. EVO2 N. 32 BMW 308287711R KIT COPPA POST.M.VERT.D.54 EV.2+LUNG 088283004R KIT RIC RIVESTIMENTO FACT.DX MEDIO L=250 088283006R KIT RIC RIVESTIMENTO FACT.SX MEDIO L=250 414205R KIT RICAMBI LANA HT 800 Plus 850g	
<b>8497E</b>	KAWASAKI	Z 1000 SX (fits with original panniers)	2010-2013 Leovince LV ONE EVO - 2 SLIP-ON - CARBON FIBER
RICAMBI		307659501R KIT FASCETTA FM5 CARBONIO 308497203R KIT SACCHETTO COLLETTORE N. 884 DX 308497204R KIT SACCHETTO COLLETTORE N. 885 SX 308497601R KIT SACCHETTO MINUTERIA Z1000 SX '11 303949001R KIT RIC MOLLA-GOMM. ANTIVIB. CORTA 308413481R KIT R COR EV CAR D54 MED L=250 OM.9634 308413482R KIT R CO SX EV CARB D54 MED L=250 OM9634 085096018R KIT LAMELLE E RIVETTI OM.9634 014 3014008701R KIT RICAMBIO COPPA POST. MEDIA VERT CARB 307677801R KIT TAPPO X OMOL. EVO2 N. 32 BMW 308287711R KIT COPPA POST.M.VERT.D.54 EV.2+LUNG 409118R KIT RIVESTIMENTO MED CARB 100X115 L=250 414205R KIT RICAMBI LANA HT 800 Plus 850g 206721R KIT RIC TARGHETTA LEOVINCE CARBONIO	
<b>8514S</b>	TRIUMPH	SPEED TRIPLE 1050/R (low side mount)	2011-2013 Leovince FACTORY S - SLIP-ON - CARBON FIBER
RICAMBI		308448501R KIT fascetta FR2 CARBONIO MEDIA 308514202R KIT SACCHETTO COLL. N.892 TRIUMPH 1050 300045530R KIT fascetta 45 Inox 308514601R KIT SACCH. MINUT.TRIUMPH 1050 '11 303949001R KIT RIC MOLLA-GOMM. ANTIVIB. CORTA 308420481R KIT R CO DX CAR D54 L=270 10057/8 10395 088421026R KIT LAMELLE E RIVETTI OM.10057-58 10395 308420701R KIT RICAMBIO COPPA POST. DX FACT CARB 308421801R KIT TAPPO X OMOL. EVO2 N. 52 FACTORY -R 308421741R KIT COPPA POST.DX VERT. FACTORY-R Ø50 088420002R KIT RIC RIVESTIMENTO FACT 270mm CARB 416797R KIT RICAMBIO LANA FACTORY L=270 206721R KIT RIC TARGHETTA LEOVINCE CARBONIO	
<b>8515S</b>	TRIUMPH	SPEED TRIPLE 1050/R (low side mount)	2011-2013 Leovince FACTORY S - SLIP-ON - STAINLESS STEEL
RICAMBI		308448501R KIT fascetta FR2 CARBONIO MEDIA 308514202R KIT SACCHETTO COLL. N.892 TRIUMPH 1050 300045530R KIT fascetta 45 Inox 308514601R KIT SACCH. MINUT.TRIUMPH 1050 '11 303949001R KIT RIC MOLLA-GOMM. ANTIVIB. CORTA 308421481R KIT R CO DX IN C D54 L=270 10057/8 10395 088421026R KIT LAMELLE E RIVETTI OM.10057-58 10395 308420701R KIT RICAMBIO COPPA POST. DX FACT CARB 308421801R KIT TAPPO X OMOL. EVO2 N. 52 FACTORY -R 308421741R KIT COPPA POST.DX VERT. FACTORY-R Ø50 088421046R KIT RIC RIVESTIMENTO FACTORY INOX L=270 416797R KIT RICAMBIO LANA FACTORY L=270	
<b>8519E</b>	YAMAHA	X-CITY 250 carburetor/injection	2006-2016 Leovince LV ONE EVO - FULL SYSTEM 1/1 - STAINLESS STEEL
	YAMAHA	X-MAX 250 carburetor/injection	2006-2016
RICAMBI		306958505R KIT FASCETTA FM1S CARB. FACT. MED 308520801R KIT TAPPO X OMOL. EVO2 N. 54 4 FILE da 308119202R KIT SACCHETTO COLLETTORE N. 652 DX 5682 KIT TAPPO Sonda LAMBDA M18 BASE + GUARN 308520601R KIT SACCH.MIN. YAMAHA X-MAX 250 '10 303949001R KIT RIC MOLLA-GOMM. ANTIVIB. CORTA 308295481R KIT RIC.COR EVO IN D50MED L=370 OM.0231	

ART.	MARCA	MODELLO	TIPOLOGIA
		088296002R KIT LAMELLE E RIVETTI OM.0231	
		3014008701R KIT RICAMBIO COPPA POST. MEDIA VERT CARB	
		307762801R KIT TAPPO X OMOL. EVO2 N. 32B GPSTY	
		308287711R KIT COPPA POST.M.VERT.D.54 EV.2+LUNG	
		083980016R KIT RIC RIVESTIMENTO VERT.DX MEDIO L=370	
		414205R KIT RICAMBI LANA HT 800 Plus 850g	
<b>8525S</b>	SUZUKI	GSX-R 600	2011-2016 Leovince FACTORY S - SLIP-ON - CARBON FIBER
	SUZUKI	GSX-R 750	2011-2016
<b>RICAMBI</b>		308448501R KIT fascetta FR2 CARBONIO MEDIA	
		308525202R KIT SACCHETTO COLLETTORE N.896	
		300049530R KIT fascetta 49 Inox	
		308525681R KIT SACCH. MINUT. SUZUKI GSX-600 '11	
		088525001R KIT CARTER CARBONIO SUZUKI GSX-R 600 '11	
		303949001R KIT RIC MOLLA-GOMM. ANTIVIB. CORTA	
		308436481R KIT R CORPO DX C Ø50 L270 O10057/8 10401	
		088421022R KIT LAMELLE E RIVETTI OM.10057-58 10401	
		308420701R KIT RICAMBIO COPPA POST. DX FACT CARB	
		308437801R KIT TAPPO dB-KILLER N. 52B FACTORY R	
		308437741R KIT COPPA POST.DX VERT. FACTORY-R Ø50	
		088420002R KIT RIC RIVESTIMENTO FACT 270mm CARB	
		416797R KIT RICAMBIO LANA FACTORY L=270	
		206721R KIT RIC TARGHETTA LEOVINCE CARBONIO	
<b>8526S</b>	SUZUKI	GSX-R 600	2011-2016 Leovince FACTORY S - SLIP-ON - STAINLESS STEEL
	SUZUKI	GSX-R 750	2011-2016
<b>RICAMBI</b>		308448501R KIT fascetta FR2 CARBONIO MEDIA	
		308525202R KIT SACCHETTO COLLETTORE N.896	
		300049530R KIT fascetta 49 Inox	
		308525681R KIT SACCH. MINUT. SUZUKI GSX-600 '11	
		088525001R KIT CARTER CARBONIO SUZUKI GSX-R 600 '11	
		303949001R KIT RIC MOLLA-GOMM. ANTIVIB. CORTA	
		308437481R KIT R CO DX CAR CO D50 270 10057/8 10401	
		088421022R KIT LAMELLE E RIVETTI OM.10057-58 10401	
		308420701R KIT RICAMBIO COPPA POST. DX FACT CARB	
		308437801R KIT TAPPO dB-KILLER N. 52B FACTORY R	
		308437741R KIT COPPA POST.DX VERT. FACTORY-R Ø50	
		088421046R KIT RIC RIVESTIMENTO FACTORY INOX L=270	
		416797R KIT RICAMBIO LANA FACTORY L=270	
<b>8537E</b>	MBK	SKYCRUISER 125	2006-2016 Leovince LV ONE EVO - FULL SYSTEM 1/1 - STAINLESS STEEL
	MBK	X-CITY 125	2008-2016
	MBK	X-MAX 125	2006-2016
<b>RICAMBI</b>		306958505R KIT FASCETTA FM1S CARB. FACT. MED	
		308520801R KIT TAPPO X OMOL. EVO2 N. 54 4 FILE da	
		307429610R KIT SACCHETTO KIT RULLI 5648 G.8.7	
		308538202R KIT SACCHETTO COLLETTORE N.902	
		5682 KIT TAPPO Sonda LAMBDA M18 BASE + GUARN	
		308538601R KIT SACCH.MIN. YAMAHA X-MAX 125 '11	
		303949001R KIT RIC MOLLA-GOMM. ANTIVIB. CORTA	
		308295481R KIT RIC.COR EVO IN D50MED L=370 OM.0231	
		088296002R KIT LAMELLE E RIVETTI OM.0231	
		3014008701R KIT RICAMBIO COPPA POST. MEDIA VERT CARB	
		307762801R KIT TAPPO X OMOL. EVO2 N. 32B GPSTY	
		308287711R KIT COPPA POST.M.VERT.D.54 EV.2+LUNG	
		083980016R KIT RIC RIVESTIMENTO VERT.DX MEDIO L=370	
		414205R KIT RICAMBI LANA HT 800 Plus 850g	
<b>8541E</b>	GILERA	RUNNER ST 125	2008-2016 Leovince LV ONE EVO - FULL SYSTEM 1/1 - STAINLESS STEEL
	GILERA	RUNNER VX 125	2006-2007
	GILERA	RUNNER ST 200	2008-2014
	GILERA	RUNNER VXR 200	2006-2008
<b>RICAMBI</b>		306958501R KIT fascetta FM1 Factory Medio Verticale	

ART.	MARCA	MODELLO	TIPOLOGIA
		308520801R KIT TAPPO X OMOL. EVO2 N. 54 4 FILE da	
		308131205R KIT SACCHETTO COLLETTORE N. 657B	
		308131206R KIT SACCHETTO COLLETTORE N. 657C	
		300043530R KIT fascetta 43 Inox	
		308542601R KIT SACCH.MIN.GILERA RUNNER VX125'11	
		203529R KIT RIC BOCCOLA 40X35X30 LGR/F D.133/03	
		205261R KIT RIC BOCCOLA INOX 50X38X40 DIS.039/09	
		303949001R KIT RIC MOLLA-GOMM. ANTIVIB. CORTA	
		308295481R KIT RIC.COR EVO IN D50MED L=370 OM.0231	
		088296002R KIT LAMELLE E RIVETTI OM.0231	
		3014008701R KIT RICAMBIO COPPA POST. MEDIA VERT CARB	
		307762801R KIT TAPPO X OMOL. EVO2 N. 32B GPSTY	
		308287711R KIT COPPA POST.M.VERT.D.54 EV.2+LUNG	
		083980016R KIT RIC RIVESTIMENTO VERT.DX MEDIO L=370	
		414205R KIT RICAMBI LANA HT 800 Plus 850g	
<b>8543E</b>	SUZUKI	GSR/GSX-S 750	2011-2016 Leovince LV ONE EVO - SLIP-ON - STAINLESS STEEL
RICAMBI		306958501R KIT fascetta FM1 Factory Medio Verticale	
		308544202R KIT SACCHETTO COLLETTORE N.907	
		300045530R KIT fascetta 45 Inox	
		308544601R KIT SACCH MINUTERIA SUZUKI GSR 750 '11	
		303949001R KIT RIC MOLLA-GOMM. ANTIVIB. CORTA	
		308406481R KIT R COR EVO IN D50 MED L=270 OM.0430	
		088282002R KIT LAMELLE E RIVETTI OM.0429 0430	
		3014008701R KIT RICAMBIO COPPA POST. MEDIA VERT CARB	
		204790R KIT RIC GOMMINO COPPE CARBONIO D.007/06	
		307762801R KIT TAPPO X OMOL. EVO2 N. 32B GPSTY	
		308287711R KIT COPPA POST.M.VERT.D.54 EV.2+LUNG	
		088406004R KIT RIC RIVESTIMENTO FACT.DX MEDIO L=270	
		414205R KIT RICAMBI LANA HT 800 Plus 850g	
<b>8544E</b>	SUZUKI	GSR/GSX-S 750	2011-2016 Leovince LV ONE EVO - SLIP-ON - CARBON FIBER
RICAMBI		306958501R KIT fascetta FM1 Factory Medio Verticale	
		308544202R KIT SACCHETTO COLLETTORE N.907	
		300045530R KIT fascetta 45 Inox	
		308544601R KIT SACCH MINUTERIA SUZUKI GSR 750 '11	
		303949001R KIT RIC MOLLA-GOMM. ANTIVIB. CORTA	
		308407481R KIT R COR EV CAR D50 MED L=270 OM.0430	
		085096022R KIT LAMELLE E RIVETTI OM.430 014	
		3014008701R KIT RICAMBIO COPPA POST. MEDIA VERT CARB	
		204790R KIT RIC GOMMINO COPPE CARBONIO D.007/06	
		307762801R KIT TAPPO X OMOL. EVO2 N. 32B GPSTY	
		308287711R KIT COPPA POST.M.VERT.D.54 EV.2+LUNG	
		088407002R KIT RIC RIVESTIMENTO FACTORY MEDIO L=270	
		206721R KIT RIC TARGHETTA LEOVINCE CARBONIO	
		414205R KIT RICAMBI LANA HT 800 Plus 850g	
<b>8545S</b>	SUZUKI	GSR/GSX-S 750	2011-2016 Leovince FACTORY S - SLIP-ON - CARBON FIBER
	SUZUKI	GSX-S 750/Z ABS (US model only)	2015-2017
RICAMBI		308448501R KIT fascetta FR2 CARBONIO MEDIA	
		308545202R KIT SACCHETTO COLLETTORE N.906	
		300045530R KIT fascetta 45 Inox	
		308545601R KIT SACCH. MINUT. SUZUKI GSR 750 '11	
		303949001R KIT RIC MOLLA-GOMM. ANTIVIB. CORTA	
		308436481R KIT R CORPO DX C Ø50 L270 O10057/8 10401	
		088421022R KIT LAMELLE E RIVETTI OM.10057-58 10401	
		308420701R KIT RICAMBIO COPPA POST. DX FACT CARB	
		308437801R KIT TAPPO dB-KILLER N. 52B FACTORY R	
		308437741R KIT COPPA POST.DX VERT. FACTORY-R Ø50	
		088420002R KIT RIC RIVESTIMENTO FACT 270mm CARB	
		416797R KIT RICAMBIO LANA FACTORY L=270	
		206721R KIT RIC TARGHETTA LEOVINCE CARBONIO	
<b>8546S</b>	SUZUKI	GSR/GSX-S 750	2011-2016 Leovince FACTORY S - SLIP-ON - STAINLESS STEEL
	SUZUKI	GSX-S 750/Z ABS (US model only)	2015-2017

ART.	MARCA	MODELLO	TIPOLOGIA
RICAMBI	308448501R	KIT fascetta FR2 CARBONIO MEDIA	
	308545202R	KIT SACCHETTO COLLETTORE N.906	
	300045530R	KIT fascetta 45 Inox	
	308545601R	KIT SACCH. MINUT. SUZUKI GSR 750 '11	
	303949001R	KIT RIC MOLLA-GOMM. ANTIVIB. CORTA	
	308437481R	KIT R CO DX CAR CO D50 270 10057/8 10401	
	088421022R	KIT LAMELLE E RIVETTI OM.10057-58 10401	
	308420701R	KIT RICAMBIO COPPA POST. DX FACT CARB	
	308437801R	KIT TAPPO dB-KILLER N. 52B FACTORY R	
	308437741R	KIT COPPA POST.DX VERT. FACTORY-R Ø50	
	088421046R	KIT RIC RIVESTIMENTO FACTORY INOX L=270	
	416797R	KIT RICAMBIO LANA FACTORY L=270	
<b>8552E</b>	HONDA	SILVER WING 400	2006-2008 Leovince LV ONE EVO - SLIP-ON - STAINLESS STEEL
	HONDA	SILVER WING 400 (US model only)	2006-2016
	HONDA	SW-T 400	2009-2016
	HONDA	SILVER WING 600	2002-2010
	HONDA	SILVER WING 600 (US model only)	2002-2016
	HONDA	SW-T 600	2011-2016
RICAMBI	306960505R	KIT FASCETTA FB1S CARBONIO	
	308552202R	KIT SACCHETTO COLLETTORE N. 909	
	5682	KIT TAPPO SONDA LAMBDA M18 BASE + GUARN	
	300035530R	KIT fascetta 35 Inox	
	308552681R	KIT SACCH.MINUT.X SILVER WING 600'11	
	083896002R	KIT CARTER CARBONIO LATER X RAPTOR '06	
	205261R	KIT RIC BOCCOLA INOX 50X38X40 DIS.039/09	
	303949001R	KIT RIC MOLLA-GOMM. ANTIVIB. CORTA	
	308424481R	KIT R COR EV IN RETE D50 BIG 0230 10399	
	088425010R	KIT LAMELLE E RIVETTI OM.0230 10399	
	3014000701R	KIT RICAMBI COPPA POST.BIG VERTICALE CAR	
	307762801R	KIT TAPPO X OMOL. EVO2 N. 32B GPSTY	
	307242711R	KIT COPPA POST.FACT.VERT. D.54 EV.2	
	088291004R	KIT RIC RIVESTIMENTO FACT.DX BIG L=370	
	414205R	KIT RICAMBI LANA HT 800 Plus 850g	
<b>8555E</b>	HONDA	CB 1000 R	2008-2016 Leovince LV ONE EVO - SLIP-ON - STAINLESS STEEL
RICAMBI	306958501R	KIT fascetta FM1 Factory Medio Verticale	
	308128202R	KIT RICAMBIO COLLETTORE CB1000R '08	
	300051530R	KIT fascetta 51 Inox	
	308128601R	KIT SACCH. MINUTERIA HONDA CB 1000 '08	
	303949001R	KIT RIC MOLLA-GOMM. ANTIVIB. CORTA	
	308406481R	KIT R COR EVO IN D50 MED L=270 OM.0430	
	088282002R	KIT LAMELLE E RIVETTI OM.0429 0430	
	3014008701R	KIT RICAMBIO COPPA POST. MEDIA VERT CARB	
	204790R	KIT RIC GOMMINO COPPE CARBONIO D.007/06	
	307762801R	KIT TAPPO X OMOL. EVO2 N. 32B GPSTY	
	308287711R	KIT COPPA POST.M.VERT.D.54 EV.2+LUNG	
	088406004R	KIT RIC RIVESTIMENTO FACT.DX MEDIO L=270	
	414205R	KIT RICAMBI LANA HT 800 Plus 850g	
<b>8556E</b>	HONDA	CB 1000 R	2008-2016 Leovince LV ONE EVO - SLIP-ON - CARBON FIBER
RICAMBI	306958501R	KIT fascetta FM1 Factory Medio Verticale	
	308128202R	KIT RICAMBIO COLLETTORE CB1000R '08	
	300051530R	KIT fascetta 51 Inox	
	308128601R	KIT SACCH. MINUTERIA HONDA CB 1000 '08	
	303949001R	KIT RIC MOLLA-GOMM. ANTIVIB. CORTA	
	308407481R	KIT R COR EV CAR D50 MED L=270 OM.0430	
	085096022R	KIT LAMELLE E RIVETTI OM.430 014	
	3014008701R	KIT RICAMBIO COPPA POST. MEDIA VERT CARB	
	204790R	KIT RIC GOMMINO COPPE CARBONIO D.007/06	
	307762801R	KIT TAPPO X OMOL. EVO2 N. 32B GPSTY	
	308287711R	KIT COPPA POST.M.VERT.D.54 EV.2+LUNG	
	088407002R	KIT RIC RIVESTIMENTO FACTORY MEDIO L=270	
	206721R	KIT RIC TARGHETTA LEOVINCE CARBONIO	
	414205R	KIT RICAMBI LANA HT 800 Plus 850g	

ART.	MARCA	MODELLO		TIPOLOGIA
8562E	SYM	GTS 300	2010-2011	Leovince LV ONE EVO - SLIP-ON - STAINLESS STEEL
	SYM	JOYMAX 300 EVO/GTS	2010-2011	
RICAMBI	306958505R	KIT FASCETTA FM1S CARB. FACT. MED		
	308562501R	KIT fascetta FB5AS CARBONIO LVONE		
	308562202R	KIT RICAMBI COLLETTORE JOY MAX 300		
	300028530R	KIT fascetta 28 Inox		
	308520801R	KIT TAPPO X OMOL. EVO2 N. 54 4 FILE da		
	308562601R	KIT SACCH.MIN.SYM JOYMAX 300 2011		
	303949001R	KIT RIC MOLLA-GOMM. ANTIVIB. CORTA		
	308424481R	KIT R COR EV IN RETE D50 BIG 0230 10399		
	088425010R	KIT LAMELLE E RIVETTI OM.0230 10399		
	3014000701R	KIT RICAMBI COPPA POST.BIG VERTICALE CAR		
	307762801R	KIT TAPPO X OMOL. EVO2 N. 32B GPSTY		
	307242711R	KIT COPPA POST.FACT.VERT. D.54 EV.2		
	088291004R	KIT RIC RIVESTIMENTO FACT.DX BIG L=370		
	414205R	KIT RICAMBI LANA HT 800 Plus 850g		
8565E	APRILIA	SRV 850	2012-2016	Leovince LV ONE EVO - SLIP-ON - STAINLESS STEEL
	APRILIA	GP 800	2008-2015	
RICAMBI	307659501R	KIT FASCETTA FM5 CARBONIO		
	308120204R	KIT RICAMBI COLLETTORE N°654 DX		
	308120205R	KIT RICAMBI COLLETTORE N°655 SX		
	308120206R	KIT RICAMBI COLLETTORE N°656		
	5682	KIT TAPPO SONDA LAMBDA M18 BASE + GUARN		
	308120601R	KIT SACCH MINUTERIA GILERA GP800		
	303949001R	KIT RIC MOLLA-GOMM. ANTIVIB. CORTA		
	308295482R	KIT RIC.COR SX EV IN D50 ME L=370 OM0231		
	088296002R	KIT LAMELLE E RIVETTI OM.0231		
	3014008701R	KIT RICAMBIO COPPA POST. MEDIA VERT CARB		
	307762801R	KIT TAPPO X OMOL. EVO2 N. 32B GPSTY		
	308287711R	KIT COPPA POST.M.VERT.D.54 EV.2+LUNG		
	083980016R	KIT RIC RIVESTIMENTO VERT.DX MEDIO L=370		
	083980018R	KIT RIC RIVESTIMENTO VERT.SX MEDIO L=370		
414205R	KIT RICAMBI LANA HT 800 Plus 850g			
8566B	KTM	DUKE 125	2011-2016	Leovince GP STYLE BLACK - SLIP-ON - STAINLESS STEEL
	KTM	DUKE 200	2012-2014	
RICAMBI	307708801R	KIT TAPPO X OMOL. EVO2 N. 41 4 FILE da3		
	308566203R	KIT SACCHETTO COLLECTORE N.912		
	300041530R	KIT fascetta 41 Inox		
	308566204R	KIT SACCHETTO COLLETTORE N. 913 KTM DUKE		
	308566601R	KIT SACCH.MINUT.KTM DUKE 125 '11		
	303949001R	KIT RIC MOLLA-GOMM. ANTIVIB. CORTA		
	307762475R	KIT RIC CORPO DX Ø150 L=295 IN OM0473 BL		
	307762801R	KIT TAPPO X OMOL. EVO2 N. 32B GPSTY		
8566	KTM	DUKE 125	2011-2016	Leovince GP STYLE - SLIP-ON - STAINLESS STEEL
	KTM	DUKE 200	2012-2014	
	KTM	DUKE 125	2011-2016	
	KTM	DUKE 200	2012-2014	
RICAMBI	307708801R	KIT TAPPO X OMOL. EVO2 N. 41 4 FILE da3		
	308566203R	KIT SACCHETTO COLLECTORE N.912		
	300041530R	KIT fascetta 41 Inox		
	308566204R	KIT SACCHETTO COLLETTORE N. 913 KTM DUKE		
	308566601R	KIT SACCH.MINUT.KTM DUKE 125 '11		
	303949001R	KIT RIC MOLLA-GOMM. ANTIVIB. CORTA		
	307762471R	KIT RIC CORPO DX Ø150 L=295 INOX OM.0473		
	307762801R	KIT TAPPO X OMOL. EVO2 N. 32B GPSTY		
8567E	TRIUMPH	STREET TRIPLE 675	2007-2012	Leovince LV ONE EVO - 2 SLIP-ON - STAINLESS STEEL
	KTM	STREET TRIPLE 675 R	2009-2012	
RICAMBI	303984501R	KIT fascetta 22T CAR. MED. SING. DIS		
	307940203R	KIT SACCHETTO COLLETT N° 615 TRIUMPH 675		

ART.	MARCA	MODELLO	TIPOLOGIA
		307940204R KIT SACCHETTO COLLETT N° 616 TRIUMPH 675	
		308568601R KIT SACCH. MINUT.X TRIUMPH 675 '11	
		303949001R KIT RIC MOLLA-GOMM. ANTIVIB. CORTA	
		308406481R KIT R COR EVO IN D50 MED L=270 OM.0430	
		308406482R KIT R COR SX EV IN D50 MED L=270 OM.0430	
		088282002R KIT LAMELLE E RIVETTI OM.0429 0430	
		3014008701R KIT RICAMBIO COPPA POST. MEDIA VERT CARB	
		307762801R KIT TAPPO X OMOL. EVO2 N. 32B GPSTY	
		308287711R KIT COPPA POST.M.VERT.D.54 EV.2+LUNG	
		088406004R KIT RIC RIVESTIMENTO FACT.DX MEDIO L=270	
		088406006R KIT RIC RIVESTIMENTO FACT.SX MEDIO L=270	
		414205R KIT RICAMBI LANA HT 800 Plus 850g	
<b>8568E</b>	TRIUMPH	STREET TRIPLE 675	2007-2012 Leovince LV ONE EVO - 2 SLIP-ON - CARBON FIBER
	TRIUMPH	STREET TRIPLE 675 R	2009-2012
<b>RICAMBI</b>		303984501R KIT fascetta 22T CAR. MED. SING. DIS	
		307940203R KIT SACCHETTO COLLETT N° 615 TRIUMPH 675	
		307940204R KIT SACCHETTO COLLETT N° 616 TRIUMPH 675	
		308568601R KIT SACCH. MINUT.X TRIUMPH 675 '11	
		303949001R KIT RIC MOLLA-GOMM. ANTIVIB. CORTA	
		308407481R KIT R COR EV CAR D50 MED L=270 OM.0430	
		308407482R KIT R COR SX EV CAR D50 MED L=270 OM0430	
		085096022R KIT LAMELLE E RIVETTI OM.430 014	
		3014008701R KIT RICAMBIO COPPA POST. MEDIA VERT CARB	
		307762801R KIT TAPPO X OMOL. EVO2 N. 32B GPSTY	
		308287711R KIT COPPA POST.M.VERT.D.54 EV.2+LUNG	
		088407002R KIT RIC RIVESTIMENTO FACTORY MEDIO L=270	
		414205R KIT RICAMBI LANA HT 800 Plus 850g	
		206721R KIT RIC TARGHETTA LEOVINCE CARBONIO	
<b>8571E</b>	VESPA	GTS 125 SUPER	2009-2015 Leovince LV ONE EVO - SLIP-ON - STAINLESS STEEL
	VESPA	GTS 250	2005-2013
	VESPA	GTV 250	2006-2013
	VESPA	GTV 250 NAVY	2008-2008
	VESPA	GTS 300 SUPER	2008-2015
	VESPA	GTS 300 SUPERSPORT	2010-2015
	VESPA	GTV 300 VIA MONTENAPOLEONE	2010-2013
<b>RICAMBI</b>		306960505R KIT FASCETTA FB1S CARBONIO	
		308571202R KIT SACCHETTO COLLETT N.922 VESPA GTS	
		300043530R KIT fascetta 43 Inox	
		308520801R KIT TAPPO X OMOL. EVO2 N. 54 4 FILE da	
		308571601R KIT SACCH MINUTERIA GTS 250/300	
		203532R KIT RIC BOCCOLA 40X32X30 LGR/F D.136/03	
		205261R KIT RIC BOCCOLA INOX 50X38X40 DIS.039/09	
		303949001R KIT RIC MOLLA-GOMM. ANTIVIB. CORTA	
		308424481R KIT R COR EV IN RETE D50 BIG 0230 10399	
		088425010R KIT LAMELLE E RIVETTI OM.0230 10399	
		3014000701R KIT RICAMBI COPPA POST.BIG VERTICALE CAR	
		307762801R KIT TAPPO X OMOL. EVO2 N. 32B GPSTY	
		307242711R KIT COPPA POST.FACT.VERT. D.54 EV.2	
		088291004R KIT RIC RIVESTIMENTO FACT.DX BIG L=370	
		414205R KIT RICAMBI LANA HT 800 Plus 850g	
<b>8572E</b>	BMW	G 650 GS (fits with original panniers)	2011-2016 Leovince LV ONE EVO - SLIP-ON - STAINLESS STEEL
	BMW	G 650 GS SERTA0 (fits with original panniers)	2012-2014
<b>RICAMBI</b>		306958501R KIT fascetta FM1 Factory Medio Verticale	
		308573202R KIT SACCHETTO COLLETT N. 923 SX	
		300045530R KIT fascetta 45 Inox	
		308573601R KIT RICAMBIO MINUTERIA BMW G 650 GS '11	
		303949001R KIT RIC MOLLA-GOMM. ANTIVIB. CORTA	
		308572482R KIT R COR EVO IN D.50 MED L=370 OM.0231	
		088296002R KIT LAMELLE E RIVETTI OM.0231	
		3014008701R KIT RICAMBIO COPPA POST. MEDIA VERT CARB	
		307919801R KIT TAPPO X OMOL. EVO2 N. 32BF GPSTY	
		308287711R KIT COPPA POST.M.VERT.D.54 EV.2+LUNG	

ART.	MARCA	MODELLO		TIPOLOGIA
		083980016R	KIT RIC RIVESTIMENTO VERT.DX MEDIO L=370	
		083980018R	KIT RIC RIVESTIMENTO VERT.SX MEDIO L=370	
		414205R	KIT RICAMBI LANA HT 800 Plus 850g	
<b>8579</b>	KAWASAKI	ER-6N/F/NINJA 650R		2012-2016 Leovince UNDERBODY - FULL SYSTEM 2/1 - STAINLESS STEEL
	KAWASAKI	VERSYS 650		2015-2016
<b>RICAMBI</b>		308579204R	KIT RICAMBI COLLETTORI PRIMARI ER-6N-F	
		206060R	KIT RIC BOCCOLA INOX 41X33X25.5 D.031/12	
		206061R	KIT RIC FLANGIA INOX 158 A DIS.032/12	
		308579205R	KIT SACCHETTO BIFORCA FINALE KAW ER6 N-F	
		5682	KIT TAPPO SONDA LAMBDA M18 BASE + GUARN	
		308579601R	KIT SACCH. MINUT. KAWAS. ER6 N-F '12	
		303949001R	KIT RIC MOLLA-GOMM. ANTIVIB. CORTA	
		308242471R	KIT RIC CORPO INOX D50 L=205 10034 10417	
		088232014R	KIT LAMELLE E RIVETTI OM.10034/42 10417	
		308232701R	KIT COPPA POST.UNDERBODY CARB	
		204790R	KIT RIC GOMMINO COPPE CARBONIO D.007/06	
		308232801R	KIT TAPPO X OMOL. EVO2 UNDER Xd.50 N. 47	
		308232750R	KIT RIC RIVESTIMENTO UNDER CORTO L=205	
		8066	KIT RICAMBIO MATERIALE FONOAASS UNDERBODY	
<b>8585E</b>	KTM	950 SM SUPERMOTO		2005-2008 Leovince LV ONE EVO - 2 SLIP-ON - CARBON FIBER
	KTM	990 SM SUPERMOTO		2008-2010
	KTM	990 SM R SUPERMOTO R		2009-2012
<b>RICAMBI</b>		306958501R	KIT fascetta FM1 Factory Medio Verticale	
		307536204R	KIT SACCHETTO BIFORCA N° 387	
		307545203R	KIT SACCHETTO COLLETTORE N°408 DX	
		307545204R	KIT SACCHETTO COLLETTORE N°409 SX	
		307545601R	KIT SACCH MINUTERIA SUPERMOTO 950	
		303949001R	KIT RIC MOLLA-GOMM. ANTIVIB. CORTA	
		308288481R	KIT R.COR.EV CAR D54 MED L-370 OM.0237	
		308288482R	KIT R.COR SX EVO CAR D54 MEDL=370 OM0237	
		085096014R	KIT LAMELLE E RIVET 0457 0237 0430 10410	
		3014008701R	KIT RICAMBIO COPPA POST. MEDIA VERT CARB	
		307677801R	KIT TAPPO X OMOL. EVO2 N. 32 BMW	
		308287711R	KIT COPPA POST.M.VERT.D.54 EV.2+LUNG	
		408541R	KIT RIVESTIMENTO MED CARB 100X115 L=370	
		414205R	KIT RICAMBI LANA HT 800 Plus 850g	
		206721R	KIT RIC TARGHETTA LEOVINCE CARBONIO	
<b>8588E</b>	YAMAHA	T-MAX 530		2012-2016 Leovince LV ONE EVO - FULL SYSTEM 2/1 - STAINLESS STEEL
<b>RICAMBI</b>		308562501R	KIT fascetta FB5AS CARBONIO LVONE	
		308108203R	KIT SACCH BIFORCAZIONE SEC. YAM.T-MAX	
		308108204R	KIT SACCH COLLETT FINALE DX YAM. T-MAX	
		5682	KIT TAPPO SONDA LAMBDA M18 BASE + GUARN	
		308588202R	KIT RICAMBIO COLL. PRIMARIO T-MAX 530	
		308108601R	KIT SACCHETTO MINUT.YAMAHA T-MAX '08	
		304982002R	KIT RIC MOLLA TRAZ.+TUBETTO MONTATO	
		308424481R	KIT R COR EV IN RETE D50 BIG 0230 10399	
		088425010R	KIT LAMELLE E RIVETTI OM.0230 10399	
		3014000701R	KIT RICAMBI COPPA POST.BIG VERTICALE CAR	
		307762801R	KIT TAPPO X OMOL. EVO2 N. 32B GPSTY	
		307242711R	KIT COPPA POST.FACT.VERT. D.54 EV.2	
		088291004R	KIT RIC RIVESTIMENTO FACT.DX BIG L=370	
		414205R	KIT RICAMBI LANA HT 800 Plus 850g	
<b>8598S</b>	SUZUKI	GSX-R 1000		2012-2016 Leovince FACTORY S - SLIP-ON - CARBON FIBER
<b>RICAMBI</b>		308448501R	KIT fascetta FR2 CARBONIO MEDIA	
		308421801R	KIT TAPPO X OMOL. EVO2 N. 52 FACTORY -R	
		308598601R	KIT SACCH. MINUT. SUZUKI GSX-R1000 '12	
		308598481R	KIT CORPO DX CA Ø50 270 10057/8 +C 10401	
		088421022R	KIT LAMELLE E RIVETTI OM.10057-58 10401	
		308420701R	KIT RICAMBIO COPPA POST. DX FACT CARB	

ART.	MARCA	MODELLO	TIPOLOGIA
		308437801R KIT TAPPO dB-KILLER N. 52B FACTORY R	
		300051530R KIT fascetta 51 Inox	
		308437741R KIT COPPA POST.DX VERT. FACTORY-R Ø50	
		088420002R KIT RIC RIVESTIMENTO FACT 270mm CARB	
		416797R KIT RICAMBIO LANA FACTORY L=270	
		206721R KIT RIC TARGHETTA LEOVINCE CARBONIO	
<b>8599S</b>	SUZUKI	GSX-R 1000	2012-2016 Leovince FACTORY S - SLIP-ON - STAINLESS STEEL
RICAMBI		308448501R KIT fascetta FR2 CARBONIO MEDIA	
		308421801R KIT TAPPO X OMOL. EVO2 N. 52 FACTORY -R	
		308598601R KIT SACCH. MINUT. SUZUKI GSX-R1000 '12	
		308599481R KIT R CO DX IN Ø50 270 10057/8 +C 10401	
		088421022R KIT LAMELLE E RIVETTI OM.10057-58 10401	
		308420701R KIT RICAMBIO COPPA POST. DX FACT CARB	
		308437801R KIT TAPPO dB-KILLER N. 52B FACTORY R	
		300051530R KIT fascetta 51 Inox	
		308437741R KIT COPPA POST.DX VERT. FACTORY-R Ø50	
		088421046R KIT RIC RIVESTIMENTO FACTORY INOX L=270	
		416797R KIT RICAMBIO LANA FACTORY L=270	
<b>8700E</b>	HONDA	INTEGRA 700/DCT/ABS	2012-2013 Leovince LV ONE EVO - SLIP-ON - STAINLESS STEEL
	HONDA	NC 700 S/X/DCT/ABS	2012-2013
	HONDA	INTEGRA 750/DCT/ABS	2014-2015
	HONDA	NC 750 S/X/DCT/ABS	2014-2015
RICAMBI		303984501R KIT fascetta 22T CAR. MED. SING. DIS	
		308701202R KIT RICAMBIO COLLETTORE INTEGRA 700	
		300041530R KIT fascetta 41 Inox	
		308701601R KIT SACCH.MIN. HONDA INTEGRA 700 '12	
		303949001R KIT RIC MOLLA-GOMM. ANTIVIB. CORTA	
		308402481R KIT R COR EV I D50 ME L300 0429/30 10394	
		088282004R KIT LAMELLE E RIVETTI OM.0430 0457 10394	
		3014008701R KIT RICAMBIO COPPA POST. MEDIA VERT CARB	
		307762801R KIT TAPPO X OMOL. EVO2 N. 32B GPSTY	
		308287711R KIT COPPA POST.M.VERT.D.54 EV.2+LUNG	
		083710014R KIT RIC RIVESTIMENTO DX VERT MEDIO L=300	
		414205R KIT RICAMBI LANA HT 800 Plus 850g	
<b>8701E</b>	HONDA	INTEGRA 700/DCT/ABS	2012-2013 Leovince LV ONE EVO - SLIP-ON - CARBON FIBER
	HONDA	NC 700 S/X/DCT/ABS	2012-2013
	HONDA	INTEGRA 750/DCT/ABS	2014-2015
	HONDA	NC 750 S/X/DCT/ABS	2014-2015
RICAMBI		303984501R KIT fascetta 22T CAR. MED. SING. DIS	
		308701202R KIT RICAMBIO COLLETTORE INTEGRA 700	
		300041530R KIT fascetta 41 Inox	
		308701601R KIT SACCH.MIN. HONDA INTEGRA 700 '12	
		303949001R KIT RIC MOLLA-GOMM. ANTIVIB. CORTA	
		308403481R KIT R COR EV CA D50 M L300 0429/30 10394	
		085096024R KIT LAMELLE E RIVETTI 0429 0430 10394	
		3014008701R KIT RICAMBIO COPPA POST. MEDIA VERT CARB	
		307762801R KIT TAPPO X OMOL. EVO2 N. 32B GPSTY	
		308287711R KIT COPPA POST.M.VERT.D.54 EV.2+LUNG	
		409117R KIT RIVESTIMENTO MED CARB 100X115 L=300	
		414205R KIT RICAMBI LANA HT 800 Plus 850g	
		206721R KIT RIC TARGHETTA LEOVINCE CARBONIO	
<b>8702E</b>	KTM	690 DUKE	2012-2015 Leovince LV ONE EVO - SLIP-ON - STAINLESS STEEL
RICAMBI		306958501R KIT fascetta FM1 Factory Medio Verticale	
		308703202R KIT SACCHETTO COLLETTORE N. 963 DX	
		308703601R KIT SACCH.MINUT. KTM 690 DUKE '12	
		303949001R KIT RIC MOLLA-GOMM. ANTIVIB. CORTA	
		308406481R KIT R COR EVO IN D50 MED L=270 OM.0430	
		088282002R KIT LAMELLE E RIVETTI OM.0429 0430	
		3014008701R KIT RICAMBIO COPPA POST. MEDIA VERT CARB	
		307762801R KIT TAPPO X OMOL. EVO2 N. 32B GPSTY	



ART.	MARCA	MODELLO	TIPOLOGIA
		308287711R KIT COPPA POST.M.VERT.D.54 EV.2+LUNG 088406004R KIT RIC RIVESTIMENTO FACT.DX MEDIO L=270 414205R KIT RICAMBI LANA HT 800 Plus 850g	
<b>8703E</b>	KTM	690 DUKE	2012-2015 Leovince LV ONE EVO - SLIP-ON - CARBON FIBER
RICAMBI		306958501R KIT fascetta FM1 Factory Medio Verticale 308703202R KIT SACCHETTO COLLETTORE N. 963 DX 308703601R KIT SACCH.MINUT. KTM 690 DUKE '12 303949001R KIT RIC MOLLA-GOMM. ANTIVIB. CORTA 308407481R KIT R COR EV CAR D50 MED L=270 OM.0430 085096022R KIT LAMELLE E RIVETTI OM.430 014 3014008701R KIT RICAMBIO COPPA POST. MEDIA VERT CARB 307762801R KIT TAPPO X OMOL. EVO2 N. 32B GPSTY 308287711R KIT COPPA POST.M.VERT.D.54 EV.2+LUNG 088407002R KIT RIC RIVESTIMENTO FACTORY MEDIO L=270 414205R KIT RICAMBI LANA HT 800 Plus 850g 206721R KIT RIC TARGHETTA LEOVINCE CARBONIO	
<b>8704E</b>	HONDA	VFR 1200 X CROSSTOURER/DCT/XD (fits with original panniers and centre stand)	2012-2015 Leovince LV ONE EVO - SLIP-ON - STAINLESS STEEL
RICAMBI		308562501R KIT fascetta FB5AS CARBONIO LVONE 308446203R KIT SACCHETTO COLLETTORE N. 874 300049530R KIT fascetta 49 Inox 308705202R KIT SACCHETTO COLLETTORE N. 961 308705601R KIT RICAMBIO MINUT. HONDA CROSSTOURER 303949001R KIT RIC MOLLA-GOMM. ANTIVIB. CORTA 308488481R KIT R COR EVO IN R D54 BIG 0233/35 10400 088292004R KIT LAMELLE E RIVETTI OM.0233 0235 10400 3014000701R KIT RICAMBI COPPA POST.BIG VERTICALE CAR 307762801R KIT TAPPO X OMOL. EVO2 N. 32B GPSTY 307242711R KIT COPPA POST.FACT.VERT. D.54 EV.2 088291004R KIT RIC RIVESTIMENTO FACT.DX BIG L=370 414205R KIT RICAMBI LANA HT 800 Plus 850g	
<b>8705E</b>	HONDA	VFR 1200 X CROSSTOURER/DCT/XD (fits with original panniers and centre stand)	2012-2015 Leovince LV ONE EVO - SLIP-ON - CARBON FIBER
RICAMBI		308562501R KIT fascetta FB5AS CARBONIO LVONE 308446203R KIT SACCHETTO COLLETTORE N. 874 300049530R KIT fascetta 49 Inox 308705202R KIT SACCHETTO COLLETTORE N. 961 308705601R KIT RICAMBIO MINUT. HONDA CROSSTOURER 303949001R KIT RIC MOLLA-GOMM. ANTIVIB. CORTA 308524481R KIT R COR EV CA RE D54 BIG 0233/35 10400 088425008R KIT LAMELLE E RIVETTI OM.0233 0235 10400 3014000701R KIT RICAMBI COPPA POST.BIG VERTICALE CAR 307762801R KIT TAPPO X OMOL. EVO2 N. 32B GPSTY 307242711R KIT COPPA POST.FACT.VERT. D.54 EV.2 408543R KIT RIVESTIMENTO BIG CARB 110X125 L=370 414205R KIT RICAMBI LANA HT 800 Plus 850g 206721R KIT RIC TARGHETTA LEOVINCE CARBONIO	
<b>8712E</b>	APRILIA	RS4 125	2011-2016 Leovince LV ONE EVO - SLIP-ON - STAINLESS STEEL
RICAMBI		307785501R KIT fascetta FM6 Factory Medio Orizzontale 308713202R KIT SACCHETTO COLLETTORE N. 971 APRILIA 300035530R KIT fascetta 35 Inox 308713601R KIT SACCH. MIN. X APRILIA RS4 125 '12 205261R KIT RIC BOCCOLA INOX 50X38X40 DIS.039/09 303949001R KIT RIC MOLLA-GOMM. ANTIVIB. CORTA 308295481R KIT RIC.COR EVO IN D50MED L=370 OM.0231 088296002R KIT LAMELLE E RIVETTI OM.0231 3014008701R KIT RICAMBIO COPPA POST. MEDIA VERT CARB 307762801R KIT TAPPO X OMOL. EVO2 N. 32B GPSTY 308287711R KIT COPPA POST.M.VERT.D.54 EV.2+LUNG 083980016R KIT RIC RIVESTIMENTO VERT.DX MEDIO L=370 414205R KIT RICAMBI LANA HT 800 Plus 850g	

ART.	MARCA	MODELLO	TIPOLOGIA
8717S	KAWASAKI	ZZR 1400/ZX 14 R	2012-2015 Leovince FACTORY S - 2 SLIP-ON - CARBON FIBER
RICAMBI	308448501R	KIT fascetta FR2 CARBONIO MEDIA	
	308717203R	KIT SACCHETTO COLLETTORE N° 978 DX	
	300057530R	KIT fascetta 57 Inox	
	308717204R	KIT SACCHETTO COLLETTORE N.979 SX	
	308717601R	KIT SACCH MINUTERIA YAMAHA ZZR 1400 '12	
	303949001R	KIT RIC MOLLA-GOMM. ANTIVIB. CORTA	
	308446481R	KIT R CO DX CAR CON D54 L=350 OM10059-60	
	308446482R	KIT R CO SX CAR CON D54 L=350 OM10059-60	
	088421020R	KIT LAMELLE E RIVETTI OM. 10059-60	
	308420701R	KIT RICAMBIO COPPA POST. DX FACT CARB	
	308420702R	KIT RICAMBIO COPPA POST. SX FACT CARB	
	308421801R	KIT TAPPO X OMOL. EVO2 N. 52 FACTORY -R	
	308421741R	KIT COPPA POST.DX VERT. FACTORY-R Ø50	
	308421742R	KIT COPPA POST.SX VERT. FACTORY-R Ø54	
	088446002R	KIT RIC RIVESTIMENTO FACTORY CAR. L=350	
	416796R	KIT RICAMBIO LANA FACTORY L=350	
	206721R	KIT RIC TARGHETTA LEOVINCE CARBONIO	
8718S	KAWASAKI	ZZR 1400/ZX 14 R	2012-2015 Leovince FACTORY S - 2 SLIP-ON - STAINLESS STEEL
	KAWASAKI	ZX 14 R (US model only)	2012-2016
RICAMBI	308448501R	KIT fascetta FR2 CARBONIO MEDIA	
	308717203R	KIT SACCHETTO COLLETTORE N° 978 DX	
	300057530R	KIT fascetta 57 Inox	
	308717204R	KIT SACCHETTO COLLETTORE N.979 SX	
	308717601R	KIT SACCH MINUTERIA YAMAHA ZZR 1400 '12	
	303949001R	KIT RIC MOLLA-GOMM. ANTIVIB. CORTA	
	308447481R	KIT R CO DX IN CON D54 L=350 OM10059-60	
	308447482R	KIT R CO SX IN CON D54 L=350 OM10059-60	
	088421020R	KIT LAMELLE E RIVETTI OM. 10059-60	
	308420701R	KIT RICAMBIO COPPA POST. DX FACT CARB	
	308420702R	KIT RICAMBIO COPPA POST. SX FACT CARB	
	308421801R	KIT TAPPO X OMOL. EVO2 N. 52 FACTORY -R	
	308421741R	KIT COPPA POST.DX VERT. FACTORY-R Ø50	
	308421742R	KIT COPPA POST.SX VERT. FACTORY-R Ø54	
	088447034R	KIT RIC RIVESTIMENTO FACTORY INOX L=350	
	416796R	KIT RICAMBIO LANA FACTORY L=350	
8720E	TRIUMPH	TIGER EXPLORER (fits with original panniers)	2012-2015 Leovince LV ONE EVO - SLIP-ON - STAINLESS STEEL
RICAMBI	306960505R	KIT FASCETTA FB1S CARBONIO	
	308720202R	KIT SACCHETTO COLLETTORE N. 988	
	308720681R	KIT SACCH MINUT.TRIUMPH 1200 '12	
	308720001R	KIT SACC CARTER CARB TRIUMPH EXPL 1200	
	303949001R	KIT RIC MOLLA-GOMM. ANTIVIB. CORTA	
	308488481R	KIT R COR EVO IN R D54 BIG 0233/35 10400	
	088292004R	KIT LAMELLE E RIVETTI OM.0233 0235 10400	
	3014000701R	KIT RICAMBI COPPA POST.BIG VERTICALE CAR	
	307762801R	KIT TAPPO X OMOL. EVO2 N. 32B GPSTY	
	307242711R	KIT COPPA POST.FACT.VERT. D.54 EV.2	
	088291004R	KIT RIC RIVESTIMENTO FACT.DX BIG L=370	
	414205R	KIT RICAMBI LANA HT 800 Plus 850g	
8722	HONDA	XL 125 V VARADERO	2001 - 2006 Leovince SLIP-ON - LV ONE -INOX
	HONDA	XL 125 V VARADERO i.e.	2007 - 2013
RICAMBI	307550801R	dB-KILLER N. 33	
	205964VPR	COPPA T.P. LVONE VERT. PICCOL	
	303996501R	STAFFA 12T CARB. PIC. SING. DISAS	
	Contiene:		
	204677 N. 1 DISTANZIALE ALL ANOD.NERO		
	414205R	KIT MATERIALE FONOASSORBENTE SFUSO HT 800 PLUS 850g x X3/SBK + N 4 RIVETTI	
	088722004R	FODERO VERT. piccolo L=250mm	
	088722002R	LAMELLA RIVETTI 365.5X15 10105-9	

ART.	MARCA	MODELLO	TIPOLOGIA
200682R		RIVETTO 4,8X12,5 INOX	
303949001R		KIT RICAMBIO MOLLA A TRAZIONE CORTA	
308722471R		SILENZIATORE INOXØ45picc L=250 OM.10105	
307556202R		SACCH. COL179D HONDA XL125'01-'06	
Contiene:			
300041530	N. 1	FASCETTA 41 INOX	307556201 N. 1 COLLETTORE 179D
308722601R		SACCH. MINUTERIA x honda xl 125 '12	
Contiene:			
080191001	N. 1	STAFFA ALL.DIR L=62	200993 N. 1 BRUGOLA 8X40 T.C.E.I. Z.B.
200294	N. 2	PL-RONDELLA 8X17 PIANA Z.B.	202491 N. 1 BRUGOLA M8X30 T.C.E.I. Z.B.
200298	N. 1	DADO 8 FLANGIATO Z.B.	203532 N. 1 BOCCOLA 40X32X30 LGR/F
200360	N. 1	BRUGOLA M8X16 T.C.Z.B.	204321 N. 1 DISTANZIALE AL.SBK Ø27X8.5
200627	N. 1	GANCIO TIRAMOLLE	303949001 N. 1 MOLLA TRAZ.KTM+TUBETTO MONTATO
200678	N. 1	PL DISTANZIALE 20X22X8.5 ALL.	

8724	YAMAHA	WR 125 R - X i.e.	2009 - 2016	Leovince	SLIP-ON - LV ONE -INOX
<b>RICAMBI</b>	307550801R	dB-KILLER N. 33			
	308213801R	dB-KILLER N. 40			
	205964VPR	COPPA T.P. LVONE VERT. PICCOL			
	303996501R	STAFFA 12T CARB. PIC. SING. DISAS			
Contiene:					
	204677	N. 1 DISTANZIALE ALL ANOD.NERO			
	414205R	KIT MATERIALE FONOASSORBENTE SFUSO HT 800 PLUS 850g x X3/SBK + N 4 RIVETTI			
	088722004R	FODERO VERT. piccolo L=250mm			
	088722002R	LAMELLA RIVETTI 365.5X15 10105-9			
	200682R	RIVETTO 4,8X12,5 INOX			
	308722471R	SILENZIATORE INOXØ45picc L=250 OM.10105			
	303949001R	KIT RICAMBIO MOLLA A TRAZIONE CORTA			
	308724202R	SACCH. COLLETTORE N° 997 WR 125 R 12			
Contiene:					
	300038530	N. 1 FASCETTA 38 INOX	308724201	N. 1	COLLETTORE N°997
	308724601R	SACCH. MINUTERIA YAM.WR 125R-X i.e.'12			
Contiene:					
	088213001	N. 1 CARTER CARBONIO	201031	N. 2	BRUGOLA M5X12 T.B.E.I. INOX
	200294	N. 1 PL-RONDELLA 8X17 PIANA Z.B.	204321	N. 1	DISTANZIALE AL.SBK Ø27X8.5
	200319	N. 1 BRUGOLA M8X35 T.C.E.I. Z.B.	204406	N. 1	PIASTRINA FISSAGG. M8 Z.B.
	200360	N. 1 BRUGOLA M8X16 T.C.Z.B.	204555	N. 2	PIASTRINA FISSAGG. M5 Z.B.
	200371	N. 4 GUARNIZIONE 14X4,9X1,5 ROTONDA	303949001	N. 1	MOLLA TRAZ.KTM+TUBETTO MONTATO
	200414	N. 1 PL DISTANZIALE 20X10X8,5 ALL.	406580	N. 2	RONDELLA 5X15 INOX
	200627	N. 1 GANCIO TIRAMOLLE			

8725	KTM	DUKE 125 i.e.	2011 - 2016	Leovince	SLIP-ON - LV ONE -INOX
	KTM	DUKE 200 i.e.	2012 - 2014		
<b>RICAMBI</b>	307550801R	dB-KILLER N. 33			
	205964VPR	COPPA T.P. LVONE VERT. PICCOL			
	303996501R	STAFFA 12T CARB. PIC. SING. DISAS			
Contiene:					
	204677	N. 1 DISTANZIALE ALL ANOD.NERO			
	308725471R	SILENZIATORE INOX Ø50 picc L=250 OM.10105			
	414205R	KIT MATERIALE FONOASSORBENTE SFUSO HT 800 PLUS 850g x X3/SBK + N 4 RIVETTI			
	088722004R	FODERO VERT. piccolo L=250mm			
	088722002R	LAMELLA RIVETTI 365.5X15 10105-9			
	200682R	RIVETTO 4,8X12,5 INOX			
	303949001R	KIT RICAMBIO MOLLA A TRAZIONE CORTA			
	308566203R	SACCH.COLLETTORE N° 912 KTM DUKE 125			
Contiene:					
	300041530	N. 1 FASCETTA 41 INOX	308566201	N. 1	COLLETTORE ANT.912
	308725202R	SACCH. COLLETTORE N° 996 DUKE 125 '12			
Contiene:					
	308725201	N. 1 COLLETTORE N° 996			

ART.	MARCA	MODELLO	TIPOLOGIA			
		308725601R SACCH. MINUTERIA x KTM DUKE 125 '12 '12				
		Contiene:				
		088566001 N. 1 STAFFA INOX KTM DUKE 125	200360	N.	1	BRUGOLA M8X16 T.C.Z.B.
		200261 N. 2 BULLONE 6X20 Z.B. FLANGIATO	200627	N.	1	GANCIO TIRAMOLLE
		200291 N. 2 RONDELLA 6X12 PIANA Z.B.	201822	N.	2	DISTANZIALE 20X14X8.5 ALL.
		200294 N. 2 RONDELLA 8X17 PIANA Z.B.	204321	N.	1	DISTANZIALE AL.SBK Ø27X8.5
		200298 N. 2 DADO 8 FLANGIATO Z.B.	303949001	N.	2	MOLLA TRAZ.KTM+TUBETTO MONTATO
		200319 N. 2 BRUGOLA M8X35 T.C.E.I. Z.B.	307605501	N.	1	STAFFA INOX CON DADO SALD.
<b>8726</b>	YAMAHA	YZF-R 125 i.e.	2008 - 2013	Leovince	FULL SYSTEM 1/1 - LV ONE -INOX	
RICAMBI		307550801R dB-KILLER N. 33				
		205964VPR COPPA T.P. LVONE VERT. PICCOL				
		303996501R STAFFA 12T CARB. PIC. SING. DISAS				
		Contiene:				
		204677 N. 1 DISTANZIALE ALL ANOD.NERO				
		414205R KIT MATERIALE FONDAASSORBENTE SFUSO HT 800 PLUS 850g x X3/SBK + N 4 RIVETTI				
		088722004R FODERO VERT. piccolo L=250mm				
		088722002R LAMELLA RIVETTI 365.5X15 10105-9				
		200682R RIVETTO 4,8X12,5 INOX				
		303949001R KIT RICAMBIO MOLLA A TRAZIONE CORTA				
		308725471R SILENZIATORE INOXØ50picc L=250 OM.10105				
		308124202R SACCH. COLLETTORE PRIM. YAM.YZF 125R'08				
		Contiene:				
		205267 N. 1 FLANGIA 45E INOX	308124201	N.	1	COLLETTORE
		205268 N. 1 BOCCOLA INOX 41X26X21				
		308726601R SACCH. MINUTERIA X YAM. YZF 125 R '12				
		Contiene:				
		088124001 N. 1 STAFFA PIEG.INOX	202491	N.	1	BRUGOLA M8X30 T.C.E.I. Z.B.
		200298 N. 1 DADO 8 FLANGIATO Z.B.	204321	N.	1	DISTANZIALE AL.SBK Ø27X8.5
		200415 N. 1 PL DISTANZIALE 20X5X8,5 ALL	204785	N.	1	PL-DISTANZIALE ALL.20X3X8,5
		200627 N. 1 GANCIO TIRAMOLLE	303949001	N.	2	MOLLA TRAZ.KTM+TUBETTO MONTATO
		200722 N. 1 BRUGOLA M8X20 T.C.Z.B.				
<b>8740E</b>	KAWASAKI	NINJA 250 R	2013-2016	Leovince	LV ONE EVO - SLIP-ON - STAINLESS STEEL	
	KAWASAKI	Z 250	2015-2016			
	KAWASAKI	NINJA 300 R/ABS	2013-2016			
	KAWASAKI	NINJA 300 R/ABS (US model only)	2013-2017			
	KAWASAKI	Z 300/ABS	2015-2016			
RICAMBI		308741501R KIT fascetta FM8 CARBONIO Factory Media				
		307708801R KIT TAPPO X OMOL. EVO2 N. 41 4 FILE da3				
		308741202R KIT SACCH COLLETTORE 1003				
		300038530R KIT fascetta 38 Inox				
		308741681R KIT SACCHETTO MINUTERIA NINJA 300R				
		088741002R KIT CARTER CARBONIO X NINJA 300				
		303949001R KIT RIC MOLLA-GOMM. ANTIVIB. CORTA				
		308740481R KIT R COR EVO IN D50 L=300 OM0430-10382				
		0814170020R KIT LAMELLE E RIVETTI OM.0429 0430 10382				
		3014008701R KIT RICAMBIO COPPA POST. MEDIA VERT CARB				
		307919801R KIT TAPPO X OMOL. EVO2 N. 32BF GPSTY				
		308287711R KIT COPPA POST.M.VERT.D.54 EV.2+LUNG				
		083710014R KIT RIC RIVESTIMENTO DX VERT MEDIO L=300				
		414205R KIT RICAMBI LANA HT 800 Plus 850g				
<b>8741E</b>	KAWASAKI	NINJA 250 R	2013-2016	Leovince	LV ONE EVO - SLIP-ON - CARBON FIBER	
	KAWASAKI	Z 250	2015-2016			
	KAWASAKI	NINJA 300 R/ABS	2013-2016			
	KAWASAKI	NINJA 300 R/ABS (US model only)	2013-2017			
	KAWASAKI	Z 300/ABS	2015-2016			
RICAMBI		308741501R KIT fascetta FM8 CARBONIO Factory Media				
		307708801R KIT TAPPO X OMOL. EVO2 N. 41 4 FILE da3				
		308741202R KIT SACCH COLLETTORE 1003				
		300038530R KIT fascetta 38 Inox				
		308741681R KIT SACCHETTO MINUTERIA NINJA 300R				

ART.	MARCA	MODELLO	TIPOLOGIA
		088741002R KIT CARTER CARBONIO X NINJA 300	
		303949001R KIT RIC MOLLA-GOMM. ANTIVIB. CORTA	
		308741481R KIT R COR EV CAR D50 L=300 OM0430-10382	
		0814170022R KIT LAMELLE E RIVETTI OM.0237 0430 10382	
		3014008701R KIT RICAMBIO COPPA POST. MEDIA VERT CARB	
		307919801R KIT TAPPO X OMOL. EVO2 N. 32BF GPSTY	
		308287711R KIT COPPA POST.M.VERT.D.54 EV.2+LUNG	
		409117R KIT RIVESTIMENTO MED CARB 100X115 L=300	
		414205R KIT RICAMBI LANA HT 800 Plus 850g	
		206721R KIT RIC TARGHETTA LEOVINCE CARBONIO	
<b>8746E</b>	KAWASAKI	ZX-6R NINJA	2009-2016 Leovince LV ONE EVO - SLIP-ON - STAINLESS STEEL
	KAWASAKI	ZX-6R 636 NINJA	2013-2016
<b>RICAMBI</b>		306958501R KIT fascetta FM1 Factory Medio Verticale	
		308161202R KIT RICAMBIO COLLETTORE DX 698 KAW.ZX 6R	
		308161601R KIT SACCH.MINUT.KAWAS.ZX6R '09	
		307283602R KIT RICAMBI VALVOLA ZX-6R / 636 05	
		303949001R KIT RIC MOLLA-GOMM. ANTIVIB. CORTA	
		308412481R KIT R COR EV IN D54 MED L=250 OM.9634	
		088413002R KIT LAMELLE E RIVETTI OM.9634	
		3014008701R KIT RICAMBIO COPPA POST. MEDIA VERT CARB	
		307677801R KIT TAPPO X OMOL. EVO2 N. 32 BMW	
		308287711R KIT COPPA POST.M.VERT.D.54 EV.2+LUNG	
		088283004R KIT RIC RIVESTIMENTO FACT.DX MEDIO L=250	
		414205R KIT RICAMBI LANA HT 800 Plus 850g	
<b>8747E</b>	KAWASAKI	ZX-6R NINJA	2009-2016 Leovince LV ONE EVO - SLIP-ON - CARBON FIBER
	KAWASAKI	ZX-6R 636 NINJA	2013-2016
<b>RICAMBI</b>		306958501R KIT fascetta FM1 Factory Medio Verticale	
		308161202R KIT RICAMBIO COLLETTORE DX 698 KAW.ZX 6R	
		308161601R KIT SACCH.MINUT.KAWAS.ZX6R '09	
		307283602R KIT RICAMBI VALVOLA ZX-6R / 636 05	
		303949001R KIT RIC MOLLA-GOMM. ANTIVIB. CORTA	
		308413481R KIT R COR EV CAR D54 MED L=250 OM.9634	
		085096018R KIT LAMELLE E RIVETTI OM.9634 014	
		3014008701R KIT RICAMBIO COPPA POST. MEDIA VERT CARB	
		307677801R KIT TAPPO X OMOL. EVO2 N. 32 BMW	
		308287711R KIT COPPA POST.M.VERT.D.54 EV.2+LUNG	
		409118R KIT RIVESTIMENTO MED CARB 100X115 L=250	
		414205R KIT RICAMBI LANA HT 800 Plus 850g	
		206721R KIT RIC TARGHETTA LEOVINCE CARBONIO	
<b>8757E</b>	HONDA	CB 400 F/X (do not fit with original centre stand)	2013-2016 Leovince LV ONE EVO - SLIP-ON - STAINLESS STEEL
	HONDA	CBR 400 R	2013-2016
	HONDA	CB 500 F (do not fit with original centre stand)	2013-2015
	HONDA	CB 500 X (do not fit with original centre stand)	2013-2016
	HONDA	CBR 500 R	2013-2015
<b>RICAMBI</b>		303984501R KIT fascetta 22T CAR. MED. SING. DIS	
		307919801R KIT TAPPO X OMOL. EVO2 N. 32BF GPSTY	
		308758202R KIT SACCH COLLETTORE CB500F	
		300045530R KIT fascetta 45 Inox	
		308758601R KIT SACCH.MINUT.HONDA CBR 500 '13	
		308574001R KIT RIC MOLLA TRAZ SUPER CORTA + TUBETTO	
		308410481R KIT R COR EV IN D54 MED L300 0457 10410	
		088280002R KIT KAMELLE E RIVETTI OM.0457 10410	
		3014008701R KIT RICAMBIO COPPA POST. MEDIA VERT CARB	
		307762801R KIT TAPPO X OMOL. EVO2 N. 32B GPSTY	
		308287711R KIT COPPA POST.M.VERT.D.54 EV.2+LUNG	
		083710014R KIT RIC RIVESTIMENTO DX VERT MEDIO L=300	
		414205R KIT RICAMBI LANA HT 800 Plus 850g	
<b>8758E</b>	HONDA	CB 400 F/X (do not fit with original centre stand)	2013-2016 Leovince LV ONE EVO - SLIP-ON - CARBON FIBER
	HONDA	CBR 400 R	2013-2016
	HONDA	CB 500 F (do not fit with original centre stand)	2013-2015
	HONDA	CB 500 X (do not fit with original centre stand)	2013-2016
	HONDA	CBR 500 R	2013-2015

ART.	MARCA	MODELLO	TIPOLOGIA		
RICAMBI	303984501R	KIT fascetta 22T CAR. MED. SING. DIS			
	307919801R	KIT TAPPO X OMOL. EVO2 N. 32BF GPSTY			
	308758202R	KIT SACCH COLLETTORE CB500F			
	300045530R	KIT fascetta 45 Inox			
	308758601R	KIT SACCH.MINUT.HONDA CBR 500 '13			
	308574001R	KIT RIC MOLLA TRAZ SUPER CORTA + TUBETTO			
	308411481R	KIT R COR EV CAR D54 MED L300 0457 10410			
	088280002R	KIT KAMELLE E RIVETTI OM.0457 10410			
	3014008701R	KIT RICAMBIO COPPA POST. MEDIA VERT CARB			
	307762801R	KIT TAPPO X OMOL. EVO2 N. 32B GPSTY			
	308287711R	KIT COPPA POST.M.VERT.D.54 EV.2+LUNG			
	409117R	KIT RIVESTIMENTO MED CARB 100X115 L=300			
	414205R	KIT RICAMBI LANA HT 800 Plus 850g			
	206721R	KIT RIC TARGHETTA LEOVINCE CARBONIO			
<b>8760</b>	HONDA	CB 400/ 500 F i.e.	2013 - 2015	Leovince SLIP-ON - GP CORSA - CARBONIO	
	HONDA	CB 400/ 500 X i.e.	2013 - 2015		
	HONDA	CBR 400/ 500 R i.e.	2013 - 2015		
RICAMBI	307677801R	dB-KILLER N. 32			
	307919801R	dB-KILLER N. 32BF			
	205756VMR	COPPA T.P. LVONE VERT. MEDIA			
	303984501R	STAFFA 22T CAR. MED. SING. DIS			
	Contiene:				
	204677	N. 1	DISTANZIALE ALL ANOD.NERO		
	414205R	KIT MATERIALE FONASSORBENTE SFUSO HT 800 PLUS 850g x X3/SBK + N 4 RIVETTI			
	409117R	FODERO 100X115X300 FACTORY CARBO			
	085096022R	LAMELLA RIVETTI 365.5X15 0457			
	200682R	RIVETTO 4,8X12,5 INOX			
	303457473R	KIT RIC CORPO CUB TONDO CAR.LANA HT			
	308758202R	SACCH. COLLETTORE N° 1012x CBR 500R '13			
	Contiene:				
	300045530	N. 1	FASCETTA 45 INOX	308758201	N. 1 COLLETTORE N.1012
	308758601R	SACCH. MINUTERIA HONDA CBR 500 '13			
	Contiene:				
	200298	N. 1	DADO 8 FLANGIATO Z.B.	201222	N. 1 BRUGOLA M8X65 T.C.E.I.Z.B.
	200321	N. 1	PL-RONDELLA 8X24 PIANA Z.B.	204321	N. 1 DISTANZIALE AL.SBK Ø27X8,5
	200415	N. 1	PL DISTANZIALE 20X5X8,5 ALL	308574001	N. 1 MOLLA TRAZ.SUPER CORTA +TUBET
	200627	N. 1	GANCIO TIRAMOLLE		
<b>8771S</b>	TRIUMPH	STREET TRIPLE 675/R	2013-2016	Leovince FACTORY S - SLIP-ON - CARBON FIBER	
RICAMBI	308448501R	KIT fascetta FR2 CARBONIO MEDIA			
	308771202R	KIT SACCHETTO COLLETTORE N. 1016			
	300045530R	KIT fascetta 45 Inox			
	308771601R	KIT SACCH. MINUT.TRIUMPH TIGER '12			
	303949001R	KIT RIC MOLLA-GOMM. ANTIVIB. CORTA			
	308436481R	KIT R CORPO DX C Ø50 L270 O10057/8 10401			
	088421022R	KIT LAMELLE E RIVETTI OM.10057-58 10401			
	308420701R	KIT RICAMBIO COPPA POST. DX FACT CARB			
	308437801R	KIT TAPPO dB-KILLER N. 52B FACTORY R			
	308437741R	KIT COPPA POST.DX VERT. FACTORY-R Ø50			
	088420002R	KIT RIC RIVESTIMENTO FACT 270mm CARB			
	416797R	KIT RICAMBIO LANA FACTORY L=270			
	206721R	KIT RIC TARGHETTA LEOVINCE CARBONIO			
<b>8772S</b>	TRIUMPH	STREET TRIPLE 675/R	2013-2016	Leovince FACTORY S - SLIP-ON - STAINLESS STEEL	
RICAMBI	308448501R	KIT fascetta FR2 CARBONIO MEDIA			
	308771202R	KIT SACCHETTO COLLETTORE N. 1016			
	300045530R	KIT fascetta 45 Inox			
	308771601R	KIT SACCH. MINUT.TRIUMPH TIGER '12			
	303949001R	KIT RIC MOLLA-GOMM. ANTIVIB. CORTA			
	308437481R	KIT R CO DX CAR CO D50 270 10057/8 10401			

ART.	MARCA	MODELLO	TIPOLOGIA
		088421022R KIT LAMELLE E RIVETTI OM.10057-58 10401 308420701R KIT RICAMBIO COPPA POST. DX FACT CARB 308437801R KIT TAPPO dB-KILLER N. 52B FACTORY R 308437741R KIT COPPA POST.DX VERT. FACTORY-R Ø50 088421046R KIT RIC RIVESTIMENTO FACTORY INOX L=270 416797R KIT RICAMBIO LANA FACTORY L=270	
<b>8773E</b>	HONDA	CRF 250 L	2012-2013 Leovince LV ONE EVO - SLIP-ON - STAINLESS STEEL
RICAMBI		308749501R KIT RIC STAFFA V1 NEL SACCHETTO 308520801R KIT TAPPO X OMOL. EVO2 N. 54 4 FILE da 205261R KIT RIC BOCCOLA INOX 50X38X40 DIS.039/09 308773202R KIT SACCHETTO COLLETTORE N. 1017 DX 300028530R KIT fascetta 28 Inox 308773601R KIT SACCH.MINUT.X CRF 250 L '11 303949001R KIT RIC MOLLA-GOMM. ANTIVIB. CORTA 308406481R KIT R COR EVO IN D50 MED L=270 OM.0430 088282002R KIT LAMELLE E RIVETTI OM.0429 0430 3014008701R KIT RICAMBIO COPPA POST. MEDIA VERT CARB 307762801R KIT TAPPO X OMOL. EVO2 N. 32B GPSTY 308287711R KIT COPPA POST.M.VERT.D.54 EV.2+LUNG 088406004R KIT RIC RIVESTIMENTO FACT.DX MEDIO L=270 414205R KIT RICAMBI LANA HT 800 Plus 850g	
<b>8777E</b>	KAWASAKI	Z 800	2013-2016 Leovince LV ONE EVO - SLIP-ON - STAINLESS STEEL
RICAMBI		307572501R KIT FASCETTA FM4 CARBONIO 308778202R KIT SACCH COLLETTORE N.1019 308778601R KIT SACCH. MINUT.KAW. Z-800 '13 303949001R KIT RIC MOLLA-GOMM. ANTIVIB. CORTA 308410481R KIT R COR EV IN D54 MED L300 0457 10410 088280002R KIT KAMELLE E RIVETTI OM.0457 10410 3014008701R KIT RICAMBIO COPPA POST. MEDIA VERT CARB 307762801R KIT TAPPO X OMOL. EVO2 N. 32B GPSTY 308287711R KIT COPPA POST.M.VERT.D.54 EV.2+LUNG 083710014R KIT RIC RIVESTIMENTO DX VERT MEDIO L=300 414205R KIT RICAMBI LANA HT 800 Plus 850g	
<b>8778E</b>	KAWASAKI	Z 800	2013-2016 Leovince LV ONE EVO - SLIP-ON - CARBON FIBER
RICAMBI		307572501R KIT FASCETTA FM4 CARBONIO 308778202R KIT SACCH COLLETTORE N.1019 308778601R KIT SACCH. MINUT.KAW. Z-800 '13 303949001R KIT RIC MOLLA-GOMM. ANTIVIB. CORTA 308411481R KIT R COR EV CAR D54 MED L300 0457 10410 088280002R KIT KAMELLE E RIVETTI OM.0457 10410 3014008701R KIT RICAMBIO COPPA POST. MEDIA VERT CARB 307762801R KIT TAPPO X OMOL. EVO2 N. 32B GPSTY 308287711R KIT COPPA POST.M.VERT.D.54 EV.2+LUNG 409117R KIT RIVESTIMENTO MED CARB 100X115 L=300 414205R KIT RICAMBI LANA HT 800 Plus 850g 206721R KIT RIC TARGHETTA LEOVINCE CARBONIO	
<b>8782E</b>	KAWASAKI	Z 800 E	2013-2016 Leovince LV ONE EVO - SLIP-ON - STAINLESS STEEL
RICAMBI		307572501R KIT FASCETTA FM4 CARBONIO 308783202R KIT SACCHETTO COLLETTORE N.1024 300051530R KIT fascetta 51 Inox 308778601R KIT SACCH. MINUT.KAW. Z-800 '13 303949001R KIT RIC MOLLA-GOMM. ANTIVIB. CORTA 308410481R KIT R COR EV IN D54 MED L300 0457 10410 088280002R KIT KAMELLE E RIVETTI OM.0457 10410 3014008701R KIT RICAMBIO COPPA POST. MEDIA VERT CARB 307762801R KIT TAPPO X OMOL. EVO2 N. 32B GPSTY 308287711R KIT COPPA POST.M.VERT.D.54 EV.2+LUNG 083710014R KIT RIC RIVESTIMENTO DX VERT MEDIO L=300 414205R KIT RICAMBI LANA HT 800 Plus 850g	

ART.	MARCA	MODELLO		TIPOLOGIA
8783E	KAWASAKI	Z 800 E	2013-2016	Leovince LV ONE EVO - SLIP-ON - CARBON FIBER
RICAMBI	307572501R	KIT FASCETTA FM4 CARBONIO		
	308783202R	KIT SACCHETTO COLLETTORE N.1024		
	300051530R	KIT fascetta 51 Inox		
	308778601R	KIT SACCH. MINUT.KAW. Z-800 '13		
	303949001R	KIT RIC MOLLA-GOMM. ANTIVIB. CORTA		
	308411481R	KIT R COR EV CAR D54 MED L300 0457 10410		
	088280002R	KIT KAMELLE E RIVETTI OM.0457 10410		
	3014008701R	KIT RICAMBIO COPPA POST. MEDIA VERT CARB		
	307762801R	KIT TAPPO X OMOL. EVO2 N. 32B GPSTY		
	308287711R	KIT COPPA POST.M.VERT.D.54 EV.2+LUNG		
	409117R	KIT RIVESTIMENTO MED CARB 100X115 L=300		
	414205R	KIT RICAMBI LANA HT 800 Plus 850g		
	206721R	KIT RIC TARGHETTA LEOVINCE CARBONIO		
8784E	YAMAHA	FJR 1300 A/AS	2001-2015	Leovince LV ONE EVO - 2 SLIP-ON - STAINLESS STEEL
RICAMBI	306958501R	KIT fascetta FM1 Factory Medio Verticale		
	305482206R	KIT RICAMBI COLL. DX FJR 1300		
	300045530R	KIT fascetta 45 Inox		
	307206204R	KIT RICAMBI COLL. YAMAHA FJR 1300 OV		
	305482601R	KIT SACCH.MINUT.X YAMAHA FJR 1300		
	304982002R	KIT RIC MOLLA TRAZ.+TUBETTO MONTATO		
	308295481R	KIT RIC.COR EVO IN D50MED L=370 OM.0231		
	308295482R	KIT RIC.COR SX EV IN D50 ME L=370 OM0231		
	088296002R	KIT LAMELLE E RIVETTI OM.0231		
	3014008701R	KIT RICAMBIO COPPA POST. MEDIA VERT CARB		
	307762801R	KIT TAPPO X OMOL. EVO2 N. 32B GPSTY		
	308287711R	KIT COPPA POST.M.VERT.D.54 EV.2+LUNG		
	083980016R	KIT RIC RIVESTIMENTO VERT.DX MEDIO L=370		
	083980018R	KIT RIC RIVESTIMENTO VERT.SX MEDIO L=370		
	414205R	KIT RICAMBI LANA HT 800 Plus 850g		
8786E	BMW	R 1200 GS (fits with original panniers)	2013-2016	Leovince LV ONE EVO - SLIP-ON - STAINLESS STEEL
	BMW	R 1200 GS ADVENTURE (fits with original panniers)	2013-2016	
RICAMBI	306960505R	KIT FASCETTA FB1S CARBONIO		
	308787202R	KIT SACCHETTO COLLETTORE N°1032		
	308787681R	KIT RICAMBIO MINUTERIA BMW GS 1200 '13		
	308787001R	KIT SACCHET CARTER CARBONIO BMW R1200 GS		
	308574001R	KIT RIC MOLLA TRAZ SUPER CORTA + TUBETTO		
	308291481R	KIT R COR EVO IN R D54 BIG 0233/35 10400		
	088292004R	KIT LAMELLE E RIVETTI OM.0233 0235 10400		
	3014000701R	KIT RICAMBI COPPA POST.BIG VERTICALE CAR		
	307762801R	KIT TAPPO X OMOL. EVO2 N. 32B GPSTY		
	307242711R	KIT COPPA POST.FACT.VERT. D.54 EV.2		
	088291004R	KIT RIC RIVESTIMENTO FACT.DX BIG L=370		
	414205R	KIT RICAMBI LANA HT 800 Plus 850g		
8787E	BMW	R 1200 GS (fits with original panniers)	2013-2016	Leovince LV ONE EVO - SLIP-ON - CARBON FIBER
	BMW	R 1200 GS ADVENTURE (fits with original panniers)	2013-2016	
RICAMBI	306960505R	KIT FASCETTA FB1S CARBONIO		
	308787202R	KIT SACCHETTO COLLETTORE N°1032		
	308787681R	KIT RICAMBIO MINUTERIA BMW GS 1200 '13		
	308787001R	KIT SACCHET CARTER CARBONIO BMW R1200 GS		
	308574001R	KIT RIC MOLLA TRAZ SUPER CORTA + TUBETTO		
	308292481R	KIT R COR EV CAR R D54 BIG 0233/35 10400		
	088425008R	KIT LAMELLE E RIVETTI OM.0233 0235 10400		
	3014000701R	KIT RICAMBI COPPA POST.BIG VERTICALE CAR		
	307762801R	KIT TAPPO X OMOL. EVO2 N. 32B GPSTY		
	307242711R	KIT COPPA POST.FACT.VERT. D.54 EV.2		
	408543R	KIT RIVESTIMENTO BIG CARB 110X125 L=370		
	414205R	KIT RICAMBI LANA HT 800 Plus 850g		
	206721R	KIT RIC TARGHETTA LEOVINCE CARBONIO		



ART.	MARCA	MODELLO		TIPOLOGIA
8788E	SUZUKI	BURGMAN 650	2013-2016	Leovince LV ONE EVO - FULL SYSTEM 2/1 - STAINLESS STEEL
RICAMBI	308562501R	KIT fascetta FB5AS CARBONIO LVONE		
	304151201R	KIT RICAMBI COLLETTORE PRIM DX 4151		
	304151202R	KIT RICAMBI COLLETTORE PRIM SX 4151		
	304151203R	KIT SACCHETTO COLLETTORE 4 ROAD SECOND 4		
	308788202R	KIT SACCH COLLETTORE FINALE BURGMAN		
	5682	KIT TAPPO SONDA LAMBDA M18 BASE + GUARN		
	308788601R	KIT SACCH.MIN. SUZUKI BURGMAN 650		
	304982002R	KIT RIC MOLLA TRAZ.+TUBETTO MONTATO		
	308424481R	KIT R COR EV IN RETE D50 BIG 0230 10399		
	088425010R	KIT LAMELLE E RIVETTI OM.0230 10399		
	3014000701R	KIT RICAMBI COPPA POST.BIG VERTICALE CAR		
	307762801R	KIT TAPPO X OMOL. EVO2 N. 32B GPSTY		
	307242711R	KIT COPPA POST.FACT.VERT. D.54 EV.2		
	088291004R	KIT RIC RIVESTIMENTO FACT.DX BIG L=370		
	414205R	KIT RICAMBI LANA HT 800 Plus 850g		
8790E	HONDA	CBR 600 RR/ABS	2013-2016	Leovince LV ONE - SLIP-ON - STAINLESS STEEL
RICAMBI	307002503R	KIT fascetta FM3 Factory Medio Orizzontale		
	307730203R	KIT SACCHETTO COLLETTORE N. 486 ANTERIOR		
	300051530R	KIT fascetta 51 Inox		
	308791202R	KIT SACCHETTO COLLETTORE N. 1037		
	308791601R	KIT SACCH.MINUT.HONDA CBR 600 '13		
	303949001R	KIT RIC MOLLA-GOMM. ANTIVIB. CORTA		
	308279481R	KIT RIC COR E IN D54 MED L300 0457 10410		
	088280002R	KIT KAMELLE E RIVETTI OM.0457 10410		
	2057570MR	KIT RIC COPPA LV-ONE MEDIA ORIZ.		
	307762801R	KIT TAPPO X OMOL. EVO2 N. 32B GPSTY		
	308284711R	KIT COPPA POST.M.ORIZ.d.54 O6406+LUNG		
	083710014R	KIT RIC RIVESTIMENTO DX VERT MEDIO L=300		
	414205R	KIT RICAMBI LANA HT 800 Plus 850g		
8791E	HONDA	CBR 600 RR/ABS	2013-2016	Leovince LV ONE - SLIP-ON - CARBON FIBER
RICAMBI	307002503R	KIT fascetta FM3 Factory Medio Orizzontale		
	307730203R	KIT SACCHETTO COLLETTORE N. 486 ANTERIOR		
	300051530R	KIT fascetta 51 Inox		
	308791202R	KIT SACCHETTO COLLETTORE N. 1037		
	308791601R	KIT SACCH.MINUT.HONDA CBR 600 '13		
	303949001R	KIT RIC MOLLA-GOMM. ANTIVIB. CORTA		
	308280481R	KIT RIC COR E CA D54 MED L300 0457 10410		
	085096014R	KIT LAMELLE E RIVET 0457 0237 0430 10410		
	2057570MR	KIT RIC COPPA LV-ONE MEDIA ORIZ.		
	307762801R	KIT TAPPO X OMOL. EVO2 N. 32B GPSTY		
	308284711R	KIT COPPA POST.M.ORIZ.d.54 O6406+LUNG		
	409117R	KIT RIVESTIMENTO MED CARB 100X115 L=300		
	414205R	KIT RICAMBI LANA HT 800 Plus 850g		
	206721R	KIT RIC TARGHETTA LEOVINCE CARBONIO		
8796	YAMAHA	MT-07/FZ-07/ABS	2014-2016	Leovince UNDERBODY - FULL SYSTEM 2/1 - STAINLESS STEEL
	YAMAHA	FZ-07 (US model only)	2015-2016	
RICAMBI	3014030205R	KIT SACCHETTO COLLETTORE PRIMARIO XSR700		
	204833R	KIT RIC BOCCOLA INOX DIS.028/06		
	204569R	KIT RIC FLANGIA INOX 112 A DIS.195/04		
	3014148202R	KIT SACCHETTO COLLETTORE BIFORCA XSR 700		
	5684	KIT TAPPO SONDA LAMBDA M12 BASE + GUARN		
	3014148601R	KIT SACCH. MINUT. YAMAHA XSR 700 '16		
	303949001R	KIT RIC MOLLA-GOMM. ANTIVIB. CORTA		
	3014148471R	KIT RIC CORPO Ø150 L=205 OM.10034 10417		
	088232014R	KIT LAMELLE E RIVETTI OM.10034/42 10417		
	308232701R	KIT COPPA POST.UNDERBODY CARB		
	204790R	KIT RIC GOMMINO COPPE CARBONIO D.007/06		
	308232801R	KIT TAPPO X OMOL. EVO2 UNDER Xd.50 N. 47		

ART.	MARCA	MODELLO		TIPOLOGIA
		3014148750R 8066	KIT RIC RIVESTIMENTO UNDER CORTO L=205 KIT RICAMBIO MATERIALE FONOASS UNDERBODY	
<b>8797</b>	YAMAHA	MT-09/FZ-09/ABS		2013-2016 Leovince UNDERBODY - FULL SYSTEM 3/1 - STAINLESS STEEL
<b>RICAMBI</b>		308797204R 204870R 204448R 308797206R 308797601R 303949001R 308797471R 088232014R 308232701R 204790R 308232801R 308232750R 8066	KIT RICAMBIO SACC COLL PRIM. X MT09 '14 KIT RICAMBIO BOCCOLA INOX DIS.094/06 KIT RIC FLANGIA INOX 46 D DIS.086/04 KIT RICAMBIO SACC TRIFORCA FIN. MT09 '14 KIT SACCHETTO MINUT. MT09 '14 KIT RIC MOLLA-GOMM. ANTIVIB. CORTA KIT RIC CORPO Øi50L=205 O.10034/42 10417 KIT LAMELLE E RIVETTI OM.10034/42 10417 KIT COPPA POST.UNDERBODY CARB KIT RIC GOMMINO COPPE CARBONIO D.007/06 KIT TAPPO X OMOL. EVO2 UNDER Xd.50 N. 47 KIT RIC RIVESTIMENTO UNDER CORTO L=205 KIT RICAMBIO MATERIALE FONOASS UNDERBODY	
<b>8798S</b>	HONDA	CBR 1000 RR/SP/ABS		2014-2016 Leovince FACTORY S - SLIP-ON - STAINLESS STEEL
<b>RICAMBI</b>		308444501R 308798202R 300063530R 308798601R 303949001R 308421481R 088421026R 308420701R 308421801R 308421741R 088421046R 416797R	KIT fascetta FR3 CARBONIO PICCOLA KIT RICAMBIO SACC COLL POST CBR1000 RR KIT fascetta 63 Inox KIT SACCH. MINUT. CBR 1000 RR '13/'15 KIT RIC MOLLA-GOMM. ANTIVIB. CORTA KIT R CO DX IN C D54 L=270 10057/8 10395 KIT LAMELLE E RIVETTI OM.10057-58 10395 KIT RICAMBIO COPPA POST. DX FACT CARB KIT TAPPO X OMOL. EVO2 N. 52 FACTORY -R KIT COPPA POST.DX VERT. FACTORY-R Ø50 KIT RIC RIVESTIMENTO FACTORY INOX L=270 KIT RICAMBIO LANA FACTORY L=270	
<b>8799</b>	YAMAHA	MT-125/ABS		2014-2016 Leovince LV ONE - FULL SYSTEM 1/1 - STAINLESS STEEL
	YAMAHA	YZF-R 125/ABS		2014-2016
<b>RICAMBI</b>		303804501R 308799202R 308799601R 303949001R 308725471R 088722002R 205964VPR 307550801R 307550711R 088722004R 414205R	KIT fascetta 11T CARBONIO PIC.SING.CENTR KIT SACCHETTO COLLETTORE PRIMARIO KIT SACCH. MIN. YAM MT 125 - YZF-R 125 KIT RIC MOLLA-GOMM. ANTIVIB. CORTA KIT RIC COR d.50 PICC INO L=250 OM.10105 KIT LAMELLE E RIVETTI OM.10105-9 KIT RIC COPPA PLASTIC LVONE VERT.PICCOLA KIT TAPPO DB Killer N°33 Ovale KIT COPPA POST.MEDIA VERT. diametro 45 KIT RIC RIVESTIMENTO VERT. PICCOLO L=250 KIT RICAMBI LANA HT 800 Plus 850g	
<b>9700</b>	HONDA	PCX 125 i.e. (Type JF2812)		2012 - 2016 Leovince GRANTURISMO - IMP. C. 1/1
	HONDA	PCX 150 i.e.		2012 - 2016
<b>RICAMBI</b>		205984R 5608D49 303491471R 309700201R 309700601R	BOCCOLA IN GRAFITE LGR/F Øe.46 Øi.40 h30 FASCETTA Ø 49 INOX (300049533) SILENZIATORE GT STAFFA AVANZATA COLLETTORE N°1011 PCX 150 '12 SACCH. MINUTERIA 9700 GT	
		Contiene:		
		200321 N. 3 RONDELLA 8X24 PIANA Z.B.	203335 N. 3 BULLONE 8X30 Z.B.	
		200349 N. 3 RONDELLA 10 GROWER Z.B.	203518 N. 3 RONDELLA 10X20 PIANA Z.B.	
		200361 N. 3 RONDELLA 8X14 GROWER Z.B.	204089 N. 3 VITE M10X25 PASSO 1.25 T.E.Z.B	
		201525 N. 1 GUARNIZIONE 33X26,15X4 SPIR.	303427502 N. 1 STAFFA INOX	
<b>9702</b>	HONDA	PCX 125 i.e. (Type JF2812)		2012 - 2016 Leovince IMP. C. 1/1 - GP CORSA - CARBONIO
	HONDA	PCX 150 i.e.		2012 - 2016
<b>RICAMBI</b>		205984R 5608D49	BOCCOLA IN GRAFITE LGR/F Øe.46 Øi.40 h30 FASCETTA Ø 49 INOX (300049533)	

ART.	MARCA	MODELLO				TIPOLOGIA
		303457473R	KIT RIC CORPO CUB TONDO CAR.LANA HT			
		309700201R	COLLETTORE N°1011 PCX 150 '12			
		309700601R	SACCH. MINUTERIA 9700 GT			
		Contiene:				
		200321	N.	3	RONDELLA 8X24 PIANA Z.B.	203335 N. 3 BULLONE 8X30 Z.B.
		200349	N.	3	RONDELLA 10 GROWER Z.B.	203518 N. 3 RONDELLA 10X20 PIANA Z.B.
		200361	N.	3	RONDELLA 8X14 GROWER Z.B.	204089 N. 3 VITE M10X25 PASSO 1.25 T.E.Z.B
		201525	N.	1	GUARNIZIONE 33X26,15X4 SPIR.	303427502 N. 1 STAFFA INOX
<b>9704</b>	HONDA	SH 125i/ABS			2013 - 2016	Leovince GRANTURISMO - IMP. COMP. 1/1
	HONDA	SH 150i/ABS			2013 - 2016	Leovince
<b>RICAMBI</b>		205984R	BOCCOLA IN GRAFITE LGR/F Øe.46 Øi.40 h30			
		5608D49	FASCETTA Ø 49 INOX (300049533)			
		303428471R	SILENZIATORE GT STAFFA ARRETRATA			
		309704201R	COLLETTORE N°1014 SH 125 '13			
		309704601R	SACCH. MINUTERIA 9704 GT			
		Contiene:				
		200321	N.	3	PL-RONDELLA 8X24 PIANA Z.B.	203335 N. 3 BULLONE 8X30 Z.B.
		200349	N.	3	RONDELLA 10 GROWER Z.B.	203518 N. 3 RONDELLA 10X20 PIANA Z.B.
		200361	N.	3	RONDELLA 8X14 GROWER Z.B.	204083 N. 3 BULLONE 10X30 PASSO 1.25 TE ZB
		201525	N.	1	GUARNIZIONE 33X26,15X4 SPIR.	309704502 N. 1 STAFFA INOX
<b>9726</b>	HONDA	MSX 125/GROM			2013 - 2015	Leovince GP CORSA - SLIP ON -CARBONIO
<b>RICAMBI</b>		205984R	BOCCOLA IN GRAFITE LGR/F Øe.46 Øi.40 h30			
		5608D49	FASCETTA Ø 49 INOX (300049533)			
		303277473R	KIT RIC CORPO CUB TONDO CAR.LANA HTØ45			
		309704201R	COLLETTORE N°1014 SH 125 '13			
		309704601R	SACCH. MINUTERIA 9704 GT			
		Contiene:				
		200321	N.	3	PL-RONDELLA 8X24 PIANA Z.B.	203335 N. 3 BULLONE 8X30 Z.B.
		200349	N.	3	RONDELLA 10 GROWER Z.B.	203518 N. 3 RONDELLA 10X20 PIANA Z.B.
		200361	N.	3	RONDELLA 8X14 GROWER Z.B.	204083 N. 3 BULLONE 10X30 PASSO 1.25 TE ZB
		201525	N.	1	GUARNIZIONE 33X26,15X4 SPIR.	309704502 N. 1 STAFFA INOX
<b>14000</b>	YAMAHA	T-MAX 530			2012-2016	Leovince NERO - FULL SYSTEM 2/1 - STAINLESS STEEL
<b>RICAMBI</b>		308108203R	KIT SACCH BIFORCAZIONE SEC. YAM.T-MAX			
		308108204R	KIT SACCH COLLETT FINALE DX YAM. T-MAX			
		5684	KIT TAPPO SONDA LAMBDA M12 BASE + GUARN			
		308588202R	KIT RICAMBIO COLL PRIMARIO T-MAX 530			
		308108601R	KIT SACCHETTO MINUT.YAMAHA T-MAX '08			
		304982002R	KIT RIC MOLLA TRAZ.+TUBETTO MONTATO			
		3014000471R	KIT RIC CORPO d.i50 BIG INOX 0230 10399			
		088425010R	KIT LAMELLE E RIVETTI OM.0230 10399			
		3014000701R	KIT RICAMBI COPPA POST.BIG VERTICALE CAR			
		204790R	KIT RIC GOMMINO COPPE CARBONIO D.007/06			
		307762801R	KIT TAPPO X OMOL. EVO2 N. 32B GPSTY			
		3014000750VLR	KIT RIC RIVESTIMENTO MEDIO L=370 NERO			
		414205R	KIT RICAMBI LANA HT 800 Plus 850g			
<b>14001</b>	YAMAHA	X-MAX 400			2013-2016	Leovince NERO - SLIP-ON - STAINLESS STEEL
<b>RICAMBI</b>		307919801R	KIT TAPPO X OMOL. EVO2 N. 32BF GPSTY			
		3014001202R	KIT SACCHETTO COL.N.1039 YAM. X-MAX 400			
		300038530R	KIT fascetta 38 Inox			
		308078804R	KIT RIC TAPPO N.57 x SCOOTERONI			
		3014001601R	KIT SACCH. MINUT. X-MAX 400 '13			
		303949001R	KIT RIC MOLLA-GOMM. ANTIVIB. CORTA			
		3014000471R	KIT RIC CORPO d.i50 BIG INOX 0230 10399			
		088425010R	KIT LAMELLE E RIVETTI OM.0230 10399			
		3014000701R	KIT RICAMBI COPPA POST.BIG VERTICALE CAR			
		204790R	KIT RIC GOMMINO COPPE CARBONIO D.007/06			
		307762801R	KIT TAPPO X OMOL. EVO2 N. 32B GPSTY			
		3014000750VLR	KIT RIC RIVESTIMENTO MEDIO L=370 NERO			
		414205R	KIT RICAMBI LANA HT 800 Plus 850g			

ART.	MARCA	MODELLO	TIPOLOGIA
14002	SUZUKI	BURGMAN 650	2013-2016 Leovince NERO - FULL SYSTEM 2/1 - STAINLESS STEEL
RICAMBI	304151201R	KIT RICAMBI COLLETTORE PRIM DX 4151	
	304151202R	KIT RICAMBI COLLETTORE PRIM SX 4151	
	304151203R	KIT SACCHETTO COLLETTORE 4 ROAD SECOND 4	
	308788202R	KIT SACCH COLLETTORE FINALE BURGMAN	
	5684	KIT TAPPO SONDA LAMBDA M12 BASE + GUARN	
	308788601R	KIT SACCH.MIN. SUZUKI BURGMAN 650	
	304982002R	KIT RIC MOLLA TRAZ.+TUBETTO MONTATO	
	3014000471R	KIT RIC CORPO d.i50 BIG INOX 0230 10399	
	088425010R	KIT LAMELLE E RIVETTI OM.0230 10399	
	3014000701R	KIT RICAMBI COPPA POST.BIG VERTICALE CAR	
	204790R	KIT RIC GOMMINO COPPE CARBONIO D.007/06	
	307762801R	KIT TAPPO X OMOL. EVO2 N. 32B GPSTY	
	3014000750VLR	KIT RIC RIVESTIMENTO MEDIO L=370 NERO	
	414205R	KIT RICAMBI LANA HT 800 Plus 850g	
14004	TRIUMPH	TIGER EXPLORER (fits with original panniers)	2012-2015 Leovince NERO - SLIP-ON - STAINLESS STEEL
RICAMBI	308720202R	KIT SACCHETTO COLLETTORE N. 988	
	308720681R	KIT SACCH MINUT.TRIUMPH 1200 '12	
	308720001R	KIT SACC CARTER CARB TRIUMPH EXPL 1200	
	303949001R	KIT RIC MOLLA-GOMM. ANTIVIB. CORTA	
	3014004471R	KIT RIC CORPO d.i54 BIG IN 0233/35 10400	
	088292004R	KIT LAMELLE E RIVETTI OM.0233 0235 10400	
	3014000701R	KIT RICAMBI COPPA POST.BIG VERTICALE CAR	
	204790R	KIT RIC GOMMINO COPPE CARBONIO D.007/06	
	307762801R	KIT TAPPO X OMOL. EVO2 N. 32B GPSTY	
	3014000750VLR	KIT RIC RIVESTIMENTO MEDIO L=370 NERO	
	414205R	KIT RICAMBI LANA HT 800 Plus 850g	
14005	PIAGGIO	MP3 400/LT/RST	2007-2012 Leovince NERO - SLIP-ON - STAINLESS STEEL
	PIAGGIO	MP3 500/BUSINESS/LT/SPORT	2011-2016
RICAMBI	308078804R	KIT RIC TAPPO N.57 x SCOOTERONI	
	308490202R	KIT RICAMBI COLLETTORE N°881 DX	
	300041530R	KIT fascetta 41 Inox	
	3014005601R	KIT RICAMBIO MINUTERIA PIAGGIO MP3 400	
	303949001R	KIT RIC MOLLA-GOMM. ANTIVIB. CORTA	
	3014000471R	KIT RIC CORPO d.i50 BIG INOX 0230 10399	
	088425010R	KIT LAMELLE E RIVETTI OM.0230 10399	
	3014000701R	KIT RICAMBI COPPA POST.BIG VERTICALE CAR	
	204790R	KIT RIC GOMMINO COPPE CARBONIO D.007/06	
	307762801R	KIT TAPPO X OMOL. EVO2 N. 32B GPSTY	
	3014000750VLR	KIT RIC RIVESTIMENTO MEDIO L=370 NERO	
	414205R	KIT RICAMBI LANA HT 800 Plus 850g	
14006	TRIUMPH	TIGER 800 XC/XCA/XCX/XR/XRX (fits with original panniers)	2011-2016 Leovince NERO - SLIP-ON - STAINLESS STEEL
RICAMBI	3014006202R	KIT SACCHETTO COL.N.1038 TIGER 800 '12	
	3014006601R	KIT SACCH. MINUT. X-MAX 400 '13	
	303949001R	KIT RIC MOLLA-GOMM. ANTIVIB. CORTA	
	3014000471R	KIT RIC CORPO d.i50 BIG INOX 0230 10399	
	088425010R	KIT LAMELLE E RIVETTI OM.0230 10399	
	3014000701R	KIT RICAMBI COPPA POST.BIG VERTICALE CAR	
	204790R	KIT RIC GOMMINO COPPE CARBONIO D.007/06	
	307762801R	KIT TAPPO X OMOL. EVO2 N. 32B GPSTY	
	3014000750VLR	KIT RIC RIVESTIMENTO MEDIO L=370 NERO	
	414205R	KIT RICAMBI LANA HT 800 Plus 850g	
14007	KAWASAKI	Z 750	2007-2014 Leovince NERO - SLIP-ON - STAINLESS STEEL
	KAWASAKI	Z 750 R	2011-2014
RICAMBI	3014007202R	KIT RICAMBI COLL. N° 1041 KAWASAKI Z 750	
	3014007601R	KIT SACCH. MINUT. KAW. Z 750 '12	
	303949001R	KIT RIC MOLLA-GOMM. ANTIVIB. CORTA	
	3014008471R	KIT RIC CORPO d.54 MEDIO INOX 0457 10410	
	088280002R	KIT KAMELLE E RIVETTI OM.0457 10410	

ART.	MARCA	MODELLO	TIPOLOGIA
		3014008701R 204790R 307762801R 3014008750VLR 414205R	KIT RICAMBIO COPPA POST. MEDIA VERT CARB KIT RIC GOMMINO COPPE CARBONIO D.007/06 KIT TAPPO X OMOL. EVO2 N. 32B GPSTY KIT RIC RIVESTIMENTO MEDIO L=300 NERO KIT RICAMBI LANA HT 800 Plus 850g
<b>14008</b>	KAWASAKI	Z 800	2013-2016 Leovince NERO - SLIP-ON - STAINLESS STEEL
RICAMBI		308778202R 308778601R 303949001R 3014008471R 088280002R 3014008701R 204790R 307762801R 3014008750VLR 414205R	KIT SACCH COLLETTORE N.1019 KIT SACCH. MINUT.KAW. Z-800 '13 KIT RIC MOLLA-GOMM. ANTIVIB. CORTA KIT RIC CORPO d.54 MEDIO INOX 0457 10410 KIT KAMELLE E RIVETTI OM.0457 10410 KIT RICAMBIO COPPA POST. MEDIA VERT CARB KIT RIC GOMMINO COPPE CARBONIO D.007/06 KIT TAPPO X OMOL. EVO2 N. 32B GPSTY KIT RIC RIVESTIMENTO MEDIO L=300 NERO KIT RICAMBI LANA HT 800 Plus 850g
<b>14009</b>	HONDA	INTEGRA 700/DCT/ABS	2012-2013 Leovince NERO - SLIP-ON - STAINLESS STEEL
	HONDA	NC 700 S/X/DCT/ABS	2012-2013
	HONDA	INTEGRA 750/DCT/ABS	2014-2015
	HONDA	NC 750 S/X/DCT/ABS	2014-2015
RICAMBI		3014009202R 300041530R 3014009601R 303949001R 3014009471R 088282004R 3014008701R 204790R 307762801R 3014008750VLR 414205R	KIT SACCHETTO COLLET N.1042 INTEGRA 700 KIT fascetta 41 Inox KIT SACCH. MINUT. INTEGRA 700 '13 KIT RIC MOLLA-GOMM. ANTIVIB. CORTA KIT RIC CORPO d.i50 MEDIO IN 0430 10394 KIT LAMELLE E RIVETTI OM.0430 0457 10394 KIT RICAMBIO COPPA POST. MEDIA VERT CARB KIT RIC GOMMINO COPPE CARBONIO D.007/06 KIT TAPPO X OMOL. EVO2 N. 32B GPSTY KIT RIC RIVESTIMENTO MEDIO L=300 NERO KIT RICAMBI LANA HT 800 Plus 850g
<b>14010</b>	SUZUKI	GSR/GSX-S 750	2011-2016 Leovince NERO - SLIP-ON - STAINLESS STEEL
RICAMBI		308544202R 300045530R 308544601R 303949001R 3014009471R 088282004R 3014008701R 204790R 307762801R 3014008750VLR 414205R	KIT SACCHETTO COLLETTORE N.907 KIT fascetta 45 Inox KIT SACCH MINUTERIA SUZUKI GSR 750 '11 KIT RIC MOLLA-GOMM. ANTIVIB. CORTA KIT RIC CORPO d.i50 MEDIO IN 0430 10394 KIT LAMELLE E RIVETTI OM.0430 0457 10394 KIT RICAMBIO COPPA POST. MEDIA VERT CARB KIT RIC GOMMINO COPPE CARBONIO D.007/06 KIT TAPPO X OMOL. EVO2 N. 32B GPSTY KIT RIC RIVESTIMENTO MEDIO L=300 NERO KIT RICAMBI LANA HT 800 Plus 850g
<b>14011</b>	KYMCO	XCITING 400i	2012-2016 Leovince NERO - SLIP-ON - STAINLESS STEEL
RICAMBI		308078804R 3014011202R 3014011601R 300041530R 300035533R 303949001R 3014000471R 088425010R 3014000701R 204790R 307762801R 3014000750VLR 414205R	KIT RIC TAPPO N.57 x SCOOTERONI KIT SACCHETTO COLLET N1046 KYMCO XCITING KIT SACCH. MINUT. KYMCO XCITING 400 i.e. KIT fascetta 41 Inox KIT fascetta 35 Inox con gancio KIT RIC MOLLA-GOMM. ANTIVIB. CORTA KIT RIC CORPO d.i50 BIG INOX 0230 10399 KIT LAMELLE E RIVETTI OM.0230 10399 KIT RICAMBI COPPA POST.BIG VERTICALE CAR KIT RIC GOMMINO COPPE CARBONIO D.007/06 KIT TAPPO X OMOL. EVO2 N. 32B GPSTY KIT RIC RIVESTIMENTO MEDIO L=370 NERO KIT RICAMBI LANA HT 800 Plus 850g
<b>14012</b>	SUZUKI	V-STROM 1000 (fits with original panniers)	2014-2016 Leovince NERO - SLIP-ON - STAINLESS STEEL
		V-STROM 1000 (fits with original panniers) (US model only)	2014-2017

ART.	MARCA	MODELLO		TIPOLOGIA
RICAMBI	3014047202R 300057530R 3014012601R 303949001R 3014000471R 088425010R 3014000701R 204790R 307762801R 3014000750VLR 414205R	KIT SACCHETTO COLLETTORE N°1138 KIT fascetta 57 Inox KIT SACCH. MINUT. SUZUKY V-STROM 1000 KIT RIC MOLLA-GOMM. ANTIVIB. CORTA KIT RIC CORPO d.i50 BIG INOX 0230 10399 KIT LAMELLE E RIVETTI OM.0230 10399 KIT RICAMBI COPPA POST.BIG VERTICALE CAR KIT RIC GOMMINO COPPE CARBONIO D.007/06 KIT TAPPO X OMOL. EVO2 N. 32B GPSTY KIT RIC RIVESTIMENTO MEDIO L=370 NERO KIT RICAMBI LANA HT 800 Plus 850g		
14013	YAMAHA	T-MAX 500	2008-2011	Leovince NERO - FULL SYSTEM 2/1 - STAINLESS STEEL
RICAMBI	308108203R 308108201R 308108204R 5684 308108601R 304982002R 3014000471R 088425010R 3014000701R 204790R 307762801R 3014000750VLR 414205R	KIT SACCH BIFORCAZIONE SEC. YAM.T-MAX KIT SACCH COLL PRIM.DX-SX YAM. T-MAX '08 KIT SACCH COLLETT FINALE DX YAM. T-MAX KIT TAPPO Sonda LAMBDA M12 BASE + GUARN KIT SACCHETTO MINUT.YAMAHA T-MAX '08 KIT RIC MOLLA TRAZ.+TUBETTO MONTATO KIT RIC CORPO d.i50 BIG INOX 0230 10399 KIT LAMELLE E RIVETTI OM.0230 10399 KIT RICAMBI COPPA POST.BIG VERTICALE CAR KIT RIC GOMMINO COPPE CARBONIO D.007/06 KIT TAPPO X OMOL. EVO2 N. 32B GPSTY KIT RIC RIVESTIMENTO MEDIO L=370 NERO KIT RICAMBI LANA HT 800 Plus 850g		
14014	DUCATI	HYPERMOTARD/HYPERSTRADA 821	2013-2016	Leovince NERO - SLIP-ON - STAINLESS STEEL
RICAMBI	3014014202R 3014014601R 303949001R 3014008471R 088280002R 3014008701R 204790R 307762801R 3014008750VLR 414205R	KIT SACCHETTO COL.N. 1048 DUCATI HYPERM. KIT SACCH. MINUT. DUCATI HYPERM. 821 '13 KIT RIC MOLLA-GOMM. ANTIVIB. CORTA KIT RIC CORPO d.54 MEDIO INOX 0457 10410 KIT KAMELLE E RIVETTI OM.0457 10410 KIT RICAMBIO COPPA POST. MEDIA VERT CARB KIT RIC GOMMINO COPPE CARBONIO D.007/06 KIT TAPPO X OMOL. EVO2 N. 32B GPSTY KIT RIC RIVESTIMENTO MEDIO L=300 NERO KIT RICAMBI LANA HT 800 Plus 850g		
14015	HONDA HONDA	PCX 125 PCX 150	2012-2016 2012-2016	Leovince NERO - FULL SYSTEM 1/1 - STAINLESS STEEL
RICAMBI	3014015802R 3014015202R 206281R 3014015601R 303949001R 3014009471R 088282004R 3014008701R 204790R 307762801R 3014008750VLR 414205R	KIT TAPPO RICAMBIO db-killer 57B KIT SACCH COLL. N° 1049 HONDA PCX 125 KIT RIC FLANGIA INOX 43 B DIS.MD12 KIT SACCH. MINUT. HONDA PCX125/150 12/14 KIT RIC MOLLA-GOMM. ANTIVIB. CORTA KIT RIC CORPO d.i50 MEDIO IN 0430 10394 KIT LAMELLE E RIVETTI OM.0430 0457 10394 KIT RICAMBIO COPPA POST. MEDIA VERT CARB KIT RIC GOMMINO COPPE CARBONIO D.007/06 KIT TAPPO X OMOL. EVO2 N. 32B GPSTY KIT RIC RIVESTIMENTO MEDIO L=300 NERO KIT RICAMBI LANA HT 800 Plus 850g		
14016	HONDA HONDA	CB 650 F CBR 650 F	2014-2016 2014-2016	Leovince NERO - FULL SYSTEM 4/2/1 - STAINLESS STEEL
RICAMBI	3014016205R 206285R 3014016207R 5682 3014016209R 3014016601R	KIT SACCHETTO COLLETTORE N. 4 COLL.PRIM KIT RIC FLANGIA INOX 206285 DIS.MD16 KIT SACCHETTO BIF. SEC HONDA CB CBR 650F KIT TAPPO Sonda LAMBDA M18 BASE + GUARN KIT RICAMBIO COLL. FINALE HONDA CB650 KIT SACCH. MINUT. HONDA CB650F-CBR 650F		

ART.	MARCA	MODELLO	TIPOLOGIA
		303949001R KIT RIC MOLLA-GOMM. ANTIVIB. CORTA 3014008471R KIT RIC CORPO d.54 MEDIO INOX 0457 10410 088280002R KIT KAMELLE E RIVETTI OM.0457 10410 3014008701R KIT RICAMBIO COPPA POST. MEDIA VERT CARB 204790R KIT RIC GOMMINO COPPE CARBONIO D.007/06 307762801R KIT TAPPO X OMOL. EVO2 N. 32B GPSTY 3014008750VLR KIT RIC RIVESTIMENTO MEDIO L=300 NERO 414205R KIT RICAMBI LANA HT 800 Plus 850g	
<b>14017</b>	KAWASAKI	Z 800 E	2013-2016 Leovince NERO - SLIP-ON - STAINLESS STEEL
<b>RICAMBI</b>		308783202R KIT SACCHETTO COLLETTORE N.1024 300051530R KIT fascetta 51 Inox 3014017601R KIT SACCHET MINUTE KAWA Z-800 '13/'15 303949001R KIT RIC MOLLA-GOMM. ANTIVIB. CORTA 3014008471R KIT RIC CORPO d.54 MEDIO INOX 0457 10410 088280002R KIT KAMELLE E RIVETTI OM.0457 10410 3014008701R KIT RICAMBIO COPPA POST. MEDIA VERT CARB 204790R KIT RIC GOMMINO COPPE CARBONIO D.007/06 307762801R KIT TAPPO X OMOL. EVO2 N. 32B GPSTY 3014008750VLR KIT RIC RIVESTIMENTO MEDIO L=300 NERO 414205R KIT RICAMBI LANA HT 800 Plus 850g	
<b>14018</b>	YAMAHA	MT-07/FZ-07/ABS	2014-2016 Leovince NERO - FULL SYSTEM 2/1 - STAINLESS STEEL
<b>RICAMBI</b>		308796204R KIT SACCHETTO COLLETTORE PRIMARIO X MT07 204833R KIT RIC BOCCOLA INOX DIS.028/06 204569R KIT RIC FLANGIA INOX 112 A DIS.195/04 3014018202R KIT SACCHETTO BIFOR SECOND. MT07 '14/'15 5682 KIT TAPPO Sonda LAMBDA M18 BASE + GUARN 3014018204R KIT RICAMBI COLL. FINALE MT07 3014018601R KIT RICAMBI SACCHETTO MINUTERIA MT07 303949001R KIT RIC MOLLA-GOMM. ANTIVIB. CORTA 3014009471R KIT RIC CORPO d.i50 MEDIO IN 0430 10394 088282004R KIT LAMELLE E RIVETTI OM.0430 0457 10394 3014008701R KIT RICAMBIO COPPA POST. MEDIA VERT CARB 204790R KIT RIC GOMMINO COPPE CARBONIO D.007/06 307762801R KIT TAPPO X OMOL. EVO2 N. 32B GPSTY 3014008750VLR KIT RIC RIVESTIMENTO MEDIO L=300 NERO 414205R KIT RICAMBI LANA HT 800 Plus 850g	
<b>14019</b>	PEUGEOT	METROPOLIS 400i	2013-2016 Leovince NERO - SLIP-ON - STAINLESS STEEL
<b>RICAMBI</b>		308078804R KIT RIC TAPPO N.57 x SCOOTERONI 3014019202R KIT RICAMBI COLLETTORE N°1058 300041531R KIT fascetta 41 Inox + gancio molla 3014019601R KIT SACCH. MINUT. METROPOLIS 400 '13/'15 303949001R KIT RIC MOLLA-GOMM. ANTIVIB. CORTA 3014000471R KIT RIC CORPO d.i50 BIG INOX 0230 10399 088425010R KIT LAMELLE E RIVETTI OM.0230 10399 3014000701R KIT RICAMBI COPPA POST.BIG VERTICALE CAR 204790R KIT RIC GOMMINO COPPE CARBONIO D.007/06 307762801R KIT TAPPO X OMOL. EVO2 N. 32B GPSTY 3014000750VLR KIT RIC RIVESTIMENTO MEDIO L=370 NERO 414205R KIT RICAMBI LANA HT 800 Plus 850g	
<b>14020</b>	HONDA	CBR 300 R	2014-2017 Leovince NERO - SLIP-ON - STAINLESS STEEL
	HONDA	CB 300 F (US model only)	2014-2017
<b>RICAMBI</b>		3014109202R KIT SACCHETTO COLLETTORE POSTER N.1060 300043530R KIT fascetta 43 Inox 3014109601R KIT SACCH. MINUT. HONDA CBR 300R '13/'15 303949001R KIT RIC MOLLA-GOMM. ANTIVIB. CORTA 3014009471R KIT RIC CORPO d.i50 MEDIO IN 0430 10394 088282004R KIT LAMELLE E RIVETTI OM.0430 0457 10394 3014008701R KIT RICAMBIO COPPA POST. MEDIA VERT CARB 204790R KIT RIC GOMMINO COPPE CARBONIO D.007/06 307762801R KIT TAPPO X OMOL. EVO2 N. 32B GPSTY	

ART.	MARCA	MODELLO	TIPOLOGIA
		3014008750VLR 414205R	KIT RIC RIVESTIMENTO MEDIO L=300 NERO KIT RICAMBI LANA HT 800 Plus 850g
<b>14021</b>	HONDA	FORZA 125/NSS 125/ABS	2015-2016 Leovince NERO - FULL SYSTEM 1/1 - STAINLESS STEEL
<b>RICAMBI</b>		3014015802R 308770202R 3014021601R 206294R 303949001R 3014009471R 088282004R 3014008701R 204790R 307762801R 3014008750VLR 414205R	KIT TAPPO RICAMBIO db-killer 57B KIT SACCHETTO COLLETTORE POSTER N.1013 KIT SACCH. MINUT. HONDA FORZA 125 '15 KIT RIC BOCCOLA INOX 40<50 xColeg. Silen KIT RIC MOLLA-GOMM. ANTIVIB. CORTA KIT RIC CORPO d.i50 MEDIO IN 0430 10394 KIT LAMELLE E RIVETTI OM.0430 0457 10394 KIT RICAMBIO COPPA POST. MEDIA VERT CARB KIT RIC GOMMINO COPPE CARBONIO D.007/06 KIT TAPPO X OMOL. EVO2 N. 32B GPSTY KIT RIC RIVESTIMENTO MEDIO L=300 NERO KIT RICAMBI LANA HT 800 Plus 850g
<b>14022</b>	SUZUKI	GSX-S 1000	2015-2016 Leovince NERO - SLIP-ON - STAINLESS STEEL
	SUZUKI	GSX-S 1000 F	2015-2016
<b>RICAMBI</b>		3014112202R 300049530R 3014112601R 300051535R 303949001R 3014009471R 088282004R 3014008701R 204790R 307762801R 3014008750VLR 414205R	KIT SACCHETTO COLLETTORE N.1063 KIT fascetta 49 Inox KIT SACCH. MINUT.SUZUKI GSX-S 1000 '15 KIT fascetta 51 Inox + Gancio 90° e Staf KIT RIC MOLLA-GOMM. ANTIVIB. CORTA KIT RIC CORPO d.i50 MEDIO IN 0430 10394 KIT LAMELLE E RIVETTI OM.0430 0457 10394 KIT RICAMBIO COPPA POST. MEDIA VERT CARB KIT RIC GOMMINO COPPE CARBONIO D.007/06 KIT TAPPO X OMOL. EVO2 N. 32B GPSTY KIT RIC RIVESTIMENTO MEDIO L=300 NERO KIT RICAMBI LANA HT 800 Plus 850g
<b>14023</b>	YAMAHA	X-CITY 125	2006-2016 Leovince NERO - SLIP-ON - STAINLESS STEEL
	YAMAHA	X-MAX 125	2006-2016
<b>RICAMBI</b>		308078804R 3014023202R 300035530R 3014023601R 303949001R 3014009471R 088282004R 3014008701R 204790R 307762801R 3014008750VLR 414205R	KIT RIC TAPPO N.57 x SCOOTERONI KIT SACCHETTO COLLETTORE N.1064 KIT fascetta 35 Inox KIT SACCH.MINUT.YAM X-MAX125 / X-CITY125 KIT RIC MOLLA-GOMM. ANTIVIB. CORTA KIT RIC CORPO d.i50 MEDIO IN 0430 10394 KIT LAMELLE E RIVETTI OM.0430 0457 10394 KIT RICAMBIO COPPA POST. MEDIA VERT CARB KIT RIC GOMMINO COPPE CARBONIO D.007/06 KIT TAPPO X OMOL. EVO2 N. 32B GPSTY KIT RIC RIVESTIMENTO MEDIO L=300 NERO KIT RICAMBI LANA HT 800 Plus 850g
<b>14024</b>	PIAGGIO	BEVERLY 300	2010-2016 Leovince NERO - SLIP-ON - STAINLESS STEEL
<b>RICAMBI</b>		308078804R 3014024202R 300043533R 3014024601R 303949001R 3014000471R 088425010R 3014000701R 204790R 307762801R 3014000750VLR 414205R	KIT RIC TAPPO N.57 x SCOOTERONI KIT SACCHETTO COLLETTORE N.1065 KIT fascetta 43 Inox + Gancio 90° KIT SACCH.MINUT.PIAGGIO BEVERLY 300 '15 KIT RIC MOLLA-GOMM. ANTIVIB. CORTA KIT RIC CORPO d.i50 BIG INOX 0230 10399 KIT LAMELLE E RIVETTI OM.0230 10399 KIT RICAMBI COPPA POST.BIG VERTICALE CAR KIT RIC GOMMINO COPPE CARBONIO D.007/06 KIT TAPPO X OMOL. EVO2 N. 32B GPSTY KIT RIC RIVESTIMENTO MEDIO L=370 NERO KIT RICAMBI LANA HT 800 Plus 850g
<b>14025</b>	PIAGGIO	BEVERLY 350 SPORT TOURING EURO 3	2011-2016 Leovince NERO - SLIP-ON - STAINLESS STEEL
<b>RICAMBI</b>		308078804R	KIT RIC TAPPO N.57 x SCOOTERONI



ART.	MARCA	MODELLO	TIPOLOGIA
		3014025202R KIT SACCHETTO COLLETTORE N.1066 300045534R KIT fascetta 45 Inox + Gancio 90° 3014025601R KIT RICAMBI MINUT. PIAGGIO BEVERLY 350 206327R KIT RIC BOCCOLA 45X37.6X30 LGR/F MD56 303949001R KIT RIC MOLLA-GOMM. ANTIVIB. CORTA 3014000471R KIT RIC CORPO d.i50 BIG INOX 0230 10399 088425010R KIT LAMELLE E RIVETTI OM.0230 10399 3014000701R KIT RICAMBI COPPA POST.BIG VERTICALE CAR 204790R KIT RIC GOMMINO COPPE CARBONIO D.007/06 307762801R KIT TAPPO X OMOL. EVO2 N. 32B GPSTY 3014000750VLR KIT RIC RIVESTIMENTO MEDIO L=370 NERO 414205R KIT RICAMBI LANA HT 800 Plus 850g	
<b>14026</b>	YAMAHA	X-MAX 250 carburetor/injection	2006-2016 Leovince NERO - FULL SYSTEM 1/1 - STAINLESS STEEL
<b>RICAMBI</b>		308078804R KIT RIC TAPPO N.57 x SCOOTERONI 3014026202R KIT SACCHETTO COLLETTORE N.1079 200560R KIT RIC FLANGIA INOX 25 B DIS.129/00 5684 KIT TAPPO SONDA LAMBDA M12 BASE + GUARN 3014026601R KIT SACCH. MINUT. YAMAHA X-MAX 250 '06 303949001R KIT RIC MOLLA-GOMM. ANTIVIB. CORTA 3014000471R KIT RIC CORPO d.i50 BIG INOX 0230 10399 088425010R KIT LAMELLE E RIVETTI OM.0230 10399 3014000701R KIT RICAMBI COPPA POST.BIG VERTICALE CAR 204790R KIT RIC GOMMINO COPPE CARBONIO D.007/06 307762801R KIT TAPPO X OMOL. EVO2 N. 32B GPSTY 3014000750VLR KIT RIC RIVESTIMENTO MEDIO L=370 NERO 414205R KIT RICAMBI LANA HT 800 Plus 850g	
<b>14027</b>	YAMAHA	TRICITY 125	2014-2016 Leovince NERO - SLIP-ON - STAINLESS STEEL
<b>RICAMBI</b>		3014027202R KIT SACCHETTO COLLETTORE N.1082 3014027601R KIT SACCH. MINUT.YAMAHA TRICITY 125 '15 300035530R KIT fascetta 35 Inox 303949001R KIT RIC MOLLA-GOMM. ANTIVIB. CORTA 3014009471R KIT RIC CORPO d.i50 MEDIO IN 0430 10394 088282004R KIT LAMELLE E RIVETTI OM.0430 0457 10394 3014008701R KIT RICAMBIO COPPA POST. MEDIA VERT CARB 204790R KIT RIC GOMMINO COPPE CARBONIO D.007/06 307762801R KIT TAPPO X OMOL. EVO2 N. 32B GPSTY 3014008750VLR KIT RIC RIVESTIMENTO MEDIO L=300 NERO 414205R KIT RICAMBI LANA HT 800 Plus 850g	
<b>14028</b>	HONDA	CRF 1000 L AFRICA TWIN EURO 3 (fits with original panniers)	2016-2017 Leovince NERO - SLIP-ON - STAINLESS STEEL
<b>RICAMBI</b>		308078804R KIT RIC TAPPO N.57 x SCOOTERONI 3014028204R KIT SACCHETTO COLLETTORE N.1096 3014028011R KIT SACC CARTER CAR HONDA CRF1000L AFTWN 3014028601R KIT SACCH. MINUT.HONDA CRF 1000L AFRICA 300035530R KIT fascetta 35 Inox 303949001R KIT RIC MOLLA-GOMM. ANTIVIB. CORTA 3014000471R KIT RIC CORPO d.i50 BIG INOX 0230 10399 088425010R KIT LAMELLE E RIVETTI OM.0230 10399 3014000701R KIT RICAMBI COPPA POST.BIG VERTICALE CAR 204790R KIT RIC GOMMINO COPPE CARBONIO D.007/06 307762801R KIT TAPPO X OMOL. EVO2 N. 32B GPSTY 3014000750VLR KIT RIC RIVESTIMENTO MEDIO L=370 NERO 414205R KIT RICAMBI LANA HT 800 Plus 850g	
<b>14029</b>	KAWASAKI	Z 1000 SX (fits with original panniers)	2014-2016 Leovince NERO - 2 SLIP-ON - STAINLESS STEEL
	KAWASAKI	NINJA 1000/ABS (US model only, fits with original panniers)	2010-2018
<b>RICAMBI</b>		3014144203R KIT RICAMBI COLLETTORE 1088 KAW Z1000 SX 3014144204R KIT RICAMBI COLLETTORE 1089 KAW Z1000 SX 3014144601R KIT RICAMBI MINUT. KAW Z 1000 SX 303949001R KIT RIC MOLLA-GOMM. ANTIVIB. CORTA 3014008471R KIT RIC CORPO d.54 MEDIO INOX 0457 10410 3014008472R KIT RIC COR SX d54 MEDIO IN 0457 10410	

ART.	MARCA	MODELLO		TIPOLOGIA
		088280002R	KIT KAMELLE E RIVETTI OM.0457 10410	
		3014008701R	KIT RICAMBIO COPPA POST. MEDIA VERT CARB	
		204790R	KIT RIC GOMMINO COPPE CARBONIO D.007/06	
		307762801R	KIT TAPPO X OMOL. EVO2 N. 32B GPSTY	
		3014008750VLR	KIT RIC RIVESTIMENTO MEDIO L=300 NERO	
		414205R	KIT RICAMBI LANA HT 800 Plus 850g	
<b>14031</b>	SUZUKI	SV 650/ABS		2016-2018 Leovince NERO - SLIP-ON - STAINLESS STEEL
	SUZUKI	SV 650 X ABS		2018-
<b>RICAMBI</b>		3014031202R	KIT SACCHETTO COLLETTORE N.1092	
		3014031601R	KIT SACCH. MINUT. SUZUKI SV 650 '16	
		204999R	KIT RIC BOCCOLA 45X38X30 LGR/F D.026/07	
		300049530R	KIT fascetta 49 Inox	
		303949001R	KIT RIC MOLLA-GOMM. ANTIVIB. CORTA	
		3014009471R	KIT RIC CORPO d.i50 MEDIO IN 0430 10394	
		088282004R	KIT LAMELLE E RIVETTI OM.0430 0457 10394	
		3014008701R	KIT RICAMBIO COPPA POST. MEDIA VERT CARB	
		204790R	KIT RIC GOMMINO COPPE CARBONIO D.007/06	
		307762801R	KIT TAPPO X OMOL. EVO2 N. 32B GPSTY	
		3014008750VLR	KIT RIC RIVESTIMENTO MEDIO L=300 NERO	
		414205R	KIT RICAMBI LANA HT 800 Plus 850g	
<b>14033</b>	KTM	1050 ADVENTURE (fits with rails for original and Givi panniers)		2015-2016 Leovince NERO - SLIP-ON - STAINLESS STEEL
	KTM	1190/R ADVENTURE (fits with rails for original and Givi panniers)		2013-2016
	KTM	1290 SUPER ADVENTURE (fits with rails for original and Givi panniers)		2015-2016
<b>RICAMBI</b>		3014033001R	KIT SACC CARTER CAR KTM ADV1050 1190 '16	
		3014033601R	KIT SACCH. MINUT. KTM ADV 1050 1190 '16	
		3014033471R	KIT R CORPO d.54 BIG I 0233/35 + C 10400	
		088292004R	KIT LAMELLE E RIVETTI OM.0233 0235 10400	
		3014000701R	KIT RICAMBI COPPA POST.BIG VERTICALE CAR	
		204790R	KIT RIC GOMMINO COPPE CARBONIO D.007/06	
		307762801	TAPPO X OMOL. EVO2 N. 32B GPSTY	
		3014033750VLR	KIT RIC RIVESTIMENTO MEDIO L=370 NERO	
		414205R	KIT RICAMBI LANA HT 800 Plus 850g	
<b>14034</b>	HONDA	CB 400 F		2017-2018 Leovince NERO - SLIP-ON - STAINLESS STEEL
	HONDA	CBR 400 R		2017-2018
	HONDA	CB 500 F (do not fit with original centre stand)		2016-2016
	HONDA	CBR 500 R		2016-2016
<b>RICAMBI</b>		3014034202R	KIT SACCHETTO COLLETTORE N.1094	
		3014034601R	KIT SACCH. MINUT. HONDA CB/CBR 400/500 F	
		300045530R	KIT fascetta 45 Inox	
		308574001R	KIT RIC MOLLA TRAZ SUPER CORTA + TUBETTO	
		3014008471R	KIT RIC CORPO d.54 MEDIO INOX 0457 10410	
		088280002R	KIT KAMELLE E RIVETTI OM.0457 10410	
		3014008701R	KIT RICAMBIO COPPA POST. MEDIA VERT CARB	
		204790R	KIT RIC GOMMINO COPPE CARBONIO D.007/06	
		307762801R	KIT TAPPO X OMOL. EVO2 N. 32B GPSTY	
		3014008750VLR	KIT RIC RIVESTIMENTO MEDIO L=300 NERO	
		414205R	KIT RICAMBI LANA HT 800 Plus 850g	
<b>14035</b>	HONDA	SH 300i ABS		2016-2017 Leovince NERO - SLIP-ON - STAINLESS STEEL
	HONDA	SH 300i ABS		2016-2017
<b>RICAMBI</b>		3014035202R	KIT SACCHETTO COLLETTORE N.1098	
		3014035561R	KIT SACCH STAFFA IN VN HONDA SH300i '16	
		303876001R	KIT SACC CARTER CARB. HONDA SH300i '16	
		3014035601R	KIT SACCHETTO MINUTERIA HONDA SH300i '16	
		303949001R	KIT RIC MOLLA-GOMM. ANTIVIB. CORTA	
		300038530R	KIT fascetta 38 Inox	
		3014000471R	KIT RIC CORPO d.i50 BIG INOX 0230 10399	
		088425010R	KIT LAMELLE E RIVETTI OM.0230 10399	
		3014000701R	KIT RICAMBI COPPA POST.BIG VERTICALE CAR	
		204790R	KIT RIC GOMMINO COPPE CARBONIO D.007/06	
		307762801R	KIT TAPPO X OMOL. EVO2 N. 32B GPSTY	

ART.	MARCA	MODELLO	TIPOLOGIA	
	3014000750VLR 414205R	KIT RIC RIVESTIMENTO MEDIO L=370 NERO KIT RICAMBI LANA HT 800 Plus 850g		
<b>14036</b>	KYMCO	DINK STREET 125i	2009-2016	Leovince NERO - FULL SYSTEM - STAINLESS STEEL
	KYMCO	DOWNTOWN 125i	2009-2016	
	KYMCO	SUPERDINK 125i	2009-2016	
<b>RICAMBI</b>	308078804R 3014036202R 5684 3014036681R 0814036501R 303949001R 3014000471R 088425010R 3014000701R 204790R 307762801R 3014000750VLR 414205R	KIT RIC TAPPO N.57 x SCOOTERONI KIT SACCHETTO COLLETTORE N.1099 KIT TAPPO SONDA LAMBDA M12 BASE + GUARN KIT SACCHETTO MINUTERIA KYMCO SDINK 125 KIT STAFFA INOX VN KYMCO DINK 125 KIT RIC MOLLA-GOMM. ANTIVIB. CORTA KIT RIC CORPO d.i50 BIG INOX 0230 10399 KIT LAMELLE E RIVETTI OM.0230 10399 KIT RICAMBI COPPA POST.BIG VERTICALE CAR KIT RIC GOMMINO COPPE CARBONIO D.007/06 KIT TAPPO X OMOL. EVO2 N. 32B GPSTY KIT RIC RIVESTIMENTO MEDIO L=370 NERO KIT RICAMBI LANA HT 800 Plus 850g		
<b>14037</b>	KTM	DUKE 390	2013-2016	Leovince NERO - SLIP-ON - STAINLESS STEEL
<b>RICAMBI</b>	3014037204R 300043530R 3014037501R 3014037601R 303949001R 3014009471R 088282004R 3014008701R 204790R 307762801R 3014008750VLR 414205R	KIT SACCHETTO COLLETTORE N.1126 KIT fascetta 43 Inox KIT SACCHETTO STAFFA IN KTM 390 DUKE '16 KIT SACCHETTO MINUTERIA KTM 390 DUKE '16 KIT RIC MOLLA-GOMM. ANTIVIB. CORTA KIT RIC CORPO d.i50 MEDIO IN 0430 10394 KIT LAMELLE E RIVETTI OM.0430 0457 10394 KIT RICAMBIO COPPA POST. MEDIA VERT CARB KIT RIC GOMMINO COPPE CARBONIO D.007/06 KIT TAPPO X OMOL. EVO2 N. 32B GPSTY KIT RIC RIVESTIMENTO MEDIO L=300 NERO KIT RICAMBI LANA HT 800 Plus 850g		
<b>14038</b>	KTM	RC 125	2014-2016	Leovince NERO - SLIP-ON - STAINLESS STEEL
<b>RICAMBI</b>	3014167202R 300041530R 3014167501R 3014167601R 303949001R 3014009471R 088282004R 3014008701R 204790R 307762801R 3014008750VLR 414205R	KIT SACCHETTO COLLETTORE N.1101 KIT fascetta 41 Inox KIT SACCHETTO STAFFA ALL VN KTM RC125 KIT SACCHETTO MINUTERIA KTM RC 125 '15 KIT RIC MOLLA-GOMM. ANTIVIB. CORTA KIT RIC CORPO d.i50 MEDIO IN 0430 10394 KIT LAMELLE E RIVETTI OM.0430 0457 10394 KIT RICAMBIO COPPA POST. MEDIA VERT CARB KIT RIC GOMMINO COPPE CARBONIO D.007/06 KIT TAPPO X OMOL. EVO2 N. 32B GPSTY KIT RIC RIVESTIMENTO MEDIO L=300 NERO KIT RICAMBI LANA HT 800 Plus 850g		
<b>14039</b>	KAWASAKI	Z 900 (also fit 35Kw & 70Kw versions)	2017-2018	Leovince NERO - SLIP-ON - STAINLESS STEEL
<b>RICAMBI</b>	3014039202R 3014039561R 3014039601R 300053530R 303949001R 3014009471R 088282004R 3014008701R 204790R 307762801R 3014008750VLR 414205R	KIT SACCHETTO COLLETTORE N.1112 KIT SACCHET STAFFA ALL VN KAWA Z900 '17 KIT SACCHET MINUTERIA KAWASAKI Z900 '17 KIT fascetta 53 Inox KIT RIC MOLLA-GOMM. ANTIVIB. CORTA KIT RIC CORPO d.i50 MEDIO IN 0430 10394 KIT LAMELLE E RIVETTI OM.0430 0457 10394 KIT RICAMBIO COPPA POST. MEDIA VERT CARB KIT RIC GOMMINO COPPE CARBONIO D.007/06 KIT TAPPO X OMOL. EVO2 N. 32B GPSTY KIT RIC RIVESTIMENTO MEDIO L=300 NERO KIT RICAMBI LANA HT 800 Plus 850g		
<b>14040</b>	SUZUKI	GSX-S 750/Z ABS	2017-2018	Leovince NERO - SLIP-ON - STAINLESS STEEL
<b>RICAMBI</b>	308544202R	KIT SACCHETTO COLLETTORE N.907		

ART.	MARCA	MODELLO	TIPOLOGIA
		300045530R KIT fascetta 45 Inox 3014040601R KIT SACCHET MINUTERIA SUZUKI GSX-S 750 303949001R KIT RIC MOLLA-GOMM. ANTIVIB. CORTA 3014009471R KIT RIC CORPO d.i50 MEDIO IN 0430 10394 088282004R KIT LAMELLE E RIVETTI OM.0430 0457 10394 3014008701R KIT RICAMBIO COPPA POST. MEDIA VERT CARB 204790R KIT RIC GOMMINO COPPE CARBONIO D.007/06 307762801R KIT TAPPO X OMOL. EVO2 N. 32B GPSTY 3014008750VLR KIT RIC RIVESTIMENTO MEDIO L=300 NERO 414205R KIT RICAMBI LANA HT 800 Plus 850g	
<b>14042</b>	HONDA	INTEGRA 750/DCT/ABS (also fits 35Kw version)	2016-2018 Leovince NERO - SLIP-ON - STAINLESS STEEL
	HONDA	NC 750 S/X/DCT/ABS (also fits 35Kw version)	2016-2018
<b>RICAMBI</b>		3014009202R KIT SACCHETTO COLLET N.1042 INTEGRA 700 300041530R KIT fascetta 41 Inox 3014009601R KIT SACCH. MINUT. INTEGRA 700 '13 303949001R KIT RIC MOLLA-GOMM. ANTIVIB. CORTA 3014009471R KIT RIC CORPO d.i50 MEDIO IN 0430 10394 088282004R KIT LAMELLE E RIVETTI OM.0430 0457 10394 3014008701R KIT RICAMBIO COPPA POST. MEDIA VERT CARB 204790R KIT RIC GOMMINO COPPE CARBONIO D.007/06 307762801R KIT TAPPO X OMOL. EVO2 N. 32B GPSTY 3014008750VLR KIT RIC RIVESTIMENTO MEDIO L=300 NERO 414205R KIT RICAMBI LANA HT 800 Plus 850g	
<b>14043K</b>	YAMAHA	TMAX 530 ABS/DX/SX	2017-2018 Leovince NERO - FULL SYSTEM 2/1 - STAINLESS STEEL
<b>RICAMBI</b>		3014043001R KIT SACCHET CARTER CARB YAMAHA T-MAX 530 3014043202R KIT SACCHETTO COLLETTORE PRIM N.1127 3014043206R KIT SACCHETTO COLLETTORE N.1129 5683 KIT TAPPO Sonda LAMBDA M12 RACING + GUA 3014043601R KIT SACCHET MINUTERIA YAMAHA T-MAX 530 303949001R KIT RIC MOLLA-GOMM. ANTIVIB. CORTA 3014000471R KIT RIC CORPO d.i50 BIG INOX 0230 10399 088425010R KIT LAMELLE E RIVETTI OM.0230 10399 3014000701R KIT RICAMBI COPPA POST.BIG VERTICALE CAR 204790R KIT RIC GOMMINO COPPE CARBONIO D.007/06 307762801R KIT TAPPO X OMOL. EVO2 N. 32B GPSTY 3014000750VLR KIT RIC RIVESTIMENTO MEDIO L=370 NERO 414205R KIT RICAMBI LANA HT 800 Plus 850g	
<b>14043</b>	YAMAHA	TMAX 530 ABS/DX/SX	2017-2018 Leovince NERO - FULL SYSTEM 2/1 - STAINLESS STEEL
		TMAX 530 ABS/DX/SX	2017-2018
<b>RICAMBI</b>		3014043001R KIT SACCHET CARTER CARB YAMAHA T-MAX 530 3014043202R KIT SACCHETTO COLLETTORE PRIM N.1127 3014043204R KIT SACCHETTO COLLETTORE N.1128 5683 KIT TAPPO Sonda LAMBDA M12 RACING + GUA 3014043601R KIT SACCHET MINUTERIA YAMAHA T-MAX 530 303949001R KIT RIC MOLLA-GOMM. ANTIVIB. CORTA 3014000471R KIT RIC CORPO d.i50 BIG INOX 0230 10399 088425010R KIT LAMELLE E RIVETTI OM.0230 10399 3014000701R KIT RICAMBI COPPA POST.BIG VERTICALE CAR 204790R KIT RIC GOMMINO COPPE CARBONIO D.007/06 307762801R KIT TAPPO X OMOL. EVO2 N. 32B GPSTY 3014000750VLR KIT RIC RIVESTIMENTO MEDIO L=370 NERO 414205R KIT RICAMBI LANA HT 800 Plus 850g	
<b>14044</b>	HONDA	CRF 1000 L AFRICA TWIN ABS EURO 4 (fits with original panniers)	2016-2017 Leovince NERO - SLIP-ON - STAINLESS STEEL
<b>RICAMBI</b>		308078804R KIT RIC TAPPO N.57 x SCOOTERONI 3014028204R KIT SACCHETTO COLLETTORE N.1096 3014028011R KIT SACC CARTER CAR HONDA CRF1000L AFTWN 3014028601R KIT SACCH. MINUT.HONDA CRF 1000L AFRICA 300035530R KIT fascetta 35 Inox 303949001R KIT RIC MOLLA-GOMM. ANTIVIB. CORTA	

ART.	MARCA	MODELLO		TIPOLOGIA
		3014000471R	KIT RIC CORPO d.i50 BIG INOX 0230 10399	
		088425010R	KIT LAMELLE E RIVETTI OM.0230 10399	
		3014000701R	KIT RICAMBI COPPA POST.BIG VERTICALE CAR	
		204790R	KIT RIC GOMMINO COPPE CARBONIO D.007/06	
		307762801R	KIT TAPPO X OMOL. EVO2 N. 32B GPSTY	
		3014000750VLR	KIT RIC RIVESTIMENTO MEDIO L=370 NERO	
		414205R	KIT RICAMBI LANA HT 800 Plus 850g	
<b>14045</b>	KTM	1090 ADVENTURE/R (fits with rails for original and Givi panniers)	2017-2018	Leovince NERO - SLIP-ON - STAINLESS STEEL
	KTM	1290 SUPER ADVENTURE R/S/T (fits with rails for original and Givi panniers)	2017-2018	
<b>RICAMBI</b>		3014033001R	KIT SACC CARTER CAR KTM ADV1050 1190 '16	
		3014033601R	KIT SACCH. MINUT. KTM ADV 1050 1190 '16	
		3014033471R	KIT R CORPO d.54 BIG I 0233/35 + C 10400	
		088292004R	KIT LAMELLE E RIVETTI OM.0233 0235 10400	
		3014000701R	KIT RICAMBI COPPA POST.BIG VERTICALE CAR	
		204790R	KIT RIC GOMMINO COPPE CARBONIO D.007/06	
		307762801R	KIT TAPPO X OMOL. EVO2 N. 32B GPSTY	
		3014033750VLR	KIT RIC RIVESTIMENTO MEDIO L=370 NERO	
		414205R	KIT RICAMBI LANA HT 800 Plus 850g	
<b>14046</b>	HONDA	X-ADV	2017-2018	Leovince NERO - SLIP-ON - STAINLESS STEEL
<b>RICAMBI</b>		3014046202R	KIT SACCHETTO COLLETTORE N.1132	
		3014046601R	KIT SACCHET MINUTERIA HONDA X-ADV 750	
		300041530R	KIT fascetta 41 Inox	
		083896002R	KIT CARTER CARBONIO LATER X RAPTOR '06	
		303949001R	KIT RIC MOLLA-GOMM. ANTIVIB. CORTA	
		3014009471R	KIT RIC CORPO d.i50 MEDIO IN 0430 10394	
		088282004R	KIT LAMELLE E RIVETTI OM.0430 0457 10394	
		3014008701R	KIT RICAMBIO COPPA POST. MEDIA VERT CARB	
		204790R	KIT RIC GOMMINO COPPE CARBONIO D.007/06	
		307762801R	KIT TAPPO X OMOL. EVO2 N. 32B GPSTY	
		3014008750VLR	KIT RIC RIVESTIMENTO MEDIO L=300 NERO	
		414205R	KIT RICAMBI LANA HT 800 Plus 850g	
<b>14047</b>	SUZUKI	V-STROM 1000/1000 XT ABS (fits with original panniers)	2017-2018	Leovince NERO - SLIP-ON - STAINLESS STEEL
<b>RICAMBI</b>		3014047202R	KIT SACCHETTO COLLETTORE N°1138	
		300057530R	KIT fascetta 57 Inox	
		3014047601R	KIT SACCHET MINUTERIA SUZUKI V-STROM1000	
		303949001R	KIT RIC MOLLA-GOMM. ANTIVIB. CORTA	
		3014000471R	KIT RIC CORPO d.i50 BIG INOX 0230 10399	
		088425010R	KIT LAMELLE E RIVETTI OM.0230 10399	
		3014000701R	KIT RICAMBI COPPA POST.BIG VERTICALE CAR	
		204790R	KIT RIC GOMMINO COPPE CARBONIO D.007/06	
		307762801R	KIT TAPPO X OMOL. EVO2 N. 32B GPSTY	
		3014000750VLR	KIT RIC RIVESTIMENTO MEDIO L=370 NERO	
		414205R	KIT RICAMBI LANA HT 800 Plus 850g	
<b>14048K</b>	HONDA	SH 125i	2017-	Leovince NERO - FULL SYSTEM 1/1 - STAINLESS STEEL
	HONDA	SH 150i	2017-	
<b>RICAMBI</b>		3014048204R	KIT SACCHETTO COLLETTORE N°1141	
		3014048601R	KIT SACCHET MINUTERIA HONDA SH 125/150	
		303949001R	KIT RIC MOLLA-GOMM. ANTIVIB. CORTA	
		3014009471R	KIT RIC CORPO d.i50 MEDIO IN 0430 10394	
		088282004R	KIT LAMELLE E RIVETTI OM.0430 0457 10394	
		3014008701R	KIT RICAMBIO COPPA POST. MEDIA VERT CARB	
		204790R	KIT RIC GOMMINO COPPE CARBONIO D.007/06	
		307762801R	KIT TAPPO X OMOL. EVO2 N. 32B GPSTY	
		3014008750VLR	KIT RIC RIVESTIMENTO MEDIO L=300 NERO	
		414205R	KIT RICAMBI LANA HT 800 Plus 850g	
<b>14048</b>	HONDA	SH 125i	2017-	Leovince NERO - FULL SYSTEM 1/1 - STAINLESS STEEL
	HONDA	SH 150i	2017-	
	HONDA	SH 125i	2017-	
	HONDA	SH 150i	2017-	

ART.	MARCA	MODELLO	TIPOLOGIA
RICAMBI	3014048202R	KIT SACCHETTO COLLETTORE N°1140	
	3014048601R	KIT SACCHET MINUTERIA HONDA SH 125/150	
	303949001R	KIT RIC MOLLA-GOMM. ANTIVIB. CORTA	
	3014009471R	KIT RIC CORPO d.i50 MEDIO IN 0430 10394	
	088282004R	KIT LAMELLE E RIVETTI OM.0430 0457 10394	
	3014008701R	KIT RICAMBIO COPPA POST. MEDIA VERT CARB	
	204790R	KIT RIC GOMMINO COPPE CARBONIO D.007/06	
	307762801R	KIT TAPPO X OMOL. EVO2 N. 32B GPSTY	
	3014008750VLR	KIT RIC RIVESTIMENTO MEDIO L=300 NERO	
	414205R	KIT RICAMBI LANA HT 800 Plus 850g	
<b>14049</b>	KAWASAKI	Z 1000	2017-2018 Leovince NERO - 2 SLIP-ON - STAINLESS STEEL
	KAWASAKI	Z 1000 SX (fits with original panniers)	2017-2018
RICAMBI	3014144203R	KIT RICAMBI COLLETTORE 1088 KAW Z1000 SX	
	3014144204R	KIT RICAMBI COLLETTORE 1089 KAW Z1000 SX	
	3014144601R	KIT RICAMBI MINUT. KAW Z 1000 SX	
	303949001R	KIT RIC MOLLA-GOMM. ANTIVIB. CORTA	
	3014008471R	KIT RIC CORPO d.54 MEDIO INOX 0457 10410	
	3014008472R	KIT RIC COR SX d54 MEDIO IN 0457 10410	
	088280002R	KIT KAMELLE E RIVETTI OM.0457 10410	
	3014008701R	KIT RICAMBIO COPPA POST. MEDIA VERT CARB	
	204790R	KIT RIC GOMMINO COPPE CARBONIO D.007/06	
	307762801R	KIT TAPPO X OMOL. EVO2 N. 32B GPSTY	
	3014008750VLR	KIT RIC RIVESTIMENTO MEDIO L=300 NERO	
	414205R	KIT RICAMBI LANA HT 800 Plus 850g	
<b>14050</b>	HONDA	CB 500 F (fits with original centre stand)	2016-2018 Leovince NERO - SLIP-ON - STAINLESS STEEL
	HONDA	CBR 500 R	2016-2018
	HONDA	CB 500 X (fits with original centre stand)	2017-2018
RICAMBI	3014050202R	KIT SACCHETTO COLLETTORE N.1150	
	3014034601R	KIT SACCH. MINUT. HONDA CB/CBR 400/500 F	
	300045530R	KIT fascetta 45 Inox	
	308574001R	KIT RIC MOLLA TRAZ SUPER CORTA + TUBETTO	
	3014008471R	KIT RIC CORPO d.54 MEDIO INOX 0457 10410	
	088280002R	KIT KAMELLE E RIVETTI OM.0457 10410	
	3014008701R	KIT RICAMBIO COPPA POST. MEDIA VERT CARB	
	204790R	KIT RIC GOMMINO COPPE CARBONIO D.007/06	
	307762801R	KIT TAPPO X OMOL. EVO2 N. 32B GPSTY	
	3014008750VLR	KIT RIC RIVESTIMENTO MEDIO L=300 NERO	
	414205R	KIT RICAMBI LANA HT 800 Plus 850g	
<b>14051</b>	TRIUMPH	TIGER EXPLORER XR/XCX/XC LOW/XCA (fits with original panniers)	2016-2017 Leovince NERO - SLIP-ON - STAINLESS STEEL
RICAMBI	3014051202R	KIT SACCHETTO COLLETTORE N.1145	
	308720001R	KIT SACC CARTER CARB TRIUMPH EXPL 1200	
	3014051601R	KIT SACC MINUTERIA TRIUMPH 1200 '17	
	303949001R	KIT RIC MOLLA-GOMM. ANTIVIB. CORTA	
	3014004471R	KIT RIC CORPO d.i54 BIG IN 0233/35 10400	
	088292004R	KIT LAMELLE E RIVETTI OM.0233 0235 10400	
	3014000701R	KIT RICAMBI COPPA POST.BIG VERTICALE CAR	
	204790R	KIT RIC GOMMINO COPPE CARBONIO D.007/06	
	307762801R	KIT TAPPO X OMOL. EVO2 N. 32B GPSTY	
	3014000750VLR	KIT RIC RIVESTIMENTO MEDIO L=370 NERO	
	414205R	KIT RICAMBI LANA HT 800 Plus 850g	
<b>14052K</b>	HONDA	FORZA 125/NSS 125/ABS	2017-2018 Leovince NERO - FULL SYSTEM 1/1 - STAINLESS STEEL
RICAMBI	3014052204R	KIT SACCH COLLETTORE N.1153 APP	
	3014052601R	KIT SACC MINUTERIA HONDA FORZA NSS 125	
	303949001R	KIT RIC MOLLA-GOMM. ANTIVIB. CORTA	
	3014052471R	KIT RIC CORPO d.i50 BIG INOX 0230 10399	
	088425010R	KIT LAMELLE E RIVETTI OM.0230 10399	
	3014000701R	KIT RICAMBI COPPA POST.BIG VERTICALE CAR	
	204790R	KIT RIC GOMMINO COPPE CARBONIO D.007/06	
	307762801R	KIT TAPPO X OMOL. EVO2 N. 32B GPSTY	
	3014052750VLR	KIT RIC RIVESTIMENTO MEDIO L=370 NERO	
	414205R	KIT RICAMBI LANA HT 800 Plus 850g	

ART.	MARCA	MODELLO		TIPOLOGIA
14052	HONDA	FORZA 125/NSS 125/ABS	2017-2018	Leovince NERO - FULL SYSTEM 1/1 - STAINLESS STEEL
	HONDA	FORZA 125/NSS 125/ABS	2017-2018	
RICAMBI	3014052202R	KIT SACCHETTO COLLETTORE N.1152		
	3014052601R	KIT SACC MINUTERIA HONDA FORZA NSS 125		
	303949001R	KIT RIC MOLLA-GOMM. ANTIVIB. CORTA		
	3014052471R	KIT RIC CORPO d.i50 BIG INOX 0230 10399		
	088425010R	KIT LAMELLE E RIVETTI OM.0230 10399		
	3014000701R	KIT RICAMBI COPPA POST.BIG VERTICALE CAR		
	204790R	KIT RIC GOMMINO COPPE CARBONIO D.007/06		
	307762801R	KIT TAPPO X OMOL. EVO2 N. 32B GPSTY		
	3014052750VLR	KIT RIC RIVESTIMENTO MEDIO L=370 NERO		
	414205R	KIT RICAMBI LANA HT 800 Plus 850g		
14053	BMW	R 1200 GS (fits with original panniers)	2017-2018	Leovince NERO - SLIP-ON - STAINLESS STEEL
	BMW	R 1200 GS ADVENTURE (fits with original panniers)	2017-2018	
RICAMBI	308787202R	KIT SACCHETTO COLLETTORE N°1032		
	308787001R	KIT SACCHET CARTER CARBONIO BMW R1200 GS		
	3014053601R	KIT SACCHETTO MINUTERIA BMW R1200 GS		
	308574001R	KIT RIC MOLLA TRAZ SUPER CORTA + TUBETTO		
	3014004471R	KIT RIC CORPO d.i54 BIG IN 0233/35 10400		
	088292004R	KIT LAMELLE E RIVETTI OM.0233 0235 10400		
	3014000701R	KIT RICAMBI COPPA POST.BIG VERTICALE CAR		
	204790R	KIT RIC GOMMINO COPPE CARBONIO D.007/06		
	307762801R	KIT TAPPO X OMOL. EVO2 N. 32B GPSTY		
	3014000750VLR	KIT RIC RIVESTIMENTO MEDIO L=370 NERO		
	414205R	KIT RICAMBI LANA HT 800 Plus 850g		
14100E	HONDA	CB 650 F	2014-2016	Leovince LV ONE EVO - FULL SYSTEM 4/2/1 - STAINLESS STEEL
	HONDA	CBR 650 F	2014-2016	
RICAMBI	307572505R	KIT fascetta FM4S Fact. Medio		
	3014016205R	KIT SACCHETTO COLLETTORE N. 4 COLL.PRIM		
	3014016207R	KIT SACCHETTO BIF. SEC HONDA CB CBR 650F		
	3014016209R	KIT RICAMBIO COLL. FINALE HONDA CB650		
	3014016601R	KIT SACCH. MINUT. HONDA CB650F-CBR 650F		
	5684	KIT TAPPO SONDA LAMBDA M12 BASE + GUARN		
	303949001R	KIT RIC MOLLA-GOMM. ANTIVIB. CORTA		
	308410481R	KIT R COR EV IN D54 MED L300 0457 10410		
	088280002R	KIT KAMELLE E RIVETTI OM.0457 10410		
	3014008701R	KIT RICAMBIO COPPA POST. MEDIA VERT CARB		
	307762801R	KIT TAPPO X OMOL. EVO2 N. 32B GPSTY		
	308287711R	KIT COPPA POST.M.VERT.D.54 EV.2+LUNG		
	083710014R	KIT RIC RIVESTIMENTO DX VERT MEDIO L=300		
	414205R	KIT RICAMBI LANA HT 800 Plus 850g		
14101E	HONDA	CB 650 F	2014-2016	Leovince LV ONE EVO - FULL SYSTEM 4/2/1 - CARBON FIBER
	HONDA	CBR 650 F	2014-2016	
RICAMBI	307572505R	KIT fascetta FM4S Fact. Medio		
	3014016205R	KIT SACCHETTO COLLETTORE N. 4 COLL.PRIM		
	3014016207R	KIT SACCHETTO BIF. SEC HONDA CB CBR 650F		
	3014016209R	KIT RICAMBIO COLL. FINALE HONDA CB650		
	3014016601R	KIT SACCH. MINUT. HONDA CB650F-CBR 650F		
	5684	KIT TAPPO SONDA LAMBDA M12 BASE + GUARN		
	303949001R	KIT RIC MOLLA-GOMM. ANTIVIB. CORTA		
	308411481R	KIT R COR EV CAR D54 MED L300 0457 10410		
	088280002R	KIT KAMELLE E RIVETTI OM.0457 10410		
	3014008701R	KIT RICAMBIO COPPA POST. MEDIA VERT CARB		
	307762801R	KIT TAPPO X OMOL. EVO2 N. 32B GPSTY		
	308287711R	KIT COPPA POST.M.VERT.D.54 EV.2+LUNG		
	409117R	KIT RIVESTIMENTO MED CARB 100X115 L=300		
	414205R	KIT RICAMBI LANA HT 800 Plus 850g		
	206721R	KIT RIC TARGHETTA LEOVINCE CARBONIO		

ART.	MARCA	MODELLO		TIPOLOGIA
14102E	YAMAHA	MT-09 TRACER/FJ-09 (fits with original centre stand)	2015-2016	Leovince LV ONE EVO - FULL SYSTEM 3/1 - STAINLESS STEEL
RICAMBI	306958501R	KIT fascetta FM1 Factory Medio Verticale		
	308797204R	KIT RICAMBIO SACC COLL PRIM. X MT09 '14		
	204870R	KIT RICAMBIO BOCCOLA INOX DIS.094/06		
	204448R	KIT RIC FLANGIA INOX 46 D DIS.086/04		
	3014102202R	KIT SACCHETTO TRIFORC. FINALE MT09 '14		
	3014102601R	KIT SACCHETTO MINUT. MT09 '14		
	5682	KIT TAPPO Sonda LAMBDA M18 BASE + GUARN		
	303949001R	KIT RIC MOLLA-GOMM. ANTIVIB. CORTA		
	308406481R	KIT R COR EVO IN D50 MED L=270 OM.0430		
	088282002R	KIT LAMELLE E RIVETTI OM.0429 0430		
	3014008701R	KIT RICAMBIO COPPA POST. MEDIA VERT CARB		
	204790R	KIT RIC GOMMINO COPPE CARBONIO D.007/06		
	307762801R	KIT TAPPO X OMOL. EVO2 N. 32B GPSTY		
	308287711R	KIT COPPA POST.M.VERT.D.54 EV.2+LUNG		
	088406004R	KIT RIC RIVESTIMENTO FACT.DX MEDIO L=270		
	414205R	KIT RICAMBI LANA HT 800 Plus 850g		
14103E	YAMAHA	MT-09 TRACER/FJ-09 (fits with original centre stand)	2015-2016	Leovince LV ONE EVO - FULL SYSTEM 3/1 - CARBON FIBER
RICAMBI	306958501R	KIT fascetta FM1 Factory Medio Verticale		
	308797204R	KIT RICAMBIO SACC COLL PRIM. X MT09 '14		
	204870R	KIT RICAMBIO BOCCOLA INOX DIS.094/06		
	204448R	KIT RIC FLANGIA INOX 46 D DIS.086/04		
	3014102202R	KIT SACCHETTO TRIFORC. FINALE MT09 '14		
	3014102601R	KIT SACCHETTO MINUT. MT09 '14		
	5682	KIT TAPPO Sonda LAMBDA M18 BASE + GUARN		
	303949001R	KIT RIC MOLLA-GOMM. ANTIVIB. CORTA		
	308407481R	KIT R COR EV CAR D50 MED L=270 OM.0430		
	085096022R	KIT LAMELLE E RIVETTI OM.430 014		
	3014008701R	KIT RICAMBIO COPPA POST. MEDIA VERT CARB		
	204790R	KIT RIC GOMMINO COPPE CARBONIO D.007/06		
	307762801R	KIT TAPPO X OMOL. EVO2 N. 32B GPSTY		
	308287711R	KIT COPPA POST.M.VERT.D.54 EV.2+LUNG		
	088407002R	KIT RIC RIVESTIMENTO FACTORY MEDIO L=270		
	414205R	KIT RICAMBI LANA HT 800 Plus 850g		
	206721R	KIT RIC TARGHETTA LEOVINCE CARBONIO		
14104E	YAMAHA	MT-07/FZ-07/ABS	2014-2016	Leovince LV ONE EVO - FULL SYSTEM 2/1 - STAINLESS STEEL
RICAMBI	306958501R	KIT fascetta FM1 Factory Medio Verticale		
	308796204R	KIT SACCHETTO COLLETTORE PRIMARIO X MT07		
	204833R	KIT RIC BOCCOLA INOX DIS.028/06		
	204569R	KIT RIC FLANGIA INOX 112 A DIS.195/04		
	3014018202R	KIT SACCHETTO BIFOR SECOND. MT07 '14/'15		
	3014018204R	KIT RICAMBI COLL. FINALE MT07		
	3014018601R	KIT RICAMBI SACCHETTO MINUTERIA MT07		
	5684	KIT TAPPO Sonda LAMBDA M12 BASE + GUARN		
	303949001R	KIT RIC MOLLA-GOMM. ANTIVIB. CORTA		
	308402481R	KIT R COR EV I D50 ME L300 0429/30 10394		
	088282004R	KIT LAMELLE E RIVETTI OM.0430 0457 10394		
	3014008701R	KIT RICAMBIO COPPA POST. MEDIA VERT CARB		
	307762801R	KIT TAPPO X OMOL. EVO2 N. 32B GPSTY		
	308287711R	KIT COPPA POST.M.VERT.D.54 EV.2+LUNG		
	083710014R	KIT RIC RIVESTIMENTO DX VERT MEDIO L=300		
	414205R	KIT RICAMBI LANA HT 800 Plus 850g		
14105E	YAMAHA	MT-07/FZ-07/ABS	2014-2016	Leovince LV ONE EVO - FULL SYSTEM 2/1 - CARBON FIBER
RICAMBI	306958501R	KIT fascetta FM1 Factory Medio Verticale		
	308796204R	KIT SACCHETTO COLLETTORE PRIMARIO X MT07		
	204833R	KIT RIC BOCCOLA INOX DIS.028/06		
	204569R	KIT RIC FLANGIA INOX 112 A DIS.195/04		
	3014018202R	KIT SACCHETTO BIFOR SECOND. MT07 '14/'15		
	3014018204R	KIT RICAMBI COLL. FINALE MT07		



ART.	MARCA	MODELLO	TIPOLOGIA
		3014018601R KIT RICAMBI SACCHETTO MINUTERIA MT07 5684 KIT TAPPO SONDA LAMBDA M12 BASE + GUARN 303949001R KIT RIC MOLLA-GOMM. ANTIVIB. CORTA 308403481R KIT R COR EV CA D50 M L300 0429/30 10394 085096024R KIT LAMELLE E RIVETTI 0429 0430 10394 3014008701R KIT RICAMBIO COPPA POST. MEDIA VERT CARB 307762801R KIT TAPPO X OMOL. EVO2 N. 32B GPSTY 308287711R KIT COPPA POST.M.VERT.D.54 EV.2+LUNG 409117R KIT RIVESTIMENTO MED CARB 100X115 L=300 414205R KIT RICAMBI LANA HT 800 Plus 850g 206721R KIT RIC TARGHETTA LEOVINCE CARBONIO	
<b>14106E</b>	HONDA	CBR 1000 RR/SP/ABS	2014-2016 Leovince LV ONE EVO - SLIP-ON - STAINLESS STEEL
<b>RICAMBI</b>		307572505R KIT fascetta FM4S Fact. Medio 308798202R KIT RICAMBIO SACC COLL POST CBR1000 RR 300063530R KIT fascetta 63 Inox 3014106601R KIT SACCH. MINUTERIA CBR 1000 RR '13/'15 303949001R KIT RIC MOLLA-GOMM. ANTIVIB. CORTA 308412481R KIT R COR EV IN D54 MED L=250 OM.9634 088413002R KIT LAMELLE E RIVETTI OM.9634 3014008701R KIT RICAMBIO COPPA POST. MEDIA VERT CARB 307677801R KIT TAPPO X OMOL. EVO2 N. 32 BMW 308287711R KIT COPPA POST.M.VERT.D.54 EV.2+LUNG 088283004R KIT RIC RIVESTIMENTO FACT.DX MEDIO L=250 414205R KIT RICAMBI LANA HT 800 Plus 850g	
<b>14107E</b>	HONDA	CBR 1000 RR/SP/ABS	2014-2016 Leovince LV ONE EVO - SLIP-ON - CARBON FIBER
<b>RICAMBI</b>		307572505R KIT fascetta FM4S Fact. Medio 308798202R KIT RICAMBIO SACC COLL POST CBR1000 RR 300063530R KIT fascetta 63 Inox 3014106601R KIT SACCH. MINUTERIA CBR 1000 RR '13/'15 303949001R KIT RIC MOLLA-GOMM. ANTIVIB. CORTA 308413481R KIT R COR EV CAR D54 MED L=250 OM.9634 085096018R KIT LAMELLE E RIVETTI OM.9634 014 3014008701R KIT RICAMBIO COPPA POST. MEDIA VERT CARB 307677801R KIT TAPPO X OMOL. EVO2 N. 32 BMW 308287711R KIT COPPA POST.M.VERT.D.54 EV.2+LUNG 409118R KIT RIVESTIMENTO MED CARB 100X115 L=250 414205R KIT RICAMBI LANA HT 800 Plus 850g 206721R KIT RIC TARGHETTA LEOVINCE CARBONIO	
<b>14108E</b>	PEUGEOT	METROPOLIS 400i	2013-2016 Leovince LV ONE EVO - SLIP-ON - STAINLESS STEEL
<b>RICAMBI</b>		308078804R KIT RIC TAPPO N.57 x SCOOTERONI 308562501R KIT fascetta FB5AS CARBONIO LVONE 3014108202R KIT SACCHETTO COLLETTORE POSTER N.1059 300041530R KIT fascetta 41 Inox 3014108601R KIT SACCH. MINUT. METROPOLIS 400 '13/'15 205359R KIT BOCCOLA INOX 54X50X35 DIS.040/09 303949001R KIT RIC MOLLA-GOMM. ANTIVIB. CORTA 308488481R KIT R COR EVO IN R D54 BIG 0233/35 10400 088292004R KIT LAMELLE E RIVETTI OM.0233 0235 10400 3014000701R KIT RICAMBI COPPA POST.BIG VERTICALE CAR 307762801R KIT TAPPO X OMOL. EVO2 N. 32B GPSTY 307242711R KIT COPPA POST.FACT.VERT. D.54 EV.2 088291004R KIT RIC RIVESTIMENTO FACT.DX BIG L=370 414205R KIT RICAMBI LANA HT 800 Plus 850g	
<b>14109E</b>	HONDA	CBR 300 R	2014-2017 Leovince LV ONE EVO - SLIP-ON - STAINLESS STEEL
	HONDA	CB 300 F (US model only)	2014-2017
<b>RICAMBI</b>		307572501R KIT FASCETTA FM4 CARBONIO 3014109202R KIT SACCHETTO COLLETTORE POSTER N.1060 300043530R KIT fascetta 43 Inox 3014109601R KIT SACCH. MINUT. HONDA CBR 300R '13/'15 303949001R KIT RIC MOLLA-GOMM. ANTIVIB. CORTA	

ART.	MARCA	MODELLO	TIPOLOGIA
		308402481R KIT R COR EV I D50 ME L300 0429/30 10394 088282004R KIT LAMELLE E RIVETTI OM.0430 0457 10394 3014008701R KIT RICAMBIO COPPA POST. MEDIA VERT CARB 307762801R KIT TAPPO X OMOL. EVO2 N. 32B GPSTY 308287711R KIT COPPA POST.M.VERT.D.54 EV.2+LUNG 083710014R KIT RIC RIVESTIMENTO DX VERT MEDIO L=300 414205R KIT RICAMBI LANA HT 800 Plus 850g	
<b>14110E</b>	HONDA	CBR 300 R	2014-2017 Leovince LV ONE EVO - SLIP-ON - CARBON FIBER
	HONDA	CB 300 F (US model only)	2014-2017
<b>RICAMBI</b>		307572501R KIT FASCETTA FM4 CARBONIO 3014109202R KIT SACCHETTO COLLETTORE POSTER N.1060 300043530R KIT fascetta 43 Inox 3014109601R KIT SACCH. MINUT. HONDA CBR 300R '13/'15 303949001R KIT RIC MOLLA-GOMM. ANTIVIB. CORTA 308403481R KIT R COR EV CA D50 M L300 0429/30 10394 085096024R KIT LAMELLE E RIVETTI 0429 0430 10394 3014008701R KIT RICAMBIO COPPA POST. MEDIA VERT CARB 307762801R KIT TAPPO X OMOL. EVO2 N. 32B GPSTY 308287711R KIT COPPA POST.M.VERT.D.54 EV.2+LUNG 409117R KIT RIVESTIMENTO MED CARB 100X115 L=300 414205R KIT RICAMBI LANA HT 800 Plus 850g 206721R KIT RIC TARGHETTA LEOVINCE CARBONIO	
<b>14111E</b>	HONDA	FORZA 125/NSS 125/ABS	2015-2016 Leovince LV ONE EVO - FULL SYSTEM 1/1 - STAINLESS STEEL
<b>RICAMBI</b>		307572505R KIT fascetta FM4S Fact. Medio 307659501R KIT FASCETTA FM5 CARBONIO 3014015802R KIT TAPPO RICAMBIO db-killer 57B 308770202R KIT SACCHETTO COLLETTORE POSTER N.1013 3014111601R KIT SACCH. MINUT. HONDA FORZA 125 '15 206294R KIT RIC BOCCOLA INOX 40<50 xColeg. Silen 303949001R KIT RIC MOLLA-GOMM. ANTIVIB. CORTA 308295481R KIT RIC.COR EVO IN D50MED L=370 OM.0231 088296002R KIT LAMELLE E RIVETTI OM.0231 3014008701R KIT RICAMBIO COPPA POST. MEDIA VERT CARB 307762801R KIT TAPPO X OMOL. EVO2 N. 32B GPSTY 308287711R KIT COPPA POST.M.VERT.D.54 EV.2+LUNG 083980016R KIT RIC RIVESTIMENTO VERT.DX MEDIO L=370 414205R KIT RICAMBI LANA HT 800 Plus 850g	
<b>14112E</b>	SUZUKI	GSX-S 1000	2015-2016 Leovince LV ONE EVO - SLIP-ON - STAINLESS STEEL
	SUZUKI	GSX-S 1000 F	2015-2016
<b>RICAMBI</b>		307572505R KIT fascetta FM4S Fact. Medio 3014112202R KIT SACCHETTO COLLETTORE N.1063 300049530R KIT fascetta 49 Inox 3014112601R KIT SACCH. MINUT.SUZUKI GSX-S 1000 '15 300051535R KIT fascetta 51 Inox + Gancio 90° e Staf 303949001R KIT RIC MOLLA-GOMM. ANTIVIB. CORTA 308402481R KIT R COR EV I D50 ME L300 0429/30 10394 088282004R KIT LAMELLE E RIVETTI OM.0430 0457 10394 3014008701R KIT RICAMBIO COPPA POST. MEDIA VERT CARB 307762801R KIT TAPPO X OMOL. EVO2 N. 32B GPSTY 308287711R KIT COPPA POST.M.VERT.D.54 EV.2+LUNG 083710014R KIT RIC RIVESTIMENTO DX VERT MEDIO L=300 414205R KIT RICAMBI LANA HT 800 Plus 850g	
<b>14116E</b>	DUCATI	SCRAMBLER 800 ICON/CLASSIC	2015-2016 Leovince LV ONE EVO - SLIP-ON - STAINLESS STEEL
<b>RICAMBI</b>		307572505R KIT fascetta FM4S Fact. Medio 3014116202R KIT SACCHETTO COLLETTORE N.1068 3014116601R KIT SACCH. MINUT. DUCATI SCRAMBLER 800 303949001R KIT RIC MOLLA-GOMM. ANTIVIB. CORTA 308402481R KIT R COR EV I D50 ME L300 0429/30 10394 088282004R KIT LAMELLE E RIVETTI OM.0430 0457 10394 3014008701R KIT RICAMBIO COPPA POST. MEDIA VERT CARB	

ART.	MARCA	MODELLO	TIPOLOGIA
		307762801R KIT TAPPO X OMOL. EVO2 N. 32B GPSTY 308287711R KIT COPPA POST.M.VERT.D.54 EV.2+LUNG 083710014R KIT RIC RIVESTIMENTO DX VERT MEDIO L=300 414205R KIT RICAMBI LANA HT 800 Plus 850g	
<b>14118B</b>	DUCATI	SCRAMBLER 800 ICON/CLASSIC	2015-2016 Leovince GP STYLE BLACK - SLIP-ON - STAINLESS STEEL
RICAMBI		3014116202R KIT SACCHETTO COLLETTORE N.1068 3014118601R KIT SACCH. MINUT. DUCATI SCRAMBLER 800 303949001R KIT RIC MOLLA-GOMM. ANTIVIB. CORTA 308124475R KIT RIC CORPO DX Ø150 L=295 IN OM0473 BL 307762801R KIT TAPPO X OMOL. EVO2 N. 32B GPSTY	
<b>14118</b>	DUCATI	SCRAMBLER 800 ICON/CLASSIC	2015-2016 Leovince GP STYLE - SLIP-ON - STAINLESS STEEL
	DUCATI	SCRAMBLER 800 ICON/CLASSIC	2015-2016
RICAMBI		3014116202R KIT SACCHETTO COLLETTORE N.1068 3014118601R KIT SACCH. MINUT. DUCATI SCRAMBLER 800 303949001R KIT RIC MOLLA-GOMM. ANTIVIB. CORTA 308124471R KIT RIC CORPO DX Ø150 L=295 INOX OM.0473 307762801R KIT TAPPO X OMOL. EVO2 N. 32B GPSTY	
<b>14119S</b>	YAMAHA	YZF 1000 R1	2015-2016 Leovince FACTORY S - SLIP-ON - STAINLESS STEEL
RICAMBI		308444501R KIT fascetta FR3 CARBONIO PICCOLA 3014119202R KIT SACCHETTO COLLETTORE N.1069 3014119601R KIT SACCH. MINUTERIA YAMAHA R1 '15 300057532R KIT Fascetta 57 Inox + 2 Ganci Molla 308574001R KIT RIC MOLLA TRAZ SUPER CORTA + TUBETTO 308421481R KIT R CO DX IN C D54 L=270 10057/8 10395 088421026R KIT LAMELLE E RIVETTI OM.10057-58 10395 308420701R KIT RICAMBIO COPPA POST. DX FACT CARB 308421801R KIT TAPPO X OMOL. EVO2 N. 52 FACTORY -R 308421741R KIT COPPA POST.DX VERT. FACTORY-R Ø50 088421046R KIT RIC RIVESTIMENTO FACTORY INOX L=270 416797R KIT RICAMBIO LANA FACTORY L=270	
<b>14120S</b>	YAMAHA	YZF 1000 R1	2015-2016 Leovince FACTORY S - SLIP-ON - CARBON FIBER
RICAMBI		308444501R KIT fascetta FR3 CARBONIO PICCOLA 3014119202R KIT SACCHETTO COLLETTORE N.1069 3014119601R KIT SACCH. MINUTERIA YAMAHA R1 '15 300057532R KIT Fascetta 57 Inox + 2 Ganci Molla 308574001R KIT RIC MOLLA TRAZ SUPER CORTA + TUBETTO 308420481R KIT R CO DX CAR D54 L=270 10057/8 10395 088421026R KIT LAMELLE E RIVETTI OM.10057-58 10395 308420701R KIT RICAMBIO COPPA POST. DX FACT CARB 308421801R KIT TAPPO X OMOL. EVO2 N. 52 FACTORY -R 308421741R KIT COPPA POST.DX VERT. FACTORY-R Ø50 088420002R KIT RIC RIVESTIMENTO FACT 270mm CARB 416797R KIT RICAMBIO LANA FACTORY L=270 206721R KIT RIC TARGHETTA LEOVINCE CARBONIO	
<b>14121</b>	HONDA	SH 125i/ABS	2013-2016 Leovince NERO - FULL SYSTEM 1/1 - STAINLESS STEEL
	HONDA	SH 150i/ABS	2013-2016
RICAMBI		3014015802R KIT TAPPO RICAMBIO db-killer 57B 3014121202R KIT SACCHETTO COLLETTORE N.1071 3014121601R KIT SACCH. MINUTERIA HONDA SH 125/150 303949001R KIT RIC MOLLA-GOMM. ANTIVIB. CORTA 3014009471R KIT RIC CORPO d.i50 MEDIO IN 0430 10394 088282004R KIT LAMELLE E RIVETTI OM.0430 0457 10394 3014008701R KIT RICAMBIO COPPA POST. MEDIA VERT CARB 204790R KIT RIC GOMMINO COPPE CARBONIO D.007/06 307762801R KIT TAPPO X OMOL. EVO2 N. 32B GPSTY 3014008750VLR KIT RIC RIVESTIMENTO MEDIO L=300 NERO 414205R KIT RICAMBI LANA HT 800 Plus 850g	

ART.	MARCA	MODELLO		TIPOLOGIA
14122E	YAMAHA	MT-25	2015-2017	Leovince LV ONE EVO - FULL SYSTEM 2/1 - STAINLESS STEEL
	YAMAHA	YZF-R25	2014-2017	
	YAMAHA	MT-03	2016-2017	
	YAMAHA	MT-03	2018-	
	YAMAHA	YZF-R3	2015-2017	
	YAMAHA	YZF-R3	2018-	
	YAMAHA	YZF-R3 (US model only)	2015-2018	
RICAMBI	307572505R	KIT fascetta FM4S Fact. Medio		
	303379202R	KIT SACCHETTO COLLETTORE PRIMARIO N.1072		
	303379204R	KIT SACCHETTO COLLETTORE FINALE N.1073		
	3014122601R	KIT SACCH. MINUT. YAMAHA YZF MT25 R25 R3		
	5684	KIT TAPPO SONDA LAMBDA M12 BASE + GUARN		
	303949001R	KIT RIC MOLLA-GOMM. ANTIVIB. CORTA		
	308574001R	KIT RIC MOLLA TRAZ SUPER CORTA + TUBETTO		
	308410481R	KIT R COR EV IN D54 MED L300 0457 10410		
	088280002R	KIT KAMELLE E RIVETTI OM.0457 10410		
	3014008701R	KIT RICAMBIO COPPA POST. MEDIA VERT CARB		
	307762801R	KIT TAPPO X OMOL. EVO2 N. 32B GPSTY		
	308287711R	KIT COPPA POST.M.VERT.D.54 EV.2+LUNG		
	083710014R	KIT RIC RIVESTIMENTO DX VERT MEDIO L=300		
	414205R	KIT RICAMBI LANA HT 800 Plus 850g		
14123E	YAMAHA	MT-25	2015-2017	Leovince LV ONE EVO - FULL SYSTEM 2/1 - CARBON FIBER
	YAMAHA	YZF-R25	2014-2017	
	YAMAHA	MT-03	2016-2017	
	YAMAHA	MT-03	2018-	
	YAMAHA	YZF-R3	2015-2017	
	YAMAHA	YZF-R3	2018-	
	YAMAHA	YZF-R3 (US model only)	2015-2018	
RICAMBI	307572505R	KIT fascetta FM4S Fact. Medio		
	303379202R	KIT SACCHETTO COLLETTORE PRIMARIO N.1072		
	303379204R	KIT SACCHETTO COLLETTORE FINALE N.1073		
	3014122601R	KIT SACCH. MINUT. YAMAHA YZF MT25 R25 R3		
	5684	KIT TAPPO SONDA LAMBDA M12 BASE + GUARN		
	303949001R	KIT RIC MOLLA-GOMM. ANTIVIB. CORTA		
	308574001R	KIT RIC MOLLA TRAZ SUPER CORTA + TUBETTO		
	308411481R	KIT R COR EV CAR D54 MED L300 0457 10410		
	088280002R	KIT KAMELLE E RIVETTI OM.0457 10410		
	3014008701R	KIT RICAMBIO COPPA POST. MEDIA VERT CARB		
	307762801R	KIT TAPPO X OMOL. EVO2 N. 32B GPSTY		
	308287711R	KIT COPPA POST.M.VERT.D.54 EV.2+LUNG		
	409117R	KIT RIVESTIMENTO MED CARB 100X115 L=300		
	414205R	KIT RICAMBI LANA HT 800 Plus 850g		
	206721R	KIT RIC TARGHETTA LEOVINCE CARBONIO		
14124E	YAMAHA	MT-25	2015-2017	Leovince LV PRO - SLIP-ON - STAINLESS STEEL
	YAMAHA	YZF-R25	2014-2017	
	YAMAHA	MT-03	2016-2017	
	YAMAHA	YZF-R3	2015-2017	
	YAMAHA	YZF-R3 (US model only)	2015-2018	
RICAMBI	307572505R	KIT fascetta FM4S Fact. Medio		
	3014124202R	KIT SACCHETTO COLLETTORE N.1074		
	3014124601R	KIT SACCH. MINUT. YAMAHA YZF MT25 R25 R3		
	206414R	KIT RIC BOCCOLA LGR/F 40X31,7XH30		
	300041530R	KIT fascetta 41 Inox		
	303949001R	KIT RIC MOLLA-GOMM. ANTIVIB. CORTA		
	3014124481R	KIT R C PRO DX I50 COR L=180 10074 10393		
	088442008R	KIT LAMELLE E RIVETTI O. 10074-10393		
	308494701R	KIT RIC COPPA CAR.VERT.FACT.SOTTOSELLA		
	308437801R	KIT TAPPO dB-KILLER N. 52B FACTORY R		
	3014124741R	KIT COPPA POST VERTICALE Ø50 SOTTOSELLA		
	0814124004R	KIT RIC RIVESTIMENTO DX MEDIO L180 NO BA		
	414205R	KIT RICAMBI LANA HT 800 Plus 850g		

ART.	MARCA	MODELLO	TIPOLOGIA
14125E	YAMAHA	MT-25	2015-2017 Leovince LV PRO - SLIP-ON - CARBON FIBER
	YAMAHA	YZF-R25	2014-2017
	YAMAHA	MT-03	2016-2017
	YAMAHA	YZF-R3	2015-2017
	YAMAHA	YZF-R3 (US model only)	2015-2018
RICAMBI	307572505R	KIT fascetta FM4S Fact. Medio	
	3014124202R	KIT SACCHETTO COLLETTORE N.1074	
	3014124601R	KIT SACCH. MINUT. YAMAHA YZF MT25 R25 R3	
	206414R	KIT RIC BOCCOLA LGR/F 40X31,7XH30	
	300041530R	KIT fascetta 41 Inox	
	303949001R	KIT RIC MOLLA-GOMM. ANTIVIB. CORTA	
	3014124482R	KIT R C PRO DX C50 COR L=180 10074 10393	
	088442010R	KIT LAMELLE E RIVETTI O. 10074-10393	
	308494701R	KIT RIC COPPA CAR.VERT.FACT.SOTTOSELLA	
	308437801R	KIT TAPPO dB-KILLER N. 52B FACTORY R	
	3014124741R	KIT COPPA POST VERTICALE Ø50 SOTTOSELLA	
	088442006R	KIT RIC RIVESTIMENTO MEDIO CARB L=180mm	
	414205R	KIT RICAMBI LANA HT 800 Plus 850g	
	206733R	KIT RIC TARGHETTA LEOVINCE CARB LV PRO	
14126S	HONDA	CBR 1000 RR/SP/ABS	2014-2016 Leovince FACTORY S - SLIP-ON - CARBON FIBER
RICAMBI	308444501R	KIT fascetta FR3 CARBONIO PICCOLA	
	308798202R	KIT RICAMBIO SACC COLL POST CBR1000 RR	
	300063530R	KIT fascetta 63 Inox	
	308798601R	KIT SACCH. MINUT. CBR 1000 RR '13/'15	
	303949001R	KIT RIC MOLLA-GOMM. ANTIVIB. CORTA	
	308420481R	KIT R CO DX CAR D54 L=270 10057/8 10395	
	088421026R	KIT LAMELLE E RIVETTI OM.10057-58 10395	
	308420701R	KIT RICAMBIO COPPA POST. DX FACT CARB	
	308421801R	KIT TAPPO X OMOL. EVO2 N. 52 FACTORY -R	
	308421741R	KIT COPPA POST.DX VERT. FACTORY-R Ø50	
	088420002R	KIT RIC RIVESTIMENTO FACT 270mm CARB	
	416797R	KIT RICAMBIO LANA FACTORY L=270	
	206721R	KIT RIC TARGHETTA LEOVINCE CARBONIO	
14129E	DUCATI	MULTISTRADA 1200S D/AIR (fits with original panniers)	2015-2017 Leovince LV PRO - SLIP-ON - STAINLESS STEEL
RICAMBI	307572505R	KIT fascetta FM4S Fact. Medio	
	3014129202R	KIT SACCHETTO COLLETTORE N.1078	
	3014129002R	KIT SACC CARTER CARB. DUCATI MULTI 1200	
	3014129601R	KIT SACCH. MINUT. DUCATI MULTISTRADA 120	
	0814129001R	KIT STAFFA CARB. DUCATI MULTIST 1200 '16	
	300057533R	KIT Fascetta 57 Inox +1 Ganc +1 Ganc 90°	
	303949001R	KIT RIC MOLLA-GOMM. ANTIVIB. CORTA	
	3014129481R	KIT COR PRO DX I54 COR L=180 10074 10405	
	088442012R	KIT LAMELLE E RIVETTI O. 10074-10405	
	308494701R	KIT RIC COPPA CAR.VERT.FACT.SOTTOSELLA	
	308437801R	KIT TAPPO dB-KILLER N. 52B FACTORY R	
	308442711R	KIT COPPA POST VERTICALE Ø54 SOTTOSELLA	
	0814124004R	KIT RIC RIVESTIMENTO DX MEDIO L180 NO BA	
	414205R	KIT RICAMBI LANA HT 800 Plus 850g	
14130E	DUCATI	MULTISTRADA 1200S D/AIR (fits with original panniers)	2015-2017 Leovince LV PRO - SLIP-ON - CARBON FIBER
RICAMBI	307572505R	KIT fascetta FM4S Fact. Medio	
	3014129202R	KIT SACCHETTO COLLETTORE N.1078	
	3014129002R	KIT SACC CARTER CARB. DUCATI MULTI 1200	
	3014129601R	KIT SACCH. MINUT. DUCATI MULTISTRADA 120	
	0814129001R	KIT STAFFA CARB. DUCATI MULTIST 1200 '16	
	300057533R	KIT Fascetta 57 Inox +1 Ganc +1 Ganc 90°	
	303949001R	KIT RIC MOLLA-GOMM. ANTIVIB. CORTA	
	3014129482R	KIT COR PRO DX C54 COR L=180 10074 10405	
	088442014R	KIT LAMELLE E RIVETTI O. 10074-10405	
	308494701R	KIT RIC COPPA CAR.VERT.FACT.SOTTOSELLA	
	308437801R	KIT TAPPO dB-KILLER N. 52B FACTORY R	
	308442711R	KIT COPPA POST VERTICALE Ø54 SOTTOSELLA	

ART.	MARCA	MODELLO	TIPOLOGIA
		088442006R 414205R 206733R	KIT RIC RIVESTIMENTO MEDIO CARB L=180mm KIT RICAMBI LANA HT 800 Plus 850g KIT RIC TARGHETTA LEOVINCE CARB LV PRO
<b>14133E</b>	DUCATI	MONSTER 821	2014-2016 Leovince LV ONE EVO - SLIP-ON - STAINLESS STEEL
RICAMBI		307572505R 3014133202R 3014133681R 083896002R 300063530R 303949001R 308402481R 088282004R 3014008701R 307762801R 308287711R 083710014R 414205R	KIT fascetta FM4S Fact. Medio KIT SACCHETTO COLLETTORE N.1080 KIT SACCH. MINUT. DUCATI MONSTER 821 '14 KIT CARTER CARBONIO LATER X RAPTOR '06 KIT fascetta 63 Inox KIT RIC MOLLA-GOMM. ANTIVIB. CORTA KIT R COR EV I D50 ME L300 0429/30 10394 KIT LAMELLE E RIVETTI OM.0430 0457 10394 KIT RICAMBIO COPPA POST. MEDIA VERT CARB KIT TAPPO X OMOL. EVO2 N. 32B GPSTY KIT COPPA POST.M.VERT.D.54 EV.2+LUNG KIT RIC RIVESTIMENTO DX VERT MEDIO L=300 KIT RICAMBI LANA HT 800 Plus 850g
<b>14134E</b>	DUCATI	MONSTER 821	2014-2016 Leovince LV ONE EVO - SLIP-ON - CARBON FIBER
RICAMBI		307572505R 3014133202R 3014133681R 083896002R 300063530R 303949001R 308403481R 085096024R 3014008701R 307762801R 308287711R 409117R 414205R 206721R	KIT fascetta FM4S Fact. Medio KIT SACCHETTO COLLETTORE N.1080 KIT SACCH. MINUT. DUCATI MONSTER 821 '14 KIT CARTER CARBONIO LATER X RAPTOR '06 KIT fascetta 63 Inox KIT RIC MOLLA-GOMM. ANTIVIB. CORTA KIT R COR EV CA D50 M L300 0429/30 10394 KIT LAMELLE E RIVETTI 0429 0430 10394 KIT RICAMBIO COPPA POST. MEDIA VERT CARB KIT TAPPO X OMOL. EVO2 N. 32B GPSTY KIT COPPA POST.M.VERT.D.54 EV.2+LUNG KIT RIVESTIMENTO MED CARB 100X115 L=300 KIT RICAMBI LANA HT 800 Plus 850g KIT RIC TARGHETTA LEOVINCE CARBONIO
<b>14137S</b>	BMW	R 1200 R (fits with original panniers)	2015-2016 Leovince FACTORY S - SLIP-ON - STAINLESS STEEL
	BMW	R 1200 RS (fits with original panniers)	2015-2016
RICAMBI		308448501R 3014137001R 3014137202R 3014137601R 300067530R 303949001R 308421481R 088421026R 308420701R 308421801R 308421741R 088421046R 416797R	KIT fascetta FR2 CARBONIO MEDIA KIT SACC CARTER CARB. BMW R1200R '15/'16 KIT SACCHETTO COLLETTORE N.1085 KIT SACCH. MINUT. BMW R1200R '15/'16 KIT fascetta 67 Inox KIT RIC MOLLA-GOMM. ANTIVIB. CORTA KIT R CO DX IN C D54 L=270 10057/8 10395 KIT LAMELLE E RIVETTI OM.10057-58 10395 KIT RICAMBIO COPPA POST. DX FACT CARB KIT TAPPO X OMOL. EVO2 N. 52 FACTORY -R KIT COPPA POST.DX VERT. FACTORY-R Ø50 KIT RIC RIVESTIMENTO FACTORY INOX L=270 KIT RICAMBIO LANA FACTORY L=270
<b>14138S</b>	BMW	R 1200 R (fits with original panniers)	2015-2016 Leovince FACTORY S - SLIP-ON - CARBON FIBER
	BMW	R 1200 RS (fits with original panniers)	2015-2016
RICAMBI		308448501R 3014137001R 3014137202R 3014137601R 300067530R 303949001R 308420481R 088421026R 308420701R 308421801R 308421741R	KIT fascetta FR2 CARBONIO MEDIA KIT SACC CARTER CARB. BMW R1200R '15/'16 KIT SACCHETTO COLLETTORE N.1085 KIT SACCH. MINUT. BMW R1200R '15/'16 KIT fascetta 67 Inox KIT RIC MOLLA-GOMM. ANTIVIB. CORTA KIT R CO DX CAR D54 L=270 10057/8 10395 KIT LAMELLE E RIVETTI OM.10057-58 10395 KIT RICAMBIO COPPA POST. DX FACT CARB KIT TAPPO X OMOL. EVO2 N. 52 FACTORY -R KIT COPPA POST.DX VERT. FACTORY-R Ø50

ART.	MARCA	MODELLO	TIPOLOGIA
		088420002R 416797R 206721R	KIT RIC RIVESTIMENTO FACT 270mm CARB KIT RICAMBIO LANA FACTORY L=270 KIT RIC TARGHETTA LEOVINCE CARBONIO
<b>14139E</b>	HONDA	CRF 1000 L AFRICA TWIN EURO 3 (fits with original panniers)	2016-2017 Leovince LV ONE EVO - SLIP-ON - STAINLESS STEEL
RICAMBI		306960505R 3014028204R 3014028011R 3014139601R 0814139501R 300035530R 303949001R 308424481R 088425010R 3014000701R 307762801R 307242711R 088291004R 414205R	KIT FASCETTA FB1S CARBONIO KIT SACCHETTO COLLETTOR N.1096 KIT SACC CARTER CAR HONDA CRF1000L AFTWN KIT SACCH. MINUT.HONDA CRF 1000L AFRICA KIT STAFFA CARB. HONDA CRF1000L AFR TWIN KIT fascetta 35 Inox KIT RIC MOLLA-GOMM. ANTIVIB. CORTA KIT R COR EV IN RETE D50 BIG 0230 10399 KIT LAMELLE E RIVETTI OM.0230 10399 KIT RICAMBI COPPA POST.BIG VERTICALE CAR KIT TAPPO X OMOL. EVO2 N. 32B GPSTY KIT COPPA POST.FACT.VERT. D.54 EV.2 KIT RIC RIVESTIMENTO FACT.DX BIG L=370 KIT RICAMBIO LANA HT 800 Plus 850g
<b>14140S</b>	BMW	S 1000 XR (fits with original panniers)	2015-2016 Leovince FACTORY S - SLIP-ON - STAINLESS STEEL
	BMW	S 1000 XR (US model only, fits with original panniers)	2015-2018
RICAMBI		308444501R 3014140202R 3014140001R 3014140601R 300035530R 300053530R 303949001R 308421481R 088421026R 308420701R 308421801R 308421741R 088421046R 416797R	KIT fascetta FR3 CARBONIO PICCOLA KIT SACCHETTO COLLETTOR BIFOR. N.1083 KIT SACC CARTER CAR BMW S1000XR '15/'16 KIT SACCH. MINUT.BMW S1000XR '15/'16 KIT fascetta 35 Inox KIT fascetta 53 Inox KIT RIC MOLLA-GOMM. ANTIVIB. CORTA KIT R CO DX IN C D54 L=270 10057/8 10395 KIT LAMELLE E RIVETTI OM.10057-58 10395 KIT RICAMBIO COPPA POST. DX FACT CARB KIT TAPPO X OMOL. EVO2 N. 52 FACTORY -R KIT COPPA POST.DX VERT. FACTORY-R Ø50 KIT RIC RIVESTIMENTO FACTORY INOX L=270 KIT RICAMBIO LANA FACTORY L=270
<b>14141S</b>	BMW	S 1000 XR (fits with original panniers)	2015-2016 Leovince FACTORY S - SLIP-ON - CARBON FIBER
	BMW	S 1000 XR (US model only, fits with original panniers)	2015-2018
RICAMBI		308444501R 3014140202R 3014140001R 3014140601R 300035530R 300053530R 303949001R 308420481R 088421026R 308420701R 308421801R 308421741R 088420002R 416797R 206721R	KIT fascetta FR3 CARBONIO PICCOLA KIT SACCHETTO COLLETTOR BIFOR. N.1083 KIT SACC CARTER CAR BMW S1000XR '15/'16 KIT SACCH. MINUT.BMW S1000XR '15/'16 KIT fascetta 35 Inox KIT fascetta 53 Inox KIT RIC MOLLA-GOMM. ANTIVIB. CORTA KIT R CO DX CAR D54 L=270 10057/8 10395 KIT LAMELLE E RIVETTI OM.10057-58 10395 KIT RICAMBIO COPPA POST. DX FACT CARB KIT TAPPO X OMOL. EVO2 N. 52 FACTORY -R KIT COPPA POST.DX VERT. FACTORY-R Ø50 KIT RIC RIVESTIMENTO FACT 270mm CARB KIT RICAMBIO LANA FACTORY L=270 KIT RIC TARGHETTA LEOVINCE CARBONIO
<b>14142S</b>	KAWASAKI	ZX-10R NINJA	2016-2018 Leovince FACTORY S - SLIP-ON - STAINLESS STEEL
	KAWASAKI	ZX-10RR NINJA	2017-2018
RICAMBI		308444501R 3014142202R 3014142601R 300053530R 303949001R 308437481R 088421022R	KIT fascetta FR3 CARBONIO PICCOLA KIT SACCHETTO COLLETTOR N.1086 KIT SACCH. MINUT. KAWASAKI ZX10R '16 KIT fascetta 53 Inox KIT RIC MOLLA-GOMM. ANTIVIB. CORTA KIT R CO DX CAR CO D50 270 10057/8 10401 KIT LAMELLE E RIVETTI OM.10057-58 10401

ART.	MARCA	MODELLO		TIPOLOGIA
		308420701R 308437801R 308437741R 088421046R 416797R	KIT RICAMBIO COPPA POST. DX FACT CARB KIT TAPPO dB-KILLER N. 52B FACTORY R KIT COPPA POST.DX VERT. FACTORY-R Ø50 KIT RIC RIVESTIMENTO FACTORY INOX L=270 KIT RICAMBIO LANA FACTORY L=270	
<b>14143S</b>	KAWASAKI	ZX-10R NINJA	2016-2018	Leovince FACTORY S - SLIP-ON - CARBON FIBER
	KAWASAKI	ZX-10RR NINJA	2017-2018	
<b>RICAMBI</b>		308444501R 3014142202R 3014142601R 300053530R 303949001R 308436481R 088421022R 308420701R 308437801R 308437741R 088420002R 416797R 206721R	KIT fascetta FR3 CARBONIO PICCOLA KIT SACCHETTO COLLETTORE N.1086 KIT SACCH. MINUT. KAWASAKI ZX10R '16 KIT fascetta 53 Inox KIT RIC MOLLA-GOMM. ANTIVIB. CORTA KIT R CORPO DX C Ø50 L270 O10057/8 10401 KIT LAMELLE E RIVETTI OM.10057-58 10401 KIT RICAMBIO COPPA POST. DX FACT CARB KIT TAPPO dB-KILLER N. 52B FACTORY R KIT COPPA POST.DX VERT. FACTORY-R Ø50 KIT RIC RIVESTIMENTO FACT 270mm CARB KIT RICAMBIO LANA FACTORY L=270 KIT RIC TARGHETTA LEOVINCE CARBONIO	
<b>14144E</b>	KAWASAKI	Z 1000 SX (fits with original panniers)	2014-2016	Leovince LV ONE EVO - 2 SLIP-ON - STAINLESS STEEL
	KAWASAKI	NINJA 1000/ABS (US model only)	2010-2018	
<b>RICAMBI</b>		307572505R 3014144203R 3014144204R 3014144601R 303949001R 308410481R 308410482R 088280002R 3014008701R 307762801R 308287711R 083710014R 083710016R 414205R	KIT fascetta FM4S Fact. Medio KIT RICAMBI COLLETTORE 1088 KAW Z1000 SX KIT RICAMBI COLLETTORE 1089 KAW Z1000 SX KIT RICAMBI MINUT. KAW Z 1000 SX KIT RIC MOLLA-GOMM. ANTIVIB. CORTA KIT R COR EV IN D54 MED L300 0457 10410 KIT R COR SX EV IN 54 ME L300 0457 10410 KIT KAMELLE E RIVETTI OM.0457 10410 KIT RICAMBIO COPPA POST. MEDIA VERT CARB KIT TAPPO X OMOL. EVO2 N. 32B GPSTY KIT COPPA POST.M.VERT.D.54 EV.2+LUNG KIT RIC RIVESTIMENTO DX VERT MEDIO L=300 KIT RIC RIVESTIMENTO SX VERT. MEDI L=300 KIT RICAMBI LANA HT 800 Plus 850g	
<b>14145E</b>	KAWASAKI	Z 1000 SX (fits with original panniers)	2014-2016	Leovince LV ONE EVO - 2 SLIP-ON - CARBON FIBER
	KAWASAKI	NINJA 1000/ABS (US model only)	2010-2018	
<b>RICAMBI</b>		307572505R 3014144203R 3014144204R 3014144601R 303949001R 308411481R 308411482R 088280002R 3014008701R 307762801R 308287711R 409117R 414205R 206721R	KIT fascetta FM4S Fact. Medio KIT RICAMBI COLLETTORE 1088 KAW Z1000 SX KIT RICAMBI COLLETTORE 1089 KAW Z1000 SX KIT RICAMBI MINUT. KAW Z 1000 SX KIT RIC MOLLA-GOMM. ANTIVIB. CORTA KIT R COR EV CAR D54 MED L300 0457 10410 KIT R COR SX EV C 54 MED L300 0457 10410 KIT KAMELLE E RIVETTI OM.0457 10410 KIT RICAMBIO COPPA POST. MEDIA VERT CARB KIT TAPPO X OMOL. EVO2 N. 32B GPSTY KIT COPPA POST.M.VERT.D.54 EV.2+LUNG KIT RIVESTIMENTO MED CARB 100X115 L=300 KIT RICAMBI LANA HT 800 Plus 850g KIT RIC TARGHETTA LEOVINCE CARBONIO	
<b>14146S</b>	KAWASAKI	Z 1000 SX (fits with original panniers)	2014-2016	Leovince FACTORY S - 2 SLIP-ON - STAINLESS STEEL
	KAWASAKI	NINJA 1000/ABS (US model only)/clears hardbags	2010-2018	
<b>RICAMBI</b>		308444501R 3014146203R 3014146204R 3014146601R	KIT fascetta FR3 CARBONIO PICCOLA KIT SACCHETTO COLLETTORE N.1090 KIT SACCHETTO COLLETTORE N.1091 KIT SACCH. MINUT. KAWASAKI Z1000 SX '14	



ART.	MARCA	MODELLO	TIPOLOGIA
		303949001R KIT RIC MOLLA-GOMM. ANTIVIB. CORTA	
		308421481R KIT R CO DX IN C D54 L=270 10057/8 10395	
		308421482R KIT R CO SX IN C D54 L=270 10057/8 10395	
		088421026R KIT LAMELLE E RIVETTI OM.10057-58 10395	
		308420701R KIT RICAMBIO COPPA POST. DX FACT CARB	
		308420702R KIT RICAMBIO COPPA POST. SX FACT CARB	
		308421801R KIT TAPPO X OMOL. EVO2 N. 52 FACTORY -R	
		308421741R KIT COPPA POST.DX VERT. FACTORY-R Ø50	
		308421742R KIT COPPA POST.SX VERT. FACTORY-R Ø54	
		088421046R KIT RIC RIVESTIMENTO FACTORY INOX L=270	
		416797R KIT RICAMBIO LANA FACTORY L=270	
<b>14147S</b>	KAWASAKI	Z 1000 SX (fits with original panniers)	2014-2016 Leovince FACTORY S - 2 SLIP-ON - CARBON FIBER
	KAWASAKI	NINJA 1000/ABS (US model only)/clears hardbags	2010-2018
<b>RICAMBI</b>		308444501R KIT fascetta FR3 CARBONIO PICCOLA	
		3014146203R KIT SACCHETTO COLLETTORE N.1090	
		3014146204R KIT SACCHETTO COLLETTORE N.1091	
		3014146601R KIT SACCH. MINUT. KAWASAKI Z1000 SX '14	
		303949001R KIT RIC MOLLA-GOMM. ANTIVIB. CORTA	
		308420481R KIT R CO DX CAR D54 L=270 10057/8 10395	
		308420482R KIT R CO SX CAR D54 L=270 10057/8 10395	
		088421026R KIT LAMELLE E RIVETTI OM.10057-58 10395	
		308420701R KIT RICAMBIO COPPA POST. DX FACT CARB	
		308420702R KIT RICAMBIO COPPA POST. SX FACT CARB	
		308421801R KIT TAPPO X OMOL. EVO2 N. 52 FACTORY -R	
		308421741R KIT COPPA POST.DX VERT. FACTORY-R Ø50	
		308421742R KIT COPPA POST.SX VERT. FACTORY-R Ø54	
		088420002R KIT RIC RIVESTIMENTO FACT 270mm CARB	
		416797R KIT RICAMBIO LANA FACTORY L=270	
		206721R KIT RIC TARGHETTA LEOVINCE CARBONIO	
<b>14148</b>	YAMAHA	XSR 700 ABS	2016-2018 Leovince UNDERBODY - FULL SYSTEM 2/1 - STAINLESS STEEL
<b>RICAMBI</b>		3014030205R KIT SACCHETTO COLLETTORE PRIMARIO XSR700	
		204833R KIT RIC BOCCOLA INOX DIS.028/06	
		204569R KIT RIC FLANGIA INOX 112 A DIS.195/04	
		3014148202R KIT SACCHETTO COLLETTORE BIFORCA XSR 700	
		5684 KIT TAPPO SONDA LAMBDA M12 BASE + GUARN	
		3014148601R KIT SACCH. MINUT. YAMAHA XSR 700 '16	
		303949001R KIT RIC MOLLA-GOMM. ANTIVIB. CORTA	
		3014148471R KIT RIC CORPO Ø150 L=205 OM.10034 10417	
		088232014R KIT LAMELLE E RIVETTI OM.10034/42 10417	
		308232701R KIT COPPA POST.UNDERBODY CARB	
		204790R KIT RIC GOMMINO COPPE CARBONIO D.007/06	
		308232801R KIT TAPPO X OMOL. EVO2 UNDER Xd.50 N. 47	
		3014148750R KIT RIC RIVESTIMENTO UNDER CORTO L=205	
		8066 KIT RICAMBIO MATERIALE FONOAASS UNDERBODY	
<b>14152E</b>	SUZUKI	SV 650/ABS	2016-2018 Leovince LV ONE EVO - SLIP-ON - STAINLESS STEEL
	SUZUKI	SV 650 X ABS	2018-
<b>RICAMBI</b>		3014149501R KIT fascetta FM5SF Factory Medio Vertica	
		3014031204R KIT SACCHETTO COLLETTORE N.1092	
		308078804R KIT RIC TAPPO N.57 x SCOOTERONI	
		3014031601 SACCH. MINUT. SUZUKI SV 650 '16	
		204999R KIT RIC BOCCOLA 45X38X30 LGR/F D.026/07	
		300049530R KIT fascetta 49 Inox	
		303949001R KIT RIC MOLLA-GOMM. ANTIVIB. CORTA	
		3014152481R KIT R COR EVO IN D50 L=300 OM92R 0110382	
		0814152002R KIT LAMELLE E RIVETTI OM.92R 01 10382	
		3014008701R KIT RICAMBIO COPPA POST. MEDIA VERT CARB	
		307919801R KIT TAPPO X OMOL. EVO2 N. 32BF GPSTY	
		308287711R KIT COPPA POST.M.VERT.D.54 EV.2+LUNG	
		083710014R KIT RIC RIVESTIMENTO DX VERT MEDIO L=300	
		414205R KIT RICAMBI LANA HT 800 Plus 850g	

ART.	MARCA	MODELLO		TIPOLOGIA
14153E	SUZUKI	SV 650/ABS	2016-2018	Leovince LV ONE EVO - SLIP-ON - CARBON FIBER
	SUZUKI	SV 650 X ABS	2018-	
RICAMBI	3014149501R	KIT fascetta FM5SF Factory Medio Vertica		
	3014031204R	KIT SACCHETTO COLLETTORE N.1092		
	308078804R	KIT RIC TAPPO N.57 x SCOOTERONI		
	3014031601	SACCH. MINUT. SUZUKI SV 650 '16		
	204999R	KIT RIC BOCCOLA 45X38X30 LGR/F D.026/07		
	300049530R	KIT fascetta 49 Inox		
	303949001R	KIT RIC MOLLA-GOMM. ANTIVIB. CORTA		
	3014153481R	KIT R COR EV CAR D50 L=300 OM92R 0110382		
	0814152004R	KIT LAMELLE E RIVETTI OM.92R 01 10382 02		
	3014008701R	KIT RICAMBIO COPPA POST. MEDIA VERT CARB		
	307919801R	KIT TAPPO X OMOL. EVO2 N. 32BF GPSTY		
	308287711R	KIT COPPA POST.M.VERT.D.54 EV.2+LUNG		
	409117R	KIT RIVESTIMENTO MED CARB 100X115 L=300		
	414205R	KIT RICAMBI LANA HT 800 Plus 850g		
	206721R	KIT RIC TARGHETTA LEOVINCE CARBONIO		
14156	YAMAHA	XSR 900 ABS	2016-2018	Leovince UNDERBODY - FULL SYSTEM 3/1 - STAINLESS STEEL
RICAMBI	308078804R	KIT RIC TAPPO N.57 x SCOOTERONI		
	3014032206R	KIT SACCHETTO COLLETTORE PRIMARIO XSR900		
	204870R	KIT RICAMBIO BOCCOLA INOX DIS.094/06		
	204448R	KIT RIC FLANGIA INOX 46 D DIS.086/04		
	3014156202R	KIT SACCHET TRIFORCA FIN YAMAHA XSR 900		
	5682	KIT TAPPO SONDA LAMBDA M18 BASE + GUARN		
	3014156601R	KIT SACCH. MINUT. YAMAHA XSR 900 '16		
	303949001R	KIT RIC MOLLA-GOMM. ANTIVIB. CORTA		
	3014156471R	KIT RIC CORPO Ø150 L=205 OM.10034 10417		
	088232014R	KIT LAMELLE E RIVETTI OM.10034/42 10417		
	308232701R	KIT COPPA POST.UNDERBODY CARB		
	204790R	KIT RIC GOMMINO COPPE CARBONIO D.007/06		
	308232801R	KIT TAPPO X OMOL. EVO2 UNDER Xd.50 N. 47		
	3014156750R	KIT RIC RIVESTIMENTO UNDER CORTO L=205		
	8066	KIT RICAMBIO MATERIALE FONOASS UNDERBODY		
14159E	KTM	1050 ADVENTURE (fits with rails for original and Givi panniers)	2015-2016	Leovince LV ONE EVO - SLIP-ON - STAINLESS STEEL
	KTM	1190/R ADVENTURE (fits with rails for original and Givi panniers)	2013-2016	
	KTM	1290 SUPER ADVENTURE (fits with rails for original and Givi panniers)	2015-2016	
RICAMBI	308562501R	KIT fascetta FB5AS CARBONIO LVONE		
	3014033001R	KIT SACC CARTER CAR KTM ADV1050 1190 '16		
	3014033601R	KIT SACCH. MINUT. KTM ADV 1050 1190 '16		
	3014159481R	KIT R CO EV I R D54 BIG 0233/35 +C 10400		
	088292004R	KIT LAMELLE E RIVETTI OM.0233 0235 10400		
	3014000701R	KIT RICAMBI COPPA POST.BIG VERTICALE CAR		
	307762801R	KIT TAPPO X OMOL. EVO2 N. 32B GPSTY		
	307242711R	KIT COPPA POST.FACT.VERT. D.54 EV.2		
	088291004R	KIT RIC RIVESTIMENTO FACT.DX BIG L=370		
	414205R	KIT RICAMBI LANA HT 800 Plus 850g		
14160E	HONDA	CB 400 F	2017-	Leovince LV ONE EVO - SLIP-ON - STAINLESS STEEL
	HONDA	CBR 400 R	2017-	
	HONDA	CB 500 F (do not fit with original centre stand)	2016-2016	
	HONDA	CBR 500 R	2016-2016	
RICAMBI	3014149501R	KIT fascetta FM5SF Factory Medio Vertica		
	3014034202R	KIT SACCHETTO COLLETTORE N.1094		
	3014034601R	KIT SACCH. MINUT. HONDA CB/CBR 400/500 F		
	300045530R	KIT fascetta 45 Inox		
	303949001R	KIT RIC MOLLA-GOMM. ANTIVIB. CORTA		
	308410481R	KIT R COR EV IN D54 MED L300 0457 10410		
	088280002R	KIT KAMELLE E RIVETTI OM.0457 10410		
	3014008701R	KIT RICAMBIO COPPA POST. MEDIA VERT CARB		
	307762801R	KIT TAPPO X OMOL. EVO2 N. 32B GPSTY		
	308287711R	KIT COPPA POST.M.VERT.D.54 EV.2+LUNG		

ART.	MARCA	MODELLO	TIPOLOGIA
		083710014R 414205R	KIT RIC RIVESTIMENTO DX VERT MEDIO L=300 KIT RICAMBI LANA HT 800 Plus 850g
<b>14161E</b>	HONDA	CB 400 F	2017- Leovince LV ONE EVO - SLIP-ON - CARBON FIBER
	HONDA	CBR 400 R	2017-
	HONDA	CB 500 F (do not fit with original centre stand)	2016-2016
	HONDA	CBR 500 R	2016-2016
<b>RICAMBI</b>		3014149501R 3014034202R 3014034601R 300045530R 303949001R 308411481R 088280002R 3014008701R 307762801R 308287711R 409117R 414205R 206721R	KIT fascetta FM5SF Factory Medio Vertica KIT SACCHETTO COLLETTORE N.1094 KIT SACCH. MINUT. HONDA CB/CBR 400/500 F KIT fascetta 45 Inox KIT RIC MOLLA-GOMM. ANTIVIB. CORTA KIT R COR EV CAR D54 MED L300 0457 10410 KIT KAMELLE E RIVETTI OM.0457 10410 KIT RICAMBIO COPPA POST. MEDIA VERT CARB KIT TAPPO X OMOL. EVO2 N. 32B GPSTY KIT COPPA POST.M.VERT.D.54 EV.2+LUNG KIT RIVESTIMENTO MED CARB 100X115 L=300 KIT RICAMBI LANA HT 800 Plus 850g KIT RIC TARGHETTA LEOVINCE CARBONIO
<b>14162S</b>	YAMAHA	MT-10/FZ-10/MTN1000	2016-2018 Leovince FACTORY S - SLIP-ON - STAINLESS STEEL
	YAMAHA	MT-10 SP	2017-2018
	YAMAHA	FZ-10 (US model only)	2017-2018
<b>RICAMBI</b>		308444501R 3014162202R 3014162001R 3014162681R 0814162002R 300057532R 308574001R 308421481R 088421026R 308420701R 308421801R 308421741R 088421046R 416797R	KIT fascetta FR3 CARBONIO PICCOLA KIT SACCHETTO COLLETTORE N.1095 KIT SACC CARTER CARB YAMAHA MT-10 '16 KIT SACCH. MINUT. YAMAHA MT-10 '16 KIT STAFFA CARBONIO YAMAHA MT-10 '16 KIT Fascetta 57 Inox + 2 Ganci Molla KIT RIC MOLLA TRAZ SUPER CORTA + TUBETTO KIT R CO DX IN C D54 L=270 10057/8 10395 KIT LAMELLE E RIVETTI OM.10057-58 10395 KIT RICAMBIO COPPA POST. DX FACT CARB KIT TAPPO X OMOL. EVO2 N. 52 FACTORY -R KIT COPPA POST.DX VERT. FACTORY-R Ø50 KIT RIC RIVESTIMENTO FACTORY INOX L=270 KIT RICAMBIO LANA FACTORY L=270
<b>14163S</b>	YAMAHA	MT-10/FZ-10/MTN1000	2016-2018 Leovince FACTORY S - SLIP-ON - CARBON FIBER
	YAMAHA	MT-10 SP	2017-2018
	YAMAHA	FZ-10 (US model only)	2017-2018
<b>RICAMBI</b>		308444501R 3014162202R 3014162001R 3014162681R 0814162002R 300057532R 308574001R 308420481R 088421026R 308420701R 308421801R 308421741R 088420002R 416797R 206721R	KIT fascetta FR3 CARBONIO PICCOLA KIT SACCHETTO COLLETTORE N.1095 KIT SACC CARTER CARB YAMAHA MT-10 '16 KIT SACCH. MINUT. YAMAHA MT-10 '16 KIT STAFFA CARBONIO YAMAHA MT-10 '16 KIT Fascetta 57 Inox + 2 Ganci Molla KIT RIC MOLLA TRAZ SUPER CORTA + TUBETTO KIT R CO DX CAR D54 L=270 10057/8 10395 KIT LAMELLE E RIVETTI OM.10057-58 10395 KIT RICAMBIO COPPA POST. DX FACT CARB KIT TAPPO X OMOL. EVO2 N. 52 FACTORY -R KIT COPPA POST.DX VERT. FACTORY-R Ø50 KIT RIC RIVESTIMENTO FACT 270mm CARB KIT RICAMBIO LANA FACTORY L=270 KIT RIC TARGHETTA LEOVINCE CARBONIO
<b>14164E</b>	KTM	DUKE 390	2013-2016 Leovince LV ONE EVO - SLIP-ON - STAINLESS STEEL
<b>RICAMBI</b>		3014149501R 3014037204R 3014037501R 3014037601R 300043530R	KIT fascetta FM5SF Factory Medio Vertica KIT SACCHETTO COLLETTORE N.1126 KIT SACCHETTO STAFFA IN KTM 390 DUKE '16 KIT SACCHETTO MINUTERIA KTM 390 DUKE '16 KIT fascetta 43 Inox

ART.	MARCA	MODELLO	TIPOLOGIA
		303949001R KIT RIC MOLLA-GOMM. ANTIVIB. CORTA 308740481R KIT R COR EVO IN D50 L=300 OM0430-10382 0814170020R KIT LAMELLE E RIVETTI OM.0429 0430 10382 3014008701R KIT RICAMBIO COPPA POST. MEDIA VERT CARB 307919801R KIT TAPPO X OMOL. EVO2 N. 32BF GPSTY 308287711R KIT COPPA POST.M.VERT.D.54 EV.2+LUNG 083710014R KIT RIC RIVESTIMENTO DX VERT MEDIO L=300 414205R KIT RICAMBI LANA HT 800 Plus 850g	
<b>14165E</b>	KTM	DUKE 390	2013-2016 Leovince LV ONE EVO - SLIP-ON - CARBON FIBER
RICAMBI	3014149501R 3014037204R 3014037501R 3014037601R 300043530R 303949001R 308741481R 0814170022R 3014008701R 307919801R 308287711R 409117R 414205R 206721R	KIT fascetta FM5SF Factory Medio Vertica KIT SACCHETTO COLLETTORE N.1126 KIT SACCHETTO STAFFA IN KTM 390 DUKE '16 KIT SACCHETTO MINUTERIA KTM 390 DUKE '16 KIT fascetta 43 Inox KIT RIC MOLLA-GOMM. ANTIVIB. CORTA KIT R COR EV CAR D50 L=300 OM0430-10382 KIT LAMELLE E RIVETTI OM.0237 0430 10382 KIT RICAMBIO COPPA POST. MEDIA VERT CARB KIT TAPPO X OMOL. EVO2 N. 32BF GPSTY KIT COPPA POST.M.VERT.D.54 EV.2+LUNG KIT RIVESTIMENTO MED CARB 100X115 L=300 KIT RICAMBI LANA HT 800 Plus 850g KIT RIC TARGHETTA LEOVINCE CARBONIO	
<b>14166B</b>	KTM	DUKE 390	2013-2016 Leovince GP STYLE BLACK - SLIP-ON - STAINLESS STEEL
RICAMBI	3014037204R 3014037501R 3014166601R 300043530R 303949001R 308124475R 305432801R	KIT SACCHETTO COLLETTORE N.1126 KIT SACCHETTO STAFFA IN KTM 390 DUKE '16 KIT SACCHETTO MINUTERIA KTM 390 DUKE '16 KIT fascetta 43 Inox KIT RIC MOLLA-GOMM. ANTIVIB. CORTA KIT RIC CORPO DX Ø150 L=295 IN OM0473 BL KIT TAPPO X OMOL. EVO2 N. 32C GPSTY	
<b>14166</b>	KTM	DUKE 390	2013-2016 Leovince GP STYLE - SLIP-ON - STAINLESS STEEL
RICAMBI	3014037204R 3014037501R 3014166601R 300043530R 303949001R 308124471R 305432801R	KIT SACCHETTO COLLETTORE N.1126 KIT SACCHETTO STAFFA IN KTM 390 DUKE '16 KIT SACCHETTO MINUTERIA KTM 390 DUKE '16 KIT fascetta 43 Inox KIT RIC MOLLA-GOMM. ANTIVIB. CORTA KIT RIC CORPO DX Ø150 L=295 INOX OM.0473 KIT TAPPO X OMOL. EVO2 N. 32C GPSTY	
<b>14167E</b>	KTM	RC 125	2014-2016 Leovince LV ONE EVO - SLIP-ON - STAINLESS STEEL
RICAMBI	3014149501R 3014167202R 3014167501R 3014167601R 303949001R 300041530R 308406481R 088282002R 3014008701R 204790R 307762801R 308287711R 088406004R 414205R	KIT fascetta FM5SF Factory Medio Vertica KIT SACCHETTO COLLETTORE N.1101 KIT SACCHETTO STAFFA ALL VN KTM RC125 KIT SACCHETTO MINUTERIA KTM RC 125 '15 KIT RIC MOLLA-GOMM. ANTIVIB. CORTA KIT fascetta 41 Inox KIT R COR EVO IN D50 MED L=270 OM.0430 KIT LAMELLE E RIVETTI OM.0429 0430 KIT RICAMBIO COPPA POST. MEDIA VERT CARB KIT RIC GOMMINO COPPE CARBONIO D.007/06 KIT TAPPO X OMOL. EVO2 N. 32B GPSTY KIT COPPA POST.M.VERT.D.54 EV.2+LUNG KIT RIC RIVESTIMENTO FACT.DX MEDIO L=270 KIT RICAMBI LANA HT 800 Plus 850g	
<b>14168E</b>	KTM	RC 125	2014-2016 Leovince LV ONE EVO - SLIP-ON - CARBON FIBER
RICAMBI	3014149501R 3014167202R 3014167501R	KIT fascetta FM5SF Factory Medio Vertica KIT SACCHETTO COLLETTORE N.1101 KIT SACCHETTO STAFFA ALL VN KTM RC125	

ART.	MARCA	MODELLO		TIPOLOGIA
		3014167601R KIT SACCHETTO MINUTERIA KTM RC 125 '15 303949001R KIT RIC MOLLA-GOMM. ANTIVIB. CORTA 300041530R KIT fascetta 41 Inox 308407481R KIT R COR EV CAR D50 MED L=270 OM.0430 085096022R KIT LAMELLE E RIVETTI OM.430 014 3014008701R KIT RICAMBIO COPPA POST. MEDIA VERT CARB 204790R KIT RIC GOMMINO COPPE CARBONIO D.007/06 307762801R KIT TAPPO X OMOL. EVO2 N. 32B GPSTY 308287711R KIT COPPA POST.M.VERT.D.54 EV.2+LUNG 088407002R KIT RIC RIVESTIMENTO FACTORY MEDIO L=270 206721R KIT RIC TARGHETTA LEOVINCE CARBONIO 414205R KIT RICAMBI LANA HT 800 Plus 850g		
<b>14169B</b>	KTM	RC 125	2014-2016	Leovince GP STYLE BLACK - SLIP-ON - STAINLESS STEEL
RICAMBI		3014167202R KIT SACCHETTO COLLETTORE N.1101 3014169501R KIT SACCHETTO STAFFA ALL VN KTM RC 125 3014169601R KIT SACCHETTO MINUTERIA KTM RC 125 '15 300041530R KIT fascetta 41 Inox 303949001R KIT RIC MOLLA-GOMM. ANTIVIB. CORTA 308124475R KIT RIC CORPO DX Ø150 L=295 IN OM0473 BL 305432801R KIT TAPPO X OMOL. EVO2 N. 32C GPSTY		
<b>14169</b>	KTM	RC 125	2014-2016	Leovince GP STYLE - SLIP-ON - STAINLESS STEEL
RICAMBI		3014167202R KIT SACCHETTO COLLETTORE N.1101 3014169501R KIT SACCHETTO STAFFA ALL VN KTM RC 125 3014169601R KIT SACCHETTO MINUTERIA KTM RC 125 '15 300041530R KIT fascetta 41 Inox 303949001R KIT RIC MOLLA-GOMM. ANTIVIB. CORTA 308124471R KIT RIC CORPO DX Ø150 L=295 INOX OM.0473 305432801R KIT TAPPO X OMOL. EVO2 N. 32C GPSTY		
<b>14170K</b>	KAWASAKI	NINJA 650	2017-2018	Leovince UNDERBODY - FULL SYSTEM 2/1 - STAINLESS STEEL
	KAWASAKI	Z 650	2017-2018	
RICAMBI		308579204R KIT RICAMBI COLLETTORI PRIMARI ER-6N-F 206060R KIT RIC BOCCOLA INOX 41X33X25.5 D.031/12 206061R KIT RIC FLANGIA INOX 158 A DIS.032/12 3014170204R KIT SACCHETTO COLL SECOND KA NJ Z650 APP 5683 KIT TAPPO SONDA LAMBDA M12 RACING + GUA 3014170601R KIT SACCHETTO MINUT KAWA Z650 NJ 650 303949001R KIT RIC MOLLA-GOMM. ANTIVIB. CORTA 3014170471R KIT RIC CORPO INOX D50 L=205 10034 10417 088232014R KIT LAMELLE E RIVETTI OM.10034/42 10417 308232701R KIT COPPA POST.UNDERBODY CARB 204790R KIT RIC GOMMINO COPPE CARBONIO D.007/06 308232801R KIT TAPPO X OMOL. EVO2 UNDER Xd.50 N. 47 3014170750R KIT RIC RIVESTIMENTO UNDER CORTO L=205 8066 KIT RICAMBIO MATERIALE FONOASS UNDERBODY		
<b>14170</b>	KAWASAKI	NINJA 650	2017-2018	Leovince UNDERBODY - FULL SYSTEM 2/1 - STAINLESS STEEL
	KAWASAKI	Z 650	2017-2018	
RICAMBI		308579204R KIT RICAMBI COLLETTORI PRIMARI ER-6N-F 206060R KIT RIC BOCCOLA INOX 41X33X25.5 D.031/12 206061R KIT RIC FLANGIA INOX 158 A DIS.032/12 3014170202R KIT SACCHETTO COLLETT SECOND KA NJ Z650 5683 KIT TAPPO SONDA LAMBDA M12 RACING + GUA 3014170601R KIT SACCHETTO MINUT KAWA Z650 NJ 650 303949001R KIT RIC MOLLA-GOMM. ANTIVIB. CORTA 3014170471R KIT RIC CORPO INOX D50 L=205 10034 10417 088232014R KIT LAMELLE E RIVETTI OM.10034/42 10417 308232701R KIT COPPA POST.UNDERBODY CARB 204790R KIT RIC GOMMINO COPPE CARBONIO D.007/06 308232801R KIT TAPPO X OMOL. EVO2 UNDER Xd.50 N. 47		

ART.	MARCA	MODELLO	TIPOLOGIA
		3014170750R 8066	KIT RIC RIVESTIMENTO UNDER CORTO L=205 KIT RICAMBIO MATERIALE FONOASS UNDERBODY
<b>14171E</b>	KAWASAKI	Z 900 (also fit 35Kw & 70Kw versions)	2017-2018 Leovince LV PRO - SLIP-ON - STAINLESS STEEL
RICAMBI		306958505R 3014171202R 3014171561R 3014171601R 300053530R 303949001R 3014124481 088442008R 308494701R 308437801R 3014124741R 0814124004R 414205R	KIT FASCETTA FM1S CARB. FACT. MED KIT SACCHETTO COLLETTORE N.1114 KIT SACCHET STAFFA ALL VN KAWA Z900 '17 KIT SACCHET MINUTERIA KAWASAKI Z900 '17 KIT fascetta 53 Inox KIT RIC MOLLA-GOMM. ANTIVIB. CORTA CORPO PRO DX I Ø50 COR L=180 10074 10393 KIT LAMELLE E RIVETTI O. 10074-10393 KIT RIC COPPA CAR.VERT.FACT.SOTTOSELLA KIT TAPPO dB-KILLER N. 52B FACTORY R KIT COPPA POST VERTICALE Ø50 SOTTOSELLA KIT RIC RIVESTIMENTO DX MEDIO L180 NO BA KIT RICAMBI LANA HT 800 Plus 850g
<b>14172E</b>	KAWASAKI	Z 900 (also fit 35Kw & 70Kw versions)	2017-2018 Leovince LV PRO - SLIP-ON - CARBON FIBER
RICAMBI		306958505R 3014171202R 3014171561R 3014171601R 300053530R 303949001R 3014124482R 088442010R 308494701R 308437801R 3014124741R 088442006R 414205R 206733R	KIT FASCETTA FM1S CARB. FACT. MED KIT SACCHETTO COLLETTORE N.1114 KIT SACCHET STAFFA ALL VN KAWA Z900 '17 KIT SACCHET MINUTERIA KAWASAKI Z900 '17 KIT fascetta 53 Inox KIT RIC MOLLA-GOMM. ANTIVIB. CORTA KIT R C PRO DX C50 COR L=180 10074 10393 KIT LAMELLE E RIVETTI O. 10074-10393 KIT RIC COPPA CAR.VERT.FACT.SOTTOSELLA KIT TAPPO dB-KILLER N. 52B FACTORY R KIT COPPA POST VERTICALE Ø50 SOTTOSELLA KIT RIC RIVESTIMENTO MEDIO CARB L=180mm KIT RICAMBI LANA HT 800 Plus 850g KIT RIC TARGHETTA LEOVINCE CARB LV PRO
<b>14173S</b>	KAWASAKI	Z 900 (also fit 35Kw & 70Kw versions)	2017-2018 Leovince FACTORY S - SLIP-ON - STAINLESS STEEL
RICAMBI		308448501R 3014173202R 3014039561R 3014173601R 300053530R 303949001R 308437481R 088421022R 308420701R 308437801R 308437741R 088421046R 416797R	KIT fascetta FR2 CARBONIO MEDIA KIT SACCHETTO COLLETTORE N.1113 KIT SACCHET STAFFA ALL VN KAWA Z900 '17 KIT SACCHET MINUTERIA KAWASAKI Z900 '17 KIT fascetta 53 Inox KIT RIC MOLLA-GOMM. ANTIVIB. CORTA KIT R CO DX CAR CO D50 270 10057/8 10401 KIT LAMELLE E RIVETTI OM.10057-58 10401 KIT RICAMBIO COPPA POST. DX FACT CARB KIT TAPPO dB-KILLER N. 52B FACTORY R KIT COPPA POST.DX VERT. FACTORY-R Ø50 KIT RIC RIVESTIMENTO FACTORY INOX L=270 KIT RICAMBIO LANA FACTORY L=270
<b>14174S</b>	KAWASAKI	Z 900 (also fit 35Kw & 70Kw versions)	2017-2018 Leovince FACTORY S - SLIP-ON - CARBON FIBER
RICAMBI		308448501R 3014173202R 3014039561R 3014173601R 300053530R 303949001R 308436481R 088421022R 308420701R 308437801R 308437741R 088420002R 416797R 206721R	KIT fascetta FR2 CARBONIO MEDIA KIT SACCHETTO COLLETTORE N.1113 KIT SACCHET STAFFA ALL VN KAWA Z900 '17 KIT SACCHET MINUTERIA KAWASAKI Z900 '17 KIT fascetta 53 Inox KIT RIC MOLLA-GOMM. ANTIVIB. CORTA KIT R CORPO DX C Ø50 L270 O10057/8 10401 KIT LAMELLE E RIVETTI OM.10057-58 10401 KIT RICAMBIO COPPA POST. DX FACT CARB KIT TAPPO dB-KILLER N. 52B FACTORY R KIT COPPA POST.DX VERT. FACTORY-R Ø50 KIT RIC RIVESTIMENTO FACT 270mm CARB KIT RICAMBIO LANA FACTORY L=270 KIT RIC TARGHETTA LEOVINCE CARBONIO

ART.	MARCA	MODELLO		TIPOLOGIA
14175E	SUZUKI	GSX-S 750/Z ABS	2017-2018	Leovince LV ONE EVO - SLIP-ON - STAINLESS STEEL
RICAMBI	306958505R	KIT FASCETTA FM1S CARB. FACT. MED		
	308544202R	KIT SACCHETTO COLLETTORE N.907		
	300045530R	KIT fascetta 45 Inox		
	3014040601R	KIT SACCHET MINUTERIA SUZUKI GSX-S 750		
	303949001R	KIT RIC MOLLA-GOMM. ANTIVIB. CORTA		
	308402481R	KIT R COR EV I D50 ME L300 0429/30 10394		
	088282004R	KIT LAMELLE E RIVETTI OM.0430 0457 10394		
	3014008701R	KIT RICAMBIO COPPA POST. MEDIA VERT CARB		
	307762801R	KIT TAPPO X OMOL. EVO2 N. 32B GPSTY		
	308287711R	KIT COPPA POST.M.VERT.D.54 EV.2+LUNG		
	083710014R	KIT RIC RIVESTIMENTO DX VERT MEDIO L=300		
	414205R	KIT RICAMBI LANA HT 800 Plus 850g		
14176E	SUZUKI	GSX-S 750/Z ABS	2017-2018	Leovince LV ONE EVO - SLIP-ON - CARBON FIBER
RICAMBI	306958505R	KIT FASCETTA FM1S CARB. FACT. MED		
	308544202R	KIT SACCHETTO COLLETTORE N.907		
	300045530R	KIT fascetta 45 Inox		
	3014040601R	KIT SACCHET MINUTERIA SUZUKI GSX-S 750		
	303949001R	KIT RIC MOLLA-GOMM. ANTIVIB. CORTA		
	308403481R	KIT R COR EV CA D50 M L300 0429/30 10394		
	085096024R	KIT LAMELLE E RIVETTI 0429 0430 10394		
	3014008701R	KIT RICAMBIO COPPA POST. MEDIA VERT CARB		
	307762801R	KIT TAPPO X OMOL. EVO2 N. 32B GPSTY		
	308287711R	KIT COPPA POST.M.VERT.D.54 EV.2+LUNG		
	409117R	KIT RIVESTIMENTO MED CARB 100X115 L=300		
	414205R	KIT RICAMBI LANA HT 800 Plus 850g		
	206721R	KIT RIC TARGHETTA LEOVINCE CARBONIO		
14177S	SUZUKI	GSX-S 750/Z ABS	2017-2018	Leovince FACTORY S - SLIP-ON - STAINLESS STEEL
RICAMBI	308448501R	KIT fascetta FR2 CARBONIO MEDIA		
	308545202R	KIT SACCHETTO COLLETTORE N.906		
	300045530R	KIT fascetta 45 Inox		
	3014177601R	KIT SACCHET MINUTERIA SUZUKI GSX-S 750		
	303949001R	KIT RIC MOLLA-GOMM. ANTIVIB. CORTA		
	308437481R	KIT R CO DX CAR CO D50 270 10057/8 10401		
	088421022R	KIT LAMELLE E RIVETTI OM.10057-58 10401		
	308420701R	KIT RICAMBIO COPPA POST. DX FACT CARB		
	308437801R	KIT TAPPO dB-KILLER N. 52B FACTORY R		
	308437741R	KIT COPPA POST.DX VERT. FACTORY-R Ø50		
	088421046R	KIT RIC RIVESTIMENTO FACTORY INOX L=270		
	416797R	KIT RICAMBIO LANA FACTORY L=270		
14178S	SUZUKI	GSX-S 750/Z ABS	2017-2018	Leovince FACTORY S - SLIP-ON - CARBON FIBER
RICAMBI	308448501R	KIT fascetta FR2 CARBONIO MEDIA		
	308545202R	KIT SACCHETTO COLLETTORE N.906		
	300045530R	KIT fascetta 45 Inox		
	3014177601R	KIT SACCHET MINUTERIA SUZUKI GSX-S 750		
	303949001R	KIT RIC MOLLA-GOMM. ANTIVIB. CORTA		
	308436481R	KIT R CORPO DX C Ø50 L270 O10057/8 10401		
	088421022R	KIT LAMELLE E RIVETTI OM.10057-58 10401		
	308420701R	KIT RICAMBIO COPPA POST. DX FACT CARB		
	308437801R	KIT TAPPO dB-KILLER N. 52B FACTORY R		
	308437741R	KIT COPPA POST.DX VERT. FACTORY-R Ø50		
	088420002R	KIT RIC RIVESTIMENTO FACT 270mm CARB		
	416797R	KIT RICAMBIO LANA FACTORY L=270		
	206721R	KIT RIC TARGHETTA LEOVINCE CARBONIO		
14181EK	KAWASAKI	NINJA 650	2017-2018	Leovince LV ONE EVO - FULL SYSTEM 2/1 - STAINLESS STEEL
	KAWASAKI	Z 650	2017-2018	
RICAMBI	306958505R	KIT FASCETTA FM1S CARB. FACT. MED		
	308579204R	KIT RICAMBI COLLETTORI PRIMARI ER-6N-F		
	206060R	KIT RIC BOCCOLA INOX 41X33X25.5 D.031/12		

ART.	MARCA	MODELLO	TIPOLOGIA
		206061R KIT RIC FLANGIA INOX 158 A DIS.032/12 3014181204R KIT SACCHETTO COLL SECOND KA NJ Z650 APP 5683 KIT TAPPO Sonda LAMBDA M12 RACING + GUA 3014181561R KIT SACCHET STAFFA INOX VN KA Z650 NJ650 3014181601R KIT SACCHETTO MINUT KAWA Z650 NJ 650 303949001R KIT RIC MOLLA-GOMM. ANTIVIB. CORTA 308574001R KIT RIC MOLLA TRAZ SUPER CORTA + TUBETTO 308740481R KIT R COR EVO IN D50 L=300 OM0430-10382 0814170020R KIT LAMELLE E RIVETTI OM.0429 0430 10382 3014008701R KIT RICAMBIO COPPA POST. MEDIA VERT CARB 307919801R KIT TAPPO X OMOL. EVO2 N. 32BF GPSTY 308287711R KIT COPPA POST.M.VERT.D.54 EV.2+LUNG 083710014R KIT RIC RIVESTIMENTO DX VERT MEDIO L=300 414205R KIT RICAMBI LANA HT 800 Plus 850g	
<b>14181E</b>	KAWASAKI	NINJA 650	2017-2018 Leovince LV ONE EVO - FULL SYSTEM 2/1 - STAINLESS STEEL
	KAWASAKI	Z 650	2017-2018
<b>RICAMBI</b>		306958505R KIT FASCETTA FM1S CARB. FACT. MED 308579204R KIT RICAMBI COLLETTORI PRIMARI ER-6N-F 206060R KIT RIC BOCCOLA INOX 41X33X25.5 D.031/12 206061R KIT RIC FLANGIA INOX 158 A DIS.032/12 3014181202R KIT SACCHETTO COLLETT SECOND KA NJ Z650 5683 KIT TAPPO Sonda LAMBDA M12 RACING + GUA 3014181561R KIT SACCHET STAFFA INOX VN KA Z650 NJ650 3014181601R KIT SACCHETTO MINUT KAWA Z650 NJ 650 303949001R KIT RIC MOLLA-GOMM. ANTIVIB. CORTA 308574001R KIT RIC MOLLA TRAZ SUPER CORTA + TUBETTO 308740481R KIT R COR EVO IN D50 L=300 OM0430-10382 0814170020R KIT LAMELLE E RIVETTI OM.0429 0430 10382 3014008701R KIT RICAMBIO COPPA POST. MEDIA VERT CARB 307919801R KIT TAPPO X OMOL. EVO2 N. 32BF GPSTY 308287711R KIT COPPA POST.M.VERT.D.54 EV.2+LUNG 083710014R KIT RIC RIVESTIMENTO DX VERT MEDIO L=300 414205R KIT RICAMBI LANA HT 800 Plus 850g	
<b>14182EK</b>	KAWASAKI	NINJA 650	2017-2018 Leovince LV ONE EVO - FULL SYSTEM 2/1 - CARBON FIBER
	KAWASAKI	Z 650	2017-2018
<b>RICAMBI</b>		306958505R KIT FASCETTA FM1S CARB. FACT. MED 308579204R KIT RICAMBI COLLETTORI PRIMARI ER-6N-F 206060R KIT RIC BOCCOLA INOX 41X33X25.5 D.031/12 206061R KIT RIC FLANGIA INOX 158 A DIS.032/12 3014181204R KIT SACCHETTO COLL SECOND KA NJ Z650 APP 5683 KIT TAPPO Sonda LAMBDA M12 RACING + GUA 3014181561R KIT SACCHET STAFFA INOX VN KA Z650 NJ650 3014181601R KIT SACCHETTO MINUT KAWA Z650 NJ 650 303949001R KIT RIC MOLLA-GOMM. ANTIVIB. CORTA 308574001R KIT RIC MOLLA TRAZ SUPER CORTA + TUBETTO 308741481R KIT R COR EV CAR D50 L=300 OM0430-10382 0814170022R KIT LAMELLE E RIVETTI OM.0237 0430 10382 3014008701R KIT RICAMBIO COPPA POST. MEDIA VERT CARB 307919801R KIT TAPPO X OMOL. EVO2 N. 32BF GPSTY 308287711R KIT COPPA POST.M.VERT.D.54 EV.2+LUNG 409117R KIT RIVESTIMENTO MED CARB 100X115 L=300 414205R KIT RICAMBI LANA HT 800 Plus 850g 206721R KIT RIC TARGHETTA LEOVINCE CARBONIO	
<b>14182E</b>	KAWASAKI	NINJA 650	2017-2018 Leovince LV ONE EVO - FULL SYSTEM 2/1 - CARBON FIBER
	KAWASAKI	Z 650	2017-2018
<b>RICAMBI</b>		306958505R KIT FASCETTA FM1S CARB. FACT. MED 308579204R KIT RICAMBI COLLETTORI PRIMARI ER-6N-F 206060R KIT RIC BOCCOLA INOX 41X33X25.5 D.031/12 206061R KIT RIC FLANGIA INOX 158 A DIS.032/12 3014181202R KIT SACCHETTO COLLETT SECOND KA NJ Z650	



ART.	MARCA	MODELLO	TIPOLOGIA
	5683	KIT TAPPO SONDA LAMBDA M12 RACING + GUA	
	3014181561R	KIT SACCHET STAFFA INOX VN KA Z650 NJ650	
	3014181601R	KIT SACCHETTO MINUT KAWA Z650 NJ 650	
	303949001R	KIT RIC MOLLA-GOMM. ANTIVIB. CORTA	
	308574001R	KIT RIC MOLLA TRAZ SUPER CORTA + TUBETTO	
	308741481R	KIT R COR EV CAR D50 L=300 OM0430-10382	
	0814170022R	KIT LAMELLE E RIVETTI OM.0237 0430 10382	
	3014008701R	KIT RICAMBIO COPPA POST. MEDIA VERT CARB	
	307919801R	KIT TAPPO X OMOL. EVO2 N. 32BF GPSTY	
	308287711R	KIT COPPA POST.M.VERT.D.54 EV.2+LUNG	
	409117R	KIT RIVESTIMENTO MED CARB 100X115 L=300	
	414205R	KIT RICAMBI LANA HT 800 Plus 850g	
	206721R	KIT RIC TARGHETTA LEOVINCE CARBONIO	
<b>14183E</b>	KTM	DUKE 125	2017-2018 Leovince LV PRO - SLIP-ON - STAINLESS STEEL
	KTM	RC 125	2017-2018
	KTM	DUKE 390	2017-2018
	KTM	RC 390	2017-2018
RICAMBI	306958505R	KIT FASCETTA FM1S CARB. FACT. MED	
	3014183202R	KIT SACCHETTO COLLETTORE N.1124	
	3014183601R	KIT SACCHETTO MINUT KTM RC DUKE 125/390	
	303949001R	KIT RIC MOLLA-GOMM. ANTIVIB. CORTA	
	3014124481R	KIT R C PRO DX I50 COR L=180 10074 10393	
	088442008R	KIT LAMELLE E RIVETTI O. 10074-10393	
	308494701R	KIT RIC COPPA CAR.VERT.FACT.SOTTOSELLA	
	308437801R	KIT TAPPO dB-KILLER N. 52B FACTORY R	
	3014124741R	KIT COPPA POST VERTICALE Ø50 SOTTOSELLA	
	0814124004R	KIT RIC RIVESTIMENTO DX MEDIO L180 NO BA	
	414205R	KIT RICAMBI LANA HT 800 Plus 850g	
<b>14184E</b>	KTM	DUKE 125	2017-2018 Leovince LV PRO - SLIP-ON - CARBON FIBER
	KTM	RC 125	2017-2018
	KTM	DUKE 390	2017-2018
	KTM	RC 390	2017-2018
RICAMBI	306958505R	KIT FASCETTA FM1S CARB. FACT. MED	
	3014183202R	KIT SACCHETTO COLLETTORE N.1124	
	3014183601R	KIT SACCHETTO MINUT KTM RC DUKE 125/390	
	303949001R	KIT RIC MOLLA-GOMM. ANTIVIB. CORTA	
	3014124482R	KIT R C PRO DX C50 COR L=180 10074 10393	
	088442010R	KIT LAMELLE E RIVETTI O. 10074-10393	
	308494701R	KIT RIC COPPA CAR.VERT.FACT.SOTTOSELLA	
	308437801R	KIT TAPPO dB-KILLER N. 52B FACTORY R	
	3014124741R	KIT COPPA POST VERTICALE Ø50 SOTTOSELLA	
	088442006R	KIT RIC RIVESTIMENTO MEDIO CARB L=180mm	
	414205R	KIT RICAMBI LANA HT 800 Plus 850g	
	206733R	KIT RIC TARGHETTA LEOVINCE CARB LV PRO	
<b>14185E</b>	KTM	DUKE 125	2017-2018 Leovince LV ONE EVO - SLIP-ON - STAINLESS STEEL
	KTM	RC 125	2017-2018
	KTM	DUKE 390	2017-2018
	KTM	RC 390	2017-2018
RICAMBI	306958505R	KIT FASCETTA FM1S CARB. FACT. MED	
	3014183202R	KIT SACCHETTO COLLETTORE N.1124	
	3014183601R	KIT SACCHETTO MINUT KTM RC DUKE 125/390	
	303949001R	KIT RIC MOLLA-GOMM. ANTIVIB. CORTA	
	308402481R	KIT R COR EV I D50 ME L300 0429/30 10394	
	088282004R	KIT LAMELLE E RIVETTI OM.0430 0457 10394	
	3014008701R	KIT RICAMBIO COPPA POST. MEDIA VERT CARB	
	307762801R	KIT TAPPO X OMOL. EVO2 N. 32B GPSTY	
	308287711R	KIT COPPA POST.M.VERT.D.54 EV.2+LUNG	
	083710014R	KIT RIC RIVESTIMENTO DX VERT MEDIO L=300	
	414205R	KIT RICAMBI LANA HT 800 Plus 850g	
<b>14186E</b>	KTM	DUKE 125	2017-2018 Leovince LV ONE EVO - SLIP-ON - CARBON FIBER
	KTM	RC 125	2017-2018

ART.	MARCA	MODELLO	TIPOLOGIA
	KTM	DUKE 390	2017-2018
	KTM	RC 390	2017-2018
<b>RICAMBI</b>	306958505R	KIT FASCETTA FM1S CARB. FACT. MED	
	3014183202R	KIT SACCHETTO COLLETTORE N.1124	
	3014183601R	KIT SACCHETTO MINUT KTM RC DUKE 125/390	
	303949001R	KIT RIC MOLLA-GOMM. ANTIVIB. CORTA	
	308403481R	KIT R COR EV CA D50 M L300 0429/30 10394	
	088282004R	KIT LAMELLE E RIVETTI OM.0430 0457 10394	
	3014008701R	KIT RICAMBIO COPPA POST. MEDIA VERT CARB	
	307762801R	KIT TAPPO X OMOL. EVO2 N. 32B GPSTY	
	308287711R	KIT COPPA POST.M.VERT.D.54 EV.2+LUNG	
	409117R	KIT RIVESTIMENTO MED CARB 100X115 L=300	
	414205R	KIT RICAMBI LANA HT 800 Plus 850g	
	206721R	KIT RIC TARGHETTA LEOVINCE CARBONIO	
<b>14187EK</b>	YAMAHA	TMAX 530 ABS/DX/SX	2017-2018 Leovince LV ONE EVO - FULL SYSTEM 2/1 - STAINLESS STEEL
<b>RICAMBI</b>	308562501R	KIT fascetta FB5AS CARBONIO LVONE	
	3014043001R	KIT SACCHET CARTER CARB YAMAHA T-MAX 530	
	3014043202R	KIT SACCHETTO COLLETTORE PRIM N.1127	
	3014043206R	KIT SACCHETTO COLLETTORE N.1129	
	5683	KIT TAPPO Sonda LAMBDA M12 RACING + GUA	
	3014043601R	KIT SACCHET MINUTERIA YAMAHA T-MAX 530	
	303949001R	KIT RIC MOLLA-GOMM. ANTIVIB. CORTA	
	308424481R	KIT R COR EV IN RETE D50 BIG 0230 10399	
	088425010R	KIT LAMELLE E RIVETTI OM.0230 10399	
	3014000701R	KIT RICAMBI COPPA POST.BIG VERTICALE CAR	
	307762801R	KIT TAPPO X OMOL. EVO2 N. 32B GPSTY	
	307242711R	KIT COPPA POST.FACT.VERT. D.54 EV.2	
	088291004R	KIT RIC RIVESTIMENTO FACT.DX BIG L=370	
	414205R	KIT RICAMBI LANA HT 800 Plus 850g	
<b>14187E</b>	YAMAHA	TMAX 530 ABS/DX/SX	2017-2018 Leovince LV ONE EVO - FULL SYSTEM 2/1 - STAINLESS STEEL
<b>RICAMBI</b>	308562501R	KIT fascetta FB5AS CARBONIO LVONE	
	3014043001R	KIT SACCHET CARTER CARB YAMAHA T-MAX 530	
	3014043202R	KIT SACCHETTO COLLETTORE PRIM N.1127	
	3014043204R	KIT SACCHETTO COLLETTORE N.1128	
	5683	KIT TAPPO Sonda LAMBDA M12 RACING + GUA	
	3014043601R	KIT SACCHET MINUTERIA YAMAHA T-MAX 530	
	303949001R	KIT RIC MOLLA-GOMM. ANTIVIB. CORTA	
	308424481R	KIT R COR EV IN RETE D50 BIG 0230 10399	
	088425010R	KIT LAMELLE E RIVETTI OM.0230 10399	
	3014000701R	KIT RICAMBI COPPA POST.BIG VERTICALE CAR	
	307762801R	KIT TAPPO X OMOL. EVO2 N. 32B GPSTY	
	307242711R	KIT COPPA POST.FACT.VERT. D.54 EV.2	
	088291004R	KIT RIC RIVESTIMENTO FACT.DX BIG L=370	
	414205R	KIT RICAMBI LANA HT 800 Plus 850g	
<b>14189E</b>	HONDA	INTEGRA 750/DCT/ABS (also fits 35Kw version)	2016-2018 Leovince LV ONE EVO - SLIP-ON - STAINLESS STEEL
	HONDA	NC 750 S/X/DCT/ABS (also fits 35Kw version)	2016-2018
<b>RICAMBI</b>	303984501R	KIT fascetta 22T CAR. MED. SING. DIS	
	308701202R	KIT RICAMBIO COLLETTORE INTEGRA 700	
	300041530R	KIT fascetta 41 Inox	
	308701601R	KIT SACCH. MIN. HONDA INTEGRA 700 '12	
	303949001R	KIT RIC MOLLA-GOMM. ANTIVIB. CORTA	
	308402481R	KIT R COR EV I D50 ME L300 0429/30 10394	
	088282004R	KIT LAMELLE E RIVETTI OM.0430 0457 10394	
	3014008701R	KIT RICAMBIO COPPA POST. MEDIA VERT CARB	
	307762801R	KIT TAPPO X OMOL. EVO2 N. 32B GPSTY	
	308287711R	KIT COPPA POST.M.VERT.D.54 EV.2+LUNG	
	083710014R	KIT RIC RIVESTIMENTO DX VERT MEDIO L=300	
	414205R	KIT RICAMBI LANA HT 800 Plus 850g	

ART.	MARCA	MODELLO		TIPOLOGIA
14190E	HONDA	INTEGRA 750/DCT/ABS (also fits 35Kw version)	2016-2018	Leovince LV ONE EVO - SLIP-ON - CARBON FIBER
	HONDA	NC 750 S/X/DCT/ABS (also fits 35Kw version)	2016-2018	
RICAMBI	303984501R	KIT fascetta 22T CAR. MED. SING. DIS		
	308701202R	KIT RICAMBIO COLLETTORE INTEGRA 700		
	300041530R	KIT fascetta 41 Inox		
	308701601R	KIT SACCH.MIN. HONDA INTEGRA 700 '12		
	303949001R	KIT RIC MOLLA-GOMM. ANTIVIB. CORTA		
	308403481R	KIT R COR EV CA D50 M L300 0429/30 10394		
	085096024R	KIT LAMELLE E RIVETTI 0429 0430 10394		
	3014008701R	KIT RICAMBIO COPPA POST. MEDIA VERT CARB		
	307762801R	KIT TAPPO X OMOL. EVO2 N. 32B GPSTY		
	308287711R	KIT COPPA POST.M.VERT.D.54 EV.2+LUNG		
	409117R	KIT RIVESTIMENTO MED CARB 100X115 L=300		
	414205R	KIT RICAMBI LANA HT 800 Plus 850g		
	206721R	KIT RIC TARGHETTA LEOVINCE CARBONIO		
14191E	HONDA	CRF 1000 L AFRICA TWIN ABS EURO 4 (fits with original panniers)	2016-2017	Leovince LV ONE EVO - SLIP-ON - STAINLESS STEEL
RICAMBI	306960505R	KIT FASCETTA FB1S CARBONIO		
	3014028204R	KIT SACCHETTO COLLETTORE N.1096		
	3014028011R	KIT SACC CARTER CAR HONDA CRF1000L AFTWN		
	3014139601R	KIT SACCH. MINUT.HONDA CRF 1000L AFRICA		
	0814139501R	KIT STAFFA CARB. HONDA CRF1000L AFR TWIN		
	300035530R	KIT fascetta 35 Inox		
	303949001R	KIT RIC MOLLA-GOMM. ANTIVIB. CORTA		
	308424481R	KIT R COR EV IN RETE D50 BIG 0230 10399		
	088425010R	KIT LAMELLE E RIVETTI OM.0230 10399		
	3014000701R	KIT RICAMBI COPPA POST.BIG VERTICALE CAR		
	307762801R	KIT TAPPO X OMOL. EVO2 N. 32B GPSTY		
	307242711R	KIT COPPA POST.FACT.VERT. D.54 EV.2		
	088291004R	KIT RIC RIVESTIMENTO FACT.DX BIG L=370		
	414205R	KIT RICAMBI LANA HT 800 Plus 850g		
14192E	KTM	1090 ADVENTURE/R (fits with rails for original and Givi panniers)	2017-2018	Leovince LV ONE EVO - SLIP-ON - STAINLESS STEEL
	KTM	1290 SUPER ADVENTURE R/S/T (fits with rails for original and Givi panniers)	2017-2018	
RICAMBI	308562501R	KIT fascetta FB5AS CARBONIO LVONE		
	3014033001R	KIT SACC CARTER CAR KTM ADV1050 1190 '16		
	3014033601R	KIT SACCH. MINUT. KTM ADV 1050 1190 '16		
	3014159481R	KIT R CO EV I R D54 BIG 0233/35 +C 10400		
	088292004R	KIT LAMELLE E RIVETTI OM.0233 0235 10400		
	3014000701R	KIT RICAMBI COPPA POST.BIG VERTICALE CAR		
	307762801R	KIT TAPPO X OMOL. EVO2 N. 32B GPSTY		
	307242711R	KIT COPPA POST.FACT.VERT. D.54 EV.2		
	088291004R	KIT RIC RIVESTIMENTO FACT.DX BIG L=370		
	414205R	KIT RICAMBI LANA HT 800 Plus 850g		
14193E	HONDA	X-ADV	2017-2018	Leovince LV PRO - SLIP-ON - STAINLESS STEEL
RICAMBI	306958501R	KIT fascetta FM1 Factory Medio Verticale		
	3014046202R	KIT SACCHETTO COLLETTORE N.1132		
	3014193601R	KIT SACCHET MINUTERIA HONDA X-ADV 750		
	300041530R	KIT fascetta 41 Inox		
	083896002R	KIT CARTER CARBONIO LATER X RAPTOR '06		
	303949001R	KIT RIC MOLLA-GOMM. ANTIVIB. CORTA		
	3014124481R	KIT R C PRO DX I50 COR L=180 10074 10393		
	088442008R	KIT LAMELLE E RIVETTI O. 10074-10393		
	308494701R	KIT RIC COPPA CAR.VERT.FACT.SOTTOSELLA		
	308437801R	KIT TAPPO dB-KILLER N. 52B FACTORY R		
	3014124741R	KIT COPPA POST VERTICALE Ø50 SOTTOSELLA		
	0814124004R	KIT RIC RIVESTIMENTO DX MEDIO L180 NO BA		
	414205R	KIT RICAMBI LANA HT 800 Plus 850g		
14194E	HONDA	X-ADV	2017-2018	Leovince LV PRO - SLIP-ON - CARBON FIBER
RICAMBI	306958501R	KIT fascetta FM1 Factory Medio Verticale		
	3014046202R	KIT SACCHETTO COLLETTORE N.1132		

ART.	MARCA	MODELLO	TIPOLOGIA
		3014193601R KIT SACCHET MINUTERIA HONDA X-ADV 750	
		300041530R KIT fascetta 41 Inox	
		083896002R KIT CARTER CARBONIO LATER X RAPTOR '06	
		303949001R KIT RIC MOLLA-GOMM. ANTIVIB. CORTA	
		3014124482R KIT R C PRO DX C50 COR L=180 10074 10393	
		088442010R KIT LAMELLE E RIVETTI O. 10074-10393	
		308494701R KIT RIC COPPA CAR.VERT.FACT.SOTTOSELLA	
		308437801R KIT TAPPO dB-KILLER N. 52B FACTORY R	
		3014124741R KIT COPPA POST VERTICALE Ø50 SOTTOSELLA	
		088442006R KIT RIC RIVESTIMENTO MEDIO CARB L=180mm	
		414205R KIT RICAMBI LANA HT 800 Plus 850g	
		206733R KIT RIC TARGHETTA LEOVINCE CARB LV PRO	
<b>14195S</b>	HONDA	X-ADV	2017-2018 Leovince FACTORY S - SLIP-ON - STAINLESS STEEL
RICAMBI		308448501R KIT fascetta FR2 CARBONIO MEDIA	
		3014195202R KIT SACCHETTO COLLETTORE N.1133	
		3014195601R KIT SACCHET MINUTERIA HONDA X-ADV 750	
		300041530R KIT fascetta 41 Inox	
		083896002R KIT CARTER CARBONIO LATER X RAPTOR '06	
		303949001R KIT RIC MOLLA-GOMM. ANTIVIB. CORTA	
		308437481R KIT R CO DX CAR CO D50 270 10057/8 10401	
		088421022R KIT LAMELLE E RIVETTI OM.10057-58 10401	
		308420701R KIT RICAMBIO COPPA POST. DX FACT CARB	
		308437801R KIT TAPPO dB-KILLER N. 52B FACTORY R	
		308437741R KIT COPPA POST.DX VERT. FACTORY-R Ø50	
		088421046R KIT RIC RIVESTIMENTO FACTORY INOX L=270	
		416797R KIT RICAMBIO LANA FACTORY L=270	
<b>14196S</b>	HONDA	X-ADV	2017-2018 Leovince FACTORY S - SLIP-ON - CARBON FIBER
RICAMBI		308448501R KIT fascetta FR2 CARBONIO MEDIA	
		3014195202R KIT SACCHETTO COLLETTORE N.1133	
		3014195601R KIT SACCHET MINUTERIA HONDA X-ADV 750	
		300041530R KIT fascetta 41 Inox	
		083896002R KIT CARTER CARBONIO LATER X RAPTOR '06	
		303949001R KIT RIC MOLLA-GOMM. ANTIVIB. CORTA	
		308436481R KIT R CORPO DX C Ø50 L270 O10057/8 10401	
		088421022R KIT LAMELLE E RIVETTI OM.10057-58 10401	
		308420701R KIT RICAMBIO COPPA POST. DX FACT CARB	
		308437801R KIT TAPPO dB-KILLER N. 52B FACTORY R	
		308437741R KIT COPPA POST.DX VERT. FACTORY-R Ø50	
		088420002R KIT RIC RIVESTIMENTO FACT 270mm CARB	
		416797R KIT RICAMBIO LANA FACTORY L=270	
		206721R KIT RIC TARGHETTA LEOVINCE CARBONIO	
<b>14210E</b>	HONDA	CB 500 F (fits with original centre stand)	2016-2018 Leovince LV ONE EVO - SLIP-ON - STAINLESS STEEL
	HONDA	CBR 500 R	2016-2018
	HONDA	CB 500 X (fits with original centre stand)	2017-2018
RICAMBI		3014149501R KIT fascetta FM5SF Factory Medio Vertica	
		3014050202R KIT SACCHETTO COLLETTORE N.1150	
		3014034601R KIT SACCH. MINUT. HONDA CB/CBR 400/500 F	
		300045530R KIT fascetta 45 Inox	
		308574001R KIT RIC MOLLA TRAZ SUPER CORTA + TUBETTO	
		308410481R KIT R COR EV IN D54 MED L300 0457 10410	
		088280002R KIT KAMELLE E RIVETTI OM.0457 10410	
		3014008701R KIT RICAMBIO COPPA POST. MEDIA VERT CARB	
		307762801R KIT TAPPO X OMOL. EVO2 N. 32B GPSTY	
		308287711R KIT COPPA POST.M.VERT.D.54 EV.2+LUNG	
		083710014R KIT RIC RIVESTIMENTO DX VERT MEDIO L=300	
		414205R KIT RICAMBI LANA HT 800 Plus 850g	
<b>14211E</b>	HONDA	CB 500 F (fits with original centre stand)	2016-2018 Leovince LV ONE EVO - SLIP-ON - CARBON FIBER
	HONDA	CBR 500 R	2016-2018
	HONDA	CB 500 X (fits with original centre stand)	2017-2018
RICAMBI		3014149501R KIT fascetta FM5SF Factory Medio Vertica	
		3014050202R KIT SACCHETTO COLLETTORE N.1150	

ART.	MARCA	MODELLO	TIPOLOGIA
3014034601R		KIT SACCH. MINUT. HONDA CB/CBR 400/500 F	
300045530R		KIT fascetta 45 Inox	
308574001R		KIT RIC MOLLA TRAZ SUPER CORTA + TUBETTO	
308411481R		KIT R COR EV CAR D54 MED L300 0457 10410	
088280002R		KIT KAMELLE E RIVETTI OM.0457 10410	
3014008701R		KIT RICAMBIO COPPA POST. MEDIA VERT CARB	
307762801R		KIT TAPPO X OMOL. EVO2 N. 32B GPSTY	
308287711R		KIT COPPA POST.M.VERT.D.54 EV.2+LUNG	
409117R		KIT RIVESTIMENTO MED CARB 100X115 L=300	
414205R		KIT RICAMBI LANA HT 800 Plus 850g	
206721R		KIT RIC TARGHETTA LEOVINCE CARBONIO	

14212SK	KYMCO	AK550 ABS	2017-2018	Leovince	FACTORY S - SLIP-ON - STAINLESS STEEL
---------	-------	-----------	-----------	----------	---------------------------------------

RICAMBI		
308448501R		KIT fascetta FR2 CARBONIO MEDIA
3014212204R		KIT SACCHETTO COLLETTORE N.1143
3014212561R		KIT SACCHET STAFFA INOX KYMCO AK 550
3014212001R		KIT SACC CARTER CAR KYMCO AK 550 '17
3014212601R		KIT SACCHETTO MINUTERIA KYMCO AK 550
300045530R		KIT fascetta 45 Inox
204999R		KIT RIC BOCCOLA 45X38X30 LGR/F D.026/07
303949001R		KIT RIC MOLLA-GOMM. ANTIVIB. CORTA
308437481R		KIT R CO DX CAR CO D50 270 10057/8 10401
088421022R		KIT LAMELLE E RIVETTI OM.10057-58 10401
308420701R		KIT RICAMBIO COPPA POST. DX FACT CARB
308437801R		KIT TAPPO dB-KILLER N. 52B FACTORY R
308437741R		KIT COPPA POST.DX VERT. FACTORY-R Ø50
088421046R		KIT RIC RIVESTIMENTO FACTORY INOX L=270
416797R		KIT RICAMBIO LANA FACTORY L=270

14212S	KYMCO	AK550 ABS	2017-2018	Leovince	FACTORY S - SLIP-ON - STAINLESS STEEL
--------	-------	-----------	-----------	----------	---------------------------------------

RICAMBI		
308078804R		KIT RIC TAPPO N.57 x SCOOTERONI
308448501R		KIT fascetta FR2 CARBONIO MEDIA
3014212202R		KIT SACCHETTO COLLETTORE N.1142
3014212561R		KIT SACCHET STAFFA INOX KYMCO AK 550
3014212001R		KIT SACC CARTER CAR KYMCO AK 550 '17
3014212601R		KIT SACCHETTO MINUTERIA KYMCO AK 550
300045530R		KIT fascetta 45 Inox
204999R		KIT RIC BOCCOLA 45X38X30 LGR/F D.026/07
303949001R		KIT RIC MOLLA-GOMM. ANTIVIB. CORTA
308437481R		KIT R CO DX CAR CO D50 270 10057/8 10401
088421022R		KIT LAMELLE E RIVETTI OM.10057-58 10401
308420701R		KIT RICAMBIO COPPA POST. DX FACT CARB
308437801R		KIT TAPPO dB-KILLER N. 52B FACTORY R
308437741R		KIT COPPA POST.DX VERT. FACTORY-R Ø50
088421046R		KIT RIC RIVESTIMENTO FACTORY INOX L=270
416797R		KIT RICAMBIO LANA FACTORY L=270

14213E	KYMCO	AK550 ABS	2017-2018	Leovince	LV PRO - SLIP-ON - STAINLESS STEEL
--------	-------	-----------	-----------	----------	------------------------------------

RICAMBI		
308078804R		KIT RIC TAPPO N.57 x SCOOTERONI
306958505R		KIT FASCETTA FM1S CARB. FACT. MED
3014213202R		KIT SACCHETTO COLLETTORE N.1144
3014213561R		KIT SACCHET STAFFA INOX KYMCO AK 550
306974002R		KIT SACC CARTER CARB APRILIA RSV 000
3014213601R		KIT SACCHETTO MINUTERIA KYMCO AK 550
300045530R		KIT fascetta 45 Inox
204999R		KIT RIC BOCCOLA 45X38X30 LGR/F D.026/07
303949001R		KIT RIC MOLLA-GOMM. ANTIVIB. CORTA
3014124481R		KIT R C PRO DX I50 COR L=180 10074 10393
088442008R		KIT LAMELLE E RIVETTI O. 10074-10393
308494701R		KIT RIC COPPA CAR.VERT.FACT.SOTTOSELLA
308437801R		KIT TAPPO dB-KILLER N. 52B FACTORY R
3014124741R		KIT COPPA POST VERTICALE Ø50 SOTTOSELLA
0814124004R		KIT RIC RIVESTIMENTO DX MEDIO L180 NO BA
414205R		KIT RICAMBI LANA HT 800 Plus 850g

ART.	MARCA	MODELLO	TIPOLOGIA
14214E	TRIUMPH	TIGER EXPLORER XR/XCX/XCX LOW/XCA (fits with original panniers) 2016-2017	Leovince LV ONE EVO - SLIP-ON - STAINLESS STEEL
RICAMBI	308562501R	KIT fascetta FB5AS CARBONIO LVONE	
	3014051202R	KIT SACCHETTO COLLETTORE N.1145	
	308720001R	KIT SACC CARTER CARB TRIUMPH EXPL 1200	
	3014051601R	KIT SACC MINUTERIA TRIUMPH 1200 '17	
	303949001R	KIT RIC MOLLA-GOMM. ANTIVIB. CORTA	
	308488481R	KIT R COR EVO IN R D54 BIG 0233/35 10400	
	088292004R	KIT LAMELLE E RIVETTI OM.0233 0235 10400	
	3014000701R	KIT RICAMBI COPPA POST.BIG VERTICALE CAR	
	307762801R	KIT TAPPO X OMOL. EVO2 N. 32B GPSTY	
	307242711R	KIT COPPA POST.FACT.VERT. D.54 EV.2	
	088291004R	KIT RIC RIVESTIMENTO FACT.DX BIG L=370	
	414205R	KIT RICAMBI LANA HT 800 Plus 850g	
14215EK	HONDA	FORZA 125/NSS 125/ABS 2017-2018	Leovince LV ONE EVO - FULL SYSTEM 1/1 - STAINLESS STEEL
RICAMBI	308562501R	KIT fascetta FB5AS CARBONIO LVONE	
	3014052204R	KIT SACCH COLLETTORE N.1153 APP	
	3014215601R	KIT SACC MINUTERIA HONDA FORZA NSS 125	
	303949001R	KIT RIC MOLLA-GOMM. ANTIVIB. CORTA	
	308424481R	KIT R COR EV IN RETE D50 BIG 0230 10399	
	088425010R	KIT LAMELLE E RIVETTI OM.0230 10399	
	3014000701R	KIT RICAMBI COPPA POST.BIG VERTICALE CAR	
	307762801R	KIT TAPPO X OMOL. EVO2 N. 32B GPSTY	
	307242711R	KIT COPPA POST.FACT.VERT. D.54 EV.2	
	088291004R	KIT RIC RIVESTIMENTO FACT.DX BIG L=370	
	414205R	KIT RICAMBI LANA HT 800 Plus 850g	
14215E	HONDA	FORZA 125/NSS 125/ABS 2017-2018	Leovince LV ONE EVO - FULL SYSTEM 1/1 - STAINLESS STEEL
RICAMBI	308562501R	KIT fascetta FB5AS CARBONIO LVONE	
	3014052202R	KIT SACCHETTO COLLETTORE N.1152	
	3014215601R	KIT SACC MINUTERIA HONDA FORZA NSS 125	
	303949001R	KIT RIC MOLLA-GOMM. ANTIVIB. CORTA	
	308424481R	KIT R COR EV IN RETE D50 BIG 0230 10399	
	088425010R	KIT LAMELLE E RIVETTI OM.0230 10399	
	3014000701R	KIT RICAMBI COPPA POST.BIG VERTICALE CAR	
	307762801R	KIT TAPPO X OMOL. EVO2 N. 32B GPSTY	
	307242711R	KIT COPPA POST.FACT.VERT. D.54 EV.2	
	088291004R	KIT RIC RIVESTIMENTO FACT.DX BIG L=370	
	414205R	KIT RICAMBI LANA HT 800 Plus 850g	
14216E	BMW	R 1200 GS (fits with original panniers) 2017-2018	Leovince LV ONE EVO - SLIP-ON - STAINLESS STEEL
	BMW	R 1200 GS ADVENTURE (fits with original panniers) 2017-2018	
RICAMBI	306960505R	KIT FASCETTA FB1S CARBONIO	
	308787202R	KIT SACCHETTO COLLETTORE N°1032	
	3014053601R	KIT SACCHETTO MINUTERIA BMW R1200 GS	
	308787001R	KIT SACCHET CARTER CARBONIO BMW R1200 GS	
	308574001R	KIT RIC MOLLA TRAZ SUPER CORTA + TUBETTO	
	308291481R	KIT R COR EVO IN R D54 BIG 0233/35 10400	
	088292004R	KIT LAMELLE E RIVETTI OM.0233 0235 10400	
	3014000701R	KIT RICAMBI COPPA POST.BIG VERTICALE CAR	
	307762801R	KIT TAPPO X OMOL. EVO2 N. 32B GPSTY	
	307242711R	KIT COPPA POST.FACT.VERT. D.54 EV.2	
	088291004R	KIT RIC RIVESTIMENTO FACT.DX BIG L=370	
	414205R	KIT RICAMBI LANA HT 800 Plus 850g	
14217E	BMW	R 1200 GS (fits with original panniers) 2017-2018	Leovince LV ONE EVO - SLIP-ON - CARBON FIBER
	BMW	R 1200 GS ADVENTURE (fits with original panniers) 2017-2018	
RICAMBI	306960505R	KIT FASCETTA FB1S CARBONIO	
	308787202R	KIT SACCHETTO COLLETTORE N°1032	
	3014053601R	KIT SACCHETTO MINUTERIA BMW R1200 GS	
	308787001R	KIT SACCHET CARTER CARBONIO BMW R1200 GS	
	308574001R	KIT RIC MOLLA TRAZ SUPER CORTA + TUBETTO	

ART.	MARCA	MODELLO	TIPOLOGIA
		308292481R KIT R COR EV CAR R D54 BIG 0233/35 10400 088425008R KIT LAMELLE E RIVETTI OM.0233 0235 10400 3014000701R KIT RICAMBI COPPA POST.BIG VERTICALE CAR 307762801R KIT TAPPO X OMOL. EVO2 N. 32B GPSTY 307242711R KIT COPPA POST.FACT.VERT. D.54 EV.2 408543R KIT RIVESTIMENTO BIG CARB 110X125 L=370 414205R KIT RICAMBI LANA HT 800 Plus 850g 206721R KIT RIC TARGHETTA LEOVINCE CARBONIO	
<b>14218E</b>	HONDA	CBR 1000 RR FIREBLADE/SP/SP2	2017-2018 Leovince LV PRO - SLIP-ON - STAINLESS STEEL
RICAMBI		306958505R KIT FASCETTA FM1S CARB. FACT. MED 3014218202R KIT SACCHETTO COLLETTORE N.1177 3014218601R KIT SACCHETT MINUTERIA HONDA CBR 1000 RR 3014218561R KIT SACCHET STAFF INOX HONDA CBR 1000 RR 300063530R KIT fascetta 63 Inox 303949001R KIT RIC MOLLA-GOMM. ANTIVIB. CORTA 3014129481R KIT COR PRO DX I54 COR L=180 10074 10405 088442014R KIT LAMELLE E RIVETTI O. 10074-10405 308494701R KIT RIC COPPA CAR.VERT.FACT.SOTTOSELLA 308437801R KIT TAPPO dB-KILLER N. 52B FACTORY R 308442711R KIT COPPA POST VERTICALE Ø54 SOTTOSELLA 0814124004R KIT RIC RIVESTIMENTO DX MEDIO L180 NO BA 414205R KIT RICAMBI LANA HT 800 Plus 850g	
<b>14219E</b>	HONDA	CBR 1000 RR FIREBLADE/SP/SP2	2017-2018 Leovince LV PRO - SLIP-ON - CARBON FIBER
RICAMBI		306958505R KIT FASCETTA FM1S CARB. FACT. MED 3014218202R KIT SACCHETTO COLLETTORE N.1177 3014218601R KIT SACCHETT MINUTERIA HONDA CBR 1000 RR 3014218561R KIT SACCHET STAFF INOX HONDA CBR 1000 RR 300063530R KIT fascetta 63 Inox 303949001R KIT RIC MOLLA-GOMM. ANTIVIB. CORTA 3014129482R KIT COR PRO DX C54 COR L=180 10074 10405 088442014R KIT LAMELLE E RIVETTI O. 10074-10405 308494701R KIT RIC COPPA CAR.VERT.FACT.SOTTOSELLA 308437801R KIT TAPPO dB-KILLER N. 52B FACTORY R 308442711R KIT COPPA POST VERTICALE Ø54 SOTTOSELLA 088442006R KIT RIC RIVESTIMENTO MEDIO CARB L=180mm 414205R KIT RICAMBI LANA HT 800 Plus 850g 206733R KIT RIC TARGHETTA LEOVINCE CARB LV PRO	
<b>14220E</b>	HONDA	CRF 1000 L AFRICA TWIN/ABS (fits with original panniers)	2016-2017 Leovince LV ONE EVO - FULL SYSTEM 2/1 - STAINLESS STEEL
RICAMBI		3014220501R KIT fascetta FB1AS CARBONIO LVONE 3014220203R KIT SACCHETTO COLLETT PRIM N.1165 1166 3014220205R KIT SACCHETTO COLLETT SECONDARIO N.1167 5683 KIT TAPPO SONDA LAMBDA M12 RACING + GUA 3014220207R KIT SACCHETTO COLLETT FINALE N.1168 307114002R KIT SACC CARTER CAR KAWASAKI ZX10R NINJA 3014220502R KIT SACCHET STAFFA CAR HONDA CRF1000L 3014220601R KIT SACCH. MINUT.HONDA CRF 1000L AFRICA 303949001R KIT RIC MOLLA-GOMM. ANTIVIB. CORTA 3014220481R KIT R COR EVO IN R D54 BIG 0233/35 10400 088292004R KIT LAMELLE E RIVETTI OM.0233 0235 10400 307762801R KIT TAPPO X OMOL. EVO2 N. 32B GPSTY 307242711R KIT COPPA POST.FACT.VERT. D.54 EV.2 088291004R KIT RIC RIVESTIMENTO FACT.DX BIG L=370 414205R KIT RICAMBI LANA HT 800 Plus 850g	
<b>14221E</b>	KAWASAKI	NINJA 1000/ABS (US model only, do not fit with original panniers)	2010-2018 Leovince LV PRO - 2 SLIP-ON - STAINLESS STEEL
	KAWASAKI	Z 1000	2017-2018
	KAWASAKI	Z 1000 SX (do not fit with original panniers)	2017-2018
RICAMBI		307572505R KIT fascetta FM4S Fact. Medio 308249203R KIT RICAMBIO COLLETTORE N°790 DX Z1000 308249204R KIT SACCHETTO COLLETTORE N. 791 SX	

ART.	MARCA	MODELLO	TIPOLOGIA	
		308249601R	KIT SACCH.MINUTERIA Z1000 ie10 FAC	
		303949001R	KIT RIC MOLLA-GOMM. ANTIVIB. CORTA	
		3014129481R	KIT COR PRO DX I54 COR L=180 10074 10405	
		3014129483R	KIT COR PRO SX I54 COR L=180 10074 10405	
		088442012R	KIT LAMELLE E RIVETTI O. 10074-10405	
		308494701R	KIT RIC COPPA CAR.VERT.FACT.SOTTOSELLA	
		308437801R	KIT TAPPO dB-KILLER N. 52B FACTORY R	
		308442711R	KIT COPPA POST VERTICALE Ø54 SOTTOSELLA	
		814124004	RIVESTIMENTO MEDIO DX INOX L=180mm	
		0814124010R	KIT RIC RIVESTIMENTO SX MEDIO L180 NO BA	
		414205R	KIT RICAMBI LANA HT 800 Plus 850g	
<b>14222E</b>	KAWASAKI	NINJA 1000/ABS (US model only, do not fit with original panniers)	2010-2018	Leovince LV PRO - 2 SLIP-ON - CARBON FIBER
	KAWASAKI	Z 1000	2017-2018	
	KAWASAKI	Z 1000 SX (do not fit with original panniers)	2017-2018	
<b>RICAMBI</b>		307572505R	KIT fascetta FM4S Fact. Medio	
		308249203R	KIT RICAMBIO COLLETTORE N°790 DX Z1000	
		308249204R	KIT SACCHETTO COLLETTORE N. 791 SX	
		308249601R	KIT SACCH.MINUTERIA Z1000 ie10 FAC	
		303949001R	KIT RIC MOLLA-GOMM. ANTIVIB. CORTA	
		3014129482	CORPO PRO DX C Ø54 COR L=180 10074 10405	
		3014129484	CORPO PRO SX C Ø54 COR L=180 10074 10405	
		088442014R	KIT LAMELLE E RIVETTI O. 10074-10405	
		308494701R	KIT RIC COPPA CAR.VERT.FACT.SOTTOSELLA	
		308437801R	KIT TAPPO dB-KILLER N. 52B FACTORY R	
		308442711R	KIT COPPA POST VERTICALE Ø54 SOTTOSELLA	
		088442006R	KIT RIC RIVESTIMENTO MEDIO CARB L=180mm	
		414205R	KIT RICAMBI LANA HT 800 Plus 850g	
		206721R	KIT RIC TARGHETTA LEOVINCE CARBONIO	
<b>14223S</b>	KAWASAKI	Z 1000	2017-2018	Leovince FACTORY S - 2 SLIP-ON - STAINLESS STEEL
	KAWASAKI	Z 1000 SX (fits with original panniers)	2017-2018	
<b>RICAMBI</b>		308444501R	KIT fascetta FR3 CARBONIO PICCOLA	
		3014146203R	KIT SACCHETTO COLLETTORE N.1090	
		3014146204R	KIT SACCHETTO COLLETTORE N.1091	
		3014146601R	KIT SACCH. MINUT. KAWASAKI Z1000 SX '14	
		303949001R	KIT RIC MOLLA-GOMM. ANTIVIB. CORTA	
		308421481R	KIT R CO DX IN C D54 L=270 10057/8 10395	
		308421482R	KIT R CO SX IN C D54 L=270 10057/8 10395	
		088421026R	KIT LAMELLE E RIVETTI OM.10057-58 10395	
		308420701R	KIT RICAMBIO COPPA POST. DX FACT CARB	
		308420702R	KIT RICAMBIO COPPA POST. SX FACT CARB	
		308421801R	KIT TAPPO X OMOL. EVO2 N. 52 FACTORY -R	
		308421741R	KIT COPPA POST.DX VERT. FACTORY-R Ø50	
		308421742R	KIT COPPA POST.SX VERT. FACTORY-R Ø54	
		088421046R	KIT RIC RIVESTIMENTO FACTORY INOX L=270	
		416797R	KIT RICAMBIO LANA FACTORY L=270	
<b>14224S</b>	KAWASAKI	Z 1000	2017-2018	Leovince FACTORY S - 2 SLIP-ON - CARBON FIBER
	KAWASAKI	Z 1000 SX (fits with original panniers)	2017-2018	
<b>RICAMBI</b>		308444501R	KIT fascetta FR3 CARBONIO PICCOLA	
		3014146203R	KIT SACCHETTO COLLETTORE N.1090	
		3014146204R	KIT SACCHETTO COLLETTORE N.1091	
		3014146601R	KIT SACCH. MINUT. KAWASAKI Z1000 SX '14	
		303949001R	KIT RIC MOLLA-GOMM. ANTIVIB. CORTA	
		308420481R	KIT R CO DX CAR D54 L=270 10057/8 10395	
		308420482R	KIT R CO SX CAR D54 L=270 10057/8 10395	
		088421026R	KIT LAMELLE E RIVETTI OM.10057-58 10395	
		308420701R	KIT RICAMBIO COPPA POST. DX FACT CARB	
		308420702R	KIT RICAMBIO COPPA POST. SX FACT CARB	
		308421801R	KIT TAPPO X OMOL. EVO2 N. 52 FACTORY -R	
		308421741R	KIT COPPA POST.DX VERT. FACTORY-R Ø50	
		308421742R	KIT COPPA POST.SX VERT. FACTORY-R Ø54	
		088420002R	KIT RIC RIVESTIMENTO FACT 270mm CARB	



ART.	MARCA	MODELLO		TIPOLOGIA
		416797R	KIT RICAMBIO LANA FACTORY L=270	
		206721R	KIT RIC TARGHETTA LEOVINCE CARBONIO	
<b>14226S</b>	YAMAHA	YZF-R6	2017-2018	Leovince FACTORY S - FULL SYSTEM 4/21 - STAINLESS STEEL
<b>RICAMBI</b>		308448501R	KIT fascetta FR2 CARBONIO MEDIA	
		308241206R	KIT SACCHETTO COL.PRIMARI X R6 '10	
		204448R	KIT RIC FLANGIA INOX 46 D DIS.086/04	
		204851R	KIT RIC BOCCHETTONE INOX DIS. 060/06	
		3014226203R	KIT SACCHET BIFORCAZIONE SECOND SX E DX	
		3014226205R	KIT SACCHETTO COLLETTORE FINALE	
		3014226601R	KIT SACCHETT MINUTERIA YAMAHA YZF R6 '18	
		3014226561R	KIT SACCH STAFFA ALL YAMAHA YZF-R6 '18	
		5683	KIT TAPPO SONDA LAMBDA M12 RACING + GUA	
		303949001R	KIT RIC MOLLA-GOMM. ANTIVIB. CORTA	
		308472481R	KIT R COR DX IN CON D60 L=270 OM10059-60	
		088421020R	KIT LAMELLE E RIVETTI OM. 10059-60	
		308420701R	KIT RICAMBIO COPPA POST. DX FACT CARB	
		308421801R	KIT TAPPO X OMOL. EVO2 N. 52 FACTORY -R	
		308421741R	KIT COPPA POST.DX VERT. FACTORY-R Ø50	
		088421046R	KIT RIC RIVESTIMENTO FACTORY INOX L=270	
		416797R	KIT RICAMBIO LANA FACTORY L=270	
<b>14227S</b>	YAMAHA	YZF-R6	2017-2018	Leovince FACTORY S - FULL SYSTEM 4/21 - CARBON FIBER
<b>RICAMBI</b>		308448501R	KIT fascetta FR2 CARBONIO MEDIA	
		308241206R	KIT SACCHETTO COL.PRIMARI X R6 '10	
		204448R	KIT RIC FLANGIA INOX 46 D DIS.086/04	
		204851R	KIT RIC BOCCHETTONE INOX DIS. 060/06	
		3014226203R	KIT SACCHET BIFORCAZIONE SECOND SX E DX	
		3014226205R	KIT SACCHETTO COLLETTORE FINALE	
		3014226601R	KIT SACCHETT MINUTERIA YAMAHA YZF R6 '18	
		3014226561R	KIT SACCH STAFFA ALL YAMAHA YZF-R6 '18	
		5683	KIT TAPPO SONDA LAMBDA M12 RACING + GUA	
		303949001R	KIT RIC MOLLA-GOMM. ANTIVIB. CORTA	
		308471481R	KIT R CO DX CAR CON D60 L=270 OM10059-60	
		088421020R	KIT LAMELLE E RIVETTI OM. 10059-60	
		308420701R	KIT RICAMBIO COPPA POST. DX FACT CARB	
		308421801R	KIT TAPPO X OMOL. EVO2 N. 52 FACTORY -R	
		308421741R	KIT COPPA POST.DX VERT. FACTORY-R Ø50	
		088420002R	KIT RIC RIVESTIMENTO FACT 270mm CARB	
		416797R	KIT RICAMBIO LANA FACTORY L=270	
		206721R	KIT RIC TARGHETTA LEOVINCE CARBONIO	
<b>14228EK</b>	YAMAHA	MT-09 ABS	2017-2018	Leovince LV ONE EVO - FULL SYSTEM 3/1 - STAINLESS STEEL
	YAMAHA	MT-09 SP	2018-	
	YAMAHA	MT-09 TRACER/FJ-09 (fits with original centre stand)	2017-2018	
	YAMAHA	MT-09 TRACER GT/FJ-09 GT (fits with original centre stand)	2018-	
	YAMAHA	XSR 900 ABS	2016-2018	
<b>RICAMBI</b>		307572505R	KIT fascetta FM4S Fact. Medio	
		3014228802R	KIT TAPPO X OMOL. EVO2 N.59	
		3014032206R	KIT SACCHETTO COLLETTORE PRIMARIO XSR900	
		3014228204R	KIT RICAMBIO SACC TRIFORC CAT TRACER 900	
		3014228601R	KIT SACCHETT MINUTERIA YAMAHA TRACER 900	
		3014228561R	KIT SACCHET STAFF INOX YAMAHA TRACER 900	
		204448R	KIT RIC FLANGIA INOX 46 D DIS.086/04	
		204870R	KIT RICAMBIO BOCCOLA INOX DIS.094/06	
		303949001R	KIT RIC MOLLA-GOMM. ANTIVIB. CORTA	
		3014228481R	KIT R COR EVO IN D50 MED L=270 OM.10423	
		0814228003R	KIT LAMELLE E RIVETTI OM.0429-30 10423	
		308266701R	KIT COPPA CARB.ORIZ. FACT.SOTTOSELLA	
		204790R	KIT RIC GOMMINO COPPE CARBONIO D.007/06	
		3014228701R	KIT COP.POST ORIZZ./VERTIC. Ø50 SOTTOSEL	
		088406004R	KIT RIC RIVESTIMENTO FACT.DX MEDIO L=270	
		414205R	KIT RICAMBI LANA HT 800 Plus 850g	

ART.	MARCA	MODELLO		TIPOLOGIA
14228E	YAMAHA	MT-09 ABS	2017-2018	Leovince LV ONE EVO - FULL SYSTEM 3/1 - STAINLESS STEEL
	YAMAHA	MT-09 SP	2018-	
	YAMAHA	MT-09 TRACER/FJ-09 (fits with original centre stand)	2017-2018	
	YAMAHA	MT-09 TRACER GT/FJ-09 GT (fits with original centre stand)	2018-	
	YAMAHA	XSR 900 ABS	2016-2018	
RICAMBI	307572505R	KIT fascetta FM4S Fact. Medio		
	3014228802R	KIT TAPPO X OMOL. EVO2 N.59		
	3014032206R	KIT SACCHETTO COLLETTORE PRIMARIO XSR900		
	3014228202R	KIT RICAMBIO SACC TRIFORC FIN TRACER 900		
	3014228601R	KIT SACCHETT MINUTERIA YAMAHA TRACER 900		
	3014228561R	KIT SACCHET STAFF INOX YAMAHA TRACER 900		
	204448R	KIT RIC FLANGIA INOX 46 D DIS.086/04		
	204870R	KIT RICAMBIO BOCCOLA INOX DIS.094/06		
	303949001R	KIT RIC MOLLA-GOMM. ANTIVIB. CORTA		
	3014228481R	KIT R COR EVO IN D50 MED L=270 OM.10423		
	0814228003R	KIT LAMELLE E RIVETTI OM.0429-30 10423		
	308266701R	KIT COPPA CARB.ORIZ. FACT.SOTTOSELLA		
	204790R	KIT RIC GOMMINO COPPE CARBONIO D.007/06		
	3014228701R	KIT COP.POST ORIZZ./VERTIC. Ø50 SOTTOSEL		
	088406004R	KIT RIC RIVESTIMENTO FACT.DX MEDIO L=270		
	414205R	KIT RICAMBI LANA HT 800 Plus 850g		
14229EK	YAMAHA	MT-09 ABS	2017-2018	Leovince LV ONE EVO - FULL SYSTEM 3/1 - CARBON FIBER
	YAMAHA	MT-09 SP	2018-	
	YAMAHA	MT-09 TRACER/FJ-09 (fits with original centre stand)	2017-2018	
	YAMAHA	MT-09 TRACER GT/FJ-09 GT (fits with original centre stand)	2018-	
	YAMAHA	XSR 900 ABS	2016-2018	
RICAMBI	307572505R	KIT fascetta FM4S Fact. Medio		
	3014228802R	KIT TAPPO X OMOL. EVO2 N.59		
	3014032206R	KIT SACCHETTO COLLETTORE PRIMARIO XSR900		
	3014228204R	KIT RICAMBIO SACC TRIFORC CAT TRACER 900		
	3014228601R	KIT SACCHETT MINUTERIA YAMAHA TRACER 900		
	3014228561R	KIT SACCHET STAFF INOX YAMAHA TRACER 900		
	204448R	KIT RIC FLANGIA INOX 46 D DIS.086/04		
	204870R	KIT RICAMBIO BOCCOLA INOX DIS.094/06		
	303949001R	KIT RIC MOLLA-GOMM. ANTIVIB. CORTA		
	3014228481R	KIT R COR EVO IN D50 MED L=270 OM.10423		
	0814228003R	KIT LAMELLE E RIVETTI OM.0429-30 10423		
	308266701R	KIT COPPA CARB.ORIZ. FACT.SOTTOSELLA		
	204790R	KIT RIC GOMMINO COPPE CARBONIO D.007/06		
	3014228701R	KIT COP.POST ORIZZ./VERTIC. Ø50 SOTTOSEL		
	088407002R	KIT RIC RIVESTIMENTO FACTORY MEDIO L=270		
	414205R	KIT RICAMBI LANA HT 800 Plus 850g		
14229E	YAMAHA	MT-09 ABS	2017-2018	Leovince LV ONE EVO - FULL SYSTEM 3/1 - CARBON FIBER
	YAMAHA	MT-09 SP	2018-	
	YAMAHA	MT-09 TRACER/FJ-09 (fits with original centre stand)	2017-2018	
	YAMAHA	MT-09 TRACER GT/FJ-09 GT (fits with original centre stand)	2018-	
	YAMAHA	XSR 900 ABS	2016-2018	
RICAMBI	307572505R	KIT fascetta FM4S Fact. Medio		
	3014228802R	KIT TAPPO X OMOL. EVO2 N.59		
	3014032206R	KIT SACCHETTO COLLETTORE PRIMARIO XSR900		
	3014228202R	KIT RICAMBIO SACC TRIFORC FIN TRACER 900		
	3014228601R	KIT SACCHETT MINUTERIA YAMAHA TRACER 900		
	3014228561R	KIT SACCHET STAFF INOX YAMAHA TRACER 900		
	204448R	KIT RIC FLANGIA INOX 46 D DIS.086/04		
	204870R	KIT RICAMBIO BOCCOLA INOX DIS.094/06		
	303949001R	KIT RIC MOLLA-GOMM. ANTIVIB. CORTA		
	3014229481R	KIT R COR EV CAR D50 MED L=270 OM.10423		
	0814228003R	KIT LAMELLE E RIVETTI OM.0429-30 10423		
	308266701R	KIT COPPA CARB.ORIZ. FACT.SOTTOSELLA		
	204790R	KIT RIC GOMMINO COPPE CARBONIO D.007/06		
	3014228701R	KIT COP.POST ORIZZ./VERTIC. Ø50 SOTTOSEL		

ART.	MARCA	MODELLO		TIPOLOGIA
		088407002R 414205R	KIT RIC RIVESTIMENTO FACTORY MEDIO L=270 KIT RICAMBI LANA HT 800 Plus 850g	
<b>14230E</b>	BENELLI	TRK 502	2017-2018	Leovince LV ONE EVO - SLIP-ON - STAINLESS STEEL
RICAMBI		3014228802R 3014230202R 3014230601R 303949001R 3014230481R 0814228003R 308266701R 204790R 3014228701R 0814230005R 414205R	KIT TAPPO X OMOL. EVO2 N.59 KIT SACCHETTO COLLETTORE N.1183 KIT SACCHETTO MINUTERIA BENELLI TRK 502 KIT RIC MOLLA-GOMM. ANTIVIB. CORTA KIT R COR EVO IN D50 MED L=270 OM.10423 KIT LAMELLE E RIVETTI OM.0429-30 10423 KIT COPPA CARB.ORIZ. FACT.SOTTOSELLA KIT RIC GOMMINO COPPE CARBONIO D.007/06 KIT COP.POST ORIZZ./VERTIC. Ø50 SOTTOSEL KIT RIC RIVESTIMENTO FACT.DX MEDIO L=270 KIT RICAMBI LANA HT 800 Plus 850g	
<b>14231SK</b>	KYMCO	AK550 ABS	2017-2018	Leovince FACTORY S - FULL SYSTEM 2/1 - STAINLESS STEEL
RICAMBI		308448501R 3014212204R 3014212561R 3014212001R 308087202R 308087204R 3014231601R 5683 300045530R 204999R 303949001R 308437481R 088421022R 308420701R 308437801R 308437741R 088421046R 416797R	KIT fascetta FR2 CARBONIO MEDIA KIT SACCHETTO COLLETTORE N.1143 KIT SACCHET STAFFA INOX KYMCO AK 550 KIT SACC CARTER CAR KYMCO AK 550 '17 KIT SACCHETTO COLLETTORE PRIMARIO N.1158 KIT SACCHETTO COLLETTORE FINALE N.1159 KIT SACCHETT MINUT KYMCO AK 550 FULL '17 KIT TAPPO Sonda LAMBDA M12 RACING + GUA KIT fascetta 45 Inox KIT RIC BOCCOLA 45X38X30 LGR/F D.026/07 KIT RIC MOLLA-GOMM. ANTIVIB. CORTA KIT R CO DX CAR CO D50 270 10057/8 10401 KIT LAMELLE E RIVETTI OM.10057-58 10401 KIT RICAMBIO COPPA POST. DX FACT CARB KIT TAPPO dB-KILLER N. 52B FACTORY R KIT COPPA POST.DX VERT. FACTORY-R Ø50 KIT RIC RIVESTIMENTO FACTORY INOX L=270 KIT RICAMBIO LANA FACTORY L=270	
<b>14231S</b>	KYMCO	AK550 ABS	2017-2018	Leovince FACTORY S - FULL SYSTEM 2/1 - STAINLESS STEEL
RICAMBI		308448501R 3014212202R 3014212561R 3014212001R 308087202R 308087204R 3014231601R 5683 300045530R 204999R 303949001R 308437481R 088421022R 308420701R 308437801R 308437741R 088421046R 416797R	KIT fascetta FR2 CARBONIO MEDIA KIT SACCHETTO COLLETTORE N.1142 KIT SACCHET STAFFA INOX KYMCO AK 550 KIT SACC CARTER CAR KYMCO AK 550 '17 KIT SACCHETTO COLLETTORE PRIMARIO N.1158 KIT SACCHETTO COLLETTORE FINALE N.1159 KIT SACCHETT MINUT KYMCO AK 550 FULL '17 KIT TAPPO Sonda LAMBDA M12 RACING + GUA KIT fascetta 45 Inox KIT RIC BOCCOLA 45X38X30 LGR/F D.026/07 KIT RIC MOLLA-GOMM. ANTIVIB. CORTA KIT R CO DX CAR CO D50 270 10057/8 10401 KIT LAMELLE E RIVETTI OM.10057-58 10401 KIT RICAMBIO COPPA POST. DX FACT CARB KIT TAPPO dB-KILLER N. 52B FACTORY R KIT COPPA POST.DX VERT. FACTORY-R Ø50 KIT RIC RIVESTIMENTO FACTORY INOX L=270 KIT RICAMBIO LANA FACTORY L=270	
<b>14232EK</b>	HUSQVARNA	701 ENDURO	2017-2018	Leovince LV ONE EVO - FULL SYSTEM 1/1 - STAINLESS STEEL
	HUSQVARNA	701 SUPERMOTO	2017-2018	
RICAMBI		303692502R 3014232206R 3014232208R 3014232601R	KIT RICAMBIO STAFFA T2 KIT SACCHETTO COLLETT PRIM BOMB CATALIZ KIT SACCHETTO COLLETT FINALE + TAPPO 57C KIT SACCHETT MINUT HUSQVARNA 701 FULL	

ART.	MARCA	MODELLO		TIPOLOGIA
		303949001R	KIT RIC MOLLA-GOMM. ANTIVIB. CORTA	
		3014232481R	KIT COR SX EV I D50 M L300 0429/30 10394	
		088282004R	KIT LAMELLE E RIVETTI OM.0430 0457 10394	
		3014008701R	KIT RICAMBIO COPPA POST. MEDIA VERT CARB	
		307762801R	KIT TAPPO X OMOL. EVO2 N. 32B GPSTY	
		308287711R	KIT COPPA POST.M.VERT.D.54 EV.2+LUNG	
		0814232012R	KIT RIC RIVESTIMENTO SX VERT MEDIO L=300	
		414205R	KIT RICAMBI LANA HT 800 Plus 850g	
		206424R	KIT BOCCOLA IN INOX 304 DIS.MF150	
		206423R	KIT FLANGIA INOX 304 SP.5MM DIS.MF149	
<b>14232E</b>	HUSQVARNA	701 ENDURO	2017-2018	Leovince LV ONE EVO - FULL SYSTEM 1/1 - STAINLESS STEEL
	HUSQVARNA	701 SUPERMOTO	2017-2018	
<b>RICAMBI</b>		303692502R	KIT RICAMBIO STAFFA T2	
		3014232202R	KIT SACCHETTO COLLETT PRIMAR BOMBOLOTTO	
		3014232204R	KIT SACCHETTO COLLETTORE FINALE	
		3014232601R	KIT SACCHETT MINUT HUSQVARNA 701 FULL	
		3014232802R	KIT SACC.TAPPO N. 57C CONO COLLETTORI	
		303949001R	KIT RIC MOLLA-GOMM. ANTIVIB. CORTA	
		3014232481R	KIT COR SX EV I D50 M L300 0429/30 10394	
		088282004R	KIT LAMELLE E RIVETTI OM.0430 0457 10394	
		3014008701R	KIT RICAMBIO COPPA POST. MEDIA VERT CARB	
		307762801R	KIT TAPPO X OMOL. EVO2 N. 32B GPSTY	
		308287711R	KIT COPPA POST.M.VERT.D.54 EV.2+LUNG	
		0814232012R	KIT RIC RIVESTIMENTO SX VERT MEDIO L=300	
		414205R	KIT RICAMBI LANA HT 800 Plus 850g	
		206423R	KIT FLANGIA INOX 304 SP.5MM DIS.MF149	
		206424R	KIT BOCCOLA IN INOX 304 DIS.MF150	
<b>14233S</b>	BMW	S 1000 RR	2017-2018	Leovince FACTORY S - FULL SYSTEM 4/2/1 - STAINLESS STEEL
<b>RICAMBI</b>		308448501R	KIT fascetta FR2 CARBONIO MEDIA	
		3014233561R	KIT SACC STAFFA V CARBON BMW S 1000 RR	
		3014233205R	KIT SACCHETTO COLLETTORI PRIMARI	
		205670R	KIT RIC FLANGIA INOX 150 A DIS.006/10	
		206432R	KIT BOCCOLA INOX 48.3X38X23 DIS.MF158	
		3014233207R	KIT SACCHETTO BIFORCAZIONE SECONDARIA SX	
		3014233209R	KIT SACCHETTO BIFORCAZIONE SECONDARIA DX	
		3014233211R	KIT SACCHETTO COLLETTORE FINALE 2/1	
		3014233601R	KIT SACC MINUT FULL SYS BMW S 1000 R '17	
		5683	KIT TAPPO Sonda LAMBDA M12 RACING + GUA	
		303949001R	KIT RIC MOLLA-GOMM. ANTIVIB. CORTA	
		308472481R	KIT R COR DX IN CON D60 L=270 OM10059-60	
		088421020R	KIT LAMELLE E RIVETTI OM. 10059-60	
		308420701R	KIT RICAMBIO COPPA POST. DX FACT CARB	
		308421801R	KIT TAPPO X OMOL. EVO2 N. 52 FACTORY -R	
		308421741R	KIT COPPA POST.DX VERT. FACTORY-R Ø50	
		088421046R	KIT RIC RIVESTIMENTO FACTORY INOX L=270	
		416797R	KIT RICAMBIO LANA FACTORY L=270	
<b>14234S</b>	BMW	S 1000 RR	2017-2018	Leovince FACTORY S - FULL SYSTEM 4/2/1 - CARBON FIBER
<b>RICAMBI</b>		308448501R	KIT fascetta FR2 CARBONIO MEDIA	
		3014233561R	KIT SACC STAFFA V CARBON BMW S 1000 RR	
		3014233205R	KIT SACCHETTO COLLETTORI PRIMARI	
		205670R	KIT RIC FLANGIA INOX 150 A DIS.006/10	
		206432R	KIT BOCCOLA INOX 48.3X38X23 DIS.MF158	
		3014233207R	KIT SACCHETTO BIFORCAZIONE SECONDARIA SX	
		3014233209R	KIT SACCHETTO BIFORCAZIONE SECONDARIA DX	
		3014233211R	KIT SACCHETTO COLLETTORE FINALE 2/1	
		3014233601R	KIT SACC MINUT FULL SYS BMW S 1000 R '17	
		5683	KIT TAPPO Sonda LAMBDA M12 RACING + GUA	
		303949001R	KIT RIC MOLLA-GOMM. ANTIVIB. CORTA	
		308471481R	KIT R CO DX CAR CON D60 L=270 OM10059-60	
		088421020R	KIT LAMELLE E RIVETTI OM. 10059-60	
		308420701R	KIT RICAMBIO COPPA POST. DX FACT CARB	

ART.	MARCA	MODELLO	TIPOLOGIA
		308421801R KIT TAPPO X OMOL. EVO2 N. 52 FACTORY -R	
		308421741R KIT COPPA POST.DX VERT. FACTORY-R Ø50	
		088420002R KIT RIC RIVESTIMENTO FACT 270mm CARB	
		416797R KIT RICAMBIO LANA FACTORY L=270	
		206721R KIT RIC TARGHETTA LEOVINCE CARBONIO	
<b>14235E</b>	TRIUMPH	SPEED TRIPLE 1050 R/S	2016-2017 Leovince LV ONE EVO - 2 SLIP-ON - STAINLESS STEEL
<b>RICAMBI</b>		306958505R KIT FASCETTA FM1S CARB. FACT. MED	
		3014235601R KIT SACC MINUT SPEED TRIPLE 1050 '17	
		3014235561R KIT SACC STAF ALL TRIUMPH SPEED TRIPLE	
		3014235481R KIT R C EV IN DX D50 MED L=300 OM.10394	
		3014235482R KIT R C EVO IN SX D50 MED L=300 OM.10394	
		088282004R KIT LAMELLE E RIVETTI OM.0430 0457 10394	
		3014008701R KIT RICAMBIO COPPA POST. MEDIA VERT CARB	
		307762801R KIT TAPPO X OMOL. EVO2 N. 32B GPSTY	
		308287711R KIT COPPA POST.M.VERT.D.54 EV.2+LUNG	
		083710014R KIT RIC RIVESTIMENTO DX VERT MEDIO L=300	
		083710016R KIT RIC RIVESTIMENTO SX VERT. MEDI L=300	
		414205R KIT RICAMBI LANA HT 800 Plus 850g	
<b>14236E</b>	TRIUMPH	SPEED TRIPLE 1050 R/S	2016-2017 Leovince LV ONE EVO - 2 SLIP-ON - CARBON FIBER
<b>RICAMBI</b>		306958505R KIT FASCETTA FM1S CARB. FACT. MED	
		3014235601R KIT SACC MINUT SPEED TRIPLE 1050 '17	
		3014235561R KIT SACC STAF ALL TRIUMPH SPEED TRIPLE	
		3014236481R KIT R C EV CAR DX D50 MED L=300 OM.10394	
		3014236482R KIT R C EV CAR SX D50 MED L=300 OM.10394	
		088282004R KIT LAMELLE E RIVETTI OM.0430 0457 10394	
		3014008701R KIT RICAMBIO COPPA POST. MEDIA VERT CARB	
		307762801R KIT TAPPO X OMOL. EVO2 N. 32B GPSTY	
		308287711R KIT COPPA POST.M.VERT.D.54 EV.2+LUNG	
		409117R KIT RIVESTIMENTO MED CARB 100X115 L=300	
		206721R KIT RIC TARGHETTA LEOVINCE CARBONIO	
		414205R KIT RICAMBI LANA HT 800 Plus 850g	
<b>14237S</b>	TRIUMPH	SPEED TRIPLE 1050 R/S	2016-2017 Leovince FACTORY S - SLIP-ON - STAINLESS STEEL
<b>RICAMBI</b>		308448501R KIT fascetta FR2 CARBONIO MEDIA	
		3014237202R KIT SACCHETT COLLETTORE N.1185	
		300045530R KIT fascetta 45 Inox	
		308514601R KIT SACCH. MINUT.TRIUMPH 1050 '11	
		303949001R KIT RIC MOLLA-GOMM. ANTIVIB. CORTA	
		308421481R KIT R CO DX IN C D54 L=270 10057/8 10395	
		088421026R KIT LAMELLE E RIVETTI OM.10057-58 10395	
		308420701R KIT RICAMBIO COPPA POST. DX FACT CARB	
		308421801R KIT TAPPO X OMOL. EVO2 N. 52 FACTORY -R	
		308421741R KIT COPPA POST.DX VERT. FACTORY-R Ø50	
		088421046R KIT RIC RIVESTIMENTO FACTORY INOX L=270	
		416797R KIT RICAMBIO LANA FACTORY L=270	
<b>14238S</b>	TRIUMPH	SPEED TRIPLE 1050 R/S	2016-2017 Leovince FACTORY S - SLIP-ON - CARBON FIBER
<b>RICAMBI</b>		308448501R KIT fascetta FR2 CARBONIO MEDIA	
		3014237202R KIT SACCHETT COLLETTORE N.1185	
		300045530R KIT fascetta 45 Inox	
		308514601R KIT SACCH. MINUT.TRIUMPH 1050 '11	
		303949001R KIT RIC MOLLA-GOMM. ANTIVIB. CORTA	
		308420481R KIT R CO DX CAR D54 L=270 10057/8 10395	
		088421026R KIT LAMELLE E RIVETTI OM.10057-58 10395	
		308420701R KIT RICAMBIO COPPA POST. DX FACT CARB	
		308421801R KIT TAPPO X OMOL. EVO2 N. 52 FACTORY -R	
		308421741R KIT COPPA POST.DX VERT. FACTORY-R Ø50	
		088420002R KIT RIC RIVESTIMENTO FACT 270mm CARB	
		416797R KIT RICAMBIO LANA FACTORY L=270	
		206721R KIT RIC TARGHETTA LEOVINCE CARBONIO	

ART.	MARCA	MODELLO	2018-	Leovince	TIPOLOGIA
14239S	KAWASAKI	NINJA 400	2018-	Leovince	FACTORY S - FULL SYSTEM 2/1 - STAINLESS STEEL
RICAMBI	308448501R	KIT fascetta FR2 CARBONIO MEDIA			
	3014239561R	KIT SACC STAF CARB KAWA NINJA 400 FULL S			
	3014239203R	KIT SACCHETTO COLLETTORI PRIMARI			
	204524R	KIT RIC FLANGIA INOX 107 A DIS.165/04			
	206435R	KIT BOCCOLA INOX 38X35,7X27 DIS.MF161			
	3014239205R	KIT SACCHETTO COLLETTORE FINALE 2/1			
	3014239601R	KIT SACC MIN FULL SYS KAWASAKI NINJA 400			
	5683	KIT TAPPO SONDA LAMBDA M12 RACING + GUA			
	303949001R	KIT RIC MOLLA-GOMM. ANTIVIB. CORTA			
	308437481R	KIT R CO DX CAR CO D50 270 10057/8 10401			
	088421022R	KIT LAMELLE E RIVETTI OM.10057-58 10401			
	308420701R	KIT RICAMBIO COPPA POST. DX FACT CARB			
	308421801R	KIT TAPPO X OMOL. EVO2 N. 52 FACTORY -R			
	308421741R	KIT COPPA POST.DX VERT. FACTORY-R Ø50			
	088421046R	KIT RIC RIVESTIMENTO FACTORY INOX L=270			
	416797R	KIT RICAMBIO LANA FACTORY L=270			
14240S	KAWASAKI	NINJA 400	2018-	Leovince	FACTORY S - FULL SYSTEM 2/1 - CARBON FIBER
RICAMBI	308448501R	KIT fascetta FR2 CARBONIO MEDIA			
	3014239561R	KIT SACC STAF CARB KAWA NINJA 400 FULL S			
	3014239203R	KIT SACCHETTO COLLETTORI PRIMARI			
	204524R	KIT RIC FLANGIA INOX 107 A DIS.165/04			
	206435R	KIT BOCCOLA INOX 38X35,7X27 DIS.MF161			
	3014239205R	KIT SACCHETTO COLLETTORE FINALE 2/1			
	3014239601R	KIT SACC MIN FULL SYS KAWASAKI NINJA 400			
	5683	KIT TAPPO SONDA LAMBDA M12 RACING + GUA			
	303949001R	KIT RIC MOLLA-GOMM. ANTIVIB. CORTA			
	308436481R	KIT R CORPO DX C Ø50 L270 O10057/8 10401			
	088421022R	KIT LAMELLE E RIVETTI OM.10057-58 10401			
	308420701R	KIT RICAMBIO COPPA POST. DX FACT CARB			
	308421801R	KIT TAPPO X OMOL. EVO2 N. 52 FACTORY -R			
	308421741R	KIT COPPA POST.DX VERT. FACTORY-R Ø50			
	088420002R	KIT RIC RIVESTIMENTO FACT 270mm CARB			
	416797R	KIT RICAMBIO LANA FACTORY L=270			
	206721R	KIT RIC TARGHETTA LEOVINCE CARBONIO			
14241S	BMW	S 1000 XR (fits with original panniers)	2017-2018	Leovince	FACTORY S - SLIP-ON - STAINLESS STEEL
RICAMBI	308444501R	KIT fascetta FR3 CARBONIO PICCOLA			
	3014140202R	KIT SACCHETTO COLLETTORE BIFOR. N.1083			
	3014140001R	KIT SACC CARTER CAR BMW S1000XR '15/'16			
	3014140601R	KIT SACCH. MINUT.BMW S1000XR '15/'16			
	300035530R	KIT fascetta 35 Inox			
	300053530R	KIT fascetta 53 Inox			
	303949001R	KIT RIC MOLLA-GOMM. ANTIVIB. CORTA			
	308421481R	KIT R CO DX IN C D54 L=270 10057/8 10395			
	088421026R	KIT LAMELLE E RIVETTI OM.10057-58 10395			
	308420701R	KIT RICAMBIO COPPA POST. DX FACT CARB			
	308421801R	KIT TAPPO X OMOL. EVO2 N. 52 FACTORY -R			
	308421741R	KIT COPPA POST.DX VERT. FACTORY-R Ø50			
	088421046R	KIT RIC RIVESTIMENTO FACTORY INOX L=270			
	416797R	KIT RICAMBIO LANA FACTORY L=270			
14242S	BMW	S 1000 XR (fits with original panniers)	2017-2018	Leovince	FACTORY S - SLIP-ON - CARBON FIBER
RICAMBI	308444501R	KIT fascetta FR3 CARBONIO PICCOLA			
	3014140202R	KIT SACCHETTO COLLETTORE BIFOR. N.1083			
	3014140001R	KIT SACC CARTER CAR BMW S1000XR '15/'16			
	3014140601R	KIT SACCH. MINUT.BMW S1000XR '15/'16			
	300035530R	KIT fascetta 35 Inox			
	300053530R	KIT fascetta 53 Inox			
	303949001R	KIT RIC MOLLA-GOMM. ANTIVIB. CORTA			
	308420481R	KIT R CO DX CAR D54 L=270 10057/8 10395			
	088421026R	KIT LAMELLE E RIVETTI OM.10057-58 10395			

ART.	MARCA	MODELLO	TIPOLOGIA
		308420701R 308421801R 308421741R 088420002R 416797R 206721R	KIT RICAMBIO COPPA POST. DX FACT CARB KIT TAPPO X OMOL. EVO2 N. 52 FACTORY -R KIT COPPA POST.DX VERT. FACTORY-R Ø50 KIT RIC RIVESTIMENTO FACT 270mm CARB KIT RICAMBIO LANA FACTORY L=270 KIT RIC TARGHETTA LEOVINCE CARBONIO
<b>14243S</b>	YAMAHA	YZF 1000 R1/M	2017-2018 Leovince FACTORY S - SLIP-ON - STAINLESS STEEL
<b>RICAMBI</b>		308444501R 3014243561R 3014243601R 300053530R 3014243481R 0814243002R 308420701R 308421801R 308421741R 088421046R 416797R	KIT fascetta FR3 CARBONIO PICCOLA KIT SACC STAFFA CARBONIO YAMAHA YZF-R1 KIT SACC MIN YAMAHA YZF-R1 '17 KIT fascetta 53 Inox KIT CORP FACT S DX D60 L270 INOX OM10424 KIT LAMELLE E RIVETTI OM. 10424 59/60 KIT RICAMBIO COPPA POST. DX FACT CARB KIT TAPPO X OMOL. EVO2 N. 52 FACTORY -R KIT COPPA POST.DX VERT. FACTORY-R Ø50 KIT RIC RIVESTIMENTO FACTORY INOX L=270 KIT RICAMBIO LANA FACTORY L=270
<b>14244S</b>	YAMAHA	YZF 1000 R1/M	2017-2018 Leovince FACTORY S - SLIP-ON - CARBON FIBER
<b>RICAMBI</b>		308444501R 3014243561R 3014243601R 300053530R 3014244481R 0814243002R 308420701R 308421801R 308421741R 088420002R 416797R 206721R	KIT fascetta FR3 CARBONIO PICCOLA KIT SACC STAFFA CARBONIO YAMAHA YZF-R1 KIT SACC MIN YAMAHA YZF-R1 '17 KIT fascetta 53 Inox KIT CORP FACT S DX D60 L270 CORP OM10424 KIT LAMELLE E RIVETTI OM. 10424 59/60 KIT RICAMBIO COPPA POST. DX FACT CARB KIT TAPPO X OMOL. EVO2 N. 52 FACTORY -R KIT COPPA POST.DX VERT. FACTORY-R Ø50 KIT RIC RIVESTIMENTO FACT 270mm CARB KIT RICAMBIO LANA FACTORY L=270 KIT RIC TARGHETTA LEOVINCE CARBONIO
<b>14245EK</b>	HONDA	CB 125 R	2018- Leovince LV ONE EVO - FULL SYSTEM 1/1 - STAINLESS STEEL
<b>RICAMBI</b>		306958505R 3014228802R 3014245204R 3014245601R 3014245561R 206442R 206443R 303949001R 308574001R 3014228481R 0814228003R 308266701R 204790R 3014228701R 088406004R 414205R	KIT FASCETTA FM1S CARB. FACT. MED KIT TAPPO X OMOL. EVO2 N.59 KIT SACCHETTO COLLETTORE N.1197 KIT SACCHET MINUTERIA HONDA CB 125 R '18 KIT SACCHET STAFFA INOX HONDA CB 125 R KIT BOCCOLA INOX CB/CBR 125 DIS.MF168 KIT FLANGIA INOX 304 SP.5MM DIS.MF169 KIT RIC MOLLA-GOMM. ANTIVIB. CORTA KIT RIC MOLLA TRAZ SUPER CORTA + TUBETTO KIT R COR EVO IN D50 MED L=270 OM.10423 KIT LAMELLE E RIVETTI OM.0429-30 10423 KIT COPPA CARB.ORIZ. FACT.SOTTOSELLA KIT RIC GOMMINO COPPE CARBONIO D.007/06 KIT COP.POST ORIZZ./VERTIC. Ø50 SOTTOSEL KIT RIC RIVESTIMENTO FACT.DX MEDIO L=270 KIT RICAMBI LANA HT 800 Plus 850g
<b>14245E</b>	HONDA	CB 125 R	2018- Leovince LV ONE EVO - FULL SYSTEM 1/1 - STAINLESS STEEL
<b>RICAMBI</b>		306958505R 3014228802R 3014245202R 3014245601R 3014245561R 206442R 206443R 303949001R 308574001R 3014228481R	KIT FASCETTA FM1S CARB. FACT. MED KIT TAPPO X OMOL. EVO2 N.59 KIT SACCHETT COLLETTORE N.1196 KIT SACCHET MINUTERIA HONDA CB 125 R '18 KIT SACCHET STAFFA INOX HONDA CB 125 R KIT BOCCOLA INOX CB/CBR 125 DIS.MF168 KIT FLANGIA INOX 304 SP.5MM DIS.MF169 KIT RIC MOLLA-GOMM. ANTIVIB. CORTA KIT RIC MOLLA TRAZ SUPER CORTA + TUBETTO KIT R COR EVO IN D50 MED L=270 OM.10423

ART.	MARCA	MODELLO	TIPOLOGIA
		0814228003R 308266701R 204790R 3014228701R 088406004R 414205R	KIT LAMELLE E RIVETTI OM.0429-30 10423 KIT COPPA CARB.ORIZ. FACT.SOTTOSELLA KIT RIC GOMMINO COPPE CARBONIO D.007/06 KIT COP.POST ORIZZ./VERTIC. Ø50 SOTTOSEL KIT RIC RIVESTIMENTO FACT.DX MEDIO L=270 KIT RICAMBI LANA HT 800 Plus 850g
<b>14246EK</b>	HONDA	CB 125 R	2018- Leovince LV ONE EVO - FULL SYSTEM 1/1 - CARBON FIBER
RICAMBI		306958505R 3014228802R 3014245204R 3014245601R 3014245561R 206442R 206443R 303949001R 308574001R 3014229481R 0814228003R 308266701R 204790R 3014228701R 088407002R 414205R 206721R	KIT FASCETTA FM1S CARB. FACT. MED KIT TAPPO X OMOL. EVO2 N.59 KIT SACCHETTO COLLETTORE N.1197 KIT SACCHET MINUTERIA HONDA CB 125 R '18 KIT SACCHET STAFFA INOX HONDA CB 125 R KIT BOCCOLA INOX CB/CBR 125 DIS.MF168 KIT FLANGIA INOX 304 SP.5MM DIS.MF169 KIT RIC MOLLA-GOMM. ANTIVIB. CORTA KIT RIC MOLLA TRAZ SUPER CORTA + TUBETTO KIT R COR EV CAR D50 MED L=270 OM.10423 KIT LAMELLE E RIVETTI OM.0429-30 10423 KIT COPPA CARB.ORIZ. FACT.SOTTOSELLA KIT RIC GOMMINO COPPE CARBONIO D.007/06 KIT COP.POST ORIZZ./VERTIC. Ø50 SOTTOSEL KIT RIC RIVESTIMENTO FACTORY MEDIO L=270 KIT RICAMBI LANA HT 800 Plus 850g KIT RIC TARGHETTA LEOVINCE CARBONIO
<b>14246E</b>	HONDA	CB 125 R	2018- Leovince LV ONE EVO - FULL SYSTEM 1/1 - CARBON FIBER
RICAMBI		306958505R 3014228802R 3014245202R 3014245601R 3014245561R 206442R 206443R 303949001R 308574001R 3014229481R 0814228003R 308266701R 204790R 3014228701R 088407002R 414205R 206721R	KIT FASCETTA FM1S CARB. FACT. MED KIT TAPPO X OMOL. EVO2 N.59 KIT SACCHET COLLETTORE N.1196 KIT SACCHET MINUTERIA HONDA CB 125 R '18 KIT SACCHET STAFFA INOX HONDA CB 125 R KIT BOCCOLA INOX CB/CBR 125 DIS.MF168 KIT FLANGIA INOX 304 SP.5MM DIS.MF169 KIT RIC MOLLA-GOMM. ANTIVIB. CORTA KIT RIC MOLLA TRAZ SUPER CORTA + TUBETTO KIT R COR EV CAR D50 MED L=270 OM.10423 KIT LAMELLE E RIVETTI OM.0429-30 10423 KIT COPPA CARB.ORIZ. FACT.SOTTOSELLA KIT RIC GOMMINO COPPE CARBONIO D.007/06 KIT COP.POST ORIZZ./VERTIC. Ø50 SOTTOSEL KIT RIC RIVESTIMENTO FACTORY MEDIO L=270 KIT RICAMBI LANA HT 800 Plus 850g KIT RIC TARGHETTA LEOVINCE CARBONIO
<b>14247S</b>	YAMAHA	YZF-R6	2017-2018 Leovince FACTORY S - SLIP-ON - STAINLESS STEEL
RICAMBI		308448501R 3014247202R 3014226561R 3014247601R 300049530R 303949001R 308437481R 088421022R 308420701R 308437801R 308421741R 088421046R 416797R	KIT fascetta FR2 CARBONIO MEDIA KIT SACCHETTO COLLETTORE N.1199 KIT SACCH STAFFA ALL YAMAHA YZF-R6 '18 KIT SACCHET MINUTERIA YAMAHA YZF R6 '18 KIT fascetta 49 Inox KIT RIC MOLLA-GOMM. ANTIVIB. CORTA KIT R CO DX CAR CO D50 270 10057/8 10401 KIT LAMELLE E RIVETTI OM.10057-58 10401 KIT RICAMBIO COPPA POST. DX FACT CARB KIT TAPPO dB-KILLER N. 52B FACTORY R KIT COPPA POST.DX VERT. FACTORY-R Ø50 KIT RIC RIVESTIMENTO FACTORY INOX L=270 KIT RICAMBIO LANA FACTORY L=270
<b>14248S</b>	YAMAHA	YZF-R6	2017-2018 Leovince FACTORY S - SLIP-ON - CARBON FIBER
RICAMBI		308448501R 3014247202R	KIT fascetta FR2 CARBONIO MEDIA KIT SACCHETTO COLLETTORE N.1199



ART.	MARCA	MODELLO	TIPOLOGIA
		3014226561R KIT SACCH STAFFA ALL YAMAHA YZF-R6 '18	
		3014247601R KIT SACCHETT MINUTERIA YAMAHA YZF R6 '18	
		300049530R KIT fascetta 49 Inox	
		303949001R KIT RIC MOLLA-GOMM. ANTIVIB. CORTA	
		308436481R KIT R CORPO DX C Ø50 L270 O10057/8 10401	
		088421022R KIT LAMELLE E RIVETTI OM.10057-58 10401	
		308420701R KIT RICAMBIO COPPA POST. DX FACT CARB	
		308437801R KIT TAPPO dB-KILLER N. 52B FACTORY R	
		308421741R KIT COPPA POST.DX VERT. FACTORY-R Ø50	
		088420002R KIT RIC RIVESTIMENTO FACT 270mm CARB	
		416797R KIT RICAMBIO LANA FACTORY L=270	
		206721R KIT RIC TARGHETTA LEOVINCE CARBONIO	
<b>14249S</b>	HONDA	CB 1000 R	2018- Leovince FACTORY S - SLIP-ON - STAINLESS STEEL
RICAMBI		308444501R KIT fascetta FR3 CARBONIO PICCOLA	
		3014249202R KIT SACCHETTO COLLETTORE N.1204	
		3014249601R KIT SACCHETT MINUTER HONDA CB 1000 R '18	
		300051530R KIT fascetta 51 Inox	
		303949001R KIT RIC MOLLA-GOMM. ANTIVIB. CORTA	
		308437481R KIT R CO DX CAR CO D50 270 10057/8 10401	
		088421022R KIT LAMELLE E RIVETTI OM.10057-58 10401	
		308420701R KIT RICAMBIO COPPA POST. DX FACT CARB	
		308437801R KIT TAPPO dB-KILLER N. 52B FACTORY R	
		308437741R KIT COPPA POST.DX VERT. FACTORY-R Ø50	
		088421046R KIT RIC RIVESTIMENTO FACTORY INOX L=270	
		416797R KIT RICAMBIO LANA FACTORY L=270	
<b>14250S</b>	HONDA	CB 1000 R	2018- Leovince FACTORY S - SLIP-ON - CARBON FIBER
RICAMBI		308444501R KIT fascetta FR3 CARBONIO PICCOLA	
		3014249202R KIT SACCHETTO COLLETTORE N.1204	
		3014249601R KIT SACCHETT MINUTER HONDA CB 1000 R '18	
		300051530R KIT fascetta 51 Inox	
		303949001R KIT RIC MOLLA-GOMM. ANTIVIB. CORTA	
		308436481R KIT R CORPO DX C Ø50 L270 O10057/8 10401	
		088421022R KIT LAMELLE E RIVETTI OM.10057-58 10401	
		308420701R KIT RICAMBIO COPPA POST. DX FACT CARB	
		308437801R KIT TAPPO dB-KILLER N. 52B FACTORY R	
		308437741R KIT COPPA POST.DX VERT. FACTORY-R Ø50	
		088420002R KIT RIC RIVESTIMENTO FACT 270mm CARB	
		416797R KIT RICAMBIO LANA FACTORY L=270	
		206721R KIT RIC TARGHETTA LEOVINCE CARBONIO	
<b>14251EK</b>	YAMAHA	MT-07 (also fits 35Kw version)	2017-2018 Leovince LV ONE EVO - FULL SYSTEM 2/1 - STAINLESS STEEL
	YAMAHA	MT-07 TRACER (also fits 35Kw version)	2016-2018
	YAMAHA	XSR 700 (also fits 35Kw version)	2016-2018
RICAMBI		306958505R KIT FASCETTA FM1S CARB. FACT. MED	
		3014228802R KIT TAPPO X OMOL. EVO2 N.59	
		3014030205R KIT SACCHETTO COLLETTORE PRIMARIO XSR700	
		3014251204R KIT SACCHETTO BIFORC 2/1 CON BOMB CAT	
		3014251601R KIT SACCHETTO MINUTERIA YAMAHA MT 07 '18	
		3014251561R KIT SACCHETT STAFFA INOX YAMAHA MT 07	
		204448R KIT RIC FLANGIA INOX 46 D DIS.086/04	
		204870R KIT RICAMBIO BOCCOLA INOX DIS.094/06	
		303949001R KIT RIC MOLLA-GOMM. ANTIVIB. CORTA	
		3014228481R KIT R COR EVO IN D50 MED L=270 OM.10423	
		0814228003R KIT LAMELLE E RIVETTI OM.0429-30 10423	
		308266701R KIT COPPA CARB.ORIZ. FACT.SOTTOSELLA	
		204790R KIT RIC GOMMINO COPPE CARBONIO D.007/06	
		3014228701R KIT COP.POST ORIZZ./VERTIC. Ø50 SOTTOSEL	
		088406004R KIT RIC RIVESTIMENTO FACT.DX MEDIO L=270	
		414205R KIT RICAMBI LANA HT 800 Plus 850g	

ART.	MARCA	MODELLO		TIPOLOGIA
14251E	YAMAHA	MT-07 (also fits 35Kw version)	2017-2018	Leovince LV ONE EVO - FULL SYSTEM 2/1 - STAINLESS STEEL
	YAMAHA	MT-07 TRACER (also fits 35Kw version)	2016-2018	
	YAMAHA	XSR 700 (also fits 35Kw version)	2016-2018	
RICAMBI	3014251802R	KIT RIC TAPPO N.61		
	306958505R	KIT FASCETTA FM1S CARB. FACT. MED		
	3014228802R	KIT TAPPO X OMOL. EVO2 N.59		
	3014030205R	KIT SACCHETTO COLLETTORE PRIMARIO XSR700		
	3014251202R	KIT SACCHETTO BIFORCAZIONE 2/1 CON BOMB		
	3014251601R	KIT SACCHETTO MINUTERIA YAMAHA MT 07 '18		
	3014251561R	KIT SACCHET STAFFA INOX YAMAHA MT 07		
	204448R	KIT RIC FLANGIA INOX 46 D DIS.086/04		
	204870R	KIT RICAMBIO BOCCOLA INOX DIS.094/06		
	303949001R	KIT RIC MOLLA-GOMM. ANTIVIB. CORTA		
	3014228481R	KIT R COR EVO IN D50 MED L=270 OM.10423		
	0814228003R	KIT LAMELLE E RIVETTI OM.0429-30 10423		
	308266701R	KIT COPPA CARB.ORIZ. FACT.SOTTOSELLA		
	204790R	KIT RIC GOMMINO COPPE CARBONIO D.007/06		
	3014228701R	KIT COP.POST ORIZZ./VERTIC. Ø50 SOTTOSEL		
088406004R	KIT RIC RIVESTIMENTO FACT.DX MEDIO L=270			
414205R	KIT RICAMBI LANA HT 800 Plus 850g			
14252EK	YAMAHA	MT-07 (also fits 35Kw version)	2017-2018	Leovince LV ONE EVO - FULL SYSTEM 2/1 - CARBON FIBER
	YAMAHA	MT-07 TRACER (also fits 35Kw version)	2016-2018	
	YAMAHA	XSR 700 (also fits 35Kw version)	2016-2018	
RICAMBI	306958505R	KIT FASCETTA FM1S CARB. FACT. MED		
	3014228802R	KIT TAPPO X OMOL. EVO2 N.59		
	3014030205R	KIT SACCHETTO COLLETTORE PRIMARIO XSR700		
	3014251204R	KIT SACCHETTO BIFORC 2/1 CON BOMB CAT		
	3014251601R	KIT SACCHETTO MINUTERIA YAMAHA MT 07 '18		
	3014251561R	KIT SACCHET STAFFA INOX YAMAHA MT 07		
	204448R	KIT RIC FLANGIA INOX 46 D DIS.086/04		
	204870R	KIT RICAMBIO BOCCOLA INOX DIS.094/06		
	303949001R	KIT RIC MOLLA-GOMM. ANTIVIB. CORTA		
	3014229481R	KIT R COR EV CAR D50 MED L=270 OM.10423		
	0814228003R	KIT LAMELLE E RIVETTI OM.0429-30 10423		
	308266701R	KIT COPPA CARB.ORIZ. FACT.SOTTOSELLA		
	204790R	KIT RIC GOMMINO COPPE CARBONIO D.007/06		
	3014228701R	KIT COP.POST ORIZZ./VERTIC. Ø50 SOTTOSEL		
	088407002R	KIT RIC RIVESTIMENTO FACTORY MEDIO L=270		
414205R	KIT RICAMBI LANA HT 800 Plus 850g			
206721R	KIT RIC TARGHETTA LEOVINCE CARBONIO			
14252E	YAMAHA	MT-07 (also fits 35Kw version)	2017-2018	Leovince LV ONE EVO - FULL SYSTEM 2/1 - CARBON FIBER
	YAMAHA	MT-07 TRACER (also fits 35Kw version)	2016-2018	
	YAMAHA	XSR 700 (also fits 35Kw version)	2016-2018	
RICAMBI	3014251802R	KIT RIC TAPPO N.61		
	306958505R	KIT FASCETTA FM1S CARB. FACT. MED		
	3014228802R	KIT TAPPO X OMOL. EVO2 N.59		
	3014030205R	KIT SACCHETTO COLLETTORE PRIMARIO XSR700		
	3014251202R	KIT SACCHETTO BIFORCAZIONE 2/1 CON BOMB		
	3014251601R	KIT SACCHETTO MINUTERIA YAMAHA MT 07 '18		
	3014251561R	KIT SACCHET STAFFA INOX YAMAHA MT 07		
	204448R	KIT RIC FLANGIA INOX 46 D DIS.086/04		
	204870R	KIT RICAMBIO BOCCOLA INOX DIS.094/06		
	303949001R	KIT RIC MOLLA-GOMM. ANTIVIB. CORTA		
	3014229481R	KIT R COR EV CAR D50 MED L=270 OM.10423		
	0814228003R	KIT LAMELLE E RIVETTI OM.0429-30 10423		
	308266701R	KIT COPPA CARB.ORIZ. FACT.SOTTOSELLA		
	204790R	KIT RIC GOMMINO COPPE CARBONIO D.007/06		
	3014228701R	KIT COP.POST ORIZZ./VERTIC. Ø50 SOTTOSEL		
088407002R	KIT RIC RIVESTIMENTO FACTORY MEDIO L=270			
414205R	KIT RICAMBI LANA HT 800 Plus 850g			
206721R	KIT RIC TARGHETTA LEOVINCE CARBONIO			

ART.	MARCA	MODELLO		TIPOLOGIA
14257E	YAMAHA	MT-03	2018-	Leovince LV PRO - SLIP-ON - STAINLESS STEEL
	YAMAHA	YZF-R3	2018-	
RICAMBI	307572505R	KIT fascetta FM4S Fact. Medio		
	3014124202R	KIT SACCHETTO COLLETTORE N.1074		
	3014124601R	KIT SACCH. MINUT. YAMAHA YZF MT25 R25 R3		
	206414R	KIT RIC BOCCOLA LGR/F 40X31,7XH30		
	300041530R	KIT fascetta 41 Inox		
	303949001R	KIT RIC MOLLA-GOMM. ANTIVIB. CORTA		
	3014124481R	KIT R C PRO DX I50 COR L=180 10074 10393		
	088442008R	KIT LAMELLE E RIVETTI O. 10074-10393		
	308494701R	KIT RIC COPPA CAR.VERT.FACT.SOTTOSELLA		
	308437801R	KIT TAPPO dB-KILLER N. 52B FACTORY R		
	3014124741R	KIT COPPA POST VERTICALE Ø50 SOTTOSELLA		
	0814124004R	KIT RIC RIVESTIMENTO DX MEDIO L180 NO BA		
	414205R	KIT RICAMBI LANA HT 800 Plus 850g		
14258E	YAMAHA	MT-03	2018-	Leovince LV PRO - SLIP-ON - CARBON FIBER
	YAMAHA	YZF-R3	2018-	
RICAMBI	307572505R	KIT fascetta FM4S Fact. Medio		
	3014124202R	KIT SACCHETTO COLLETTORE N.1074		
	3014124601R	KIT SACCH. MINUT. YAMAHA YZF MT25 R25 R3		
	206414R	KIT RIC BOCCOLA LGR/F 40X31,7XH30		
	300041530R	KIT fascetta 41 Inox		
	303949001R	KIT RIC MOLLA-GOMM. ANTIVIB. CORTA		
	3014124482R	KIT R C PRO DX C50 COR L=180 10074 10393		
	088442010R	KIT LAMELLE E RIVETTI O. 10074-10393		
	308494701R	KIT RIC COPPA CAR.VERT.FACT.SOTTOSELLA		
	308437801R	KIT TAPPO dB-KILLER N. 52B FACTORY R		
	3014124741R	KIT COPPA POST VERTICALE Ø50 SOTTOSELLA		
	088442006R	KIT RIC RIVESTIMENTO MEDIO CARB L=180mm		
	414205R	KIT RICAMBI LANA HT 800 Plus 850g		
	206733R	KIT RIC TARGHETTA LEOVINCE CARB LV PRO		
15000K	MOTO GUZZI	V7 III / STONE / SPECIAL / ANNIVERSARIO	2017-2018	Leovince CLASSIC RACER - 2 SLIP-ON - STAINLESS STEEL
RICAMBI	3015000206R	KIT SACCH COLLETTORE N.1148 APP		
	3015000208R	KIT SACCH COLLETTORE N.1149 APP		
	3015000561R	KIT SACCHET STAFFA INOX SX GUZZI V7		
	3015000562R	KIT SACCHET STAFFA INOX DX GUZZI V7		
	3015000601R	KIT SACCHETTO MINUTERIA GUZZI V7 STONE		
	205087R	KIT RIC BOCCOLA 41.4X38X40 LGR/F D050/07		
	300043530R	KIT fascetta 43 Inox		
	303949001R	KIT RIC MOLLA-GOMM. ANTIVIB. CORTA		
	3015000481R	KIT R CORPO DX CL RAC IN D50 L=380 10392		
	0815000008R	KIT CONO DX CL RACER INOX Ø50 L=380mm		
	3015000701R	KIT RIC COPPA POST DX INOX SCOTCH BRITE		
	303457802R	KIT SACCHETTO TAPPO Ø25mm X SILENZ. CUB		
	3015000482R	KIT R CORPO SX CL RAC IN D50 L=380 10392		
	0815000009R	KIT CONO SX CL RACER INOX Ø50 L=380mm		
	3015000702R	KIT RIC COPPA POST SX INOX SCOTCH BRITE		
	414205R	KIT RICAMBI LANA HT 800 Plus 850g		
15000	MOTO GUZZI	V7 III / STONE / SPECIAL / ANNIVERSARIO	2017-2018	Leovince CLASSIC RACER - 2 SLIP-ON - STAINLESS STEEL
RICAMBI	3015000202R	KIT SACCHETTO COLLETTORE N.1146		
	3015000204R	KIT SACCHETTO COLLETTORE N.1147		
	3015000561R	KIT SACCHET STAFFA INOX SX GUZZI V7		
	3015000562R	KIT SACCHET STAFFA INOX DX GUZZI V7		
	3015000601R	KIT SACCHETTO MINUTERIA GUZZI V7 STONE		
	205087R	KIT RIC BOCCOLA 41.4X38X40 LGR/F D050/07		
	300043530R	KIT fascetta 43 Inox		
	303949001R	KIT RIC MOLLA-GOMM. ANTIVIB. CORTA		
	3015000481R	KIT R CORPO DX CL RAC IN D50 L=380 10392		
	0815000008R	KIT CONO DX CL RACER INOX Ø50 L=380mm		
	3015000701R	KIT RIC COPPA POST DX INOX SCOTCH BRITE		

ART.	MARCA	MODELLO	TIPOLOGIA
		303457802R KIT SACCHETTO TAPPO Ø25mm X SILENZ. CUB 3015000482R KIT R CORPO SX CL RAC IN D50 L=380 10392 0815000009R KIT CONO SX CL RACER INOX Ø50 L=380mm 3015000702R KIT RIC COPPA POST SX INOX SCOTCH BRITE 414205R KIT RICAMBI LANA HT 800 Plus 850g	
<b>15002</b>	TRIUMPH	BONNEVILLE T100	2016-2017 Leovince CLASSIC RACER - 2 SLIP-ON - STAINLESS STEEL
<b>RICAMBI</b>		3015002202R KIT SACCHETTO COLLETTORE N.1118 3015002204R KIT SACCHETTO COLLETTORE N.1119 3015002561R KIT SACCHET STAFFA INOX SX TRI B T100 3015002562R KIT SACCHET STAFFA INOX DX TRI B T100 3015002601R KIT SACCHETTO MINUT TRIUMPH BON T100 205290R KIT RIC BOCCOLA 38X32X30 LGR/F D.089/08 300041530R KIT fascetta 41 Inox 308574001R KIT RIC MOLLA TRAZ SUPER CORTA + TUBETTO 3015000481R KIT R CORPO DX CL RAC IN D50 L=380 10392 0815000008R KIT CONO DX CL RACER INOX Ø50 L=380mm 3015000701R KIT RIC COPPA POST DX INOX SCOTCH BRITE 303457802R KIT SACCHETTO TAPPO Ø25mm X SILENZ. CUB 3015000482R KIT R CORPO SX CL RAC IN D50 L=380 10392 0815000009R KIT CONO SX CL RACER INOX Ø50 L=380mm 3015000702R KIT RIC COPPA POST SX INOX SCOTCH BRITE 414205R KIT RICAMBI LANA HT 800 Plus 850g	
<b>15003</b>	TRIUMPH	BONNEVILLE T120	2016-2017 Leovince CLASSIC RACER - 2 SLIP-ON - STAINLESS STEEL
<b>RICAMBI</b>		3015002202R KIT SACCHETTO COLLETTORE N.1118 3015003202R KIT SACCHETTO COLLETTORE N.1134 3015003561R KIT SACCHET STAFFA INOX SX TRI B T120 3015003562R KIT SACCHET STAFFA INOX DX TRI B T120 3015003563R KIT SACCHET STAFFA INOX TRI BON T120 3015003601R KIT SACCHETTO MINUT TRIUMPH BON T120 205290R KIT RIC BOCCOLA 38X32X30 LGR/F D.089/08 300041530R KIT fascetta 41 Inox 308574001R KIT RIC MOLLA TRAZ SUPER CORTA + TUBETTO 3015000481R KIT R CORPO DX CL RAC IN D50 L=380 10392 0815000008R KIT CONO DX CL RACER INOX Ø50 L=380mm 3015000701R KIT RIC COPPA POST DX INOX SCOTCH BRITE 303457802R KIT SACCHETTO TAPPO Ø25mm X SILENZ. CUB 3015000482R KIT R CORPO SX CL RAC IN D50 L=380 10392 0815000009R KIT CONO SX CL RACER INOX Ø50 L=380mm 3015000702R KIT RIC COPPA POST SX INOX SCOTCH BRITE 414205R KIT RICAMBI LANA HT 800 Plus 850g	
<b>15004</b>	TRIUMPH	STREET TWIN	2016-2017 Leovince CLASSIC RACER - 2 SLIP-ON - STAINLESS STEEL
<b>RICAMBI</b>		3015004202R KIT SACCHETTO COLLETTORE N.1135 3015004204R KIT SACCHETTO COLLETTORE N.1136 3015004561R KIT SACCHET STAFFA INOX SX TRI ST TW 900 3015004562R KIT SACCHET STAFFA INOX DX TRI ST TW 900 3015004601R KIT SACCHETTO MINUT TRIUMPH STR TW 900 206363R KIT RIC BOCCOLA 42,6X38,6X30 LGR/F MD92 300045530R KIT fascetta 45 Inox 303949001R KIT RIC MOLLA-GOMM. ANTIVIB. CORTA 3015000481R KIT R CORPO DX CL RAC IN D50 L=380 10392 0815000008R KIT CONO DX CL RACER INOX Ø50 L=380mm 3015000701R KIT RIC COPPA POST DX INOX SCOTCH BRITE 303457802R KIT SACCHETTO TAPPO Ø25mm X SILENZ. CUB 3015000482R KIT R CORPO SX CL RAC IN D50 L=380 10392 0815000009R KIT CONO SX CL RACER INOX Ø50 L=380mm 3015000702R KIT RIC COPPA POST SX INOX SCOTCH BRITE 414205R KIT RICAMBI LANA HT 800 Plus 850g	

ART.	MARCA	MODELLO		TIPOLOGIA
15005	TRIUMPH	THRUXTON water cooled	2016-2017	Leovince CLASSIC RACER - 2 SLIP-ON - STAINLESS STEEL
RICAMBI	3015005202R	KIT SACCHETTO COLLETTORE N.1116		
	3015005204R	KIT SACCHETTO COLLETTORE N.1117		
	3015005561R	KIT SACCHET STAFFA INOX TRIUM THRU 1200		
	3015005601R	KIT SACCHETTO MINUT TRIUMPH THRUX 1200		
	206363R	KIT RIC BOCCOLA 42,6X38,6X30 LGR/F MD92		
	300045530R	KIT fascetta 45 Inox		
	303949001R	KIT RIC MOLLA-GOMM. ANTIVIB. CORTA		
	3015000481R	KIT R CORPO DX CL RAC IN D50 L=380 10392		
	0815000008R	KIT CONO DX CL RACER INOX Ø50 L=380mm		
	3015000701R	KIT RIC COPPA POST DX INOX SCOTCH BRITE		
	303457802R	KIT SACCHETTO TAPPO Ø25mm X SILENZ. CUB		
	3015000482R	KIT R CORPO SX CL RAC IN D50 L=380 10392		
	0815000009R	KIT CONO SX CL RACER INOX Ø50 L=380mm		
	3015000702R	KIT RIC COPPA POST SX INOX SCOTCH BRITE		
	414205R	KIT RICAMBI LANA HT 800 Plus 850g		
15100	BMW	R NINE T	2014-2016	Leovince GP DUALS - SLIP-ON - STAINLESS STEEL
RICAMBI	3015100202R	KIT SACCHETTO COLLETTORE N.1108		
	3015101561R	KIT SACCHET STAFFA IN VN COLL CORPI LV9		
	3015100561R	KIT SACCHET STAFFA INOX VN BMW R NINE		
	3015100601R	KIT SACCHETTO MINUT BMW R NINE '14/ '16		
	303949001	MOLLA TRAZ.KTM+TUBETTO MONTATO		
	300065530R	KIT fascetta 65 Inox		
	3015100483R	KIT R CORPO SX SUP GPDUALS IN D.50 L=290		
	0815100007R	KIT CONO SX SUP GP DUALS INOX Ø50 L=290		
	3015100702R	KIT RIC COPPA POSTERIORE SX INOX		
	303457803R	KIT TAPPO xSILENZIATORI VN CUB d.25mm		
	3015100484R	KIT R COR SX INF GPDUA IN D50 L290 10390		
	0815100009R	KIT CONO INFERIORE GPDUALS INOX Ø50 L290		
	414205R	KIT RICAMBI LANA HT 800 Plus 850g		
15101K	DUCATI	SCRAMBLER 800 ICON/CLASSIC	2015-2016	Leovince GP DUALS - SLIP-ON - STAINLESS STEEL
RICAMBI	3015101207R	KIT SACCHETTO COLLETTORE N.1104		
	3015101206R	KIT SACCHETTO COLLETTORE N.1103		
	3015101561R	KIT SACCHET STAFFA IN VN COLL CORPI LV9		
	3015101562R	KIT SACCHET STAFFA INOX VN DUCATI SCA800		
	3015101601R	KIT SACCHETTO MINUT DUCATI SCAM 800 '16		
	303949001	MOLLA TRAZ.KTM+TUBETTO MONTATO		
	3015100481R	KIT R CORPO DX SUP GPDUALS IN D.50 L=290		
	0815100008R	KIT CONO DX SUP GP DUALS INOX Ø50 L=290		
	3015100701R	KIT RIC COPPA POSTERIORE DX INOX		
	303457803R	KIT TAPPO xSILENZIATORI VN CUB d.25mm		
	3015100482R	KIT R COR DX INF GPDUA IN D50 L290 10390		
	0815100009R	KIT CONO INFERIORE GPDUALS INOX Ø50 L290		
	414205R	KIT RICAMBI LANA HT 800 Plus 850g		
15101	DUCATI	SCRAMBLER 800 ICON/CLASSIC	2015-2016	Leovince GP DUALS - SLIP-ON - STAINLESS STEEL
RICAMBI	3015101205R	KIT SACCHETTO COLLETTORE N.1102		
	3015101206R	KIT SACCHETTO COLLETTORE N.1103		
	3015101561R	KIT SACCHET STAFFA IN VN COLL CORPI LV9		
	3015101562R	KIT SACCHET STAFFA INOX VN DUCATI SCA800		
	3015101601R	KIT SACCHETTO MINUT DUCATI SCAM 800 '16		
	303949001	MOLLA TRAZ.KTM+TUBETTO MONTATO		
	3015100481R	KIT R CORPO DX SUP GPDUALS IN D.50 L=290		
	0815100008R	KIT CONO DX SUP GP DUALS INOX Ø50 L=290		
	3015100701R	KIT RIC COPPA POSTERIORE DX INOX		
	303457803R	KIT TAPPO xSILENZIATORI VN CUB d.25mm		
	3015100482R	KIT R COR DX INF GPDUA IN D50 L290 10390		
	0815100009R	KIT CONO INFERIORE GPDUALS INOX Ø50 L290		
	414205R	KIT RICAMBI LANA HT 800 Plus 850g		

ART.	MARCA	MODELLO	TIPOLOGIA
15101US	DUCATI	SCRAMBLER 800 ICON/CLASSIC	2015-2016 Leovince GP DUALS - SLIP-ON - STAINLESS STEEL
RICAMBI	3015101208R	KIT SACCHETTO COLLETTORE N.1105	
	3015101561R	KIT SACCHET STAFFA IN VN COLL CORPI LV9	
	3015101562R	KIT SACCHET STAFFA INOX VN DUCATI SCA800	
	3015101601R	KIT SACCHETTO MINUT DUCATI SCAM 800 '16	
	303949001	MOLLA TRAZ.KTM+TUBETTO MONTATO	
	3015100481R	KIT R CORPO DX SUP GPDUALS IN D.50 L=290	
	0815100008R	KIT CONO DX SUP GP DUALS INOX Ø50 L=290	
	3015100701R	KIT RIC COPPA POSTERIORE DX INOX	
	303457803R	KIT TAPPO xSILENZIATORI VN CUB d.25mm	
	3015100482R	KIT R COR DX INF GPDUA IN D50 L290 10390	
	0815100009R	KIT CONO INFERIORE GPDUALS INOX Ø50 L290	
	414205R	KIT RICAMBI LANA HT 800 Plus 850g	
15102	HONDA	CB 500 F (fits with original centre stand)	2016-2018 Leovince GP DUALS - SLIP-ON - STAINLESS STEEL
	HONDA	CBR 500 R	2016-2018
	HONDA	CB 500 X (fits with original centre stand)	2017-2018
RICAMBI	3015102202R	KIT SACCHETTO COLLETTORE N.1151	
	3015101561R	KIT SACCHET STAFFA IN VN COLL CORPI LV9	
	3015102561R	KIT SACCHET STAFFA ALL VN HONDA CB/R 500	
	3015102601R	KIT SACCHETTO MINUT HONDA CB/R 500 F '17	
	300045530R	KIT fascetta 45 Inox	
	303949001	MOLLA TRAZ.KTM+TUBETTO MONTATO	
	3015110481R	KIT R CORPO DX SUP GPDUALS IN D.50 L=290	
	0815100008R	KIT CONO DX SUP GP DUALS INOX Ø50 L=290	
	3015103701R	KIT RIC COPPA POSTERIORE DX INOX	
	303430803R	KIT TAPPO xSILENZIATORI VN CUB d.22mm	
	3015108482R	KIT R COR DX INF GPDUA IN D50 L290 10390	
	0815100009R	KIT CONO INFERIORE GPDUALS INOX Ø50 L290	
	414205R	KIT RICAMBI LANA HT 800 Plus 850g	
15103	KAWASAKI	Z 800	2013-2016 Leovince GP DUALS - SLIP-ON - STAINLESS STEEL
RICAMBI	3015103202R	KIT SACCHETTO COLLETTORE N.1106	
	3015101561R	KIT SACCHET STAFFA IN VN COLL CORPI LV9	
	3015103561R	KIT SACCHET STAFFA INOX VN KAWASAKI Z800	
	3015103601R	KIT SACCHETTO MINUT KAWASAKI Z800 '16	
	303949001	MOLLA TRAZ.KTM+TUBETTO MONTATO	
	3015110481R	KIT R CORPO DX SUP GPDUALS IN D.50 L=290	
	0815100008R	KIT CONO DX SUP GP DUALS INOX Ø50 L=290	
	3015103701R	KIT RIC COPPA POSTERIORE DX INOX	
	303430803R	KIT TAPPO xSILENZIATORI VN CUB d.22mm	
	3015108482R	KIT R COR DX INF GPDUA IN D50 L290 10390	
	0815100009R	KIT CONO INFERIORE GPDUALS INOX Ø50 L290	
	414205R	KIT RICAMBI LANA HT 800 Plus 850g	
15104	KAWASAKI	Z 800 E	2013-2016 Leovince GP DUALS - SLIP-ON - STAINLESS STEEL
RICAMBI	3015104202R	KIT SACCHETTO COLLETTORE N.1107	
	3015101561R	KIT SACCHET STAFFA IN VN COLL CORPI LV9	
	3015103561R	KIT SACCHET STAFFA INOX VN KAWASAKI Z800	
	3015104601R	KIT SACCHETTO MINUT KAWASAKI Z800E '16	
	303949001	MOLLA TRAZ.KTM+TUBETTO MONTATO	
	3015110481R	KIT R CORPO DX SUP GPDUALS IN D.50 L=290	
	0815100008R	KIT CONO DX SUP GP DUALS INOX Ø50 L=290	
	3015103701R	KIT RIC COPPA POSTERIORE DX INOX	
	303430803R	KIT TAPPO xSILENZIATORI VN CUB d.22mm	
	3015108482R	KIT R COR DX INF GPDUA IN D50 L290 10390	
	0815100009R	KIT CONO INFERIORE GPDUALS INOX Ø50 L290	
	414205R	KIT RICAMBI LANA HT 800 Plus 850g	
15105	SUZUKI	SV 650/ABS	2016-2018 Leovince GP DUALS - SLIP-ON - STAINLESS STEEL
	SUZUKI	SV 650 X ABS	2018-
RICAMBI	3015105202R	KIT SACCHETTO COLLETTORE N.1110	
	3015101561R	KIT SACCHET STAFFA IN VN COLL CORPI LV9	
	3015105561R	KIT SACCHET STAFFA INOX VN SUZUKI SV650	

ART.	MARCA	MODELLO	TIPOLOGIA
		3015105601R KIT SACCHETTO MINUT SUZUKI SV650 '16	
		303949001 MOLLA TRAZ.KTM+TUBETTO MONTATO	
		204999R KIT RIC BOCCOLA 45X38X30 LGR/F D.026/07	
		300049530R KIT fascetta 49 Inox	
		3015105481R KIT R CORPO DX SUP GPDUALS IN D.50 L=290	
		0815100008R KIT CONO DX SUP GP DUALS INOX Ø50 L=290	
		3015100701R KIT RIC COPPA POSTERIORE DX INOX	
		303430803R KIT TAPPO xSILENZIATORI VN CUB d.22mm	
		3015105482R KIT R COR DX INF GPDUA IN D50 L290 10390	
		0815100009R KIT CONO INFERIORE GPDUALS INOX Ø50 L290	
		414205R KIT RICAMBI LANA HT 800 Plus 850g	
<b>15106</b>	SUZUKI	GSR/GSX-S 750	2011-2016 Leovince GP DUALS - SLIP-ON - STAINLESS STEEL
	SUZUKI	GSX-S 750/Z ABS (US model only)	2015-2017
	SUZUKI	GSX-S 750/Z ABS	2017-2018
<b>RICAMBI</b>		3015106202R KIT SACCHETTO COLLETTORE N.1125	
		3015101561R KIT SACCHET STAFFA IN VN COLL CORPI LV9	
		3015106561R KIT SACCH STAFFA INOX VN SUZ GSX-S 750	
		3015106601R KIT SACCHET MINUTERIA SUZUKI GSX-S 750	
		300045530R KIT fascetta 45 Inox	
		303949001 MOLLA TRAZ.KTM+TUBETTO MONTATO	
		3015110481R KIT R CORPO DX SUP GPDUALS IN D.50 L=290	
		0815100008R KIT CONO DX SUP GP DUALS INOX Ø50 L=290	
		3015103701R KIT RIC COPPA POSTERIORE DX INOX	
		303430803R KIT TAPPO xSILENZIATORI VN CUB d.22mm	
		3015108482R KIT R COR DX INF GPDUA IN D50 L290 10390	
		0815100009R KIT CONO INFERIORE GPDUALS INOX Ø50 L290	
		414205R KIT RICAMBI LANA HT 800 Plus 850g	
<b>15107K</b>	YAMAHA	MT-07/FZ-07/ABS	2014-2016 Leovince GP DUALS - FULL SYSTEM 2/1 - STAINLESS STEEL
	YAMAHA	MT-07/FZ-07/ABS	2017-2018
<b>RICAMBI</b>		3014030205R KIT SACCHETTO COLLETTORE PRIMARIO XSR700	
		204569R KIT RIC FLANGIA INOX 112 A DIS.195/04	
		204833R KIT RIC BOCCOLA INOX DIS.028/06	
		3014030206R KIT SACCHETTO COLLETTORE BIFORCA XSR 700	
		5684 KIT TAPPO Sonda LAMBDA M12 BASE + GUARN	
		3015107204R KIT SACCH COLLETT FINALE YAM MT07 XSR700	
		3015101561R KIT SACCHET STAFFA IN VN COLL CORPI LV9	
		3015107561R KIT RIC SACCHETTO STAFFA ALL VN YAM MT07	
		3015107601R KIT SACCHETTO MINUT YAMAHA MT07 XSR700	
		303949001 MOLLA TRAZ.KTM+TUBETTO MONTATO	
		308574001R KIT RIC MOLLA TRAZ SUPER CORTA + TUBETTO	
		3015110481R KIT R CORPO DX SUP GPDUALS IN D.50 L=290	
		0815100008R KIT CONO DX SUP GP DUALS INOX Ø50 L=290	
		3015103701R KIT RIC COPPA POSTERIORE DX INOX	
		303430803R KIT TAPPO xSILENZIATORI VN CUB d.22mm	
		3015108482R KIT R COR DX INF GPDUA IN D50 L290 10390	
		0815100009R KIT CONO INFERIORE GPDUALS INOX Ø50 L290	
		414205R KIT RICAMBI LANA HT 800 Plus 850g	
<b>15107</b>	YAMAHA	MT-07/FZ-07/ABS	2014-2016 Leovince GP DUALS - FULL SYSTEM 2/1 - STAINLESS STEEL
	YAMAHA	MT-07/FZ-07/ABS	2017-2018
<b>RICAMBI</b>		3014030205R KIT SACCHETTO COLLETTORE PRIMARIO XSR700	
		204569R KIT RIC FLANGIA INOX 112 A DIS.195/04	
		204833R KIT RIC BOCCOLA INOX DIS.028/06	
		3014030206R KIT SACCHETTO COLLETTORE BIFORCA XSR 700	
		5684 KIT TAPPO Sonda LAMBDA M12 BASE + GUARN	
		3015107202R KIT SACCH COLLETT FINALE YAM MT07 XSR700	
		3015101561R KIT SACCHET STAFFA IN VN COLL CORPI LV9	
		3015107561R KIT RIC SACCHETTO STAFFA ALL VN YAM MT07	
		3015107601R KIT SACCHETTO MINUT YAMAHA MT07 XSR700	
		303949001 MOLLA TRAZ.KTM+TUBETTO MONTATO	
		308574001R KIT RIC MOLLA TRAZ SUPER CORTA + TUBETTO	
		3015110481R KIT R CORPO DX SUP GPDUALS IN D.50 L=290	

ART.	MARCA	MODELLO		TIPOLOGIA
		0815100008R 3015103701R 303430803R 3015108482R 0815100009R 414205R	KIT CONO DX SUP GP DUALS INOX Ø50 L=290 KIT RIC COPPA POSTERIORE DX INOX KIT TAPPO xSILENZIATORI VN CUB d.22mm KIT R COR DX INF GPDUA IN D50 L290 10390 KIT CONO INFERIORE GPDUALS INOX Ø50 L290 KIT RICAMBI LANA HT 800 Plus 850g	
<b>15108K</b>	YAMAHA	MT-09/FZ-09/ABS	2013-2016	Leovince GP DUALS - FULL SYSTEM 3/1 - STAINLESS STEEL
	YAMAHA	MT-09/FZ-09/ABS	2017-2018	
	YAMAHA	XSR 900 ABS	2016-2018	
<b>RICAMBI</b>		3014032206R 204448R 204870R 3014032207R 5682 3015110204R 3015101561R 3015110561R 3015110601R 303949001 3015110481R 0815100008R 3015103701R 303430803R 3015108482R 0815100009R 414205R	KIT SACCHETTO COLLETTORE PRIMARIO XSR900 KIT RIC FLANGIA INOX 46 D DIS.086/04 KIT RICAMBIO BOCCOLA INOX DIS.094/06 KIT SACCHETTO TRIFO FINAL YAMAHA XSR900 KIT TAPPO SONDA LAMBDA M18 BASE + GUARN KIT SACCHET COLLETTORE FINALE XSR900 APP KIT SACCHET STAFFA IN VN COLL CORPI LV9 KIT SACCHET STAFFA ALL VN YAM XSR900 '16 KIT SACCHETTO MINUT YAMA XSR900 '16 MOLLA TRAZ.KTM+TUBETTO MONTATO KIT R CORPO DX SUP GPDUALS IN D.50 L=290 KIT CONO DX SUP GP DUALS INOX Ø50 L=290 KIT RIC COPPA POSTERIORE DX INOX KIT TAPPO xSILENZIATORI VN CUB d.22mm KIT R COR DX INF GPDUA IN D50 L290 10390 KIT CONO INFERIORE GPDUALS INOX Ø50 L290 KIT RICAMBI LANA HT 800 Plus 850g	
<b>15108</b>	YAMAHA	MT-09/FZ-09/ABS	2013-2016	Leovince GP DUALS - FULL SYSTEM 3/1 - STAINLESS STEEL
	YAMAHA	MT-09/FZ-09/ABS	2017-2018	
	YAMAHA	XSR 900 ABS	2016-2018	
<b>RICAMBI</b>		3014032206R 204448R 204870R 3014032207R 5682 3015110202R 3015101561R 3015110561R 3015110601R 303949001 3015110481R 0815100008R 3015103701R 303430803R 3015108482R 0815100009R 414205R	KIT SACCHETTO COLLETTORE PRIMARIO XSR900 KIT RIC FLANGIA INOX 46 D DIS.086/04 KIT RICAMBIO BOCCOLA INOX DIS.094/06 KIT SACCHETTO TRIFO FINAL YAMAHA XSR900 KIT TAPPO SONDA LAMBDA M18 BASE + GUARN KIT SACCHETTO COLLETTORE FINALE XSR 900 KIT SACCHET STAFFA IN VN COLL CORPI LV9 KIT SACCHET STAFFA ALL VN YAM XSR900 '16 KIT SACCHETTO MINUT YAMA XSR900 '16 MOLLA TRAZ.KTM+TUBETTO MONTATO KIT R CORPO DX SUP GPDUALS IN D.50 L=290 KIT CONO DX SUP GP DUALS INOX Ø50 L=290 KIT RIC COPPA POSTERIORE DX INOX KIT TAPPO xSILENZIATORI VN CUB d.22mm KIT R COR DX INF GPDUA IN D50 L290 10390 KIT CONO INFERIORE GPDUALS INOX Ø50 L290 KIT RICAMBI LANA HT 800 Plus 850g	
<b>15108US</b>	YAMAHA	MT-09/FZ-09/ABS	2013-2016	Leovince GP DUALS - FULL SYSTEM 3/1 - STAINLESS STEEL
	YAMAHA	MT-09/FZ-09/ABS	2017-2018	
	YAMAHA	XSR 900 ABS	2016-2018	
<b>RICAMBI</b>		3014032206R 204448R 204870R 3014032207R 5682 3015110206R 3015101561R 3015110561R 3015110602R 303949001 3015110481R 0815100008R	KIT SACCHETTO COLLETTORE PRIMARIO XSR900 KIT RIC FLANGIA INOX 46 D DIS.086/04 KIT RICAMBIO BOCCOLA INOX DIS.094/06 KIT SACCHETTO TRIFO FINAL YAMAHA XSR900 KIT TAPPO SONDA LAMBDA M18 BASE + GUARN KIT SACCHET COLLETTORE FINALE XSR900 RAC KIT SACCHET STAFFA IN VN COLL CORPI LV9 KIT SACCHET STAFFA ALL VN YAM XSR900 '16 KIT SACCHETTO MINUT YAMA XSR900 RAC '16 MOLLA TRAZ.KTM+TUBETTO MONTATO KIT R CORPO DX SUP GPDUALS IN D.50 L=290 KIT CONO DX SUP GP DUALS INOX Ø50 L=290	



ART.	MARCA	MODELLO		TIPOLOGIA
		3015103701R 303430803R 3015108482R 0815100009R 414205R	KIT RIC COPPA POSTERIORE DX INOX KIT TAPPO xSILENZIATORI VN CUB d.22mm KIT R COR DX INF GPDUA IN D50 L290 10390 KIT CONO INFERIORE GPDUALS INOX Ø50 L290 KIT RICAMBI LANA HT 800 Plus 850g	
<b>15109K</b>	YAMAHA	XSR 700 ABS	2016-2018	Leovince GP DUALS - FULL SYSTEM 2/1 - STAINLESS STEEL
RICAMBI		3014030205R 204569R 204833R 3014030206R 5684 3015107204R 3015101561R 3015109561R 3015107601R 303949001 308574001R 3015110481R 0815100008R 3015103701R 303430803R 3015108482R 0815100009R 414205R	KIT SACCHETTO COLLETTORE PRIMARIO XSR700 KIT RIC FLANGIA INOX 112 A DIS.195/04 KIT RIC BOCCOLA INOX DIS.028/06 KIT SACCHETTO COLLETTORE BIFORCA XSR 700 KIT TAPPO SONDA LAMBDA M12 BASE + GUARN KIT SACCH COLLETT FINALE YAM MT07 XSR700 KIT SACCHET STAFFA IN VN COLL CORPI LV9 KIT RIC SACCH STAFFA ALL VN YAM XSR700 KIT SACCHETTO MINUT YAMAHA MT07 XSR700 MOLLA TRAZ.KTM+TUBETTO MONTATO KIT RIC MOLLA TRAZ SUPER CORTA + TUBETTO KIT R CORPO DX SUP GPDUALS IN D.50 L=290 KIT CONO DX SUP GP DUALS INOX Ø50 L=290 KIT RIC COPPA POSTERIORE DX INOX KIT TAPPO xSILENZIATORI VN CUB d.22mm KIT R COR DX INF GPDUA IN D50 L290 10390 KIT CONO INFERIORE GPDUALS INOX Ø50 L290 KIT RICAMBI LANA HT 800 Plus 850g	
<b>15109</b>	YAMAHA	XSR 700 ABS	2016-2018	Leovince GP DUALS - FULL SYSTEM 2/1 - STAINLESS STEEL
RICAMBI		3014030205R 204569R 204833R 3014030206R 5684 3015107202R 3015101561R 3015109561R 3015107601R 303949001 308574001R 3015110481R 0815100008R 3015103701R 303430803R 3015108482R 0815100009R 414205R	KIT SACCHETTO COLLETTORE PRIMARIO XSR700 KIT RIC FLANGIA INOX 112 A DIS.195/04 KIT RIC BOCCOLA INOX DIS.028/06 KIT SACCHETTO COLLETTORE BIFORCA XSR 700 KIT TAPPO SONDA LAMBDA M12 BASE + GUARN KIT SACCH COLLETT FINALE YAM MT07 XSR700 KIT SACCHET STAFFA IN VN COLL CORPI LV9 KIT RIC SACCH STAFFA ALL VN YAM XSR700 KIT SACCHETTO MINUT YAMAHA MT07 XSR700 MOLLA TRAZ.KTM+TUBETTO MONTATO KIT RIC MOLLA TRAZ SUPER CORTA + TUBETTO KIT R CORPO DX SUP GPDUALS IN D.50 L=290 KIT CONO DX SUP GP DUALS INOX Ø50 L=290 KIT RIC COPPA POSTERIORE DX INOX KIT TAPPO xSILENZIATORI VN CUB d.22mm KIT R COR DX INF GPDUA IN D50 L290 10390 KIT CONO INFERIORE GPDUALS INOX Ø50 L290 KIT RICAMBI LANA HT 800 Plus 850g	
<b>15112</b>	BMW	R NINE T (HIGH)	2014-2016	Leovince GP DUALS - SLIP-ON - STAINLESS STEEL
RICAMBI		3015112202R 3015101561R 3015112561R 307299001R 3015112601R 303949001 300065530R 3015100483R 0815100007R 3015100702R 303457803R 3015100484R 0815100009R 414205R	KIT SACCHETTO COLLETTORE N.1109 KIT SACCHET STAFFA IN VN COLL CORPI LV9 KIT SACCHET STAFFA INOX VN BMW R NINE-T KIT SACC CARTER CARB DUCATI 999/999S '05 KIT SACCHETTO MINUT BMW R NINE-T 14/ 16 MOLLA TRAZ.KTM+TUBETTO MONTATO KIT fascetta 65 Inox KIT R CORPO SX SUP GPDUALS IN D.50 L=290 KIT CONO SX SUP GP DUALS INOX Ø50 L=290 KIT RIC COPPA POSTERIORE SX INOX KIT TAPPO xSILENZIATORI VN CUB d.25mm KIT R COR SX INF GPDUA IN D50 L290 10390 KIT CONO INFERIORE GPDUALS INOX Ø50 L290 KIT RICAMBI LANA HT 800 Plus 850g	
<b>15113K</b>	KAWASAKI	NINJA 650	2017-2018	Leovince GP DUALS - FULL SYSTEM 2/1 - STAINLESS STEEL
	KAWASAKI	Z 650	2017-2018	

ART.	MARCA	MODELLO	TIPOLOGIA
RICAMBI	308579204R 206060R 206061R 3015113206R 5683 3015113204R 3015101561R 3015113561R 3015113601R 303949001 3015110481R 0815100008R 3015103701R 303430803R 3015108482R 0815100009R 414205R	KIT RICAMBI COLLETTORI PRIMARI ER-6N-F KIT RIC BOCCOLA INOX 41X33X25.5 D.031/12 KIT RIC FLANGIA INOX 158 A DIS.032/12 KIT SACCHETTO COLL SECOND KA NJ Z650 APP KIT TAPPO Sonda LAMBDA M12 RACING + GUA KIT SACCHETTO COLLETT FINALE KA NJ Z650 KIT SACCHET STAFFA IN VN COLL CORPI LV9 KIT SACCHET STAFFA ALL VN KAW Z650 NJ650 KIT SACCHETTO MINUT KAWA Z650 NJ 650 MOLLA TRAZ.KTM+TUBETTO MONTATO KIT R CORPO DX SUP GPDUALS IN D.50 L=290 KIT CONO DX SUP GP DUALS INOX Ø50 L=290 KIT RIC COPPA POSTERIORE DX INOX KIT TAPPO xSILENZIATORI VN CUB d.22mm KIT R COR DX INF GPDUA IN D50 L290 10390 KIT CONO INFERIORE GPDUALS INOX Ø50 L290 KIT RICAMBI LANA HT 800 Plus 850g	
15113	KAWASAKI	NINJA 650	2017-2018 Leovince GP DUALS - FULL SYSTEM 2/1 - STAINLESS STEEL
	KAWASAKI	Z 650	2017-2018
RICAMBI	308579204R 206060R 206061R 3015113202R 5683 3015113204R 3015101561R 3015113561R 3015113601R 303949001 3015110481R 0815100008R 3015103701R 303430803R 3015108482R 0815100009R 414205R	KIT RICAMBI COLLETTORI PRIMARI ER-6N-F KIT RIC BOCCOLA INOX 41X33X25.5 D.031/12 KIT RIC FLANGIA INOX 158 A DIS.032/12 KIT SACCHETTO COLLETT SECOND KA NJ Z650 KIT TAPPO Sonda LAMBDA M12 RACING + GUA KIT SACCHETTO COLLETT FINALE KA NJ Z650 KIT SACCHET STAFFA IN VN COLL CORPI LV9 KIT SACCHET STAFFA ALL VN KAW Z650 NJ650 KIT SACCHETTO MINUT KAWA Z650 NJ 650 MOLLA TRAZ.KTM+TUBETTO MONTATO KIT R CORPO DX SUP GPDUALS IN D.50 L=290 KIT CONO DX SUP GP DUALS INOX Ø50 L=290 KIT RIC COPPA POSTERIORE DX INOX KIT TAPPO xSILENZIATORI VN CUB d.22mm KIT R COR DX INF GPDUA IN D50 L290 10390 KIT CONO INFERIORE GPDUALS INOX Ø50 L290 KIT RICAMBI LANA HT 800 Plus 850g	
15114	KAWASAKI	Z 900 (also fits 35Kw & 70Kw versions)	2017-2018 Leovince GP DUALS - SLIP-ON - STAINLESS STEEL
RICAMBI	3015114202R 3015101561R 3015114561R 3015114601R 300053530R 303949001 3015110481R 0815100008R 3015103701R 303430803R 3015108482R 0815100009R 414205R	KIT SACCHETTO COLLETTORE N.1111 KIT SACCHET STAFFA IN VN COLL CORPI LV9 KIT SACCHET STAFFA INOX VN KAWA Z900 '17 KIT SACCHET MINUTERIA KAWASAKI Z900 '17 KIT fascetta 53 Inox MOLLA TRAZ.KTM+TUBETTO MONTATO KIT R CORPO DX SUP GPDUALS IN D.50 L=290 KIT CONO DX SUP GP DUALS INOX Ø50 L=290 KIT RIC COPPA POSTERIORE DX INOX KIT TAPPO xSILENZIATORI VN CUB d.22mm KIT R COR DX INF GPDUA IN D50 L290 10390 KIT CONO INFERIORE GPDUALS INOX Ø50 L290 KIT RICAMBI LANA HT 800 Plus 850g	
15116	KTM	DUKE 125	2017-2018 Leovince GP ONE - SLIP-ON - STAINLESS STEEL
	KTM	RC 125	2017-2018
	KTM	DUKE 390	2017-2018
	KTM	RC 390	2017-2018
RICAMBI	3015116202R 3015116561R 3015116601R 204980R 303949001 3015116481R 0815100008R	KIT SACCHETTO COLLETTORE N.1123 KIT SACCHETTO STAFFA INOX VN KTM RC DUKE KIT SACCHETTO MINUT KTM RC DUKE 125/390 KIT GUARNIZIONE 57x25x1 LGR/F D.008/07 MOLLA TRAZ.KTM+TUBETTO MONTATO KIT R CORPO SU GP ONE IN D50 L=290 10402 KIT CONO DX SUP GP DUALS INOX Ø50 L=290	

ART.	MARCA	MODELLO	TIPOLOGIA
		3015103701R KIT RIC COPPA POSTERIORE DX INOX	
		303430803R KIT TAPPO xSILENZIATORI VN CUB d.22mm	
		414205R KIT RICAMBI LANA HT 800 Plus 850g	
<b>15117K</b>	DUCATI	SCRAMBLER 800 DESERT SLED	2017-2018 Leovince GP DUALS - SLIP-ON - STAINLESS STEEL
RICAMBI		3015101207R KIT SACCHETTO COLLETTORE N.1104	
		3015101206R KIT SACCHETTO COLLETTORE N.1103	
		3015101561R KIT SACCHET STAFFA IN VN COLL CORPI LV9	
		3015117561R KIT SACCHET STAFFA PREALL VN DUC SCAMBLE	
		3015117562R KIT SACCHET STAFFA PREALL VN DUC SCAMBLE	
		3015117601R KIT SACCHETTO MINUT DUCATI SCAMBLER DES	
		303949001 MOLLA TRAZ.KTM+TUBETTO MONTATO	
		3015110481R KIT R CORPO DX SUP GPDUALS IN D.50 L=290	
		0815100008R KIT CONO DX SUP GP DUALS INOX Ø50 L=290	
		3015103701R KIT RIC COPPA POSTERIORE DX INOX	
		303430803R KIT TAPPO xSILENZIATORI VN CUB d.22mm	
		3015108482R KIT R COR DX INF GPDUA IN D50 L290 10390	
		0815100009R KIT CONO INFERIORE GPDUALS INOX Ø50 L290	
		414205R KIT RICAMBI LANA HT 800 Plus 850g	
<b>15117</b>	DUCATI	SCRAMBLER 800 DESERT SLED	2017-2018 Leovince GP DUALS - SLIP-ON - STAINLESS STEEL
RICAMBI		3015101205R KIT SACCHETTO COLLETTORE N.1102	
		3015101206R KIT SACCHETTO COLLETTORE N.1103	
		3015101561R KIT SACCHET STAFFA IN VN COLL CORPI LV9	
		3015117561R KIT SACCHET STAFFA PREALL VN DUC SCAMBLE	
		3015117562R KIT SACCHET STAFFA PREALL VN DUC SCAMBLE	
		3015117601R KIT SACCHETTO MINUT DUCATI SCAMBLER DES	
		303949001 MOLLA TRAZ.KTM+TUBETTO MONTATO	
		3015110481R KIT R CORPO DX SUP GPDUALS IN D.50 L=290	
		0815100008R KIT CONO DX SUP GP DUALS INOX Ø50 L=290	
		3015103701R KIT RIC COPPA POSTERIORE DX INOX	
		303430803R KIT TAPPO xSILENZIATORI VN CUB d.22mm	
		3015108482R KIT R COR DX INF GPDUA IN D50 L290 10390	
		0815100009R KIT CONO INFERIORE GPDUALS INOX Ø50 L290	
		414205R KIT RICAMBI LANA HT 800 Plus 850g	
<b>15118</b>	DUCATI	SCRAMBLER 800 DESERT SLED	2017-2018 Leovince GP ONE - SLIP-ON - STAINLESS STEEL
RICAMBI		3015118202R KIT SACCHETTO COLLETTORE N.1164	
		3015118601R KIT SACCHETTO MINUT DUCATI SCAMBLER DES	
		204980R KIT GUARNIZIONE 57x25x1 LGR/F D.008/07	
		303949001 MOLLA TRAZ.KTM+TUBETTO MONTATO	
		3015116481R KIT R CORPO SU GP ONE IN D50 L=290 10402	
		0815100008R KIT CONO DX SUP GP DUALS INOX Ø50 L=290	
		3015103701R KIT RIC COPPA POSTERIORE DX INOX	
		303430803R KIT TAPPO xSILENZIATORI VN CUB d.22mm	
		414205R KIT RICAMBI LANA HT 800 Plus 850g	
<b>15119</b>	KAWASAKI	Z 900 RS/CAFE (Fits with original centre stand)	2018- Leovince GP DUALS - SLIP-ON - STAINLESS STEEL
RICAMBI		3015119202R KIT SACCHETTO COLLETTORE N.1184	
		3015101561R KIT SACCHET STAFFA IN VN COLL CORPI LV9	
		3015119561R KIT SACCHET STAFFA INOX KAWASAKI Z900 RS	
		3015119601R KIT SACCHET MINUTER KAWASAKI Z900 RS '18	
		300053530R KIT fascetta 53 Inox	
		303949001 MOLLA TRAZ.KTM+TUBETTO MONTATO	
		3015110481R KIT R CORPO DX SUP GPDUALS IN D.50 L=290	
		0815100008R KIT CONO DX SUP GP DUALS INOX Ø50 L=290	
		3015103701R KIT RIC COPPA POSTERIORE DX INOX	
		303430803R KIT TAPPO xSILENZIATORI VN CUB d.22mm	
		3015108482R KIT R COR DX INF GPDUA IN D50 L290 10390	
		0815100009R KIT CONO INFERIORE GPDUALS INOX Ø50 L290	
		414205R KIT RICAMBI LANA HT 800 Plus 850g	
<b>15120K</b>	HONDA	CB 125 R with catalystr	2018- Leovince GP ONE - FULL SYSTEM 1/1 - STAINLESS STEEL
RICAMBI		3015120204R KIT SACCHETT COLLETTORE N.1195	

ART.	MARCA	MODELLO		TIPOLOGIA
		3015120561R	KIT SACCHET STAFFA INOX HONDA CB 125 R	
		3015120601R	KIT SACCHET MINUTERIA HONDA CB 125 R '18	
		204980R	KIT GUARNIZIONE 57x25x1 LGR/F D.008/07	
		303949001	MOLLA TRAZ.KTM+TUBETTO MONTATO	
		308574001R	KIT RIC MOLLA TRAZ SUPER CORTA + TUBETTO	
		3015116481R	KIT R CORPO SU GP ONE IN D50 L=290 10402	
		0815100008R	KIT CONO DX SUP GP DUALS INOX Ø50 L=290	
		3015103701R	KIT RIC COPPA POSTERIORE DX INOX	
		303430803R	KIT TAPPO xSILENZIATORI VN CUB d.22mm	
		414205R	KIT RICAMBI LANA HT 800 Plus 850g	
		206442R	KIT BOCCOLA INOX CB/CBR 125 DIS.MF168	
		206443R	KIT FLANGIA INOX 304 SP.5MM DIS.MF169	
<b>15120</b>	HONDA	CB 125 R	2018-	Leovince GP ONE - FULL SYSTEM 1/1 - STAINLESS STEEL
<b>RICAMBI</b>		3015120202R	KIT SACCHETT COLLETTORE N.1194	
		3015120561R	KIT SACCHET STAFFA INOX HONDA CB 125 R	
		3015120601R	KIT SACCHET MINUTERIA HONDA CB 125 R '18	
		204980R	KIT GUARNIZIONE 57x25x1 LGR/F D.008/07	
		303949001	MOLLA TRAZ.KTM+TUBETTO MONTATO	
		308574001R	KIT RIC MOLLA TRAZ SUPER CORTA + TUBETTO	
		3015116481R	KIT R CORPO SU GP ONE IN D50 L=290 10402	
		0815100008R	KIT CONO DX SUP GP DUALS INOX Ø50 L=290	
		3015103701R	KIT RIC COPPA POSTERIORE DX INOX	
		303430803R	KIT TAPPO xSILENZIATORI VN CUB d.22mm	
		414205R	KIT RICAMBI LANA HT 800 Plus 850g	
		206442R	KIT BOCCOLA INOX CB/CBR 125 DIS.MF168	
		206443R	KIT FLANGIA INOX 304 SP.5MM DIS.MF169	
<b>15121</b>	HUSQVARNA	SVARTPILEN 401	2018-	Leovince GP ONE - SLIP-ON - STAINLESS STEEL
	HUSQVARNA	VITPILEN 401	2018-	
<b>RICAMBI</b>		3015121202R	KIT SACCHETTO COLLETTORE N.1189	
		3015121561R	KIT SAC STAF INO HUQVAR VITPILEN 401 '18	
		3015121601R	KIT SACC MINUT HUQVARNA VITPILEN 401 '18	
		303949001	MOLLA TRAZ.KTM+TUBETTO MONTATO	
		3015116481R	KIT R CORPO SU GP ONE IN D50 L=290 10402	
		0815100008R	KIT CONO DX SUP GP DUALS INOX Ø50 L=290	
		3015103701R	KIT RIC COPPA POSTERIORE DX INOX	
		303430803R	KIT TAPPO xSILENZIATORI VN CUB d.22mm	
		414205R	KIT RICAMBI LANA HT 800 Plus 850g	
<b>15122</b>	HUSQVARNA	VITPILEN 701	2018-	Leovince GP DUALS - SLIP-ON - STAINLESS STEEL
<b>RICAMBI</b>		3015122202R	KIT SACCHETT COLLETTORE N.1193	
		3015122601R	KIT SACC MINUT HUQVARNA VITPILEN 701 '18	
		3015101561R	KIT SACCHET STAFFA IN VN COLL CORPI LV9	
		3015122561R	KIT SACCH STAFFA ALL HUSQVA VITPILEN 701	
		303949001	MOLLA TRAZ.KTM+TUBETTO MONTATO	
		3015110481R	KIT R CORPO DX SUP GPDUALS IN D.50 L=290	
		0815100008R	KIT CONO DX SUP GP DUALS INOX Ø50 L=290	
		3015103701R	KIT RIC COPPA POSTERIORE DX INOX	
		303430803R	KIT TAPPO xSILENZIATORI VN CUB d.22mm	
		3015108482R	KIT R COR DX INF GPDUA IN D50 L290 10390	
		0815100009R	KIT CONO INFERIORE GPDUALS INOX Ø50 L290	
		414205R	KIT RICAMBI LANA HT 800 Plus 850g	
<b>15123</b>	HONDA	CB 1000 R	2018-	Leovince GP DUALS - SLIP-ON - STAINLESS STEEL
<b>RICAMBI</b>		300051530R	KIT fascetta 51 Inox	
		3015123202R	KIT SACCHETT COLLETTORE N.1202	
		3015123601R	KIT SACCHE MINUTERIA HONDA CB 1000 R '18	
		3015101561R	KIT SACCHET STAFFA IN VN COLL CORPI LV9	
		3015123561R	KIT SACCH STAFFA ALL HONDA CB 1000 R '18	
		303949001	MOLLA TRAZ.KTM+TUBETTO MONTATO	
		3015110481R	KIT R CORPO DX SUP GPDUALS IN D.50 L=290	
		303430803R	KIT TAPPO xSILENZIATORI VN CUB d.22mm	

ART.	MARCA	MODELLO	TIPOLOGIA	
		3015108482R 414205R	KIT R COR DX INF GPDUA IN D50 L290 10390 KIT RICAMBI LANA HT 800 Plus 850g	
<b>15200B</b>	KAWASAKI	ZX-10R NINJA (low & high mount)	2016-2018	Leovince LV-10 BLACK - SLIP-ON - STAINLESS STEEL
	KAWASAKI	ZX-10RR NINJA (low & high mount)	2017-2018	
<b>RICAMBI</b>		3015200202R 3015200204R 3015200601R 300053530R 303949001R 309746485R 309746701R 309746703R 309746012R 414205R	KIT SACCHETTO COLLETTORE N.1154 KIT SACCHETTO COLLETTORE N.1155 KIT SACCHETTO MINUT KAWASAKI ZX10R KIT fascetta 53 Inox KIT RIC MOLLA-GOMM. ANTIVIB. CORTA KIT RIC CORPO DX INOX Ø54 L=160 LV10 BLA KIT COPPA POSTERIORE D.54 LV10 KIT CANDELA DX L=173 LV10 d.54 INOX KIT RIC RIVESTIMENTO COMPL DX IN L160 BL KIT RICAMBI LANA HT 800 Plus 850g	
<b>15200</b>	KAWASAKI	ZX-10R NINJA (low & high mount)	2016-2018	Leovince LV-10 - SLIP-ON - STAINLESS STEEL
	KAWASAKI	ZX-10RR NINJA (low & high mount)	2017-2018	
<b>RICAMBI</b>		3015200202R 3015200204R 3015200601R 300053530R 303949001R 309746481R 309746701R 309746703R 309746010R 414205R	KIT SACCHETTO COLLETTORE N.1154 KIT SACCHETTO COLLETTORE N.1155 KIT SACCHETTO MINUT KAWASAKI ZX10R KIT fascetta 53 Inox KIT RIC MOLLA-GOMM. ANTIVIB. CORTA KIT RIC CORPO DX INOX Ø54 L=160mm LV10 KIT COPPA POSTERIORE D.54 LV10 KIT CANDELA DX L=173 LV10 d.54 INOX KIT RIC RIVESTIMENTO COMPL DX INOX L=160 KIT RICAMBI LANA HT 800 Plus 850g	
<b>15201B</b>	YAMAHA	YZF 1000 R1	2015-2016	Leovince LV-10 BLACK - SLIP-ON - STAINLESS STEEL
	YAMAHA	YZF 1000 R1	2017-2018	
<b>RICAMBI</b>		3015201601R 300057530R 303949001R 3015201485R 309746701R 3015201703R 089746011R 414205R	KIT SACC MINUTERIA YAMAHA R1 KIT fascetta 57 Inox KIT RIC MOLLA-GOMM. ANTIVIB. CORTA KIT RIC CORPO DX INOX Ø54,5 L=160 LV10 B KIT COPPA POSTERIORE D.54 LV10 KIT CANDELA DX L=173 LV10 d.54,5 INOX KIT RIVESTIMENTO DX INOX L=160mm BLACK KIT RICAMBI LANA HT 800 Plus 850g	
<b>15201</b>	YAMAHA	YZF 1000 R1	2015-2016	Leovince LV-10 - SLIP-ON - STAINLESS STEEL
	YAMAHA	YZF 1000 R1	2017-2018	
<b>RICAMBI</b>		3015201601R 300057530R 303949001R 3015201481R 309746701R 3015201703R 089746010R 414205R	KIT SACC MINUTERIA YAMAHA R1 KIT fascetta 57 Inox KIT RIC MOLLA-GOMM. ANTIVIB. CORTA KIT RIC CORPO DX INOX Ø54,5 L=160mm LV10 KIT COPPA POSTERIORE D.54 LV10 KIT CANDELA DX L=173 LV10 d.54,5 INOX KIT RIVESTIMENTO DX INOX L=160mm KIT RICAMBI LANA HT 800 Plus 850g	
<b>15202B</b>	DUCATI	SCRAMBLER 800 DESERT SLED	2017-2018	Leovince LV-10 BLACK - SLIP-ON - STAINLESS STEEL
<b>RICAMBI</b>		3015202202R 3015202601R 303949001R 309746485R 309746701R 309746703R 309746012R 414205R	KIT SACCHETTO COLLETTORE N.1163 KIT SACCHETTO MINUT DUCATI SCRAMBLER DES KIT RIC MOLLA-GOMM. ANTIVIB. CORTA KIT RIC CORPO DX INOX Ø54 L=160 LV10 BLA KIT COPPA POSTERIORE D.54 LV10 KIT CANDELA DX L=173 LV10 d.54 INOX KIT RIC RIVESTIMENTO COMPL DX IN L160 BL KIT RICAMBI LANA HT 800 Plus 850g	
<b>15202</b>	DUCATI	SCRAMBLER 800 DESERT SLED	2017-2018	Leovince LV-10 - SLIP-ON - STAINLESS STEEL
<b>RICAMBI</b>		3015202202R	KIT SACCHETTO COLLETTORE N.1163	

ART.	MARCA	MODELLO	TIPOLOGIA
		3015202601R KIT SACCHETTO MINUT DUCATI SCAMBLER DES 303949001R KIT RIC MOLLA-GOMM. ANTIVIB. CORTA 309746481R KIT RIC CORPO DX INOX Ø54 L=160mm LV10 309746701R KIT COPPA POSTERIORE D.54 LV10 309746703R KIT CANDELA DX L=173 LV10 d.54 INOX 309746010R KIT RIC RIVESTIMENTO COMPL DX INOX L=160 414205R KIT RICAMBI LANA HT 800 Plus 850g	
<b>15203B</b>	YAMAHA	MT-10/FZ-10/MTN1000	2016-2018 Leovince LV-10 BLACK - SLIP-ON - STAINLESS STEEL
	YAMAHA	MT-10 SP	2017-2018
<b>RICAMBI</b>		3015203601R KIT SACC MINUTERIA YAMAHA MT10 300057530R KIT fascetta 57 Inox 308574001R KIT RIC MOLLA TRAZ SUPER CORTA + TUBETTO 3015201485R KIT RIC CORPO DX INOX Ø54,5 L=160 LV10 B 309746701R KIT COPPA POSTERIORE D.54 LV10 3015201703R KIT CANDELA DX L=173 LV10 d.54,5 INOX 089746011R KIT RIVESTIMENTO DX INOX L=160mm BLACK 414205R KIT RICAMBI LANA HT 800 Plus 850g	
<b>15203</b>	YAMAHA	MT-10/FZ-10/MTN1000	2016-2018 Leovince LV-10 - SLIP-ON - STAINLESS STEEL
	YAMAHA	MT-10 SP	2017-2018
<b>RICAMBI</b>		3015203601R KIT SACC MINUTERIA YAMAHA MT10 300057530R KIT fascetta 57 Inox 308574001R KIT RIC MOLLA TRAZ SUPER CORTA + TUBETTO 3015201481R KIT RIC CORPO DX INOX Ø54,5 L=160mm LV10 309746701R KIT COPPA POSTERIORE D.54 LV10 3015201703R KIT CANDELA DX L=173 LV10 d.54,5 INOX 089746010R KIT RIVESTIMENTO DX INOX L=160mm 414205R KIT RICAMBI LANA HT 800 Plus 850g	
<b>15204B</b>	KAWASAKI	Z 900 (also fits 35Kw & 70Kw versions)	2017-2018 Leovince LV-10 BLACK - SLIP-ON - STAINLESS STEEL
<b>RICAMBI</b>		3015204202R KIT SACCHETTO COLLETTORE N.1157 3015204601R KIT SACC MINUTERIA KAWASAKI Z900 300053530R KIT fascetta 53 Inox 303949001R KIT RIC MOLLA-GOMM. ANTIVIB. CORTA 309746485R KIT RIC CORPO DX INOX Ø54 L=160 LV10 BLA 309746701R KIT COPPA POSTERIORE D.54 LV10 309746703R KIT CANDELA DX L=173 LV10 d.54 INOX 309746012R KIT RIC RIVESTIMENTO COMPL DX IN L160 BL 414205R KIT RICAMBI LANA HT 800 Plus 850g	
<b>15204</b>	KAWASAKI	Z 900 (also fits 35Kw & 70Kw versions)	2017-2018 Leovince LV-10 - SLIP-ON - STAINLESS STEEL
<b>RICAMBI</b>		3015204202R KIT SACCHETTO COLLETTORE N.1157 3015204601R KIT SACC MINUTERIA KAWASAKI Z900 300053530R KIT fascetta 53 Inox 303949001R KIT RIC MOLLA-GOMM. ANTIVIB. CORTA 309746481R KIT RIC CORPO DX INOX Ø54 L=160mm LV10 309746701R KIT COPPA POSTERIORE D.54 LV10 309746703R KIT CANDELA DX L=173 LV10 d.54 INOX 309746010R KIT RIC RIVESTIMENTO COMPL DX INOX L=160 414205R KIT RICAMBI LANA HT 800 Plus 850g	
<b>15205B</b>	KAWASAKI	Z 250	2015-2016 Leovince LV-10 BLACK - SLIP-ON - STAINLESS STEEL
	KAWASAKI	Z 300/ABS	2015-2016
	KAWASAKI	NINJA 250 R	2013-2016
	KAWASAKI	NINJA 300 R/ABS	2013-2016
	KAWASAKI	NINJA 300 R/ABS (US model only)	2013-2017
<b>RICAMBI</b>		3015205202R KIT SACCHETTO COLLETTORE N.1160 3015205601R KIT SACCHETTO MINUTERIA KAWASAKI Z300 300038530R KIT fascetta 38 Inox 303949001R KIT RIC MOLLA-GOMM. ANTIVIB. CORTA 309746485R KIT RIC CORPO DX INOX Ø54 L=160 LV10 BLA 309746701R KIT COPPA POSTERIORE D.54 LV10 309746703R KIT CANDELA DX L=173 LV10 d.54 INOX	

ART.	MARCA	MODELLO	TIPOLOGIA	
		309746012R 414205R	KIT RIC RIVESTIMENTO COMPL DX IN L160 BL KIT RICAMBI LANA HT 800 Plus 850g	
<b>15205</b>	KAWASAKI	Z 250	2015-2016	Leovince LV-10 - SLIP-ON - STAINLESS STEEL
	KAWASAKI	Z 300/ABS	2015-2016	
	KAWASAKI	NINJA 250 R	2013-2016	
	KAWASAKI	NINJA 300 R/ABS	2013-2016	
	KAWASAKI	NINJA 300 R/ABS (US model only)	2013-2017	
<b>RICAMBI</b>		3015205202R 3015205601R 300038530R 303949001R 309746481R 309746701R 309746703R 309746010R 414205R	KIT SACCHETTO COLLETTORE N.1160 KIT SACCHETTO MINUTERIA KAWASAKI Z300 KIT fascetta 38 Inox KIT RIC MOLLA-GOMM. ANTIVIB. CORTA KIT RIC CORPO DX INOX Ø54 L=160mm LV10 KIT COPPA POSTERIORE D.54 LV10 KIT CANDELA DX L=173 LV10 d.54 INOX KIT RIC RIVESTIMENTO COMPL DX INOX L=160 KIT RICAMBI LANA HT 800 Plus 850g	
<b>15206B</b>	DUCATI	SCRAMBLER 800 ICON/CLASSIC	2015-2016	Leovince LV-10 BLACK - SLIP-ON - STAINLESS STEEL
	DUCATI	SCRAMBLER 800 ICON/CLASSIC	2017-2018	
<b>RICAMBI</b>		3015206202R 3015206601R 303949001R 309746485R 309746701R 309746703R 309746012R 414205R	KIT SACCHETTO COLLETTORE N.1170 KIT SACCHETTO MINUT DUCATI SCAMBLER 800 KIT RIC MOLLA-GOMM. ANTIVIB. CORTA KIT RIC CORPO DX INOX Ø54 L=160 LV10 BLA KIT COPPA POSTERIORE D.54 LV10 KIT CANDELA DX L=173 LV10 d.54 INOX KIT RIC RIVESTIMENTO COMPL DX IN L160 BL KIT RICAMBI LANA HT 800 Plus 850g	
<b>15206</b>	DUCATI	SCRAMBLER 800 ICON/CLASSIC	2015-2016	Leovince LV-10 - SLIP-ON - STAINLESS STEEL
	DUCATI	SCRAMBLER 800 ICON/CLASSIC	2017-2018	
<b>RICAMBI</b>		3015206202R 3015206601R 303949001R 309746481R 309746701R 309746703R 309746010R 414205R	KIT SACCHETTO COLLETTORE N.1170 KIT SACCHETTO MINUT DUCATI SCAMBLER 800 KIT RIC MOLLA-GOMM. ANTIVIB. CORTA KIT RIC CORPO DX INOX Ø54 L=160mm LV10 KIT COPPA POSTERIORE D.54 LV10 KIT CANDELA DX L=173 LV10 d.54 INOX KIT RIC RIVESTIMENTO COMPL DX INOX L=160 KIT RICAMBI LANA HT 800 Plus 850g	
<b>15207B</b>	HONDA	CBR 1000 RR FIREBLADE/SP/SP2	2017-2018	Leovince LV-10 BLACK - SLIP-ON - STAINLESS STEEL
<b>RICAMBI</b>		3015207202R 3015207601R 3015207561R 303949001R 309746485R 309746701R 309746703R 309746012R 414205R	KIT SACCHETTO COLLETTORE N.1176 KIT SACCHETT MINUTERIA HONDA CBR 1000 RR KIT SACCHET STAFF INOX HONDA CBR 1000 RR KIT RIC MOLLA-GOMM. ANTIVIB. CORTA KIT RIC CORPO DX INOX Ø54 L=160 LV10 BLA KIT COPPA POSTERIORE D.54 LV10 KIT CANDELA DX L=173 LV10 d.54 INOX KIT RIC RIVESTIMENTO COMPL DX IN L160 BL KIT RICAMBI LANA HT 800 Plus 850g	
<b>15207</b>	HONDA	CBR 1000 RR FIREBLADE/SP/SP2	2017-2018	Leovince LV-10 - SLIP-ON - STAINLESS STEEL
<b>RICAMBI</b>		3015207202R 3015207601R 3015207561R 303949001R 309746481R 309746701R 309746703R 309746010R 414205R	KIT SACCHETTO COLLETTORE N.1176 KIT SACCHETT MINUTERIA HONDA CBR 1000 RR KIT SACCHET STAFF INOX HONDA CBR 1000 RR KIT RIC MOLLA-GOMM. ANTIVIB. CORTA KIT RIC CORPO DX INOX Ø54 L=160mm LV10 KIT COPPA POSTERIORE D.54 LV10 KIT CANDELA DX L=173 LV10 d.54 INOX KIT RIC RIVESTIMENTO COMPL DX INOX L=160 KIT RICAMBI LANA HT 800 Plus 850g	
<b>15208B</b>	HONDA	CB 500 F (do not fit with original centre stand)	2016-2016	Leovince LV-10 BLACK - SLIP-ON - STAINLESS STEEL
	HONDA	CB 500 F (do not fit with original centre stand)	2016-2018	

ART.	MARCA	MODELLO	TIPOLOGIA
	HONDA	CB 500 X (do not fit with original centre stand)	2017-2018
	HONDA	CBR 500 R	2016-2018
	HONDA	CBR 500 R	2017-2018
RICAMBI	3015208202R	KIT SACCHETTO COLLETTORE N.1175	
	3015208601R	KIT SACCHETTO MINUT HONDA CBR 500 R	
	303949001R	KIT RIC MOLLA-GOMM. ANTIVIB. CORTA	
	309746485R	KIT RIC CORPO DX INOX Ø54 L=160 LV10 BLA	
	309746701R	KIT COPPA POSTERIORE D.54 LV10	
	309746703R	KIT CANDELA DX L=173 LV10 d.54 INOX	
	309746012R	KIT RIC RIVESTIMENTO COMPL DX IN L160 BL	
	414205R	KIT RICAMBI LANA HT 800 Plus 850g	
<b>15208</b>	HONDA	CB 500 F (do not fit with original centre stand)	2016-2016 Leovince LV-10 - SLIP-ON - STAINLESS STEEL
	HONDA	CB 500 F (do not fit with original centre stand)	2016-2018
	HONDA	CB 500 X (do not fit with original centre stand)	2017-2018
	HONDA	CBR 500 R	2016-2018
	HONDA	CBR 500 R	2017-2018
RICAMBI	3015208202R	KIT SACCHETTO COLLETTORE N.1175	
	3015208601R	KIT SACCHETTO MINUT HONDA CBR 500 R	
	303949001R	KIT RIC MOLLA-GOMM. ANTIVIB. CORTA	
	309746481R	KIT RIC CORPO DX INOX Ø54 L=160mm LV10	
	309746701R	KIT COPPA POSTERIORE D.54 LV10	
	309746703R	KIT CANDELA DX L=173 LV10 d.54 INOX	
	309746010R	KIT RIC RIVESTIMENTO COMPL DX INOX L=160	
	414205R	KIT RICAMBI LANA HT 800 Plus 850g	
<b>15209B</b>	KAWASAKI	Z 1000	2010-2016 Leovince LV-10 BLACK - 2 SLIP-ON - STAINLESS STEEL
	KAWASAKI	Z 1000	2017-2018
	KAWASAKI	Z 1000 SX (do not fit with panniers)	2010-2016
	KAWASAKI	Z 1000 SX (do not fit with panniers)	2017-2018
	KAWASAKI	NINJA 1000/ABS (US model only, do not fit with panniers)	2010-2018
RICAMBI	3015209202R	KIT SACCHETTO COLLETTORE N.1171 SX	
	3015209204R	KIT SACCHETTO COLLETTORE N.1172 DX	
	3015209601R	KIT SACCHETTO MINUTERIA KAWASAKI Z1000	
	303949001R	KIT RIC MOLLA-GOMM. ANTIVIB. CORTA	
	309746485R	KIT RIC CORPO DX INOX Ø54 L=160 LV10 BLA	
	309746701R	KIT COPPA POSTERIORE D.54 LV10	
	309746703R	KIT CANDELA DX L=173 LV10 d.54 INOX	
	309746012R	KIT RIC RIVESTIMENTO COMPL DX IN L160 BL	
	3015209486R	KIT RIC CORPO SX INOX Ø54 L=160 LV10 BLA	
	309746704R	KIT CANDELA SX L=173 LV10 d.54 INOX	
	309746016R	KIT RIC RIVESTIMENTO COMPL SX IN L160 BL	
	414205R	KIT RICAMBI LANA HT 800 Plus 850g	
<b>15209</b>	KAWASAKI	Z 1000	2010-2016 Leovince LV-10 - 2 SLIP-ON - STAINLESS STEEL
	KAWASAKI	Z 1000	2017-2018
	KAWASAKI	Z 1000 SX (do not fit with panniers)	2010-2016
	KAWASAKI	Z 1000 SX (do not fit with panniers)	2017-2018
	KAWASAKI	NINJA 1000/ABS (US model only, do not fit with panniers)	2010-2018
RICAMBI	3015209202R	KIT SACCHETTO COLLETTORE N.1171 SX	
	3015209204R	KIT SACCHETTO COLLETTORE N.1172 DX	
	3015209601R	KIT SACCHETTO MINUTERIA KAWASAKI Z1000	
	303949001R	KIT RIC MOLLA-GOMM. ANTIVIB. CORTA	
	309746481R	KIT RIC CORPO DX INOX Ø54 L=160mm LV10	
	309746701R	KIT COPPA POSTERIORE D.54 LV10	
	309746703R	KIT CANDELA DX L=173 LV10 d.54 INOX	
	309746010R	KIT RIC RIVESTIMENTO COMPL DX INOX L=160	
	3015209482R	KIT RIC CORPO SX INOX Ø54 L=160mm LV10	
	309746704R	KIT CANDELA SX L=173 LV10 d.54 INOX	
	309746014R	KIT RIC RIVESTIMENTO COMPL SX INOX L=160	
	414205R	KIT RICAMBI LANA HT 800 Plus 850g	
<b>15210B</b>	HONDA	CBR 250 R	2011-2013 Leovince LV-10 BLACK - SLIP-ON - STAINLESS STEEL
RICAMBI	3015210202R	KIT SACCHETTO COLLETTORE N.1174	



ART.	MARCA	MODELLO	TIPOLOGIA
		3015210601R KIT SACCHETTO MINUT HONDA CBR 250 R 300041530R KIT fascetta 41 Inox 303949001R KIT RIC MOLLA-GOMM. ANTIVIB. CORTA 309746485R KIT RIC CORPO DX INOX Ø54 L=160 LV10 BLA 309746701R KIT COPPA POSTERIORE D.54 LV10 309746703R KIT CANDELA DX L=173 LV10 d.54 INOX 309746012R KIT RIC RIVESTIMENTO COMPL DX IN L160 BL 414205R KIT RICAMBI LANA HT 800 Plus 850g	
<b>15210</b>	HONDA	CBR 250 R	2011-2013 Leovince LV-10 - SLIP-ON - STAINLESS STEEL
RICAMBI		3015210601R KIT SACCHETTO MINUT HONDA CBR 250 R 3015210202R KIT SACCHETTO COLLETTORE N.1174 300041530R KIT fascetta 41 Inox 303949001R KIT RIC MOLLA-GOMM. ANTIVIB. CORTA 309746481R KIT RIC CORPO DX INOX Ø54 L=160mm LV10 309746701R KIT COPPA POSTERIORE D.54 LV10 309746703R KIT CANDELA DX L=173 LV10 d.54 INOX 309746010R KIT RIC RIVESTIMENTO COMPL DX INOX L=160 414205R KIT RICAMBI LANA HT 800 Plus 850g	
<b>15211B</b>	HONDA	CB 300 F (US model only)	2014-2017 Leovince LV-10 BLACK - SLIP-ON - STAINLESS STEEL
	HONDA	CBR 300 R	2014-2017
RICAMBI		3015211202R KIT SACCHETTO COLLETTORE N.1173 3015211601R KIT SACCHETTO MINUT HONDA CBR 300 R 300041530R KIT fascetta 41 Inox 303949001R KIT RIC MOLLA-GOMM. ANTIVIB. CORTA 309746485R KIT RIC CORPO DX INOX Ø54 L=160 LV10 BLA 309746701R KIT COPPA POSTERIORE D.54 LV10 309746703R KIT CANDELA DX L=173 LV10 d.54 INOX 309746012R KIT RIC RIVESTIMENTO COMPL DX IN L160 BL 414205R KIT RICAMBI LANA HT 800 Plus 850g	
<b>15211</b>	HONDA	CB 300 F (US model only)	2014-2017 Leovince LV-10 - SLIP-ON - STAINLESS STEEL
	HONDA	CBR 300 R	2014-2017
RICAMBI		3015211202R KIT SACCHETTO COLLETTORE N.1173 3015211601R KIT SACCHETTO MINUT HONDA CBR 300 R 300041530R KIT fascetta 41 Inox 303949001R KIT RIC MOLLA-GOMM. ANTIVIB. CORTA 309746481R KIT RIC CORPO DX INOX Ø54 L=160mm LV10 309746701R KIT COPPA POSTERIORE D.54 LV10 309746703R KIT CANDELA DX L=173 LV10 d.54 INOX 309746010R KIT RIC RIVESTIMENTO COMPL DX INOX L=160 414205R KIT RICAMBI LANA HT 800 Plus 850g	
<b>15212B</b>	YAMAHA	MT-25	2015-2017 Leovince LV-10 BLACK - SLIP-ON - STAINLESS STEEL
	YAMAHA	YZF-R25	2014-2017
	YAMAHA	MT-03	2016-2017
	YAMAHA	MT-03	2018-
	YAMAHA	YZF-R3	2015-2017
	YAMAHA	YZF-R3	2018-
	YAMAHA	YZF-R3 (US model only)	2015-2018
RICAMBI		3015212202R KIT SACCHETTO COLLETTORE N.1178 3015212601R KIT SACCHETT MINUTERIA YAMAHA R3 MT03 3015212561R KIT SACCHET STAFFA CAR YAMAHA R3 MT03 300041530R KIT fascetta 41 Inox 303949001R KIT RIC MOLLA-GOMM. ANTIVIB. CORTA 309746485R KIT RIC CORPO DX INOX Ø54 L=160 LV10 BLA 309746701R KIT COPPA POSTERIORE D.54 LV10 309746703R KIT CANDELA DX L=173 LV10 d.54 INOX 309746012R KIT RIC RIVESTIMENTO COMPL DX IN L160 BL 414205R KIT RICAMBI LANA HT 800 Plus 850g	
<b>15212</b>	YAMAHA	MT-25	2015-2017 Leovince LV-10 - SLIP-ON - STAINLESS STEEL
	YAMAHA	YZF-R25	2014-2017
	YAMAHA	MT-03	2016-2017

ART.	MARCA	MODELLO	TIPOLOGIA
	YAMAHA	MT-03	2018-
	YAMAHA	YZF-R3	2015-2017
	YAMAHA	YZF-R3	2018-
	YAMAHA	YZF-R3 (US model only)	2015-2018
<b>RICAMBI</b>	3015212202R	KIT SACCHETTO COLLETTORE N.1178	
	3015212601R	KIT SACCHETT MINUTERIA YAMAHA R3 MT03	
	3015212561R	KIT SACCHET STAFFA CAR YAMAHA R3 MT03	
	300041530R	KIT fascetta 41 Inox	
	303949001R	KIT RIC MOLLA-GOMM. ANTIVIB. CORTA	
	309746481R	KIT RIC CORPO DX INOX Ø54 L=160mm LV10	
	309746701R	KIT COPPA POSTERIORE D.54 LV10	
	309746703R	KIT CANDELA DX L=173 LV10 d.54 INOX	
	309746010R	KIT RIC RIVESTIMENTO COMPL DX INOX L=160	
	414205R	KIT RICAMBI LANA HT 800 Plus 850g	
<b>15213B</b>	SUZUKI	GSX 250 R/ABS	2017-2018 Leovince LV-10 BLACK - SLIP-ON - STAINLESS STEEL
<b>RICAMBI</b>	3015213202R	KIT SACCHETTO COLLETTORE N.1179	
	3015213601R	KIT SACCHETT MINUTERIA SUZUKI GSX 250 R	
	300049530R	KIT fascetta 49 Inox	
	303949001R	KIT RIC MOLLA-GOMM. ANTIVIB. CORTA	
	309746485R	KIT RIC CORPO DX INOX Ø54 L=160 LV10 BLA	
	309746701R	KIT COPPA POSTERIORE D.54 LV10	
	309746703R	KIT CANDELA DX L=173 LV10 d.54 INOX	
	309746012R	KIT RIC RIVESTIMENTO COMPL DX IN L160 BL	
	414205R	KIT RICAMBI LANA HT 800 Plus 850g	
<b>15213</b>	SUZUKI	GSX 250 R/ABS	2017-2018 Leovince LV-10 - SLIP-ON - STAINLESS STEEL
<b>RICAMBI</b>	3015213202R	KIT SACCHETTO COLLETTORE N.1179	
	3015213601R	KIT SACCHETT MINUTERIA SUZUKI GSX 250 R	
	300049530R	KIT fascetta 49 Inox	
	303949001R	KIT RIC MOLLA-GOMM. ANTIVIB. CORTA	
	309746481R	KIT RIC CORPO DX INOX Ø54 L=160mm LV10	
	309746701R	KIT COPPA POSTERIORE D.54 LV10	
	309746703R	KIT CANDELA DX L=173 LV10 d.54 INOX	
	309746010R	KIT RIC RIVESTIMENTO COMPL DX INOX L=160	
	414205R	KIT RICAMBI LANA HT 800 Plus 850g	
<b>15214B</b>	KAWASAKI	Z 800	2013-2016 Leovince LV-10 BLACK - SLIP-ON - STAINLESS STEEL
<b>RICAMBI</b>	3015214202R	KIT SACCHETTO COLLETTORE N.1180	
	3015214561R	KIT SACCHET STAFFA CAR KAWASAKI Z800	
	3015214601R	KIT SACCHETT MINUTERIA KAWASAKI Z800	
	303949001R	KIT RIC MOLLA-GOMM. ANTIVIB. CORTA	
	309746485R	KIT RIC CORPO DX INOX Ø54 L=160 LV10 BLA	
	309746701R	KIT COPPA POSTERIORE D.54 LV10	
	309746703R	KIT CANDELA DX L=173 LV10 d.54 INOX	
	309746012R	KIT RIC RIVESTIMENTO COMPL DX IN L160 BL	
	414205R	KIT RICAMBI LANA HT 800 Plus 850g	
<b>15214</b>	KAWASAKI	Z 800	2013-2016 Leovince LV-10 - SLIP-ON - STAINLESS STEEL
<b>RICAMBI</b>	3015214202R	KIT SACCHETTO COLLETTORE N.1180	
	3015214561R	KIT SACCHET STAFFA CAR KAWASAKI Z800	
	3015214601R	KIT SACCHETT MINUTERIA KAWASAKI Z800	
	303949001R	KIT RIC MOLLA-GOMM. ANTIVIB. CORTA	
	309746481R	KIT RIC CORPO DX INOX Ø54 L=160mm LV10	
	309746701R	KIT COPPA POSTERIORE D.54 LV10	
	309746703R	KIT CANDELA DX L=173 LV10 d.54 INOX	
	309746010R	KIT RIC RIVESTIMENTO COMPL DX INOX L=160	
	414205R	KIT RICAMBI LANA HT 800 Plus 850g	
<b>15215B</b>	YAMAHA	YZF-R6	2006-2018 Leovince LV-10 BLACK - SLIP-ON - STAINLESS STEEL
<b>RICAMBI</b>	3015215202R	KIT SACCHETTO COLLETTORE N.1182	
	3015215601R	KIT SACCHETT MINUTERIA YAMAHA YZF R6 '18	
	3015215561R	KIT SACCHETTO STAFFA INOX YAMAHA YZF R6	

ART.	MARCA	MODELLO	TIPOLOGIA
		303949001R KIT RIC MOLLA-GOMM. ANTIVIB. CORTA 309746485R KIT RIC CORPO DX INOX Ø54 L=160 LV10 BLA 309746701R KIT COPPA POSTERIORE D.54 LV10 309746703R KIT CANDELA DX L=173 LV10 d.54 INOX 309746012R KIT RIC RIVESTIMENTO COMPL DX IN L160 BL 414205R KIT RICAMBI LANA HT 800 Plus 850g	
<b>15215</b>	YAMAHA	YZF-R6	2006-2018 Leovince LV-10 - SLIP-ON - STAINLESS STEEL
<b>RICAMBI</b>		3015215202R KIT SACCHETTO COLLETTORE N.1182 3015215561R KIT SACCHETTO STAFFA INOX YAMAHA YZF R6 3015215601R KIT SACCHETT MINUTERIA YAMAHA YZF R6 '18 303949001R KIT RIC MOLLA-GOMM. ANTIVIB. CORTA 309746481R KIT RIC CORPO DX INOX Ø54 L=160mm LV10 309746701R KIT COPPA POSTERIORE D.54 LV10 309746703R KIT CANDELA DX L=173 LV10 d.54 INOX 309746010R KIT RIC RIVESTIMENTO COMPL DX INOX L=160 414205R KIT RICAMBI LANA HT 800 Plus 850g	
<b>15216B</b>	KAWASAKI	Z 900 RS/CAFE (fits with original centre stand)	2018- Leovince LV-10 BLACK - SLIP-ON - STAINLESS STEEL
<b>RICAMBI</b>		3015216601R KIT SACC MINUTERIA KAWASAKI Z900 RS '18 3015216485R KIT RIC COR DX INOX COL SAL L=160 LV10 B 309746701R KIT COPPA POSTERIORE D.54 LV10 3015216703R KIT CAND. DX L=173 LV10 d.54 INOX + COLL 3015216012R KIT RIC RIV. COMPL DX IN L160 BL 0017 300053530R KIT fascetta 53 Inox 414205R KIT RICAMBI LANA HT 800 Plus 850g	
<b>15216</b>	KAWASAKI	Z 900 RS/CAFE (fits with original centre stand)	2018- Leovince LV-10 - SLIP-ON - STAINLESS STEEL
<b>RICAMBI</b>		3015216601R KIT SACC MINUTERIA KAWASAKI Z900 RS '18 3015216481R KIT RIC COR DX INOX COL SAL L=160mm LV10 309746701R KIT COPPA POSTERIORE D.54 LV10 3015216703R KIT CAND. DX L=173 LV10 d.54 INOX + COLL 3015216010R KIT RIC RIVESTIMENTO COMPL DX INOX L=160 300053530R KIT fascetta 53 Inox 414205R KIT RICAMBI LANA HT 800 Plus 850g	
<b>15217B</b>	BMW	S 1000 RR	2017-2018 Leovince LV-10 BLACK - SLIP-ON - STAINLESS STEEL
<b>RICAMBI</b>		3015217601R KIT SACCHETTO MINUTERIA BMW S 1000 RR 309746485R KIT RIC CORPO DX INOX Ø54 L=160 LV10 BLA 309746701R KIT COPPA POSTERIORE D.54 LV10 309746703R KIT CANDELA DX L=173 LV10 d.54 INOX 309746012R KIT RIC RIVESTIMENTO COMPL DX IN L160 BL 300053530R KIT fascetta 53 Inox 300035530R KIT fascetta 35 Inox 3015217202R KIT SACCHETT COLLETTORE N.1186 3015217561R KIT SACC STAFFA CARBONIO BMW S 1000 RR 306974002R KIT SACC CARTER CARB APRILIA RSV 000 414205R KIT RICAMBI LANA HT 800 Plus 850g 303949001R KIT RIC MOLLA-GOMM. ANTIVIB. CORTA	
<b>15217</b>	BMW	S 1000 RR	2017-2018 Leovince LV-10 - SLIP-ON - STAINLESS STEEL
<b>RICAMBI</b>		3015217601R KIT SACCHETTO MINUTERIA BMW S 1000 RR 309746481R KIT RIC CORPO DX INOX Ø54 L=160mm LV10 309746701R KIT COPPA POSTERIORE D.54 LV10 309746703R KIT CANDELA DX L=173 LV10 d.54 INOX 309746010R KIT RIC RIVESTIMENTO COMPL DX INOX L=160 300053530R KIT fascetta 53 Inox 300035530R KIT fascetta 35 Inox 3015217202R KIT SACCHETT COLLETTORE N.1186 3015217561R KIT SACC STAFFA CARBONIO BMW S 1000 RR 306974002R KIT SACC CARTER CARB APRILIA RSV 000 414205R KIT RICAMBI LANA HT 800 Plus 850g 303949001R KIT RIC MOLLA-GOMM. ANTIVIB. CORTA	

ART.	MARCA	MODELLO	TIPOLOGIA
15218B	KAWASAKI	NINJA 400	2018- Leovince LV-10 BLACK - SLIP-ON - STAINLESS STEEL
RICAMBI	3015218202R	KIT SACCHETT COLLETTORE N.1187	
	3015218601R	KIT SACCHET MINUTERIA KAWASAKI NINJA 400	
	303949001R	KIT RIC MOLLA-GOMM. ANTIVIB. CORTA	
	309746485R	KIT RIC CORPO DX INOX Ø54 L=160 LV10 BLA	
	309746701R	KIT COPPA POSTERIORE D.54 LV10	
	309746703R	KIT CANDELA DX L=173 LV10 d.54 INOX	
	309746012R	KIT RIC RIVESTIMENTO COMPL DX IN L160 BL	
	414205R	KIT RICAMBI LANA HT 800 Plus 850g	
15218	KAWASAKI	NINJA 400	2018- Leovince LV-10 - SLIP-ON - STAINLESS STEEL
RICAMBI	3015218202R	KIT SACCHETT COLLETTORE N.1187	
	3015218601R	KIT SACCHET MINUTERIA KAWASAKI NINJA 400	
	303949001R	KIT RIC MOLLA-GOMM. ANTIVIB. CORTA	
	309746481R	KIT RIC CORPO DX INOX Ø54 L=160mm LV10	
	309746701R	KIT COPPA POSTERIORE D.54 LV10	
	309746703R	KIT CANDELA DX L=173 LV10 d.54 INOX	
	309746010R	KIT RIC RIVESTIMENTO COMPL DX INOX L=160	
	414205R	KIT RICAMBI LANA HT 800 Plus 850g	
15219B	HUSQVARNA	SVARTPILEN 401	2018- Leovince LV-10 BLACK - SLIP-ON - STAINLESS STEEL
	HUSQVARNA	VITPILEN 401	2018-
RICAMBI	3015219202R	KIT SACCHETT COLLETTORE N.1188	
	3015219561R	KIT SAC STAF INO HUQVAR VITPILEN 401 '18	
	3015219601R	KIT SACC MINUT HUQVARNA VITPILEN 401 '18	
	303949001R	KIT RIC MOLLA-GOMM. ANTIVIB. CORTA	
	309746481R	KIT RIC CORPO DX INOX Ø54 L=160mm LV10	
	309746701R	KIT COPPA POSTERIORE D.54 LV10	
	309746703R	KIT CANDELA DX L=173 LV10 d.54 INOX	
	309746012R	KIT RIC RIVESTIMENTO COMPL DX IN L160 BL	
	414205R	KIT RICAMBI LANA HT 800 Plus 850g	
15219	HUSQVARNA	SVARTPILEN 401	2018- Leovince LV-10 - SLIP-ON - STAINLESS STEEL
	HUSQVARNA	VITPILEN 401	2018-
RICAMBI	3015219202R	KIT SACCHETT COLLETTORE N.1188	
	3015219561R	KIT SAC STAF INO HUQVAR VITPILEN 401 '18	
	3015219601R	KIT SACC MINUT HUQVARNA VITPILEN 401 '18	
	303949001R	KIT RIC MOLLA-GOMM. ANTIVIB. CORTA	
	309746481R	KIT RIC CORPO DX INOX Ø54 L=160mm LV10	
	309746701R	KIT COPPA POSTERIORE D.54 LV10	
	309746703R	KIT CANDELA DX L=173 LV10 d.54 INOX	
	309746010R	KIT RIC RIVESTIMENTO COMPL DX INOX L=160	
	414205R	KIT RICAMBI LANA HT 800 Plus 850g	
15220B	HUSQVARNA	VITPILEN 701	2018- Leovince LV-10 BLACK - SLIP-ON - STAINLESS STEEL
RICAMBI	3015220202R	KIT SACCHETT COLLETTORE N.1192	
	3015220601R	KIT SACC MINUT HUQVARNA VITPILEN 701 '18	
	303949001R	KIT RIC MOLLA-GOMM. ANTIVIB. CORTA	
	309746485R	KIT RIC CORPO DX INOX Ø54 L=160 LV10 BLA	
	309746701R	KIT COPPA POSTERIORE D.54 LV10	
	309746703R	KIT CANDELA DX L=173 LV10 d.54 INOX	
	309746012R	KIT RIC RIVESTIMENTO COMPL DX IN L160 BL	
	414205R	KIT RICAMBI LANA HT 800 Plus 850g	
15220	HUSQVARNA	VITPILEN 701	2018- Leovince LV-10 - SLIP-ON - STAINLESS STEEL
RICAMBI	3015220202R	KIT SACCHETT COLLETTORE N.1192	
	3015220601R	KIT SACC MINUT HUQVARNA VITPILEN 701 '18	
	303949001R	KIT RIC MOLLA-GOMM. ANTIVIB. CORTA	
	309746481R	KIT RIC CORPO DX INOX Ø54 L=160mm LV10	
	309746701R	KIT COPPA POSTERIORE D.54 LV10	
	309746703R	KIT CANDELA DX L=173 LV10 d.54 INOX	
	309746010R	KIT RIC RIVESTIMENTO COMPL DX INOX L=160	
	414205R	KIT RICAMBI LANA HT 800 Plus 850g	

ART.	MARCA	MODELLO	2018-	Leovince	TIPOLOGIA
15221B	HONDA	CB 125 R			LV-10 BLACK - FULL SYSTEM 1/1 - STAINLESS STEEL
RICAMBI	3015221202R	KIT SACCHETT COLLETTORE N.1198			
	3015221561R	KIT SACCHET STAFFA INOX HONDA CB 125 R			
	3015221601R	KIT SACCHET MINUTERIA HONDA CB 125 R '18			
	206442R	KIT BOCCOLA INOX CB/CBR 125 DIS.MF168			
	206443R	KIT FLANGIA INOX 304 SP.5MM DIS.MF169			
	303949001R	KIT RIC MOLLA-GOMM. ANTIVIB. CORTA			
	308574001R	KIT RIC MOLLA TRAZ SUPER CORTA + TUBETTO			
	309746485R	KIT RIC CORPO DX INOX Ø54 L=160 LV10 BLA			
	309746701R	KIT COPPA POSTERIORE D.54 LV10			
	309746703R	KIT CANDELA DX L=173 LV10 d.54 INOX			
	309746012R	KIT RIC RIVESTIMENTO COMPL DX IN L160 BL			
	414205R	KIT RICAMBI LANA HT 800 Plus 850g			
15221	HONDA	CB 125 R			LV-10 - FULL SYSTEM 1/1 - STAINLESS STEEL
RICAMBI	3015221202R	KIT SACCHETT COLLETTORE N.1198			
	3015221561R	KIT SACCHET STAFFA INOX HONDA CB 125 R			
	3015221601R	KIT SACCHET MINUTERIA HONDA CB 125 R '18			
	206442R	KIT BOCCOLA INOX CB/CBR 125 DIS.MF168			
	206443R	KIT FLANGIA INOX 304 SP.5MM DIS.MF169			
	303949001R	KIT RIC MOLLA-GOMM. ANTIVIB. CORTA			
	308574001R	KIT RIC MOLLA TRAZ SUPER CORTA + TUBETTO			
	309746481R	KIT RIC CORPO DX INOX Ø54 L=160mm LV10			
	309746701R	KIT COPPA POSTERIORE D.54 LV10			
	309746703R	KIT CANDELA DX L=173 LV10 d.54 INOX			
	309746010R	KIT RIC RIVESTIMENTO COMPL DX INOX L=160			
	414205R	KIT RICAMBI LANA HT 800 Plus 850g			
15222B	HONDA	CB 1000 R			LV-10 BLACK - SLIP-ON - STAINLESS STEEL
RICAMBI	3015222202R	KIT SACCHETT COLLETTORE N.1203			
	3015222601R	KIT SACCHE MINUTERIA HONDA CB 1000 R '18			
	303949001R	KIT RIC MOLLA-GOMM. ANTIVIB. CORTA			
	300051530R	KIT fascetta 51 Inox			
	309746485R	KIT RIC CORPO DX INOX Ø54 L=160 LV10 BLA			
	414205R	KIT RICAMBI LANA HT 800 Plus 850g			
15222	HONDA	CB 1000 R			LV-10 - SLIP-ON - STAINLESS STEEL
RICAMBI	3015222202R	KIT SACCHETT COLLETTORE N.1203			
	3015222601R	KIT SACCHE MINUTERIA HONDA CB 1000 R '18			
	303949001R	KIT RIC MOLLA-GOMM. ANTIVIB. CORTA			
	300051530R	KIT fascetta 51 Inox			
	309746481R	KIT RIC CORPO DX INOX Ø54 L=160mm LV10			
	414205R	KIT RICAMBI LANA HT 800 Plus 850g			

## RICAMBI E ACCESSORI

### LEOVINCE STREET

DESCRIZIONE	ART.
Carter paracalore universale in carbonio piccolo (L 110 mm X H 58 mm) per collettori con diam. da 44mm a 66 mm	6684
Carter paracalore universale in carbonio medio (L 158 mm X H 58 mm) per collettori con diam. da 44mm a 66 mm	6685
Kit ricambio molla a trazione lunga e gommino antivibrante	4682
Kit ricambio molla a trazione corta e gommino antivibrante	303949001R
Kit materiale fonoassorbente sfuso per silenziatori GPStyle e GP PRO (rivetti compresi in confezione)	414204R
Kit materiale fonoassorbente sfuso per silenziatori LV ONE, Ovali e Factory (rivetti compresi in confezione)	414205R
Kit materiale fonoassorbente per silenziatori Factory R - 270 mm - (rivetti compresi in confezione)	416797R
Kit materiale fonoassorbente per silenziatori Factory R - 350 mm - (rivetti compresi in confezione)	416796R
Kit materiale fonoassorbente per silenziatori Underbody (rivetti compresi in confezione)	8066
Tappo di chiusura attacco sonda lambda in inox (M 18X1,5) racing + guarnizione	5681
Tappo di chiusura attacco sonda lambda in inox (M 18X1,5) base + guarnizione	204888R
Tappo di chiusura attacco sonda lambda in inox (M 12X1,25) racing + guarnizione	204052R
Tappo di chiusura attacco sonda lambda in inox (M 12X1,25) base + guarnizione	205123R
Kit catalizzatore per collettore diametro 40m	8605K
Kit catalizzatore per collettore diametro 45mm	6521K
Kit catalizzatore per collettore diametro 50mm	6522K
Kit catalizzatore per collettore diametro 54mm	6523K
Kit catalizzatore per collettore diametro 60,3mm	6525K
Targhetta Leovince per silenziatore	417705R
Rivetto 4,8X12,5 Inox	200682R

### SILVERTAIL

DESCRIZIONE	ART.	
K02 CODA SLASH-CUT	dx/right	2301
	sx/left	2302
dB- Killer per K02	2327	



### LEOVINCE SCOOT

MODELLO	ART.
Confezione ricambio lana di vetro fonoassorbente per silenziatori	4600
Kit ricambio materiale fono-assorbente LeoVince H.M. ZX - H.M. RR - H.M. TT	5672
Molla attacco tubo collettore corta	4620
Molla attacco tubo collettore lunga	4621
Boccola in grafite raccordo collettore-silenziatore per scooter diam. 45/50	4622
Boccola in grafite raccordo collettore-silenziatore per scooter diam. 35/40	4623
Collettore per art. 4205	4625
Collettore per art. 4206	4626
Silenziatore Standard in Alluminio adattabile all'espansione Hand Made "TT"	6662
Kit catalizzatore per collettore diametro 35mm per scarico Granturismo	8613K
Guarnizione in grafite (3 fori) per art. 4604 - 4607 - 4612 - 4613 - 4614 - 4652 - 5643 - 5644	200315R
Fascetta con guarnizione per silenziatore H.M. "TT" e "ZX"	304051501R

# SITO

## DESCRIPTION

DESCRIPTION	ART.
Protezione paracalore per art. 0554	0607
Silenziatore terminale in alluminio per scooter Sitoplus art. 0571/0572	0626
Staffa attacco per art. 0237 - 0238 - 0239 - 0240	0641
Silenziatore interno tipo originale per Piaggio Vespa ET3 smontabile	0642
Guarnizione collettore per art. 0238 - 0240	203523R
Guarnizione collettore per art. 0256 - 0261 - 0262 - 0554	200324R
Collettore per art. 0256 - 0261	300256201R
Collettore per art. 0237	300237201R
Collettore per art. 0238	300238201R
Collettore per art. 0250	300250201R
Collettore per art. 0251	300251201R
Collettore per art. 0233 - 0262 - 0554	300262201R
Collettore per art. 0572	300572201R

## RICAMBI UNIVERSALI N/A

CC. MODELLO			ANNO							
N/A ALL BIKES			N/A-N/A							
GAMMA	LINEA	TIPO	MATERIALE	COPPA	STANDARD	TYPE	HOM.	2T/4T	ART.	
LEOVINCE	CARTER	N/A	N/A	N/A			N/A	N/A	6684	
LEOVINCE	CARTER	N/A	N/A	N/A			N/A	N/A	6685	
N/A K02 UNIVERSAL DBKILLER			N/A-N/A							
GAMMA	LINEA	TIPO	MATERIALE	COPPA	STANDARD	TYPE	HOM.	2T/4T	ART.	
SILVERTAIL	dB KILLER	N/A	N/A	N/A			N/A	N/A	2327	
N/A N/A			N/A-N/A							
GAMMA	LINEA	TIPO	MATERIALE	COPPA	STANDARD	TYPE	HOM.	2T/4T	ART.	
LEOVINCE	CATALYTIC CONVERTER	N/A	N/A	N/A	N/A		EC-Approved	N/A	6521K	
LEOVINCE	CATALYTIC CONVERTER	N/A	N/A	N/A	N/A		EC-Approved	N/A	6522BK	
LEOVINCE	CATALYTIC CONVERTER	N/A	N/A	N/A	N/A		EC-Approved	N/A	6522CK	
LEOVINCE	CATALYTIC CONVERTER	N/A	N/A	N/A	N/A		EC-Approved	N/A	6522K	
LEOVINCE	CATALYTIC CONVERTER	N/A	N/A	N/A	N/A		EC-Approved	N/A	6523K	
LEOVINCE	CATALYTIC CONVERTER	N/A	N/A	N/A	N/A		EC-Approved	N/A	6525K	
LEOVINCE	CATALYTIC CONVERTER	N/A	N/A	N/A	N/A		EC-Approved	N/A	8605K	
LEOVINCE	CATALYTIC CONVERTER	N/A	N/A	N/A	N/A		EC-Approved	N/A	8613K	
LEOVINCE	CATALYTIC CONVERTER MANIFOLD	N/A	N/A	N/A	EURO 4		EU-Approved	N/A	16000	
LEOVINCE	CATALYTIC CONVERTER MANIFOLD	N/A	N/A	N/A	EURO 4		EU-Approved	N/A	16001	
LEOVINCE	CATALYTIC CONVERTER MANIFOLD	N/A	N/A	N/A	EURO 3		EU-Approved	N/A	16002	
LEOVINCE	CATALYTIC CONVERTER MANIFOLD	N/A	N/A	N/A	EURO 3/4		EU-Approved	N/A	16003	
LEOVINCE	CATALYTIC CONVERTER MANIFOLD	N/A	N/A	N/A	EURO 3/4		EU-Approved	N/A	16004	
LEOVINCE	CATALYTIC CONVERTER MANIFOLD	N/A	N/A	N/A	EURO 4		EU-Approved	N/A	16005	
LEOVINCE	CATALYTIC CONVERTER MANIFOLD	N/A	N/A	N/A	EURO 4		EU-Approved	N/A	16006	
LEOVINCE	CATALYTIC CONVERTER MANIFOLD	N/A	N/A	N/A	EURO 4		EU-Approved	N/A	16011	
LEOVINCE	CATALYTIC CONVERTER MANIFOLD	N/A	N/A	N/A	EURO 4		EU-Approved	N/A	16012	
LEOVINCE	CATALYTIC CONVERTER MANIFOLD	N/A	N/A	N/A	EURO 4		EU-Approved	N/A	16013	
LEOVINCE	CATALYTIC CONVERTER MANIFOLD	N/A	N/A	N/A	EURO 4		EU-Approved	N/A	16014	

## RICAMBI UNIVERSALI N/A

CC. MODELLO			ANNO						
LEOVINCE	CATALYTIC CON- VERTER MANIFOLD	N/A	N/A	N/A	EURO 4	EU-Approved	N/A	16015	
LEOVINCE	CATALYTIC CON- VERTER MANIFOLD	N/A	N/A	N/A	EURO 4	EU-Approved	N/A	16016	
LEOVINCE	CATALYTIC CON- VERTER MANIFOLD	N/A	N/A	N/A	EURO 4	EU-Approved	N/A	16017	
LEOVINCE	CATALYTIC CON- VERTER MANIFOLD	N/A	N/A	N/A	EURO 4	EU-Approved	N/A	16018	
LEOVINCE	CATALYTIC CON- VERTER MANIFOLD	N/A	N/A	N/A	EURO 4	EU-Approved	N/A	16019	
LEOVINCE	CATALYTIC CON- VERTER MANIFOLD	N/A	N/A	N/A	EURO 4	EU-Approved	N/A	16020	
LEOVINCE	REPACK KIT	N/A	N/A	N/A	N/A	N/A	N/A	5672	
LEOVINCE	REPACK KIT	N/A	N/A	N/A	N/A	N/A	N/A	6660	
LEOVINCE	REPACK KIT	N/A	N/A	N/A	N/A	N/A	N/A	8066	
LEOVINCE	REPACK KIT	N/A	N/A	N/A	N/A	N/A	N/A	414204R	
LEOVINCE	REPACK KIT	N/A	N/A	N/A	N/A	N/A	N/A	414205R	

## UNIVERSAL

CC. MODELLO			ANNO						
N/A ALL BIKES			N/A-N/A						
GAMMA	LINEA	TIPO	MATERIALE	COPPA	STANDARD	TYPE	HOM.	2T/4T	ART.
LEOVINCE	EXHAUST WRAP	N/A	N/A	N/A	N/A	N/A	N/A	4T	8083
LEOVINCE	EXHAUST WRAP	N/A	N/A	N/A	N/A	N/A	N/A	4T	8084
LEOVINCE	GP STYLE	MUFFLER KIT Ø 50	STAINLESS STEEL	N/A	N/A	N/A	N/A	4T	8032
LEOVINCE	GP STYLE	MUFFLER KIT Ø 54	STAINLESS STEEL	N/A	N/A	N/A	N/A	4T	8033
LEOVINCE	GP STYLE BLACK	MUFFLER KIT Ø 50	STAINLESS STEEL	N/A	N/A	N/A	N/A	4T	8032B
LEOVINCE	GP STYLE BLACK	MUFFLER KIT Ø 54	STAINLESS STEEL	N/A	N/A	N/A	N/A	4T	8033B
LEOVINCE	CLASSIC RACER	MUFFLER KIT Ø 50 RIGHT	STAINLESS STEEL	STAINLESS STEEL	N/A	N/A	N/A	N/A	9758
LEOVINCE	CLASSIC RACER	MUFFLER KIT Ø 50 LEFT	STAINLESS STEEL	STAINLESS STEEL	N/A	N/A	N/A	N/A	9759
LEOVINCE	CLASSIC RACER	MUFFLER KIT Ø 50 RIGHT & LEFT	STAINLESS STEEL	STAINLESS STEEL	N/A	N/A	N/A	N/A	9760
LEOVINCE	CLASSIC RACER BLACK	MUFFLER KIT Ø 50 RIGHT	STAINLESS STEEL	STAINLESS STEEL	N/A	N/A	N/A	N/A	9758B
LEOVINCE	CLASSIC RACER BLACK	MUFFLER KIT Ø 50 LEFT	STAINLESS STEEL	STAINLESS STEEL	N/A	N/A	N/A	N/A	9759B
LEOVINCE	CLASSIC RACER BLACK	MUFFLER KIT Ø 50 RIGHT & LEFT	STAINLESS STEEL	STAINLESS STEEL	N/A	N/A	N/A	N/A	9760B
LEOVINCE	GP CORSA	MUFFLER KIT Ø 54	CARBON FIBER	N/A	N/A	N/A	N/A	N/A	9736
LEOVINCE	GP CORSA EVO	MUFFLER KIT Ø 54	CARBON FIBER	TECHNOPOLYMER	N/A	N/A	N/A	N/A	9736E
LEOVINCE	GP CORSA EVO SHORT	MUFFLER KIT Ø 54	CARBON FIBER	TECHNOPOLYMER	N/A	N/A	N/A	N/A	9739E
LEOVINCE	GP CORSA SHORT	MUFFLER KIT Ø 54	CARBON FIBER	N/A	N/A	N/A	N/A	N/A	9739
LEOVINCE	GP ONE	MUFFLER KIT Ø 50	STAINLESS STEEL	STAINLESS STEEL	N/A	N/A	N/A	N/A	9763
LEOVINCE	LV PRO	MUFFLER KIT Ø 54	STAINLESS STEEL	CARBON FIBER	N/A	N/A	N/A	N/A	9747
LEOVINCE	LV PRO	MUFFLER KIT Ø 54	CARBON FIBER	CARBON FIBER	N/A	N/A	N/A	N/A	9748
LEOVINCE	LV PRO	MUFFLER KIT Ø 50	STAINLESS STEEL	CARBON FIBER	N/A	N/A	N/A	N/A	9761
LEOVINCE	LV PRO	MUFFLER KIT Ø 50	CARBON FIBER	CARBON FIBER	N/A	N/A	N/A	N/A	9762
LEOVINCE	LV-10	MUFFLER KIT Ø 54	STAINLESS STEEL	STAINLESS STEEL	N/A	N/A	N/A	N/A	9746
LEOVINCE	LV-10 BLACK	MUFFLER KIT Ø 54	STAINLESS STEEL	STAINLESS STEEL	N/A	N/A	N/A	N/A	9746B



# UNIVERSAL

<b>8032</b>	UNIVERSAL	ALL BIKES	N/A-N/A	Leovince	GP STYLE - MUFFLER KIT Ø 50 - STAINLESS STEEL
		ALL BIKES	N/A-N/A		
<b>RICAMBI</b>	308032601R	KIT SACCH.MINUTERIA GP-STYLE STANDARD			
	303949001R	KIT RIC MOLLA-GOMM. ANTIVIB. CORTA			
	307762461R	KIT RIC CORPO Ø150 L=295 INOX OM.0473 ST			
	307762801R	KIT TAPPO X OMOL. EVO2 N. 32B GPSTY			

<b>8033</b>	UNIVERSAL	ALL BIKES	N/A-N/A	Leovince	GP STYLE - MUFFLER KIT Ø 54 - STAINLESS STEEL
		ALL BIKES	N/A-N/A		
<b>RICAMBI</b>	308032601R	KIT SACCH.MINUTERIA GP-STYLE STANDARD			
	303949001R	KIT RIC MOLLA-GOMM. ANTIVIB. CORTA			
	307777461R	KIT RIC CORPO Ø154 L=295 INOX OM.0474			
	307762801R	KIT TAPPO X OMOL. EVO2 N. 32B GPSTY			

## KIT MOLLE RULLI VARIATORE

MODELLO	ART.
Kit 9 molle innesto frizione motori Minarelli	5612
Kit 9 molle innesto frizione motori Piaggio	5613
Kit 6 rulli D x L = 20 x 15 mm per variatore centrifugo maxi-scooter (grammi 8,5)	4145P85
Kit 6 rulli D x L = 20 x 15 mm per variatore centrifugo maxi-scooter (grammi 9,2)	4145P92
Kit 6 rulli D x L = 20 x 15 mm per variatore centrifugo maxi-scooter (grammi 9,8)	4145P98
Kit 6 rulli D x L = 20 x 15 mm per variatore centrifugo maxi-scooter (grammi 10,5)	4145P105
Kit 6 rulli D x L = 20 x 15 mm per variatore centrifugo maxi-scooter (grammi 11,0)	4145P11
Kit 6 rulli D x L = 20 x 15 mm per variatore centrifugo maxi-scooter (grammi 11,8)	4145P118
Kit 6 rulli D x L = 20 x 15 mm per variatore centrifugo maxi-scooter (grammi 12,3)	4145P123
Kit 6 rulli D x L = 20 x 15 mm per variatore centrifugo maxi-scooter (grammi 12,9)	4145P129
Kit 6 rulli D x L = 15 x 12 mm per variatore centrifugo scooter 50 cc (grammi 3,3)	4645P33
Kit 6 rulli D x L = 15 x 12 mm per variatore centrifugo scooter 50 cc (grammi 3,5)	4645P35
Kit 6 rulli D x L = 15 x 12 mm per variatore centrifugo scooter 50 cc (grammi 4,3)	4645P43
Kit 6 rulli D x L = 15 x 12 mm per variatore centrifugo scooter 50 cc (grammi 4,7)	4645P47
Kit 6 rulli D x L = 15 x 12 mm per variatore centrifugo scooter 50 cc (grammi 5,0)	4645P50
Kit 6 rulli D x L = 15 x 12 mm per variatore centrifugo scooter 50 cc (grammi 5,3)	4645P53
Kit 6 rulli D x L = 15 x 12 mm per variatore centrifugo scooter 50 cc (grammi 5,8)	4645P58
Kit 6 rulli D x L = 15 x 12 mm per variatore centrifugo scooter 50 cc (grammi 6,3)	4645P63
Kit 6 rulli D x L = 15 x 12 mm per variatore centrifugo scooter 50 cc (grammi 6,6)	4645P66
Kit 6 rulli D x L = 15 x 12 mm per variatore centrifugo scooter 50 cc (grammi 7,2)	4645P72
Kit 6 rulli D x L = 15 x 12 mm per variatore centrifugo scooter 50 cc (grammi 8,6)	4645P86
Kit 6 rulli D x L = 16 x 13 mm per variatore centrifugo scooter 50 cc (grammi 3,6)	4646P36
Kit 6 rulli D x L = 16 x 13 mm per variatore centrifugo scooter 50 cc (grammi 4,0)	4646P40
Kit 6 rulli D x L = 16 x 13 mm per variatore centrifugo scooter 50 cc (grammi 4,7)	4646P47
Kit 6 rulli D x L = 16 x 13 mm per variatore centrifugo scooter 50 cc (grammi 5,1)	4646P51
Kit 6 rulli D x L = 16 x 13 mm per variatore centrifugo scooter 50 cc (grammi 5,5)	4646P55
Kit 6 rulli D x L = 16 x 13 mm per variatore centrifugo scooter 50 cc (grammi 5,7)	4646P57
Kit 6 rulli D x L = 16 x 13 mm per variatore centrifugo scooter 50 cc (grammi 6,2)	4646P62
Kit 6 rulli D x L = 16 x 13 mm per variatore centrifugo scooter 50 cc (grammi 6,7)	4646P67
Kit 6 rulli D x L = 16 x 13 mm per variatore centrifugo scooter 50 cc (grammi 7,0)	4646P70
Kit 6 rulli D x L = 16 x 13 mm per variatore centrifugo scooter 50 cc (grammi 7,5)	4646P75
Kit 6 rulli D x L = 16 x 13 mm per variatore centrifugo scooter 50 cc (grammi 8,0)	4646P80
Kit 6 rulli D x L = 16 x 13 mm per variatore centrifugo scooter 50 cc (grammi 8,5)	4646P85
Kit 6 rulli D x L = 16 x 13 mm per variatore centrifugo scooter 50 cc (grammi 9,0)	4646P90
Kit 6 rulli D x L = 17 x 12 mm per variatore centrifugo scooter 50 cc (grammi 6,8)	4658P68

## KIT MOLLE RULLI VARIATORE

MODELLO	ART.
Kit 6 rulli D x L = 17 x 12 mm per variatore centrifugo scooter 50 cc (grammi 9,2)	4658P92
Kit 6 rulli D x L = 19 x 15,5 mm per variatore centrifugo scooter 50 cc (grammi 3,7)	4659P37
Kit 6 rulli D x L = 19 x 15,5 mm per variatore centrifugo scooter 50 cc (grammi 4,0)	4659P40
Kit 6 rulli D x L = 19 x 15,5 mm per variatore centrifugo scooter 50 cc (grammi 4,3)	4659P43
Kit 6 rulli D x L = 19 x 15,5 mm per variatore centrifugo scooter 50 cc (grammi 4,8)	4659P48
Kit 6 rulli D x L = 19 x 15,5 mm per variatore centrifugo scooter 50 cc (grammi 5,3)	4659P53
Kit 6 rulli D x L = 19 x 15,5 mm per variatore centrifugo scooter 50 cc (grammi 5,7)	4659P57
Kit 6 rulli D x L = 19 x 15,5 mm per variatore centrifugo scooter 50 cc (grammi 6,0)	4659P60
Kit 6 rulli D x L = 19 x 15,5 mm per variatore centrifugo scooter 50 cc (grammi 6,5)	4659P65
Kit 6 rulli D x L = 19 x 15,5 mm per variatore centrifugo scooter 50 cc (grammi 6,8)	4659P68
Kit 6 rulli D x L = 19 x 15,5 mm per variatore centrifugo scooter 50 cc (grammi 7,2)	4659P72
Kit 6 rulli D x L = 19 x 15,5 mm per variatore centrifugo scooter 50 cc (grammi 7,5)	4659P75
Kit 6 rulli D x L = 19 x 15,5 mm per variatore centrifugo scooter 50 cc (grammi 7,8)	4659P78
Kit 6 rulli D x L = 19 x 15,5 mm per variatore centrifugo scooter 50 cc (grammi 8,3)	4659P83
Kit 6 rulli D x L = 19 x 15,5 mm per variatore centrifugo scooter 50 cc (grammi 8,7)	4659P87
Kit 6 rulli D x L = 20 x 12 mm per variatore centrifugo maxi-scooter (grammi 7,2)	5648P72
Kit 6 rulli D x L = 20 x 12 mm per variatore centrifugo maxi-scooter (grammi 8,2)	5648P82
Kit 6 rulli D x L = 20 x 12 mm per variatore centrifugo maxi-scooter (grammi 9,2)	5648P92
Kit 6 rulli D x L = 20 x 12 mm per variatore centrifugo maxi-scooter (grammi 9,9)	5648P99
Kit 6 rulli D x L = 20 x 17 mm per variatore centrifugo maxi-scooter (grammi 11,5)	5650P115
Kit 6 rulli D x L = 20 x 17 mm per variatore centrifugo maxi-scooter (grammi 12,5)	5650P125
Kit 6 rulli D x L = 19 x 17 mm per variatore centrifugo maxi-scooter (grammi 7,3)	6643P73
Kit 6 rulli D x L = 19 x 17 mm per variatore centrifugo maxi-scooter (grammi 7,9)	6643P79
Kit 6 rulli D x L = 19 x 17 mm per variatore centrifugo maxi-scooter (grammi 8,5)	6643P85

## SCHEMA PESI PER KIT RULLI

ART.	Colore	Kit	D x L (mm)	Pesi (grammi)
4145	rossi	6 rulli	20 x 15	8,5 - 9,2 - 9,8 - 10,5 - 11,0 - 11,8 - 12,3 - 12,9
4645	azzurri	6 rulli	15 x 12	2,3 - 3,3 - 3,5 - 4,3 - 4,7 - 5,0 - 5,3 - 5,8 - 6,3 - 6,6 - 7,2 - 7,7 - 8,1 - 8,6
4646	verdi	6 rulli	16 x 13	2,7 - 3,6 - 4,0 - 4,7 - 5,1 - 5,5 - 5,7 - 6,2 - 6,7 - 7,0 - 7,5 - 8,0 - 8,5 - 9,0
4647	neri	6 rulli	17 x 13,5	3,0 - 4,0 - 5,5 - 6,6 - 7,0 - 7,4 - 9,0 - 9,4
4658	gialli	6 rulli	17 x 12	3,0 - 3,6 - 4,0 - 4,6 - 5,2 - 5,6 - 6,0 - 6,3 - 6,8 - 7,2 - 7,7 - 8,3 - 8,7 - 9,2
4659	arancioni	6 rulli	19 x 15,5	3,7 - 4,0 - 4,3 - 4,8 - 5,3 - 5,7 - 6,0 - 6,5 - 6,8 - 7,2 - 7,5 - 7,8 - 8,3 - 8,7
4674	grigi	8 rulli	20 x 12	8,2 - 8,7 - 9,2 - 9,9 - 10,6 - 11,3 - 12,0 - 12,7 - 13,4 - 14,0 - 14,7
4675	beige	6 rulli	23,8 x 18	10,0 - 11,0 - 12,0 - 13,0 - 14,0 - 15,0 - 15,5 - 17,0 - 18,5 - 20,0 - 21,5 - 22,0 - 23,0 - 23,5 - 24,0 - 25,0 - 26,5 - 28,0 - 29,5 - 31,0 - 32,5
5648	grigi	6 rulli	20 x 12	6,7 - 7,2 - 7,7 - 8,2 - 8,7 - 9,2 - 9,9 - 10,6 - 11,3 - 12,0 - 12,7 - 13,4 - 14,0
5649	bianchi	8 rulli	26 x 12,85	15,0 - 16,0 - 17,0 - 18,0 - 19,0 - 20,0 - 21,0 - 22,0
5650	marroni	6 rulli	20 x 17	5,0 - 6,5 - 7,0 - 7,5 - 8,0 - 8,5 - 9,0 - 9,5 - 10,0 - 11,5 - 12,5 - 13,5 - 14,5 - 15,5 - 16,5
5651	viola	6 rulli	19 x 13,5	9,2 - 9,9 - 10,6 - 11,3 - 12,0 - 12,5
6643	rosa	6 rulli	19 x 17	5 - 5,3 - 5,8 - 6,2 - 6,7 - 7,16 - 7,3 - 7,7 - 7,9 - 8,5 - 8,65 - 9,3 - 10,0
3410	neri	6 rulli	21 x 17	9,0 - 9,5 - 10,0 - 10,5 - 11,3 - 12,5 - 13,6

RULLI ORIGINALI	KIT LEOVINCE	RULLI GIA' INCLUSI IN CONFEZIONE							
		SP3	TOURING	H.M. "ZX"	H.M. "ZXc"	H.M. "ZX-R"	H.M. "TT"	H.M. "GP"	4ROAD
grammi	articolo	grammi	grammi	grammi	grammi	grammi	grammi	grammi	grammi

APRILIA	AMICO - AMICO SPORT ('91-'92)	6,5	4645	4,3						
	AMICO (dal '93)	6,5	4645	5,0						
	AMICO GL	7,0	4645	5,0						
	SR (cil. verticale)	5,5	4645	5,0		5,0*			5,0*	5,0*
	SR (cil. orizzontale - air cooled)	5,2	4645	4,7	4,3*	4,7*	4,7*	4,7*	4,7*	4,7*
	SR (cil. orizzontale - liquid cooled)	6,5	4645	5,8	5,0*	5,3*	5,3*	5,3*	5,3*	5,3*
	SR WWW (cil. orizz. - air cooled)	6,5	4645	5,8	5,0*	4,3*	4,3*	4,3*	4,3*	4,3*
	NETSCAPER (cil. orizz. - air cooled)	6,5	4645			5,3*	5,3*	5,3*	5,3*	5,3*
	SR STEALTH (cil. orizz. - liquid cooled)	5,5	4645	4,7	4,3*	4,3*	4,3*	4,3*	4,3*	4,3*
	SR 50 (mod. '00/'02 - mot. Suzuki)	7,6	4658		OR.*	6,0*	6,0*		6,0*	6,0*
	SR 50 DI-TECH (mod. '01/'04)	7,7	4658		OR.	OR.	OR.	OR.	OR.	OR.
	SR 50 i.e. TUONO (mod. '03)	7,7	4658		OR.	OR.		OR.		OR.
	SR 50 SPORT PRO i.e. ('03 - mot. Piaggio)	5,3	4659		OR.*	4,8*	4,8*	4,8*	4,8*	4,8*
	SR 50 R FACTORY i.e. ('05 - Di-tech)	5,3	4659			4,8*	4,8*	4,8*	4,8*	4,8*
	SR 50 R FACTORY(mot. Piaggio - carb.)	6,0	4659			4,8*	4,8*	4,8*	4,8*	4,8*
	AREA 51 KAT	5,5	4645			3,5*	3,5*		3,5*	
	SCARABEO (fino al '97)	7,0	4645	6,3	5,3*					
	SCARABEO (mod. '98-freno disco post.)	6,5	4645	6,3	OR.					
	SCARABEO 50 i.e. ('01/'04 -DI-TECH)	8,6	4658	OR.	OR.					
	SCARABEO 50 STREET (mot. Piaggio)	7,5	4659		5,7*					
	RALLY (air cooled)	6,5	4645	4,7		4,7*			4,7*	
	RALLY (liquid cooled)	6,5	4645	4,7		4,3*			4,3*	
	GULLIVER (liquid cooled)	6,5	4645	4,7						
	HABANA 50 KAT (mod. '99/'03)	7,7	4658		4,6					
	SCARABEO 100	7,5	4645	6,3						
	SCARABEO 125	8,8	5650		OR.					8,0
	SCARABEO 150	9,5	5650		OR.					OR.
	SCARABEO 200 (fino al '02)	10,0	5650							8,5
	LEONARDO 125 ST	8,3	5650							6,5

OR. = Utilizzare i rulli originali

\* = Kit molle per frizione comprese in confezione

● = Articolo in preparazione

## SCHEMA PESI PER KIT RULLI

	RULLI ORIGINALI	KIT LEOVINCE	RULLI GIA' INCLUSI IN CONFEZIONE							4ROAD
			SP3	TOURING	H.M. "ZX"	H.M. "Zxc"	H.M. "ZX-R"	H.M. "TT"	H.M. "GP"	
	grammi	articolo	grammi	grammi	grammi	grammi	grammi	grammi	grammi	grammi
<b>APRILIA</b>	LEONARDO 150 ST	9,0	5650							6,5
	LEONARDO 250	14,0	4674		OR.					
	LEONARDO 250 ST	12,0	4674							12,0
	SPORTCITY 125 (mod. '05)	7,3	6643							OR.
	SPORTCITY 200 (mod. '05)	10,6	5650							OR.
	SPORTCITY 300 (mod. '09/'10)	13,8	3410							12,5
	ATLANTIC 125 ('03)	7,2	5650							OR.
	ATLANTIC 200 ('03)	\	5650							10,0
<b>ATALA</b>	HACKER	5,5	4658	OR.						
	CAROSELLO	7,0	4645	5,0						
<b>BENELLI</b>	491 GT (air/liquid cooled)	6,6	4645			4,3*	4,3*		4,3*	
	491 RR (liquid cooled - mot. Minarelli)	6,5	4645		4,3*					
	491 ST (air cooled - mot. Minarelli)	6,5	4645		4,3*					
	491 RR (mod. '03 - l. c. - mot. Morini)	5,3	4658			4,0	4,0		4,0	
	491 ST (mod. '03/ '04 - a. c. - Morini)	5,3	4658			4,0	4,0		4,0	
	SPORT - RACING - SBK	6,6	4645			4,3*	4,3*		4,3*	
<b>BETA</b>	QUADRA	5,5	4645			4,3*	4,3*		4,3*	4,3*
	ARK (mod. '96/'03 - liquid cooled)	5,5	4645			4,3*	4,3*	4,3*	4,3*	4,3*
<b>CPI</b>	HUSSAR/OLIVER 50	-	4645			3,5			3,5	
	POPCORN 50	-	4645			3,5			3,5	
<b>DERBI</b>	HUNTER	6,3	4658	OR.						
	GP1 50 (liquid cooled)	5,3	4659			4,8*	4,8*	4,8*	4,8*	4,8*
	ATLANTIS 50 KAT ('99/'02 - a./l. cooled)	5,8	4658			OR.			OR.	
	ATLANTIS 50 KAT (air cooled)	6,3	4659			OR.	OR.		OR.	OR.
	PREDATOR 50 (air cooled)	6,2	4658			OR.			OR.	
	PREDATOR 50 (liquid cooled)	8,5	4658			6,0			6,0	
<b>GILERA</b>	TYPHOON - STORM 50	8,5	4646	6,2	5,5	5,7*			5,7*	5,7*
	TYPHOON 50 ('09)	6,5	4659		4,8	5,7			5,7	*
	EASY MOVING	8,5	4646	7,0						
	RUNNER 50	5,3	4659		OR.	OR.	OR.	OR.	OR.	4,3
	RUNNER 50 i.e. Purejet (mod.'02)	5,3	4659	OR.*	OR.*	4,8*	4,8*	4,8*	4,8*	4,8*
	RUNNER 50 Purejet (mod.'06 - Piaggio)	5,3	4659			4,8*	4,8*	4,8*	4,8*	4,8*
	STALKER 50	6,5	4659			OR.*	OR.*	OR.*	OR.*	OR.*
	DNA 50 KAT (mod. '00-'01)	7,5	4659			5,3*			5,3*	
	ICE 50 KAT (mod. '01)	7,5	4659	4,8*	5,7*	5,3*	5,3*		5,3*	
	RUNNER 180	15,5	5650		OR.	11,5				
	RUNNER 180 KAT	15,5	5650		OR.					
	RUNNER VXR 125 4T (mod. '02)	7,3	6643							5,3
	RUNNER VXR 125 4T (mod. '04/'05)	7,3	6643							OR.
	RUNNER VXR 180 4T (mod. '00)	10,6	5650		OR.					9,0
	RUNNER VXR 200 4T (mod. '02/'05)	10,6	5650							OR.
	<b>HONDA</b>	VISION	7,5	4646	6,2					
VISION MET-IN		8,5	4646	6,7						
SH - SCOOPY (fino al '95)		11,6	4646	OR.						
SH FIFTY (mod. '96)		9,0	4646	OR.	7,5					
GP-DIO-SC01 (HSC)-SP-SC-SR		8,5	4646	7,5						

OR. = Utilizzare i rulli originali

\* = Kit molle per frizione comprese in confezione

● = Articolo in preparazione

## SCHEMA PESI PER KIT RULLI

	RULLI ORIGINALI	KIT LEOVINCE	RULLI GIA' INCLUSI IN CONFEZIONE							
			SP3	TOURING	H.M. "ZX"	H.M. "ZXc"	H.M. "ZX-R"	H.M. "TT"	H.M. "GP"	4ROAD
	grammi	articolo	grammi	grammi	grammi	grammi	grammi	grammi	grammi	grammi
<b>HONDA</b>	HSC ZX (cil. verticale)	8,5	4646			6,7*				
	SJ 50 BALI	8,5	4646	6,7	OR.					
	SFX 50	9,0	4646	6,7	8,5	7,5*			7,5*	
	SKY	5,0	4646	OR.	OR.					
	SHADOW 50	9,0	4646	6,2						
	LIVE DIO ZX 50 (mod. Giappone)	8,5	4646			5,5*				
	X8R-S - X8R-X 50	5,0	4646	6,7	OR.	6,2*	6,2*		6,2*	6,2*
	PANTHEON 125 (mod. '03)	12,3	4145							10,5
	SH 125	\	\							OR.
	@ 125	11,8	4145							OR.
	PANTHEON 150 (mod. '03)	12,1	4145							10,5
	SH 150	12,3	4145							OR.
	@ 150	11,8	4145							10,5
	DYLAN 125 (mod. '04)	12,3	4145							8,5
	DYLAN 150	12,3	4145							8,5
	FORESIGHT 250 (fino al '99)	23,0	4675							OR.
	FORESIGHT 250 ('00/'02)	24,8	4675							20,0
	CN 250	23,0	4675		OR.					
	JAZZ 250	25,0	4675							24,0
	FORZA 250 X ('05)	27,1	4675							24,0
	SH 300 i.e.	19,0	4675							OR.
	SILVER WING 600	●	●							OR.
<b>ITALJET</b>	REPORTER - BAZOOKA	6,5	4645	5,3						
	PISTA - SCOOP (mod. '93)	6,5	4645	4,3						
	FORMULA 50 (fino al '97 - air cooled)	5,5	4658	OR.		OR.	OR.		OR.	
<b>KYMCO</b>	DJ Y	8,5	4646	7,5						
	SNIPER 50	7,5	4646	5,7						
	TOP BOY ON/OFF	8,6	4646			5,7	5,7		5,7	5,7
	PEOPLE 50 ECO KAT ('03/'04)	8,5	4646	7,5*	OR.					
	ZX SUPER FEVER 50 (mod. '04)	7,6	4647			OR.			OR.	OR.
	SUPER 9S 50 (mod. '05)	8,5	4646			5,7			5,7	5,7
	BET & WIN 150 (mod. '04)	●	4145							12,9
	DINK 200 (mod. '04)	●	4145							12,9
	GRAN DINK 250 (mod. '01/'02)	21,6	4675							OR.
	BET & WIN 250 (mod. '04)	20,0	4675							OR.
<b>LEM</b>	TORNADO SS1 - FLASH	6,5	4645	5,3						
<b>MALAGUTI</b>	CENTRO	7,0	4645	6,3						
	F 10 JET LINE (mod. '92/'98)	6,5	4645	4,7*	4,7*	5,0*	5,0*		5,0*	
	F 12 PHANTOM (air cooled)	6,5	4645	5,8	4,3*	4,7*	4,7*	4,7*	4,7*	4,7*
	F 12 PHANTOM (liquid cooled)	6,5	4645	OR.	4,3*	5,0*	5,0*	5,0*	5,0*	5,0*
	F 12 PHANTOM KAT ('99 - air/liquid c.)	6,5	4645		5,0	5,0*	5,0*	5,0*	5,0*	5,0*
	F 12 PHANTOM KAT (00 - liquid c.)	5,0	4645		OR.	OR.*	OR.*	OR.*	OR.*	OR.*
	F 12 R PHANTOM KAT (07 - liquid c.)	6,5	4645		4,3*	4,3*	4,3*	4,3*	4,3*	4,3*
	F 15 FIREFOX (mod. '96/'98)	6,5	4645	OR.	4,7*	5,8*	5,8*	5,8*	5,8*	5,8*
	F 15 (mod. '05 - liquid cooled)	6,0	4645		4,3	3,5	3,5	3,5	3,5	3,5
	F 15 (mod. '05 - air cooled)	6,5	4646			4,3*	4,3*	4,3*	4,3*	4,3*

OR. = Utilizzare i rulli originali

\* = Kit molle per frizione comprese in confezione

● = Articolo in preparazione

## SCHEMA PESI PER KIT RULLI

	RULLI ORIGINALI	KIT LEOVINCE	RULLI GIA' INCLUSI IN CONFEZIONE							
			SP3	TOURING	H.M. "ZX"	H.M. "Zxc"	H.M. "ZX-R"	H.M. "TT"	H.M. "GP"	4ROAD
	grammi	articolo	grammi	grammi	grammi	grammi	grammi	grammi	grammi	grammi
<b>MALAGUTI</b>	CR1 CROSSER (mod. '95/'98)	5,5	4658	OR.		4,6			4,6	
	F 12 PHANTOM 100 ('99/'00 - air c.)	11,6	4658		7,7	7,7				
	F18 WARRIOR 125 (4T - mod. '00/'02)	15,3	4145							9,8
	MADISON S 250 ('02)	14,1	4674							12,0
	MADISON K 400 ('02)	17,8	5649							15,0
<b>MBK</b>	BOOSTER	6,5	4645	4,3	4,3	4,3*	4,3*	4,3*	4,3*	4,3*
	BOOSTER NEXT GEN. - ROCKET	7,0	4645	4,7	5,8	5,8*	5,8*	5,8*	5,8*	5,8*
	BOOSTER 50 KAT (mod. '04)	5,5	4645	6,3*	4,7*	4,7*	4,7*	4,7*	4,7*	4,7*
	SPIRIT	7,0	4645	4,7		5,8*	5,8*	5,8*	5,8*	5,8*
	SORRISO (SUPERSPORT)	6,5	4645	5,3						
	TARGET	6,5	4645	5,3						
	EVOLIS	7,5	4645	4,7*						
	FIZZ	7,0	4645	4,7*						
	FORTE	7,5	4645	4,7*						
	STUNT (mod. '00/'02)	6,0	4645		4,3	4,3*	4,3*	4,3*	4,3*	4,3*
	OVETTO	6,5	4645		4,7*					
	NITRO	5,5	4645		4,7*	4,3*	4,3*		4,3*	4,3*
	NITRO KAT (mod. '00)	6,5	4645		4,7*	4,3*	4,3*		4,3*	4,3*
	BOOSTER 100 (mod. '99/'01)	8,5	4645		7,7	7,7				
	SKYLINER 125 (fino al '00)	9,2	5648		OR.					
	SKYLINER 125 ('01)	●	5648							7,7
	SKYLINER 125 i.e. ('07/'09)	●	5648							9,2
	SKYLINER 250 (fino al '99)	12,0	4674							OR.
	SKYLINER 250 (mod. '00)	12,0	4674							9,9
<b>PEUGEOT</b>	ST	7,5	4646	6,2						
	SV 50 GEO	11,0	4646	9,0						
	SV 50 GEO (mod. '94)	8,5	4646	6,7						
	ZENITH - BUXY - SPEEDAKE	8,5	4646	6,7	OR.	6,7*			6,7*	
	BUXI M	9,0	4646			8,5*	8,5*	8,5*	8,5*	8,5*
	SQUAB	9,0	4646	OR.	8,0*	8,5*	8,5*	8,5*	8,5*	8,5*
	TREKKER 50	8,8	4646	OR.		OR.*	OR.*	OR.*	OR.*	OR.*
	VIVACITY 50 (air cooled)	8,8	4646	OR.	8,0*	8,5*	8,5*	8,5*	8,5*	8,5*
	SPEEDFIGHT 50 (air cooled)	9,0	4646		OR.*	OR.*	OR.*	OR.*	OR.*	OR.*
	SPEEDFIGHT 50 (liquid cooled)	9,0	4646	8,5	OR.*	OR.*	OR.*	OR.*	OR.*	OR.*
	SPEEDFIGHT 2 50 (liquid cooled)	9,0	4646			OR.*	OR.*	OR.*		OR.*
	X-FIGHT 50 KAT (mod. '01 - liquid cool.)	9,0	4646		OR.*	OR.*	OR.*	OR.*	OR.*	OR.*
	X-FIGHT 50 WRC ( '02/'03 - liquid cool.)	9,0	4646			6,7*	6,7*	6,7*	6,7*	6,7*
	JET FORCE 50 (mod. '03)	7,8	4646			OR	OR	OR	OR	OR
	JET FORCE C-TECH 50 (mod. '05)	8,0	4646			OR	OR	OR	OR	OR
	METAL-X 50 (mod. '03)	9,0	4646		8,0*	7,5	7,5	7,5	7,5	7,5
	LUDIX 50 ONE (mod. '04 - air c.)	9,0	4646			OR.	OR.	OR.	OR.	OR.
	LUDIX BLASTER 50 (mod. '05 - l. cooled)	8,0	4646			6,2	6,2	6,2	6,2	6,2
	ELYSEO 100	8,8	●							
	SPEEDFIGHT 100	8,8	●							
	ELYSTAR 125	6,8	5650							6,5
	JET FORCE 125 (mod. '03)	6,8	5650							5,0

OR. = Utilizzare i rulli originali

\* = Kit molle per frizione comprese in confezione

● = Articolo in preparazione

## SCHEMA PESI PER KIT RULLI

	RULLI ORIGINALI	KIT LEOVINCE	RULLI GIA' INCLUSI IN CONFEZIONE							
			SP3	TOURING	H.M. "ZX"	H.M. "ZXc"	H.M. "ZX-R"	H.M. "TT"	H.M. "GP"	4ROAD
	grammi	articolo	grammi	grammi	grammi	grammi	grammi	grammi	grammi	grammi
<b>PGO</b>	BIG MAX 50 (mod. '04)	4646							4,7*	
<b>PIAGGIO</b>	SFERA 50 (1° serie - fino al '94)	5,2	4647	4,3						
	SFERA 50 (2° serie - dal '95)	8,5	4646	6,7	6,7					
	ZIP	5,2	4647	4,0						
	ZIP FAST RIDER	8,5	4646	7,0	7,5*	7,0*	7,0*	7,0*	7,0*	7,0*
	FREE	8,5	4646	7,5	OR.					
	ZIP SP	7,0	4646		OR.	6,2*		6,2*		
	ZIP KAT (mod. '99 - air cooled)	8,5	4646			7,0*	7,0*	7,0*	7,0*	7,0*
	ZIP KAT (mod. '00 - air cooled)	7,5	4659	4,8*	6,5*	5,3*	5,3*	5,3*	5,3*	5,3*
	ZIP KAT (mod. '09)	7,5	4659		OR.	OR.	OR.	OR.	OR.	5,3*
	NRG - NTT	8,5	4646	5,5	5,5	6,7*	6,7*	6,7*	6,7*	6,7*
	NRG=mc <sup>2</sup> (mod. '97)	7,0	4646	OR.	OR.	6,2	6,2	6,2	6,2	6,2
	NRG=mc <sup>2</sup> (mod. '98)	5,5	4659	4,3	4,8	OR.	OR.	OR.	OR.	OR.
	NRG=mc <sup>2</sup> (mod. '99) (air cooled)	6,5	4659	5,7	OR.	5,3*	5,3*	5,3*	5,3*	5,3*
	NRG=mc <sup>2</sup> (mod. '99) (liquid cooled)	6,3	4659	5,7	4,8	6,0*	6,0*	6,0*	6,0*	6,0*
	NRG=mc <sup>2</sup> EXTREME (mod. '00-liquid c.)	5,3	4659	4,8	4,8*	OR.*	OR.*	OR.*	OR.*	OR.*
	NRG=mc <sup>3</sup> KAT (mod. '01)	5,3	4659			4,8*	4,8*	4,8*	4,8*	4,8*
	NRG 50 POWER DD (mod. carb)	6,3	4659			4,8*	4,8*	4,8*	4,8*	4,8*
	NRG PUREJET 50 POWER (mod. '05)	5,3	4659			4,8*	4,8*	4,8*	4,8*	4,8*
	VESPA 50 ET2 (mod. '97)	8,5	4646	7,5	7,5					
	VESPA 50 ET2 (mod. '98)	6,5	4659	5,7	OR.					
	VESPA 50 ET2 KAT (2° serie-mod. '00)	6,5	4659	5,7*						
	LIBERTY 50	6,5	4659	OR.	OR.					
	FLY 50 (mod. '05)	7,5	4659			5,3*	5,3*		5,3*	
	LIBERTY 125	12,0	5651		OR.					
	MP3 125 (mod. '07)	7,3	6643							5,0
	X8 125 (mod. '04/'06)	7,4	6643							OR.
	X9 125	7,3	6643							5,0
	X9 180 AMALFI	11,0	5650							9,0
	BEVERLY 200	10,8	5650							9,5
	X8 200 (mod. '04)	10,6	5650							9,0
	BEVERLY 250 (mod. '04)	11,1	5650							9,5
	X9 250 (motore Honda - fino al '03)	25,1	4675		OR.					21,5
	X9 500 - X9 500 EVOLUTION ('03)	●	●							OR.
<b>SUZUKI</b>	ADDRESS - AP 50	6,6	4658	OR.						
	AJ 50 ZZ (SEPIA)	6,6	4658	OR.						
	AY 50 KATANA (air cooled - fino '02)	7,2	4658		4,6	5,2	5,2		5,2	
	AY 50 KATANA (liquid cooled - fino '02))	11,3	4658		4,6	4,0	4,0		4,0	
	AN 125 BURGMAN (mod. '04)	12,9	4145							10,5
	AN 150 BURGMAN (mod. '03)	16,8	4145							12,9
	AN 250 BURGMAN	31,0	4675							25,0
	AN 400 BURGMAN ('99/'02)	21,0	5649							OR.
	AN 400 BURGMAN i.e. ('03/'05)	19,0	5649							OR.
<b>YAMAHA</b>	CT 50 S	6,5	4645	5,3						
	CR 50 Z	6,5	4645	5,3						
	BW'S	6,5	4645	4,3	4,3	4,3*	4,3*	4,3*	4,3*	4,3*

OR. = Utilizzare i rulli originali

\* = Kit molle per frizione comprese in confezione

● = Articolo in preparazione

## SCHEMA PESI PER KIT RULLI

RULLI ORIGINALI	KIT LEOVINCE	RULLI GIA' INCLUSI IN CONFEZIONE								
		SP3	TOURING	H.M. "ZX"	H.M. "ZXc"	H.M. "ZX-R"	H.M. "TT"	H.M. "GP"	4ROAD	
grammi	articolo	grammi	grammi	grammi	grammi	grammi	grammi	grammi	grammi	
<b>YAMAHA</b>	BW'S NEXT GENERATION	7,0	4645	4,7	5,8	5,8*	5,8*	5,8*	5,8*	5,8*
	BW'S N.G. 50 KAT (mod. '02)	7,0	4645	4,3*	4,7*	OR.*	OR.*	OR.*	OR.*	OR.*
	BW'S 50 KAT (mod. '04)	5,5	4645	6,3*	4,7*	4,7*	4,7*	4,7*	4,7*	4,7*
	YE 50 ZEST	7,5	4645	4,7*						
	BREEZE	7,0	4645	4,7*						
	JOG - AXIS	6,5	4645	4,7*	4,7*	5,0*	5,0*		5,0*	
	NEO'S	6,5	4645		4,7*					
	SLIDER	6,0	4645		4,3	4,3*	4,3*	4,3*	4,3*	4,3*
	SUPER JOG ZR 50 (mod. Giappone)	7,7	4645			5,0*		5,0*		
	AEROX 50	5,5	4645		4,7*	4,3*	4,3*	4,3*	4,3*	4,3*
	AEROX 50 KAT (mod. '00-'01)	6,5	4645		4,7*	4,3*	4,3*	4,3*	4,3*	4,3*
	AEROX 50 KAT (mod. '04)	5,6	4645		5,0*	4,3*	4,3*	4,3*	4,3*	4,3*
	WHY 50 KAT (air cooled)	6,5	4645	4,3*	5,0*					
	JOG 50 R (mod. '04 - air cooled)	6,5	4645			5,0*	5,0*		5,0*	
	BW'S 100	8,5	4645		7,7	7,7				
	AEROX 100 KAT	9,6	4645		7,7	7,7	7,7			
	YP 125 R MAJESTY (fino al '00)	9,2	5648							OR.
	YP 125 R MAJESTY (mod. '01)	10,0	5648							7,7
	YP 150 R MAJESTY (mod. '01)	11,0	5648							7,7
	YP 180 MAJESTY (mod. '04)	16,0	5648							14,0
	YP 250 MAJESTY (fino al '99)	14,0	4674		OR.					OR.
	YP 250 MAJESTY DX - DX ABS ('99)	14,0	4674		OR.					12,7
	YP 250 MAJESTY DX (mod. '00)	12,0	4674							9,9
	X-CITY 250 i.e.	10,0	4674							10,6
	X-MAX 250 (mod. '06)	10,0	4674							10,6
	VERSITY 300 (mod. '03)	16,0	4674							14

OR. = Utilizzare i rulli originali

\* = Kit molle per frizione comprese in confezione

● = Articolo in preparazione



## NOTE

## NOTE



# LeoVince<sup>®</sup>

R I D E . D O M I N A T E . R O A R .

Distribuito da

**M**otorparts S.r.l.

Via Aldina, 26 - 40012 Lippo di Calderara di Reno (BO)

Tel.: +39 051 725442 - Fax: +39 051 725449

Email: [info@motor-parts.it](mailto:info@motor-parts.it) - [motorparts.it](http://motorparts.it)



[www.leovince.com](http://www.leovince.com)

