

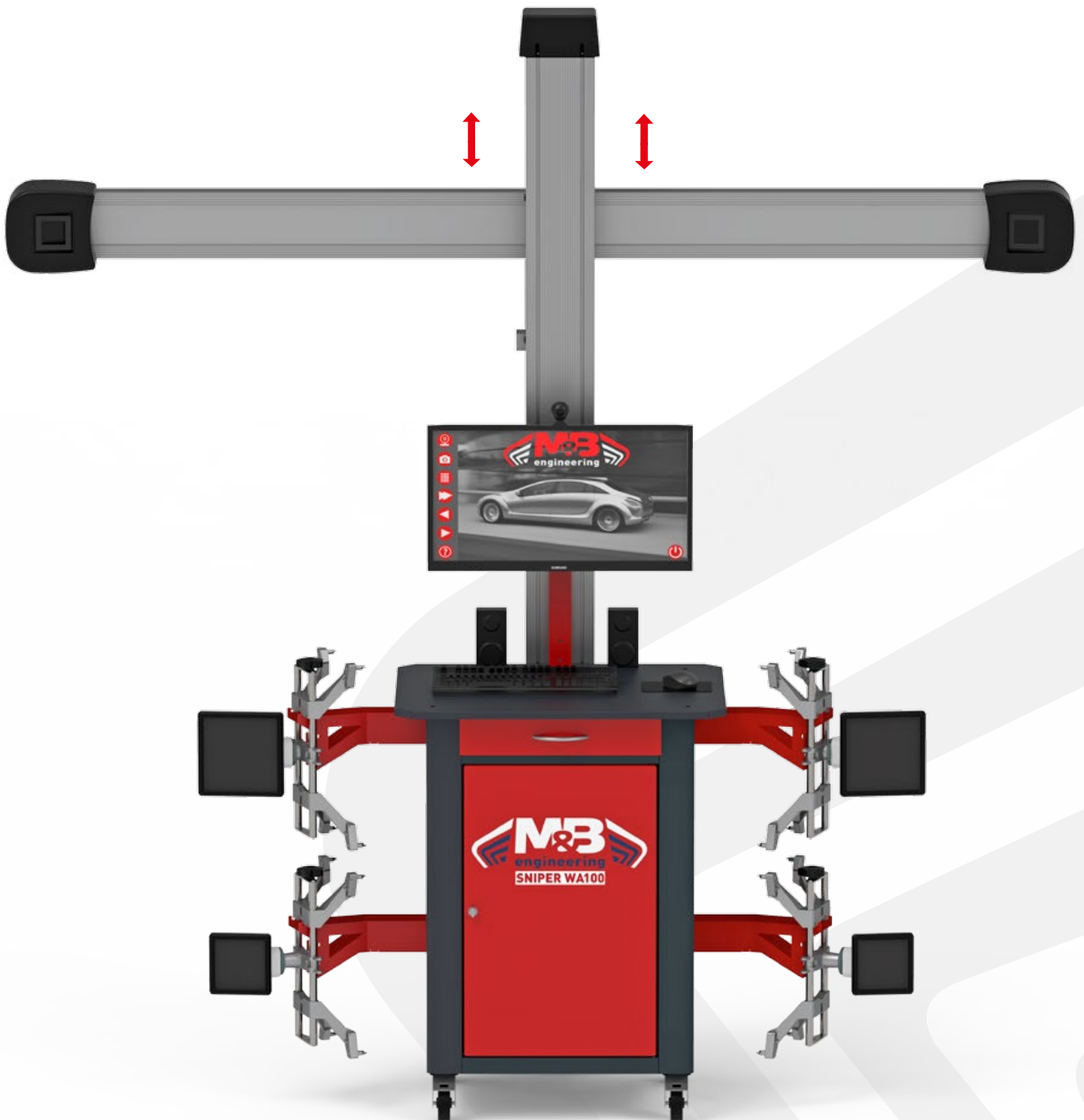







# Sniper WA100





3D HD wheel alignment for maximum precision







# Sniper WA100

-  **M&B SNIPER WA100** high-precision 3D wheel aligner, designed to ensure real-time reliable results thanks to fast and intuitive automation
-  **M&B SNIPER WA100** è l'assetto ruote 3D di alta precisione, studiato per garantire risultati affidabili in tempo reale grazie ad un'automazione rapida e intuitiva
-  **M&B SNIPER WA100** est l'alignement des roues 3D haute précision, imaginée pour garantir des résultats fiables en temps réel grâce à une automatisation rapide et intuitive
-  **M&B SNIPER WA100** ist eine hochpräzise 3D-Achsmessgerät, die dank einer schnellen und intuitiven Automatisierung zuverlässige Ergebnisse in Echtzeit gewährleistet
-  **M&B SNIPER WA100** es el alineamiento ruedas 3D de precisión elevada, estudiado para garantizar resultados de confianza en tiempo real gracias a una automatización rápida e intuitiva

## FEATURES

-  **Mobile cameras: automatic adjustment** in the correct position according to the lift height  
**Full performance** with wheelbase, track and diagonal, wheel diameter, caster angle and friction range measurements  
**Measurements with 2 targets** for long vehicles  
**Single raised wheel run-out:** useful in small spaces  
**Identification of driving problems,** resulting from measures not contemplated in the specifications  
**User-friendly interface:** using it and printing the final report are quick and easy
-  **Telecamere mobili: regolazione automatica** nella posizione corretta in base all'altezza del ponte  
**Prestazioni complete** con misure di passo, carreggiata, diagonali, diametro ruote, braccio a terra e raggio d'attrito  
**Misura con 2 targets** in caso di veicoli lunghi  
**Run-out a ruota singola sollevata:** utile in mancanza di spazio  
**Diagnosi dei disturbi di guida** conseguenti a misure rilevate fuori specifica  
**Interfaccia intuitiva:** l'utilizzo e la stampa del report finale sono facili e veloci
-  **Caméras mobiles : réglage automatique** dans la position correcte en fonction de la hauteur de l'élévateur  
**Performances complètes** avec mesures de pas, largeur et diagonales, du diamètre des roues, de bras à terre et rayon de frottement  
**Mesure avec 2 cibles** pour les véhicules longs  
**Mesure de l'excentricité à roue indépendante soulevée** utile en manque d'espace  
**Diagnostic des problèmes de conduite** à la suite de mesures hors spécification  
**Interface intuitive :** l'utilisation ainsi que l'impression du rapport final sont rapides et faciles
-  **Mobile Kameras: Automatische Einstellung** in der richtigen Position auf der Grundlage der Brückenhöhe  
**Volle Leistungen** mit Messung von Radstand, Spurweite und Diagonalen, des Raddurchmessers, von Caster und Reibungsradius  
**Messung mit 2 Zielscheiben** für lange Fahrzeuge  
**Run-out am einzelnen angehobenen Rad** nützlich bei Platzmangel  
**Die Diagnose der Fahrstörungen** infolge von Messungen außerhalb der Toleranz  
**Intuitive Benutzeroberfläche:** Die Verwendung und das Drucken des Abschlussberichts sind schnell und einfach
-  **Telecámaras móviles: ajuste automático** en posición correcta de acuerdo con la altura del elevador  
**Prestaciones completas** con medida de paso, superficie de rodadura, diagonales, del diámetro de las ruedas, de brazo en el suelo y radio de rozamiento  
**Medida con 2 puntos de referencia** en vehículos largos  
**Desviación con una rueda levantada** útil si falta espacio  
**Diagnóstico de problemas de conducción** debidos a medidas que no cumplen las especificaciones  
**Interfaz intuitiva:** el uso y la impresión del informe final son rápidos y fáciles

## DURABLE TARGETS

-  **Targets with reduced dimensions;** no electronic components
-  **Bersagli di dimensioni ridotte;** nessun componente elettronico
-  **Cibles compactes;** pas de composants électroniques
-  **Kompakte Zielscheiben;** Keine elektronischen Komponenten
-  **Objetivos compactos;** ningún componentes electrónicos



# 3D HD wheel alignment for maximum precision

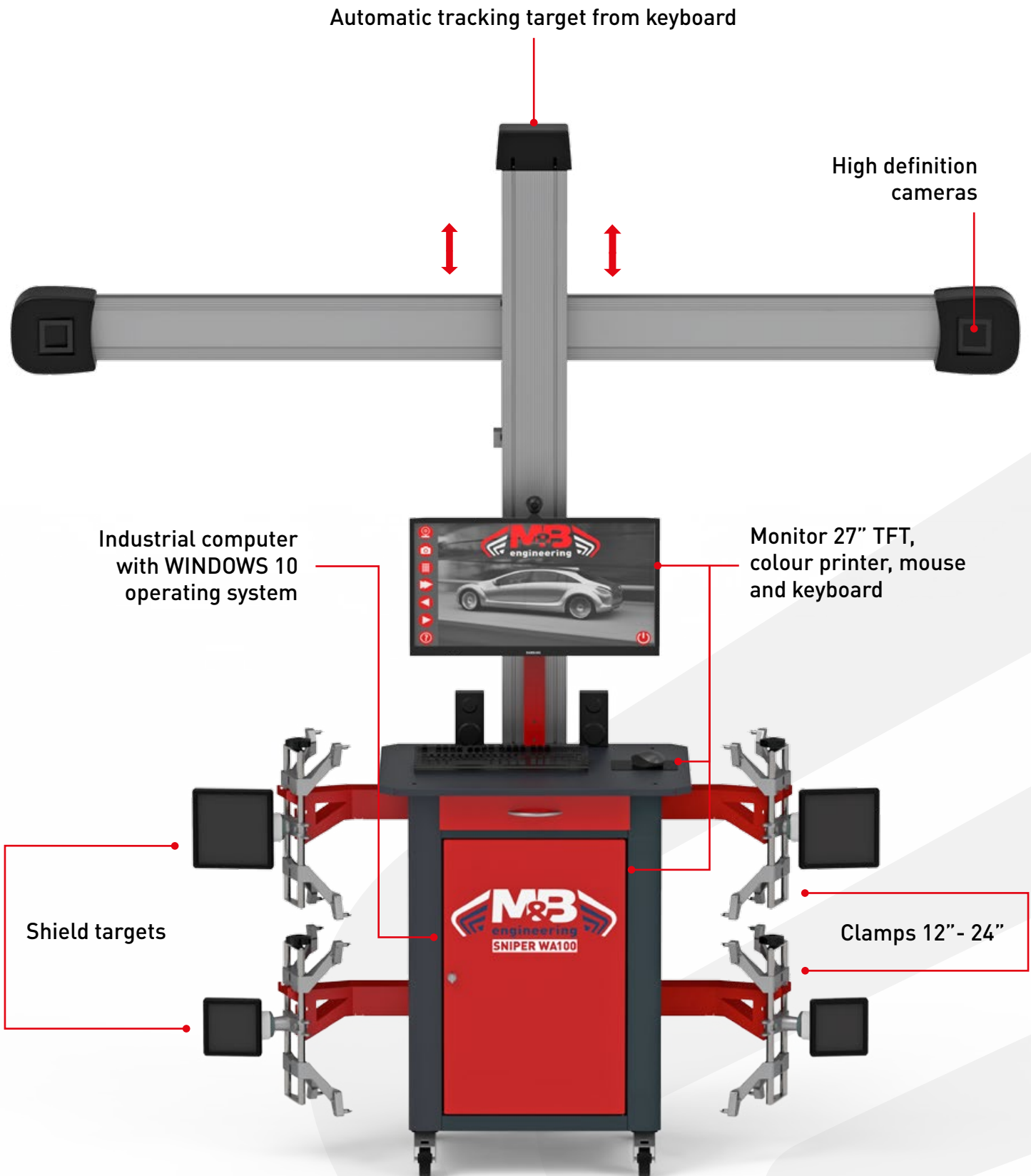

## STANDARD CONFIGURATION











-  Four self-centering clamps 12"-24" with universal grips  
Brake pedal, steering wheel holder, two wedge blocks  
Two mechanical turning plates
-  Quattro aggrappi autocentranti 12"-24"  
con unghiette universali  
Premipedale, bloccasterzo, due tamponi  
Coppia di piatti rotanti meccanici
-  Quatre griffes à 4 points 12"-24" avec ongles universels  
Presseur pédale, blocage direction, tampons  
Deux plateaux pivotants mécaniques
-  4 Radklammern mit 4 Kontaktpunkten (12-24") mit  
Universalradklammerfingern  
Pedalbetätigung, Lenkradfeststeller, Tumpfers  
Zwei mechanische Drehplatten
-  Cuatro garras de 4 puntos de 12-24"  
con uñas universales  
Bloqueo de volante, depresor de freno,  
almohadillas  
Dos placas giratorias mecánicas



Optional up to 27"

## OPTIONAL ACCESSORIES



-  Premium turntables: two mechanical  
turntables and two paddles to ease  
the run-out operations
-  Piatti Premium: due piatti rotanti  
e due supporti in gomma per  
agevolare la manovra a spinta
-  Plateaux Premium : deux plateaux  
et deux entretoises caoutchouc pour  
une manoeuvre de pousse aisée
-  Premium-Teller: 2 Drehtellern und  
2 Gummiträgern für erleichterten  
Run-out-Vorgang
-  Platos Premium: dos platos giratorios  
y dos espaciadores de plástico para  
agilizar la manidora de alabeo
-  Frontal assistance webcam
-  Videocamera frontale
-  Caméra vidéo frontale d'aide
-  Vordere Hilfs-Videokamera
-  Videocámara delantera de ayuda

