

MOTORPARTS

YOUR QUALITY SUPPLIER



MOTOR PARTS

CATALOGO GENERALE
2020



TPR
FACTORY





EDIZIONE FEBBRAIO 2020

Immagini, dati e indicazioni tecniche contenute in questo catalogo non sono impegnative.
Motorparts si riserva di apportare, per aggiornamenti o migliorie, qualsiasi tipo di variazione anche senza preavviso.

Motorparts consiglia di consultare il sito motorparts.it per avere informazioni sempre aggiornate e complete.

Your Quality Supplier!

Motorparts è da sempre garanzia di affidabilità e innovazione nella progettazione di parti speciali, ricambi e accessori per le due ruote.

L'azienda nasce nel 1965 come distributore di ricambi originali per la Motori Minarelli, storico marchio d'eccellenza del motociclismo italiano di cui segue la tradizione di qualità e serietà.

Negli anni '90 amplia il suo raggio d'azione dedicandosi allo sviluppo di parti speciali da competizione attraverso il brand Top Performances, con alle spalle il lavoro incessante di un'avanzatissimo reparto Ricerca e Sviluppo, vero fiore all'occhiello dell'innovazione Motorparts.

Parallelamente si espande sul mercato della componentistica per ciclomotori acquisendo il marchio DR Racing Parts, che porta in dote nella famiglia Motorparts i know how relativi a sviluppo e distribuzione di kit Vespa e parti speciali scooter Piaggio, Honda e Peugeot.

La gamma prodotti distribuiti da Motorparts si rinnova e si evolve costantemente, come la rete di vendita, ramificata capillarmente in Italia ed in più di 40 paesi nel Mondo.



INDICE GENERALE



TPR
FACTORY



MERCHANDISING pag 12

APPLICABILITÀ

MOTO 50 cc	pag	16
SCOOTER 50 cc	pag	42
SCOOTER 50 cc RACING	pag	112
MAXI SCOOTER	pag	158
MOTO 125 cc	pag	256
ATV QUAD	pag	262
DR CLASSIC	pag	266
ELECTRIC PARTS	pag	276
MICROCAR	pag	338

TPR FACTORY

CARTER RACING	pag	356
---------------	-----	-----

TOP PERFORMANCES

ACCENSIONI	pag	362
ALBERI A CAMME	pag	365
ALBERI MOTORE	pag	366
CAMBIO COMPLETO	pag	365
CAMPANE FRIZIONI	pag	368
CARICA BATTERIE	pag	369
CARICATORI USB	pag	369
CINGHIE DI TRASMISSIONE TOP	pag	371
CONTAGIRI	pag	369
CONVERTITORI DI COPPIA	pag	374
COPERCHI	pag	375
CUSCINETTI	pag	370
DESMODROMICO CAMBIO	pag	365
FRIZIONI	pag	376
GRUPPI TERMICI MAGGIORATI	pag	385
GRUPPI TERMICI MAXI SCOOTER	pag	391
GRUPPI TERMICI RACING	pag	393
GRUPPI TERMICI STANDARD	pag	382
INGRANAGGI	pag	416



KIT ASPIRAZIONE	pag	399
KIT DI PROGRAMMAZIONE	pag	369
MASSE VARIATORE	pag	406
MOLLE CONTRASTO VARIATORE	pag	410
MOLLE FRIZIONE	pag	414
PIGNONI	pag	416
RAPPORTI	pag	417
REGOLATORE DI PRESSIONE	pag	417
SCARICHI COMPLETI	pag	418
SCARICHI GP	pag	418
SCARICHI NARDÒ 2	pag	419
VALVOLE LAMELLARI	pag	420
VARIATORI	pag	423

SPARE PARTS

SPARE PARTS

ACCENSIONI	pag	434
ALBERI ENTRATA MOTO	pag	662
ALBERI MESSA IN MOTO	pag	663
ALBERI MOTORE	pag	436
ALBERI USCITA MOTO	pag	662
ALTERNATORI	pag	444
AM6 RICAMBI MOTORE	pag	445
BATTERIE	pag	452
BIELLE	pag	453
BLOCCHI ACCENSIONE	pag	454
BOBINE	pag	455
CAMPANE FRIZIONE	pag	463
CARBURATORI	pag	468
CENTRALINE	pag	470
CINGHIE DI TRASMISSIONE	pag	471
COLLETTORI	pag	489
CONVOGLIATORI	pag	493
CUSCINETTI	pag	494
CUSCINETTI NTN	pag	500
CUSCINETTI SKF	pag	496
FILTRI ARIA	pag	507

SPARE PARTS

FILTRI OLIO	pag	514
FRIZIONI	pag	521
GABBIA	pag	664
GRUPPI INGRANAGGI SECONDARI	pag	665
INGRANAGGI AVVIAMENTO	pag	664
INTERMITTENZE	pag	665
KIT REVISIONE POMPA ACQUA	pag	528
KIT TAGLIANDO	pag	536
KIT TRASMISSIONE	pag	540
LAMPADE OSRAM	pag	544
LAMPADE TOPLIGHT	pag	545
MEMBRANE CARBURATORE	pag	552
MOLLE	pag	664
MOLLE A GAS	pag	555
MOTORINI AVVIAMENTO	pag	556
PARAOLI	pag	607
POMPE BENZINA	pag	608
PULEGGE VARIATORI	pag	610
REGOLATORI	pag	614
RUOTE LIBERE	pag	652
SCODELLINO	pag	664
SCOOTER 50 RICAMBI MOTORE	pag	662
SEGMENTI MAXI SCOOTER	pag	666
SERIE PARAOLI	pag	606
STATORI	pag	667
VALVOLE LAMELLARI	pag	673



DR CLASSIC

CILINDRETTI FRENO	pag	676
FILTRI BENZINA	pag	676
FRIZIONI	pag	677
GANASCE FRENO	pag	678
GRUPPI TERMICI	pag	681
GRUPPI TERMICI HIGH PERFORMANCE	pag	680
GUARNIZIONI ASPIRAZIONE	pag	696



GUARNIZIONI BASE CILINDRO	pag	696
GUARNIZIONI SCARICO	pag	696
SCARICHI PROMA	pag	697
SEGMENTI	pag	698
SERIE GUARNIZIONI	pag	694



SACHS		
COPERCHI SCATOLA FRIZIONE	pag	700
DISCHI FRIZIONE	pag	702
KIT FRIZIONE	pag	704
MOLLE A DIAFRAMMA	pag	704
SCATOLE FRIZIONE	pag	705
SPINGIDISCHI	pag	706



RECKLESS		
CONTRAPPESI MANUBRIO	pag	710
COVER FORO SPECCHI	pag	710
LEVA FRENO A MANO	pag	711
PEDALINE PASSEGGERO	pag	711
PROTEZIONE LEVA FRENO	pag	712
TAPPO FLUIDO FRENI	pag	712
TAPPO OLIO MOTORE	pag	713



XFORTE		
LINEA BICI	pag	720
LINEA CUSTOM	pag	719
LINEA MOTO	pag	716



MICROCAR		
AMMORTIZZATORI	pag	724
DISCHI FRENO	pag	736
KIT GIUNTI	pag	738
PASTIGLIE FRENO	pag	739
PINZE FRENO	pag	741
SEMIASSI	pag	742

MOTORPARTS

YOUR QUALITY SUPPLIER

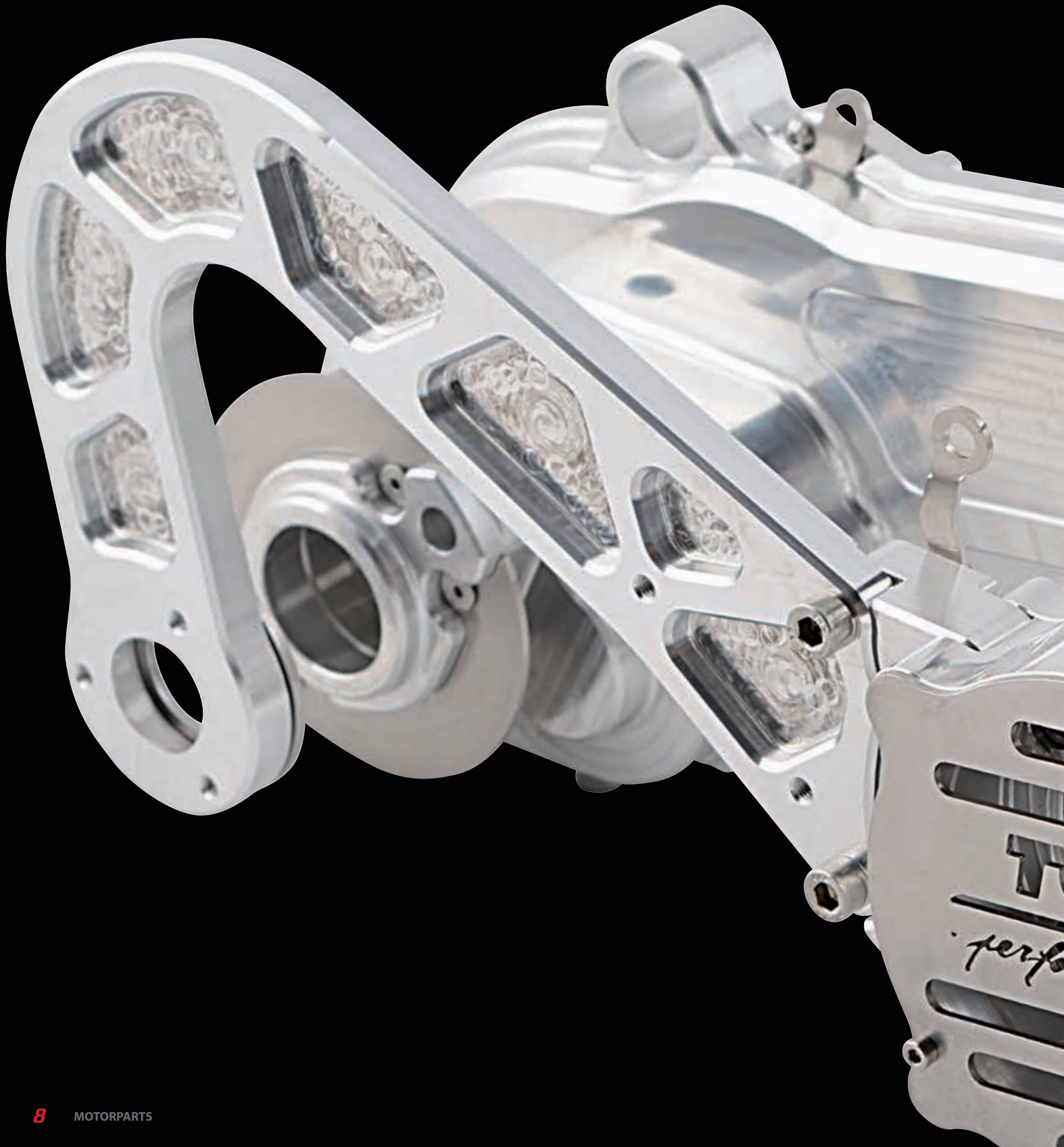

Motorparts scende in pista!

Motorparts ha presentato a EICMA 2019 il Carter Racing da competizione **TPR Factory** Il Carter più evoluto del mercato, il primo di una serie di prodotti progettati e realizzati con caratteristiche tecniche specifiche per l'uso in pista.

TPR
FACTORY

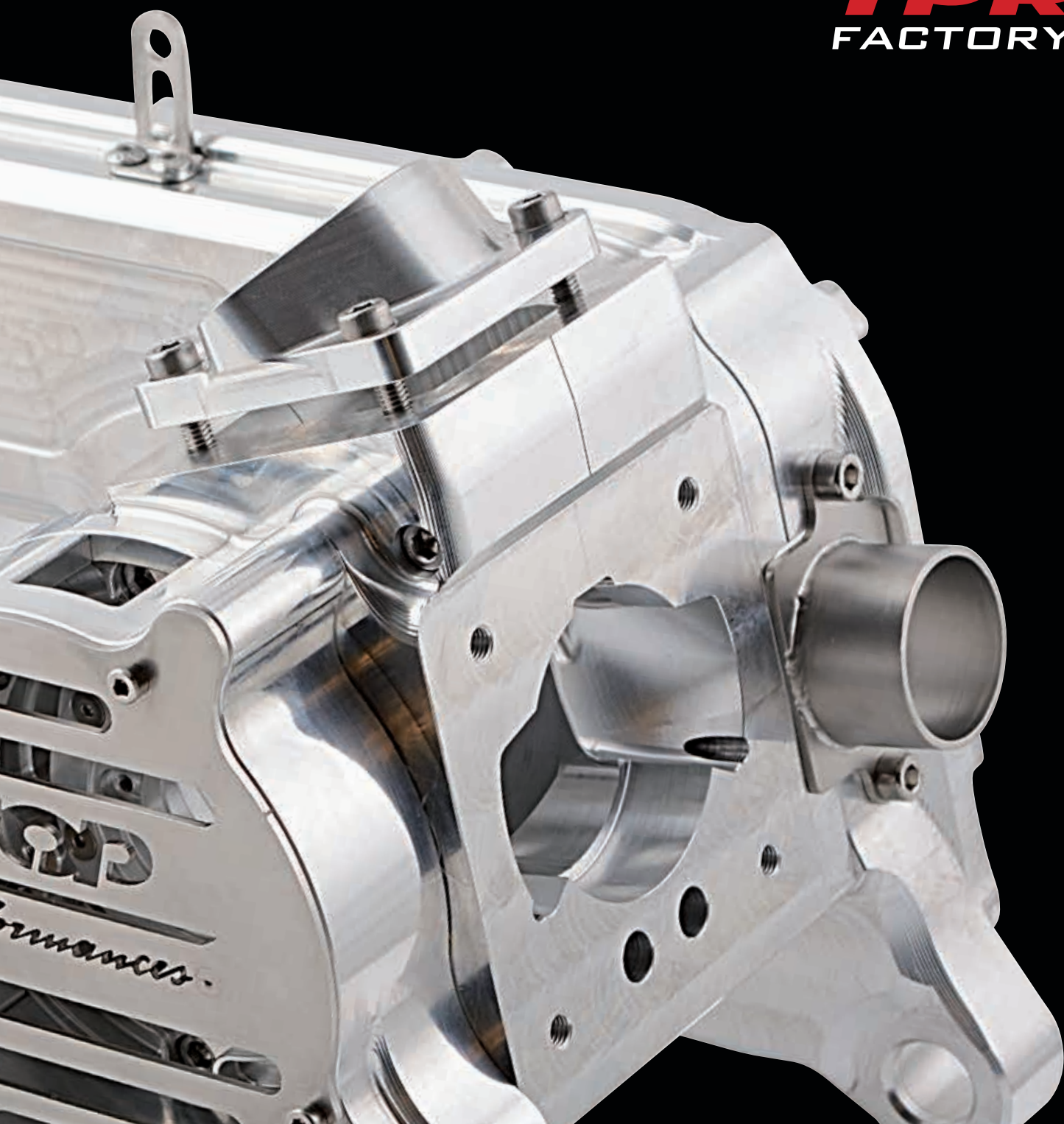

MOTORPARTS

YOUR QUALITY SUPPLIER



Your Quality Supplier!



DISTRIBUTORE UFFICIALE





MOTORPARTS

YOUR QUALITY SUPPLIER

Merchandising



▲ Cartella 18 Adesivi Assortiti

Dimensioni 21x29,7 cm

CODICE

99AD001



▲ LANYARD

CODICE

99ME004

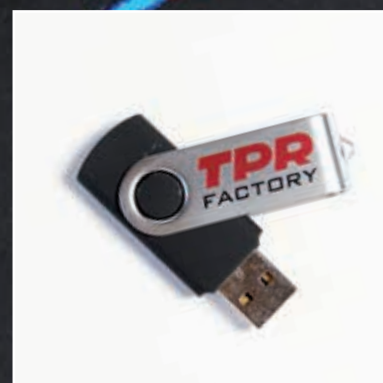

▲ SUPPORTO USB

CODICE

99ME005



▲
CAPPELLINO

Colore: NERO

CODICE

99ME003



▲
CAMICIA Stretch M/Lunga

75% COTONE - 25% ELASTAN
130 GR.

Colore: BIANCO – NERO

COD. TAGLIE

	NERO	BIANCO
S	99ME002S	99ME102S
M	99ME002M	99ME102M
L	99ME002L	99ME102L
XL	99ME002XL	99ME102XL



▲
GIACCA

92% POLIESTERE - 8% ELASTAN
340 GR.

Colore: NERO

COD. TAGLIE

S	99ME001S
M	99ME001M
L	99ME001L
XL	99ME001XL



gamma prodotti



APRILIA	APRILIA	APRILIA	APRILIA
CLASSIC	EUROPA	EUROPA	MX
92-99	90-90	91-92	04-04
50cc 2T LC	50cc 2T LC	50cc 2T LC	50cc 2T LC
AM 6	RV4	AM 3-4-5	AM 6

IT	EN	FR				
ALBERO MOTORE corsa 39 mm a piattelli pieni	Racing Crankshaft Stroke 39mm	VILEBREQUIN course 39 mm à contre-poids pleins		9921720	9921720	9921720
BIELLA Axe 16	CONROD Axle 16	BIELLE Axe 16		IM07033	IM07033	IM07033
BIELLA Axe 18	CONROD Axle 18	BIELLE Axe 18		IM07036	IM07036	IM07036
CAMBIO COMPLETO RACING	COMPLETE GEAR BOX RACING	BOÎTE DE VITESSES COMPLÈTE RACING		9935000		9935000
DESMODROMICO CAMBIO	SHIFT DRUM GEAR	BOÎTE DE VITESSES		9920020		9920020
CENTRALINA digitale ad ant. variabile volano Ducati 6 poli	CDI UNIT WITH VARIABLE ADVANCE (Ducati 6 coils)	BOÎTE ÉLECTRONIQUE numérique à avance variable volant Ducati 6 pôles		9921690	9921690	9921690
CENTRALINA RACING EU4	RACING EU4 CONTROL UNIT	BOÎTIER ÉLECTRONIQUE RACING EU4				
CUSCINETTI DI BANCO TPR Carbonirurati Serie	BEARINGS TPR Carbonitrided	PALIERI DE VILEBREQUIN TPR Carbonitrurés Jeu		9929180	9929180	9929180
FRIZIONE A DENTI DRITTI	STRAIGHT TEETH CLUTCH	EMBAYAGE À DENTS DROITES		9918550	9918550	9918550
GRUPPO TERMICO Ø STD Ghisa	CYLINDER KIT Ø Standard (CAST IRON)	CYLINDRE COMPLET Ø STD Fonte		9916770	9916770	9916770
GRUPPO TERMICO Ø Maggiorato Ghisa	CYLINDER KIT BIG BORE (CAST IRON)	CYLINDRE COMPLET Ø Majoré Fonte		9919250	9919250	9919250
GRUPPO TERMICO RACING Ø 49,5 Ghisa	CYLINDER KIT RACING Ø 49,5 (CAST IRON)	CYLINDRE COMPLET RACING Ø 49,5 Fonte		9919240	9919240	9919240
GRUPPO TERMICO RACING Ø 49,5 Ghisa testa scomposta	CYLINDER KIT RACING Ø 49,5 (CAST IRON) Decomposable head	CYLINDRE COMPLET RACING Ø 49,5 Fonte culasse décomposée		9921150	9921150	9921150
GRUPPO TERMICO RACING Ø 50 alluminio	CYLINDER KIT RACING Ø 50 (ALUMINIUM)	CYLINDRE COMPLET RACING Ø 50 aluminium		9924130	9924130	9924130
GRUPPO TERMICO RACING Ø Standard Alluminio	CYLINDER KIT RACING Ø Standard (ALUMINIUM)	CYLINDRE COMPLET RACING Ø Standard Aluminium		9934500	9934500	9934500
INGRANAGGIO 6 VELOCITÀ AM6 1° Versione	GEAR 6° SPEED AM6 1° SERIES	ENGRENAGE 6 VITESSES 1° SERIE		9919080		9919080
INGRANAGGIO 6 VELOCITÀ AM6 2° Versione	GEAR 6° SPEED AM6 2° SERIES	ENGRENAGE 6 VITESSES 2° SERIE		9931910		9931910
KIT ASPIRAZIONE COMPLETO MIKUNI TM 24 TPR 360	COMPLETE MIKUNI INLET KIT TM 24 TPR 360	KIT ASPIRATION COMPLET MIKUNI TM 24 TPR 360		9930910	9930910	9930910
KIT ASPIRAZIONE COMPLETO OKO 28 TPR 360	COMPLETE INLET KIT OKO 28 TPR 360	KIT ASPIRATION COMPLET OKO 28 TPR 360		9931750	9931750	9931750
KIT FRIZIONE + TAMBURO	HOUSING CLUTCH KIT+ BOSS	KIT EMBRAYAGE + TAMBOUR		9931900	9931900	9931900
MAXI KIT RACING 85 cc ghisa Ø 49,5 corsa 44	MAXI KIT RACING 85cc CAST IRON Ø 49,5 stroke 44	MAXI KIT RACING 85 cc fonte Ø 49,5 course 44		9921450	9921450	9921450
MAXI KIT RACING 86 cc alluminio Ø 50 corsa 44	MAXI KIT RACING 86cc ALLUMINIUM Ø 49,5 stroke 44	MAXI KIT RACING 86 cc aluminium Ø 50 course 44		9924240	9924240	9924240
MOLLE FRIZIONE	CLUTCH SPRINGS	RESSORTS EMBRAYAGE		9920580	9920580	9920580
MOTORINO AVVIAMENTO	STARTER ENGINE	DÉMARREUR ÉLECTRIQUE		MA00018	MA00018	
SCARICO RACING omologato	RACING EXHAUST Approved	ÉCHAPPEMENT RACING homologué				
SERIE DISCHI frizione racing cellulosa/kevlar	CLUTCH PLATES RACING Cellulose/kevlar	JEU DISQUES embrayage racing cellulose/kevlar		9921180	9921180	9921180
SERIE DISCHI standard	CLUTCH PLATES Standard	JEU DISQUES standard		9920250	9920250	9920250
TRASDUTTORE per volano Ducati 6 poli	TRANSDUCER (Ducati 6 coils)	TRANSDUCTEUR pour volant Ducati 6 pôles		9910150	9910150	9910150
VALVOLA LAMELLARE	REED VALVE	CLAPET À LAMELLES		9906500	9906500	9906500
VALVOLA LAMELLARE TPR	REED VALVE TPR	CLAPET À LAMELLES TPR		9931600	9931600	9931600

APRILIA	APRILIA	APRILIA	APRILIA	APRILIA	APRILIA	APRILIA	APRILIA	APRILIA	APRILIA	APRILIA	APRILIA
MX.MOTARD	PEGASO	RS	RS	RS	RS	RS	RS4	RS4 REPLICA	RX	RX	RX
95-03	92-94	91-92	93-95	96-98	99-05	06-10	11-13	14-16	89-90	03-04	06-10
50cc 2T LC	50cc 2T LC	50cc 2T LC	50cc 2T LC	50cc 2T LC	50cc 2T LC	50cc 2T LC	50cc 2T LC	50cc 2T LC	50cc 2T LC	50cc 2T LC	50cc 2T LC
AM 6	AM 3-4-5	AM 3-4-5	AM 3-4-5-6	AM 6	AM 6	D50B1	D50B1	D50B1	RV4	AM 6	D50B1
9921720	9921720	9921720	9921720	9921720	9921720	9930150	9930150	9930150		9921720	9930150
IM07033	IM07033	IM07033	IM07033	IM07033	IM07033					IM07033	
IM07036	IM07036	IM07036	IM07036	IM07036	IM07036					IM07036	
9935000			9935000	9935000	9935000					9935000	
			9920020	9920020	9920020					9920020	
9921690	9921690	9921690	9921690	9921690	9921690					9921690	
9929180	9929180	9929180	9929180	9929180	9929180	9929190	9929190	9929190		9929180	9929190
9918550	9918550	9918550	9918550	9918550	9918550					9918550	
9916770	9916770	9916770	9916770	9916770	9916770	9927100	9927100	9927100		9916770	9927100
9919250	9919250	9919250	9919250	9919250	9919250	9927020	9927020	9927020		9919250	9927020
9919240	9919240	9919240	9919240	9919240	9919240					9919240	
9921150	9921150	9921150	9921150	9921150	9921150					9921150	
9924130	9924130	9924130	9924130	9924130	9924130					9924130	
9934500	9934500	9934500	9934500	9934500	9934500					9934500	
9919080			9919080	9919080	9919080					9919080	
9931910			9931910	9931910	9931910					9931910	
9930910	9930910	9930910	9930910	9930910	9930910	9930910	9930910	9930910		9930910	9930910
9931750	9931750	9931750	9931750	9931750	9931750	9931750	9931750	9931750		9931750	9931750
9931900	9931900	9931900	9931900	9931900	9931900					9931900	
9921450	9921450	9921450	9921450	9921450	9921450					9921450	
9924240	9924240	9924240	9924240	9924240	9924240	9934270	9934270	9934270		9924240	9934270
9920580	9920580	9920580	9920580	9920580	9920580	9923180	9923180	9923180		9920580	9923180
	MA00018	MA00018	MA00018	MA00018	MA00018	MA00015	MA00015				
9921180	9921180	9921180	9921180	9921180	9921180	9923190	9923190	9923190		9921180	9923190
9920250	9920250	9920250	9920250	9920250	9920250					9920250	
9910150	9910150	9910150	9910150	9910150	9910150					9910150	
9906500	9906500	9906500	9906500	9906500	9906500				9906500	9906500	
9931600	9931600	9931600	9931600	9931600	9931600				9931600	9931600	



APRILIA	APRILIA	APRILIA	APRILIA
RX	RX	RX 3-5 MARCE	RX ENDURO
06-13	14-16	91-94	95-03
50cc 2T LC	50cc 2T LC	50cc 2T LC	50cc 2T LC
D50B1	D50B1	AM 3-4-5	AM 6

IT	EN	FR					
ALBERO MOTORE corsa 39 mm a piattelli pieni	Racing Crankshaft Stroke 39mm	VILEBREQUIN course 39 mm à contre-poids pleins		9930150	9930150	9921720	9921720
BIELLA Axe 16	CONROD Axle 16	BIELLE Axe 16				IM07033	IM07033
BIELLA Axe 18	CONROD Axle 18	BIELLE Axe 18				IM07036	IM07036
CAMBIO COMPLETO RACING	COMPLETE GEAR BOX RACING	BOÎTE DE VITESSES COMPLÈTE RACING					9935000
DESMODROMICO CAMBIO	SHIFT DRUM GEAR	BOÎTE DE VITESSES					
CENTRALINA digitale ad ant. variabile volano Ducati 6 poli	CDI UNIT WITH VARIABLE ADVANCE (Ducati 6 coils)	BOÎTE ÉLECTRONIQUE numérique à avance variable volant Ducati 6 pôles				9921690	9921690
CENTRALINA RACING EU4	RACING EU4 CONTROL UNIT	BOÎTIER ÉLECTRONIQUE RACING EU4					
CUSCINETTI DI BANCO TPR Carbonitrurati Serie	BEARINGS TPR Carbonitrided	PALIERI DE VILEBREQUIN TPR Carbonitrurés Jeu		9929190	9929190	9929180	9929180
FRIZIONE A DENTI DRITTI	STRAIGHT TEETH CLUTCH	EMBAYAGE À DENTS DROITES				9918550	9918550
GRUPPO TERMICO Ø STD Ghisa	CYLINDER KIT Ø Standard (CAST IRON)	CYLINDRE COMPLET Ø STD Fonte		9927100	9927100	9916770	9916770
GRUPPO TERMICO Ø Maggiorato Ghisa	CYLINDER KIT BIG BORE (CAST IRON)	CYLINDRE COMPLET Ø Majoré Fonte		9927020	9927020	9919250	9919250
GRUPPO TERMICO RACING Ø 49,5 Ghisa	CYLINDER KIT RACING Ø 49,5 (CAST IRON)	CYLINDRE COMPLET RACING Ø 49,5 Fonte				9919240	9919240
GRUPPO TERMICO RACING Ø 49,5 Ghisa testa scomposta	CYLINDER KIT RACING Ø 49,5 (CAST IRON) Decomposable head	CYLINDRE COMPLET RACING Ø 49,5 Fonte culasse décomposée				9921150	9921150
GRUPPO TERMICO RACING Ø 50 alluminio	CYLINDER KIT RACING Ø 50 (ALUMINIUM)	CYLINDRE COMPLET RACING Ø 50 aluminium				9924130	9924130
GRUPPO TERMICO RACING Ø Standard Alluminio	CYLINDER KIT RACING Ø Standard (ALUMINIUM)	CYLINDRE COMPLET RACING Ø Standard Aluminium				9934500	9934500
INGRANAGGO 6 VELOCITÀ AM6 1° Versione	GEAR 6° SPEED AM6 1 st SERIES	ENGRENAGE 6 VITESSES 1 st SERIE					9919080
INGRANAGGO 6 VELOCITÀ AM6 2° Versione	GEAR 6° SPEED AM6 2 st SERIES	ENGRENAGE 6 VITESSES 2 st SERIE					9931910
KIT ASPIRAZIONE COMPLETO MIKUNI TM 24 TPR 360	COMPLETE MIKUNI INLET KIT TM 24 TPR 360	KIT ASPIRATION COMPLET MIKUNI TM 24 TPR 360		9930910	9930910	9930910	9930910
KIT ASPIRAZIONE COMPLETO OKO 28 TPR 360	COMPLETE INLET KIT OKO 28 TPR 360	KIT ASPIRATION COMPLET OKO 28 TPR 360		9931750	9931750	9931750	9931750
KIT FRIZIONE + TAMBURO	HOUSING CLUTCH KIT+ BOSS	KIT EMBRAYAGE + TAMBOUR				9931900	9931900
MAXI KIT RACING 85 cc ghisa Ø 49,5 corsa 44	MAXI KIT RACING 85cc CAST IRON Ø 49,5 stroke 44	MAXI KIT RACING 85 cc fonte Ø 49,5 course 44				9921450	9921450
MAXI KIT RACING 86 cc alluminio Ø 50 corsa 44	MAXI KIT RACING 86cc ALLUMINIUM Ø 49,5 stroke 44	MAXI KIT RACING 86 cc aluminium Ø 50 course 44		9934270	9934270	9924240	9924240
MOLLE FRIZIONE	CLUTCH SPRINGS	RESSORTS EMBRAYAGE		9923180	9923180	9920580	9920580
MOTORINO AVVIAMENTO	STARTER ENGINE	DÉMARREUR ÉLECTRIQUE					
SCARICO RACING omologato	RACING EXHAUST Approved	ÉCHAPPEMENT RACING homologué					
SERIE DISCHI frizione racing cellulosa/kevlar	CLUTCH PLATES RACING Cellulose/kevlar	JEU DISQUES embrayage racing cellulose/kevlar		9923190	9923190	9921180	9921180
SERIE DISCHI standard	CLUTCH PLATES Standard	JEU DISQUES standard				9920250	9920250
TRASDUTTORE per volano Ducati 6 poli	TRANSDUCER (Ducati 6 coils)	TRANSDUCTEUR pour volant Ducati 6 pôles				9910150	9910150
VALVOLA LAMELLARE	REED VALVE	CLAPET À LAMELLES				9906500	9906500
VALVOLA LAMELLARE TPR	REED VALVE TPR	CLAPET À LAMELLES TPR				9931600	9931600

APRILIA	APRILIA	APRILIA	APRILIA	APRILIA	APRILIA	BETA	BETA	BETA	BETA	BETA	CH HUSQUARNA
RX RACING	SX	SX	SX	SX LIMITED EDITION	TUONO	RR 2T 50 EU4	RR 50 RACING EU4	RR ALU	RR ENDURO	RR MOTARD	SM
03-06	06-10	06-13	14-16	14-16	03-04	18-20	18-20	08-12	06-17	06-17	00-10
50cc 2T LC	50cc 2T LC	50cc 2T LC	50cc 2T LC	50cc 2T LC	50cc 2T LC	50cc 2T LC	50cc 2T LC	50cc 2T LC	50cc 2T LC	50cc 2T LC	50cc 2T LC
AM 6	D50B1	D50B1	D50B1	D50B1	AM 6	AM 6	AM 6	AM 6	AM 6	AM 6	AM 6
9921720	9930150	9930150	9930150	9930150	9921720	9921720	9921720	9921720	9921720	9921720	9921720
IM07033					IM07033	IM07033	IM07033	IM07033	IM07033	IM07033	IM07033
IM07036					IM07036	IM07036	IM07036	IM07036	IM07036	IM07036	IM07036
					9935000	9935000	9935000	9935000	9935000	9935000	9935000
					9920020	9920020	9920020	9920020	9920020	9920020	9920020
9921690					9921690						9921690
						9934440	9934440				
9929180	9929190	9929190	9929190	9929190	9929180	9929180	9929180	9929180	9929180	9929180	9929180
9918550					9918550	9918550	9918550	9918550	9918550	9918550	9918550
9916770	9927100	9927100	9927100	9927100	9916770	9916770 KT00098	9916770 KT00098	9916770	9916770	9916770	9916770
9919250	9927020	9927020	9927020	9927020	9919250	9919250 KT00114	9919250 KT00114	9919250	9919250	9919250	9919250
9919240					9919240	9919240	9919240	9919240	9919240	9919240	9919240
9921150					9921150	9921150	9921150	9921150	9921150	9921150	9921150
9924130					9924130	9924130	9924130	9924130	9924130	9924130	9924130
9934500					9934500	9934500	9934500	9934500	9934500	9934500	9934500
					9919080	9919080	9919080	9919080	9919080	9919080	9919080
					9931910	9931910	9931910	9931910	9931910	9931910	9931910
9930910	9930910	9930910	9930910	9930910	9930910	9930910	9930910	9930910	9930910	9930910	9930910
9931750	9931750	9931750	9931750	9931750	9931750	9931750	9931750	9931750	9931750	9931750	9931750
9931900					9931900	9931900	9931900	9931900	9931900	9931900	9931900
9921450					9921450	9921450	9921450	9921450	9921450	9921450	9921450
9924240	9934270	9934270	9934270	9934270	9924240	9924240	9924240	9924240	9924240	9924240	9924240
9920580	9923180	9923180	9923180	9923180	9920580	9920580	9920580	9920580	9920580	9920580	9920580
					MA00018						
9921180	9923190	9923190	9923190	9923190	9921180	9921180	9921180	9921180	9921180	9921180	9921180
9920250					9920250	9920250	9920250	9920250	9920250	9920250	9920250
9910150					9910150						9910150
9906500					9906500	9906500	9906500	9906500	9906500	9906500	9906500
9931600					9931600	9931600	9931600	9931600	9931600	9931600	9931600

MOTO 50cc



CH HUSQUARNA	CH HUSQUARNA	CMC	CMC
WR	WSM	ENDURO	MOTARD
00-10	00-10	11-11	11-11
50cc 2T LC	50cc 2T LC	50cc 2T LC	50cc 2T LC
AM 6	AM 6	AM 6	AM 6

IT	EN	FR				
ALBERO MOTORE corsa 39 mm a piattelli pieni	Racing Crankshaft Stroke 39mm	VILEBREQUIN course 39 mm à contre-poids pleins		9921720	9921720	9921720
BIELLA Axe 16	CONROD Axle 16	BIELLE Axe 16		IM07033	IM07033	IM07033
BIELLA Axe 18	CONROD Axle 18	BIELLE Axe 18		IM07036	IM07036	IM07036
CAMBIO COMPLETO RACING	COMPLETE GEAR BOX RACING	BOÎTE DE VITESSES COMPLÈTE RACING		9935000	9935000	9935000
DESMODROMICO CAMBIO	SHIFT DRUM GEAR	BOÎTE DE VITESSES		9920020	9920020	9920020
CENTRALINA digitale ad ant. variabile volano Ducati 6 poli	CDI UNIT WITH VARIABLE ADVANCE (Ducati 6 coils)	BOÎTE ÉLECTRONIQUE numérique à avance variable volano Ducati 6 pôles		9921690	9921690	
CENTRALINA RACING EU4	RACING EU4 CONTROL UNIT	BOÎTIER ÉLECTRONIQUE RACING EU4				
CUSCINETTI DI BANCO TPR Carbonirurati Serie	BEARINGS TPR Carbonitrided	PALIERI DE VILEBREQUIN TPR Carbonitrurés Jeu		9929180	9929180	9929180
FRIZIONE A DENTI DRITTI	STRAIGHT TEETH CLUTCH	EMBAYAGE À DENTS DROITES		9918550	9918550	9918550
GRUPPO TERMICO Ø STD Ghisa	CYLINDER KIT Ø Standard (CAST IRON)	CYLINDRE COMPLET Ø STD Fonte		9916770	9916770	9916770
GRUPPO TERMICO Ø Maggiorato Ghisa	CYLINDER KIT BIG BORE (CAST IRON)	CYLINDRE COMPLET Ø Majoré Fonte		9919250	9919250	9919250
GRUPPO TERMICO RACING Ø 49,5 Ghisa	CYLINDER KIT RACING Ø 49,5 (CAST IRON)	CYLINDRE COMPLET RACING Ø 49,5 Fonte		9919240	9919240	9919240
GRUPPO TERMICO RACING Ø 49,5 Ghisa testa scomposta	CYLINDER KIT RACING Ø 49,5 (CAST IRON) Decomposable head	CYLINDRE COMPLET RACING Ø 49,5 Fonte culasse décomposée		9921150	9921150	9921150
GRUPPO TERMICO RACING Ø 50 alluminio	CYLINDER KIT RACING Ø 50 (ALUMINIUM)	CYLINDRE COMPLET RACING Ø 50 aluminium		9924130	9924130	9924130
GRUPPO TERMICO RACING Ø Standard Alluminio	CYLINDER KIT RACING Ø Standard (ALUMINIUM)	CYLINDRE COMPLET RACING Ø Standard Aluminium		9934500	9934500	9934500
INGRANAGGIO 6 VELOCITÀ AM6 1° Versione	GEAR 6° SPEED AM6 1° SERIES	ENGRENAGE 6 VITESSES 1° SERIE		9919080	9919080	9919080
INGRANAGGIO 6 VELOCITÀ AM6 2° Versione	GEAR 6° SPEED AM6 2° SERIES	ENGRENAGE 6 VITESSES 2° SERIE		9931910	9931910	9931910
KIT ASPIRAZIONE COMPLETO MIKUNI TM 24 TPR 360	COMPLETE MIKUNI INLET KIT TM 24 TPR 360	KIT ASPIRATION COMPLET MIKUNI TM 24 TPR 360		9930910	9930910	9930910
KIT ASPIRAZIONE COMPLETO OKO 28 TPR 360	COMPLETE INLET KIT OKO 28 TPR 360	KIT ASPIRATION COMPLET OKO 28 TPR 360		9931750	9931750	9931750
KIT FRIZIONE + TAMBURO	HOUSING CLUTCH KIT+ BOSS	KIT EMBRAYAGE + TAMBOUR		9931900	9931900	9931900
MAXI KIT RACING 85 cc ghisa Ø 49,5 corsa 44	MAXI KIT RACING 85cc CAST IRON Ø 49,5 stroke 44	MAXI KIT RACING 85 cc fonte Ø 49,5 course 44		9921450	9921450	9921450
MAXI KIT RACING 86 cc alluminio Ø 50 corsa 44	MAXI KIT RACING 86cc ALLUMINIUM Ø 49,5 stroke 44	MAXI KIT RACING 86 cc aluminium Ø 50 course 44		9924240	9924240	9924240
MOLLE FRIZIONE	CLUTCH SPRINGS	RESSORTS EMBRAYAGE		9920580	9920580	9920580
MOTORINO AVVIAMENTO	STARTER ENGINE	DÉMARREUR ÉLECTRIQUE				
SCARICO RACING omologato	RACING EXHAUST Approved	ÉCHAPPEMENT RACING homologué				
SERIE DISCHI frizione racing cellulosa/kevlar	CLUTCH PLATES RACING Cellulose/kevlar	JEU DISQUES embrayage racing cellulose/kevlar		9921180	9921180	9921180
SERIE DISCHI standard	CLUTCH PLATES Standard	JEU DISQUES standard		9920250	9920250	9920250
TRASDUTTORE per volano Ducati 6 poli	TRANSDUCER (Ducati 6 coils)	TRANSDUCTEUR pour volano Ducati 6 pôles		9910150	9910150	
VALVOLA LAMELLARE	REED VALVE	CLAPET À LAMELLES		9906500	9906500	9906500
VALVOLA LAMELLARE TPR	REED VALVE TPR	CLAPET À LAMELLES TPR		9931600	9931600	9931600

DERBI	DERBI	DERBI	DERBI	DERBI	DERBI	DERBI	DERBI	DERBI	DERBI	DERBI	DERBI
BULTACO LOBITO	GPR 2T	GPR 2T EU2	GPR NUDE	GPR NUDE & GPR NUDE TUNING	GPR NUDE SPORT	GPR R	GPR R EU2 - GPR REPLICA EU2	GPR RACING	GPR RACING EU2	GPR REPLICA	GPR REPLICA & GPR R EU2
98-01	13-13	09-10	04-05	06-08	06-06	97-00	08-08	04-05	06-06	99-01	06-06
50cc 2T LC	50cc 2T LC	50cc 2T LC	50cc 2T LC	50cc 2T LC	50cc 2T LC	50cc 2T LC	50cc 2T LC	50cc 2T LC	50cc 2T LC	50cc 2T LC	50cc 2T LC
	D50B0	D50B0	EBE050	D50B0	D50B0	EBE050	D50B0	EBE050	D50B0	EBE050	D50B0
	9930150	9930150		9930150	9930150		9930150		9930150		9930150
9929190	9929190	9929190	9929190	9929190	9929190	9929190	9929190	9929190	9929190	9929190	9929190
9917400 9927980	9927100	9927100	9917400 9927980	9927100	9927100	9917400 9927980	9927100	9917400 9927980	9927100	9917400 9927980	9927100
9917390	9927020	9927020	9917390 9928030	9927020	9927020	9917390 9928030	9927020	9917390 9928030	9927020	9917390 9928030	9927020
9930910	9930910	9930910	9930910	9930910	9930910	9930910	9930910	9930910	9930910	9930910	9930910
9931750	9931750	9931750	9931750	9931750	9931750	9931750	9931750	9931750	9931750	9931750	9931750
	9934270	9934270		9934270	9934270		9934270		9934270		9934270
9923180	9923180	9923180	9923180	9923180	9923180	9923180	9923180	9923180	9923180	9923180	9923180
							MA00015		MA00015		MA00015
9923190	9923190	9923190	9923190	9923190	9923190	9923190	9923190	9923190	9923190	9923190	9923190



DERBI	DERBI	DERBI	DERBI
GPR REPLICA 2T MALOSSÌ	GPR REPLICA PESEK EU2	GPR REPLICA RACING	GPR REPLICA RACING
07-07	07-07	02-02	03-03
50cc 2T LC	50cc 2T LC	50cc 2T LC	50cc 2T LC
D50B0	D50B0	EBE050	EBE050

IT	EN	FR				
ALBERO MOTORE corsa 39 mm a piattelli pieni	Racing Crankshaft Stroke 39mm	VILEBREQUIN course 39 mm à contre-poids pleins		9930150	9930150	
BIELLA Axe 16	CONROD Axle 16	BIELLE Axe 16				
BIELLA Axe 18	CONROD Axle 18	BIELLE Axe 18				
CAMBIO COMPLETO RACING	COMPLETE GEAR BOX RACING	BOÎTE DE VITESSES COMPLÈTE RACING				
DESMODROMICO CAMBIO	SHIFT DRUM GEAR	BOÎTE DE VITESSES				
CENTRALINA digitale ad ant. variabile volano Ducati 6 poli	CDI UNIT WITH VARIABLE ADVANCE (Ducati 6 coils)	BOÎTE ÉLECTRONIQUE numérique à avance variable volant Ducati 6 pôles				
CENTRALINA RACING EU4	RACING EU4 CONTROL UNIT	BOÎTIER ÉLECTRONIQUE RACING EU4				
CUSCINETTI DI BANCO TPR Carbonirurati Serie	BEARINGS TPR Carbonitrided	PALIERI DE VILEBREQUIN TPR Carbonitrurés Jeu		9929190	9929190	9929190 9929190
FRIZIONE A DENTI DRITTI	STRAIGHT TEETH CLUTCH	EMBAYAGE À DENTS DROITES				
GRUPPO TERMICO Ø STD Ghisa	CYLINDER KIT Ø Standard (CAST IRON)	CYLINDRE COMPLET Ø STD Fonte		9927100	9927100	9917400 9927980 9917400 9927980
GRUPPO TERMICO Ø Maggiorato Ghisa	CYLINDER KIT BIG BORE (CAST IRON)	CYLINDRE COMPLET Ø Majoré Fonte		9927020	9927020	9917390 9928030 9917390 9928030
GRUPPO TERMICO RACING Ø 49,5 Ghisa	CYLINDER KIT RACING Ø 49,5 (CAST IRON)	CYLINDRE COMPLET RACING Ø 49,5 Fonte				
GRUPPO TERMICO RACING Ø 49,5 Ghisa testa scomposta	CYLINDER KIT RACING Ø 49,5 (CAST IRON) Decomposable head	CYLINDRE COMPLET RACING Ø 49,5 Fonte culasse décomposée				
GRUPPO TERMICO RACING Ø 50 alluminio	CYLINDER KIT RACING Ø 50 (ALUMINIUM)	CYLINDRE COMPLET RACING Ø 50 aluminium				
GRUPPO TERMICO RACING Ø Standard Alluminio	CYLINDER KIT RACING Ø Standard (ALUMINIUM)	CYLINDRE COMPLET RACING Ø Standard Aluminium				
INGRANAGGIO 6 VELOCITÀ AM6 1° Versione	GEAR 6° SPEED AM6 1° SERIES	ENGRENAGE 6 VITESSES 1° SERIE				
INGRANAGGIO 6 VELOCITÀ AM6 2° Versione	GEAR 6° SPEED AM6 2° SERIES	ENGRENAGE 6 VITESSES 2° SERIE				
KIT ASPIRAZIONE COMPLETO MIKUNI TM 24 TPR 360	COMPLETE MIKUNI INLET KIT TM 24 TPR 360	KIT ASPIRATION COMPLET MIKUNI TM 24 TPR 360		9930910	9930910	9930910 9930910
KIT ASPIRAZIONE COMPLETO OKO 28 TPR 360	COMPLETE INLET KIT OKO 28 TPR 360	KIT ASPIRATION COMPLET OKO 28 TPR 360		9931750	9931750	9931750 9931750
KIT FRIZIONE + TAMBURO	HOUSING CLUTCH KIT+ BOSS	KIT EMBRAYAGE + TAMBOUR				
MAXI KIT RACING 85 cc ghisa Ø 49,5 corsa 44	MAXI KIT RACING 85cc CAST IRON Ø 49,5 stroke 44	MAXI KIT RACING 85 cc fonte Ø 49,5 course 44				
MAXI KIT RACING 86 cc alluminio Ø 50 corsa 44	MAXI KIT RACING 86cc ALLUMINIUM Ø 49,5 stroke 44	MAXI KIT RACING 86 cc aluminium Ø 50 course 44		9934270	9934270	
MOLLE FRIZIONE	CLUTCH SPRINGS	RESSORTS EMBRAYAGE		9923180	9923180	9923180 9923180
MOTORINO AVVIAMENTO	STARTER ENGINE	DÉMARREUR ÉLECTRIQUE			MA00015	
SCARICO RACING omologato	RACING EXHAUST Approved	ÉCHAPPEMENT RACING homologué				
SERIE DISCHI frizione racing cellulosa/kevlar	CLUTCH PLATES RACING Cellulose/kevlar	JEU DISQUES embrayage racing cellulose/kevlar		9923190	9923190	9923190 9923190
SERIE DISCHI standard	CLUTCH PLATES Standard	JEU DISQUES standard				
TRASDUTTORE per volano Ducati 6 poli	TRANSDUCER (Ducati 6 coils)	TRANSDUCTEUR pour volant Ducati 6 pôles				
VALVOLA LAMELLARE	REED VALVE	CLAPET À LAMELLES				
VALVOLA LAMELLARE TPR	REED VALVE TPR	CLAPET À LAMELLES TPR				

DERBI	DERBI	DERBI	DERBI	DERBI	DERBI	DERBI	DERBI	DERBI	DERBI	DERBI	DERBI
GPR REPLICARACING EU2	SENDA BLACK EDITION	SENDA HYP DRD EVO EU2	SENDA HYP DRD EVO LIMITED EDITION EU2	SENDA R	SENDA R	SENDA R DRD BLACK DEVIL 2A EDIZIONE	SENDA R DRD EU1 EU1R	SENDA R DRD PRO EU2	SENDA R DRD RACING	SENDA R DRD RACING EU2	SENDA R DRD RACING LTD
05-05	03-03	08-09	08-08	99-99	00-01	03-03	02-02	05-11	04-05	05-08	05-05
50cc 2T LC	50cc 2T LC	50cc 2T LC	50cc 2T LC	50cc 2T LC	50cc 2T LC	50cc 2T LC	50cc 2T LC	50cc 2T LC	50cc 2T LC	50cc 2T LC	50cc 2T LC
EBS050	EBS050	D50B0	D50B0	EBS050	EBS050	EBS050	EBS050	D50B0	EBS050	D50B0	EBS050
		9930150	9930150					9930150		9930150	
9929190	9929190	9929190	9929190	9929190	9929190	9929190	9929190	9929190	9929190	9929190	9929190
9917400 9927980	9917400 9927980	9927100	9927100	9917400 9927980	9917400 9927980	9917400 9927980	9917400 9927980	9927100	9917400 9927980	9927100	9917400 9927980
9917390 9928030	9917390 9928030	9927020	9927020	9917390 9928030	9917390 9928030	9917390 9928030	9917390 9928030	9927020	9917390 9928030	9927020	9917390 9928030
9930910	9930910	9930910	9930910	9930910	9930910	9930910	9930910	9930910	9930910	9930910	9930910
9931750	9931750	9931750	9931750	9931750	9931750	9931750	9931750	9931750	9931750	9931750	9931750
		9934270	9934270					9934270		9934270	
9923180	9923180	9923180	9923180	9923180	9923180	9923180	9923180	9923180	9923180	9923180	9923180
								MA00015			
9923190	9923190	9923190	9923190	9923190	9923190	9923190	9923190	9923190	9923190	9923190	9923190



DERBI	DERBI	DERBI	DERBI
SENDA R DRD X-TREME 2T EU2	SENDA R DRD X-TREME 2T EURO2	SENDA R RACER	SENDA R X-RACE
14-15	10-12	03-03	04-04
50cc 2T LC	50cc 2T LC	50cc 2T LC	50cc 2T LC
D50B0	D50B0	EBS050	EBS050

IT	EN	FR				
ALBERO MOTORE corsa 39 mm a piattelli pieni	Racing Crankshaft Stroke 39mm	VILEBREQUIN course 39 mm à contre-poids pleins		9930150	9930150	
BIELLA Axe 16	CONROD Axle 16	BIELLE Axe 16				
BIELLA Axe 18	CONROD Axle 18	BIELLE Axe 18				
CAMBIO COMPLETO RACING	COMPLETE GEAR BOX RACING	BOÎTE DE VITESSES COMPLÈTE RACING				
DESMODROMICO CAMBIO	SHIFT DRUM GEAR	BOÎTE DE VITESSES				
CENTRALINA digitale ad ant. variabile volano Ducati 6 poli	CDI UNIT WITH VARIABLE ADVANCE (Ducati 6 coils)	BOÎTE ÉLECTRONIQUE numérique à avance variable volant Ducati 6 pôles				
CENTRALINA RACING EU4	RACING EU4 CONTROL UNIT	BOÎTIER ÉLECTRONIQUE RACING EU4				
CUSCINETTI DI BANCO TPR Carbonirurati Serie	BEARINGS TPR Carbonitrided	PALIERI DE VILEBREQUIN TPR Carbonitrurés Jeu		9929190	9929190	9929190 9929190
FRIZIONE A DENTI DRITTI	STRAIGHT TEETH CLUTCH	EMBAYAGE À DENTS DROITES				
GRUPPO TERMICO Ø STD Ghisa	CYLINDER KIT Ø Standard (CAST IRON)	CYLINDRE COMPLET Ø STD Fonte		9927100	9927100	9917400 9927980 9917400 9927980
GRUPPO TERMICO Ø Maggiorato Ghisa	CYLINDER KIT BIG BORE (CAST IRON)	CYLINDRE COMPLET Ø Majoré Fonte		9927020	9927020	9917390 9928030 9917390 9928030
GRUPPO TERMICO RACING Ø 49,5 Ghisa	CYLINDER KIT RACING Ø 49,5 (CAST IRON)	CYLINDRE COMPLET RACING Ø 49,5 Fonte				
GRUPPO TERMICO RACING Ø 49,5 Ghisa testa scomposta	CYLINDER KIT RACING Ø 49,5 (CAST IRON) Decomposable head	CYLINDRE COMPLET RACING Ø 49,5 Fonte culasse décomposée				
GRUPPO TERMICO RACING Ø 50 alluminio	CYLINDER KIT RACING Ø 50 (ALUMINIUM)	CYLINDRE COMPLET RACING Ø 50 aluminium				
GRUPPO TERMICO RACING Ø Standard Alluminio	CYLINDER KIT RACING Ø Standard (ALUMINIUM)	CYLINDRE COMPLET RACING Ø Standard Aluminium				
INGRANAGGIO 6 VELOCITÀ AM6 1° Versione	GEAR 6° SPEED AM6 1° SERIES	ENGRENAGE 6 VITESSES 1° SERIE				
INGRANAGGIO 6 VELOCITÀ AM6 2° Versione	GEAR 6° SPEED AM6 2° SERIES	ENGRENAGE 6 VITESSES 2° SERIE				
KIT ASPIRAZIONE COMPLETO MIKUNI TM 24 TPR 360	COMPLETE MIKUNI INLET KIT TM 24 TPR 360	KIT ASPIRATION COMPLET MIKUNI TM 24 TPR 360		9930910	9930910	9930910 9930910
KIT ASPIRAZIONE COMPLETO OKO 28 TPR 360	COMPLETE INLET KIT OKO 28 TPR 360	KIT ASPIRATION COMPLET OKO 28 TPR 360		9931750	9931750	9931750 9931750
KIT FRIZIONE + TAMBURO	HOUSING CLUTCH KIT+ BOSS	KIT EMBAYAGE + TAMBOUR				
MAXI KIT RACING 85 cc ghisa Ø 49,5 corsa 44	MAXI KIT RACING 85cc CAST IRON Ø 49,5 stroke 44	MAXI KIT RACING 85 cc fonte Ø 49,5 course 44				
MAXI KIT RACING 86 cc alluminio Ø 50 corsa 44	MAXI KIT RACING 86cc ALLUMINIUM Ø 49,5 stroke 44	MAXI KIT RACING 86 cc aluminium Ø 50 course 44		9934270	9934270	
MOLLE FRIZIONE	CLUTCH SPRINGS	RESSORTS EMBRAYAGE		9923180	9923180	9923180 9923180
MOTORINO AVVIAMENTO	STARTER ENGINE	DÉMARREUR ÉLECTRIQUE				
SCARICO RACING omologato	RACING EXHAUST Approved	ÉCHAPPEMENT RACING homologué				
SERIE DISCHI frizione racing cellulosa/kevlar	CLUTCH PLATES RACING Cellulose/kevlar	JEU DISQUES embrayage racing cellulose/kevlar		9923190	9923190	9923190 9923190
SERIE DISCHI standard	CLUTCH PLATES Standard	JEU DISQUES standard				
TRASDUTTORE per volano Ducati 6 poli	TRANSDUCER (Ducati 6 coils)	TRANSDUCTEUR pour volant Ducati 6 pôles				
VALVOLA LAMELLARE	REED VALVE	CLAPET À LAMELLES				
VALVOLA LAMELLARE TPR	REED VALVE TPR	CLAPET À LAMELLES TPR				

DERBI	DERBI	DERBI	DERBI	DERBI	DERBI	DERBI	DERBI	DERBI	DERBI	DERBI	DERBI
SENDA R X-RACE	SENDA R X-RACE 2T EU2	SENDA R X-RACE EU2	SENDA R X-RACE EU2	SENDA R X-TREME	SENDA R X-TREME	SENDA R X-TREME 2T EU2	SENDA R X-TREME EU2	SENDA R X-TREME EU2	SENDA R X-TREME EU2	SENDA R X-TREME EU2	SENDA SM
05-05	10-10	06-06	07-09	03-03	05-05	10-10	04-04	05-06	07-07	08-08	00-01
50cc 2T LC	50cc 2T LC	50cc 2T LC	50cc 2T LC	50cc 2T LC	50cc 2T LC	50cc 2T LC	50cc 2T LC	50cc 2T LC	50cc 2T LC	50cc 2T LC	50cc 2T LC
EBS050	D50B0	D50B0	D50B0	EBS050	EBS050	D50B0	EBS050	D50B0	D50B0	D50B0	EBS050
	9930150	9930150	9930150			9930150		9930150	9930150	9930150	
9929190	9929190	9929190	9929190	9929190	9929190	9929190	9929190	9929190	9929190	9929190	9929190
9917400 9927980	9927100	9927100	9927100	9917400 9927980	9917400 9927980	9927100	9917400 9927980	9927100	9927100	9927100	9917400 9927980
9917390 9928030	9927020	9927020	9927020	9917390 9928030	9917390 9928030	9927020	9917390 9928030	9927020	9927020	9927020	9917390 9928030
9930910	9930910	9930910	9930910	9930910	9930910	9930910	9930910	9930910	9930910	9930910	9930910
9931750	9931750	9931750	9931750	9931750	9931750	9931750	9931750	9931750	9931750	9931750	9931750
	9934270	9934270	9934270			9934270		9934270	9934270	9934270	
9923180	9923180	9923180	9923180	9923180	9923180	9923180	9923180	9923180	9923180	9923180	9923180
9923190	9923190	9923190	9923190	9923190	9923190	9923190	9923190	9923190	9923190	9923190	9923190

MOTO 50cc



DERBI	DERBI	DERBI	DERBI
SENDA SM DRD EDITION BLACK	SENDA SM DRD EU1 EU1R	SENDA SM DRD PRO EU2	SENDA SM DRD PRO EU2 2VER
05-05	02-03	05-11	05-08
50cc 2T LC	50cc 2T LC	50cc 2T LC	50cc 2T LC
EBS050	EBS050	D50B0	D50B0

IT	EN	FR					
ALBERO MOTORE corsa 39 mm a piattelli pieni	Racing Crankshaft Stroke 39mm	VILEBREQUIN course 39 mm à contre-poids pleins				9930150	9930150
BIELLA Axe 16	CONROD Axle 16	BIELLE Axe 16					
BIELLA Axe 18	CONROD Axle 18	BIELLE Axe 18					
CAMBIO COMPLETO RACING	COMPLETE GEAR BOX RACING	BOÎTE DE VITESSES COMPLÈTE RACING					
DESMODROMICO CAMBIO	SHIFT DRUM GEAR	BOÎTE DE VITESSES					
CENTRALINA digitale ad ant. variabile volano Ducati 6 poli	CDI UNIT WITH VARIABLE ADVANCE (Ducati 6 coils)	BOÎTE ÉLECTRONIQUE numérique à avance variable volant Ducati 6 pôles					
CENTRALINA RACING EU4	RACING EU4 CONTROL UNIT	BOÎTIER ÉLECTRONIQUE RACING EU4					
CUSCINETTI DI BANCO TPR Carbonirurati Serie	BEARINGS TPR Carbonitrided	PALIERI DE VILEBREQUIN TPR Carbonitrurés Jeu		9929190	9929190	9929190	9929190
FRIZIONE A DENTI DRITTI	STRAIGHT TEETH CLUTCH	EMBAYAGE À DENTS DROITES					
GRUPPO TERMICO Ø STD Ghisa	CYLINDER KIT Ø Standard (CAST IRON)	CYLINDRE COMPLET Ø STD Fonte		9917400 9927980	9917400 9927980	9927100	9927100
GRUPPO TERMICO Ø Maggiorato Ghisa	CYLINDER KIT BIG BORE (CAST IRON)	CYLINDRE COMPLET Ø Majoré Fonte		9917390 9928030	9917390 9928030	9927020	9927020
GRUPPO TERMICO RACING Ø 49,5 Ghisa	CYLINDER KIT RACING Ø 49,5 (CAST IRON)	CYLINDRE COMPLET RACING Ø 49,5 Fonte					
GRUPPO TERMICO RACING Ø 49,5 Ghisa testa scomposta	CYLINDER KIT RACING Ø 49,5 (CAST IRON) Decomposable head	CYLINDRE COMPLET RACING Ø 49,5 Fonte culasse décomposée					
GRUPPO TERMICO RACING Ø 50 alluminio	CYLINDER KIT RACING Ø 50 (ALUMINIUM)	CYLINDRE COMPLET RACING Ø 50 aluminium					
GRUPPO TERMICO RACING Ø Standard Alluminio	CYLINDER KIT RACING Ø Standard (ALUMINIUM)	CYLINDRE COMPLET RACING Ø Standard Aluminium					
INGRANAGGIO 6 VELOCITÀ AM6 1° Versione	GEAR 6° SPEED AM6 1° SERIES	ENGRENAGE 6 VITESSES 1° SERIE					
INGRANAGGIO 6 VELOCITÀ AM6 2° Versione	GEAR 6° SPEED AM6 2° SERIES	ENGRENAGE 6 VITESSES 2° SERIE					
KIT ASPIRAZIONE COMPLETO MIKUNI TM 24 TPR 360	COMPLETE MIKUNI INLET KIT TM 24 TPR 360	KIT ASPIRATION COMPLET MIKUNI TM 24 TPR 360		9930910	9930910	9930910	9930910
KIT ASPIRAZIONE COMPLETO OKO 28 TPR 360	COMPLETE INLET KIT OKO 28 TPR 360	KIT ASPIRATION COMPLET OKO 28 TPR 360		9931750	9931750	9931750	9931750
KIT FRIZIONE + TAMBURO	HOUSING CLUTCH KIT+ BOSS	KIT EMBRAYAGE + TAMBOUR					
MAXI KIT RACING 85 cc ghisa Ø 49,5 corsa 44	MAXI KIT RACING 85cc CAST IRON Ø 49,5 stroke 44	MAXI KIT RACING 85 cc fonte Ø 49,5 course 44					
MAXI KIT RACING 86 cc alluminio Ø 50 corsa 44	MAXI KIT RACING 86cc ALLUMINIUM Ø 49,5 stroke 44	MAXI KIT RACING 86 cc aluminium Ø 50 course 44				9934270	9934270
MOLLE FRIZIONE	CLUTCH SPRINGS	RESSORTS EMBRAYAGE		9923180	9923180	9923180	9923180
MOTORINO AVVIAMENTO	STARTER ENGINE	DÉMARREUR ÉLECTRIQUE				MA00015	
SCARICO RACING omologato	RACING EXHAUST Approved	ÉCHAPPEMENT RACING homologué					
SERIE DISCHI frizione racing cellulosa/kevlar	CLUTCH PLATES RACING Cellulose/kevlar	JEU DISQUES embrayage racing cellulose/kevlar		9923190	9923190	9923190	9923190
SERIE DISCHI standard	CLUTCH PLATES Standard	JEU DISQUES standard					
TRASDUTTORE per volano Ducati 6 poli	TRANSDUCER (Ducati 6 coils)	TRANSDUCTEUR pour volant Ducati 6 pôles					
VALVOLA LAMELLARE	REED VALVE	CLAPET À LAMELLES					
VALVOLA LAMELLARE TPR	REED VALVE TPR	CLAPET À LAMELLES TPR					

DERBI	DERBI	DERBI	DERBI	DERBI	DERBI	DERBI	DERBI	DERBI	DERBI	DERBI	DERBI
SENDA SM DRD RACING	SENDA SM DRD RACING EU2	SENDA SM DRD RACING EU2	SENDA SM DRD RACING LTD	SENDA SM DRD RACING LTD EU2	SENDA SM DRD X-TREME 2T EU2	SENDA SM DRD X-TREME 2T EU2 LIMITED ED	SENDA SM X-RACE	SENDA SM X-RACE	SENDA SM X-RACE 2T EU2	SENDA SM X-RACE EU2	SENDA SM X-RACE EU2
04-05	05-08	10-13	05-05	07-07	14-15	14-15	04-04	05-05	10-10	06-06	07-09
50cc 2T LC	50cc 2T LC	50cc 2T LC	50cc 2T LC	50cc 2T LC	50cc 2T LC	50cc 2T LC	50cc 2T LC	50cc 2T LC	50cc 2T LC	50cc 2T LC	50cc 2T LC
EBS050	D50B0	D50B0	EBS050	D50B0	D50B0	D50B0	EBS050	EBS050	D50B0	D50B0	D50B0
	9930150	9930150		9930150	9930150	9930150			9930150	9930150	9930150
9929190	9929190	9929190	9929190	9929190	9929190	9929190	9929190	9929190	9929190	9929190	9929190
9917400 9927980	9927100	9927100	9917400 9927980	9927100	9927100	9927100	9917400 9927980	9917400 9927980	9927100	9927100	9927100
9917390 9928030	9927020	9927020	9917390 9928030	9927020	9927020	9927020	9917390 9928030	9917390 9928030	9927020	9927020	9927020
9930910	9930910	9930910	9930910	9930910	9930910	9930910	9930910	9930910	9930910	9930910	9930910
9931750	9931750	9931750	9931750	9931750	9931750	9931750	9931750	9931750	9931750	9931750	9931750
	9934270	9934270		9934270	9934270	9934270			9934270	9934270	9934270
9923180	9923180	9923180	9923180	9923180	9923180	9923180	9923180	9923180	9923180	9923180	9923180
9923190	9923190	9923190	9923190	9923190	9923190	9923190	9923190	9923190	9923190	9923190	9923190



DERBI	DERBI	DERBI	DERBI
SENDA SM X-RACE EU2 2VER	SENDA SM X-TREME	SENDA SM X-TREME	SENDA SM X-TREME 2T EU2
07-09	02-02	03-03	10-10
50cc 2T LC	50cc 2T LC	50cc 2T LC	50cc 2T LC
D50B0	EBS050	EBS050	D50B0

IT	EN	FR				
ALBERO MOTORE corsa 39 mm a piattelli pieni	Racing Crankshaft Stroke 39mm	VILEBREQUIN course 39 mm à contre-poids pleins		9930150		9930150
BIELLA Axe 16	CONROD Axle 16	BIELLE Axe 16				
BIELLA Axe 18	CONROD Axle 18	BIELLE Axe 18				
CAMBIO COMPLETO RACING	COMPLETE GEAR BOX RACING	BOÎTE DE VITESSES COMPLÈTE RACING				
DESMODROMICO CAMBIO	SHIFT DRUM GEAR	BOÎTE DE VITESSES				
CENTRALINA digitale ad ant. variabile volano Ducati 6 poli	CDI UNIT WITH VARIABLE ADVANCE (Ducati 6 coils)	BOÎTE ÉLECTRONIQUE numérique à avance variable volant Ducati 6 pôles				
CENTRALINA RACING EU4	RACING EU4 CONTROL UNIT	BOÎTIER ÉLECTRONIQUE RACING EU4				
CUSCINETTI DI BANCO TPR Carbonirurati Serie	BEARINGS TPR Carbonitrided	PALIERI DE VILEBREQUIN TPR Carbonitrurés Jeu		9929190	9929190	9929190
FRIZIONE A DENTI DRITTI	STRAIGHT TEETH CLUTCH	EMBAYAGE À DENTS DROITES				
GRUPPO TERMICO Ø STD Ghisa	CYLINDER KIT Ø Standard (CAST IRON)	CYLINDRE COMPLET Ø STD Fonte		9927100	9917400 9927980	9917400 9927980
GRUPPO TERMICO Ø Maggiorato Ghisa	CYLINDER KIT BIG BORE (CAST IRON)	CYLINDRE COMPLET Ø Majoré Fonte		9927020	9917390 9928030	9917390 9928030
GRUPPO TERMICO RACING Ø 49,5 Ghisa	CYLINDER KIT RACING Ø 49,5 (CAST IRON)	CYLINDRE COMPLET RACING Ø 49,5 Fonte				
GRUPPO TERMICO RACING Ø 49,5 Ghisa testa scomposta	CYLINDER KIT RACING Ø 49,5 (CAST IRON) Decomposable head	CYLINDRE COMPLET RACING Ø 49,5 Fonte culasse décomposée				
GRUPPO TERMICO RACING Ø 50 alluminio	CYLINDER KIT RACING Ø 50 (ALUMINIUM)	CYLINDRE COMPLET RACING Ø 50 aluminium				
GRUPPO TERMICO RACING Ø Standard Alluminio	CYLINDER KIT RACING Ø Standard (ALUMINIUM)	CYLINDRE COMPLET RACING Ø Standard Aluminium				
INGRANAGGIO 6 VELOCITÀ AM6 1° Versione	GEAR 6° SPEED AM6 1° SERIES	ENGRENAGE 6 VITESSES 1° SERIE				
INGRANAGGIO 6 VELOCITÀ AM6 2° Versione	GEAR 6° SPEED AM6 2° SERIES	ENGRENAGE 6 VITESSES 2° SERIE				
KIT ASPIRAZIONE COMPLETO MIKUNI TM 24 TPR 360	COMPLETE MIKUNI INLET KIT TM 24 TPR 360	KIT ASPIRATION COMPLET MIKUNI TM 24 TPR 360		9930910	9930910	9930910
KIT ASPIRAZIONE COMPLETO OKO 28 TPR 360	COMPLETE INLET KIT OKO 28 TPR 360	KIT ASPIRATION COMPLET OKO 28 TPR 360		9931750	9931750	9931750
KIT FRIZIONE + TAMBURO	HOUSING CLUTCH KIT+ BOSS	KIT EMBRAYAGE + TAMBOUR				
MAXI KIT RACING 85 cc ghisa Ø 49,5 corsa 44	MAXI KIT RACING 85cc CAST IRON Ø 49,5 stroke 44	MAXI KIT RACING 85 cc fonte Ø 49,5 course 44				
MAXI KIT RACING 86 cc alluminio Ø 50 corsa 44	MAXI KIT RACING 86cc ALLUMINIUM Ø 49,5 stroke 44	MAXI KIT RACING 86 cc aluminium Ø 50 course 44		9934270		9934270
MOLLE FRIZIONE	CLUTCH SPRINGS	RESSORTS EMBRAYAGE		9923180	9923180	9923180
MOTORINO AVVIAMENTO	STARTER ENGINE	DÉMARREUR ÉLECTRIQUE				
SCARICO RACING omologato	RACING EXHAUST Approved	ÉCHAPPEMENT RACING homologué				
SERIE DISCHI frizione racing cellulosa/kevlar	CLUTCH PLATES RACING Cellulose/kevlar	JEU DISQUES embrayage racing cellulose/kevlar		9923190	9923190	9923190
SERIE DISCHI standard	CLUTCH PLATES Standard	JEU DISQUES standard				
TRASDUTTORE per volano Ducati 6 poli	TRANSDUCER (Ducati 6 coils)	TRANSDUCTEUR pour volant Ducati 6 pôles				
VALVOLA LAMELLARE	REED VALVE	CLAPET À LAMELLES				
VALVOLA LAMELLARE TPR	REED VALVE TPR	CLAPET À LAMELLES TPR				

DERBI	DERBI	DERBI	DERBI	DERBI	FANTIC	FANTIC	FANTIC	FANTIC	FANTIC	FANTIC	FANTIC
SENDA SM X-TREME EU2	SENDA SM X-TREME EU2	SENDA SM X-TREME EU2	SENDA SM X-TREME EU2	SENDA SM X-TREME EU2 2A EDIZIONE	CABALLERO MOTARD	CABALLERO MOTARD	CABALLERO REGOLARITÀ	CABALLERO REGOLARITÀ	ENDURO COMPETITION EU4	ENDURO PERFORMANCE EU4	MOTARD COMPETITION EU4
04-04	05-06	07-07	08-08	05-05	06-09	10-10	06-09	10-10	18-20	18-20	18-20
50cc 2T LC	50cc 2T LC	50cc 2T LC	50cc 2T LC	50cc 2T LC	50cc 2T LC	50cc 2T LC	50cc 2T LC	50cc 2T LC	50cc 2T LC	50cc 2T LC	50cc 2T LC
EBS050	D50B0	D50B0	D50B0	EBS050	AM 6	AM 6	AM 6	AM 6	AM 6	AM 6	AM 6
	9930150	9930150	9930150		9921720	9921720	9921720	9921720	9921720	9921720	9921720
					IM07033	IM07033	IM07033	IM07033	IM07033	IM07033	IM07033
					IM07036	IM07036	IM07036	IM07036	IM07036	IM07036	IM07036
					9935000	9935000	9935000	9935000	9935000	9935000	9935000
					9920020	9920020	9920020	9920020	9920020	9920020	9920020
					9921690	9921690	9921690	9921690			
									9934440	9934440	9934440
9929190	9929190	9929190	9929190	9929190	9929180	9929180	9929180	9929180	9929180	9929180	9929180
					9918550	9918550	9918550	9918550	9918550	9918550	9918550
9917400 9927980	9927100	9927100	9927100	9917400 9927980	9916770	9916770	9916770	9916770	9916770 KT00098	9916770 KT00098	9916770 KT00098
9917390 9928030	9927020	9927020	9927020	9917390 9928030	9919250	9919250	9919250	9919250	9919250 KT00114	9919250 KT00114	9919250 KT00114
					9919240	9919240	9919240	9919240	9919240	9919240	9919240
					9921150	9921150	9921150	9921150	9921150	9921150	9921150
					9924130	9924130	9924130	9924130	9924130	9924130	9924130
					9934500	9934500	9934500	9934500	9934500	9934500	9934500
					9919080	9919080	9919080	9919080	9919080	9919080	9919080
					9931910	9931910	9931910	9931910	9931910	9931910	9931910
9930910	9930910	9930910	9930910	9930910	9930910	9930910	9930910	9930910	9930910	9930910	9930910
9931750	9931750	9931750	9931750	9931750	9931750	9931750	9931750	9931750	9931750	9931750	9931750
					9931900	9931900	9931900	9931900	9931900	9931900	9931900
					9921450	9921450	9921450	9921450	9921450	9921450	9921450
	9934270	9934270	9934270		9924240	9924240	9924240	9924240	9924240	9924240	9924240
9923180	9923180	9923180	9923180	9923180	9920580	9920580	9920580	9920580	9920580	9920580	9920580
9923190	9923190	9923190	9923190	9923190	9921180	9921180	9921180	9921180	9921180	9921180	9921180
					9920250	9920250	9920250	9920250	9920250	9920250	9920250
					9906500	9906500	9906500	9906500	9906500	9906500	9906500
					9931600	9931600	9931600	9931600	9931600	9931600	9931600



FANTIC	GILERA	GILERA	GILERA
MOTARD PERFORMANCE EU4	GSM	RCR	RCR
18-20	01-01	03-03	06-07
50cc 2T LC	50cc 2T LC	50cc 2T LC	50cc 2T LC
AM 6	EBE050	EBS050	D50B0

IT	EN	FR				
ALBERO MOTORE corsa 39 mm a piattelli pieni	Racing Crankshaft Stroke 39mm	VILEBREQUIN course 39 mm à contre-poids pleins		9921720		9930150
BIELLA Axe 16	CONROD Axle 16	BIELLE Axe 16		IM07033		
BIELLA Axe 18	CONROD Axle 18	BIELLE Axe 18		IM07036		
CAMBIO COMPLETO RACING	COMPLETE GEAR BOX RACING	BOÎTE DE VITESSES COMPLÈTE RACING		9935000		
DESMODROMICO CAMBIO	SHIFT DRUM GEAR	BOÎTE DE VITESSES		9920020		
CENTRALINA digitale ad ant. variabile volano Ducati 6 poli	CDI UNIT WITH VARIABLE ADVANCE (Ducati 6 coils)	BOÎTE ÉLECTRONIQUE numérique à avance variable volant Ducati 6 pôles				
CENTRALINA RACING EU4	RACING EU4 CONTROL UNIT	BOÎTIER ÉLECTRONIQUE RACING EU4		9934440		
CUSCINETTI DI BANCO TPR Carbonirurati Serie	BEARINGS TPR Carbonitrided	PALIERI DE VILEBREQUIN TPR Carbonitrurés Jeu		9929180	9929190	9929190 9929190
FRIZIONE A DENTI DRITTI	STRAIGHT TEETH CLUTCH	EMBAYAGE À DENTS DROITES		9918550		
GRUPPO TERMICO Ø STD Ghisa	CYLINDER KIT Ø Standard (CAST IRON)	CYLINDRE COMPLET Ø STD Fonte		9916770 KT00098	9917400 9927980	9917400 9927980 9927100
GRUPPO TERMICO Ø Maggiorato Ghisa	CYLINDER KIT BIG BORE (CAST IRON)	CYLINDRE COMPLET Ø Majoré Fonte		9919250 KT00114	9917390 9928030	9917390 9928030 9927020
GRUPPO TERMICO RACING Ø 49,5 Ghisa	CYLINDER KIT RACING Ø 49,5 (CAST IRON)	CYLINDRE COMPLET RACING Ø 49,5 Fonte		9919240		
GRUPPO TERMICO RACING Ø 49,5 Ghisa testa scomposta	CYLINDER KIT RACING Ø 49,5 (CAST IRON) Decomposable head	CYLINDRE COMPLET RACING Ø 49,5 Fonte culasse décomposée		9921150		
GRUPPO TERMICO RACING Ø 50 alluminio	CYLINDER KIT RACING Ø 50 (ALUMINIUM)	CYLINDRE COMPLET RACING Ø 50 aluminium		9924130		
GRUPPO TERMICO RACING Ø Standard Alluminio	CYLINDER KIT RACING Ø Standard (ALUMINIUM)	CYLINDRE COMPLET RACING Ø Standard Aluminium		9934500		
INGRANAGGIO 6 VELOCITÀ AM6 1° Versione	GEAR 6° SPEED AM6 1° SERIES	ENGRENAGE 6 VITESSES 1° SERIE		9919080		
INGRANAGGIO 6 VELOCITÀ AM6 2° Versione	GEAR 6° SPEED AM6 2° SERIES	ENGRENAGE 6 VITESSES 2° SERIE		9931910		
KIT ASPIRAZIONE COMPLETO MIKUNI TM 24 TPR 360	COMPLETE MIKUNI INLET KIT TM 24 TPR 360	KIT ASPIRATION COMPLET MIKUNI TM 24 TPR 360		9930910	9930910	9930910 9930910
KIT ASPIRAZIONE COMPLETO OKO 28 TPR 360	COMPLETE INLET KIT OKO 28 TPR 360	KIT ASPIRATION COMPLET OKO 28 TPR 360		9931750	9931750	9931750 9931750
KIT FRIZIONE + TAMBURO	HOUSING CLUTCH KIT+ BOSS	KIT EMBRAYAGE + TAMBOUR		9931900		
MAXI KIT RACING 85 cc ghisa Ø 49,5 corsa 44	MAXI KIT RACING 85cc CAST IRON Ø 49,5 stroke 44	MAXI KIT RACING 85 cc fonte Ø 49,5 course 44		9921450		
MAXI KIT RACING 86 cc alluminio Ø 50 corsa 44	MAXI KIT RACING 86cc ALLUMINIUM Ø 49,5 stroke 44	MAXI KIT RACING 86 cc aluminium Ø 50 course 44		9924240		9934270
MOLLE FRIZIONE	CLUTCH SPRINGS	RESSORTS EMBRAYAGE		9920580	9923180	9923180 9923180
MOTORINO AVVIAMENTO	STARTER ENGINE	DÉMARREUR ÉLECTRIQUE				
SCARICO RACING omologato	RACING EXHAUST Approved	ÉCHAPPEMENT RACING homologué				
SERIE DISCHI frizione racing cellulosa/kevlar	CLUTCH PLATES RACING Cellulose/kevlar	JEU DISQUES embrayage racing cellulose/kevlar		9921180	9923190	9923190 9923190
SERIE DISCHI standard	CLUTCH PLATES Standard	JEU DISQUES standard		9920250		
TRASDUTTORE per volano Ducati 6 poli	TRANSDUCER (Ducati 6 coils)	TRANSDUCTEUR pour volant Ducati 6 pôles				
VALVOLA LAMELLARE	REED VALVE	CLAPET À LAMELLES		9906500		
VALVOLA LAMELLARE TPR	REED VALVE TPR	CLAPET À LAMELLES TPR		9931600		

GILERA	GILERA	GILERA	GILERA	GILERA	GILERA	HM	HM	HM	HM	HM	HM
RCR	RCR (CHE-SYC)	SMT	SMT	SMT	SMT RACING	BAJA, DERAPAGE BASIC	CMC	CRE BAJA RR, DERAPAGE RR	CRE BAJA RR, DERAPAGE RR	CRE BAJA, DERAPAGE	CRE BAJA, DERAPAGE
11-12	13-15	03-03	06-12	13-17	11-12	10-11	10-11	07-09	10-11	07-09	10-11
50cc 2T LC	50cc 2T LC	50cc 2T LC	50cc 2T LC	50cc 2T LC	50cc 2T LC	50cc 2T LC	50cc 2T LC	50cc 2T LC	50cc 2T LC	50cc 2T LC	50cc 2T LC
D50B0	D50B0	EBS050	D50B0	D50B0	D50B0	AM 6	AM 6	AM 6	AM 6	AM 6	AM 6
9930150	9930150		9930150	9930150	9930150	9921720	9921720	9921720	9921720	9921720	9921720
						IM07033	IM07033	IM07033	IM07033	IM07033	IM07033
						IM07036	IM07036	IM07036	IM07036	IM07036	IM07036
						9935000	9935000	9935000	9935000	9935000	9935000
						9920020	9920020	9920020	9920020	9920020	9920020
9929190	9929190	9929190	9929190	9929190	9929190	9929180	9929180	9929180	9929180	9929180	9929180
						9918550	9918550	9918550	9918550	9918550	9918550
9927100	9927100	9917400 9927980	9927100	9927100	9927100	9916770	9916770	9916770	9916770	9916770	9916770
9927020	9927020	9917390 9928030	9927020	9927020	9927020	9919250	9919250	9919250	9919250	9919250	9919250
						9919240	9919240	9919240	9919240	9919240	9919240
						9921150	9921150	9921150	9921150	9921150	9921150
						9924130	9924130	9924130	9924130	9924130	9924130
						9934500	9934500	9934500	9934500	9934500	9934500
						9919080	9919080	9919080	9919080	9919080	9919080
						9931910	9931910	9931910	9931910	9931910	9931910
9930910	9930910	9930910	9930910	9930910	9930910	9930910	9930910	9930910	9930910	9930910	9930910
9931750	9931750	9931750	9931750	9931750	9931750	9931750	9931750	9931750	9931750	9931750	9931750
						9931900	9931900	9931900	9931900	9931900	9931900
						9921450	9921450	9921450	9921450	9921450	9921450
9934270	9934270		9934270	9934270	9934270	9924240	9924240	9924240	9924240	9924240	9924240
9923180	9923180	9923180	9923180	9923180	9923180	9920580	9920580	9920580	9920580	9920580	9920580
						MA00018		MA00018	MA00018	MA00018	MA00018
						9924340	9924340	9924340	9924340	9924340	9924340
9923190	9923190	9923190	9923190	9923190	9923190	9921180	9921180	9921180	9921180	9921180	9921180
						9920250	9920250	9920250	9920250	9920250	9920250
						9906500	9906500	9906500	9906500	9906500	9906500
						9931600	9931600	9931600	9931600	9931600	9931600



HM	HM	HM	HM
CRE SIX COMPETITION	CRE SIX, BAIA, DERAPAGE	CRE SIX, BAIA, DERAPAGE	CRE SIX, BAIA, DERAPAGE
10-11	95-00	01-02	03-05
50cc 2T LC	50cc 2T LC	50cc 2T LC	50cc 2T LC
AM 6	AM 6	AM 6	AM 6

IT	EN	FR					
ALBERO MOTORE corsa 39 mm a piattelli pieni	Racing Crankshaft Stroke 39mm	VILEBREQUIN course 39 mm à contre-poids pleins		9921720	9921720	9921720	9921720
BIELLA Axe 16	CONROD Axle 16	BIELLE Axe 16		IM07033	IM07033	IM07033	IM07033
BIELLA Axe 18	CONROD Axle 18	BIELLE Axe 18		IM07036	IM07036	IM07036	IM07036
CAMBIO COMPLETO RACING	COMPLETE GEAR BOX RACING	BOÎTE DE VITESSES COMPLÈTE RACING		9935000	9935000	9935000	9935000
DESMODROMICO CAMBIO	SHIFT DRUM GEAR	BOÎTE DE VITESSES		9920020	9920020	9920020	9920020
CENTRALINA digitale ad ant. variabile volano Ducati 6 poli	CDI UNIT WITH VARIABLE ADVANCE (Ducati 6 coils)	BOÎTE ÉLECTRONIQUE numérique à avance variable volant Ducati 6 pôles			9921690	9921690	9921690
CENTRALINA RACING EU4	RACING EU4 CONTROL UNIT	BOÎTIER ÉLECTRONIQUE RACING EU4					
CUSCINETTI DI BANCO TPR Carbonirurati Serie	BEARINGS TPR Carbonitrided	PALIERI DE VILEBREQUIN TPR Carbonitrurés Jeu		9929180	9929180	9929180	9929180
FRIZIONE A DENTI DRITTI	STRAIGHT TEETH CLUTCH	EMBAYAGE À DENTS DROITES		9918550	9918550	9918550	9918550
GRUPPO TERMICO Ø STD Ghisa	CYLINDER KIT Ø Standard (CAST IRON)	CYLINDRE COMPLET Ø STD Fonte		9916770	9916770	9916770	9916770
GRUPPO TERMICO Ø Maggiorato Ghisa	CYLINDER KIT BIG BORE (CAST IRON)	CYLINDRE COMPLET Ø Majoré Fonte		9919250	9919250	9919250	9919250
GRUPPO TERMICO RACING Ø 49,5 Ghisa	CYLINDER KIT RACING Ø 49,5 (CAST IRON)	CYLINDRE COMPLET RACING Ø 49,5 Fonte		9919240	9919240	9919240	9919240
GRUPPO TERMICO RACING Ø 49,5 Ghisa testa scomposta	CYLINDER KIT RACING Ø 49,5 (CAST IRON) Decomposable head	CYLINDRE COMPLET RACING Ø 49,5 Fonte culasse décomposée		9921150	9921150	9921150	9921150
GRUPPO TERMICO RACING Ø 50 alluminio	CYLINDER KIT RACING Ø 50 (ALUMINIUM)	CYLINDRE COMPLET RACING Ø 50 aluminium		9924130	9924130	9924130	9924130
GRUPPO TERMICO RACING Ø Standard Alluminio	CYLINDER KIT RACING Ø Standard (ALUMINIUM)	CYLINDRE COMPLET RACING Ø Standard Aluminium		9934500	9934500	9934500	9934500
INGRANAGGIO 6 VELOCITÀ AM6 1° Versione	GEAR 6° SPEED AM6 1° SERIES	ENGRENAGE 6 VITESSES 1° SERIE		9919080	9919080	9919080	9919080
INGRANAGGIO 6 VELOCITÀ AM6 2° Versione	GEAR 6° SPEED AM6 2° SERIES	ENGRENAGE 6 VITESSES 2° SERIE		9931910	9931910	9931910	9931910
KIT ASPIRAZIONE COMPLETO MIKUNI TM 24 TPR 360	COMPLETE MIKUNI INLET KIT TM 24 TPR 360	KIT ASPIRATION COMPLET MIKUNI TM 24 TPR 360		9930910	9930910	9930910	9930910
KIT ASPIRAZIONE COMPLETO OKO 28 TPR 360	COMPLETE INLET KIT OKO 28 TPR 360	KIT ASPIRATION COMPLET OKO 28 TPR 360		9931750	9931750	9931750	9931750
KIT FRIZIONE + TAMBURO	HOUSING CLUTCH KIT+ BOSS	KIT EMBRAYAGE + TAMBOUR		9931900	9931900	9931900	9931900
MAXI KIT RACING 85 cc ghisa Ø 49,5 corsa 44	MAXI KIT RACING 85cc CAST IRON Ø 49,5 stroke 44	MAXI KIT RACING 85 cc fonte Ø 49,5 course 44		9921450	9921450	9921450	9921450
MAXI KIT RACING 86 cc alluminio Ø 50 corsa 44	MAXI KIT RACING 86cc ALLUMINIUM Ø 49,5 stroke 44	MAXI KIT RACING 86 cc aluminium Ø 50 course 44		9924240	9924240	9924240	9924240
MOLLE FRIZIONE	CLUTCH SPRINGS	RESSORTS EMBRAYAGE		9920580	9920580	9920580	9920580
MOTORINO AVVIAMENTO	STARTER ENGINE	DÉMARREUR ÉLECTRIQUE			MA00018		MA00018
SCARICO RACING omologato	RACING EXHAUST Approved	ÉCHAPPEMENT RACING homologué		9924340	9924340	9924340	9924340
SERIE DISCHI frizione racing cellulosa/kevlar	CLUTCH PLATES RACING Cellulose/kevlar	JEU DISQUES embrayage racing cellulose/kevlar		9921180	9921180	9921180	9921180
SERIE DISCHI standard	CLUTCH PLATES Standard	JEU DISQUES standard		9920250	9920250	9920250	9920250
TRASDUTTORE per volano Ducati 6 poli	TRANSDUCER (Ducati 6 coils)	TRANSDUCTEUR pour volant Ducati 6 pôles			9910150	9910150	9910150
VALVOLA LAMELLARE	REED VALVE	CLAPET À LAMELLES		9906500	9906500	9906500	9906500
VALVOLA LAMELLARE TPR	REED VALVE TPR	CLAPET À LAMELLES TPR		9931600	9931600	9931600	9931600

HM	HM	HM	MALAGUTI	MALAGUTI	MALAGUTI	MALAGUTI	MBK	MBK	MINARELLI	MINARELLI	MINARELLI
CRE SIX, BAIA, DERAPAGE	CRE SIX, DERAPAGE COMPETITION	DERAPAGE COMPETITION	CNK DRAKON	FIFTY EVOLUTION	XSM	XTM	X LIMIT	X POWER	MOTORE AM 3-4-5	MOTORE AM 6 1° SERIE	MOTORE AM 6 2° SERIE
06-06	07-09	10-11	05-07	90-93	03-03	03-03	03-04	03-04	91-95	96-11	12-18
50cc 2T LC	50cc 2T LC	50cc 2T LC	50cc 2T LC	50cc 2T LC	50cc 2T LC	50cc 2T LC	50cc 2T LC	50cc 2T LC	50cc 2T LC	50cc 2T LC	50cc 2T LC
AM 6	AM 6	AM 6	AM 6	AM 3-4-5	AM 6	AM 6	AM 6	AM 6	AM 3-4-5	AM 6	AM 6
9921720	9921720	9921720	9921720	9921720	9921720	9921720	9921720	9921720	9921720	9921720	9921720
IM07033	IM07033	IM07033	IM07033	IM07033	IM07033	IM07033	IM07033	IM07033	IM07033	IM07033	
IM07036	IM07036	IM07036	IM07036	IM07036	IM07036	IM07036	IM07036	IM07036		IM07036	IM07036
9935000	9935000	9935000	9935000		9935000	9935000	9935000	9935000		9935000	9935000
9920020	9920020	9920020	9920020		9920020	9920020	9920020	9920020		9920020	9920020
			9921690	9921690	9921690	9921690	9921690	9921690			
9929180	9929180	9929180	9929180	9929180	9929180	9929180	9929180	9929180	9929180	9929180	9929180
9918550	9918550	9918550	9918550	9918550	9918550	9918550	9918550	9918550	9918550	9918550	9918550
9916770	9916770	9916770	9916770	9916770	9916770	9916770	9916770	9916770	9916770	9916770	9916770
9919250	9919250	9919250	9919250	9919250	9919250	9919250	9919250	9919250	9919250	9919250	9919250
9919240	9919240	9919240	9919240	9919240	9919240	9919240	9919240	9919240	9919240	9919240	9919240
9921150	9921150	9921150	9921150	9921150	9921150	9921150	9921150	9921150	9921150	9921150	9921150
9924130	9924130	9924130	9924130	9924130	9924130	9924130	9924130	9924130	9924130	9924130	9924130
9934500	9934500	9934500	9934500	9934500	9934500	9934500	9934500	9934500	9934500	9934500	9934500
9919080	9919080	9919080	9919080		9919080	9919080	9919080	9919080		9919080	
9931910	9931910	9931910	9931910		9931910	9931910	9931910	9931910			9931910
9930910	9930910	9930910	9930910	9930910	9930910	9930910	9930910	9930910	9930910	9930910	9930910
9931750	9931750	9931750	9931750	9931750	9931750	9931750	9931750	9931750	9931750	9931750	9931750
9931900	9931900	9931900	9931900	9931900	9931900	9931900	9931900	9931900	9931900	9931900	9931900
9921450	9921450	9921450	9921450	9921450	9921450	9921450	9921450	9921450	9921450	9921450	9921450
9924240	9924240	9924240	9924240	9924240	9924240	9924240	9924240	9924240	9924240	9924240	9924240
9920580	9920580	9920580	9920580	9920580	9920580	9920580	9920580	9920580	9920580	9920580	9920580
MA00018		MA00018		MA00018						MA00018	MA00018
9924340	9924340	9924340									
9921180	9921180	9921180	9921180	9921180	9921180	9921180	9921180	9921180	9921180	9921180	9921180
9920250	9920250	9920250	9920250	9920250	9920250	9920250	9920250	9920250	9920250	9920250	9920250
			9910150	9910150	9910150	9910150	9910150	9910150			
9906500	9906500	9906500	9906500	9906500	9906500	9906500	9906500	9906500	9906500	9906500	9906500
9931600	9931600	9931600	9931600	9931600	9931600	9931600	9931600	9931600	9931600	9931600	9931600



MOTORHISPANIA	MOTORHISPANIA	MOTORHISPANIA	MOTORHISPANIA
FURIA	FURIA MAX	RX	RX R
97-00	10-12	09-12	09-12
50cc 2T LC	50cc 2T LC	50cc 2T LC	50cc 2T LC
AM 6	AM 6	AM 6	AM 6

IT	EN	FR					
ALBERO MOTORE corsa 39 mm a piattelli pieni	Racing Crankshaft Stroke 39mm	VILEBREQUIN course 39 mm à contre-poids pleins		9921720	9921720	9921720	9921720
BIELLA Axe 16	CONROD Axle 16	BIELLE Axe 16		IM07033	IM07033	IM07033	IM07033
BIELLA Axe 18	CONROD Axle 18	BIELLE Axe 18		IM07036	IM07036	IM07036	IM07036
CAMBIO COMPLETO RACING	COMPLETE GEAR BOX RACING	BOÎTE DE VITESSES COMPLÈTE RACING		9935000	9935000	9935000	9935000
DESMODROMICO CAMBIO	SHIFT DRUM GEAR	BOÎTE DE VITESSES		9920020	9920020	9920020	9920020
CENTRALINA digitale ad ant. variabile volano Ducati 6 poli	CDI UNIT WITH VARIABLE ADVANCE (Ducati 6 coils)	BOÎTE ÉLECTRONIQUE numérique à avance variable volano Ducati 6 pôles		9921690	9921690	9921690	9921690
CENTRALINA RACING EU4	RACING EU4 CONTROL UNIT	BOÎTIER ÉLECTRONIQUE RACING EU4					
CUSCINETTI DI BANCO TPR Carbonirurati Serie	BEARINGS TPR Carbonitrided	PALIERI DE VILEBREQUIN TPR Carbonitrurés Jeu		9929180	9929180	9929180	9929180
FRIZIONE A DENTI DRITTI	STRAIGHT TEETH CLUTCH	EMBAYAGE À DENTS DROITES		9918550	9918550	9918550	9918550
GRUPPO TERMICO Ø STD Ghisa	CYLINDER KIT Ø Standard (CAST IRON)	CYLINDRE COMPLET Ø STD Fonte		9916770	9916770	9916770	9916770
GRUPPO TERMICO Ø Maggiorato Ghisa	CYLINDER KIT BIG BORE (CAST IRON)	CYLINDRE COMPLET Ø Majoré Fonte		9919250	9919250	9919250	9919250
GRUPPO TERMICO RACING Ø 49,5 Ghisa	CYLINDER KIT RACING Ø 49,5 (CAST IRON)	CYLINDRE COMPLET RACING Ø 49,5 Fonte		9919240	9919240	9919240	9919240
GRUPPO TERMICO RACING Ø 49,5 Ghisa testa scomposta	CYLINDER KIT RACING Ø 49,5 (CAST IRON) Decomposable head	CYLINDRE COMPLET RACING Ø 49,5 Fonte culasse décomposée		9921150	9921150	9921150	9921150
GRUPPO TERMICO RACING Ø 50 alluminio	CYLINDER KIT RACING Ø 50 (ALUMINIUM)	CYLINDRE COMPLET RACING Ø 50 aluminium		9924130	9924130	9924130	9924130
GRUPPO TERMICO RACING Ø Standard Alluminio	CYLINDER KIT RACING Ø Standard (ALUMINIUM)	CYLINDRE COMPLET RACING Ø Standard Aluminium		9934500	9934500	9934500	9934500
INGRANAGGO 6 VELOCITÀ AM6 1° Versione	GEAR 6° SPEED AM6 1° SERIES	ENGRENAGE 6 VITESSES 1° SERIE		9919080	9919080	9919080	9919080
INGRANAGGO 6 VELOCITÀ AM6 2° Versione	GEAR 6° SPEED AM6 2° SERIES	ENGRENAGE 6 VITESSES 2° SERIE		9931910	9931910	9931910	9931910
KIT ASPIRAZIONE COMPLETO MIKUNI TM 24 TPR 360	COMPLETE MIKUNI INLET KIT TM 24 TPR 360	KIT ASPIRATION COMPLET MIKUNI TM 24 TPR 360		9930910	9930910	9930910	9930910
KIT ASPIRAZIONE COMPLETO OKO 28 TPR 360	COMPLETE INLET KIT OKO 28 TPR 360	KIT ASPIRATION COMPLET OKO 28 TPR 360		9931750	9931750	9931750	9931750
KIT FRIZIONE + TAMBURO	HOUSING CLUTCH KIT+ BOSS	KIT EMBAYAGE + TAMBOUR		9931900	9931900	9931900	9931900
MAXI KIT RACING 85 cc ghisa Ø 49,5 corsa 44	MAXI KIT RACING 85cc CAST IRON Ø 49,5 stroke 44	MAXI KIT RACING 85 cc fonte Ø 49,5 course 44		9921450	9921450	9921450	9921450
MAXI KIT RACING 86 cc alluminio Ø 50 corsa 44	MAXI KIT RACING 86cc ALLUMINIUM Ø 49,5 stroke 44	MAXI KIT RACING 86 cc aluminium Ø 50 course 44		9924240	9924240	9924240	9924240
MOLLE FRIZIONE	CLUTCH SPRINGS	RESSORTS EMBRAYAGE		9920580	9920580	9920580	9920580
MOTORINO AVVIAMENTO	STARTER ENGINE	DÉMARREUR ÉLECTRIQUE					
SCARICO RACING omologato	RACING EXHAUST Approved	ÉCHAPPEMENT RACING homologué					
SERIE DISCHI frizione racing cellulosa/kevlar	CLUTCH PLATES RACING Cellulose/kevlar	JEU DISQUES embrayage racing cellulose/kevlar		9921180	9921180	9921180	9921180
SERIE DISCHI standard	CLUTCH PLATES Standard	JEU DISQUES standard		9920250	9920250	9920250	9920250
TRASDUTTORE per volano Ducati 6 poli	TRANSDUCER (Ducati 6 coils)	TRANSDUCTEUR pour volano Ducati 6 pôles		9910150	9910150	9910150	9910150
VALVOLA LAMELLARE	REED VALVE	CLAPET À LAMELLES		9906500	9906500	9906500	9906500
VALVOLA LAMELLARE TPR	REED VALVE TPR	CLAPET À LAMELLES TPR		9931600	9931600	9931600	9931600

PEUGEOT	PEUGEOT	PEUGEOT	RIEJU	RIEJU	RIEJU	RIEJU	RIEJU	RIEJU	RIEJU	RIEJU	RIEJU
SUPERMOTARD	XP6 TRAIL S/AVV. ELETTRICO	XR6 RACING CAT. C/AVV.ELETT.	MRT	MRT 50 EU4	MRT PRO	MRT PRO EU4	MRT PRO REPLICA EU4	MRT PRO REPLICA SM EU4	MRT PRO SM	MRT PRO SM EU4	MRT SM
90-02	90-02	90-02	09-12	18-20	09-12	18-20	18-20	18-20	09-12	18-20	09-12
50cc 2T LC	50cc 2T LC	50cc 2T LC	50cc 2T LC	50cc 2T LC	50cc 2T LC	50cc 2T LC	50cc 2T LC	50cc 2T LC	50cc 2T LC	50cc 2T LC	50cc 2T LC
AM 6	AM 6	AM 6	AM 6	AM 6	AM 6	AM 6	AM 6	AM 6	AM 6	AM 6	AM 6
9921720	9921720	9921720	9921720	9921720	9921720	9921720	9921720	9921720	9921720	9921720	9921720
IM07033	IM07033	IM07033	IM07033	IM07033	IM07033	IM07033	IM07033	IM07033	IM07033	IM07033	IM07033
IM07036	IM07036	IM07036	IM07036	IM07036	IM07036	IM07036	IM07036	IM07036	IM07036	IM07036	IM07036
9935000	9935000	9935000	9935000	9935000	9935000	9935000	9935000	9935000	9935000	9935000	9935000
9920020	9920020	9920020	9920020	9920020	9920020	9920020	9920020	9920020	9920020	9920020	9920020
9921690	9921690	9921690									
				9934440		9934440	9934440	9934440		9934440	
9929180	9929180	9929180	9929180	9929180	9929180	9929180	9929180	9929180	9929180	9929180	9929180
9918550	9918550	9918550	9918550	9918550	9918550	9918550	9918550	9918550	9918550	9918550	9918550
9916770	9916770	9916770	9916770	9916770 KT00098	9916770	9916770 KT00098	9916770 KT00098	9916770 KT00098	9916770	9916770 KT00098	9916770
9919250	9919250	9919250	9919250	9919250 KT00114	9919250	9919250 KT00114	9919250 KT00114	9919250 KT00114	9919250	9919250 KT00114	9919250
9919240	9919240	9919240	9919240	9919240	9919240	9919240	9919240	9919240	9919240	9919240	9919240
9921150	9921150	9921150	9921150	9921150	9921150	9921150	9921150	9921150	9921150	9921150	9921150
9924130	9924130	9924130	9924130	9924130	9924130	9924130	9924130	9924130	9924130	9924130	9924130
9934500	9934500	9934500	9934500	9934500	9934500	9934500	9934500	9934500	9934500	9934500	9934500
9919080	9919080	9919080	9919080	9919080	9919080	9919080	9919080	9919080	9919080	9919080	9919080
9931910	9931910	9931910	9931910	9931910	9931910	9931910	9931910	9931910	9931910	9931910	9931910
9930910	9930910	9930910	9930910	9930910	9930910	9930910	9930910	9930910	9930910	9930910	9930910
9931750	9931750	9931750	9931750	9931750	9931750	9931750	9931750	9931750	9931750	9931750	9931750
9931900	9931900	9931900	9931900	9931900	9931900	9931900	9931900	9931900	9931900	9931900	9931900
9921450	9921450	9921450	9921450	9921450	9921450	9921450	9921450	9921450	9921450	9921450	9921450
9924240	9924240	9924240	9924240	9924240	9924240	9924240	9924240	9924240	9924240	9924240	9924240
9920580	9920580	9920580	9920580	9920580	9920580	9920580	9920580	9920580	9920580	9920580	9920580
9921180	9921180	9921180	9921180	9921180	9921180	9921180	9921180	9921180	9921180	9921180	9921180
9920250	9920250	9920250	9920250	9920250	9920250	9920250	9920250	9920250	9920250	9920250	9920250
9910150	9910150	9910150	9910150		9910150			9910150		9910150	9910150
9906500	9906500	9906500	9906500	9906500	9906500	9906500	9906500	9906500	9906500	9906500	9906500
9931600	9931600	9931600	9931600	9931600	9931600	9931600	9931600	9931600	9931600	9931600	9931600



RIEJU	RIEJU	RIEJU	RIEJU
MRT SM EU4	MRT TROPHY EU4	MRX	MRX PRO
18-20	18-20	01-04	01-04
50cc 2T LC	50cc 2T LC	50cc 2T LC	50cc 2T LC
AM 6	AM 6	AM 6	AM 6

IT	EN	FR					
ALBERO MOTORE corsa 39 mm a piattelli pieni	Racing Crankshaft Stroke 39mm	VILEBREQUIN course 39 mm à contre-poids pleins		9921720	9921720	9921720	9921720
BIELLA Axe 16	CONROD Axle 16	BIELLE Axe 16		IM07033	IM07033	IM07033	IM07033
BIELLA Axe 18	CONROD Axle 18	BIELLE Axe 18		IM07036	IM07036	IM07036	IM07036
CAMBIO COMPLETO RACING	COMPLETE GEAR BOX RACING	BOÎTE DE VITESSES COMPLÈTE RACING		9935000	9935000	9935000	9935000
DESMODROMICO CAMBIO	SHIFT DRUM GEAR	BOÎTE DE VITESSES		9920020	9920020	9920020	9920020
CENTRALINA digitale ad ant. variabile volano Ducati 6 poli	CDI UNIT WITH VARIABLE ADVANCE (Ducati 6 coils)	BOÎTE ÉLECTRONIQUE numérique à avance variable volant Ducati 6 pôles				9921690	9921690
CENTRALINA RACING EU4	RACING EU4 CONTROL UNIT	BOÎTIER ÉLECTRONIQUE RACING EU4		9934440	9934440		
CUSCINETTI DI BANCO TPR Carbonirurati Serie	BEARINGS TPR Carbonitrided	PALIERI DE VILEBREQUIN TPR Carbonitrurés Jeu		9929180	9929180	9929180	9929180
FRIZIONE A DENTI DRITTI	STRAIGHT TEETH CLUTCH	EMBAYAGE À DENTS DROITES		9918550	9918550	9918550	9918550
GRUPPO TERMICO Ø STD Ghisa	CYLINDER KIT Ø Standard (CAST IRON)	CYLINDRE COMPLET Ø STD Fonte		9916770 KT00098	9916770 KT00098	9916770	9916770
GRUPPO TERMICO Ø Maggiorato Ghisa	CYLINDER KIT BIG BORE (CAST IRON)	CYLINDRE COMPLET Ø Majoré Fonte		9919250 KT00114	9919250 KT00114	9919250	9919250
GRUPPO TERMICO RACING Ø 49,5 Ghisa	CYLINDER KIT RACING Ø 49,5 (CAST IRON)	CYLINDRE COMPLET RACING Ø 49,5 Fonte		9919240	9919240	9919240	9919240
GRUPPO TERMICO RACING Ø 49,5 Ghisa testa scomposta	CYLINDER KIT RACING Ø 49,5 (CAST IRON) Decomposable head	CYLINDRE COMPLET RACING Ø 49,5 Fonte culasse décomposée		9921150	9921150	9921150	9921150
GRUPPO TERMICO RACING Ø 50 alluminio	CYLINDER KIT RACING Ø 50 (ALUMINIUM)	CYLINDRE COMPLET RACING Ø 50 aluminium		9924130	9924130	9924130	9924130
GRUPPO TERMICO RACING Ø Standard Alluminio	CYLINDER KIT RACING Ø Standard (ALUMINIUM)	CYLINDRE COMPLET RACING Ø Standard Aluminium		9934500	9934500	9934500	9934500
INGRANAGGIO 6 VELOCITÀ AM6 1° Versione	GEAR 6° SPEED AM6 1° SERIES	ENGRENAGE 6 VITESSES 1° SERIE		9919080	9919080	9919080	9919080
INGRANAGGIO 6 VELOCITÀ AM6 2° Versione	GEAR 6° SPEED AM6 2° SERIES	ENGRENAGE 6 VITESSES 2° SERIE		9931910	9931910	9931910	9931910
KIT ASPIRAZIONE COMPLETO MIKUNI TM 24 TPR 360	COMPLETE MIKUNI INLET KIT TM 24 TPR 360	KIT ASPIRATION COMPLET MIKUNI TM 24 TPR 360		9930910	9930910	9930910	9930910
KIT ASPIRAZIONE COMPLETO OKO 28 TPR 360	COMPLETE INLET KIT OKO 28 TPR 360	KIT ASPIRATION COMPLET OKO 28 TPR 360		9931750	9931750	9931750	9931750
KIT FRIZIONE + TAMBURO	HOUSING CLUTCH KIT+ BOSS	KIT EMBRAYAGE + TAMBOUR		9931900	9931900	9931900	9931900
MAXI KIT RACING 85 cc ghisa Ø 49,5 corsa 44	MAXI KIT RACING 85cc CAST IRON Ø 49,5 stroke 44	MAXI KIT RACING 85 cc fonte Ø 49,5 course 44		9921450	9921450	9921450	9921450
MAXI KIT RACING 86 cc alluminio Ø 50 corsa 44	MAXI KIT RACING 86cc ALLUMINIUM Ø 49,5 stroke 44	MAXI KIT RACING 86 cc aluminium Ø 50 course 44		9924240	9924240	9924240	9924240
MOLLE FRIZIONE	CLUTCH SPRINGS	RESSORTS EMBRAYAGE		9920580	9920580	9920580	9920580
MOTORINO AVVIAMENTO	STARTER ENGINE	DÉMARREUR ÉLECTRIQUE					
SCARICO RACING omologato	RACING EXHAUST Approved	ÉCHAPPEMENT RACING homologué					
SERIE DISCHI frizione racing cellulosa/kevlar	CLUTCH PLATES RACING Cellulose/kevlar	JEU DISQUES embrayage racing cellulose/kevlar		9921180	9921180	9921180	9921180
SERIE DISCHI standard	CLUTCH PLATES Standard	JEU DISQUES standard		9920250	9920250	9920250	9920250
TRASDUTTORE per volano Ducati 6 poli	TRANSDUCER (Ducati 6 coils)	TRANSDUCTEUR pour volant Ducati 6 pôles				9910150	9910150
VALVOLA LAMELLARE	REED VALVE	CLAPET À LAMELLES		9906500	9906500	9906500	9906500
VALVOLA LAMELLARE TPR	REED VALVE TPR	CLAPET À LAMELLES TPR		9931600	9931600	9931600	9931600

RIEJU	RIEJU	RIEJU	RIEJU	RIEJU	RIEJU	RIEJU	RIEJU	RIEJU	RIEJU	SHERCO	SHERCO
RR	RS1	RS2 MATRIX	RS2 MATRIX PRO	RS2 NAKED	RS3 EU4	RS3 NKD EU4	SMX E.S./K.S.	SMX PRO E.S./K.S.	SPIKE	FACTORY SE-R EU4	FACTORY SE-RS EU4
05-06	98-01	05-06	05-06	04-05	18-20	18-20	01-01	03-03	98-01	18-20	18-20
50cc 2T LC	50cc 2T LC	50cc 2T LC	50cc 2T LC	50cc 2T LC	50cc 2T LC	50cc 2T LC	50cc 2T LC	50cc 2T LC	50cc 2T LC	50cc 2T LC	50cc 2T LC
AM 6	AM 6	AM 6	AM 6	AM 6	AM 6	AM 6	AM 6	AM 6	AM 6	AM 6	AM 6
9921720	9921720	9921720	9921720	9921720	9921720	9921720	9921720	9921720	9921720	9921720	9921720
IM07033	IM07033	IM07033	IM07033	IM07033	IM07033	IM07033	IM07033	IM07033	IM07033	IM07033	IM07033
IM07036	IM07036	IM07036	IM07036	IM07036	IM07036	IM07036	IM07036	IM07036	IM07036	IM07036	IM07036
9935000	9935000	9935000	9935000	9935000	9935000	9935000	9935000	9935000	9935000	9935000	9935000
9920020	9920020	9920020	9920020	9920020	9920020	9920020	9920020	9920020	9920020	9920020	9920020
9921690	9921690	9921690	9921690	9921690			9921690	9921690	9921690		
					9934440	9934440				9934440	9934440
9929180	9929180	9929180	9929180	9929180	9929180	9929180	9929180	9929180	9929180	9929180	9929180
9918550	9918550	9918550	9918550	9918550	9918550	9918550	9918550	9918550	9918550	9918550	9918550
9916770	9916770	9916770	9916770	9916770	9916770 KT00098	9916770 KT00098	9916770	9916770	9916770	9916770 KT00098	9916770 KT00098
9919250	9919250	9919250	9919250	9919250	9919250 KT00114	9919250 KT00114	9919250	9919250	9919250	9919250 KT00114	9919250 KT00114
9919240	9919240	9919240	9919240	9919240	9919240	9919240	9919240	9919240	9919240	9919240	9919240
9921150	9921150	9921150	9921150	9921150	9921150	9921150	9921150	9921150	9921150	9921150	9921150
9924130	9924130	9924130	9924130	9924130	9924130	9924130	9924130	9924130	9924130	9924130	9924130
9934500	9934500	9934500	9934500	9934500	9934500	9934500	9934500	9934500	9934500	9934500	9934500
9919080	9919080	9919080	9919080	9919080	9919080	9919080	9919080	9919080	9919080	9919080	9919080
9931910	9931910	9931910	9931910	9931910	9931910	9931910	9931910	9931910	9931910	9931910	9931910
9930910	9930910	9930910	9930910	9930910	9930910	9930910	9930910	9930910	9930910	9930910	9930910
9931750	9931750	9931750	9931750	9931750	9931750	9931750	9931750	9931750	9931750	9931750	9931750
9931900	9931900	9931900	9931900	9931900	9931900	9931900	9931900	9931900	9931900	9931900	9931900
9921450	9921450	9921450	9921450	9921450	9921450	9921450	9921450	9921450	9921450	9921450	9921450
9924240	9924240	9924240	9924240	9924240	9924240	9924240	9924240	9924240	9924240	9924240	9924240
9920580	9920580	9920580	9920580	9920580	9920580	9920580	9920580	9920580	9920580	9920580	9920580
9921180	9921180	9921180	9921180	9921180	9921180	9921180	9921180	9921180	9921180	9921180	9921180
9920250	9920250	9920250	9920250	9920250	9920250	9920250	9920250	9920250	9920250	9920250	9920250
9910150	9910150	9910150	9910150	9910150			9910150	9910150	9910150		
9906500	9906500	9906500	9906500	9906500	9906500	9906500	9906500	9906500	9906500	9906500	9906500
9931600	9931600	9931600	9931600	9931600	9931600	9931600	9931600	9931600	9931600	9931600	9931600

MOTO 50cc



SHERCO	SHERCO	SHERCO	SHERCO
FACTORY SILVER SM-R EU4	FACTORY SILVER SM-RS EU4	FACTORY SM-R EU4	FACTORY SM-RS EU4
18-20	18-20	18-20	18-20
50cc 2T LC	50cc 2T LC	50cc 2T LC	50cc 2T LC
AM 6	AM 6	AM 6	AM 6

IT	EN	FR				
ALBERO MOTORE corsa 39 mm a piattelli pieni	Racing Crankshaft Stroke 39mm	VILEBREQUIN course 39 mm à contre-poids pleins		9921720	9921720	9921720
BIELLA Axe 16	CONROD Axle 16	BIELLE Axe 16		IM07033	IM07033	IM07033
BIELLA Axe 18	CONROD Axle 18	BIELLE Axe 18		IM07036	IM07036	IM07036
CAMBIO COMPLETO RACING	COMPLETE GEAR BOX RACING	BOÎTE DE VITESSES COMPLÈTE RACING		9935000	9935000	9935000
DESMODROMICO CAMBIO	SHIFT DRUM GEAR	BOÎTE DE VITESSES		9920020	9920020	9920020
CENTRALINA digitale ad ant. variabile volano Ducati 6 poli	CDI UNIT WITH VARIABLE ADVANCE (Ducati 6 coils)	BOÎTE ÉLECTRONIQUE numérique à avance variable volant Ducati 6 pôles				
CENTRALINA RACING EU4	RACING EU4 CONTROL UNIT	BOÎTIER ÉLECTRONIQUE RACING EU4		9934440	9934440	9934440
CUSCINETTI DI BANCO TPR Carbonirurati Serie	BEARINGS TPR Carbonitrided	PALIERI DE VILEBREQUIN TPR Carbonitrurés Jeu		9929180	9929180	9929180
FRIZIONE A DENTI DRITTI	STRAIGHT TEETH CLUTCH	EMBAYAGE À DENTS DROITES		9918550	9918550	9918550
GRUPPO TERMICO Ø STD Ghisa	CYLINDER KIT Ø Standard (CAST IRON)	CYLINDRE COMPLET Ø STD Fonte		9916770 KT00098	9916770 KT00098	9916770 KT00098
GRUPPO TERMICO Ø Maggiorato Ghisa	CYLINDER KIT BIG BORE (CAST IRON)	CYLINDRE COMPLET Ø Majoré Fonte		9919250 KT00114	9919250 KT00114	9919250 KT00114
GRUPPO TERMICO RACING Ø 49,5 Ghisa	CYLINDER KIT RACING Ø 49,5 (CAST IRON)	CYLINDRE COMPLET RACING Ø 49,5 Fonte		9919240	9919240	9919240
GRUPPO TERMICO RACING Ø 49,5 Ghisa testa scomposta	CYLINDER KIT RACING Ø 49,5 (CAST IRON) Decomposable head	CYLINDRE COMPLET RACING Ø 49,5 Fonte culasse décomposée		9921150	9921150	9921150
GRUPPO TERMICO RACING Ø 50 alluminio	CYLINDER KIT RACING Ø 50 (ALUMINIUM)	CYLINDRE COMPLET RACING Ø 50 aluminium		9924130	9924130	9924130
GRUPPO TERMICO RACING Ø Standard Alluminio	CYLINDER KIT RACING Ø Standard (ALUMINIUM)	CYLINDRE COMPLET RACING Ø Standard Aluminium		9934500	9934500	9934500
INGRANAGGIO 6 VELOCITÀ AM6 1° Versione	GEAR 6° SPEED AM6 1° SERIES	ENGRENAGE 6 VITESSES 1° SERIE		9919080	9919080	9919080
INGRANAGGIO 6 VELOCITÀ AM6 2° Versione	GEAR 6° SPEED AM6 2° SERIES	ENGRENAGE 6 VITESSES 2° SERIE		9931910	9931910	9931910
KIT ASPIRAZIONE COMPLETO MIKUNI TM 24 TPR 360	COMPLETE MIKUNI INLET KIT TM 24 TPR 360	KIT ASPIRATION COMPLET MIKUNI TM 24 TPR 360		9930910	9930910	9930910
KIT ASPIRAZIONE COMPLETO OKO 28 TPR 360	COMPLETE INLET KIT OKO 28 TPR 360	KIT ASPIRATION COMPLET OKO 28 TPR 360		9931750	9931750	9931750
KIT FRIZIONE + TAMBURO	HOUSING CLUTCH KIT+ BOSS	KIT EMBRAYAGE + TAMBOUR		9931900	9931900	9931900
MAXI KIT RACING 85 cc ghisa Ø 49,5 corsa 44	MAXI KIT RACING 85cc CAST IRON Ø 49,5 stroke 44	MAXI KIT RACING 85 cc fonte Ø 49,5 course 44		9921450	9921450	9921450
MAXI KIT RACING 86 cc alluminio Ø 50 corsa 44	MAXI KIT RACING 86cc ALLUMINIUM Ø 49,5 stroke 44	MAXI KIT RACING 86 cc aluminium Ø 50 course 44		9924240	9924240	9924240
MOLLE FRIZIONE	CLUTCH SPRINGS	RESSORTS EMBRAYAGE		9920580	9920580	9920580
MOTORINO AVVIAMENTO	STARTER ENGINE	DÉMARREUR ÉLECTRIQUE				
SCARICO RACING omologato	RACING EXHAUST Approved	ÉCHAPPEMENT RACING homologué				
SERIE DISCHI frizione racing cellulosa/kevlar	CLUTCH PLATES RACING Cellulose/kevlar	JEU DISQUES embrayage racing cellulose/kevlar		9921180	9921180	9921180
SERIE DISCHI standard	CLUTCH PLATES Standard	JEU DISQUES standard		9920250	9920250	9920250
TRASDUTTORE per volano Ducati 6 poli	TRANSDUCER (Ducati 6 coils)	TRANSDUCTEUR pour volant Ducati 6 pôles				
VALVOLA LAMELLARE	REED VALVE	CLAPET À LAMELLES		9906500	9906500	9906500
VALVOLA LAMELLARE TPR	REED VALVE TPR	CLAPET À LAMELLES TPR		9931600	9931600	9931600

SHERCO	SHERCO	VALENTI RACING	VALENTI RACING	VENT	VENT	VENT	VENT	YAMAHA	YAMAHA	YAMAHA	YAMAHA
HRD ENDURO	HRD MOTARD	RME	SM	BAJA	BAJA RR	DERAPAGE	DERAPAGE RR	DT R	DT R	DT R	DT R
09-13	09-13	15-17	15-17	18-20	18-20	18-20	18-20	03-05	06-06	07-07	08-11
50cc 2T LC	50cc 2T LC	50cc 2T LC	50cc 2T LC	50cc 2T LC	50cc 2T LC	50cc 2T LC	50cc 2T LC	50cc 2T LC	50cc 2T LC	50cc 2T LC	50cc 2T LC
AM 6	AM 6	D50B0	D50B0	AM 6	AM 6	AM 6	AM 6	AM 6	AM 6	AM 6	AM 6
9921720	9921720	9930150	9930150	9921720	9921720	9921720	9921720	9921720	9921720	9921720	9921720
IM07033	IM07033							IM07033	IM07033	IM07033	IM07033
IM07036	IM07036			IM07036	IM07036	IM07036	IM07036	IM07036	IM07036	IM07036	IM07036
9935000	9935000			9935000	9935000	9935000	9935000	9935000	9935000	9935000	9935000
9920020	9920020			9920020	9920020	9920020	9920020	9920020	9920020	9920020	9920020
9921690	9921690							9921690	9921690		
				9934440	9934440	9934440	9934440				
9929180	9929180	9929190	9929190	9929180	9929180	9929180	9929180	9929180	9929180	9929180	9929180
9918550	9918550			9918550	9918550	9918550	9918550	9918550	9918550	9918550	9918550
9916770	9916770	9927100	9927100	9916770	9916770	9916770	9916770	9916770	9916770	9916770	9916770
9919250	9919250	9927020	9927020	9919250	9919250	9919250	9919250	9919250	9919250	9919250	9919250
9919240	9919240			9919240	9919240	9919240	9919240	9919240	9919240	9919240	9919240
9921150	9921150			9921150	9921150	9921150	9921150	9921150	9921150	9921150	9921150
9924130	9924130			9924130	9924130	9924130	9924130	9924130	9924130	9924130	9924130
9934500	9934500			9934500	9934500	9934500	9934500	9934500	9934500	9934500	9934500
9919080	9919080							9919080	9919080	9919080	9919080
9931910	9931910			9931910	9931910	9931910	9931910	9931910	9931910	9931910	9931910
9930910	9930910	9930910	9930910	9930910	9930910	9930910	9930910	9930910	9930910	9930910	9930910
9931750	9931750	9931750	9931750	9931750	9931750	9931750	9931750	9931750	9931750	9931750	9931750
9931900	9931900			9931900	9931900	9931900	9931900	9931900	9931900	9931900	9931900
9921450	9921450			9921450	9921450	9921450	9921450	9921450	9921450	9921450	9921450
9924240	9924240	9934270	9934270	9924240	9924240	9924240	9924240	9924240	9924240	9924240	9924240
9920580	9920580	9923180	9923180	9920580	9920580	9920580	9920580	9920580	9920580	9920580	9920580
				MA00018	MA00018	MA00018	MA00018				
				9924340	9924340	9924340	9924340				
9921180	9921180	9923190	9923190	9921180	9921180	9921180	9921180	9921180	9921180	9921180	9921180
9920250	9920250			9920250	9920250	9920250	9920250	9920250	9920250	9920250	9920250
9910150	9910150							9910150	9910150		
9906500	9906500			9906500	9906500	9906500	9906500	9906500	9906500	9906500	9906500
9931600	9931600			9931600	9931600	9931600	9931600	9931600	9931600	9931600	9931600



YAMAHA	YAMAHA	YAMAHA	YAMAHA
DT RSM	DT X	DT X	DT X
03-05	06-06	07-07	08-11
50cc 2T LC	50cc 2T LC	50cc 2T LC	50cc 2T LC
AM 6	AM 6	AM 6	AM 6

IT	EN	FR				
ALBERO MOTORE corsa 39 mm a piattelli pieni	Racing Crankshaft Stroke 39mm	VILEBREQUIN course 39 mm à contre-poids pleins		9921720	9921720	9921720
BIELLA Axe 16	CONROD Axle 16	BIELLE Axe 16		IM07033	IM07033	IM07033
BIELLA Axe 18	CONROD Axle 18	BIELLE Axe 18		IM07036	IM07036	IM07036
CAMBIO COMPLETO RACING	COMPLETE GEAR BOX RACING	BOÎTE DE VITESSES COMPLÈTE RACING		9935000	9935000	9935000
DESMODROMICO CAMBIO	SHIFT DRUM GEAR	BOÎTE DE VITESSES		9920020	9920020	9920020
CENTRALINA digitale ad ant. variabile volano Ducati 6 poli	CDI UNIT WITH VARIABLE ADVANCE (Ducati 6 coils)	BOÎTE ÉLECTRONIQUE numérique à avance variable volan Ducati 6 pôles		9921690	9921690	
CENTRALINA RACING EU4	RACING EU4 CONTROL UNIT	BOÎTIER ÉLECTRONIQUE RACING EU4				
CUSCINETTI DI BANCO TPR Carbonirurati Serie	BEARINGS TPR Carbonitrided	PALIERI DE VILEBREQUIN TPR Carbonitrurés Jeu		9929180	9929180	9929180
FRIZIONE A DENTI DRITTI	STRAIGHT TEETH CLUTCH	EMBAYAGE À DENTS DROITES		9918550	9918550	9918550
GRUPPO TERMICO Ø STD Ghisa	CYLINDER KIT Ø Standard (CAST IRON)	CYLINDRE COMPLET Ø STD Fonte		9916770	9916770	9916770
GRUPPO TERMICO Ø Maggiorato Ghisa	CYLINDER KIT BIG BORE (CAST IRON)	CYLINDRE COMPLET Ø Majoré Fonte		9919250	9919250	9919250
GRUPPO TERMICO RACING Ø 49,5 Ghisa	CYLINDER KIT RACING Ø 49,5 (CAST IRON)	CYLINDRE COMPLET RACING Ø 49,5 Fonte		9919240	9919240	9919240
GRUPPO TERMICO RACING Ø 49,5 Ghisa testa scomposta	CYLINDER KIT RACING Ø 49,5 (CAST IRON) Decomposable head	CYLINDRE COMPLET RACING Ø 49,5 Fonte culasse décomposée		9921150	9921150	9921150
GRUPPO TERMICO RACING Ø 50 alluminio	CYLINDER KIT RACING Ø 50 (ALUMINIUM)	CYLINDRE COMPLET RACING Ø 50 aluminium		9924130	9924130	9924130
GRUPPO TERMICO RACING Ø Standard Alluminio	CYLINDER KIT RACING Ø Standard (ALUMINIUM)	CYLINDRE COMPLET RACING Ø Standard Aluminium		9934500	9934500	9934500
INGRANAGGO 6 VELOCITÀ AM6 1° Versione	GEAR 6° SPEED AM6 1° SERIES	ENGRENAGE 6 VITESSES 1° SERIE		9919080	9919080	9919080
INGRANAGGO 6 VELOCITÀ AM6 2° Versione	GEAR 6° SPEED AM6 2° SERIES	ENGRENAGE 6 VITESSES 2° SERIE		9931910	9931910	9931910
KIT ASPIRAZIONE COMPLETO MIKUNI TM 24 TPR 360	COMPLETE MIKUNI INLET KIT TM 24 TPR 360	KIT ASPIRATION COMPLET MIKUNI TM 24 TPR 360		9930910	9930910	9930910
KIT ASPIRAZIONE COMPLETO OKO 28 TPR 360	COMPLETE INLET KIT OKO 28 TPR 360	KIT ASPIRATION COMPLET OKO 28 TPR 360		9931750	9931750	9931750
KIT FRIZIONE + TAMBURO	HOUSING CLUTCH KIT+ BOSS	KIT EMBAYAGE + TAMBOUR		9931900	9931900	9931900
MAXI KIT RACING 85 cc ghisa Ø 49,5 corsa 44	MAXI KIT RACING 85cc CAST IRON Ø 49,5 stroke 44	MAXI KIT RACING 85 cc fonte Ø 49,5 course 44		9921450	9921450	9921450
MAXI KIT RACING 86 cc alluminio Ø 50 corsa 44	MAXI KIT RACING 86cc ALLUMINIUM Ø 49,5 stroke 44	MAXI KIT RACING 86 cc aluminium Ø 50 course 44		9924240	9924240	9924240
MOLLE FRIZIONE	CLUTCH SPRINGS	RESSORTS EMBAYAGE		9920580	9920580	9920580
MOTORINO AVVIAMENTO	STARTER ENGINE	DÉMARREUR ÉLECTRIQUE				
SCARICO RACING omologato	RACING EXHAUST Approved	ÉCHAPPEMENT RACING homologué				
SERIE DISCHI frizione racing cellulosa/kevlar	CLUTCH PLATES RACING Cellulose/kevlar	JEU DISQUES embrayage racing cellulose/kevlar		9921180	9921180	9921180
SERIE DISCHI standard	CLUTCH PLATES Standard	JEU DISQUES standard		9920250	9920250	9920250
TRASDUTTORE per volano Ducati 6 poli	TRANSDUCER (Ducati 6 coils)	TRANSDUCTEUR pour volan Ducati 6 pôles		9910150	9910150	
VALVOLA LAMELLARE	REED VALVE	CLAPET À LAMELLES		9906500	9906500	9906500
VALVOLA LAMELLARE TPR	REED VALVE TPR	CLAPET À LAMELLES TPR		9931600	9931600	9931600

YAMAHA	YAMAHA	YAMAHA	YAMAHA	YAMAHA	YAMAHA	YAMAHA
TZR	TZR	TZR	TZR	TZR	TZR	TZR RR
03-05	06-06	07-07	08-08	10-10	11-11	05-05
50cc 2T LC	50cc 2T LC	50cc 2T LC	50cc 2T LC	50cc 2T LC	50cc 2T LC	50cc 2T LC
AM 6	AM 6	AM 6	AM 6	AM 6	AM 6	AM 6
9921720	9921720	9921720	9921720	9921720	9921720	9921720
IM07033	IM07033	IM07033	IM07033	IM07033	IM07033	IM07033
IM07036	IM07036	IM07036	IM07036	IM07036	IM07036	IM07036
9935000	9935000	9935000	9935000	9935000		9935000
9920020	9920020	9920020	9920020	9920020	9920020	9920020
9929180	9929180	9929180	9929180	9929180	9929180	9929180
9918550	9918550	9918550	9918550	9918550	9918550	9918550
9916770	9916770	9916770	9916770	9916770	9916770	9916770
9919250	9919250	9919250	9919250	9919250	9919250	9919250
9919240	9919240	9919240	9919240	9919240	9919240	9919240
9921150	9921150	9921150	9921150	9921150	9921150	9921150
9924130	9924130	9924130	9924130	9924130	9924130	9924130
9934500	9934500	9934500	9934500	9934500	9934500	9934500
9919080	9919080	9919080	9919080	9919080		9919080
9931910	9931910	9931910	9931910	9931910		9931910
9930910	9930910	9930910	9930910	9930910	9930910	9930910
9931750	9931750	9931750	9931750	9931750	9931750	9931750
9931900	9931900	9931900	9931900	9931900	9931900	9931900
9921450	9921450	9921450	9921450	9921450	9921450	9921450
9924240	9924240	9924240	9924240	9924240	9924240	9924240
9920580	9920580	9920580	9920580	9920580	9920580	9920580
MA00018	MA00018	MA00018	MA00018	MA00018	MA00018	MA00018
9921180	9921180	9921180	9921180	9921180	9921180	9921180
9920250	9920250	9920250	9920250	9920250	9920250	9920250
9906500	9906500	9906500	9906500	9906500	9906500	9906500
9931600	9931600	9931600	9931600	9931600	9931600	9931600



9934270
Maxi Kit Racing
86 cc Ø 50

MOTO 50cc

SCOOTER 50cc



APRILIA	APRILIA	APRILIA	APRILIA
AMICO	AMICO	AMICO GL/GLE	AMICO LX/SPORT/CAT
94-94	96-98	93-95	92-93
50cc 2T AC	50cc 2T AC	50cc 2T AC	50cc 2T
CW	CW	CW	CW

IT	EN	FR				
ALBERO MOTORE Con Cuscinetti e Paraoli	CRANKSHAFT with bearings and oil seals	VILEBREQUIN doté de Paliers et Joints d'huile		IM07058	IM07058	IM07058
ALBERO MOTORE Senza Cuscinetti e Paraoli	CRANKSHAFT without bearings and oil seals	VILEBREQUIN sans Paliers et Joints d'huile		IM07013	IM07013	IM07013
ACCENSIONE Fissa	IGNITION UNIT Fixed	ALLUMAGE Fixe				
ACCENSIONE Variabile	IGNITION UNIT Variable	ALLUMAGE Variable				
ACCENSIONE Digitale	DIGITAL IGNITION UNIT	ALLUMAGE Numérique				
BIELLA	CONROD	BIELLE		IM07032	IM07032	IM07032
CAMPANA FRIZIONE	CLUTCH HOUSING	CLOCHE EMBRAYAGE				
CINGHIA DI TRASMISSIONE TOP PERFORMANCES	TRANSMISSION BELT TOP PERFORMANCES	COURROIE DE TRANSMISSION TOP PERFORMANCES		9907770	9907770	9907770
CINGHIA DI TRASMISSIONE Mitsuboshi	TRANSMISSION BELT Mitsuboshi	COURROIE DE TRANSMISSION Mitsuboshi		9935270	9935270	9935270
COLLETTORE ASPIRAZIONE	INLET MANIFOLD	COLLECTEUR ASPIRATION		CT00726	CT00726	CT00726
CONVERTITORE DI COPPIA	TORQUE CONVERTER	CONVERTISSEUR DE COUPLE		9923030	9923030	9923030
FRIZIONE CENTRIFUGA Ø 105	CENTRIFUGAL CLUTCH Ø 105	EMBAYAGE CENTRIFUGE Ø 105		9911060	9911060	9911060
FRIZIONE CENTRIFUGA Ø 107	CENTRIFUGAL CLUTCH Ø 107	EMBAYAGE CENTRIFUGE Ø 107		9910020 9925130	9910020 9925130	9910020 9925130
GANASCE FRENO	BRAKE SHOES	MÂCHOIRES FREIN				CP00219
GRUPPO TERMICO Ø Standard c/testa	CYLINDER KIT Ø standard with head	CYLINDRE COMPLET Ø Standard avec culasse		9931170	9931170	9931170
GRUPPO TERMICO Ø Standard s/testa	CYLINDER KIT Ø standard without head	CYLINDRE COMPLET Ø Standard sans culasse		KT00096	KT00096	KT00096
GRUPPO TERMICO Ø Magg. c/testa	CYLINDER KIT BIG BORE with head	CYLINDRE COMPLET Ø Majoré avec culasse		9931370 KT00088	9931370 KT00088	9931370 KT00088
GRUPPO TERMICO Ø Magg. s/testa	CYLINDER KIT BIG BORE without head	CYLINDRE COMPLET Ø Majoré sans culasse				
GRUPPO TERMICO Modifica da AC a LC	CYLINDER KIT Conversion AC to LC	CYLINDRE COMPLET Modification de AC à LC				
KIT CUSCINETTI DA BANCO	BEARINGS KIT	KIT PALIERS DE VILEBREQUIN		KK01000 KK01002	KK01000 KK01002	KK01000 KK01002
KIT REVISIONE POMPA ACQUA	WATER PUMP REPAIR KIT	KIT RÉVISION POMPE À EAU				
MEMBRANA CARBURATORE	CARBURETOR DIAPHRAGM	MEMBRANE CARBURATEUR				
MOTORINO D'AVVIAMENTO	STARTER ENGINE	DÉMARREUR ÉLECTRIQUE		MA00001	MA00001	MA00001
PULEGGIA FISSA	VARIATOR SHEAVE FIXED	POULIE FIXE				
RAPPORTI ALLUNGATI Primari	GEARS KIT Primary	RAPPORTS ALLONGÉS Primaires		9913300	9913300	9913300
RAPPORTI ALLUNGATI Secondari	GEARS KIT Secondary	RAPPORTS ALLONGÉS Secondaires				
REGOLATORE DI TENSIONE	RECTIFIER	RÉGULATEUR DE TENSION		RE00014	RE00014	RE00014
RUOTA LIBERA	STARTER CLUTCH	ROUE LIBRE		AA00767 RL00001	AA00767 RL00001	AA00767 RL00001
STATORE	STATOR	STATOR				
VALVOLA LAMELLARE	REED VALVE	CLAPET À LAMELLES		9906520	9906520	9906520

APRILIA	APRILIA	APRILIA	APRILIA	APRILIA	APRILIA	APRILIA	APRILIA	APRILIA	APRILIA	APRILIA	APRILIA
AMICO LX/ SPORT/CAT	AREA 51	GULLIVER	GULLIVER LC	GULLIVER LC	HABANA-MOJITO CUSTOM	HABANA- MOJITO RETRO'	MOJITO CUSTOM 2T MOTORE PIAGGIO	RALLY	RALLY LIQUID COOLED	SCARABEO	SCARABEO
92-93	98-00	95-98	96-98	96-98	99-03	99-03	04-10	95-03	96-99	93-97	98-98
50cc 2T AC	50cc 2T LC	50cc 2T AC	50cc 2T	50cc 2T LC	50cc 2T AC	50cc 2T AC	50cc 2T AC	50cc 2T AC	50cc 2T LC	50cc 2T AC	50cc 2T AC
CW	MA	MY	MA	MA	Motore Aprilia	Motore Aprilia	Motore Piaggio	MY	MA	MY	MY
IM07058	IM07059	IM07059		IM07059			IM07060	IM07059	IM07059	IM07059	IM07059
IM07013	IM07014	IM07014		IM07014			IM07015	IM07014	IM07014	IM07014	IM07014
	9910100	9910100		9910100				9910100	9910100	9910100	9910100
	9909230	9909230		9909230				9909230	9909230	9909230	9909230
IM07032	IM07032	IM07032		IM07032			IM07031	IM07032	IM07032	IM07032	IM07032
	9924940	9924940		9924940			9924950	9924940	9924940	9924940	9924940
9907770	9907770	9907770		9907770	9920440	9920440	9922030	9907770	9907770	9907770	9907770
9935270	9935270	9935270		9935270	9935820	9935820	9935830	9935270	9935270	9935270	9935270
CT00726	CT00725	CT00725		CT00725			CT00727	CT00725	CT00725	CT00725	CT00725
9923030	9923030	9923030		9923030			9923150	9923030	9923030	9923030	9923030
9911060	9911060	9911060		9911060				9911060	9911060	9911060	9911060
9910020 9925130	9910020 9925130	9910020 9925130		9910020 9925130			9910020	9910020 9925130	9910020 9925130	9910020 9925130	9910020 9925130
			CP00219								
9931170	9931110	9931140		9931110			9914500	9931140	9931110	9931140	9931140
KT00096	KT00094	KT00095		KT00094			KT00080	KT00095	KT00094	KT00095	KT00095
9931370 KT00088	9931310 KT00109	9931340 KT00087		9931310 KT00109			9931250 KT00086	9931340 KT00087	9931310 KT00109	9931340 KT00087	9931340 KT00087
					KT00057	KT00057					
		9911090						9911090		9911090	9911090
KK01000 KK01002	KK01000 KK01002	KK01000 KK01002		KK01000 KK01002			KK01003 KK01009	KK01000 KK01002	KK01000 KK01002	KK01000 KK01002	KK01000 KK01002
	AA00780 AA00785 AA00786	AA00787 AA00788		AA00780 AA00785 AA00786	AA00787 AA00788			AA00780 AA00785 AA00786	AA00787 AA00788		
MA00001	MA00001	MA00001		MA00001			MA00002	MA00001	MA00001	MA00001	MA00001
	PL04055 PL04056	PL04055 PL04056		PL04055 PL04056			PL04058	PL04055 PL04056	PL04055 PL04056	PL04055 PL04056	PL04055 PL04056
9913300	9913300	9913300		9913300				9913300	9913300	9913300	9913300
	9909520			9909520				9909520			
RE00014		RE00014		RE00014				RE00014	RE00014	RE00014	RE00014
AA00767 RL00001	AA00767 RL00001	AA00767 RL00001		AA00767 RL00001				AA00767 RL00001	AA00767 RL00001	AA00767 RL00001	AA00767 RL00001
9906520	9908370	9908370		9908370			9910930	9908370	9908370	9908370	9908370

SCOOTER 50cc

SCOOTER 50cc



APRILIA	APRILIA	APRILIA	APRILIA
SCARABEO	SCARABEO	SCARABEO 2T	SCARABEO 2T EU2 MOTORE PIAGGIO
99-99	00-05	14-14	10-12
50cc 2T AC	50cc 2T AC	50cc 2T LC	50cc 2T AC
MY	MY	Motore Piaggio	Motore Piaggio
IM07059	IM07059		IM07060
IM07014	IM07014		IM07015
9910100	9910100		
9909230	9909230		
IM07032	IM07032		IM07031
9924940	9924940		9924950
9907770	9907770		
9935270	9935270	9935420	9935420
CT00725	CT00725		CT00727
9923030	9923030		9923150
9911060	9911060		
9910020 9925130	9910020 9925130		9910020
9931140	9931140		9914500
KT00095	KT00095		KT00080
9931340 KT00087	9931340 KT00087		9931250 KT00086
9911090	9911090		
KK01000 KK01002	KK01000 KK01002		KK01003 KK01009
MA00001	MA00001		MA00002
PL04055 PL04056	PL04055 PL04056	PL04058	PL04058
9913300	9913300		
RE00014	RE00014		RE00012
AA00767 RL00001	AA00767 RL00001		RL00040
9908370	9908370		9910930

IT	EN	FR
ALBERO MOTORE Con Cuscinetti e Paraoli	CRANKSHAFT with bearings and oil seals	VILEBREQUIN doté de Paliers et Joints d'huile
ALBERO MOTORE Senza Cuscinetti e Paraoli	CRANKSHAFT without bearings and oil seals	VILEBREQUIN sans Paliers et Joints d'huile
ACCENSIONE Fissa	IGNITION UNIT Fixed	ALLUMAGE Fixe
ACCENSIONE Variabile	IGNITION UNIT Variable	ALLUMAGE Variable
ACCENSIONE Digitale	DIGITAL IGNITION UNIT	ALLUMAGE Numérique
BIELLA	CONROD	BIELLE
CAMPANA FRIZIONE	CLUTCH HOUSING	CLOCHE EMBRAYAGE
CINGHIA DI TRASMISSIONE TOP PERFORMANCES	TRANSMISSION BELT TOP PERFORMANCES	COURROIE DE TRANSMISSION TOP PERFORMANCES
CINGHIA DI TRASMISSIONE Mitsuboshi	TRANSMISSION BELT Mitsuboshi	COURROIE DE TRANSMISSION Mitsuboshi
COLLETTORE ASPIRAZIONE	INLET MANIFOLD	COLLECTEUR ASPIRATION
CONVERTITORE DI COPPIA	TORQUE CONVERTER	CONVERTISSEUR DE COUPLE
FRIZIONE CENTRIFUGA Ø 105	CENTRIFUGAL CLUTCH Ø 105	EMBAYAGE CENTRIFUGE Ø 105
FRIZIONE CENTRIFUGA Ø 107	CENTRIFUGAL CLUTCH Ø 107	EMBAYAGE CENTRIFUGE Ø 107
GANASCE FRENO	BRAKE SHOES	MÂCHOIRES FREIN
GRUPPO TERMICO Ø Standard c/testa	CYLINDER KIT Ø standard with head	CYLINDRE COMPLET Ø Standard avec culasse
GRUPPO TERMICO Ø Standard s/testa	CYLINDER KIT Ø standard without head	CYLINDRE COMPLET Ø Standard sans culasse
GRUPPO TERMICO Ø Magg. c/testa	CYLINDER KIT BIG BORE with head	CYLINDRE COMPLET Ø Majoré avec culasse
GRUPPO TERMICO Ø Magg. s/testa	CYLINDER KIT BIG BORE without head	CYLINDRE COMPLET Ø Majoré sans culasse
GRUPPO TERMICO Modifica da AC a LC	CYLINDER KIT Conversion AC to LC	CYLINDRE COMPLET Modification de AC à LC
KIT CUSCINETTI DA BANCO	BEARINGS KIT	KIT PALIERS DE VILEBREQUIN
KIT REVISIONE POMPA ACQUA	WATER PUMP REPAIR KIT	KIT RÉVISION POMPE À EAU
MEMBRANA CARBURATORE	CARBURETOR DIAPHRAGM	MEMBRANE CARBURATEUR
MOTORINO D'AVVIAMENTO	STARTER ENGINE	DÉMARREUR ÉLECTRIQUE
PULEGGIA FISSA	VARIATOR SHEAVE FIXED	POULIE FIXE
RAPPORTI ALLUNGATI Primari	GEARS KIT Primary	RAPPORTS ALLONGÉS Primaires
RAPPORTI ALLUNGATI Secondari	GEARS KIT Secondary	RAPPORTS ALLONGÉS Secondaires
REGOLATORE DI TENSIONE	RECTIFIER	RÉGULATEUR DE TENSION
RUOTA LIBERA	STARTER CLUTCH	ROUE LIBRE
STATORE	STATOR	STATOR
VALVOLA LAMELLARE	REED VALVE	CLAPET À LAMELLES

APRILIA	APRILIA	APRILIA	APRILIA	APRILIA	APRILIA	APRILIA	APRILIA	APRILIA	APRILIA	APRILIA	APRILIA
SCARABEO 2T NET	SCARABEO 2T NET	SCARABEO 4T	SCARABEO 4T 4V	SCARABEO 4T 4V	SCARABEO 4T 4V NET	SCARABEO 4T 4V NET	SCARABEO 4T RESTYLING EU3	SCARABEO DITECH	SCARABEO QUATTRO	SCARABEO STREET	SCARABEO STREET 2T RESTYLING
09-09	10-10	02-06	10-12	14-14	09-09	10-10	06-09	01-04	09-09	05-06	06-09
50cc 2T AC	50cc 2T AC	50cc 4T AC	50cc 4T-4V AC	50cc 4T-4V AC	50cc 4T-4V AC	50cc 4T-4V AC	50cc 4T AC	50cc 2T-IE AC	50cc 4T-4V AC	50cc 2T AC	50cc 2T AC
Motore Piaggio	Motore Piaggio	Motore Piaggio	Motore Piaggio	Motore Piaggio	Motore Piaggio	Motore Piaggio	Motore Piaggio	Motore Aprilia	Motore Piaggio	Motore Piaggio	Motore Piaggio
IM07060	IM07060									IM07060	IM07060
IM07015	IM07015	IM07073	IM07073	IM07073	IM07073	IM07073	IM07073	IM07044	IM07073	IM07015	IM07015
IM07031	IM07031									IM07031	IM07031
9924950	9924950	9924950	9924950		9924950	9924950	9924950		9924950	9924950	9924950
								9920440			
9935420	9935420	9935420	9935420	9935420	9935420	9935420	9935420	9935820	9935420	9935420	9935420
CT00727	CT00727	CT00738					CT00737			CT00727	CT00727
9923150	9923150	9923150	9923150		9923150	9923150	9923150		9923150	9923150	9923150
9910020	9910020	9910020	9910020		9910020	9910020	9910020		9910020	9910020	9910020
9914500	9914500									9914500	9914500
KT00080	KT00080									KT00080	KT00080
9931250 KT00086	9931250 KT00086									9931250 KT00086	9931250 KT00086
		9925150 KT00133	9928300		9928300	9928300	9925150 KT00133		9928300		
KK01003 KK01009	KK01003 KK01009									KK01003 KK01009	KK01003 KK01009
MA00002	MA00002	MA00015	MA00015		MA00015	MA00015	MA00015		MA00015	MA00002	MA00002
PL04058	PL04058	PL04058	PL04058	PL04058	PL04058	PL04058	PL04058		PL04058	PL04058	PL04058
RE00012	RE00012 RE00014	RE00018					RE00018			RE00012	RE00012
RL00040	RL00040	RL00039	RL00039		RL00039	RL00039	RL00039		RL00039	RL00040	RL00040
		ST00004					ST00004				
9910930	9910930									9910930	9910930

SCOOTER 50cc

SCOOTER 50cc



APRILIA	APRILIA	APRILIA	APRILIA
SONIC	SONIC GP	SPORT CITY ONE 2T	SPORT CITY ONE 4T
98-07	98-08	08-11	08-10
50cc 2T AC	50cc 2T LC	50cc 2T AC	50cc 4T AC
CY	CA	Motore Piaggio	Motore Piaggio

IT	EN	FR					
ALBERO MOTORE Con Cuscinetti e Paraoli	CRANKSHAFT with bearings and oil seals	VILEBREQUIN doté de Paliers et Joints d'huile		IM07059	IM07059	IM07060	
ALBERO MOTORE Senza Cuscinetti e Paraoli	CRANKSHAFT without bearings and oil seals	VILEBREQUIN sans Paliers et Joints d'huile		IM07014	IM07014	IM07015	IM07073
ACCENSIONE Fissa	IGNITION UNIT Fixed	ALLUMAGE Fixe		9910100	9910100		
ACCENSIONE Variabile	IGNITION UNIT Variable	ALLUMAGE Variable		9909230	9909230		
ACCENSIONE Digitale	DIGITAL IGNITION UNIT	ALLUMAGE Numérique					
BIELLA	CONROD	BIELLE		IM07032	IM07032	IM07031	
CAMPANA FRIZIONE	CLUTCH HOUSING	CLOCHE EMBRAYAGE		9924940	9924940	9924950	9924950
CINGHIA DI TRASMISSIONE TOP PERFORMANCES	TRANSMISSION BELT TOP PERFORMANCES	COURROIE DE TRANSMISSION TOP PERFORMANCES		9907900	9907900		
CINGHIA DI TRASMISSIONE Mitsuboshi	TRANSMISSION BELT Mitsuboshi	COURROIE DE TRANSMISSION Mitsuboshi		9935340	9935340	9935420	9935420
COLLETTORE ASPIRAZIONE	INLET MANIFOLD	COLLECTEUR ASPIRATION		CT00725	CT00725	CT00727	CT00737
CONVERTITORE DI COPPIA	TORQUE CONVERTER	CONVERTISSEUR DE COUPLE		9923030	9923030	9923150	9923150
FRIZIONE CENTRIFUGA Ø 105	CENTRIFUGAL CLUTCH Ø 105	EMBAYAGE CENTRIFUGE Ø 105		9911060	9911060		
FRIZIONE CENTRIFUGA Ø 107	CENTRIFUGAL CLUTCH Ø 107	EMBAYAGE CENTRIFUGE Ø 107		9910020 9925130	9910020 9925130	9910020	9910020
GANASCE FRENO	BRAKE SHOES	MÂCHOIRES FREIN					
GRUPPO TERMICO Ø Standard c/testa	CYLINDER KIT Ø standard with head	CYLINDRE COMPLET Ø Standard avec culasse		9931140	9931110	9914500	
GRUPPO TERMICO Ø Standard s/testa	CYLINDER KIT Ø standard without head	CYLINDRE COMPLET Ø Standard sans culasse		KT00095	KT00094	KT00080	
GRUPPO TERMICO Ø Magg. c/testa	CYLINDER KIT BIG BORE with head	CYLINDRE COMPLET Ø Majoré avec culasse		9931340 KT00087	9931310 KT00109	9931250 KT00086	
GRUPPO TERMICO Ø Magg. s/testa	CYLINDER KIT BIG BORE without head	CYLINDRE COMPLET Ø Majoré sans culasse					9925150 KT00133
GRUPPO TERMICO Modifica da AC a LC	CYLINDER KIT Conversion AC to LC	CYLINDRE COMPLET Modification de AC à LC		9911090			
KIT CUSCINETTI DA BANCO	BEARINGS KIT	KIT PALIERS DE VILEBREQUIN		KK01000 KK01002	KK01000 KK01002	KK01003 KK01009	
KIT REVISIONE POMPA ACQUA	WATER PUMP REPAIR KIT	KIT RÉVISION POMPE À EAU			AA00780 AA00785 AA00786	AA00787 AA00788	
MEMBRANA CARBURATORE	CARBURETOR DIAPHRAGM	MEMBRANE CARBURATEUR					
MOTORINO D'AVVIAMENTO	STARTER ENGINE	DÉMARREUR ÉLECTRIQUE		MA00001	MA00001	MA00002	MA00015
PULEGGIA FISSA	VARIATOR SHEAVE FIXED	POULIE FIXE		PL04055 PL04056	PL04055 PL04056	PL04058	PL04058
RAPPORTI ALLUNGATI Primari	GEARS KIT Primary	RAPPORTS ALLONGÉS Primaires					
RAPPORTI ALLUNGATI Secondari	GEARS KIT Secondary	RAPPORTS ALLONGÉS Secondaires					
REGOLATORE DI TENSIONE	RECTIFIER	RÉGULATEUR DE TENSION		RE00014	RE00014	RE00012	
RUOTA LIBERA	STARTER CLUTCH	ROUE LIBRE		AA00767 RL00001	AA00767 RL00001	RL00040	RL00039
STATORE	STATOR	STATOR					ST00004
VALVOLA LAMELLARE	REED VALVE	CLAPET À LAMELLES		9908370	9908370	9910930	

APRILIA	APRILIA	APRILIA	APRILIA	APRILIA	APRILIA	APRILIA	APRILIA	APRILIA	APRILIA	APRILIA	APRILIA
SR (ORIZZONTALE)	SR (VERTICALE)	SR CARBURATORE	SR DITECH EU2	SR EUROPA	SR H2O CARBURATORE	SR H2O DITECH	SR LIQUID COOLED	SR MOTARD	SR MOTARD 4T 4V	SR R	SR R FACTORY CARBURATORE
94-96	93-93	14-14	02-04	94-94	00-03	00-04	94-96	12-14	13-14	04-09	10-14
50cc 2T AC	50cc 2T AC	50cc 2T LC	50cc 2T-IE LC	50cc	50cc 2T LC	50cc 2T-IE LC	50cc 2T LC	50cc 2T LC	50cc 4T-4V LC	50cc 2T LC	50cc 2T LC
MY	CW	Motore Piaggio	Motore Aprilia	A	Motore Aprilia	Motore Aprilia	MA	Motore Piaggio	Motore Piaggio	Motore Piaggio	Motore Piaggio
IM07059	IM07058						IM07059	IM07060		IM07060	IM07060
IM07014	IM07013		IM07044			IM07044	IM07014	IM07015	IM07073	IM07015	IM07015
9910100							9910100				
9909230							9909230				
IM07032	IM07032						IM07032	IM07031		IM07031	IM07031
9924940							9924940	9924950		9924950	9924950
9907770	9907770		9920440			9920440	9907770	9922030		9922030	9922030
9935270	9935270	9935830	9935820			9935820	9935270	9935420	9935420	9935830	9935830
CT00725	CT00726						CT00725	CT00727		CT00727	CT00727
9923030	9923030						9923030	9923150		9923150	9923150
9911060	9911060						9911060				
9910020 9925130	9910020 9925130						9910020 9925130	9910020		9910020	9910020
				CP00219							
9931140	9931170						9931110	9916580 KT00112		9916580 KT00112	9916580 KT00112
KT00095	KT00096						KT00094				
9931340 KT00087	9931370 KT00088						9931310 KT00109	9931270 KT00097		9931270 KT00097	9931270 KT00097
9911090											
KK01000 KK01002	KK01000 KK01002						KK01000 KK01002	KK01003 KK01009		KK01003 KK01009	KK01003 KK01009
		AA00796	AA00809		AA00809	AA00809	AA00780 AA00785 AA00786	AA00787 AA00788	AA00796	AA00796	AA00796
MA00001	MA00001						MA00001	MA00002		MA00015	MA00002
PL04055 PL04056		PL04058	PL04063		PL04063	PL04063	PL04055 PL04056	PL04058	PL04058	PL04058	PL04058
9913300	9913300						9913300				
9909520							9909520				
RE00014	RE00014						RE00014	RE00012		RE00012	RE00012
AA00767 RL00001	AA00767 RL00001						AA00767 RL00001	RL00040		RL00039	RL00040
9908370	9906520						9908370	9910930		9910930	9910930

SCOOTER 50cc



APRILIA	APRILIA	APRILIA	APRILIA
SR R FACTORY IE	SR R FACTORY IE	SR R FACTORY Motore Aprilia	SR RACING
10-12	10-14	05-05	97-99
50cc 2T-IE LC	50cc 2T LC	50cc 2T-IE LC	50cc 2T LC
Motore Piaggio	Motore Piaggio	Motore Aprilia	MA

IT	EN	FR
----	----	----

ALBERO MOTORE Con Cuscinetti e Paraoli	CRANKSHAFT with bearings and oil seals	VILEBREQUIN doté de Paliers et Joints d'huile			IM07060		IM07059
ALBERO MOTORE Senza Cuscinetti e Paraoli	CRANKSHAFT without bearings and oil seals	VILEBREQUIN sans Paliers et Joints d'huile			IM07015	IM07044	IM07014
ACCENSIONE Fissa	IGNITION UNIT Fixed	ALLUMAGE Fixe					9910100
ACCENSIONE Variabile	IGNITION UNIT Variable	ALLUMAGE Variable					9909230
ACCENSIONE Digitale	DIGITAL IGNITION UNIT	ALLUMAGE Numérique					
BIELLA	CONROD	BIELLE			IM07031		IM07032
CAMPANA FRIZIONE	CLUTCH HOUSING	CLOCHE EMBRAYAGE			9924950		9924940
CINGHIA DI TRASMISSIONE TOP PERFORMANCES	TRANSMISSION BELT TOP PERFORMANCES	COURROIE DE TRANSMISSION TOP PERFORMANCES			9922030	9920440	9907770
CINGHIA DI TRASMISSIONE Mitsuboshi	TRANSMISSION BELT Mitsuboshi	COURROIE DE TRANSMISSION Mitsuboshi			9935830	9935820	9935270
COLLETTORE ASPIRAZIONE	INLET MANIFOLD	COLLECTEUR ASPIRATION			CT00727		CT00725
CONVERTITORE DI COPPIA	TORQUE CONVERTER	CONVERTISSEUR DE COUPLE			9923150		9923030
FRIZIONE CENTRIFUGA Ø 105	CENTRIFUGAL CLUTCH Ø 105	EMBAYAGE CENTRIFUGE Ø 105					9911060
FRIZIONE CENTRIFUGA Ø 107	CENTRIFUGAL CLUTCH Ø 107	EMBAYAGE CENTRIFUGE Ø 107			9910020		9910020 9925130
GANASCE FRENO	BRAKE SHOES	MÂCHOIRES FREIN					
GRUPPO TERMICO Ø Standard c/testa	CYLINDER KIT Ø standard with head	CYLINDRE COMPLET Ø Standard avec culasse			9916580 KT00112		9931110
GRUPPO TERMICO Ø Standard s/testa	CYLINDER KIT Ø standard without head	CYLINDRE COMPLET Ø Standard sans culasse					KT00094
GRUPPO TERMICO Ø Magg. c/testa	CYLINDER KIT BIG BORE with head	CYLINDRE COMPLET Ø Majoré avec culasse			9931270 KT00097		9931310 KT00109
GRUPPO TERMICO Ø Magg. s/testa	CYLINDER KIT BIG BORE without head	CYLINDRE COMPLET Ø Majoré sans culasse					
GRUPPO TERMICO Modifica da AC a LC	CYLINDER KIT Conversion AC to LC	CYLINDRE COMPLET Modification de AC à LC					
KIT CUSCINETTI DA BANCO	BEARINGS KIT	KIT PALIERS DE VILEBREQUIN		KK01003 KK01009	KK01003 KK01009		KK01000 KK01002
KIT REVISIONE POMPA ACQUA	WATER PUMP REPAIR KIT	KIT RÉVISION POMPE À EAU		AA00796	AA00796	AA00809	AA00780 AA00785 AA00786 AA00787 AA00788
MEMBRANA CARBURATORE	CARBURETOR DIAPHRAGM	MEMBRANE CARBURATEUR					
MOTORINO D'AVVIAMENTO	STARTER ENGINE	DÉMARREUR ÉLECTRIQUE			MA00015		MA00001
PULEGGIA FISSA	VARIATOR SHEAVE FIXED	POULIE FIXE		PL04058	PL04058	PL04063	PL04055 PL04056
RAPPORTI ALLUNGATI Primari	GEARS KIT Primary	RAPPORTS ALLONGÉS Primaires					9913300
RAPPORTI ALLUNGATI Secondari	GEARS KIT Secondary	RAPPORTS ALLONGÉS Secondaires					9909520
REGOLATORE DI TENSIONE	RECTIFIER	RÉGULATEUR DE TENSION					RE00014
RUOTA LIBERA	STARTER CLUTCH	ROUE LIBRE			RL00039		AA00767 RL00001
STATORE	STATOR	STATOR					
VALVOLA LAMELLARE	REED VALVE	CLAPET À LAMELLES			9910930		9908370

APRILIA		APRILIA		APRILIA		APRILIA		APRILIA		ATALA		ATALA		ATALA		BAOTIAN		BAOTIAN		BAOTIAN		BAOTIAN	
SR RACING	SR STEALTH	SR STEALTH	SR STREET CARBURATORE	SR WWW	CAROSELLO	HACKER	VAMOS	ECO BIKE	REBEL	ROCHY	TANCO												
97-00	97-00	97-00	03-12	97-01	99-01	95-00	93-95	00-04	03-06	03-06	03-06												
50cc 2T LC	50cc 2T LC	50cc 2T LC	50cc 2T LC	50cc 2T AC	50cc 2T AC	50cc 2T AC	50cc 2T AC	50cc 4T AC	50cc 4T AC	50cc 4T AC	50cc 4T AC												
MA	MA	MA	Motore Piaggio	MY	MY	Motore Morini	Motore Morini	Tipo Kymco	Tipo Kymco	Tipo Kymco	Tipo Kymco												
	IM07059		IM07060	IM07059	IM07059																		
	IM07014		IM07015	IM07014	IM07014																		
	9910100			9910100																			
	9909230			9909230																			
	IM07032		IM07031	IM07032	IM07032																		
	9924940		9924950	9924940	9924940																		
	9907770		9922030	9907770	9907770																		
	9935270		9935830	9935270	9935270																		
	CT00725		CT00727	CT00725	CT00725																		
	9923030		9923150	9923030	9923030																		
	9911060			9911060	9911060																		
	9910020 9925130		9910020	9910020 9925130	9910020 9925130																		
	9931110		9916580 KT00112	9931140	9931140																		
	KT00094			KT00095	KT00095																		
	9931310 KT00109		9931270 KT00097	9931340 KT00087	9931340 KT00087																		
						KT00057	KT00057	9925140 KT00132	9925140 KT00132	9925140 KT00132	9925140 KT00132												
				9911090	9911090																		
	KK01000 KK01002		KK01003 KK01009	KK01000 KK01002	KK01000 KK01002																		
AA00780 AA00785	AA00786 AA00787	AA00780 AA00785 AA00786	AA00787 AA00788	AA00780 AA00785	AA00786 AA00787	AA00796																	
	MA00001		MA00002	MA00001	MA00001																		
PL04055 PL04056	PL04055 PL04056	PL04055 PL04056	PL04058	PL04055 PL04056	PL04055 PL04056																		
	9913300			9913300	9913300																		
	9909520																						
	RE00012 RE00014		RE00012	RE00014	RE00014																		
	AA00767 RL00001 RL00040		RL00040	AA00767 RL00001	AA00767 RL00001																		
	9908370		9910930	9908370	9908370																		

SCOOTER 50cc



BENELLI	BENELLI	BENELLI	BENELLI
491 GT	491 GT	491 NAKED	491 RACING
98-99	98-99	02-02	98-99
50cc 2T	50cc 2T AC	50cc 2T AC	50cc 2T LC
MY	MY	MY	MA

IT	EN	FR	
ALBERO MOTORE Con Cuscinetti e Paraoli	CRANKSHAFT with bearings and oil seals	VILEBREQUIN doté de Paliers et Joints d'huile	
ALBERO MOTORE Senza Cuscinetti e Paraoli	CRANKSHAFT without bearings and oil seals	VILEBREQUIN sans Paliers et Joints d'huile	
ACCENSIONE Fissa	IGNITION UNIT Fixed	ALLUMAGE Fixe	
ACCENSIONE Variabile	IGNITION UNIT Variable	ALLUMAGE Variable	
ACCENSIONE Digitale	DIGITAL IGNITION UNIT	ALLUMAGE Numérique	
BIELLA	CONROD	BIELLE	
CAMPANA FRIZIONE	CLUTCH HOUSING	CLOCHE EMBRAYAGE	
CINGHIA DI TRASMISSIONE TOP PERFORMANCES	TRANSMISSION BELT TOP PERFORMANCES	COURROIE DE TRANSMISSION TOP PERFORMANCES	
CINGHIA DI TRASMISSIONE Mitsuboshi	TRANSMISSION BELT Mitsuboshi	COURROIE DE TRANSMISSION Mitsuboshi	
COLLETTORE ASPIRAZIONE	INLET MANIFOLD	COLLECTEUR ASPIRATION	
CONVERTITORE DI COPPIA	TORQUE CONVERTER	CONVERTISSEUR DE COUPLE	
FRIZIONE CENTRIFUGA Ø 105	CENTRIFUGAL CLUTCH Ø 105	EMBAYAGE CENTRIFUGE Ø 105	
FRIZIONE CENTRIFUGA Ø 107	CENTRIFUGAL CLUTCH Ø 107	EMBAYAGE CENTRIFUGE Ø 107	
GANASCE FRENO	BRAKE SHOES	MÂCHOIRES FREIN	
GRUPPO TERMICO Ø Standard c/testa	CYLINDER KIT Ø standard with head	CYLINDRE COMPLET Ø Standard avec culasse	
GRUPPO TERMICO Ø Standard s/testa	CYLINDER KIT Ø standard without head	CYLINDRE COMPLET Ø Standard sans culasse	
GRUPPO TERMICO Ø Magg. c/testa	CYLINDER KIT BIG BORE with head	CYLINDRE COMPLET Ø Majoré avec culasse	
GRUPPO TERMICO Ø Magg. s/testa	CYLINDER KIT BIG BORE without head	CYLINDRE COMPLET Ø Majoré sans culasse	
GRUPPO TERMICO Modifica da AC a LC	CYLINDER KIT Conversion AC to LC	CYLINDRE COMPLET Modification de AC à LC	
KIT CUSCINETTI DA BANCO	BEARINGS KIT	KIT PALIERS DE VILEBREQUIN	
KIT REVISIONE POMPA ACQUA	WATER PUMP REPAIR KIT	KIT RÉVISION POMPE À EAU	
MEMBRANA CARBURATORE	CARBURETOR DIAPHRAGM	MEMBRANE CARBURATEUR	
MOTORINO D'AVVIAMENTO	STARTER ENGINE	DÉMARREUR ÉLECTRIQUE	
PULEGGIA FISSA	VARIATOR SHEAVE FIXED	POULIE FIXE	
RAPPORTI ALLUNGATI Primari	GEARS KIT Primary	RAPPORTS ALLONGÉS Primaires	
RAPPORTI ALLUNGATI Secondari	GEARS KIT Secondary	RAPPORTS ALLONGÉS Secondaires	
REGOLATORE DI TENSIONE	RECTIFIER	RÉGULATEUR DE TENSION	
RUOTA LIBERA	STARTER CLUTCH	ROUE LIBRE	
STATORE	STATOR	STATOR	
VALVOLA LAMELLARE	REED VALVE	CLAPET À LAMELLES	

BENELLI	BENELLI	BENELLI	BENELLI	BENELLI	BENELLI	BENELLI	BENELLI	BENELLI	BENELLI	BENELLI	BENELLI
491 RR	491 SP	491 SPORT	491 SPORT	491 ST	491 ST MORINI	K2	K2 LIQUID COOLED	NAKED MORINI	PEPE	PEPE	PEPE LX
99-01	99-99	98-99	98-99	99-01	03-03	98-01	98-01	03-04	99-01	10-10	03-04
50cc 2T LC	50cc 2T LC	50cc 2T	50cc 2T LC	50cc 2T AC	50cc 2T AC	50cc 2T AC	50cc 2T LC	50cc 2T AC	50cc 2T AC	50cc 2T AC	50cc 2T AC
MA	MA	MA	MA	MY	Motore Morini	MY	MA	Motore Morini	MY	Tipo Keeway	MY
IM07059	IM07059		IM07059	IM07059		IM07059	IM07059		IM07059		IM07059
IM07014	IM07014		IM07014	IM07014		IM07014	IM07014		IM07014		IM07014
9910100	9910100		9910100	9910100		9910100	9910100		9910100		9910100
9909230	9909230		9909230	9909230		9909230	9909230		9909230		9909230
IM07032	IM07032		IM07032	IM07032		IM07032	IM07032		IM07032		IM07032
9924940	9924940		9924940	9924940		9924940	9924940		9924940		9924940
9907770	9907770		9907770	9907770		9907770	9907770		9907770	9913280	9907770
9935270	9935270		9935270	9935270		9935270	9935270		9935270	9935800	9935270
CT00725	CT00725		CT00725	CT00725		CT00725	CT00725		CT00725		CT00725
9923030	9923030		9923030	9923030		9923030	9923030		9923030	9923030	9923030
9911060	9911060		9911060	9911060		9911060	9911060		9911060		9911060
9910020 9925130	9910020 9925130		9910020 9925130	9910020 9925130		9910020 9925130	9910020 9925130		9910020 9925130	9925130	9910020 9925130
		CP00219									
9931110	9931110		9931110	9931140		9931140	9931110		9931140	9925650	9931140
KT00094	KT00094		KT00094	KT00095		KT00095	KT00094		KT00095	KT00129	KT00095
9931310 KT00109	9931310 KT00109		9931310 KT00109	9931340 KT00087		9931340 KT00087	9931310 KT00109		9931340 KT00087	9924890 KT00128	9931340 KT00087
					KT00057			KT00057			
				9911090		9911090			9911090		9911090
KK01000 KK01002	KK01000 KK01002		KK01000 KK01002	KK01000 KK01002		KK01000 KK01002	KK01000 KK01002		KK01000 KK01002		KK01000 KK01002
AA00780 AA00785 AA00786	AA00787 AA00788	AA00780 AA00785 AA00786	AA00785 AA00788	AA00780 AA00785 AA00786	AA00787 AA00788	AA00780 AA00785 AA00786	AA00787 AA00788		AA00780 AA00785 AA00786	AA00787 AA00788	
MA00001	MA00001		MA00001	MA00001		MA00001	MA00001		MA00001		MA00001
PL04055 PL04056	PL04055 PL04056		PL04055 PL04056	PL04055 PL04056		PL04055 PL04056	PL04055 PL04056		PL04055 PL04056		PL04055 PL04056
9913300	9913300		9913300	9913300		9913300	9913300		9913300		9913300
9909520	9909520		9909520	9909520					9909520		9909520
AA00767 RL00001	AA00767 RL00001		AA00767 RL00001	AA00767 RL00001		AA00767 RL00001	AA00767 RL00001		AA00767 RL00001		AA00767 RL00001
9908370	9908370		9908370	9908370		9908370	9908370		9908370		9908370

SCOOTER 50cc

SCOOTER 50cc



BENELLI	BENELLI	BENELLI	BENELLI
PEPE LX	PEPE OLD	PEPE OLD	QUATTRONONEX
07-09	07-09	11-11	08-09
50cc 2T AC	50cc 2T AC	50cc 2T AC	50cc 2T AC
Tipo Keeway	Tipo Keeway	Tipo Keeway	Tipo Keeway

IT	EN	FR				
ALBERO MOTORE Con Cuscinetti e Paraoli	CRANKSHAFT with bearings and oil seals	VILEBREQUIN doté de Paliers et Joints d'huile				
ALBERO MOTORE Senza Cuscinetti e Paraoli	CRANKSHAFT without bearings and oil seals	VILEBREQUIN sans Paliers et Joints d'huile				
ACCENSIONE Fissa	IGNITION UNIT Fixed	ALLUMAGE Fixe				
ACCENSIONE Variabile	IGNITION UNIT Variable	ALLUMAGE Variable				
ACCENSIONE Digitale	DIGITAL IGNITION UNIT	ALLUMAGE Numérique				
BIELLA	CONROD	BIELLE				
CAMPANA FRIZIONE	CLUTCH HOUSING	CLOCHE EMBRAYAGE				
CINGHIA DI TRASMISSIONE TOP PERFORMANCES	TRANSMISSION BELT TOP PERFORMANCES	COURROIE DE TRANSMISSION TOP PERFORMANCES		9913280	9913280	9913280
CINGHIA DI TRASMISSIONE Mitsuboshi	TRANSMISSION BELT Mitsuboshi	COURROIE DE TRANSMISSION Mitsuboshi		9935800	9935800	9935800
COLLETTORE ASPIRAZIONE	INLET MANIFOLD	COLLECTEUR ASPIRATION				
CONVERTITORE DI COPPIA	TORQUE CONVERTER	CONVERTISSEUR DE COUPLE		9923030	9923030	9923030
FRIZIONE CENTRIFUGA Ø 105	CENTRIFUGAL CLUTCH Ø 105	EMBAYAGE CENTRIFUGE Ø 105				
FRIZIONE CENTRIFUGA Ø 107	CENTRIFUGAL CLUTCH Ø 107	EMBAYAGE CENTRIFUGE Ø 107		9925130	9925130	9925130
GANASCE FRENO	BRAKE SHOES	MÂCHOIRES FREIN				
GRUPPO TERMICO Ø Standard c/testa	CYLINDER KIT Ø standard with head	CYLINDRE COMPLET Ø Standard avec culasse		9925650	9925650	9925650
GRUPPO TERMICO Ø Standard s/testa	CYLINDER KIT Ø standard without head	CYLINDRE COMPLET Ø Standard sans culasse		KT00129	KT00129	KT00129
GRUPPO TERMICO Ø Magg. c/testa	CYLINDER KIT BIG BORE with head	CYLINDRE COMPLET Ø Majoré avec culasse		9924890 KT00128	9924890 KT00128	9924890 KT00128
GRUPPO TERMICO Ø Magg. s/testa	CYLINDER KIT BIG BORE without head	CYLINDRE COMPLET Ø Majoré sans culasse				
GRUPPO TERMICO Modifica da AC a LC	CYLINDER KIT Conversion AC to LC	CYLINDRE COMPLET Modification de AC à LC				
KIT CUSCINETTI DA BANCO	BEARINGS KIT	KIT PALIERS DE VILEBREQUIN				
KIT REVISIONE POMPA ACQUA	WATER PUMP REPAIR KIT	KIT RÉVISION POMPE À EAU				
MEMBRANA CARBURATORE	CARBURETOR DIAPHRAGM	MEMBRANE CARBURATEUR				
MOTORINO D'AVVIAMENTO	STARTER ENGINE	DÉMARREUR ÉLECTRIQUE				
PULEGGIA FISSA	VARIATOR SHEAVE FIXED	POULIE FIXE				
RAPPORTI ALLUNGATI Primari	GEARS KIT Primary	RAPPORTS ALLONGÉS Primaires				
RAPPORTI ALLUNGATI Secondari	GEARS KIT Secondary	RAPPORTS ALLONGÉS Secondaires				
REGOLATORE DI TENSIONE	RECTIFIER	RÉGULATEUR DE TENSION				
RUOTA LIBERA	STARTER CLUTCH	ROUE LIBRE				
STATORE	STATOR	STATOR				
VALVOLA LAMELLARE	REED VALVE	CLAPET À LAMELLES				

BENELLI	BENELLI	BETA	BETA	BETA	BETA	BETA	BETA	BETA	BSV	BSV	CPI
QUATTRONONEX	QUATTRONONEX	ARK	ARK LC	CHRONO	EIKON	QUADRA	QUADRA	TEMPO	DIO GP	DIO SP	HUSSAR
10-10	11-11	96-08	96-08	96-96	99-03	95-95	99-01	95-95	94-96	94-96	03-03
50cc 2T AC	50cc 2T AC	50cc 2T AC	50cc 2T LC	50cc 2T AC	50cc 2T LC	50cc 2T AC	50cc 2T AC	50cc 2T AC	50cc 2T AC	50cc 2T AC	50cc 2T AC
Tipo Keeway	Tipo Keeway	MY	MA	MY	MA	MY	MY	MY	Motore Honda	Motore Honda	Tipo Keeway
		IM07059	IM07059	IM07059	IM07059	IM07059	IM07059	IM07059			
		IM07014	IM07014	IM07014	IM07014	IM07014	IM07014	IM07014			
					9910100		9910100				
							9909230				
		IM07032	IM07032	IM07032	IM07032	IM07032	IM07032	IM07032			
		9924940	9924940	9924940	9924940	9924940	9924940	9924940			
9913280	9913280	9907770	9907770	9907770	9907770	9907770	9907770	9907770			9913280
9935800	9935800	9935270	9935270	9935270	9935270	9935270	9935270	9935270			9935800
		CT00725	CT00725	CT00725	CT00725	CT00725	CT00725	CT00725			
9923030	9923030	9923030	9923030	9923030	9923030	9923030	9923030	9923030			9923030
		9911060	9911060	9911060	9911060	9911060	9911060	9911060			
9925130	9925130	9910020 9925130	9910020 9925130	9910020 9925130	9910020 9925130	9910020 9925130	9910020 9925130	9910020 9925130	9910020	9910020	9925130
9925650	9925650	9931140	9931110	9931140	9931110	9931140	9931140	9931140			9925650
KT00129	KT00129	KT00095	KT00094	KT00095	KT00094	KT00095	KT00095	KT00095			KT00129
9924890 KT00128	9924890 KT00128	9931340 KT00087	9931310 KT00109	9931340 KT00087	9931310 KT00109	9931340 KT00087	9931340 KT00087	9931340 KT00087			9924890 KT00128
		9911090		9911090		9911090	9911090	9911090			
		KK01000 KK01002	KK01000 KK01002	KK01000 KK01002	KK01000 KK01002	KK01000 KK01002	KK01000 KK01002	KK01000 KK01002			
		AA00780 AA00785 AA00786	AA00787 AA00788		AA00780 AA00785 AA00786	AA00787 AA00788					
		MA00001	MA00001	MA00001	MA00001	MA00001	MA00001	MA00001			
		PL04055 PL04056	PL04055 PL04056	PL04055 PL04056	PL04055 PL04056	PL04055 PL04056	PL04055 PL04056	PL04055 PL04056			
		9913300	9913300	9913300	9913300	9913300	9913300	9913300			
			9909520		9909520						
		AA00767 RL00001	AA00767 RL00001	AA00767 RL00001	AA00767 RL00001	AA00767 RL00001	AA00767 RL00001	AA00767 RL00001			
		SD00002	SD00002	SD00002		SD00002		SD00002			
		9908370	9908370	9908370	9908370	9908370	9908370	9908370	9912550	9912550	

SCOOTER 50cc



CPI	CPI	DERBI	DERBI
OLIVER	POP CORN	ATLANTIS 2T	ATLANTIS 2T EU2
03-03	03-03	10-10	07-09
50cc 2T AC	50cc 2T AC	50cc 2T AC	50cc 2T AC
Tipo Keeway	Tipo Keeway	Motore Piaggio	Motore Piaggio

IT	EN	FR					
ALBERO MOTORE Con Cuscinetti e Paraoli	CRANKSHAFT with bearings and oil seals	VILEBREQUIN doté de Paliers et Joints d'huile				IM07060	IM07060
ALBERO MOTORE Senza Cuscinetti e Paraoli	CRANKSHAFT without bearings and oil seals	VILEBREQUIN sans Paliers et Joints d'huile				IM07015	IM07015
ACCENSIONE Fissa	IGNITION UNIT Fixed	ALLUMAGE Fixe					
ACCENSIONE Variabile	IGNITION UNIT Variable	ALLUMAGE Variable					
ACCENSIONE Digitale	DIGITAL IGNITION UNIT	ALLUMAGE Numérique					
BIELLA	CONROD	BIELLE				IM07031	IM07031
CAMPANA FRIZIONE	CLUTCH HOUSING	CLOCHE EMBRAYAGE				9924950	9924950
CINGHIA DI TRASMISSIONE TOP PERFORMANCES	TRANSMISSION BELT TOP PERFORMANCES	COURROIE DE TRANSMISSION TOP PERFORMANCES		9913280	9913280	9922030	9922030
CINGHIA DI TRASMISSIONE Mitsuboshi	TRANSMISSION BELT Mitsuboshi	COURROIE DE TRANSMISSION Mitsuboshi		9935800	9935800	9935830	9935830
COLLETTORE ASPIRAZIONE	INLET MANIFOLD	COLLECTEUR ASPIRATION				CT00727	CT00727
CONVERTITORE DI COPPIA	TORQUE CONVERTER	CONVERTISSEUR DE COUPLE		9923030	9923030	9923150	9923150
FRIZIONE CENTRIFUGA Ø 105	CENTRIFUGAL CLUTCH Ø 105	EMBAYAGE CENTRIFUGE Ø 105					
FRIZIONE CENTRIFUGA Ø 107	CENTRIFUGAL CLUTCH Ø 107	EMBAYAGE CENTRIFUGE Ø 107		9925130	9925130	9910020	9910020
GANASCE FRENO	BRAKE SHOES	MÂCHOIRES FREIN					
GRUPPO TERMICO Ø Standard c/testa	CYLINDER KIT Ø standard with head	CYLINDRE COMPLET Ø Standard avec culasse		9925650	9925650	9914500	9914500
GRUPPO TERMICO Ø Standard s/testa	CYLINDER KIT Ø standard without head	CYLINDRE COMPLET Ø Standard sans culasse		KT00129	KT00129	KT00080	KT00080
GRUPPO TERMICO Ø Magg. c/testa	CYLINDER KIT BIG BORE with head	CYLINDRE COMPLET Ø Majoré avec culasse		9924890 KT00128	9924890 KT00128	9931250 KT00086	9931250 KT00086
GRUPPO TERMICO Ø Magg. s/testa	CYLINDER KIT BIG BORE without head	CYLINDRE COMPLET Ø Majoré sans culasse					
GRUPPO TERMICO Modifica da AC a LC	CYLINDER KIT Conversion AC to LC	CYLINDRE COMPLET Modification de AC à LC					
KIT CUSCINETTI DA BANCO	BEARINGS KIT	KIT PALIERS DE VILEBREQUIN				KK01003 KK01009	KK01003 KK01009
KIT REVISIONE POMPA ACQUA	WATER PUMP REPAIR KIT	KIT RÉVISION POMPE À EAU					
MEMBRANA CARBURATORE	CARBURETOR DIAPHRAGM	MEMBRANE CARBURATEUR					
MOTORINO D'AVVIAMENTO	STARTER ENGINE	DÉMARREUR ÉLECTRIQUE				MA00002	MA00002
PULEGGIA FISSA	VARIATOR SHEAVE FIXED	POULIE FIXE				PL04058	PL04058
RAPPORTI ALLUNGATI Primari	GEARS KIT Primary	RAPPORTS ALLONGÉS Primaires					
RAPPORTI ALLUNGATI Secondari	GEARS KIT Secondary	RAPPORTS ALLONGÉS Secondaires					
REGOLATORE DI TENSIONE	RECTIFIER	RÉGULATEUR DE TENSION					
RUOTA LIBERA	STARTER CLUTCH	ROUE LIBRE				RL00040	RL00040
STATORE	STATOR	STATOR					
VALVOLA LAMELLARE	REED VALVE	CLAPET À LAMELLES				9910930	9910930

DERBI	DERBI	DERBI	DERBI	DERBI	DERBI	DERBI	DERBI	DERBI	DERBI	DERBI	DERBI
ATLANTIS 4T	ATLANTIS 02 BULLET	ATLANTIS 02 CITY	ATLANTIS 02 RED BULLET	ATLANTIS 02 TWO CHIC	BOULEVARD 2T	BOULEVARD 4T EU2 25KM/H	GP1	GP1	GP1 EU 2	GP1 OPEN EU2	GP1 RACE EU2
04-06	03-05	04-06	03-03	05-05	09-14	09-09	01-02	03-03	05-05	06-09	05-07
50cc 4T AC	50cc 2T AC	50cc 2T AC	50cc 2T AC	50cc 2T AC	50cc 2T AC	50cc 4T AC	50cc 2T LC	50cc 2T LC	50cc 2T LC	50cc 2T LC	50cc 2T LC
Motore Piaggio	Motore Piaggio	Motore Piaggio	Motore Piaggio	Motore Piaggio	Motore Piaggio	Motore Piaggio	Motore Piaggio	Motore Piaggio	Motore Piaggio	Motore Piaggio	Motore Piaggio
	IM07060	IM07060	IM07060	IM07060	IM07060		IM07060	IM07060	IM07060	IM07060	IM07060
IM07073	IM07015	IM07015	IM07015	IM07015	IM07015	IM07073	IM07015	IM07015	IM07015	IM07015	IM07015
	IM07031	IM07031	IM07031	IM07031	IM07031		IM07031	IM07031	IM07031	IM07031	IM07031
	9924950	9924950	9924950	9924950	9924950		9924950	9924950	9924950	9924950	9924950
	9922030	9922030	9922030	9922030			9922030	9922030	9922030	9922030	9922030
9935480	9935830	9935830	9935830	9935830	9935420	9935480	9935830	9935830	9935830	9935830	9935830
CT00738	CT00727	CT00727	CT00727	CT00727	CT00727	CT00737	CT00727	CT00727	CT00727	CT00727	CT00727
	9923150	9923150	9923150	9923150	9923150		9923150	9923150	9923150	9923150	9923150
	9910020	9910020	9910020	9910020	9910020		9910020	9910020	9910020	9910020	9910020
	9914500	9914500	9914500	9914500	9914500		9916580 KT00112	9916580 KT00112	9916580 KT00112	9916580 KT00112	9916580 KT00112
	KT00080	KT00080	KT00080	KT00080	KT00080						
	9931250 KT00086	9931250 KT00086	9931250 KT00086	9931250 KT00086	9931250 KT00086		9931270 KT00097	9931270 KT00097	9931270 KT00097	9931270 KT00097	9931270 KT00097
9925150 KT00133						9925150 KT00133					
	KK01003 KK01009	KK01003 KK01009	KK01003 KK01009	KK01003 KK01009	KK01003 KK01009		KK01003 KK01009	KK01003 KK01009	KK01003 KK01009	KK01003 KK01009	KK01003 KK01009
							AA00796	AA00796	AA00796	AA00796	AA00796
MA00015	MA00002	MA00002	MA00002	MA00002	MA00002	MA00015	MA00002	MA00002	MA00002	MA00002	MA00002
PL04058	PL04058	PL04058	PL04058	PL04058	PL04058	PL04058	PL04058	PL04058	PL04058	PL04058	PL04058
RE00018						RE00012	RE00018	RE00012	RE00012	RE00012	RE00012
RL00039	RL00040	RL00040	RL00040	RL00040	RL00040	RL00039	RL00040	RL00040	RL00040	RL00040	RL00040
ST00004						ST00004					
	9910930	9910930	9910930	9910930	9910930		9910930	9910930	9910930	9910930	9910930



DERBI	DERBI	EXPLORER	GARELLI
SONAR 2T	VARIANT SPORT 2T	CRACKER	CAPRI LX
09-09	12-12	03-03	06-07
50cc 2T AC	50cc 2T AC	50cc 2T AC	50cc 4T AC
Motore Piaggio	Motore Piaggio	Tipo Keeway	

IT	EN	FR				
ALBERO MOTORE Con Cuscinetti e Paraoli	CRANKSHAFT with bearings and oil seals	VILEBREQUIN doté de Paliers et Joints d'huile		IM07060		
ALBERO MOTORE Senza Cuscinetti e Paraoli	CRANKSHAFT without bearings and oil seals	VILEBREQUIN sans Paliers et Joints d'huile		IM07015		
ACCENSIONE Fissa	IGNITION UNIT Fixed	ALLUMAGE Fixe				
ACCENSIONE Variabile	IGNITION UNIT Variable	ALLUMAGE Variable				
ACCENSIONE Digitale	DIGITAL IGNITION UNIT	ALLUMAGE Numérique				
BIELLA	CONROD	BIELLE		IM07031		
CAMPANA FRIZIONE	CLUTCH HOUSING	CLOCHE EMBRAYAGE		9924950		
CINGHIA DI TRASMISSIONE TOP PERFORMANCES	TRANSMISSION BELT TOP PERFORMANCES	COURROIE DE TRANSMISSION TOP PERFORMANCES				9913280
CINGHIA DI TRASMISSIONE Mitsuboshi	TRANSMISSION BELT Mitsuboshi	COURROIE DE TRANSMISSION Mitsuboshi		9935420	9935420	9935800
COLLETTORE ASPIRAZIONE	INLET MANIFOLD	COLLECTEUR ASPIRATION		CT00727		
CONVERTITORE DI COPPIA	TORQUE CONVERTER	CONVERTISSEUR DE COUPLE		9923150		9923030
FRIZIONE CENTRIFUGA Ø 105	CENTRIFUGAL CLUTCH Ø 105	EMBAYAGE CENTRIFUGE Ø 105				
FRIZIONE CENTRIFUGA Ø 107	CENTRIFUGAL CLUTCH Ø 107	EMBAYAGE CENTRIFUGE Ø 107		9910020		
GANASCE FRENO	BRAKE SHOES	MÂCHOIRES FREIN				
GRUPPO TERMICO Ø Standard c/testa	CYLINDER KIT Ø standard with head	CYLINDRE COMPLET Ø Standard avec culasse		9914500		9925650
GRUPPO TERMICO Ø Standard s/testa	CYLINDER KIT Ø standard without head	CYLINDRE COMPLET Ø Standard sans culasse		KT00080		KT00129
GRUPPO TERMICO Ø Magg. c/testa	CYLINDER KIT BIG BORE with head	CYLINDRE COMPLET Ø Majoré avec culasse		9931250 KT00086		9924890 KT00128
GRUPPO TERMICO Ø Magg. s/testa	CYLINDER KIT BIG BORE without head	CYLINDRE COMPLET Ø Majoré sans culasse				9925140 KT00132
GRUPPO TERMICO Modifica da AC a LC	CYLINDER KIT Conversion AC to LC	CYLINDRE COMPLET Modification de AC à LC				
KIT CUSCINETTI DA BANCO	BEARINGS KIT	KIT PALIERS DE VILEBREQUIN		KK01003 KK01009		
KIT REVISIONE POMPA ACQUA	WATER PUMP REPAIR KIT	KIT RÉVISION POMPE À EAU				
MEMBRANA CARBURATORE	CARBURETOR DIAPHRAGM	MEMBRANE CARBURATEUR				
MOTORINO D'AVVIAMENTO	STARTER ENGINE	DÉMARREUR ÉLECTRIQUE		MA00002		
PULEGGIA FISSA	VARIATOR SHEAVE FIXED	POULIE FIXE		PL04058	PL04058	
RAPPORTI ALLUNGATI Primari	GEARS KIT Primary	RAPPORTS ALLONGÉS Primaires				
RAPPORTI ALLUNGATI Secondari	GEARS KIT Secondary	RAPPORTS ALLONGÉS Secondaires				
REGOLATORE DI TENSIONE	RECTIFIER	RÉGULATEUR DE TENSION		RE00012		
RUOTA LIBERA	STARTER CLUTCH	ROUE LIBRE		RL00040		
STATORE	STATOR	STATOR				
VALVOLA LAMELLARE	REED VALVE	CLAPET À LAMELLES		9910930		

GARELLI	GARELLI	GARELLI	GARELLI	GARELLI	GARELLI	GILERA	GILERA	GILERA	GILERA	GILERA	GILERA
CAPRI LX	CICLONE	CICLONE	FLEXI	NEW VIP	TIESSE 2T	DNA	DNA	DNA GP EXPERIENCE	EASY MOVING	ICE	RUNNER
08-08	06-07	08-08	08-11	06-07	08-08	00-02	05-07	03-04	95-96	01-05	97-00
50cc 4T AC	50cc 4T AC	50cc 4T AC	50cc 4T AC	50cc 4T AC	50cc 2T AC	50cc 2T LC	50cc 2T LC	50cc 2T LC	50cc 2T AC	50cc 2T AC	50cc 2T LC
Tipo Kymco		Tipo Kymco	Tipo Kymco			Motore Piaggio	Motore Piaggio	Motore Piaggio	Motore Piaggio	Motore Piaggio	Motore Piaggio
						IM07060	IM07060	IM07060	IM07060	IM07060	IM07060
						IM07015	IM07015	IM07015	IM07015	IM07015	IM07015
						9924870		9924870	9924870	9924870	9924870
						9924880		9924880	9924880	9924880	9924880
						IM07031	IM07031	IM07031	IM07031	IM07031	IM07031
						9924950	9924950	9924950	9924950	9924950	9924950
					9913280				9913350	9922030	9922030
					9935800	9935420	9935420	9935420	9935810	9935830	9935830
						CT00727	CT00727	CT00727	CT00727	CT00727	CT00727
									9923150	9923150	9923150
						9910020	9910020	9910020	9910020	9910020	9910020
						9916580 KT00112	9916580 KT00112	9916580 KT00112	9914500	9914500	9916580 KT00112
									KT00080	KT00080	
						9931270 KT00097	9931270 KT00097	9931270 KT00097	9931250 KT00086	9931250 KT00086	9931270 KT00097
9925140 KT00132	9925140 KT00132	9925140 KT00132	9925140 KT00132	9925140 KT00132							
						KK01003 KK01009	KK01003 KK01009	KK01003 KK01009	KK01003 KK01009	KK01003 KK01009	KK01003 KK01009
						AA00796	AA00796	AA00796			AA00796
						MA00002	MA00002	MA00002	MA00002	MA00002	MA00002
						PL04058	PL04058	PL04058	PL04058	PL04058	PL04058
						RE00012	RE00012	RE00012		RE00012	RE00012
						RL00040	RL00040	RL00040	RL00040	RL00040	RL00040
						9910930	9910930	9910930	9910930	9910930	9910930

SCOOTER 50cc

SCOOTER 50cc



GILERA	GILERA	GILERA	GILERA
RUNNER POGGIALI	RUNNER PURE JET	RUNNER PURE JET	RUNNER PURE JET
02-02	02-04	05-06	07-07
50cc 2T LC	50cc 2T-IE LC	50cc 2T-IE LC	50cc 2T-IE LC
Motore Piaggio	Motore Piaggio	Motore Piaggio	Motore Piaggio

IT	EN	FR
----	----	----

ALBERO MOTORE Con Cuscinetti e Paraoli	CRANKSHAFT with bearings and oil seals	VILEBREQUIN doté de Paliers et Joints d'huile		IM07060			
ALBERO MOTORE Senza Cuscinetti e Paraoli	CRANKSHAFT without bearings and oil seals	VILEBREQUIN sans Paliers et Joints d'huile		IM07015	IM07064	IM07064	IM07064
ACCENSIONE Fissa	IGNITION UNIT Fixed	ALLUMAGE Fixe		9924870			
ACCENSIONE Variabile	IGNITION UNIT Variable	ALLUMAGE Variable		9924880			
ACCENSIONE Digitale	DIGITAL IGNITION UNIT	ALLUMAGE Numérique					
BIELLA	CONROD	BIELLE		IM07031			
CAMPANA FRIZIONE	CLUTCH HOUSING	CLOCHE EMBRAYAGE		9924950	9924950	9924950	9924950
CINGHIA DI TRASMISSIONE TOP PERFORMANCES	TRANSMISSION BELT TOP PERFORMANCES	COURROIE DE TRANSMISSION TOP PERFORMANCES			9922030		
CINGHIA DI TRASMISSIONE Mitsuboshi	TRANSMISSION BELT Mitsuboshi	COURROIE DE TRANSMISSION Mitsuboshi		9935830	9935830		
COLLETTORE ASPIRAZIONE	INLET MANIFOLD	COLLECTEUR ASPIRATION		CT00727			
CONVERTITORE DI COPPIA	TORQUE CONVERTER	CONVERTISSEUR DE COUPLE			9923150	9923150	9923150
FRIZIONE CENTRIFUGA Ø 105	CENTRIFUGAL CLUTCH Ø 105	EMBAYAGE CENTRIFUGE Ø 105					
FRIZIONE CENTRIFUGA Ø 107	CENTRIFUGAL CLUTCH Ø 107	EMBAYAGE CENTRIFUGE Ø 107		9910020			
GANASCE FRENO	BRAKE SHOES	MÂCHOIRES FREIN					
GRUPPO TERMICO Ø Standard c/testa	CYLINDER KIT Ø standard with head	CYLINDRE COMPLET Ø Standard avec culasse		9916580	9916580	9916580	9916580
GRUPPO TERMICO Ø Standard s/testa	CYLINDER KIT Ø standard without head	CYLINDRE COMPLET Ø Standard sans culasse		KT00112			
GRUPPO TERMICO Ø Magg. c/testa	CYLINDER KIT BIG BORE with head	CYLINDRE COMPLET Ø Majoré avec culasse		9931270	9931270	9931270	9931270
GRUPPO TERMICO Ø Magg. s/testa	CYLINDER KIT BIG BORE without head	CYLINDRE COMPLET Ø Majoré sans culasse		KT00097			
GRUPPO TERMICO Modifica da AC a LC	CYLINDER KIT Conversion AC to LC	CYLINDRE COMPLET Modification de AC à LC					
KIT CUSCINETTI DA BANCO	BEARINGS KIT	KIT PALIERS DE VILEBREQUIN		KK01003 KK01009	KK01003 KK01009	KK01003 KK01009	KK01003 KK01009
KIT REVISIONE POMPA ACQUA	WATER PUMP REPAIR KIT	KIT RÉVISION POMPE À EAU		AA00796	AA00796	AA00796	AA00796
MEMBRANA CARBURATORE	CARBURETOR DIAPHRAGM	MEMBRANE CARBURATEUR					
MOTORINO D'AVVIAMENTO	STARTER ENGINE	DÉMARREUR ÉLECTRIQUE		MA00002	MA00015	MA00015	MA00015
PULEGGIA FISSA	VARIATOR SHEAVE FIXED	POULIE FIXE		PL04058	PL04058	PL04058	PL04058
RAPPORTI ALLUNGATI Primari	GEARS KIT Primary	RAPPORTS ALLONGÉS Primaires					
RAPPORTI ALLUNGATI Secondari	GEARS KIT Secondary	RAPPORTS ALLONGÉS Secondaires					
REGOLATORE DI TENSIONE	RECTIFIER	RÉGULATEUR DE TENSION		RE00012			
RUOTA LIBERA	STARTER CLUTCH	ROUE LIBRE		RL00040	RL00039	RL00039	RL00039
STATORE	STATOR	STATOR					
VALVOLA LAMELLARE	REED VALVE	CLAPET À LAMELLES		9910930	9910930	9910930	9910930

GILERA	GILERA	GILERA	GILERA	GILERA	GILERA	GILERA	GILERA	GILERA	GILERA	GILERA	GILERA
RUNNER PURE JET	RUNNER PURE JET ST	RUNNER SP	RUNNER SP	RUNNER SP ST & SIMONCELLI	STALKER	STALKER	STALKER	STALKER	STALKER NAKED	STALKER SPECIAL EDITION	STORM
10-11	08-08	02-04	07-07	08-09	97-04	05-06	07-08	09-11	08-08	07-08	94-95
50cc 2T-IE LC	50cc 2T-IE LC	50cc 2T LC	50cc 2T LC	50cc 2T LC	50cc 2T AC	50cc 2T AC	50cc 2T AC	50cc 2T AC	50cc 2T AC	50cc 2T AC	50cc 2T AC
Motore Piaggio	Motore Piaggio	Motore Piaggio	Motore Piaggio	Motore Piaggio	Motore Piaggio	Motore Piaggio	Motore Piaggio	Motore Piaggio	Motore Piaggio	Motore Piaggio	Motore Piaggio
		IM07060	IM07060	IM07060	IM07060	IM07060	IM07060	IM07060	IM07060	IM07060	IM07060
IM07064	IM07064	IM07015	IM07015	IM07015	IM07015	IM07015	IM07015	IM07015	IM07015	IM07015	IM07015
		9924870			9924870						9924870
		9924880			9924880						9924880
		IM07031	IM07031	IM07031	IM07031	IM07031	IM07031	IM07031	IM07031	IM07031	IM07031
9924950	9924950	9924950	9924950	9924950	9924950	9924950	9924950	9924950	9924950	9924950	9924950
		9922030			9922030	9922030	9922030	9922030	9922030	9922030	9913280
		9935830	9935830	9935830	9935830	9935830	9935830	9935830	9935830	9935830	9935800
		CT00727	CT00727	CT00727	CT00727	CT00727	CT00727	CT00727	CT00727	CT00727	CT00727
9923150		9923150			9923150	9923150	9923150	9923150	9923150	9923150	9923150
		9910020	9910020	9910020	9910020	9910020	9910020	9910020	9910020	9910020	9910020
9916580	9916580	9916580 KT00112	9916580 KT00112	9916580 KT00112	9914500	9914500	9914500	9914500	9914500	9914500	9914500
					KT00080	KT00080	KT00080	KT00080	KT00080	KT00080	KT00080
9931270	9931270	9931270 KT00097	9931270 KT00097	9931270 KT00097	9931250 KT00086	9931250 KT00086	9931250 KT00086	9931250 KT00086	9931250 KT00086	9931250 KT00086	9931250 KT00086
KK01003 KK01009	KK01003 KK01009	KK01003 KK01009	KK01003 KK01009	KK01003 KK01009	KK01003 KK01009	KK01003 KK01009	KK01003 KK01009	KK01003 KK01009	KK01003 KK01009	KK01003 KK01009	KK01003 KK01009
AA00796	AA00796	AA00796	AA00796	AA00796							
MA00015	MA00015	MA00002	MA00002	MA00002	MA00002	MA00002	MA00002	MA00002	MA00002	MA00002	MA00002
PL04058	PL04058	PL04058	PL04058	PL04058	PL04058	PL04058	PL04058	PL04058	PL04058	PL04058	PL04058
		RE00012	RE00012	RE00012	RE00012	RE00012	RE00012	RE00012	RE00012	RE00012	
RL00039		RL00040	RL00040	RL00040	RL00040	RL00040	RL00040	RL00040	RL00040	RL00040	RL00040
9910930	9910930	9910930	9910930	9910930	9910930	9910930	9910930	9910930	9910930	9910930	9910930

SCOOTER 50cc



GILERA	GILERA	GILERA	GILERA
STORM EURO 2	TYPHOON	TYPHOON	TYPHOON X
07-07	94-97	96-00	98-99
50cc 2T AC	50cc 2T AC	50cc	50cc 2T AC
Motore Piaggio	Motore Piaggio	A	Motore Piaggio

IT	EN	FR				
ALBERO MOTORE Con Cuscinetti e Paraoli	CRANKSHAFT with bearings and oil seals	VILEBREQUIN doté de Paliers et Joints d'huile		IM07060	IM07060	IM07060
ALBERO MOTORE Senza Cuscinetti e Paraoli	CRANKSHAFT without bearings and oil seals	VILEBREQUIN sans Paliers et Joints d'huile		IM07015	IM07015	IM07015
ACCENSIONE Fissa	IGNITION UNIT Fixed	ALLUMAGE Fixe			9924870	9924870
ACCENSIONE Variabile	IGNITION UNIT Variable	ALLUMAGE Variable			9924880	9924880
ACCENSIONE Digitale	DIGITAL IGNITION UNIT	ALLUMAGE Numérique				
BIELLA	CONROD	BIELLE		IM07031	IM07031	IM07031
CAMPANA FRIZIONE	CLUTCH HOUSING	CLOCHE EMBRAYAGE		9924950	9924950	9924950
CINGHIA DI TRASMISSIONE TOP PERFORMANCES	TRANSMISSION BELT TOP PERFORMANCES	COURROIE DE TRANSMISSION TOP PERFORMANCES		9922030	9913280	9913280
CINGHIA DI TRASMISSIONE Mitsubishi	TRANSMISSION BELT Mitsubishi	COURROIE DE TRANSMISSION Mitsubishi		9935830	9935800	9935800
COLLETTORE ASPIRAZIONE	INLET MANIFOLD	COLLECTEUR ASPIRATION		CT00727	CT00727	CT00727
CONVERTITORE DI COPPIA	TORQUE CONVERTER	CONVERTISSEUR DE COUPLE		9923150	9923150	9923150
FRIZIONE CENTRIFUGA Ø 105	CENTRIFUGAL CLUTCH Ø 105	EMBAYAGE CENTRIFUGE Ø 105				
FRIZIONE CENTRIFUGA Ø 107	CENTRIFUGAL CLUTCH Ø 107	EMBAYAGE CENTRIFUGE Ø 107		9910020	9910020	9910020
GANASCE FRENO	BRAKE SHOES	MÂCHOIRES FREIN			CP00242	
GRUPPO TERMICO Ø Standard c/testa	CYLINDER KIT Ø standard with head	CYLINDRE COMPLET Ø Standard avec culasse		9914500	9914500	9914500
GRUPPO TERMICO Ø Standard s/testa	CYLINDER KIT Ø standard without head	CYLINDRE COMPLET Ø Standard sans culasse		KT00080	KT00080	KT00080
GRUPPO TERMICO Ø Magg. c/testa	CYLINDER KIT BIG BORE with head	CYLINDRE COMPLET Ø Majoré avec culasse		9931250	9931250	9931250
GRUPPO TERMICO Ø Magg. s/testa	CYLINDER KIT BIG BORE without head	CYLINDRE COMPLET Ø Majoré sans culasse		KT00086	KT00086	KT00086
GRUPPO TERMICO Modifica da AC a LC	CYLINDER KIT Conversion AC to LC	CYLINDRE COMPLET Modification de AC à LC				
KIT CUSCINETTI DA BANCO	BEARINGS KIT	KIT PALIERS DE VILEBREQUIN		KK01003 KK01009	KK01003 KK01009	KK01003 KK01009
KIT REVISIONE POMPA ACQUA	WATER PUMP REPAIR KIT	KIT RÉVISION POMPE À EAU				
MEMBRANA CARBURATORE	CARBURETOR DIAPHRAGM	MEMBRANE CARBURATEUR				
MOTORINO D'AVVIAMENTO	STARTER ENGINE	DÉMARREUR ÉLECTRIQUE		MA00002	MA00002	MA00002
PULEGGIA FISSA	VARIATOR SHEAVE FIXED	POULIE FIXE		PL04058	PL04058	PL04058
RAPPORTI ALLUNGATI Primari	GEARS KIT Primary	RAPPORTS ALLONGÉS Primaires				
RAPPORTI ALLUNGATI Secondari	GEARS KIT Secondary	RAPPORTS ALLONGÉS Secondaires				
REGOLATORE DI TENSIONE	RECTIFIER	RÉGULATEUR DE TENSION		RE00012		RE00012
RUOTA LIBERA	STARTER CLUTCH	ROUE LIBRE		RL00040	RL00040	RL00040
STATORE	STATOR	STATOR				
VALVOLA LAMELLARE	REED VALVE	CLAPET À LAMELLES		9910930	9910930	9910930

GILERA	GILERA	HONDA	HONDA	HONDA	HONDA	HONDA	HONDA	HONDA	HONDA	HONDA	HONDA
TYPHOON XR	TYPHOON XR	BALI	CAMINO PX	DIO SR	DIO ZX	LEAD	MET IN	SFX / SXR	SGX SKY	SH	SH NEW
00-00	00-00	93-99	70-80	92-00	94-96	89-90	90-92	95-01	97-04	84-89	96-01
50cc 2T	50cc 2T AC	50cc 2T AC	50cc 2T AC	50cc 2T AC	50cc 2T AC	50cc 2T AC	50cc 2T AC	50cc 2T AC	50cc 2T AC	50cc 2T AC	50cc 2T AC
Motore Piaggio	Motore Piaggio	Motore Honda	Honda	Motore Honda	Motore Honda	Motore Honda	Motore Honda	Motore Honda	Motore Honda	Motore Honda	Motore Honda
	IM07060										
	IM07015										
	9924870										
	9924880										
	IM07031										
	9924950										
	9922030										
	9935830	9935240				9935860		9935240		9935850	
	CT00727										
	9923150										
		9910020			9910020			9910020	9910020		9910020
CP00242											
	9914500										
	KT00080	KT00113						KT00113	KT00113		KT00113
	9931250 KT00086										
		KT00090	KT00048					KT00090	KT00090		KT00090
	KK01003 KK01009										
	MA00002										
	PL04058										
	RE00012										
	RL00040										
	9910930	9912550		9912550	9912550	9912550	9912550	9912550	9912550	9912550	9912550

SCOOTER 50cc



HONDA	HONDA	HONDA	HONDA
SHADOW	VISION	WALLAROO	X8R S
98-01	88-95	90-01	98-01
50cc 2T AC	50cc 2T AC	50cc 2T AC	50cc 2T AC
Motore Honda	Motore Honda	Motore Honda	Motore Honda

IT	EN	FR				
ALBERO MOTORE Con Cuscinetti e Paraoli	CRANKSHAFT with bearings and oil seals	VILEBREQUIN doté de Paliers et Joints d'huile				
ALBERO MOTORE Senza Cuscinetti e Paraoli	CRANKSHAFT without bearings and oil seals	VILEBREQUIN sans Paliers et Joints d'huile				
ACCENSIONE Fissa	IGNITION UNIT Fixed	ALLUMAGE Fixe				
ACCENSIONE Variabile	IGNITION UNIT Variable	ALLUMAGE Variable				
ACCENSIONE Digitale	DIGITAL IGNITION UNIT	ALLUMAGE Numérique				
BIELLA	CONROD	BIELLE				
CAMPANA FRIZIONE	CLUTCH HOUSING	CLOCHE EMBRAYAGE				
CINGHIA DI TRASMISSIONE TOP PERFORMANCES	TRANSMISSION BELT TOP PERFORMANCES	COURROIE DE TRANSMISSION TOP PERFORMANCES			9931580	
CINGHIA DI TRASMISSIONE Mitsubishi	TRANSMISSION BELT Mitsubishi	COURROIE DE TRANSMISSION Mitsubishi		9935240		
COLLETTORE ASPIRAZIONE	INLET MANIFOLD	COLLECTEUR ASPIRATION				
CONVERTITORE DI COPPIA	TORQUE CONVERTER	CONVERTISSEUR DE COUPLE				
FRIZIONE CENTRIFUGA Ø 105	CENTRIFUGAL CLUTCH Ø 105	EMBAYAGE CENTRIFUGE Ø 105				
FRIZIONE CENTRIFUGA Ø 107	CENTRIFUGAL CLUTCH Ø 107	EMBAYAGE CENTRIFUGE Ø 107				
GANASCE FRENO	BRAKE SHOES	MÂCHOIRES FREIN				
GRUPPO TERMICO Ø Standard c/testa	CYLINDER KIT Ø standard with head	CYLINDRE COMPLET Ø Standard avec culasse				
GRUPPO TERMICO Ø Standard s/testa	CYLINDER KIT Ø standard without head	CYLINDRE COMPLET Ø Standard sans culasse				KT00113
GRUPPO TERMICO Ø Magg. c/testa	CYLINDER KIT BIG BORE with head	CYLINDRE COMPLET Ø Majoré avec culasse				
GRUPPO TERMICO Ø Magg. s/testa	CYLINDER KIT BIG BORE without head	CYLINDRE COMPLET Ø Majoré sans culasse			KT00073	KT00090
GRUPPO TERMICO Modifica da AC a LC	CYLINDER KIT Conversion AC to LC	CYLINDRE COMPLET Modification de AC à LC				
KIT CUSCINETTI DA BANCO	BEARINGS KIT	KIT PALIERS DE VILEBREQUIN				
KIT REVISIONE POMPA ACQUA	WATER PUMP REPAIR KIT	KIT RÉVISION POMPE À EAU				
MEMBRANA CARBURATORE	CARBURETOR DIAPHRAGM	MEMBRANE CARBURATEUR				
MOTORINO D'AVVIAMENTO	STARTER ENGINE	DÉMARREUR ÉLECTRIQUE				
PULEGGIA FISSA	VARIATOR SHEAVE FIXED	POULIE FIXE				
RAPPORTI ALLUNGATI Primari	GEARS KIT Primary	RAPPORTS ALLONGÉS Primaires				
RAPPORTI ALLUNGATI Secondari	GEARS KIT Secondary	RAPPORTS ALLONGÉS Secondaires				
REGOLATORE DI TENSIONE	RECTIFIER	RÉGULATEUR DE TENSION				
RUOTA LIBERA	STARTER CLUTCH	ROUE LIBRE				
STATORE	STATOR	STATOR				
VALVOLA LAMELLARE	REED VALVE	CLAPET À LAMELLES		9912550	9912550	9912550

HONDA	HSC	HSC	HUPPER	HUPPER	HYOSUNG	HYOSUNG	HYOSUNG	HYOSUNG	HYOSUNG	HYOSUNG	ITALJET
X8R X	SC 01	SC 01 L	MONTECARLO 30	MONTECARLO 30	SD SENSE EU1	SD SENSE EU2	SF B RALLY	SF FAST	SF FAST EU2	SF R RALLY	BAZOOKA
98-01	94-96	94-96	09-09	11-11	00-01	05-05	04-08	00-00	01-03	04-08	91-94
50cc 2T AC	50cc 2T AC	50cc 2T AC	50cc 2T AC	50cc 4T AC	50cc 2T AC	50cc 2T AC	50cc 2T AC	50cc 2T AC	50cc 2T AC	50cc 2T AC	50cc 2T AC
Motore Honda	Motore Honda	Motore Honda		Tipo Kymco	Tipo Suzuki	Tipo Suzuki	Tipo Suzuki	Tipo Suzuki	Tipo Suzuki	Tipo Suzuki	Tipo CW
			9913280								
			9935800								
											9911060
	9910020	9910020									9910020
KT00113											
KT00090				9925140 KT00132	KT00057	KT00057	KT00057	KT00057	KT00057	KT00057	
9912550	9912550	9912550									

SCOOTER 50cc

SCOOTER 50cc



ITALJET	ITALJET	ITALJET	ITALJET
DRAGSTER	FORMULA	JET SET	PISTA
98-02	94-97	02-02	92-97
50cc 2T LC	50cc 2T AC	50cc 2T AC	50cc 2T AC
MA	Motore Morini	Motore Piaggio	Tipo CW

IT	EN	FR
----	----	----

ALBERO MOTORE Con Cuscinetti e Paraoli	CRANKSHAFT with bearings and oil seals	VILEBREQUIN doté de Paliers et Joints d'huile
ALBERO MOTORE Senza Cuscinetti e Paraoli	CRANKSHAFT without bearings and oil seals	VILEBREQUIN sans Paliers et Joints d'huile
ACCENSIONE Fissa	IGNITION UNIT Fixed	ALLUMAGE Fixe
ACCENSIONE Variabile	IGNITION UNIT Variable	ALLUMAGE Variable
ACCENSIONE Digitale	DIGITAL IGNITION UNIT	ALLUMAGE Numérique
BIELLA	CONROD	BIELLE
CAMPANA FRIZIONE	CLUTCH HOUSING	CLOCHE EMBRAYAGE
CINGHIA DI TRASMISSIONE TOP PERFORMANCES	TRANSMISSION BELT TOP PERFORMANCES	COURROIE DE TRANSMISSION TOP PERFORMANCES
CINGHIA DI TRASMISSIONE Mitsuboshi	TRANSMISSION BELT Mitsuboshi	COURROIE DE TRANSMISSION Mitsuboshi
COLLETTORE ASPIRAZIONE	INLET MANIFOLD	COLLECTEUR ASPIRATION
CONVERTITORE DI COPPIA	TORQUE CONVERTER	CONVERTISSEUR DE COUPLE
FRIZIONE CENTRIFUGA Ø 105	CENTRIFUGAL CLUTCH Ø 105	EMBAYAGE CENTRIFUGE Ø 105
FRIZIONE CENTRIFUGA Ø 107	CENTRIFUGAL CLUTCH Ø 107	EMBAYAGE CENTRIFUGE Ø 107
GANASCE FRENO	BRAKE SHOES	MÂCHOIRES FREIN
GRUPPO TERMICO Ø Standard c/testa	CYLINDER KIT Ø standard with head	CYLINDRE COMPLET Ø Standard avec culasse
GRUPPO TERMICO Ø Standard s/testa	CYLINDER KIT Ø standard without head	CYLINDRE COMPLET Ø Standard sans culasse
GRUPPO TERMICO Ø Magg. c/testa	CYLINDER KIT BIG BORE with head	CYLINDRE COMPLET Ø Majoré avec culasse
GRUPPO TERMICO Ø Magg. s/testa	CYLINDER KIT BIG BORE without head	CYLINDRE COMPLET Ø Majoré sans culasse
GRUPPO TERMICO Modifica da AC a LC	CYLINDER KIT Conversion AC to LC	CYLINDRE COMPLET Modification de AC à LC
KIT CUSCINETTI DA BANCO	BEARINGS KIT	KIT PALIERS DE VILEBREQUIN
KIT REVISIONE POMPA ACQUA	WATER PUMP REPAIR KIT	KIT RÉVISION POMPE À EAU
MEMBRANA CARBURATORE	CARBURETOR DIAPHRAGM	MEMBRANE CARBURATEUR
MOTORINO D'AVVIAMENTO	STARTER ENGINE	DÉMARREUR ÉLECTRIQUE
PULEGGIA FISSA	VARIATOR SHEAVE FIXED	POULIE FIXE
RAPPORTI ALLUNGATI Primari	GEARS KIT Primary	RAPPORTS ALLONGÉS Primaires
RAPPORTI ALLUNGATI Secondari	GEARS KIT Secondary	RAPPORTS ALLONGÉS Secondaires
REGOLATORE DI TENSIONE	RECTIFIER	RÉGULATEUR DE TENSION
RUOTA LIBERA	STARTER CLUTCH	ROUE LIBRE
STATORE	STATOR	STATOR
VALVOLA LAMELLARE	REED VALVE	CLAPET À LAMELLES

	IM07059		IM07060	
	IM07014		IM07015	
	9910100		9924870	
	9909230		9924880	
	IM07032		IM07031	
	9924940		9924950	
	9907770		9922030	
	9935270			
	CT00725		CT00727	
	9923030		9923150	
	9911060			9911060
	9910020 9925130		9910020	9910020
	9931110		9914500	
	KT00094		KT00080	
	9931310 KT00109		9931250 KT00086	
		KT00057		
	KK01000 KK01002		KK01003 KK01009	
	AA00780 AA00785 AA00786	AA00787 AA00788		
	MA00001			
	PL04055 PL04056			
	9913300			
	9909520			
	AA00767 RL00001			
	9908370		9910930	

ITALJET	ITALJET	ITALJET	ITALJET	ITALJET	ITALJET	ITALJET	KEEWAY	KEEWAY	KEEWAY	KEEWAY	KEEWAY
PISTA 2	SCOOP	SCOOP 2	TORPEDO	TORPEDO NEW	VELOCIFERO	YANKEE	F-ACT	FLASH	FOCUS	GOCCIA	HURRICANE
97-98	91-95	96-98	97-00	00-01	98-02	93-97	07-08	07-08	06-06	09-09	06-08
50cc 2T AC	50cc 2T AC	50cc 2T AC	50cc 4T AC	50cc 2T AC	50cc 2T AC	50cc 2T AC	50cc 2T AC	50cc 2T AC	50cc 2T AC	50cc 2T AC	50cc 2T AC
Tipo CW	Tipo CW	Tipo CW	Motore Piaggio	Motore Piaggio	Motore Morini	Tipo CW	Motore Keeway	Motore Keeway	Motore Keeway	Motore Keeway	Motore Keeway
				IM07060							
				IM07015							
				9924870							
				9924880							
				IM07031							
				9924950							
9907770		9907770		9922030		9907770	9913280	9913280	9913280	9913280	9913280
9935270		9935270				9935270	9935800	9935800	9935800	9935800	9935800
				CT00727							
				9923150			9923030	9923030	9923030	9923030	9923030
9911060	9911060	9911060				9911060					
9910020	9910020	9910020		9910020		9910020	9925130	9925130	9925130	9925130	9925130
				9914500			9925650	9925650	9925650	9925650	9925650
				KT00080			KT00129	KT00129	KT00129	KT00129	KT00129
				9931250 KT00086			9924890 KT00128	9924890 KT00128	9924890 KT00128	9924890 KT00128	9924890 KT00128
			9925150 KT00133		KT00057						
				KK01003 KK01009							
AA00767		AA00767				AA00767					
				9910930							

SCOOTER 50cc



KEEWAY	KEEWAY	KEEWAY	KTM
MATRIX	PIXEL EURO 2	RY8	K50
06-08	09-12	08-08	96-01
50cc 2T AC	50cc 2T AC	50cc 2T AC	50cc 2T AC
Motore Keeway	Motore Keeway	Motore Keeway	MY

IT	EN	FR	Image			
ALBERO MOTORE Con Cuscinetti e Paraoli	CRANKSHAFT with bearings and oil seals	VILEBREQUIN doté de Paliers et Joints d'huile				
ALBERO MOTORE Senza Cuscinetti e Paraoli	CRANKSHAFT without bearings and oil seals	VILEBREQUIN sans Paliers et Joints d'huile				
ACCENSIONE Fissa	IGNITION UNIT Fixed	ALLUMAGE Fixe				
ACCENSIONE Variabile	IGNITION UNIT Variable	ALLUMAGE Variable				
ACCENSIONE Digitale	DIGITAL IGNITION UNIT	ALLUMAGE Numérique				
BIELLA	CONROD	BIELLE				
CAMPANA FRIZIONE	CLUTCH HOUSING	CLOCHE EMBRAYAGE				
CINGHIA DI TRASMISSIONE TOP PERFORMANCES	TRANSMISSION BELT TOP PERFORMANCES	COURROIE DE TRANSMISSION TOP PERFORMANCES				
CINGHIA DI TRASMISSIONE Mitsuboshi	TRANSMISSION BELT Mitsuboshi	COURROIE DE TRANSMISSION Mitsuboshi				
COLLETTORE ASPIRAZIONE	INLET MANIFOLD	COLLECTEUR ASPIRATION				
CONVERTITORE DI COPPIA	TORQUE CONVERTER	CONVERTISSEUR DE COUPLE				
FRIZIONE CENTRIFUGA Ø 105	CENTRIFUGAL CLUTCH Ø 105	EMBAYAGE CENTRIFUGE Ø 105				
FRIZIONE CENTRIFUGA Ø 107	CENTRIFUGAL CLUTCH Ø 107	EMBAYAGE CENTRIFUGE Ø 107				
GANASCE FRENO	BRAKE SHOES	MÂCHOIRES FREIN				
GRUPPO TERMICO Ø Standard c/testa	CYLINDER KIT Ø standard with head	CYLINDRE COMPLET Ø Standard avec culasse				
GRUPPO TERMICO Ø Standard s/testa	CYLINDER KIT Ø standard without head	CYLINDRE COMPLET Ø Standard sans culasse				
GRUPPO TERMICO Ø Magg. c/testa	CYLINDER KIT BIG BORE with head	CYLINDRE COMPLET Ø Majoré avec culasse				
GRUPPO TERMICO Ø Magg. s/testa	CYLINDER KIT BIG BORE without head	CYLINDRE COMPLET Ø Majoré sans culasse				
GRUPPO TERMICO Modifica da AC a LC	CYLINDER KIT Conversion AC to LC	CYLINDRE COMPLET Modification de AC à LC				
KIT CUSCINETTI DA BANCO	BEARINGS KIT	KIT PALIERS DE VILEBREQUIN				
KIT REVISIONE POMPA ACQUA	WATER PUMP REPAIR KIT	KIT RÉVISION POMPE À EAU				
MEMBRANA CARBURATORE	CARBURETOR DIAPHRAGM	MEMBRANE CARBURATEUR				
MOTORINO D'AVVIAMENTO	STARTER ENGINE	DÉMARREUR ÉLECTRIQUE				
PULEGGIA FISSA	VARIATOR SHEAVE FIXED	POULIE FIXE				
RAPPORTI ALLUNGATI Primari	GEARS KIT Primary	RAPPORTS ALLONGÉS Primaires				
RAPPORTI ALLUNGATI Secondari	GEARS KIT Secondary	RAPPORTS ALLONGÉS Secondaires				
REGOLATORE DI TENSIONE	RECTIFIER	RÉGULATEUR DE TENSION				
RUOTA LIBERA	STARTER CLUTCH	ROUE LIBRE				
STATORE	STATOR	STATOR				
VALVOLA LAMELLARE	REED VALVE	CLAPET À LAMELLES				



KYMCO	KYMCO	KYMCO	KYMCO
AGILITY RS	AGILITY RS NAKED	B&W	B&W EU2
09-09	10-10	02-02	03-03
50cc 4T AC	50cc 2T AC	50cc 2T LC	50cc 2T LC
Motore Kymco	Motore Kymco	Motore Kymco	Motore Kymco

IT	EN	FR				
ALBERO MOTORE Con Cuscinetti e Paraoli	CRANKSHAFT with bearings and oil seals	VILEBREQUIN doté de Paliers et Joints d'huile		IM07074		
ALBERO MOTORE Senza Cuscinetti e Paraoli	CRANKSHAFT without bearings and oil seals	VILEBREQUIN sans Paliers et Joints d'huile				
ACCENSIONE Fissa	IGNITION UNIT Fixed	ALLUMAGE Fixe				
ACCENSIONE Variabile	IGNITION UNIT Variable	ALLUMAGE Variable				
ACCENSIONE Digitale	DIGITAL IGNITION UNIT	ALLUMAGE Numérique				
BIELLA	CONROD	BIELLE				
CAMPANA FRIZIONE	CLUTCH HOUSING	CLOCHE EMBRAYAGE				
CINGHIA DI TRASMISSIONE TOP PERFORMANCES	TRANSMISSION BELT TOP PERFORMANCES	COURROIE DE TRANSMISSION TOP PERFORMANCES		9931590	9931590	9931590
CINGHIA DI TRASMISSIONE Mitsubishi	TRANSMISSION BELT Mitsubishi	COURROIE DE TRANSMISSION Mitsubishi				
COLLETORE ASPIRAZIONE	INLET MANIFOLD	COLLECTEUR ASPIRATION		CT00743		
CONVERTITORE DI COPPIA	TORQUE CONVERTER	CONVERTISSEUR DE COUPLE				
FRIZIONE CENTRIFUGA Ø 105	CENTRIFUGAL CLUTCH Ø 105	EMBAYAGE CENTRIFUGE Ø 105				
FRIZIONE CENTRIFUGA Ø 107	CENTRIFUGAL CLUTCH Ø 107	EMBAYAGE CENTRIFUGE Ø 107				
GANASCE FRENO	BRAKE SHOES	MÂCHOIRES FREIN				
GRUPPO TERMICO Ø Standard c/testa	CYLINDER KIT Ø standard with head	CYLINDRE COMPLET Ø Standard avec culasse				
GRUPPO TERMICO Ø Standard s/testa	CYLINDER KIT Ø standard without head	CYLINDRE COMPLET Ø Standard sans culasse				
GRUPPO TERMICO Ø Magg. c/testa	CYLINDER KIT BIG BORE with head	CYLINDRE COMPLET Ø Majoré avec culasse				
GRUPPO TERMICO Ø Magg. s/testa	CYLINDER KIT BIG BORE without head	CYLINDRE COMPLET Ø Majoré sans culasse		9925140 KT00132		
GRUPPO TERMICO Modifica da AC a LC	CYLINDER KIT Conversion AC to LC	CYLINDRE COMPLET Modification de AC à LC				
KIT CUSCINETTI DA BANCO	BEARINGS KIT	KIT PALIERS DE VILEBREQUIN			KK01013	KK01013
KIT REVISIONE POMPA ACQUA	WATER PUMP REPAIR KIT	KIT RÉVISION POMPE À EAU				
MEMBRANA CARBURATORE	CARBURETOR DIAPHRAGM	MEMBRANE CARBURATEUR		MC12009		
MOTORINO D'AVVIAMENTO	STARTER ENGINE	DÉMARREUR ÉLECTRIQUE		MA00025		MA00014
PULEGGIA FISSA	VARIATOR SHEAVE FIXED	POULIE FIXE				
RAPPORTI ALLUNGATI Primari	GEARS KIT Primary	RAPPORTS ALLONGÉS Primaires				
RAPPORTI ALLUNGATI Secondari	GEARS KIT Secondary	RAPPORTS ALLONGÉS Secondaires				
REGOLATORE DI TENSIONE	RECTIFIER	RÉGULATEUR DE TENSION				RE00013
RUOTA LIBERA	STARTER CLUTCH	ROUE LIBRE		RL00033 RL00040	RL00033 RL00040	RL00033 RL00040
STATORE	STATOR	STATOR				
VALVOLA LAMELLARE	REED VALVE	CLAPET À LAMELLES				

KYMC0	KYMC0	KYMC0	KYMC0	KYMC0	KYMC0	KYMC0	KYMC0	KYMC0	KYMC0	KYMC0	KYMC0
CX	CX SUPER	DINK AC	DINK LC	DINK 50 4T	DINK CLASSIC EU2	DJ WORLD	DJ X	DJ Y	EASY	FEVER ZX	FEVER ZX EU2
93-93	94-97	98-02	98-02	07-07	03-03	94-00	91-92	93-93	01-01	99-00	03-04
50cc 2T AC	50cc 2T AC	50cc 2T AC	50cc 2T LC	50cc 4T AC	50cc 2T AC	50cc 2T AC	50cc 2T AC	50cc 2T AC	50cc	50cc 2T AC	50cc 2T AC
Motore Kymco	Motore Kymco	Motore Kymco	Motore Kymco	Motore Kymco	Motore Kymco	Motore Kymco	Motore Kymco	Motore Kymco	A	Motore Kymco	Motore Kymco
		9931590	9931590	9931590	9931590						
									CP00219		
				9925140 KT00132							
			KK01013		KK01013						
				MC12009							
			MA00014	MA00025	MA00014						
RE00013	RE00013		RE00013	RE00013	RE00013	RE00013	RE00013	RE00013		RE00013	RE00013
		RL00033 RL00040	RL00033 RL00040	RL00033 RL00040	RL00033 RL00040						
				ST00028							
9912550	9912550					9912550		9912550		9912550	9912550



KYMCO	KYMCO	KYMCO	KYMCO
FILLY	FILLY LX	HEROISM	K 12
98-00	01-02	95-97	95-00
50cc 4T AC	50cc 4T AC	50cc 2T AC	50cc 2T AC
Motore Kymco	Motore Kymco	Motore Kymco	Motore Kymco
IM07074	IM07074		
CT00743	CT00743		
9925140 KT00132	9925140 KT00132		
		KK01013	
MA00025	MA00025	MA00014	
RE00013	RE00013	RE00013	RE00013
RL00033 RL00040	RL00033 RL00040	RL00033 RL00040	
ST00028	ST00028		
			9912550

IT	EN	FR
ALBERO MOTORE Con Cuscinetti e Paraoli	CRANKSHAFT with bearings and oil seals	VILEBREQUIN doté de Paliers et Joints d'huile
ALBERO MOTORE Senza Cuscinetti e Paraoli	CRANKSHAFT without bearings and oil seals	VILEBREQUIN sans Paliers et Joints d'huile
ACCENSIONE Fissa	IGNITION UNIT Fixed	ALLUMAGE Fixe
ACCENSIONE Variabile	IGNITION UNIT Variable	ALLUMAGE Variable
ACCENSIONE Digitale	DIGITAL IGNITION UNIT	ALLUMAGE Numérique
BIELLA	CONROD	BIELLE
CAMPANA FRIZIONE	CLUTCH HOUSING	CLOCHE EMBRAYAGE
CINGHIA DI TRASMISSIONE TOP PERFORMANCES	TRANSMISSION BELT TOP PERFORMANCES	COURROIE DE TRANSMISSION TOP PERFORMANCES
CINGHIA DI TRASMISSIONE Mitsubishi	TRANSMISSION BELT Mitsubishi	COURROIE DE TRANSMISSION Mitsubishi
COLLETTORE ASPIRAZIONE	INLET MANIFOLD	COLLECTEUR ASPIRATION
CONVERTITORE DI COPPIA	TORQUE CONVERTER	CONVERTISSEUR DE COUPLE
FRIZIONE CENTRIFUGA Ø 105	CENTRIFUGAL CLUTCH Ø 105	EMBAYAGE CENTRIFUGE Ø 105
FRIZIONE CENTRIFUGA Ø 107	CENTRIFUGAL CLUTCH Ø 107	EMBAYAGE CENTRIFUGE Ø 107
GANASCE FRENO	BRAKE SHOES	MÂCHOIRES FREIN
GRUPPO TERMICO Ø Standard c/testa	CYLINDER KIT Ø standard with head	CYLINDRE COMPLET Ø Standard avec culasse
GRUPPO TERMICO Ø Standard s/testa	CYLINDER KIT Ø standard without head	CYLINDRE COMPLET Ø Standard sans culasse
GRUPPO TERMICO Ø Magg. c/testa	CYLINDER KIT BIG BORE with head	CYLINDRE COMPLET Ø Majoré avec culasse
GRUPPO TERMICO Ø Magg. s/testa	CYLINDER KIT BIG BORE without head	CYLINDRE COMPLET Ø Majoré sans culasse
GRUPPO TERMICO Modifica da AC a LC	CYLINDER KIT Conversion AC to LC	CYLINDRE COMPLET Modification de AC à LC
KIT CUSCINETTI DA BANCO	BEARINGS KIT	KIT PALIERS DE VILEBREQUIN
KIT REVISIONE POMPA ACQUA	WATER PUMP REPAIR KIT	KIT RÉVISION POMPE À EAU
MEMBRANA CARBURATORE	CARBURETOR DIAPHRAGM	MEMBRANE CARBURATEUR
MOTORINO D'AVVIAMENTO	STARTER ENGINE	DÉMARREUR ÉLECTRIQUE
PULEGGIA FISSA	VARIATOR SHEAVE FIXED	POULIE FIXE
RAPPORTI ALLUNGATI Primari	GEARS KIT Primary	RAPPORTS ALLONGÉS Primaires
RAPPORTI ALLUNGATI Secondari	GEARS KIT Secondary	RAPPORTS ALLONGÉS Secondaires
REGOLATORE DI TENSIONE	RECTIFIER	RÉGULATEUR DE TENSION
RUOTA LIBERA	STARTER CLUTCH	ROUE LIBRE
STATORE	STATOR	STATOR
VALVOLA LAMELLARE	REED VALVE	CLAPET À LAMELLES

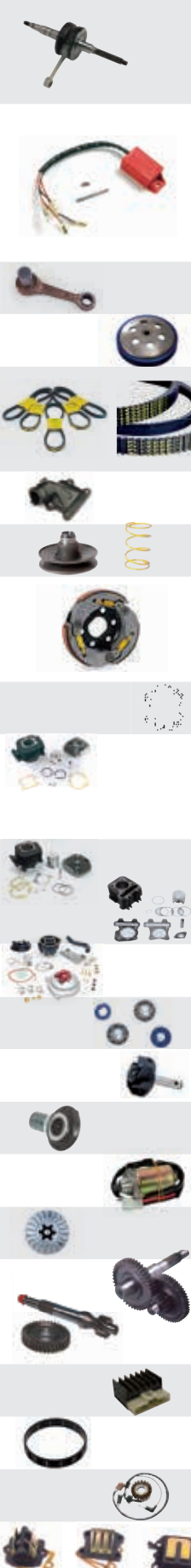

KYMCO	KYMCO	KYMCO	KYMCO	KYMCO	KYMCO	KYMCO	KYMCO	KYMCO	KYMCO	KYMCO	KYMCO
KB	LIKE	LIKE	PEOPLE	PEOPLE	PEOPLE EURO 2	PEOPLE EURO 2	PEOPLE EURO 2	PEOPLE S	PEOPLE S 4T	SENTO	SNIPER
95-00	09-09	09-09	99-03	04-04	03-03	08-08	11-11	05-08	06-08	08-08	93-93
50cc 2T AC	50cc 4T AC	50cc 4T AC	50cc 2T AC	50cc 2T AC	50cc 2T AC	50cc 2T AC	50cc 2T AC	50cc 2T AC	50cc 4T AC	50cc 4T AC	50cc 2T AC
Motore Kymco	Motore Kymco	Motore Kymco	Motore Kymco	Motore Kymco	Motore Kymco	Motore Kymco	Motore Kymco	Motore Kymco	Motore Kymco	Motore Kymco	Motore Kymco
		IM07074							IM07074	IM07074	
	9931590	9931590	9931590	9931590	9931590	9931590	9931590	9931590	9931590		
		CT00743							CT00743		
	9925140	9925140 KT00132							9925140 KT00132	9925140 KT00132	
			KK01013	KK01013	KK01013	KK01013	KK01013	KK01013	KK01013		KK01013
		MC12009									
		MA00025	MA00014	MA00014	MA00014	MA00014	MA00014	MA00014	MA00025	MA00025	MA00014
RE00013			RE00013	RE00013	RE00013	RE00013			RE00013		RE00013
	RL00033 RL00040	RL00033 RL00040	RL00033 RL00040	RL00033 RL00040	RL00033 RL00040	RL00033 RL00040	RL00033 RL00040	RL00033 RL00040	RL00033 RL00040	RL00033 RL00040	RL00033 RL00040
									ST00028	ST00028	
9912550											

SCOOTER 50cc

KYMCO	KYMCO	KYMCO	KYMCO	KYMCO	KYMCO	KYMCO	KYMCO	KYMCO	MACAL	MACAL	MALAGUTI
SUPER 8 4T	SUPER 9	SUPER 9 EU2	SUPER 9 EU2	TOP BOY	VITALITY 2T	VITALITY 4T	YUP	YUP EU2	STING	THUNDER	CENTRO EURO 2
13-13	00-00	03-03	04-04	97-00	04-04	04-04	02-02	03-03	95-96	95-96	08-08
50cc 4T AC	50cc 2T LC	50cc 2T LC	50cc 2T LC	50cc 2T AC	50cc 2T AC	50cc 4T AC	50cc 2T AC	50cc 2T AC	50cc 2T AC	50cc 2T AC	50cc 4T AC
Motore Kymco	Motore Kymco	Motore Kymco	Motore Kymco	Motore Kymco	Motore Kymco	Motore Kymco	Motore Kymco	Motore Kymco	CY	MY	Motore Piaggio
IM07074										IM07059	
										IM07014	
										IM07032	
										9924940	
	9931590	9931590		9931590	9931590	9931590	9931590	9931590		9907770	
										9935270	
						CT00743				CT00725	
										9923030	
										9911060	
										9910020 9925130	
										9931140	
										KT00095	
										9931340 KT00087	
						9925140 KT00132					9925150 KT00133
										9911090	
	KK01013	KK01013	KK01013	KK01013	KK01013		KK01013	KK01013		KK01000 KK01002	
MC12009											
	MA00014	MA00014	MA00014	MA00014	MA00014		MA00014	MA00014	MA00001	MA00001	MA00015
									PL04055 PL04056	PL04055 PL04056	
										9913300	
	RE00013	RE00013	RE00013	RE00013	RE00013	RE00013	RE00013	RE00013			RE00018
	RL00033 RL00040	RL00033 RL00040	RL00033 RL00040	RL00033 RL00040	RL00033 RL00040	RL00033 RL00040	RL00033 RL00040	RL00033 RL00040		AA00767 RL00001	RL00039
						ST00028			SD00002	SD00002	
										9908370	



MALAGUTI	MALAGUTI	MALAGUTI	MALAGUTI
CENTRO SL	CENTRO SL 4T	CIAK	CIAK EURO 2,2,3
94-98	10-10	99-01	03-03
50cc 2T AC	50cc 4T AC	50cc 2T AC	50cc 2T AC
MY	Motore Piaggio	MY	MY

IT	EN	FR					
ALBERO MOTORE Con Cuscinetti e Paraoli	CRANKSHAFT with bearings and oil seals	VILEBREQUIN doté de Paliers et Joints d'huile		IM07059		IM07059	IM07059
ALBERO MOTORE Senza Cuscinetti e Paraoli	CRANKSHAFT without bearings and oil seals	VILEBREQUIN sans Paliers et Joints d'huile		IM07014		IM07014	IM07014
ACCENSIONE Fissa	IGNITION UNIT Fixed	ALLUMAGE Fixe					
ACCENSIONE Variabile	IGNITION UNIT Variable	ALLUMAGE Variable					
ACCENSIONE Digitale	DIGITAL IGNITION UNIT	ALLUMAGE Numérique					9921210
BIELLA	CONROD	BIELLE		IM07032		IM07032	IM07032
CAMPANA FRIZIONE	CLUTCH HOUSING	CLOCHE EMBRAYAGE		9924940		9924940	9924940
CINGHIA DI TRASMISSIONE TOP PERFORMANCES	TRANSMISSION BELT TOP PERFORMANCES	COURROIE DE TRANSMISSION TOP PERFORMANCES		9907770		9907770	9907770
CINGHIA DI TRASMISSIONE Mitsuboshi	TRANSMISSION BELT Mitsuboshi	COURROIE DE TRANSMISSION Mitsuboshi		9935270		9935270	9935270
COLLETTORE ASPIRAZIONE	INLET MANIFOLD	COLLECTEUR ASPIRATION		CT00725		CT00725	CT00725
CONVERTITORE DI COPPIA	TORQUE CONVERTER	CONVERTISSEUR DE COUPLE		9923030		9923030	9923030
FRIZIONE CENTRIFUGA Ø 105	CENTRIFUGAL CLUTCH Ø 105	EMBAYAGE CENTRIFUGE Ø 105		9911060		9911060	9911060
FRIZIONE CENTRIFUGA Ø 107	CENTRIFUGAL CLUTCH Ø 107	EMBAYAGE CENTRIFUGE Ø 107		9910020 9925130		9910020 9925130	9910020 9925130
GANASCE FRENO	BRAKE SHOES	MÂCHOIRES FREIN					
GRUPPO TERMICO Ø Standard c/testa	CYLINDER KIT Ø standard with head	CYLINDRE COMPLET Ø Standard avec culasse		9931140		9931140	9931140
GRUPPO TERMICO Ø Standard s/testa	CYLINDER KIT Ø standard without head	CYLINDRE COMPLET Ø Standard sans culasse		KT00095		KT00095	KT00095
GRUPPO TERMICO Ø Magg. c/testa	CYLINDER KIT BIG BORE with head	CYLINDRE COMPLET Ø Majoré avec culasse		9931340 KT00087		9931340 KT00087	9931340 KT00087
GRUPPO TERMICO Ø Magg. s/testa	CYLINDER KIT BIG BORE without head	CYLINDRE COMPLET Ø Majoré sans culasse			9925150 KT00133		
GRUPPO TERMICO Modifica da AC a LC	CYLINDER KIT Conversion AC to LC	CYLINDRE COMPLET Modification de AC à LC		9911090		9911090	9911090
KIT CUSCINETTI DA BANCO	BEARINGS KIT	KIT PALIERS DE VILEBREQUIN		KK01000 KK01002		KK01000 KK01002	KK01000 KK01002
KIT REVISIONE POMPA ACQUA	WATER PUMP REPAIR KIT	KIT RÉVISION POMPE À EAU					
MEMBRANA CARBURATORE	CARBURETOR DIAPHRAGM	MEMBRANE CARBURATEUR					
MOTORINO D'AVVIAMENTO	STARTER ENGINE	DÉMARREUR ÉLECTRIQUE		MA00001	MA00015	MA00001	MA00001
PULEGGIA FISSA	VARIATOR SHEAVE FIXED	POULIE FIXE		PL04055 PL04056		PL04055 PL04056	PL04055 PL04056
RAPPORTI ALLUNGATI Primari	GEARS KIT Primary	RAPPORTS ALLONGÉS Primaires		9913300		9913300	9913300
RAPPORTI ALLUNGATI Secondari	GEARS KIT Secondary	RAPPORTS ALLONGÉS Secondaires					
REGOLATORE DI TENSIONE	RECTIFIER	RÉGULATEUR DE TENSION		RE00014	RE00018	RE00014	
RUOTA LIBERA	STARTER CLUTCH	ROUE LIBRE		AA00767 RL00001	RL00039	AA00767 RL00001	AA00767 RL00001
STATORE	STATOR	STATOR		SD00002		SD00002	
VALVOLA LAMELLARE	REED VALVE	CLAPET À LAMELLES		9908370		9908370	9908370

MALAGUTI	MALAGUTI	MALAGUTI	MALAGUTI	MALAGUTI	MALAGUTI	MALAGUTI	MALAGUTI	MALAGUTI	MALAGUTI	MALAGUTI	MALAGUTI
CIAK EURO2	CIAK MASTER 4T	CIAK MASTER EURO 2	CIAK MASTER EURO 2	CROSSER CR1	DVD	F10	F10 AC ECO	F10 AC WAP	F10 EURO 2	F10 EURO 2 2,3	F10 RESTYLING EURO 2
01-03	05-06	05-06	06-06	95-98	10-10	92-00	09-10	08-08	02-06	03-04	06-06
50cc 2T AC	50cc 4T AC	50cc 4T AC	50cc 2T AC	50cc 2T AC	50cc 4T AC	50cc 2T AC	50cc 2T AC	50cc 2T AC	50cc 2T AC	50cc 2T AC	50cc 2T AC
MY	Motore Piaggio	Motore Piaggio	MY	Motore Morini	Tipo Kymco	CY	Tipo Keeway	Tipo Keeway	CY	CY	CY
IM07059			IM07059			IM07059			IM07059	IM07059	IM07059
IM07014			IM07014			IM07014			IM07014	IM07014	IM07014
			9925780							9921210	9925780
IM07032			IM07032			IM07032			IM07032	IM07032	IM07032
9924940			9924940			9924940			9924940	9924940	9924940
9907770			9907770			9907900		9913280	9907900	9907900	9907900
9935270			9935270			9935340		9935800	9935340	9935340	9935340
CT00725			CT00725			CT00725			CT00725	CT00725	CT00725
9923030			9923030			9923030		9923030	9923030	9923030	9923030
9911060						9911060			9911060	9911060	
9910020 9925130			9925130			9910020 9925130		9925130	9910020 9925130	9910020 9925130	9925130
9931140			9931140			9931140	9934200	9925650	9931140	9931140	9931140
KT00095			KT00095			KT00095		KT00129	KT00095	KT00095	KT00095
9931340 KT00087			9931340 KT00087			9931340 KT00087	9934300	9924890 KT00128	9931340 KT00087	9931340 KT00087	9931340 KT00087
	9925150 KT00133	9925150 KT00133		KT00057	9925140 KT00132						
9911090			9911090			9911090			9911090	9911090	9911090
KK01000 KK01002			KK01000 KK01002			KK01000 KK01002			KK01000 KK01002	KK01000 KK01002	KK01000 KK01002
MA00001	MA00015		MA00001			MA00001			MA00001	MA00001	MA00001
PL04055 PL04056			PL04055 PL04056			PL04055 PL04056			PL04055 PL04056	PL04055 PL04056	PL04055 PL04056
9913300			9913300								
RE00014		RE00018		RE00014		RE00014		RE00014	RE00014		
AA00767 RL00001	RL00039		AA00767 RL00001			AA00767 RL00001			AA00767 RL00001	AA00767 RL00001	AA00767 RL00001
SD00002						SD00002			SD00002		
9908370			9908370			9908370			9908370	9908370	9908370

SCOOTER 50cc



MALAGUTI	MALAGUTI	MALAGUTI	MALAGUTI
F12 PHANTOM	F12 PHANTOM EURO 2	F12 PHANTOM EURO 2,2,3	F12 PHANTOM LC
94-98	02-02	03-04	94-98
50cc 2T AC	50cc 2T LC	50cc 2T AC	50cc 2T LC
MY	MA vent.	MY	MA

IT	EN	FR	
ALBERO MOTORE Con Cuscinetti e Paraoli	CRANKSHAFT with bearings and oil seals	VILEBREQUIN doté de Paliers et Joints d'huile	
ALBERO MOTORE Senza Cuscinetti e Paraoli	CRANKSHAFT without bearings and oil seals	VILEBREQUIN sans Paliers et Joints d'huile	
ACCENSIONE Fissa	IGNITION UNIT Fixed	ALLUMAGE Fixe	
ACCENSIONE Variabile	IGNITION UNIT Variable	ALLUMAGE Variable	
ACCENSIONE Digitale	DIGITAL IGNITION UNIT	ALLUMAGE Numérique	
BIELLA	CONROD	BIELLE	
CAMPANA FRIZIONE	CLUTCH HOUSING	CLOCHE EMBRAYAGE	
CINGHIA DI TRASMISSIONE TOP PERFORMANCES	TRANSMISSION BELT TOP PERFORMANCES	COURROIE DE TRANSMISSION TOP PERFORMANCES	
CINGHIA DI TRASMISSIONE Mitsuboshi	TRANSMISSION BELT Mitsuboshi	COURROIE DE TRANSMISSION Mitsuboshi	
COLLETTORE ASPIRAZIONE	INLET MANIFOLD	COLLECTEUR ASPIRATION	
CONVERTITORE DI COPPIA	TORQUE CONVERTER	CONVERTISSEUR DE COUPLE	
FRIZIONE CENTRIFUGA Ø 105	CENTRIFUGAL CLUTCH Ø 105	EMBAYAGE CENTRIFUGE Ø 105	
FRIZIONE CENTRIFUGA Ø 107	CENTRIFUGAL CLUTCH Ø 107	EMBAYAGE CENTRIFUGE Ø 107	
GANASCE FRENO	BRAKE SHOES	MÂCHOIRES FREIN	
GRUPPO TERMICO Ø Standard c/testa	CYLINDER KIT Ø standard with head	CYLINDRE COMPLET Ø Standard avec culasse	
GRUPPO TERMICO Ø Standard s/testa	CYLINDER KIT Ø standard without head	CYLINDRE COMPLET Ø Standard sans culasse	
GRUPPO TERMICO Ø Magg. c/testa	CYLINDER KIT BIG BORE with head	CYLINDRE COMPLET Ø Majoré avec culasse	
GRUPPO TERMICO Ø Magg. s/testa	CYLINDER KIT BIG BORE without head	CYLINDRE COMPLET Ø Majoré sans culasse	
GRUPPO TERMICO Modifica da AC a LC	CYLINDER KIT Conversion AC to LC	CYLINDRE COMPLET Modification de AC à LC	
KIT CUSCINETTI DA BANCO	BEARINGS KIT	KIT PALIERS DE VILEBREQUIN	
KIT REVISIONE POMPA ACQUA	WATER PUMP REPAIR KIT	KIT RÉVISION POMPE À EAU	
MEMBRANA CARBURATORE	CARBURETOR DIAPHRAGM	MEMBRANE CARBURATEUR	
MOTORINO D'AVVIAMENTO	STARTER ENGINE	DÉMARREUR ÉLECTRIQUE	
PULEGGIA FISSA	VARIATOR SHEAVE FIXED	POULIE FIXE	
RAPPORTI ALLUNGATI Primari	GEARS KIT Primary	RAPPORTS ALLONGÉS Primaires	
RAPPORTI ALLUNGATI Secondari	GEARS KIT Secondary	RAPPORTS ALLONGÉS Secondaires	
REGOLATORE DI TENSIONE	RECTIFIER	RÉGULATEUR DE TENSION	
RUOTA LIBERA	STARTER CLUTCH	ROUE LIBRE	
STATORE	STATOR	STATOR	
VALVOLA LAMELLARE	REED VALVE	CLAPET À LAMELLES	

MALAGUTI	MALAGUTI	MALAGUTI	MALAGUTI	MALAGUTI	MALAGUTI	MALAGUTI	MALAGUTI	MALAGUTI	MALAGUTI	MALAGUTI	MALAGUTI
F12 PHANTOM LC EURO 2,2,3	F12 R PHANTOM AC	F12 R PHANTOM AC	F12 R PHANTOM LC	F12 RESTYLING EURO 1	F12 RESTYLING EURO 2	F12 RESTYLING LC EURO 2	F15 FIRE FOX	F15 FIRE FOX AIR COOLED	F15 FIRE FOX EURO 2	F15 FIRE FOX EURO 2	F15 FIRE FOX EURO 2,2,3
03-04	07-08	09-10	07-10	99-02	06-06	06-06	96-98	05-06	02-03	04-06	03-04
50cc 2T LC	50cc 2T AC	50cc 2T AC	50cc 2T LC	50cc 2T LC	50cc 2T AC	50cc 2T LC	50cc 2T LC	50cc 2T AC	50cc 2T LC	50cc 2T LC	50cc 2T LC
MA vent.	Tipo Keeway	Tipo Keeway	MA	MA vent.	MY	MA vent.	MA	MY	MA	MA	MA
			IM07059				IM07059	IM07059	IM07059	IM07059	IM07059
IM07018			IM07014	IM07018	IM07018	IM07018	IM07014	IM07014	IM07014	IM07014	IM07014
9921210			9925780		9925780	9925780		9925780		9925780	9921210
IM07032			IM07032	IM07032	IM07032	IM07032	IM07032	IM07032	IM07032	IM07032	IM07032
			9924940		9924940		9924940	9924940	9924940	9924940	9924940
9907770	9913280		9907770	9907770	9907770	9907770	9907770	9907770	9907770	9907770	9907770
9935270	9935800		9935270	9935270	9935270	9935270	9935270	9935270	9935270	9935270	9935270
CT00725			CT00725	CT00725	CT00725	CT00725	CT00725	CT00725	CT00725	CT00725	CT00725
9923030	9923030		9923030	9923030	9923030	9923030	9923030	9923030	9923030	9923030	9923030
9911060					9911060		9911060		9911060		9911060
9910020 9925130	9925130		9925130	9910020 9925130	9910020 9925130	9925130	9910020 9925130	9925130	9910020 9925130	9925130	9910020 9925130
9931110	9925650	9934200	9931110	9931110	9931140	9931110	9931110	9931140	9931110	9931110	9931110
KT00094	KT00129		KT00094	KT00094	KT00095	KT00094	KT00094	KT00095	KT00094	KT00094	KT00094
9931310	9924890 KT00128	9934300	9931310 KT00109	9931310	9931340 KT00087	9931310	9931310 KT00109	9931340 KT00087	9931310 KT00109	9931310 KT00109	9931310 KT00109
					9911090			9911090			
KK01000 KK01002			KK01000 KK01002	KK01000 KK01002	KK01000 KK01002	KK01000 KK01002	KK01000 KK01002	KK01000 KK01002	KK01000 KK01002	KK01000 KK01002	KK01000 KK01002
AA00780 AA00785 AA00786	AA00787 AA00788		AA00780 AA00785 AA00786	AA00787 AA00788	AA00780 AA00785 AA00786	AA00787 AA00788	AA00780 AA00785 AA00786	AA00787 AA00788	AA00780 AA00785 AA00786	AA00787 AA00788	AA00780 AA00785 AA00786
MA00001			MA00001	MA00001	MA00001	MA00001	MA00001	MA00001	MA00001	MA00001	MA00001
PL04055 PL04056			PL04055 PL04056	PL04055 PL04056	PL04055 PL04056	PL04055 PL04056	PL04055 PL04056	PL04055 PL04056	PL04055 PL04056	PL04055 PL04056	PL04055 PL04056
			9913300		9913300		9913300	9913300	9913300	9913300	9913300
			9909520		9909520		9909520	9909520	9909520	9909520	9909520
	RE00014			RE00014			RE00014	RE00014	RE00014	RE00014	
AA00767 RL00001			AA00767 RL00001	AA00767 RL00001	AA00767 RL00001	AA00767 RL00001	AA00767 RL00001	AA00767 RL00001	AA00767 RL00001	AA00767 RL00001	AA00767 RL00001
			SD00002		SD00002		SD00002		SD00002		
9908370			9908370	9908370	9908370	9908370	9908370	9908370	9908370	9908370	9908370

SCOOTER 50cc



MALAGUTI	MBK	MBK	MBK
YESTERDAY	BOOSTER	BOOSTER	BOOSTER
97-00	90-91	90-04	92-94
50cc 2T AC	50cc 2T AC	50cc 2T AC	50cc 2T AC
CY	CW	CW	CW

IT	EN	FR					
ALBERO MOTORE Con Cuscinetti e Paraoli	CRANKSHAFT with bearings and oil seals	VILEBREQUIN doté de Paliers et Joints d'huile		IM07059	IM07058	IM07058	IM07058
ALBERO MOTORE Senza Cuscinetti e Paraoli	CRANKSHAFT without bearings and oil seals	VILEBREQUIN sans Paliers et Joints d'huile		IM07014	IM07013	IM07013	IM07013
ACCENSIONE Fissa	IGNITION UNIT Fixed	ALLUMAGE Fixe			9910100	9910100	9910100
ACCENSIONE Variabile	IGNITION UNIT Variable	ALLUMAGE Variable			9909230	9909230	9909230
ACCENSIONE Digitale	DIGITAL IGNITION UNIT	ALLUMAGE Numérique					
BIELLA	CONROD	BIELLE		IM07032	IM07032	IM07032	IM07032
CAMPANA FRIZIONE	CLUTCH HOUSING	CLOCHE EMBRAYAGE		9924940			
CINGHIA DI TRASMISSIONE TOP PERFORMANCES	TRANSMISSION BELT TOP PERFORMANCES	COURROIE DE TRANSMISSION TOP PERFORMANCES		9907900	9907770	9907770	9907770
CINGHIA DI TRASMISSIONE Mitsuboshi	TRANSMISSION BELT Mitsuboshi	COURROIE DE TRANSMISSION Mitsuboshi		9935340	9935270	9935270	9935270
COLLETTORE ASPIRAZIONE	INLET MANIFOLD	COLLECTEUR ASPIRATION		CT00725	CT00726	CT00726	CT00726
CONVERTITORE DI COPPIA	TORQUE CONVERTER	CONVERTISSEUR DE COUPLE		9923030	9923030	9923030	9923030
FRIZIONE CENTRIFUGA Ø 105	CENTRIFUGAL CLUTCH Ø 105	EMBAYAGE CENTRIFUGE Ø 105		9911060	9911060	9911060	9911060
FRIZIONE CENTRIFUGA Ø 107	CENTRIFUGAL CLUTCH Ø 107	EMBAYAGE CENTRIFUGE Ø 107		9910020 9925130	9910020 9925130	9910020 9925130	9910020 9925130
GANASCE FRENO	BRAKE SHOES	MÂCHOIRES FREIN					
GRUPPO TERMICO Ø Standard c/testa	CYLINDER KIT Ø standard with head	CYLINDRE COMPLET Ø Standard avec culasse		9931140	9931170	9931170	9931170
GRUPPO TERMICO Ø Standard s/testa	CYLINDER KIT Ø standard without head	CYLINDRE COMPLET Ø Standard sans culasse		KT00095	KT00096	KT00096	KT00096
GRUPPO TERMICO Ø Magg. c/testa	CYLINDER KIT BIG BORE with head	CYLINDRE COMPLET Ø Majoré avec culasse		9931340 KT00087	9931370 KT00088	9931370 KT00088	9931370 KT00088
GRUPPO TERMICO Ø Magg. s/testa	CYLINDER KIT BIG BORE without head	CYLINDRE COMPLET Ø Majoré sans culasse					
GRUPPO TERMICO Modifica da AC a LC	CYLINDER KIT Conversion AC to LC	CYLINDRE COMPLET Modification de AC à LC		9911090			
KIT CUSCINETTI DA BANCO	BEARINGS KIT	KIT PALIERS DE VILEBREQUIN		KK01000 KK01002	KK01000 KK01002	KK01000 KK01002	KK01000 KK01002
KIT REVISIONE POMPA ACQUA	WATER PUMP REPAIR KIT	KIT RÉVISION POMPE À EAU					
MEMBRANA CARBURATORE	CARBURETOR DIAPHRAGM	MEMBRANE CARBURATEUR					
MOTORINO D'AVVIAMENTO	STARTER ENGINE	DÉMARREUR ÉLECTRIQUE		MA00001	MA00001	MA00001	MA00001
PULEGGIA FISSA	VARIATOR SHEAVE FIXED	POULIE FIXE		PL04055 PL04056			
RAPPORTI ALLUNGATI Primari	GEARS KIT Primary	RAPPORTS ALLONGÉS Primaires			9913300	9913300	9913300
RAPPORTI ALLUNGATI Secondari	GEARS KIT Secondary	RAPPORTS ALLONGÉS Secondaires					
REGOLATORE DI TENSIONE	RECTIFIER	RÉGULATEUR DE TENSION		RE00014	RE00014	RE00014	RE00014
RUOTA LIBERA	STARTER CLUTCH	ROUE LIBRE		AA00767 RL00001	AA00767 RL00001	AA00767 RL00001	AA00767 RL00001
STATORE	STATOR	STATOR		SD00002			
VALVOLA LAMELLARE	REED VALVE	CLAPET À LAMELLES		9908370	9906520	9906520	9906520

MBK	MBK	MBK	MBK	MBK	MBK	MBK	MBK	MBK	MBK	MBK	MBK
BOOSTER EURO 2	BOOSTER NG	BOOSTER NG	BOOSTER ROCKET	BOOSTER ROCKET	BOOSTER ROCKET	BOOSTER SPIRIT	BOOSTER SPIRIT	BOOSTER SPIRIT	BOOSTER SPIRIT	BOOSTER SPIRIT EURO2	BOOSTER TRACK
04-04	95-03	03-03	97-98	97-98	97-98	96-98	99-00	00-00	03-03	03-03	96-98
50cc 2T AC	50cc 2T AC	50cc 2T AC	50cc 2T AC	50cc 2T AC	50cc 2T AC	50cc 2T AC	50cc 2T AC	50cc 2T AC	50cc 2T AC	50cc 2T AC	50cc 2T AC
CW	CW	CW	CW	CW	CW	CW	CW	CW	CW	CW	CW
IM07058	IM07058	IM07058	IM07058			IM07058	IM07058	IM07058	IM07058	IM07058	IM07058
IM07013	IM07013	IM07013	IM07013			IM07013	IM07013	IM07013	IM07013	IM07013	IM07013
	9910100		9910100			9910100	9910100	9910100			9910100
	9909230		9909230			9909230	9909230	9909230			9909230
9921790		9921790							9921790	9921790	
IM07032	IM07032	IM07032	IM07032			IM07032	IM07032	IM07032	IM07032	IM07032	IM07032
9907770	9907770	9907770	9907770			9907770	9907770	9907770	9907770	9907770	9907770
9935270	9935270	9935270	9935270			9935270	9935270	9935270	9935270	9935270	9935270
CT00726	CT00726	CT00726	CT00726			CT00726	CT00726	CT00726	CT00726	CT00726	CT00726
9923030	9923030	9923030	9923030			9923030	9923030	9923030	9923030	9923030	9923030
9911060	9911060	9911060	9911060			9911060	9911060	9911060	9911060	9911060	9911060
9910020 9925130	9910020 9925130	9910020 9925130	9910020 9925130			9910020 9925130	9910020 9925130	9910020 9925130	9910020 9925130	9910020 9925130	9910020 9925130
9931170	9931170	9931170	9931170			9931170	9931170	9931170	9931170	9931170	9931170
KT00096	KT00096	KT00096	KT00096			KT00096	KT00096	KT00096	KT00096	KT00096	KT00096
9931370 KT00088	9931370 KT00088	9931370 KT00088	9931370 KT00088			9931370 KT00088	9931370 KT00088	9931370 KT00088	9931370 KT00088	9931370 KT00088	9931370 KT00088
KK01000 KK01002	KK01000 KK01002	KK01000 KK01002	KK01000 KK01002			KK01000 KK01002	KK01000 KK01002	KK01000 KK01002	KK01000 KK01002	KK01000 KK01002	KK01000 KK01002
MA00001	MA00001	MA00001	MA00001			MA00001	MA00001	MA00001	MA00001	MA00001	MA00001
PL04055 PL04056		PL04055 PL04056	PL04055 PL04056	PL04055 PL04056	PL04055 PL04056		PL04055 PL04056		PL04055 PL04056		
9913300	9913300	9913300	9913300			9913300	9913300	9913300	9913300	9913300	9913300
	9909520	9909520									
RE00015	RE00014	RE00015	RE00014			RE00014	RE00014	RE00014	RE00015	RE00015	RE00014
AA00767 RL00001	AA00767 RL00001	AA00767 RL00001	AA00767 RL00001			AA00767 RL00001	AA00767 RL00001	AA00767 RL00001	AA00767 RL00001	AA00767 RL00001	AA00767 RL00001
9906520	9906520	9906520	9906520			9906520	9906520	9906520	9906520	9906520	9906520

SCOOTER 50cc

SCOOTER 50cc



MBK	MBK	MBK	MBK
BOOSTER X IE	EVOLIS	FIZZ	FLIPPER
08-08	92-95	94-95	98-04
50cc 4T-3V LC	50cc 2T AC	50cc 2T AC	50cc 2T AC
15P1	CY	CY	MY

IT	EN	FR					
ALBERO MOTORE Con Cuscinetti e Paraoli	CRANKSHAFT with bearings and oil seals	VILEBREQUIN doté de Paliers et Joints d'huile			IM07059	IM07059	IM07059
ALBERO MOTORE Senza Cuscinetti e Paraoli	CRANKSHAFT without bearings and oil seals	VILEBREQUIN sans Paliers et Joints d'huile			IM07014	IM07014	IM07014
ACCENSIONE Fissa	IGNITION UNIT Fixed	ALLUMAGE Fixe			9910100	9910100	9910100
ACCENSIONE Variabile	IGNITION UNIT Variable	ALLUMAGE Variable			9909230	9909230	9909230
ACCENSIONE Digitale	DIGITAL IGNITION UNIT	ALLUMAGE Numérique					
BIELLA	CONROD	BIELLE			IM07032	IM07032	IM07032
CAMPANA FRIZIONE	CLUTCH HOUSING	CLOCHE EMBRAYAGE			9924940	9924940	9924940
CINGHIA DI TRASMISSIONE TOP PERFORMANCES	TRANSMISSION BELT TOP PERFORMANCES	COURROIE DE TRANSMISSION TOP PERFORMANCES			9907900	9907900	9907770
CINGHIA DI TRASMISSIONE Mitsuboshi	TRANSMISSION BELT Mitsuboshi	COURROIE DE TRANSMISSION Mitsuboshi			9935340	9935340	9935270
COLLETTORE ASPIRAZIONE	INLET MANIFOLD	COLLECTEUR ASPIRATION			CT00725	CT00725	CT00725
CONVERTITORE DI COPPIA	TORQUE CONVERTER	CONVERTISSEUR DE COUPLE			9923030	9923030	9923030
FRIZIONE CENTRIFUGA Ø 105	CENTRIFUGAL CLUTCH Ø 105	EMBAYAGE CENTRIFUGE Ø 105					9911060
FRIZIONE CENTRIFUGA Ø 107	CENTRIFUGAL CLUTCH Ø 107	EMBAYAGE CENTRIFUGE Ø 107			9925130	9925130	9910020 9925130
GANASCE FRENO	BRAKE SHOES	MÂCHOIRES FREIN					
GRUPPO TERMICO Ø Standard c/testa	CYLINDER KIT Ø standard with head	CYLINDRE COMPLET Ø Standard avec culasse			9931140	9931140	9931140
GRUPPO TERMICO Ø Standard s/testa	CYLINDER KIT Ø standard without head	CYLINDRE COMPLET Ø Standard sans culasse			KT00095	KT00095	KT00095
GRUPPO TERMICO Ø Magg. c/testa	CYLINDER KIT BIG BORE with head	CYLINDRE COMPLET Ø Majoré avec culasse			9931340 KT00087	9931340 KT00087	9931340 KT00087
GRUPPO TERMICO Ø Magg. s/testa	CYLINDER KIT BIG BORE without head	CYLINDRE COMPLET Ø Majoré sans culasse			9926330		
GRUPPO TERMICO Modifica da AC a LC	CYLINDER KIT Conversion AC to LC	CYLINDRE COMPLET Modification de AC à LC			9911090	9911090	9911090
KIT CUSCINETTI DA BANCO	BEARINGS KIT	KIT PALIERS DE VILEBREQUIN			KK01000 KK01002	KK01000 KK01002	KK01000 KK01002
KIT REVISIONE POMPA ACQUA	WATER PUMP REPAIR KIT	KIT RÉVISION POMPE À EAU					
MEMBRANA CARBURATORE	CARBURETOR DIAPHRAGM	MEMBRANE CARBURATEUR					
MOTORINO D'AVVIAMENTO	STARTER ENGINE	DÉMARREUR ÉLECTRIQUE			MA00001	MA00001	MA00001
PULEGGIA FISSA	VARIATOR SHEAVE FIXED	POULIE FIXE			PL04055 PL04056	PL04055 PL04056	PL04055 PL04056
RAPPORTI ALLUNGATI Primari	GEARS KIT Primary	RAPPORTS ALLONGÉS Primaires					9913300
RAPPORTI ALLUNGATI Secondari	GEARS KIT Secondary	RAPPORTS ALLONGÉS Secondaires					
REGOLATORE DI TENSIONE	RECTIFIER	RÉGULATEUR DE TENSION			RE00014	RE00014	RE00014
RUOTA LIBERA	STARTER CLUTCH	ROUE LIBRE			AA00767 RL00001	AA00767 RL00001	AA00767 RL00001
STATORE	STATOR	STATOR					
VALVOLA LAMELLARE	REED VALVE	CLAPET À LAMELLES			9908370	9908370	9908370

MBK	MBK	MBK	MBK	MBK	MBK	MBK	MBK	MBK	MBK	MBK	MBK
FLIPPER EURO 2	FORTE	MACH G	MACH G LC	NITRO	NITRO EURO 2	OVETTO	OVETTO 4T	OVETTO EURO 2	SORRISO	STUNT	TARGET
03-03	94-96	02-04	02-04	97-04	03-03	97-04	09-11	02-02	95-96	00-02	91-95
50cc 2T AC	50cc 2T AC	50cc 2T AC	50cc 2T LC	50cc 2T LC	50cc 2T LC	50cc 2T AC	50cc 4T-3V LC	50cc 2T AC	50cc 2T AC	50cc 2T AC	50cc 2T AC
MY	CY	MY	MA	MA	MA	MY	5C3	MY	Tipo CW	CW	Tipo CW
IM07059	IM07059	IM07059	IM07059	IM07059	IM07059	IM07059		IM07059		IM07058	
IM07014	IM07014	IM07014	IM07014	IM07014	IM07014	IM07014		IM07014		IM07013	
				9910100		9910100				9910100	
				9909230		9909230				9909230	
9921790		9921790	9921790		9921790			9921790			
IM07032	IM07032	IM07032	IM07032	IM07032	IM07032	IM07032		IM07032		IM07032	
9924940	9924940	9924940	9924940	9924940	9924940	9924940		9924940			
9907770	9907900	9907770	9907770	9907770	9907770	9907770		9907770		9907770	
9935270	9935340	9935270	9935270	9935270	9935270	9935270		9935270		9935270	
CT00725	CT00725	CT00725	CT00725	CT00725	CT00725	CT00725		CT00725		CT00726	
9923030	9923030	9923030	9923030	9923030	9923030	9923030		9923030		9923030	
9911060		9911060	9911060	9911060	9911060	9911060		9911060	9911060	9911060	9911060
9910020 9925130	9925130	9910020 9925130	9910020 9925130	9910020 9925130	9910020 9925130	9910020 9925130	9925130	9910020 9925130	9910020 9925130	9910020 9925130	9910020 9925130
9931140	9931140	9931140	9931110	9931110	9931110	9931140		9931140		9931170	
KT00095	KT00095	KT00095	KT00094	KT00094	KT00094	KT00095		KT00095		KT00096	
9931340 KT00087	9931340 KT00087	9931340 KT00087	9931310 KT00109	9931310 KT00109	9931310 KT00109	9931340 KT00087		9931340 KT00087		9931370 KT00088	
							9926330				
9911090	9911090	9911090				9911090		9911090			
KK01000 KK01002	KK01000 KK01002	KK01000 KK01002	KK01000 KK01002	KK01000 KK01002	KK01000 KK01002	KK01000 KK01002		KK01000 KK01002		KK01000 KK01002	
			AA00780 AA00785 AA00786	AA00787 AA00788	AA00780 AA00785 AA00786	AA00787 AA00788	AA00780 AA00785 AA00786	AA00787 AA00788			
MA00001	MA00001	MA00001	MA00001	MA00001	MA00001	MA00001		MA00001		MA00001	
PL04055 PL04056	PL04055 PL04056	PL04055 PL04056	PL04055 PL04056	PL04055 PL04056	PL04055 PL04056	PL04055 PL04056		PL04055 PL04056		PL04055 PL04056	
9913300		9913300	9913300	9913300	9913300	9913300		9913300		9913300	
			9909520	9909520	9909520					9909520	
RE00015	RE00014	RE00015	RE00015	RE00014	RE00015	RE00014		RE00015		RE00014	
AA00767 RL00001	AA00767 RL00001	AA00767 RL00001	AA00767 RL00001	AA00767 RL00001	AA00767 RL00001	AA00767 RL00001		AA00767 RL00001		AA00767 RL00001	
9908370	9908370	9908370	9908370	9908370	9908370	9908370		9908370		9906520	

SCOOTER 50cc



MOTRON	MOTRON	MOTRON	PEUGEOT
STING	SYNCRO	THUNDER	BUXY
95-96	98-00	95-98	90-02
50cc 2T AC	50cc 2T AC	50cc 2T AC	50cc 2T AC
CY	MY	MY	Motore Peugeot

IT	EN	FR					
ALBERO MOTORE Con Cuscinetti e Paraoli	CRANKSHAFT with bearings and oil seals	VILEBREQUIN doté de Paliers et Joints d'huile			IM07059	IM07059	IM07061
ALBERO MOTORE Senza Cuscinetti e Paraoli	CRANKSHAFT without bearings and oil seals	VILEBREQUIN sans Paliers et Joints d'huile			IM07014	IM07014	IM07016
ACCENSIONE Fissa	IGNITION UNIT Fixed	ALLUMAGE Fixe					
ACCENSIONE Variabile	IGNITION UNIT Variable	ALLUMAGE Variable					
ACCENSIONE Digitale	DIGITAL IGNITION UNIT	ALLUMAGE Numérique					
BIELLA	CONROD	BIELLE			IM07032	IM07032	
CAMPANA FRIZIONE	CLUTCH HOUSING	CLOCHE EMBRAYAGE			9924940	9924940	
CINGHIA DI TRASMISSIONE TOP PERFORMANCES	TRANSMISSION BELT TOP PERFORMANCES	COURROIE DE TRANSMISSION TOP PERFORMANCES			9907770	9907770	9910790
CINGHIA DI TRASMISSIONE Mitsuboshi	TRANSMISSION BELT Mitsuboshi	COURROIE DE TRANSMISSION Mitsuboshi			9935270	9935270	9935240 9935570
COLLETTORE ASPIRAZIONE	INLET MANIFOLD	COLLECTEUR ASPIRATION			CT00725	CT00725	
CONVERTITORE DI COPPIA	TORQUE CONVERTER	CONVERTISSEUR DE COUPLE			9923030	9923030	
FRIZIONE CENTRIFUGA Ø 105	CENTRIFUGAL CLUTCH Ø 105	EMBAYAGE CENTRIFUGE Ø 105			9911060	9911060	
FRIZIONE CENTRIFUGA Ø 107	CENTRIFUGAL CLUTCH Ø 107	EMBAYAGE CENTRIFUGE Ø 107			9910020 9925130	9910020 9925130	9910020
GANASCE FRENO	BRAKE SHOES	MÂCHOIRES FREIN					
GRUPPO TERMICO Ø Standard c/testa	CYLINDER KIT Ø standard with head	CYLINDRE COMPLET Ø Standard avec culasse			9931140	9931140	9924770
GRUPPO TERMICO Ø Standard s/testa	CYLINDER KIT Ø standard without head	CYLINDRE COMPLET Ø Standard sans culasse			KT00095	KT00095	KT00123
GRUPPO TERMICO Ø Magg. c/testa	CYLINDER KIT BIG BORE with head	CYLINDRE COMPLET Ø Majoré avec culasse			9931340 KT00087	9931340 KT00087	9908660
GRUPPO TERMICO Ø Magg. s/testa	CYLINDER KIT BIG BORE without head	CYLINDRE COMPLET Ø Majoré sans culasse					KT00058
GRUPPO TERMICO Modifica da AC a LC	CYLINDER KIT Conversion AC to LC	CYLINDRE COMPLET Modification de AC à LC			9911090	9911090	
KIT CUSCINETTI DA BANCO	BEARINGS KIT	KIT PALIERS DE VILEBREQUIN			KK01000 KK01002	KK01000 KK01002	KK01005
KIT REVISIONE POMPA ACQUA	WATER PUMP REPAIR KIT	KIT RÉVISION POMPE À EAU					
MEMBRANA CARBURATORE	CARBURETOR DIAPHRAGM	MEMBRANE CARBURATEUR					
MOTORINO D'AVVIAMENTO	STARTER ENGINE	DÉMARREUR ÉLECTRIQUE			MA00001	MA00001	MA00001 MA00019
PULEGGIA FISSA	VARIATOR SHEAVE FIXED	POULIE FIXE			PL04055 PL04056	PL04055 PL04056	
RAPPORTI ALLUNGATI Primari	GEARS KIT Primary	RAPPORTS ALLONGÉS Primaires				9913300	9913300
RAPPORTI ALLUNGATI Secondari	GEARS KIT Secondary	RAPPORTS ALLONGÉS Secondaires					
REGOLATORE DI TENSIONE	RECTIFIER	RÉGULATEUR DE TENSION					
RUOTA LIBERA	STARTER CLUTCH	ROUE LIBRE			AA00767 RL00001	AA00767 RL00001	
STATORE	STATOR	STATOR			SD00002	SD00002	
VALVOLA LAMELLARE	REED VALVE	CLAPET À LAMELLES			9908370	9908370	9912550

PEUGEOT	PEUGEOT	PEUGEOT	PEUGEOT	PEUGEOT	PEUGEOT	PEUGEOT	PEUGEOT	PEUGEOT	PEUGEOT	PEUGEOT	PEUGEOT
BUXY RS	E-VIVACITY (EC-45 KM/H)	ELYSEO	JET C-TECH	JET FORCE	KISBEE	LOOXOR	LUDIX	LUDIX BLASTER	METAL X	METROPOLIS	RAPIDO
90-02	16-16	90-02	90-02	90-02	00-00	90-02	90-02	90-02	90-02	90-02	90-02
50cc 2T AC	50cc	50cc 2T AC	50cc 2T LC	50cc 2T LC	50cc 2T AC	50cc 2T AC	50cc 2T AC	50cc 2T LC	50cc 2T AC	50cc 2T AC	50cc 2T AC
Motore Peugeot		Motore Peugeot	Motore Peugeot	Motore Peugeot	Motore Peugeot	Motore Peugeot	Motore Peugeot	Motore Peugeot	Motore Peugeot	Motore Peugeot	Motore Peugeot
IM07061		IM07061				IM07061			IM07061		
IM07016		IM07016				IM07016			IM07016		
9910790		9910790		9910790			9910790				
9935240 9935570	9935420	9935240 9935570		9935240 9935570	9935370		9935240 9935370 9935570				
			CT00741	CT00741			CT00741	CT00741			
9910020		9910020		9910020		9910020			9910020		
9924770		9924770				9924770	9925830		9924770		
KT00123		KT00123				KT00123			KT00123		
9908660		9908660				9908660	9925800		9908660		
KT00058		KT00058				KT00058			KT00058		
KK01005											
		MA00019			MA00019	MA00019	MA00019		MA00019		
9912550		9912550				9912550			9912550	9912550	9912550

SCOOTER 50cc

SCOOTER 50cc



PEUGEOT	PEUGEOT	PEUGEOT	PEUGEOT
SPEEDAKE	SPEEDFIGHT	SPEEDFIGHT 3	SPEEDFIGHT LC
90-02	97-04	09-14	97-04
50cc 2T AC	50cc 2T AC	50cc 2T AC	50cc 2T LC
Motore Peugeot	Motore Peugeot	Motore Peugeot	Motore Peugeot
IM07061	IM07061		IM07061
IM07016	IM07016		IM07016
9910790	9910790		9910790
9935240 9935570	9935240 9935570		9935240 9935570
9924770	9924770 KT00119	9925830	KT00119
KT00123	KT00123		
9908660	9908660 KT00116	9925800	9919540 KT00116
KT00058	KT00058		
		KK01005	KK01005
MA00019	MA00019	MA00019	MA00019
9912550	9912550		9912550

IT	EN	FR
ALBERO MOTORE Con Cuscinetti e Paraoli	CRANKSHAFT with bearings and oil seals	VILEBREQUIN doté de Paliers et Joints d'huile
ALBERO MOTORE Senza Cuscinetti e Paraoli	CRANKSHAFT without bearings and oil seals	VILEBREQUIN sans Paliers et Joints d'huile
ACCENSIONE Fissa	IGNITION UNIT Fixed	ALLUMAGE Fixe
ACCENSIONE Variabile	IGNITION UNIT Variable	ALLUMAGE Variable
ACCENSIONE Digitale	DIGITAL IGNITION UNIT	ALLUMAGE Numérique
BIELLA	CONROD	BIELLE
CAMPANA FRIZIONE	CLUTCH HOUSING	CLOCHE EMBRAYAGE
CINGHIA DI TRASMISSIONE TOP PERFORMANCES	TRANSMISSION BELT TOP PERFORMANCES	COURROIE DE TRANSMISSION TOP PERFORMANCES
CINGHIA DI TRASMISSIONE Mitsuboshi	TRANSMISSION BELT Mitsuboshi	COURROIE DE TRANSMISSION Mitsuboshi
COLLETTORE ASPIRAZIONE	INLET MANIFOLD	COLLECTEUR ASPIRATION
CONVERTITORE DI COPPIA	TORQUE CONVERTER	CONVERTISSEUR DE COUPLE
FRIZIONE CENTRIFUGA Ø 105	CENTRIFUGAL CLUTCH Ø 105	EMBAYAGE CENTRIFUGE Ø 105
FRIZIONE CENTRIFUGA Ø 107	CENTRIFUGAL CLUTCH Ø 107	EMBAYAGE CENTRIFUGE Ø 107
GANASCE FRENO	BRAKE SHOES	MÂCHOIRES FREIN
GRUPPO TERMICO Ø Standard c/testa	CYLINDER KIT Ø standard with head	CYLINDRE COMPLET Ø Standard avec culasse
GRUPPO TERMICO Ø Standard s/testa	CYLINDER KIT Ø standard without head	CYLINDRE COMPLET Ø Standard sans culasse
GRUPPO TERMICO Ø Magg. c/testa	CYLINDER KIT BIG BORE with head	CYLINDRE COMPLET Ø Majoré avec culasse
GRUPPO TERMICO Ø Magg. s/testa	CYLINDER KIT BIG BORE without head	CYLINDRE COMPLET Ø Majoré sans culasse
GRUPPO TERMICO Modifica da AC a LC	CYLINDER KIT Conversion AC to LC	CYLINDRE COMPLET Modification de AC à LC
KIT CUSCINETTI DA BANCO	BEARINGS KIT	KIT PALIERS DE VILEBREQUIN
KIT REVISIONE POMPA ACQUA	WATER PUMP REPAIR KIT	KIT RÉVISION POMPE À EAU
MEMBRANA CARBURATORE	CARBURETOR DIAPHRAGM	MEMBRANE CARBURATEUR
MOTORINO D'AVVIAMENTO	STARTER ENGINE	DÉMARREUR ÉLECTRIQUE
PULEGGIA FISSA	VARIATOR SHEAVE FIXED	POULIE FIXE
RAPPORTI ALLUNGATI Primari	GEARS KIT Primary	RAPPORTS ALLONGÉS Primaires
RAPPORTI ALLUNGATI Secondari	GEARS KIT Secondary	RAPPORTS ALLONGÉS Secondaires
REGOLATORE DI TENSIONE	RECTIFIER	RÉGULATEUR DE TENSION
RUOTA LIBERA	STARTER CLUTCH	ROUE LIBRE
STATORE	STATOR	STATOR
VALVOLA LAMELLARE	REED VALVE	CLAPET À LAMELLES

PEUGEOT	PEUGEOT	PEUGEOT	PEUGEOT	PEUGEOT	PEUGEOT	PEUGEOT	PEUGEOT	PEUGEOT	PEUGEOT	PGO	PIAGGIO	PIAGGIO
SQUAB	ST	SV GEO	TREKKER	V-CLIC	VIVACITY	X-FIGHT	X-FIGHT LC	ZENITH	BIG MAX	DIESIS	FLY 2T	
90-02	90-02	90-02	90-02	90-02	90-02	00-02	00-02	90-02	95-97	01-01	05-07	
50cc 2T AC	50cc 2T AC	50cc 2T AC	50cc 2T AC	50cc 4T AC	50cc 2T AC	50cc 2T AC	50cc 2T LC	50cc 2T AC	50cc 2T AC	50cc 2T AC	50cc 2T AC	
Motore Peugeot	Motore Peugeot	Motore Peugeot	Motore Peugeot	Tipo Kymco	Motore Peugeot	Motore Peugeot	Motore Peugeot	Motore Peugeot	Tipo MY	Motore Piaggio	Motore Piaggio	
IM07061		IM07061	IM07061		IM07061	IM07061	IM07061	IM07061		IM07060	IM07060	
IM07016		IM07016	IM07016		IM07016	IM07016	IM07016	IM07016		IM07015	IM07015	
										IM07031	IM07031	
										9924950	9924950	
9910790			9910790		9910790	9910790				9922030		
9935240 9935570			9935240 9935570		9935240 9935570	9935240 9935570				9935830	9935420	
										CT00727	CT00727	
										9923150	9923150	
9910020		9910020	9910020		9910020	9910020		9910020		9910020	9910020	
9924770		9924770	9924770		9924770	9924770	KT00119	9924770	9931140	9914500	9914500	
KT00123		KT00123	KT00123		KT00123	KT00123	KT00123	KT00123	KT00095	KT00080	KT00080	
9908660		9908660	9908660		9908660	9908660	9919540 KT00116	9908660	9931340 KT00087	9931250 KT00086	9931250 KT00086	
KT00058		KT00058	KT00058	9925140 KT00132	KT00058	KT00058	KT00058	KT00058				
			KK01005						KK01000 KK01002	KK01003 KK01009	KK01003 KK01009	
MA00019			MA00019		MA00019	MA00019	MA00019	MA00019		MA00002	MA00002	
										PL04058	PL04058	
										RE00012	RE00012	
										RL00040	RL00040	
9912550	9912550	9912550	9912550		9912550	9912550	9912550	9912550		9910930	9910930	

SCOOTER 50cc

SCOOTER 50cc



PIAGGIO	PIAGGIO	PIAGGIO	PIAGGIO
FLY 2T	FLY 4T	FLY 4T & 25-30 KM/H	FLY 4T 2V
10-11	05-07	08-11	13-15
50cc 2T AC	50cc 4T AC	50cc 4T AC	50cc 4T AC
Motore Piaggio	Motore Piaggio	Motore Piaggio	Motore Piaggio

IT	EN	FR				
ALBERO MOTORE Con Cuscinetti e Paraoli	CRANKSHAFT with bearings and oil seals	VILEBREQUIN doté de Paliers et Joints d'huile		IM07060		
ALBERO MOTORE Senza Cuscinetti e Paraoli	CRANKSHAFT without bearings and oil seals	VILEBREQUIN sans Paliers et Joints d'huile		IM07015	IM07073	IM07073
ACCENSIONE Fissa	IGNITION UNIT Fixed	ALLUMAGE Fixe				
ACCENSIONE Variabile	IGNITION UNIT Variable	ALLUMAGE Variable				
ACCENSIONE Digitale	DIGITAL IGNITION UNIT	ALLUMAGE Numérique			9926150	9926150
BIELLA	CONROD	BIELLE		IM07031		
CAMPANA FRIZIONE	CLUTCH HOUSING	CLOCHE EMBRAYAGE		9924950		
CINGHIA DI TRASMISSIONE TOP PERFORMANCES	TRANSMISSION BELT TOP PERFORMANCES	COURROIE DE TRANSMISSION TOP PERFORMANCES				
CINGHIA DI TRASMISSIONE Mitsuboshi	TRANSMISSION BELT Mitsuboshi	COURROIE DE TRANSMISSION Mitsuboshi		9935420	9935480	9935480
COLLETTORE ASPIRAZIONE	INLET MANIFOLD	COLLECTEUR ASPIRATION		CT00727	CT00737	CT00737
CONVERTITORE DI COPPIA	TORQUE CONVERTER	CONVERTISSEUR DE COUPLE		9923150	9923150	9923150
FRIZIONE CENTRIFUGA Ø 105	CENTRIFUGAL CLUTCH Ø 105	EMBAYAGE CENTRIFUGE Ø 105				
FRIZIONE CENTRIFUGA Ø 107	CENTRIFUGAL CLUTCH Ø 107	EMBAYAGE CENTRIFUGE Ø 107		9910020	9910020	9910020
GANASCE FRENO	BRAKE SHOES	MÂCHOIRES FREIN				
GRUPPO TERMICO Ø Standard c/testa	CYLINDER KIT Ø standard with head	CYLINDRE COMPLET Ø Standard avec culasse		9914500		
GRUPPO TERMICO Ø Standard s/testa	CYLINDER KIT Ø standard without head	CYLINDRE COMPLET Ø Standard sans culasse		KT00080		
GRUPPO TERMICO Ø Magg. c/testa	CYLINDER KIT BIG BORE with head	CYLINDRE COMPLET Ø Majoré avec culasse		9931250 KT00086		
GRUPPO TERMICO Ø Magg. s/testa	CYLINDER KIT BIG BORE without head	CYLINDRE COMPLET Ø Majoré sans culasse			9925150 KT00133	9925150 KT00133
GRUPPO TERMICO Modifica da AC a LC	CYLINDER KIT Conversion AC to LC	CYLINDRE COMPLET Modification de AC à LC				
KIT CUSCINETTI DA BANCO	BEARINGS KIT	KIT PALIERS DE VILEBREQUIN		KK01003 KK01009		
KIT REVISIONE POMPA ACQUA	WATER PUMP REPAIR KIT	KIT RÉVISION POMPE À EAU				
MEMBRANA CARBURATORE	CARBURETOR DIAPHRAGM	MEMBRANE CARBURATEUR				
MOTORINO D'AVVIAMENTO	STARTER ENGINE	DÉMARREUR ÉLECTRIQUE		MA00002	MA00015	MA00015
PULEGGIA FISSA	VARIATOR SHEAVE FIXED	POULIE FIXE		PL04058	PL04058	PL04058
RAPPORTI ALLUNGATI Primari	GEARS KIT Primary	RAPPORTS ALLONGÉS Primaires				
RAPPORTI ALLUNGATI Secondari	GEARS KIT Secondary	RAPPORTS ALLONGÉS Secondaires				
REGOLATORE DI TENSIONE	RECTIFIER	RÉGULATEUR DE TENSION		RE00012	RE00018	
RUOTA LIBERA	STARTER CLUTCH	ROUE LIBRE		RL00040	RL00039	RL00039
STATORE	STATOR	STATOR			ST00004	ST00004
VALVOLA LAMELLARE	REED VALVE	CLAPET À LAMELLES		9910930		

PIAGGIO	PIAGGIO	PIAGGIO	PIAGGIO	PIAGGIO	PIAGGIO	PIAGGIO	PIAGGIO	PIAGGIO	PIAGGIO	PIAGGIO	PIAGGIO
FLY 4T 2V 25-30KM/H	FLY 4T 4V	FLY 4T MOTO- RE CHN	FREE	FREE DELIVERY	FREE FL	LIBERTY	LIBERTY 2T	LIBERTY 2T	LIBERTY 2T PTT EU2	LIBERTY 2T RST	LIBERTY 2T SPORT
12-17	12-13	06-07	92-94	00-01	95-02	97-05	06-06	07-08	04-05	04-04	06-06
50cc 4T AC	50cc 4T-4V AC	50cc 4T AC	50cc 2T AC	50cc 2T AC	50cc 2T AC	50cc 2T AC	50cc 2T AC	50cc 2T AC	50cc 2T AC	50cc 2T AC	50cc 2T AC
Motore Piaggio	Motore Piaggio	Motore Piaggio	Motore Piaggio	Motore Piaggio	Motore Piaggio	Motore Piaggio	Motore Piaggio	Motore Piaggio	Motore Piaggio	Motore Piaggio	Motore Piaggio
			IM07060	IM07060	IM07060	IM07060	IM07060	IM07060	IM07060	IM07060	IM07060
IM07073	IM07073	IM07073	IM07015	IM07015	IM07015	IM07015	IM07015	IM07015	IM07015	IM07015	IM07015
			9924870	9924870	9924870	9924870					
			9924880	9924880	9924880	9924880					
		9926150									
			IM07031	IM07031	IM07031	IM07031	IM07031	IM07031	IM07031	IM07031	IM07031
			9924950	9924950	9924950	9924950	9924950	9924950	9924950	9924950	9924950
			9913280	9922030	9913280						
9935480	9935480	9935480	9935800	9935830	9935800	9935420	9935420	9935420	9935420	9935420	9935420
		CT00737	CT00727	CT00727	CT00727	CT00727	CT00727	CT00727	CT00727	CT00727	CT00727
		9923150	9923150	9923150	9923150	9923150	9923150	9923150	9923150	9923150	9923150
		9910020	9910020	9910020		9910020	9910020	9910020	9910020	9910020	9910020
			9914500	9914500	9914500	9914500	9914500	9914500	9914500	9914500	9914500
			KT00080	KT00080	KT00080	KT00080	KT00080	KT00080	KT00080	KT00080	KT00080
			9931250 KT00086	9931250 KT00086	9931250 KT00086	9931250 KT00086	9931250 KT00086	9931250 KT00086	9931250 KT00086	9931250 KT00086	9931250 KT00086
		9925150 KT00133									
			KK01003 KK01009	KK01003 KK01009	KK01003 KK01009	KK01003 KK01009	KK01003 KK01009	KK01003 KK01009	KK01003 KK01009	KK01003 KK01009	KK01003 KK01009
		MA00015	MA00002	MA00002	MA00002	MA00002	MA00002	MA00002	MA00002	MA00002	MA00002
PL04058	PL04058	PL04058	PL04058	PL04058	PL04058	PL04058	PL04058	PL04058	PL04058	PL04058	PL04058
		RE00018		RE00012		RE00012	RE00012	RE00012	RE00012	RE00012	RE00012
		RL00039	RL00040	RL00040	RL00040	RL00040	RL00040	RL00040	RL00040	RL00040	RL00040
		ST00004									
			9910930	9910930	9910930	9910930	9910930	9910930	9910930	9910930	9910930

SCOOTER 50cc

SCOOTER 50cc



PIAGGIO	PIAGGIO	PIAGGIO	PIAGGIO
LIBERTY 2T SPORT	LIBERTY 4T	LIBERTY 4T	LIBERTY 4T 3V 25 KM/H
07-08	00-02	05-08	16-16
50cc 2T AC	50cc 4T AC	50cc 4T AC	50cc 4T-3V AC
Motore Piaggio	Motore Piaggio	Motore Piaggio	Motore Piaggio

IT	EN	FR
----	----	----

ALBERO MOTORE Con Cuscinetti e Paraoli	CRANKSHAFT with bearings and oil seals	VILEBREQUIN doté de Paliers et Joints d'huile		IM07060			
ALBERO MOTORE Senza Cuscinetti e Paraoli	CRANKSHAFT without bearings and oil seals	VILEBREQUIN sans Paliers et Joints d'huile		IM07015	IM07073	IM07073	IM07073
ACCENSIONE Fissa	IGNITION UNIT Fixed	ALLUMAGE Fixe					
ACCENSIONE Variabile	IGNITION UNIT Variable	ALLUMAGE Variable					
ACCENSIONE Digitale	DIGITAL IGNITION UNIT	ALLUMAGE Numérique			9926150	9926150	
BIELLA	CONROD	BIELLE		IM07031			
CAMPANA FRIZIONE	CLUTCH HOUSING	CLOCHE EMBRAYAGE		9924950			
CINGHIA DI TRASMISSIONE TOP PERFORMANCES	TRANSMISSION BELT TOP PERFORMANCES	COURROIE DE TRANSMISSION TOP PERFORMANCES					
CINGHIA DI TRASMISSIONE Mitsuboshi	TRANSMISSION BELT Mitsuboshi	COURROIE DE TRANSMISSION Mitsuboshi		9935420	9935420	9935420	9935420
COLLETTORE ASPIRAZIONE	INLET MANIFOLD	COLLECTEUR ASPIRATION		CT00727	CT00738	CT00737	
CONVERTITORE DI COPPIA	TORQUE CONVERTER	CONVERTISSEUR DE COUPLE		9923150	9923150	9923150	
FRIZIONE CENTRIFUGA Ø 105	CENTRIFUGAL CLUTCH Ø 105	EMBAYAGE CENTRIFUGE Ø 105					
FRIZIONE CENTRIFUGA Ø 107	CENTRIFUGAL CLUTCH Ø 107	EMBAYAGE CENTRIFUGE Ø 107		9910020	9910020	9910020	
GANASCE FRENO	BRAKE SHOES	MÂCHOIRES FREIN					
GRUPPO TERMICO Ø Standard c/testa	CYLINDER KIT Ø standard with head	CYLINDRE COMPLET Ø Standard avec culasse		9914500			
GRUPPO TERMICO Ø Standard s/testa	CYLINDER KIT Ø standard without head	CYLINDRE COMPLET Ø Standard sans culasse		KT00080			
GRUPPO TERMICO Ø Magg. c/testa	CYLINDER KIT BIG BORE with head	CYLINDRE COMPLET Ø Majoré avec culasse		9931250 KT00086			
GRUPPO TERMICO Ø Magg. s/testa	CYLINDER KIT BIG BORE without head	CYLINDRE COMPLET Ø Majoré sans culasse			9925150 KT00133	9925150 KT00133	
GRUPPO TERMICO Modifica da AC a LC	CYLINDER KIT Conversion AC to LC	CYLINDRE COMPLET Modification de AC à LC					
KIT CUSCINETTI DA BANCO	BEARINGS KIT	KIT PALIERS DE VILEBREQUIN		KK01003 KK01009			
KIT REVISIONE POMPA ACQUA	WATER PUMP REPAIR KIT	KIT RÉVISION POMPE À EAU					
MEMBRANA CARBURATORE	CARBURETOR DIAPHRAGM	MEMBRANE CARBURATEUR					
MOTORINO D'AVVIAMENTO	STARTER ENGINE	DÉMARREUR ÉLECTRIQUE		MA00002	MA00015	MA00015	
PULEGGIA FISSA	VARIATOR SHEAVE FIXED	POULIE FIXE		PL04058	PL04058	PL04058	PL04058
RAPPORTI ALLUNGATI Primari	GEARS KIT Primary	RAPPORTS ALLONGÉS Primaires					
RAPPORTI ALLUNGATI Secondari	GEARS KIT Secondary	RAPPORTS ALLONGÉS Secondaires					
REGOLATORE DI TENSIONE	RECTIFIER	RÉGULATEUR DE TENSION		RE00012	RE00018	RE00018	
RUOTA LIBERA	STARTER CLUTCH	ROUE LIBRE		RL00040	RL00039	RL00039	
STATORE	STATOR	STATOR			ST00004	ST00004	
VALVOLA LAMELLARE	REED VALVE	CLAPET À LAMELLES		9910930			

PIAGGIO	PIAGGIO	PIAGGIO	PIAGGIO	PIAGGIO	PIAGGIO	PIAGGIO	PIAGGIO	PIAGGIO	PIAGGIO	PIAGGIO	PIAGGIO	PIAGGIO
LIBERTY 4T 3V IE	LIBERTY 4T 3V IE E4	LIBERTY 4T DELIVERY - SINGLE	LIBERTY 4T DELIVERY TNT	LIBERTY 4T IGET CORPORATE E4	LIBERTY 4T PTT (DEU)	LIBERTY 4T PTT - DOUBLE - NEXIVE	LIBERTY 4T RST	LIBERTY 4T SPORT	LIBERTY 4T SPORT	LIBERTY IGET 4T 3V 25KM/H	LIBERTY IGET 4T 3V IE	
15-17	17-18	10-14	09-09	18-18	07-12	09-17	04-04	06-06	07-08	16-16	15-17	
50cc 4T-3V AC	50cc 4T-3V AC	50cc 4T AC	50cc 4T AC	50cc 4T-3V AC	50cc 4T AC	50cc 4T AC	50cc 4T AC	50cc 4T AC	50cc 4T AC	50cc 4T-3V AC	50cc 4T-3V AC	
Motore Piaggio	Motore Piaggio	Motore Piaggio	Motore Piaggio	Motore Piaggio	Motore Piaggio	Motore Piaggio	Motore Piaggio	Motore Piaggio	Motore Piaggio	Motore Piaggio	Motore Piaggio	
IM07073	IM07073	IM07073	IM07073		IM07073	IM07073	IM07073	IM07073	IM07073	IM07073	IM07073	IM07073
		9926150	9926150			9926150	9926150	9926150	9926150	9926150		
9924950	9924950											
9935420	9935420	9935420	9935420	9935420	9935420	9935420	9935420	9935420	9935420	9935420	9935420	9935420
		CT00737	CT00737			CT00737	CT00738	CT00737	CT00737	CT00737		
		9923150	9923150			9923150	9923150	9923150	9923150	9923150		
9910020	9910020	9910020	9910020	9910020		9910020	9910020	9910020	9910020	9910020		
		9925150 KT00133	9925150 KT00133			9925150 KT00133	9925150 KT00133	9925150 KT00133	9925150 KT00133	9925150 KT00133		
		MA00015	MA00015			MA00015	MA00015	MA00015	MA00015	MA00015		
PL04058	PL04058	PL04058	PL04058		PL04058	PL04058	PL04058	PL04058	PL04058	PL04058	PL04058	PL04058
		RE00018	RE00018			RE00018	RE00018	RE00018	RE00018	RE00018		
RL00039	RL00039	RL00039	RL00039			RL00039	RL00039	RL00039	RL00039	RL00039		
ST00004	ST00004	ST00004	ST00004			ST00004	ST00004	ST00004	ST00004	ST00004		

SCOOTER 50cc

SCOOTER 50cc



PIAGGIO	PIAGGIO	PIAGGIO	PIAGGIO
LIBERTY IGET 4T 3V IE E4 EMEA	LIBERTY IGET 4T 3V IE E4 EMEA 25KM/H	LIBERTY MOC 2T & ELLE	LIBERTY MOC 4T & ELLE
17-18	18-18	09-13	09-16
50cc 4T-3V AC	50cc 4T-3V AC	50cc 2T AC	50cc 4T AC
Motore Piaggio	Motore Piaggio	Motore Piaggio	Motore Piaggio

IT	EN	FR				
ALBERO MOTORE Con Cuscinetti e Paraoli	CRANKSHAFT with bearings and oil seals	VILEBREQUIN doté de Paliers et Joints d'huile				
ALBERO MOTORE Senza Cuscinetti e Paraoli	CRANKSHAFT without bearings and oil seals	VILEBREQUIN sans Paliers et Joints d'huile				
ACCENSIONE Fissa	IGNITION UNIT Fixed	ALLUMAGE Fixe				
ACCENSIONE Variabile	IGNITION UNIT Variable	ALLUMAGE Variable				
ACCENSIONE Digitale	DIGITAL IGNITION UNIT	ALLUMAGE Numérique				
BIELLA	CONROD	BIELLE				
CAMPANA FRIZIONE	CLUTCH HOUSING	CLOCHE EMBRAYAGE				
CINGHIA DI TRASMISSIONE TOP PERFORMANCES	TRANSMISSION BELT TOP PERFORMANCES	COURROIE DE TRANSMISSION TOP PERFORMANCES				
CINGHIA DI TRASMISSIONE Mitsubishi	TRANSMISSION BELT Mitsubishi	COURROIE DE TRANSMISSION Mitsubishi				
COLLETTORE ASPIRAZIONE	INLET MANIFOLD	COLLECTEUR ASPIRATION				
CONVERTITORE DI COPPIA	TORQUE CONVERTER	CONVERTISSEUR DE COUPLE				
FRIZIONE CENTRIFUGA Ø 105	CENTRIFUGAL CLUTCH Ø 105	EMBAYAGE CENTRIFUGE Ø 105				
FRIZIONE CENTRIFUGA Ø 107	CENTRIFUGAL CLUTCH Ø 107	EMBAYAGE CENTRIFUGE Ø 107				
GANASCE FRENO	BRAKE SHOES	MÂCHOIRES FREIN				
GRUPPO TERMICO Ø Standard c/testa	CYLINDER KIT Ø standard with head	CYLINDRE COMPLET Ø Standard avec culasse				
GRUPPO TERMICO Ø Standard s/testa	CYLINDER KIT Ø standard without head	CYLINDRE COMPLET Ø Standard sans culasse				
GRUPPO TERMICO Ø Magg. c/testa	CYLINDER KIT BIG BORE with head	CYLINDRE COMPLET Ø Majoré avec culasse				
GRUPPO TERMICO Ø Magg. s/testa	CYLINDER KIT BIG BORE without head	CYLINDRE COMPLET Ø Majoré sans culasse				
GRUPPO TERMICO Modifica da AC a LC	CYLINDER KIT Conversion AC to LC	CYLINDRE COMPLET Modification de AC à LC				
KIT CUSCINETTI DA BANCO	BEARINGS KIT	KIT PALIERS DE VILEBREQUIN				
KIT REVISIONE POMPA ACQUA	WATER PUMP REPAIR KIT	KIT RÉVISION POMPE À EAU				
MEMBRANA CARBURATORE	CARBURETOR DIAPHRAGM	MEMBRANE CARBURATEUR				
MOTORINO D'AVVIAMENTO	STARTER ENGINE	DÉMARREUR ÉLECTRIQUE				
PULEGGIA FISSA	VARIATOR SHEAVE FIXED	POULIE FIXE				
RAPPORTI ALLUNGATI Primari	GEARS KIT Primary	RAPPORTS ALLONGÉS Primaires				
RAPPORTI ALLUNGATI Secondari	GEARS KIT Secondary	RAPPORTS ALLONGÉS Secondaires				
REGOLATORE DI TENSIONE	RECTIFIER	RÉGULATEUR DE TENSION				
RUOTA LIBERA	STARTER CLUTCH	ROUE LIBRE				
STATORE	STATOR	STATOR				
VALVOLA LAMELLARE	REED VALVE	CLAPET À LAMELLES				

PIAGGIO	PIAGGIO	PIAGGIO	PIAGGIO	PIAGGIO	PIAGGIO	PIAGGIO	PIAGGIO	PIAGGIO	PIAGGIO	PIAGGIO	PIAGGIO
NRG	NRG EXTREME LC	NRG MC3	NRG POWER DD	NRG POWER DD	NRG POWER DD	NRG POWER DD SERIE SPECIALE	NRG POWER DT	NRG POWER DT	NRG POWER DT SERIE SPECIALE	NRG POWER PUREJET	NRG POWER PUREJET
94-96	99-00	01-04	05-05	06-06	07-17	07-12	06-06	07-15	07-08	04-05	06-06
50cc 2T LC	50cc 2T LC	50cc 2T LC	50cc 2T LC	50cc 2T LC	50cc 2T LC	50cc 2T LC	50cc 2T AC	50cc 2T AC	50cc 2T AC	50cc 2T-IE LC	50cc 2T-IE LC
Motore Piaggio	Motore Piaggio	Motore Piaggio	Motore Piaggio	Motore Piaggio	Motore Piaggio	Motore Piaggio	Motore Piaggio	Motore Piaggio	Motore Piaggio	Motore Piaggio	Motore Piaggio
IM07060	IM07060	IM07060	IM07060	IM07060	IM07060	IM07060	IM07060	IM07060	IM07060		
IM07015	IM07015	IM07015	IM07015	IM07015	IM07015	IM07015	IM07015	IM07015	IM07015	IM07064	IM07064
	9924870	9924870									
	9924880	9924880									
IM07031	IM07031	IM07031	IM07031	IM07031	IM07031	IM07031	IM07031	IM07031	IM07031		
9924950	9924950	9924950	9924950	9924950	9924950	9924950	9924950	9924950	9924950	9924950	9924950
9913280		9922030	9922030	9922030	9922030	9922030	9922030	9922030	9922030		
9935800		9935830	9935830	9935830	9935830	9935830	9935830	9935830	9935830		
CT00727	CT00727	CT00727	CT00727	CT00727	CT00727	CT00727	CT00727	CT00727	CT00727		
9923150	9923150	9923150	9923150	9923150	9923150	9923150	9923150	9923150	9923150	9923150	9923150
9910020							9910020	9910020	9910020		
9916580 KT00112	9916580 KT00112	9916580 KT00112	9916580 KT00112	9916580 KT00112	9916580 KT00112	9916580 KT00112	9914500	9914500	9914500	9916580 KT00112	9916580 KT00112
							KT00080	KT00080	KT00080		
9931270 KT00097	9931270 KT00097	9931270 KT00097	9931270 KT00097	9931270 KT00097	9931270 KT00097	9931270 KT00097	9931250 KT00086	9931250 KT00086	9931250 KT00086	9931270 KT00097	9931270 KT00097
KK01003 KK01009	KK01003 KK01009	KK01003 KK01009	KK01003 KK01009	KK01003 KK01009	KK01003 KK01009	KK01003 KK01009	KK01003 KK01009	KK01003 KK01009	KK01003 KK01009	KK01003 KK01009	KK01003 KK01009
AA00796	AA00796	AA00796	AA00796	AA00796	AA00796	AA00796				AA00796	AA00796
MA00002	MA00002	MA00002	MA00002	MA00002	MA00002	MA00002	MA00002	MA00002	MA00002	MA00015	MA00015
PL04058	PL04058	PL04058	PL04058	PL04058	PL04058	PL04058	PL04058	PL04058	PL04058	PL04058	PL04058
	RE00012	RE00012	RE00012	RE00012	RE00012	RE00012	RE00012	RE00012	RE00012		
RL00040	RL00040	RL00040	RL00040	RL00040	RL00040	RL00040	RL00040	RL00040	RL00040	RL00039	RL00039
9910930	9910930	9910930	9910930	9910930	9910930	9910930	9910930	9910930	9910930	9910930	9910930



PIAGGIO	PIAGGIO	PIAGGIO	PIAGGIO
NRG POWER PUREJET	NRG POWER PUREJET	NRG PUREJET	NRG PUREJET
07-09	10-11	02-04	10-10
50cc 2T-IE LC	50cc 2T-IE LC	50cc 2T-IE LC	50cc 2T-IE LC
Motore Piaggio	Motore Piaggio	Motore Piaggio	Motore Piaggio

IT	EN	FR				
ALBERO MOTORE Con Cuscinetti e Paraoli	CRANKSHAFT with bearings and oil seals	VILEBREQUIN doté de Paliers et Joints d'huile				
ALBERO MOTORE Senza Cuscinetti e Paraoli	CRANKSHAFT without bearings and oil seals	VILEBREQUIN sans Paliers et Joints d'huile		IM07064	IM07064	IM07064
ACCENSIONE Fissa	IGNITION UNIT Fixed	ALLUMAGE Fixe				
ACCENSIONE Variabile	IGNITION UNIT Variable	ALLUMAGE Variable				
ACCENSIONE Digitale	DIGITAL IGNITION UNIT	ALLUMAGE Numérique				
BIELLA	CONROD	BIELLE				
CAMPANA FRIZIONE	CLUTCH HOUSING	CLOCHE EMBRAYAGE		9924950	9924950	9924950
CINGHIA DI TRASMISSIONE TOP PERFORMANCES	TRANSMISSION BELT TOP PERFORMANCES	COURROIE DE TRANSMISSION TOP PERFORMANCES				9922030
CINGHIA DI TRASMISSIONE Mitsuboshi	TRANSMISSION BELT Mitsuboshi	COURROIE DE TRANSMISSION Mitsuboshi				9935830
COLLETTORE ASPIRAZIONE	INLET MANIFOLD	COLLECTEUR ASPIRATION				
CONVERTITORE DI COPPIA	TORQUE CONVERTER	CONVERTISSEUR DE COUPLE		9923150	9923150	9923150
FRIZIONE CENTRIFUGA Ø 105	CENTRIFUGAL CLUTCH Ø 105	EMBAYAGE CENTRIFUGE Ø 105				
FRIZIONE CENTRIFUGA Ø 107	CENTRIFUGAL CLUTCH Ø 107	EMBAYAGE CENTRIFUGE Ø 107				
GANASCE FRENO	BRAKE SHOES	MÂCHOIRES FREIN				
GRUPPO TERMICO Ø Standard c/testa	CYLINDER KIT Ø standard with head	CYLINDRE COMPLET Ø Standard avec culasse		9916580 KT00112	9916580 KT00112	9916580 KT00112
GRUPPO TERMICO Ø Standard s/testa	CYLINDER KIT Ø standard without head	CYLINDRE COMPLET Ø Standard sans culasse				
GRUPPO TERMICO Ø Magg. c/testa	CYLINDER KIT BIG BORE with head	CYLINDRE COMPLET Ø Majoré avec culasse		9931270 KT00097	9931270 KT00097	9931270 KT00097
GRUPPO TERMICO Ø Magg. s/testa	CYLINDER KIT BIG BORE without head	CYLINDRE COMPLET Ø Majoré sans culasse				
GRUPPO TERMICO Modifica da AC a LC	CYLINDER KIT Conversion AC to LC	CYLINDRE COMPLET Modification de AC à LC				
KIT CUSCINETTI DA BANCO	BEARINGS KIT	KIT PALIERS DE VILEBREQUIN		KK01003 KK01009	KK01003 KK01009	KK01003 KK01009
KIT REVISIONE POMPA ACQUA	WATER PUMP REPAIR KIT	KIT RÉVISION POMPE À EAU		AA00796	AA00796	AA00796
MEMBRANA CARBURATORE	CARBURETOR DIAPHRAGM	MEMBRANE CARBURATEUR				
MOTORINO D'AVVIAMENTO	STARTER ENGINE	DÉMARREUR ÉLECTRIQUE		MA00015	MA00015	MA00015
PULEGGIA FISSA	VARIATOR SHEAVE FIXED	POULIE FIXE		PL04058	PL04058	PL04058
RAPPORTI ALLUNGATI Primari	GEARS KIT Primary	RAPPORTS ALLONGÉS Primaires				
RAPPORTI ALLUNGATI Secondari	GEARS KIT Secondary	RAPPORTS ALLONGÉS Secondaires				
REGOLATORE DI TENSIONE	RECTIFIER	RÉGULATEUR DE TENSION				
RUOTA LIBERA	STARTER CLUTCH	ROUE LIBRE		RL00039	RL00039	RL00039
STATORE	STATOR	STATOR				
VALVOLA LAMELLARE	REED VALVE	CLAPET À LAMELLES		9910930	9910930	9910930

PIAGGIO	PIAGGIO	PIAGGIO	PIAGGIO	PIAGGIO	PIAGGIO	PIAGGIO	PIAGGIO	PIAGGIO	PIAGGIO	PIAGGIO	PIAGGIO
NRG RST MC2	NTT	QUARTZ	SFERA	SFERA MAQUILLAGE 2	SFERA RST	TYPHOON	TYPHOON	TYPHOON	TYPHOON 2T E2	TYPHOON 2T E3 CH	TYPHOON 2T EURO4
96-98	95-96	92-96	91-93	94-94	95-97	01-04	05-08	09-11	10-12	11-11	18-18
50cc 2T LC	50cc 2T LC	50cc 2T LC	50cc 2T AC	50cc 2T AC	50cc 2T AC	50cc 2T AC	50cc 2T AC	50cc 2T AC	50cc 2T AC	50cc 2T AC	50cc 4T-3V AC
Motore Piaggio	Motore Piaggio	Motore Piaggio	Motore Piaggio	Motore Piaggio	Motore Piaggio	Motore Piaggio	Motore Piaggio	Motore Piaggio	Motore Piaggio	Motore Piaggio	Motore Piaggio
IM07060	IM07060	IM07060	IM07060	IM07060	IM07060	IM07060	IM07060	IM07060	IM07060	IM07060	
IM07015	IM07015	IM07015	IM07015	IM07015	IM07015	IM07015	IM07015	IM07015	IM07015	IM07015	
9924870	9924870	9924870	9924870	9924870	9924870						
9924880	9924880	9924880	9924880	9924880	9924880						
IM07031	IM07031	IM07031	IM07031	IM07031	IM07031	IM07031	IM07031	IM07031	IM07031	IM07031	
9924950	9924950	9924950	9924950	9924950	9924950	9924950	9924950	9924950	9924950	9924950	
9913280	9913280	9913350	9913360		9913350	9922030	9922030	9922030			
9935800	9935800	9935810		9935810	9935810	9935830	9935830	9935830	9935420	9935420	9935420
CT00727	CT00727	CT00727	CT00727	CT00727	CT00727	CT00727	CT00727	CT00727	CT00727	CT00727	
9923150	9923150	9923150	9923150	9923150	9923150	9923150	9923150	9923150	9923150	9923150	
9910020	9910020	9910020	9910020	9910020	9910020				9910020	9910020	
9916580 KT00112	9916580 KT00112	9916580 KT00112	9914500	9914500	9914500	9914500	9914500	9914500	9914500	9914500	
			KT00080	KT00080	KT00080	KT00080	KT00080	KT00080	KT00080	KT00080	
9931270 KT00097	9931270 KT00097	9931270 KT00097	9931250 KT00086	9931250 KT00086	9931250 KT00086	9931250 KT00086	9931250 KT00086	9931250 KT00086	9931250 KT00086	9931250 KT00086	
KK01003 KK01009	KK01003 KK01009	KK01003 KK01009	KK01003 KK01009	KK01003 KK01009	KK01003 KK01009	KK01003 KK01009	KK01003 KK01009	KK01003 KK01009	KK01003 KK01009	KK01003 KK01009	
AA00796	AA00796	AA00796									
MA00002	MA00002	MA00002	MA00002	MA00002	MA00002	MA00002	MA00002	MA00002	MA00002	MA00002	
PL04058	PL04058	PL04058	PL04058	PL04058	PL04058	PL04058	PL04058	PL04058	PL04058	PL04058	
						RE00012	RE00012	RE00012	RE00012	RE00012	
RL00040	RL00040	RL00040	RL00040	RL00040	RL00040	RL00040	RL00040	RL00040	RL00040	RL00040	
9910930	9910930	9910930	9910930	9910930	9910930	9910930	9910930	9910930	9910930	9910930	

SCOOTER 50cc

SCOOTER 50cc



PIAGGIO	PIAGGIO	PIAGGIO	PIAGGIO
VESPA ET2	VESPA ET2	VESPA ET2 INIEZIONE	VESPA ET4
97-98	98-05	97-00	00-05
50cc 2T AC	50cc 2T AC	50cc 2T AC	50cc 4T AC
Motore Piaggio	Motore Piaggio	Motore Piaggio	Motore Piaggio

IT	EN	FR
ALBERO MOTORE Con Cuscinetti e Paraoli	CRANKSHAFT with bearings and oil seals	VILEBREQUIN doté de Paliers et Joints d'huile
ALBERO MOTORE Senza Cuscinetti e Paraoli	CRANKSHAFT without bearings and oil seals	VILEBREQUIN sans Paliers et Joints d'huile
ACCENSIONE Fissa	IGNITION UNIT Fixed	ALLUMAGE Fixe
ACCENSIONE Variabile	IGNITION UNIT Variable	ALLUMAGE Variable
ACCENSIONE Digitale	DIGITAL IGNITION UNIT	ALLUMAGE Numérique
BIELLA	CONROD	BIELLE
CAMPANA FRIZIONE	CLUTCH HOUSING	CLOCHE EMBRAYAGE
CINGHIA DI TRASMISSIONE TOP PERFORMANCES	TRANSMISSION BELT TOP PERFORMANCES	COURROIE DE TRANSMISSION TOP PERFORMANCES
CINGHIA DI TRASMISSIONE Mitsuboshi	TRANSMISSION BELT Mitsuboshi	COURROIE DE TRANSMISSION Mitsuboshi
COLLETTORE ASPIRAZIONE	INLET MANIFOLD	COLLECTEUR ASPIRATION
CONVERTITORE DI COPPIA	TORQUE CONVERTER	CONVERTISSEUR DE COUPLE
FRIZIONE CENTRIFUGA Ø 105	CENTRIFUGAL CLUTCH Ø 105	EMBAYAGE CENTRIFUGE Ø 105
FRIZIONE CENTRIFUGA Ø 107	CENTRIFUGAL CLUTCH Ø 107	EMBAYAGE CENTRIFUGE Ø 107
GANASCE FRENO	BRAKE SHOES	MÂCHOIRES FREIN
GRUPPO TERMICO Ø Standard c/testa	CYLINDER KIT Ø standard with head	CYLINDRE COMPLET Ø Standard avec culasse
GRUPPO TERMICO Ø Standard s/testa	CYLINDER KIT Ø standard without head	CYLINDRE COMPLET Ø Standard sans culasse
GRUPPO TERMICO Ø Magg. c/testa	CYLINDER KIT BIG BORE with head	CYLINDRE COMPLET Ø Majoré avec culasse
GRUPPO TERMICO Ø Magg. s/testa	CYLINDER KIT BIG BORE without head	CYLINDRE COMPLET Ø Majoré sans culasse
GRUPPO TERMICO Modifica da AC a LC	CYLINDER KIT Conversion AC to LC	CYLINDRE COMPLET Modification de AC à LC
KIT CUSCINETTI DA BANCO	BEARINGS KIT	KIT PALIERS DE VILEBREQUIN
KIT REVISIONE POMPA ACQUA	WATER PUMP REPAIR KIT	KIT RÉVISION POMPE À EAU
MEMBRANA CARBURATORE	CARBURETOR DIAPHRAGM	MEMBRANE CARBURATEUR
MOTORINO D'AVVIAMENTO	STARTER ENGINE	DÉMARREUR ÉLECTRIQUE
PULEGGIA FISSA	VARIATOR SHEAVE FIXED	POULIE FIXE
RAPPORTI ALLUNGATI Primari	GEARS KIT Primary	RAPPORTS ALLONGÉS Primaires
RAPPORTI ALLUNGATI Secondari	GEARS KIT Secondary	RAPPORTS ALLONGÉS Secondaires
REGOLATORE DI TENSIONE	RECTIFIER	RÉGULATEUR DE TENSION
RUOTA LIBERA	STARTER CLUTCH	ROUE LIBRE
STATORE	STATOR	STATOR
VALVOLA LAMELLARE	REED VALVE	CLAPET À LAMELLES



PIAGGIO	PIAGGIO	PIAGGIO	PIAGGIO	PIAGGIO	PIAGGIO	PIAGGIO	PIAGGIO	PIAGGIO	PIAGGIO	PIAGGIO	PIAGGIO
VESPA LX 2T	VESPA LX 2T	VESPA LX 2T TOURING & 30KM	VESPA LX 4T	VESPA LXV 2T	VESPA LXV 2T NAVY	VESPA S 2T & COLLEGE	ZIP	ZIP	ZIP 2T	ZIP 4T	ZIP 4T
05-08	09-13	10-13	05-09	06-09	08-08	07-12	92-93	95-96	08-13	00-05	06-13
50cc 2T AC	50cc 2T AC	50cc 2T AC	50cc 4T AC	50cc 2T AC	50cc 2T AC	50cc 2T AC	50cc 2T AC	50cc 2T AC	50cc 2T LC	50cc 4T AC	50cc 4T AC
Motore Piaggio	Motore Piaggio	Motore Piaggio	Motore Piaggio	Motore Piaggio	Motore Piaggio	Motore Piaggio	Motore Piaggio	Motore Piaggio	Motore Piaggio	Motore Piaggio	Motore Piaggio
IM07060	IM07060	IM07060		IM07060	IM07060	IM07060	IM07060	IM07060	IM07060		
IM07015	IM07015	IM07015	IM07073	IM07015	IM07015	IM07015	IM07015	IM07015	IM07015	IM07073	IM07073
							9924870	9924870			
							9924880	9924880			
			9926150							9926150	9926150
IM07031	IM07031	IM07031		IM07031	IM07031	IM07031	IM07031	IM07031	IM07031		
9924950	9924950	9924950		9924950	9924950	9924950	9924950	9924950	9924950		
9922040	9922040	9922040	9922040	9922040	9922040	9922040	9913360	9913350	9922040	9922040	9922040
9935840	9935840	9935840	9935840	9935840	9935840	9935840		9935810	9935840	9935840	9935840
CT00727	CT00727	CT00727	CT00737	CT00727	CT00727	CT00727	CT00727	CT00727	CT00727	CT00738	CT00737
9923150	9923150	9923150	9923150	9923150	9923150	9923150	9923150	9923150	9923150	9923150	9923150
							9910020	9910020		9910020	9910020
9914500	9914500	9914500		9914500	9914500	9914500	9914500	9914500	9916580 KT00112		
KT00080	KT00080	KT00080		KT00080	KT00080	KT00080	KT00080	KT00080			
9931250 KT00086	9931250 KT00086	9931250 KT00086		9931250 KT00086	9931250 KT00086	9931250 KT00086	9931250 KT00086	9931250 KT00086	9931270 KT00097		
			9925150 KT00133							9925150 KT00133	9925150 KT00133
KK01003 KK01009	KK01003 KK01009	KK01003 KK01009		KK01003 KK01009	KK01003 KK01009	KK01003 KK01009	KK01003 KK01009	KK01003 KK01009	KK01003 KK01009		
									AA00796		
MA00002		MA00002	MA00015	MA00002	MA00002	MA00002	MA00002	MA00002	MA00002	MA00015	MA00015
PL04058	PL04058	PL04058	PL04058	PL04058	PL04058	PL04058	PL04058	PL04058	PL04058	PL04058	PL04058
RE00012	RE00012		RE00018	RE00012	RE00012	RE00012			RE00012	RE00018	RE00018
RL00040		RL00040	RL00039	RL00040	RL00040	RL00040	RL00040	RL00040	RL00040	RL00039	RL00039
			ST00004							ST00004	ST00004
9910930	9910930	9910930		9910930	9910930	9910930	9910930	9910930	9910930		

SCOOTER 50cc



PIAGGIO	PIAGGIO	PIAGGIO	PIAGGIO
ZIP 4T 25KM/H	ZIP BIMODALE	ZIP FAST RIDER	ZIP FAST RIDER RST
06-16	94-97	93-94	96-97
50cc 4T AC	50cc 2T AC	50cc 2T AC	50cc 2T AC
Motore Piaggio	Motore Piaggio	Motore Piaggio	Motore Piaggio
	IM07060	IM07060	IM07060
	IM07073	IM07015	IM07015
	9924870	9924870	9924870
	9924880	9924880	9924880
	IM07031	IM07031	IM07031
	9924950	9924950	9924950
	9913350	9913350	9913350
	9935810	9935810	9935810
	CT00727	CT00727	CT00727
	9923150	9923150	9923150
	9910020	9910020	9910020
	9914500	9914500	9914500
	KT00080	KT00080	KT00080
	9931250 KT00086	9931250 KT00086	9931250 KT00086
	KK01003 KK01009	KK01003 KK01009	KK01003 KK01009
	MA00002	MA00002	MA00002
	PL04058	PL04058	PL04058
	RL00040	RL00040	RL00040
	9910930	9910930	9910930

IT	EN	FR
ALBERO MOTORE Con Cuscinetti e Paraoli	CRANKSHAFT with bearings and oil seals	VILEBREQUIN doté de Paliers et Joints d'huile
ALBERO MOTORE Senza Cuscinetti e Paraoli	CRANKSHAFT without bearings and oil seals	VILEBREQUIN sans Paliers et Joints d'huile
ACCENSIONE Fissa	IGNITION UNIT Fixed	ALLUMAGE Fixe
ACCENSIONE Variabile	IGNITION UNIT Variable	ALLUMAGE Variable
ACCENSIONE Digitale	DIGITAL IGNITION UNIT	ALLUMAGE Numérique
BIELLA	CONROD	BIELLE
CAMPANA FRIZIONE	CLUTCH HOUSING	CLOCHE EMBRAYAGE
CINGHIA DI TRASMISSIONE TOP PERFORMANCES	TRANSMISSION BELT TOP PERFORMANCES	COURROIE DE TRANSMISSION TOP PERFORMANCES
CINGHIA DI TRASMISSIONE Mitsuboshi	TRANSMISSION BELT Mitsuboshi	COURROIE DE TRANSMISSION Mitsuboshi
COLLETTORE ASPIRAZIONE	INLET MANIFOLD	COLLECTEUR ASPIRATION
CONVERTITORE DI COPPIA	TORQUE CONVERTER	CONVERTISSEUR DE COUPLE
FRIZIONE CENTRIFUGA Ø 105	CENTRIFUGAL CLUTCH Ø 105	EMBAYAGE CENTRIFUGE Ø 105
FRIZIONE CENTRIFUGA Ø 107	CENTRIFUGAL CLUTCH Ø 107	EMBAYAGE CENTRIFUGE Ø 107
GANASCE FRENO	BRAKE SHOES	MÂCHOIRES FREIN
GRUPPO TERMICO Ø Standard c/testa	CYLINDER KIT Ø standard with head	CYLINDRE COMPLET Ø Standard avec culasse
GRUPPO TERMICO Ø Standard s/testa	CYLINDER KIT Ø standard without head	CYLINDRE COMPLET Ø Standard sans culasse
GRUPPO TERMICO Ø Magg. c/testa	CYLINDER KIT BIG BORE with head	CYLINDRE COMPLET Ø Majoré avec culasse
GRUPPO TERMICO Ø Magg. s/testa	CYLINDER KIT BIG BORE without head	CYLINDRE COMPLET Ø Majoré sans culasse
GRUPPO TERMICO Modifica da AC a LC	CYLINDER KIT Conversion AC to LC	CYLINDRE COMPLET Modification de AC à LC
KIT CUSCINETTI DA BANCO	BEARINGS KIT	KIT PALIERS DE VILEBREQUIN
KIT REVISIONE POMPA ACQUA	WATER PUMP REPAIR KIT	KIT RÉVISION POMPE À EAU
MEMBRANA CARBURATORE	CARBURETOR DIAPHRAGM	MEMBRANE CARBURATEUR
MOTORINO D'AVVIAMENTO	STARTER ENGINE	DÉMARREUR ÉLECTRIQUE
PULEGGIA FISSA	VARIATOR SHEAVE FIXED	POULIE FIXE
RAPPORTI ALLUNGATI Primari	GEARS KIT Primary	RAPPORTS ALLONGÉS Primaires
RAPPORTI ALLUNGATI Secondari	GEARS KIT Secondary	RAPPORTS ALLONGÉS Secondaires
REGOLATORE DI TENSIONE	RECTIFIER	RÉGULATEUR DE TENSION
RUOTA LIBERA	STARTER CLUTCH	ROUE LIBRE
STATORE	STATOR	STATOR
VALVOLA LAMELLARE	REED VALVE	CLAPET À LAMELLES

PIAGGIO	PIAGGIO	PIAGGIO	PIAGGIO	PIAGGIO	RIEJU	RIEJU	RIEJU	RIEJU	RIEJU	SUZUKI	SUZUKI
ZIP LC	ZIP RST	ZIP SP	ZIP SP	ZIP SP EURO 2	FIRST	PACIFIC	PASEO	TOREO	WINDY	AH ADDRESS	AJ ZZ
00-04	96-99	96-00	01-04	06-13	95-98	07-08	07-08	07-08	95-98	92-95	95-97
50cc 2T LC	50cc 2T AC	50cc 2T LC	50cc 2T LC	50cc 2T LC	50cc 2T AC	50cc 4T AC	50cc 4T AC	50cc 4T AC	50cc 2T AC	50cc 2T AC	50cc 2T AC
Motore Piaggio	Motore Piaggio	Motore Piaggio	Motore Piaggio	Motore Piaggio	MY	Tipo Kymco	Tipo Kymco	Tipo Kymco	MY	Motore Suzuki	Motore Suzuki
IM07060	IM07060	IM07060	IM07060	IM07060	IM07059				IM07059		
IM07015	IM07015	IM07015	IM07015	IM07015	IM07014				IM07014		
	9924870	9924870									
	9924880	9924880									
IM07031	IM07031	IM07031	IM07031	IM07031	IM07032				IM07032		
9924950	9924950	9924950	9924950	9924950	9924940				9924940		
9922040	9913350	9913350	9922040	9922040	9907770				9907770		
9935840	9935810	9935810	9935840	9935840	9935270				9935270		
CT00727	CT00727	CT00727	CT00727	CT00727	CT00725				CT00725		
9923150	9923150	9923150	9923150	9923150	9923030				9923030		
					9911060				9911060		
	9910020	9910020			9910020 9925130				9910020 9925130		
9916580 KT00112	9914500	9916580 KT00112	9916580 KT00112	9916580 KT00112	9931140				9931140		
	KT00080				KT00095				KT00095		
9931270 KT00097	9931250 KT00086	9931270 KT00097	9931270 KT00097	9931270 KT00097	9931340 KT00087				9931340 KT00087		
						9925140 KT00132	9925140 KT00132	9925140 KT00132		KT00057	KT00057
					9911090				9911090		
KK01003 KK01009	KK01003 KK01009	KK01003 KK01009	KK01003 KK01009	KK01003 KK01009	KK01000 KK01002				KK01000 KK01002		
AA00796		AA00796	AA00796	AA00796							
MA00002	MA00015	MA00002	MA00002	MA00002	MA00001				MA00001		
PL04058	PL04058	PL04058	PL04058	PL04058	PL04055 PL04056				PL04055 PL04056		
					9913300				9913300		
RE00012			RE00012	RE00012							
RL00040	RL00039	RL00040	RL00040	RL00040	AA00767 RL00001				AA00767 RL00001		
9910930	9910930	9910930	9910930	9910930	9908370				9908370		

SCOOTER 50cc



SUZUKI	SUZUKI	SUZUKI	SUZUKI
AP	ESTILETE UF	KATANA K1-K4	KATANA V-Y
94-97	00-00	01-04	97-00
50cc 2T AC	50cc 2T AC	50cc 2T LC	50cc 2T AC
Motore Suzuki	Motore Suzuki	Motore Suzuki	Motore Suzuki

IT	EN	FR				
ALBERO MOTORE Con Cuscinetti e Paraoli	CRANKSHAFT with bearings and oil seals	VILEBREQUIN doté de Paliers et Joints d'huile				
ALBERO MOTORE Senza Cuscinetti e Paraoli	CRANKSHAFT without bearings and oil seals	VILEBREQUIN sans Paliers et Joints d'huile				
ACCENSIONE Fissa	IGNITION UNIT Fixed	ALLUMAGE Fixe				
ACCENSIONE Variabile	IGNITION UNIT Variable	ALLUMAGE Variable				
ACCENSIONE Digitale	DIGITAL IGNITION UNIT	ALLUMAGE Numérique				
BIELLA	CONROD	BIELLE				
CAMPANA FRIZIONE	CLUTCH HOUSING	CLOCHE EMBRAYAGE				
CINGHIA DI TRASMISSIONE TOP PERFORMANCES	TRANSMISSION BELT TOP PERFORMANCES	COURROIE DE TRANSMISSION TOP PERFORMANCES			9920440	9920440
CINGHIA DI TRASMISSIONE Mitsubishi	TRANSMISSION BELT Mitsubishi	COURROIE DE TRANSMISSION Mitsubishi		9935950	9935820	9935820 9935950
COLLETTORE ASPIRAZIONE	INLET MANIFOLD	COLLECTEUR ASPIRATION				
CONVERTITORE DI COPPIA	TORQUE CONVERTER	CONVERTISSEUR DE COUPLE				
FRIZIONE CENTRIFUGA Ø 105	CENTRIFUGAL CLUTCH Ø 105	EMBAYAGE CENTRIFUGE Ø 105				
FRIZIONE CENTRIFUGA Ø 107	CENTRIFUGAL CLUTCH Ø 107	EMBAYAGE CENTRIFUGE Ø 107				
GANASCE FRENO	BRAKE SHOES	MÂCHOIRES FREIN				
GRUPPO TERMICO Ø Standard c/testa	CYLINDER KIT Ø standard with head	CYLINDRE COMPLET Ø Standard avec culasse				
GRUPPO TERMICO Ø Standard s/testa	CYLINDER KIT Ø standard without head	CYLINDRE COMPLET Ø Standard sans culasse				
GRUPPO TERMICO Ø Magg. c/testa	CYLINDER KIT BIG BORE with head	CYLINDRE COMPLET Ø Majoré avec culasse				
GRUPPO TERMICO Ø Magg. s/testa	CYLINDER KIT BIG BORE without head	CYLINDRE COMPLET Ø Majoré sans culasse		KT00057		
GRUPPO TERMICO Modifica da AC a LC	CYLINDER KIT Conversion AC to LC	CYLINDRE COMPLET Modification de AC à LC				
KIT CUSCINETTI DA BANCO	BEARINGS KIT	KIT PALIERS DE VILEBREQUIN				
KIT REVISIONE POMPA ACQUA	WATER PUMP REPAIR KIT	KIT RÉVISION POMPE À EAU			AA00808 AA00809	
MEMBRANA CARBURATORE	CARBURETOR DIAPHRAGM	MEMBRANE CARBURATEUR				
MOTORINO D'AVVIAMENTO	STARTER ENGINE	DÉMARREUR ÉLECTRIQUE				
PULEGGIA FISSA	VARIATOR SHEAVE FIXED	POULIE FIXE				
RAPPORTI ALLUNGATI Primari	GEARS KIT Primary	RAPPORTS ALLONGÉS Primaires				
RAPPORTI ALLUNGATI Secondari	GEARS KIT Secondary	RAPPORTS ALLONGÉS Secondaires				
REGOLATORE DI TENSIONE	RECTIFIER	RÉGULATEUR DE TENSION				
RUOTA LIBERA	STARTER CLUTCH	ROUE LIBRE				
STATORE	STATOR	STATOR				
VALVOLA LAMELLARE	REED VALVE	CLAPET À LAMELLES				

SUZUKI	SUZUKI	SUZUKI	SYM	SYM	SYM	SYM	SYM	SYM	SYM	SYM	SYM
KATANA V-Y	STREET MAGIC	ZILLION UX	DD	FIDDLE	JET	JET	JUNGLE	JUNGLE	MASK	MASK	MASK EU2
97-00	98-98	99-99	02-02	99-99	99-99	99-01	99-99	99-00	00-01	00-01	03-04
50cc 2T LC	50cc 2T AC	50cc 2T LC	50cc 2T AC	50cc	50cc	50cc 2T AC	50cc	50cc 2T AC	50cc 2T	50cc 2T AC	50cc 2T AC
Motore Suzuki	Motore Suzuki	Motore Suzuki		A	A		A				
9920440		9920440									
9935820 9935950		9935820									
				CP00219	CP00219		CP00219		CP00219		
	KT00057										
AA00808		AA00809									
						MA00014		MA00014		MA00014	MA00014
						RE00013		RE00013		RE00013	
			9912550								

SCOOTER 50cc



SYM	SYM	SYM	SYM
MIO	RED DEVIL	RED DEVIL	SUPER FANCY
06-09	99-99	99-99	98-00
50cc 4T AC	50cc	50cc 2T AC	50cc 2T AC
	A		

IT	EN	FR				
ALBERO MOTORE Con Cuscinetti e Paraoli	CRANKSHAFT with bearings and oil seals	VILEBREQUIN doté de Paliers et Joints d'huile				
ALBERO MOTORE Senza Cuscinetti e Paraoli	CRANKSHAFT without bearings and oil seals	VILEBREQUIN sans Paliers et Joints d'huile				
ACCENSIONE Fissa	IGNITION UNIT Fixed	ALLUMAGE Fixe				
ACCENSIONE Variabile	IGNITION UNIT Variable	ALLUMAGE Variable				
ACCENSIONE Digitale	DIGITAL IGNITION UNIT	ALLUMAGE Numérique				
BIELLA	CONROD	BIELLE				
CAMPANA FRIZIONE	CLUTCH HOUSING	CLOCHE EMBRAYAGE				
CINGHIA DI TRASMISSIONE TOP PERFORMANCES	TRANSMISSION BELT TOP PERFORMANCES	COURROIE DE TRANSMISSION TOP PERFORMANCES				
CINGHIA DI TRASMISSIONE Mitsubishi	TRANSMISSION BELT Mitsubishi	COURROIE DE TRANSMISSION Mitsubishi				
COLLETTORE ASPIRAZIONE	INLET MANIFOLD	COLLECTEUR ASPIRATION				
CONVERTITORE DI COPPIA	TORQUE CONVERTER	CONVERTISSEUR DE COUPLE				
FRIZIONE CENTRIFUGA Ø 105	CENTRIFUGAL CLUTCH Ø 105	EMBAYAGE CENTRIFUGE Ø 105				
FRIZIONE CENTRIFUGA Ø 107	CENTRIFUGAL CLUTCH Ø 107	EMBAYAGE CENTRIFUGE Ø 107				
GANASCE FRENO	BRAKE SHOES	MÂCHOIRES FREIN			CP00219	
GRUPPO TERMICO Ø Standard c/testa	CYLINDER KIT Ø standard with head	CYLINDRE COMPLET Ø Standard avec culasse				
GRUPPO TERMICO Ø Standard s/testa	CYLINDER KIT Ø standard without head	CYLINDRE COMPLET Ø Standard sans culasse				
GRUPPO TERMICO Ø Magg. c/testa	CYLINDER KIT BIG BORE with head	CYLINDRE COMPLET Ø Majoré avec culasse				
GRUPPO TERMICO Ø Magg. s/testa	CYLINDER KIT BIG BORE without head	CYLINDRE COMPLET Ø Majoré sans culasse				
GRUPPO TERMICO Modifica da AC a LC	CYLINDER KIT Conversion AC to LC	CYLINDRE COMPLET Modification de AC à LC				
KIT CUSCINETTI DA BANCO	BEARINGS KIT	KIT PALIERS DE VILEBREQUIN				
KIT REVISIONE POMPA ACQUA	WATER PUMP REPAIR KIT	KIT RÉVISION POMPE À EAU				
MEMBRANA CARBURATORE	CARBURETOR DIAPHRAGM	MEMBRANE CARBURATEUR				
MOTORINO D'AVVIAMENTO	STARTER ENGINE	DÉMARREUR ÉLECTRIQUE		MA00024	MA00014	MA00014
PULEGGIA FISSA	VARIATOR SHEAVE FIXED	POULIE FIXE				
RAPPORTI ALLUNGATI Primari	GEARS KIT Primary	RAPPORTS ALLONGÉS Primaires				
RAPPORTI ALLUNGATI Secondari	GEARS KIT Secondary	RAPPORTS ALLONGÉS Secondaires				
REGOLATORE DI TENSIONE	RECTIFIER	RÉGULATEUR DE TENSION			RE00013	RE00013
RUOTA LIBERA	STARTER CLUTCH	ROUE LIBRE				
STATORE	STATOR	STATOR				
VALVOLA LAMELLARE	REED VALVE	CLAPET À LAMELLES				

SYM	SYM	SYM	SYM	SYM	VILLA	VILLA	WT MOTORS	YAMAHA	YAMAHA	YAMAHA	YAMAHA
SUPER FANCY	SYMPHONY EURO 2	SYMPHONY S	SYMPHONY SR	SYMPLY EURO 2	AX	GZ	BILBAO	AEROX	AEROX	AEROX	AEROX
99-99	09-09	10-10	10-10	07-08	93-93	93-93	11-15	97-12	01-02	04-04	05-05
50cc	50cc 4T AC	50cc 4T AC	50cc 4T AC	50cc 4T AC	50cc	50cc	50cc 4T AC	50cc 2T LC	50cc 2T LC	50cc 2T LC	50cc 2T LC
A				Tipo Kymco	A	A	Tipo Kymco	MA	MA	MA	MA
								IM07059	IM07059	IM07059	IM07059
								IM07014	IM07014	IM07014	IM07014
								9910100	9910100	9910100	9910100
								9909230	9909230	9909230	9909230
										9921790	9921790
								IM07032	IM07032	IM07032	IM07032
								9924940	9924940	9924940	9924940
	9920440							9907770	9907770	9907770	9907770
	9935820							9935270	9935270	9935270	9935270
								CT00725	CT00725	CT00725	CT00725
								9923030	9923030	9923030	9923030
								9911060	9911060	9911060	9911060
								9910020 9925130	9910020 9925130	9910020 9925130	9910020 9925130
CP00219					CP00219	CP00219					
								9931110	9931110	9931110	9931110
								KT00094	KT00094	KT00094	KT00094
								9931310 KT00109	9931310 KT00109	9931310 KT00109	9931310 KT00109
				9925140 KT00132			9925140 KT00132				
								KK01000 KK01002	KK01000 KK01002	KK01000 KK01002	KK01000 KK01002
								AA00780 AA00785 AA00786	AA00787 AA00788	AA00780 AA00785 AA00786	AA00787 AA00788
	MA00024	MA00024	MA00024					MA00001	MA00001	MA00001	MA00001
								PL04055 PL04056	PL04055 PL04056	PL04055 PL04056	PL04055 PL04056
								9913300	9913300	9913300	9913300
								9909520	9909520	9909520	9909520
								RE00014	RE00014	RE00014	RE00014
								AA00767 RL00001	AA00767 RL00001	AA00767 RL00001	AA00767 RL00001
								9908370	9908370	9908370	9908370

SCOOTER 50cc

SCOOTER 50cc



YAMAHA	YAMAHA	YAMAHA	YAMAHA
AEROX	AEROX	AEROX	AEROX
06-06	07-07	08-08	09-09
50cc 2T LC	50cc 2T LC	50cc 2T LC	50cc 2T LC
MA	MA	MA	MA
IM07059	IM07059	IM07059	IM07059
IM07014	IM07014	IM07014	IM07014
9910100	9910100	9910100	9910100
9909230	9909230	9909230	9909230
9921790	9921790	9921790	9921790
IM07032	IM07032	IM07032	IM07032
9924940	9924940	9924940	9924940
9907770	9907770	9907770	9907770
9935270	9935270	9935270	9935270
CT00725	CT00725	CT00725	CT00725
9923030	9923030	9923030	9923030
9911060	9911060	9911060	9911060
9910020 9925130	9910020 9925130	9910020 9925130	9910020 9925130
9931110	9931110	9931110	9931110
KT00094	KT00094	KT00094	KT00094
9931310 KT00109	9931310 KT00109	9931310 KT00109	9931310 KT00109
KK01000 KK01002	KK01000 KK01002	KK01000 KK01002	KK01000 KK01002
AA00780 AA00785 AA00786	AA00788 AA00797	AA00785 AA00786	AA00788 AA00797
AA00780 AA00785 AA00786	AA00788 AA00797	AA00785 AA00786	AA00788 AA00797
MA00001	MA00001	MA00001	MA00001
PL04055 PL04056	PL04055 PL04056	PL04055 PL04056	PL04055 PL04056
9913300	9913300	9913300	9913300
9909520	9909520	9909520	9909520
RE00014	RE00014	RE00014	RE00014
AA00767 RL00001	AA00767 RL00001	AA00767 RL00001	AA00767 RL00001
9908370	9908370	9908370	9908370

IT	EN	FR
ALBERO MOTORE Con Cuscinetti e Paraoli	CRANKSHAFT with bearings and oil seals	VILEBREQUIN doté de Paliers et Joints d'huile
ALBERO MOTORE Senza Cuscinetti e Paraoli	CRANKSHAFT without bearings and oil seals	VILEBREQUIN sans Paliers et Joints d'huile
ACCENSIONE Fissa	IGNITION UNIT Fixed	ALLUMAGE Fixe
ACCENSIONE Variabile	IGNITION UNIT Variable	ALLUMAGE Variable
ACCENSIONE Digitale	DIGITAL IGNITION UNIT	ALLUMAGE Numérique
BIELLA	CONROD	BIELLE
CAMPANA FRIZIONE	CLUTCH HOUSING	CLOCHE EMBRAYAGE
CINGHIA DI TRASMISSIONE TOP PERFORMANCES	TRANSMISSION BELT TOP PERFORMANCES	COURROIE DE TRANSMISSION TOP PERFORMANCES
CINGHIA DI TRASMISSIONE Mitsuboshi	TRANSMISSION BELT Mitsuboshi	COURROIE DE TRANSMISSION Mitsuboshi
COLLETTORE ASPIRAZIONE	INLET MANIFOLD	COLLECTEUR ASPIRATION
CONVERTITORE DI COPPIA	TORQUE CONVERTER	CONVERTISSEUR DE COUPLE
FRIZIONE CENTRIFUGA Ø 105	CENTRIFUGAL CLUTCH Ø 105	EMBAYAGE CENTRIFUGE Ø 105
FRIZIONE CENTRIFUGA Ø 107	CENTRIFUGAL CLUTCH Ø 107	EMBAYAGE CENTRIFUGE Ø 107
GANASCE FRENO	BRAKE SHOES	MÂCHOIRES FREIN
GRUPPO TERMICO Ø Standard c/testa	CYLINDER KIT Ø standard with head	CYLINDRE COMPLET Ø Standard avec culasse
GRUPPO TERMICO Ø Standard s/testa	CYLINDER KIT Ø standard without head	CYLINDRE COMPLET Ø Standard sans culasse
GRUPPO TERMICO Ø Magg. c/testa	CYLINDER KIT BIG BORE with head	CYLINDRE COMPLET Ø Majoré avec culasse
GRUPPO TERMICO Ø Magg. s/testa	CYLINDER KIT BIG BORE without head	CYLINDRE COMPLET Ø Majoré sans culasse
GRUPPO TERMICO Modifica da AC a LC	CYLINDER KIT Conversion AC to LC	CYLINDRE COMPLET Modification de AC à LC
KIT CUSCINETTI DA BANCO	BEARINGS KIT	KIT PALIERS DE VILEBREQUIN
KIT REVISIONE POMPA ACQUA	WATER PUMP REPAIR KIT	KIT RÉVISION POMPE À EAU
MEMBRANA CARBURATORE	CARBURETOR DIAPHRAGM	MEMBRANE CARBURATEUR
MOTORINO D'AVVIAMENTO	STARTER ENGINE	DÉMARREUR ÉLECTRIQUE
PULEGGIA FISSA	VARIATOR SHEAVE FIXED	POULIE FIXE
RAPPORTI ALLUNGATI Primari	GEARS KIT Primary	RAPPORTS ALLONGÉS Primaires
RAPPORTI ALLUNGATI Secondari	GEARS KIT Secondary	RAPPORTS ALLONGÉS Secondaires
REGOLATORE DI TENSIONE	RECTIFIER	RÉGULATEUR DE TENSION
RUOTA LIBERA	STARTER CLUTCH	ROUE LIBRE
STATORE	STATOR	STATOR
VALVOLA LAMELLARE	REED VALVE	CLAPET À LAMELLES

YAMAHA	YAMAHA	YAMAHA	YAMAHA	YAMAHA	YAMAHA	YAMAHA	YAMAHA	YAMAHA	YAMAHA	YAMAHA	YAMAHA
AEROX	AEROX	AEROX EURO 2	AEROX NAKED	AEROX R	AEROX R	AXIS	AXIS	BREEZE	BW'S	BW'S	BW'S
10-12	13-16	03-03	13-16	99-99	99-00	95-96	95-96	94-95	97-04	04-05	06-07
50cc 2T LC	50cc 2T LC	50cc 2T LC	50cc 2T LC	50cc 2T LC	50cc 2T LC	50cc	50cc 2T AC	50cc 2T AC	50cc 2T AC	50cc 2T AC	50cc 2T AC
MA	MA	MA	MA	MA	MA	A	CY	CY	CW	CW	CW
IM07059	IM07059	IM07059	IM07059	IM07059	IM07059		IM07059	IM07059	IM07058	IM07058	IM07058
IM07014	IM07014	IM07014	IM07014	IM07014	IM07014		IM07014	IM07014	IM07013	IM07013	IM07013
9910100	9910100		9910100	9910100	9910100		9910100	9910100	9910100		
9909230	9909230		9909230	9909230	9909230		9909230	9909230	9909230		
9921790	9921790	9921790	9921790							9921790	9921790
IM07032	IM07032	IM07032	IM07032	IM07032	IM07032		IM07032	IM07032	IM07032	IM07032	IM07032
9924940	9924940	9924940	9924940	9924940	9924940		9924940	9924940			
9907770	9907770	9907770	9907770	9907770	9907770		9907900	9907900	9907770	9907770	9907770
9935270	9935270	9935270	9935270	9935270	9935270		9935340	9935340	9935270	9935270	9935270
CT00725	CT00725	CT00725	CT00725	CT00725	CT00725		CT00725	CT00725	CT00726	CT00726	CT00726
9923030	9923030	9923030	9923030	9923030	9923030		9923030	9923030	9923030	9923030	9923030
9911060	9911060	9911060	9911060	9911060	9911060				9911060	9911060	9911060
9910020 9925130	9910020 9925130	9910020 9925130	9910020 9925130	9910020 9925130	9910020 9925130		9925130	9925130	9910020 9925130	9910020 9925130	9910020 9925130
							CP00219				
9931110	9931110	9931110	9931110	9931110	9931110		9931140	9931140	9931170	9931170	9931170
KT00094	KT00094	KT00094	KT00094	KT00094	KT00094		KT00095	KT00095	KT00096	KT00096	KT00096
9931310 KT00109	9931310 KT00109	9931310 KT00109	9931310 KT00109	9931310 KT00109	9931310 KT00109		9931340 KT00087	9931340 KT00087	9931370 KT00088	9931370 KT00088	9931370 KT00088
							9911090	9911090			
KK01000 KK01002	KK01000 KK01002	KK01000 KK01002	KK01000 KK01002	KK01000 KK01002	KK01000 KK01002		KK01000 KK01002	KK01000 KK01002	KK01000 KK01002	KK01000 KK01002	KK01000 KK01002
AA00780 AA00785 AA00786	AA00788 AA00785 AA00797	AA00780 AA00785 AA00786	AA00788 AA00785 AA00797	AA00780 AA00785 AA00786	AA00788 AA00785 AA00797	AA00780 AA00785 AA00786	AA00788 AA00785 AA00797	AA00780 AA00785 AA00786	AA00788 AA00785 AA00797	AA00780 AA00785 AA00786	AA00788 AA00785 AA00797
MA00001	MA00001	MA00001	MA00001	MA00001	MA00001		MA00001	MA00001	MA00001	MA00001	MA00001
PL04055 PL04056	PL04055 PL04056	PL04055 PL04056	PL04055 PL04056	PL04055 PL04056	PL04055 PL04056		PL04055 PL04056	PL04055 PL04056	PL04055 PL04056	PL04055 PL04056	PL04055 PL04056
9913300	9913300	9913300	9913300	9913300	9913300				9913300	9913300	9913300
9909520	9909520	9909520	9909520	9909520	9909520						
RE00014	RE00014	RE00015	RE00014	RE00014	RE00014		RE00014	RE00014	RE00014	RE00015	RE00015
AA00767 RL00001	AA00767 RL00001	AA00767 RL00001	AA00767 RL00001	AA00767 RL00001	AA00767 RL00001		AA00767 RL00001	AA00767 RL00001	AA00767 RL00001	AA00767 RL00001	AA00767 RL00001
9908370	9908370	9908370	9908370	9908370	9908370		9908370	9908370	9906520	9906520	9906520

SCOOTER 50cc



YAMAHA	YAMAHA	YAMAHA	YAMAHA
BW'S	BW'S	BW'S BUMP	BW'S EASY
08-12	13-16	97-98	13-13
50cc 2T AC	50cc 2T AC	50cc 2T AC	50cc 2T AC
CW	CW	CW	CW

IT	EN	FR					
ALBERO MOTORE Con Cuscinetti e Paraoli	CRANKSHAFT with bearings and oil seals	VILEBREQUIN doté de Paliers et Joints d'huile		IM07058	IM07058	IM07058	IM07058
ALBERO MOTORE Senza Cuscinetti e Paraoli	CRANKSHAFT without bearings and oil seals	VILEBREQUIN sans Paliers et Joints d'huile		IM07013	IM07013	IM07013	IM07013
ACCENSIONE Fissa	IGNITION UNIT Fixed	ALLUMAGE Fixe				9910100	
ACCENSIONE Variabile	IGNITION UNIT Variable	ALLUMAGE Variable				9909230	
ACCENSIONE Digitale	DIGITAL IGNITION UNIT	ALLUMAGE Numérique		9921790	9921790		9921790
BIELLA	CONROD	BIELLE		IM07032	IM07032	IM07032	IM07032
CAMPANA FRIZIONE	CLUTCH HOUSING	CLOCHE EMBRAYAGE					
CINGHIA DI TRASMISSIONE TOP PERFORMANCES	TRANSMISSION BELT TOP PERFORMANCES	COURROIE DE TRANSMISSION TOP PERFORMANCES		9907770	9907770	9907770	9907770
CINGHIA DI TRASMISSIONE Mitsuboshi	TRANSMISSION BELT Mitsuboshi	COURROIE DE TRANSMISSION Mitsuboshi		9935270	9935270	9935270	9935270
COLLETTORE ASPIRAZIONE	INLET MANIFOLD	COLLECTEUR ASPIRATION		CT00726	CT00726	CT00726	CT00726
CONVERTITORE DI COPPIA	TORQUE CONVERTER	CONVERTISSEUR DE COUPLE		9923030	9923030	9923030	9923030
FRIZIONE CENTRIFUGA Ø 105	CENTRIFUGAL CLUTCH Ø 105	EMBAYAGE CENTRIFUGE Ø 105		9911060	9911060	9911060	9911060
FRIZIONE CENTRIFUGA Ø 107	CENTRIFUGAL CLUTCH Ø 107	EMBAYAGE CENTRIFUGE Ø 107		9910020 9925130	9910020 9925130	9910020 9925130	9910020 9925130
GANASCE FRENO	BRAKE SHOES	MÂCHOIRES FREIN					
GRUPPO TERMICO Ø Standard c/testa	CYLINDER KIT Ø standard with head	CYLINDRE COMPLET Ø Standard avec culasse		9931170	9931170	9931170	9931170
GRUPPO TERMICO Ø Standard s/testa	CYLINDER KIT Ø standard without head	CYLINDRE COMPLET Ø Standard sans culasse		KT00096	KT00096	KT00096	KT00096
GRUPPO TERMICO Ø Magg. c/testa	CYLINDER KIT BIG BORE with head	CYLINDRE COMPLET Ø Majoré avec culasse		9931370 KT00088	9931370 KT00088	9931370 KT00088	9931370 KT00088
GRUPPO TERMICO Ø Magg. s/testa	CYLINDER KIT BIG BORE without head	CYLINDRE COMPLET Ø Majoré sans culasse					
GRUPPO TERMICO Modifica da AC a LC	CYLINDER KIT Conversion AC to LC	CYLINDRE COMPLET Modification de AC à LC					
KIT CUSCINETTI DA BANCO	BEARINGS KIT	KIT PALIERS DE VILEBREQUIN		KK01000 KK01002	KK01000 KK01002	KK01000 KK01002	KK01000 KK01002
KIT REVISIONE POMPA ACQUA	WATER PUMP REPAIR KIT	KIT RÉVISION POMPE À EAU					
MEMBRANA CARBURATORE	CARBURETOR DIAPHRAGM	MEMBRANE CARBURATEUR					
MOTORINO D'AVVIAMENTO	STARTER ENGINE	DÉMARREUR ÉLECTRIQUE		MA00001	MA00001	MA00001	MA00001
PULEGGIA FISSA	VARIATOR SHEAVE FIXED	POULIE FIXE		PL04055 PL04056	PL04055 PL04056	PL04055 PL04056	PL04055 PL04056
RAPPORTI ALLUNGATI Primari	GEARS KIT Primary	RAPPORTS ALLONGÉS Primaires		9913300	9913300	9913300	9913300
RAPPORTI ALLUNGATI Secondari	GEARS KIT Secondary	RAPPORTS ALLONGÉS Secondaires					
REGOLATORE DI TENSIONE	RECTIFIER	RÉGULATEUR DE TENSION		RE00015	RE00015	RE00014	RE00015
RUOTA LIBERA	STARTER CLUTCH	ROUE LIBRE		AA00767 RL00001	AA00767 RL00001	AA00767 RL00001	AA00767 RL00001
STATORE	STATOR	STATOR					
VALVOLA LAMELLARE	REED VALVE	CLAPET À LAMELLES		9906520	9906520	9906520	9906520

YAMAHA	YAMAHA	YAMAHA	YAMAHA	YAMAHA	YAMAHA	YAMAHA	YAMAHA	YAMAHA	YAMAHA	YAMAHA	YAMAHA
BW'S NAKED	BW'S NAKED	BW'S NAKED	BW'S NAKED	BW'S NEXT GENERATION	BW'S NEXT GENERATION	BW'S NEXT GENERATION	BW'S NEXT GENERATION	BW'S NEXT GENERATION	BW'S NEXT GENERATION	BW'S ORIGINAL	BW'S ORIGINAL
03-03	04-04	09-12	13-16	97-98	99-99	99-00	01-02	03-03	04-06	99-99	99-00
50cc 2T AC	50cc 2T AC	50cc 2T AC	50cc 2T AC	50cc 2T AC	50cc 2T AC	50cc 2T AC	50cc 2T AC	50cc 2T AC	50cc 2T AC	50cc 2T AC	50cc 2T AC
CW	CW	CW	CW	CW	CW	CW	CW	CW	CW	CW	CW
IM07058	IM07058	IM07058	IM07058	IM07058	IM07058	IM07058	IM07058	IM07058	IM07058	IM07058	IM07058
IM07013	IM07013	IM07013	IM07013	IM07013	IM07013	IM07013	IM07013	IM07013	IM07013	IM07013	IM07013
9910100				9910100	9910100	9910100	9910100			9910100	9910100
9909230				9909230	9909230	9909230	9909230			9909230	9909230
	9921790	9921790	9921790					9921790	9921790		
IM07032	IM07032	IM07032	IM07032	IM07032	IM07032	IM07032	IM07032	IM07032	IM07032	IM07032	IM07032
9907770	9907770	9907770	9907770	9907770	9907770	9907770	9907770	9907770	9907770	9907770	9907770
9935270	9935270	9935270	9935270	9935270	9935270	9935270	9935270	9935270	9935270	9935270	9935270
CT00726	CT00726	CT00726	CT00726	CT00726	CT00726	CT00726	CT00726	CT00726	CT00726	CT00726	CT00726
9923030	9923030	9923030	9923030	9923030	9923030	9923030	9923030	9923030	9923030	9923030	9923030
9911060	9911060	9911060	9911060	9911060	9911060	9911060	9911060	9911060	9911060	9911060	9911060
9910020 9925130	9910020 9925130	9910020 9925130	9910020 9925130	9910020 9925130	9910020 9925130	9910020 9925130	9910020 9925130	9910020 9925130	9910020 9925130	9910020 9925130	9910020 9925130
9931170	9931170	9931170	9931170	9931170	9931170	9931170	9931170	9931170	9931170	9931170	9931170
KT00096	KT00096	KT00096	KT00096	KT00096	KT00096	KT00096	KT00096	KT00096	KT00096	KT00096	KT00096
9931370 KT00088	9931370 KT00088	9931370 KT00088	9931370 KT00088	9931370 KT00088	9931370 KT00088	9931370 KT00088	9931370 KT00088	9931370 KT00088	9931370 KT00088	9931370 KT00088	9931370 KT00088
KK01000 KK01002	KK01000 KK01002	KK01000 KK01002	KK01000 KK01002	KK01000 KK01002	KK01000 KK01002	KK01000 KK01002	KK01000 KK01002	KK01000 KK01002	KK01000 KK01002	KK01000 KK01002	KK01000 KK01002
MA00001	MA00001	MA00001	MA00001	MA00001	MA00001	MA00001	MA00001	MA00001	MA00001	MA00001	MA00001
PL04055 PL04056	PL04055 PL04056	PL04055 PL04056	PL04055 PL04056	PL04055 PL04056	PL04055 PL04056	PL04055 PL04056	PL04055 PL04056	PL04055 PL04056	PL04055 PL04056	PL04055 PL04056	PL04055 PL04056
9913300	9913300	9913300	9913300	9913300	9913300	9913300	9913300	9913300	9913300	9913300	9913300
				9909520				9909520			
RE00014	RE00015	RE00015	RE00015	RE00014	RE00014	RE00014	RE00014	RE00015	RE00015	RE00014	RE00014
AA00767 RL00001	AA00767 RL00001	AA00767 RL00001	AA00767 RL00001	AA00767 RL00001	AA00767 RL00001	AA00767 RL00001	AA00767 RL00001	AA00767 RL00001	AA00767 RL00001	AA00767 RL00001	AA00767 RL00001
9906520	9906520	9906520	9906520	9906520	9906520	9906520	9906520	9906520	9906520	9906520	9906520

SCOOTER 50cc

SCOOTER 50cc



YAMAHA	YAMAHA	YAMAHA	YAMAHA
BW'S ORIGINAL	BW'S ORIGINAL	BW'S ORIGINAL EURO 2	C3
01-01	01-02	03-03	07-07
50cc 2T AC	50cc 2T AC	50cc 2T AC	50cc
CW	CW	CW	A

IT	EN	FR				
ALBERO MOTORE Con Cuscinetti e Paraoli	CRANKSHAFT with bearings and oil seals	VILEBREQUIN doté de Paliers et Joints d'huile		IM07058	IM07058	IM07058
ALBERO MOTORE Senza Cuscinetti e Paraoli	CRANKSHAFT without bearings and oil seals	VILEBREQUIN sans Paliers et Joints d'huile		IM07013	IM07013	IM07013
ACCENSIONE Fissa	IGNITION UNIT Fixed	ALLUMAGE Fixe		9910100	9910100	
ACCENSIONE Variabile	IGNITION UNIT Variable	ALLUMAGE Variable		9909230	9909230	
ACCENSIONE Digitale	DIGITAL IGNITION UNIT	ALLUMAGE Numérique				
BIELLA	CONROD	BIELLE		IM07032	IM07032	IM07032
CAMPANA FRIZIONE	CLUTCH HOUSING	CLOCHE EMBRAYAGE				
CINGHIA DI TRASMISSIONE TOP PERFORMANCES	TRANSMISSION BELT TOP PERFORMANCES	COURROIE DE TRANSMISSION TOP PERFORMANCES		9907770	9907770	9907770
CINGHIA DI TRASMISSIONE Mitsuboshi	TRANSMISSION BELT Mitsuboshi	COURROIE DE TRANSMISSION Mitsuboshi		9935270	9935270	9935270
COLLETTORE ASPIRAZIONE	INLET MANIFOLD	COLLECTEUR ASPIRATION		CT00726	CT00726	CT00726
CONVERTITORE DI COPPIA	TORQUE CONVERTER	CONVERTISSEUR DE COUPLE		9923030	9923030	9923030
FRIZIONE CENTRIFUGA Ø 105	CENTRIFUGAL CLUTCH Ø 105	EMBAYAGE CENTRIFUGE Ø 105		9911060	9911060	9911060
FRIZIONE CENTRIFUGA Ø 107	CENTRIFUGAL CLUTCH Ø 107	EMBAYAGE CENTRIFUGE Ø 107		9910020 9925130	9910020 9925130	9910020 9925130
GANASCE FRENO	BRAKE SHOES	MÂCHOIRES FREIN				CP00239
GRUPPO TERMICO Ø Standard c/testa	CYLINDER KIT Ø standard with head	CYLINDRE COMPLET Ø Standard avec culasse		9931170	9931170	9931170
GRUPPO TERMICO Ø Standard s/testa	CYLINDER KIT Ø standard without head	CYLINDRE COMPLET Ø Standard sans culasse		KT00096	KT00096	KT00096
GRUPPO TERMICO Ø Magg. c/testa	CYLINDER KIT BIG BORE with head	CYLINDRE COMPLET Ø Majoré avec culasse		9931370 KT00088	9931370 KT00088	9931370 KT00088
GRUPPO TERMICO Ø Magg. s/testa	CYLINDER KIT BIG BORE without head	CYLINDRE COMPLET Ø Majoré sans culasse				
GRUPPO TERMICO Modifica da AC a LC	CYLINDER KIT Conversion AC to LC	CYLINDRE COMPLET Modification de AC à LC				
KIT CUSCINETTI DA BANCO	BEARINGS KIT	KIT PALIERS DE VILEBREQUIN		KK01000 KK01002	KK01000 KK01002	KK01000 KK01002
KIT REVISIONE POMPA ACQUA	WATER PUMP REPAIR KIT	KIT RÉVISION POMPE À EAU				
MEMBRANA CARBURATORE	CARBURETOR DIAPHRAGM	MEMBRANE CARBURATEUR				
MOTORINO D'AVVIAMENTO	STARTER ENGINE	DÉMARREUR ÉLECTRIQUE		MA00001	MA00001	MA00001
PULEGGIA FISSA	VARIATOR SHEAVE FIXED	POULIE FIXE		PL04055 PL04056	PL04055 PL04056	PL04055 PL04056
RAPPORTI ALLUNGATI Primari	GEARS KIT Primary	RAPPORTS ALLONGÉS Primaires		9913300	9913300	9913300
RAPPORTI ALLUNGATI Secondari	GEARS KIT Secondary	RAPPORTS ALLONGÉS Secondaires				
REGOLATORE DI TENSIONE	RECTIFIER	RÉGULATEUR DE TENSION		RE00014	RE00014	RE00015
RUOTA LIBERA	STARTER CLUTCH	ROUE LIBRE		AA00767 RL00001	AA00767 RL00001	AA00767 RL00001
STATORE	STATOR	STATOR				
VALVOLA LAMELLARE	REED VALVE	CLAPET À LAMELLES		9906520	9906520	9906520

YAMAHA	YAMAHA	YAMAHA	YAMAHA	YAMAHA	YAMAHA	YAMAHA	YAMAHA	YAMAHA	YAMAHA	YAMAHA	YAMAHA
CRZ	CRZ	CT	DT MX	DTR	GIGGLE	JOG	JOG	JOG ER	JOG R	JOG R EURO2	JOG R EURO2
91-95	91-95	90-95	92-95	97-01	08-08	92-01	92-01	00-02	02-02	02-02	06-12
50cc 2T	50cc 2T AC	50cc 2T AC	50cc	50cc	50cc 4T-3V LC	50cc	50cc 2T AC	50cc 2T AC	50cc 2T AC	50cc 2T AC	50cc 2T AC
Tipo CW	Tipo CW	Tipo CW	A	A	15P1	A	Tipo CY	Tipo CY	MY	MY	MY
							IM07059		IM07059	IM07059	IM07059
							IM07014		IM07014	IM07014	IM07014
							9910100	9910100			
							9909230	9909230			
									9921790	9921790	
							IM07032		IM07032	IM07032	IM07032
							9924940		9924940	9924940	9924940
	9907900						9907900		9907770	9907770	9907770
	9935340				9935590		9935340		9935270	9935270	9935270
							CT00725		CT00725	CT00725	CT00725
							9923030		9923030	9923030	9923030
	9911060	9911060							9911060	9911060	9911060
	9910020 9925130	9910020 9925130			9925130		9925130	9925130	9910020 9925130	9910020 9925130	9910020 9925130
CP00239			CP00239	CP00239		CP00219					
							9931140		9931140	9931140	9931140
							KT00095	KT00095	KT00095	KT00095	KT00095
							9931340 KT00087	KT00087	9931340 KT00087	9931340 KT00087	9931340 KT00087
					9926330						
							9911090		9911090	9911090	9911090
							KK01000 KK01002		KK01000 KK01002	KK01000 KK01002	KK01000 KK01002
									MA00001	MA00001	MA00001
									PL04055 PL04056	PL04055 PL04056	PL04055 PL04056
									9913300	9913300	9913300
									RE00015	RE00015	RE00015
	AA00767						AA00767 RL00001		AA00767 RL00001	AA00767 RL00001	AA00767 RL00001
							9908370	9908370	9908370	9908370	9908370

SCOOTER 50cc

SCOOTER 50cc



YAMAHA	YAMAHA	YAMAHA	YAMAHA
JOG R EURO2	JOG R LC	JOG Z	JOG Z
13-15	02-15	95-95	95-95
50cc 2T AC	50cc 2T LC	50cc 2T	50cc 2T AC
MY	MA	Tipo CY	Tipo CY

IT	EN	FR				
ALBERO MOTORE Con Cuscinetti e Paraoli	CRANKSHAFT with bearings and oil seals	VILEBREQUIN doté de Paliers et Joints d'huile		IM07059	IM07059	
ALBERO MOTORE Senza Cuscinetti e Paraoli	CRANKSHAFT without bearings and oil seals	VILEBREQUIN sans Paliers et Joints d'huile		IM07014	IM07014	
ACCENSIONE Fissa	IGNITION UNIT Fixed	ALLUMAGE Fixe				9910100
ACCENSIONE Variabile	IGNITION UNIT Variable	ALLUMAGE Variable				9909230
ACCENSIONE Digitale	DIGITAL IGNITION UNIT	ALLUMAGE Numérique		9921790	9921790	
BIELLA	CONROD	BIELLE		IM07032	IM07032	
CAMPANA FRIZIONE	CLUTCH HOUSING	CLOCHE EMBRAYAGE		9924940	9924940	
CINGHIA DI TRASMISSIONE TOP PERFORMANCES	TRANSMISSION BELT TOP PERFORMANCES	COURROIE DE TRANSMISSION TOP PERFORMANCES		9907770	9907770	
CINGHIA DI TRASMISSIONE Mitsuboshi	TRANSMISSION BELT Mitsuboshi	COURROIE DE TRANSMISSION Mitsuboshi		9935270	9935270	
COLLETTORE ASPIRAZIONE	INLET MANIFOLD	COLLECTEUR ASPIRATION		CT00725	CT00725	
CONVERTITORE DI COPPIA	TORQUE CONVERTER	CONVERTISSEUR DE COUPLE		9923030	9923030	
FRIZIONE CENTRIFUGA Ø 105	CENTRIFUGAL CLUTCH Ø 105	EMBAYAGE CENTRIFUGE Ø 105		9911060	9911060	
FRIZIONE CENTRIFUGA Ø 107	CENTRIFUGAL CLUTCH Ø 107	EMBAYAGE CENTRIFUGE Ø 107		9910020 9925130	9910020 9925130	9925130
GANASCE FRENO	BRAKE SHOES	MÂCHOIRES FREIN				CP00219
GRUPPO TERMICO Ø Standard c/testa	CYLINDER KIT Ø standard with head	CYLINDRE COMPLET Ø Standard avec culasse		9931140	9931110	
GRUPPO TERMICO Ø Standard s/testa	CYLINDER KIT Ø standard without head	CYLINDRE COMPLET Ø Standard sans culasse		KT00095	KT00094	KT00095
GRUPPO TERMICO Ø Magg. c/testa	CYLINDER KIT BIG BORE with head	CYLINDRE COMPLET Ø Majoré avec culasse		9931340 KT00087	9931310 KT00109	KT00087
GRUPPO TERMICO Ø Magg. s/testa	CYLINDER KIT BIG BORE without head	CYLINDRE COMPLET Ø Majoré sans culasse				
GRUPPO TERMICO Modifica da AC a LC	CYLINDER KIT Conversion AC to LC	CYLINDRE COMPLET Modification de AC à LC		9911090		
KIT CUSCINETTI DA BANCO	BEARINGS KIT	KIT PALIERS DE VILEBREQUIN		KK01000 KK01002	KK01000 KK01002	
KIT REVISIONE POMPA ACQUA	WATER PUMP REPAIR KIT	KIT RÉVISION POMPE À EAU			AA00780 AA00785 AA00786	AA00787 AA00788
MEMBRANA CARBURATORE	CARBURETOR DIAPHRAGM	MEMBRANE CARBURATEUR				
MOTORINO D'AVVIAMENTO	STARTER ENGINE	DÉMARREUR ÉLECTRIQUE		MA00001	MA00001	
PULEGGIA FISSA	VARIATOR SHEAVE FIXED	POULIE FIXE		PL04055 PL04056	PL04055 PL04056	
RAPPORTI ALLUNGATI Primari	GEARS KIT Primary	RAPPORTS ALLONGÉS Primaires		9913300	9913300	
RAPPORTI ALLUNGATI Secondari	GEARS KIT Secondary	RAPPORTS ALLONGÉS Secondaires			9909520	
REGOLATORE DI TENSIONE	RECTIFIER	RÉGULATEUR DE TENSION		RE00015	RE00015	
RUOTA LIBERA	STARTER CLUTCH	ROUE LIBRE		AA00767 RL00001	AA00767 RL00001	
STATORE	STATOR	STATOR				
VALVOLA LAMELLARE	REED VALVE	CLAPET À LAMELLES		9908370	9908370	9908370

YAMAHA	YAMAHA	YAMAHA	YAMAHA	YAMAHA	YAMAHA	YAMAHA	YAMAHA	YAMAHA	YAMAHA	YAMAHA	YAMAHA
NEO'S	NEO'S	NEO'S	NEO'S	NEO'S	NEO'S 4	NEO'S 4	NEO'S 4	NEO'S EASY	NEO'S EURO 2	RS SPY	SLIDER
97-13	02-02	04-06	07-12	12-16	09-10	11-12	12-15	13-13	02-02	95-98	00-02
50cc 2T AC	50cc 2T AC	50cc 2T AC	50cc 2T AC	50cc 2T AC	50cc 4T-3V LC	50cc 4T-3V LC	50cc 4T-3V LC	50cc 2T AC	50cc 2T AC	50cc 2T AC	50cc 2T AC
MY	MY	MY	MY	MY	5C3	5C3	5C3	MY	MY	CW	CW
IM07059	IM07059	IM07059	IM07059	IM07059				IM07059	IM07059	IM07058	IM07058
IM07014	IM07014	IM07014	IM07014	IM07014				IM07014	IM07014	IM07013	IM07013
9910100	9910100									9910100	9910100
9909230	9909230									9909230	9909230
		9921790	9921790	9921790				9921790	9921790		
IM07032	IM07032	IM07032	IM07032	IM07032				IM07032	IM07032	IM07032	IM07032
9924940	9924940	9924940	9924940	9924940				9924940	9924940		
9907770	9907770	9907770	9907770	9907770				9907770	9907770	9907770	9907770
9935270	9935270	9935270	9935270	9935270	9935600	9935600	9935600	9935270	9935270	9935270	9935270
CT00725	CT00725	CT00725	CT00725	CT00725				CT00725	CT00725	CT00726	CT00726
9923030	9923030	9923030	9923030	9923030				9923030	9923030	9923030	9923030
9911060	9911060	9911060	9911060	9911060				9911060	9911060	9911060	9911060
9910020 9925130	9910020 9925130	9910020 9925130	9910020 9925130	9910020 9925130	9925130	9925130	9925130	9910020 9925130	9910020 9925130	9910020 9925130	9910020 9925130
9931140	9931140	9931140	9931140	9931140				9931140	9931140	9931170	9931170
KT00095	KT00095	KT00095	KT00095	KT00095				KT00095	KT00095	KT00096	KT00096
9931340 KT00087	9931340 KT00087	9931340 KT00087	9931340 KT00087	9931340 KT00087				9931340 KT00087	9931340 KT00087	9931370 KT00088	9931370 KT00088
					9926330	9926330	9926330				
9911090	9911090	9911090	9911090	9911090				9911090	9911090		
KK01000 KK01002	KK01000 KK01002	KK01000 KK01002	KK01000 KK01002	KK01000 KK01002				KK01000 KK01002	KK01000 KK01002	KK01000 KK01002	KK01000 KK01002
MA00001	MA00001	MA00001	MA00001	MA00001				MA00001	MA00001	MA00001	MA00001
PL04055 PL04056	PL04055 PL04056	PL04055 PL04056	PL04055 PL04056	PL04055 PL04056				PL04055 PL04056	PL04055 PL04056		PL04055 PL04056
9913300	9913300	9913300	9913300	9913300				9913300	9913300	9913300	9913300
										9909520	9909520
RE00014	RE00014	RE00014	RE00014	RE00014				RE00014	RE00015	RE00014	RE00014
AA00767 RL00001	AA00767 RL00001	AA00767 RL00001	AA00767 RL00001	AA00767 RL00001				AA00767 RL00001	AA00767 RL00001	AA00767 RL00001	AA00767 RL00001
9908370	9908370	9908370	9908370	9908370				9908370	9908370	9906520	9906520

SCOOTER 50cc



YAMAHA	YAMAHA	YAMAHA	YAMAHA
SPY	WHY	WHY EURO 2	ZEST
95-95	98-05	03-05	95-92
50cc	50cc 2T AC	50cc 2T AC	50cc 2T AC
A	MY	MY	CY

IT	EN	FR					
ALBERO MOTORE Con Cuscinetti e Paraoli	CRANKSHAFT with bearings and oil seals	VILEBREQUIN doté de Paliers et Joints d'huile			IM07059	IM07059	IM07059
ALBERO MOTORE Senza Cuscinetti e Paraoli	CRANKSHAFT without bearings and oil seals	VILEBREQUIN sans Paliers et Joints d'huile			IM07014	IM07014	IM07014
ACCENSIONE Fissa	IGNITION UNIT Fixed	ALLUMAGE Fixe			9910100		9910100
ACCENSIONE Variabile	IGNITION UNIT Variable	ALLUMAGE Variable			9909230		9909230
ACCENSIONE Digitale	DIGITAL IGNITION UNIT	ALLUMAGE Numérique				9921790	
BIELLA	CONROD	BIELLE			IM07032	IM07032	IM07032
CAMPANA FRIZIONE	CLUTCH HOUSING	CLOCHE EMBRAYAGE			9924940	9924940	
CINGHIA DI TRASMISSIONE TOP PERFORMANCES	TRANSMISSION BELT TOP PERFORMANCES	COURROIE DE TRANSMISSION TOP PERFORMANCES			9907770	9907770	9907900
CINGHIA DI TRASMISSIONE Mitsuboshi	TRANSMISSION BELT Mitsuboshi	COURROIE DE TRANSMISSION Mitsuboshi			9935270	9935270	9935340
COLLETTORE ASPIRAZIONE	INLET MANIFOLD	COLLECTEUR ASPIRATION			CT00725	CT00725	CT00725
CONVERTITORE DI COPPIA	TORQUE CONVERTER	CONVERTISSEUR DE COUPLE			9923030	9923030	9923030
FRIZIONE CENTRIFUGA Ø 105	CENTRIFUGAL CLUTCH Ø 105	EMBAYAGE CENTRIFUGE Ø 105			9911060	9911060	
FRIZIONE CENTRIFUGA Ø 107	CENTRIFUGAL CLUTCH Ø 107	EMBAYAGE CENTRIFUGE Ø 107			9910020 9925130	9910020 9925130	9925130
GANASCE FRENO	BRAKE SHOES	MÂCHOIRES FREIN			CP00239		
GRUPPO TERMICO Ø Standard c/testa	CYLINDER KIT Ø standard with head	CYLINDRE COMPLET Ø Standard avec culasse			9931140	9931140	9931140
GRUPPO TERMICO Ø Standard s/testa	CYLINDER KIT Ø standard without head	CYLINDRE COMPLET Ø Standard sans culasse			KT00095	KT00095	KT00095
GRUPPO TERMICO Ø Magg. c/testa	CYLINDER KIT BIG BORE with head	CYLINDRE COMPLET Ø Majoré avec culasse			9931340 KT00087	9931340 KT00087	9931340 KT00087
GRUPPO TERMICO Ø Magg. s/testa	CYLINDER KIT BIG BORE without head	CYLINDRE COMPLET Ø Majoré sans culasse					
GRUPPO TERMICO Modifica da AC a LC	CYLINDER KIT Conversion AC to LC	CYLINDRE COMPLET Modification de AC à LC			9911090	9911090	9911090
KIT CUSCINETTI DA BANCO	BEARINGS KIT	KIT PALIERS DE VILEBREQUIN			KK01000 KK01002	KK01000 KK01002	KK01000 KK01002
KIT REVISIONE POMPA ACQUA	WATER PUMP REPAIR KIT	KIT RÉVISION POMPE À EAU					
MEMBRANA CARBURATORE	CARBURETOR DIAPHRAGM	MEMBRANE CARBURATEUR					
MOTORINO D'AVVIAMENTO	STARTER ENGINE	DÉMARREUR ÉLECTRIQUE			MA00001	MA00001	MA00001
PULEGGIA FISSA	VARIATOR SHEAVE FIXED	POULIE FIXE			PL04055 PL04056	PL04055 PL04056	PL04055 PL04056
RAPPORTI ALLUNGATI Primari	GEARS KIT Primary	RAPPORTS ALLONGÉS Primaires			9913300	9913300	
RAPPORTI ALLUNGATI Secondari	GEARS KIT Secondary	RAPPORTS ALLONGÉS Secondaires			9909520	9909520	
REGOLATORE DI TENSIONE	RECTIFIER	RÉGULATEUR DE TENSION			RE00014	RE00015	
RUOTA LIBERA	STARTER CLUTCH	ROUE LIBRE			AA00767 RL00001	AA00767 RL00001	AA00767 RL00001
STATORE	STATOR	STATOR					
VALVOLA LAMELLARE	REED VALVE	CLAPET À LAMELLES			9908370	9908370	9908370

YAMAHA	YAMAHA
ZUMA	ZUMA
97-01	02-10
50cc 2T AC	50cc 2T AC
CW	YW
IM07058	
IM07013	
9910100	
9909230	
IM07032	
9907770	
9935270	
CT00726	
9923030	
9911060	
9910020 9925130	
9931170	
KT00096	
9931370 KT00088	
KK01000 KK01002	
MA00001	
PL04055 PL04056	
9913300	
AA00767 RL00001	
9906520	9908370



9926330
Gruppo termico Ø 44
Cilindro in alluminio

SCOOTER 50cc RACING



APRILIA APRILIA APRILIA APRILIA

AMICO AMICO AMICO GL/GLE AMICO LX/SPORT/CAT

94-94 96-98 93-95 92-93

50cc 2T AC 50cc 2T AC 50cc 2T AC 50cc 2T AC

CW CW CW CW

IT	EN	FR					
ALBERO MOTORE TPR CORSA STD Spinotto Ø 10	CRANKSHAFT TPR Standard stroke pin Ø10	VILEBREQUIN TPR COURSE STD Axe de piston Ø 10		9927900	9927900	9927900	9927900
ALBERO MOTORE TPR CORSA STD Spinotto Ø 12	CRANKSHAFT TPR Standard stroke pin Ø12	VILEBREQUIN TPR COURSE STD Axe de piston Ø 12					
COPERCHIO INGRANAGGI	GEAR COVER	COUVERCLE ENGRENAGES		9930300	9930300	9930300	9930300
COPERCHIO TRASMISSIONE	TRANSMISSION COVER	COUVERCLE TRANSMISSION					
CUSCINETTI DI BANCO TPR CARBONITRURATI Serie	BEARINGS TPR Carbonitrided Series	PALIERI DE VILEBREQUIN TPR CARBONITRURÉS Jeu		9929190	9929190	9929190	9929190
FRIZIONE TPR GP REGOLABILE Patented	CLUTCH TPR GP Adjustable Patented	EMBAYAGE TPR GP RÉGLABLE Patented		9927450	9927450	9927450	9927450
GRUPPO TERMICO RACING MAGGIORATO C/TESTA (GHISA)	RACING CYLINDER KITS BIG BORE with head (CAST IRON)	CYLINDRE COMPLET RACING MAJORÉ AVEC CULASSE (FONTE)		9930000	9930000	9930000	9930000
GRUPPO TERMICO RACING 2004 C/TESTA SCOMPOSTA (GHISA)	RACING CYLINDER KITS BIG BORE without head (CAST IRON)	CYLINDRE COMPLET RACING 2004 AVEC CULASSE DÉCOMPOSÉE (FONTE)					
GRUPPO TRASFORMAZIONE DA ARIA AD ACQUA (GHISA)	CYLINDER KIT Conversion AC to LC (CAST IRON)	GROUPE TRANSFORMATION DE L'AIR À L'EAU (FONTE)					
GRUPPO TERMICO TPR IN ALLUMINIO Ø 47,6 Spinotto Ø 10	CYLINDER KIT TPR ALLUMINIUM Ø 47,6 Pin Ø 10	CYLINDRE COMPLET TPR EN ALUMINIUM Ø 47,6 Axe de Piston Ø 10		9921640	9921640	9921640	9921640
GRUPPO TERMICO TPR IN ALLUMINIO Ø 47,6 Spinotto Ø 12	CYLINDER KIT TPR ALLUMINIUM Ø 47,6 Pin Ø 12	CYLINDRE COMPLET TPR EN ALUMINIUM Ø 47,6 Axe de Piston Ø 12					
KIT ASPIRAZIONE COMPLETO MIKUNI TM 24 TPR 360	COMPLETE INLET KIT MIKUNI TM 24 TPR 360	KIT ASPIRATION COMPLET MIKUNI TM 24 TPR 360					
KIT ASPIRAZIONE COMPLETO OKO 28 TPR 360	COMPLETE INLET KIT OKO 28 TPR 360	KIT ASPIRATION COMPLET OKO 28 TPR 360					
MAXI KIT 77cc ALESAGGIO Ø 50 CORSA STD	MAXI KIT 77 cc Bore Ø 50 Standard stroke	MAXI KIT 77 cc ALÉSAGE Ø 50 COURSE STD					
MAXI KIT 86cc ALESAGGIO Ø 50 CORSA 44 mm	MAXI KIT 86 cc Bore Ø 50 stroke 44 mm	MAXI KIT 86 cc ALÉSAGE Ø 50 COURSE 44 mm					
RAPPORTO ALLUNGATO secondario	SHAFT/GEARS	RAPPORT ALLONGÉ secondaire					
SCARICO NARDÒ 2 omologato	EXHAUST NARDÒ 2 Approved	ÉCHAPPEMENT NARDÒ 2 homologué		9931450	9931450	9931450	9931450
SCARICO TPR GP omologato	EXHAUST TPR GP Approved	ÉCHAPPEMENT TPR GP homologué					
VALVOLA LAMELLARE TPR	REED VALVE TPR	CLAPET À LAMELLES TPR					
VARIOTOP TPR con cinghia	VARIOTOP TPR with belt	VARIOTOP TPR avec courroie		9931670	9931670	9931670	9931670
VARIOTOP TPR con molla	VARIOTOP TPR with spring	VARIOTOP TPR avec ressort		9931650	9931650	9931650	9931650

APRILIA	APRILIA	APRILIA	APRILIA	APRILIA	APRILIA	APRILIA	APRILIA	APRILIA	APRILIA	APRILIA	APRILIA
AREA 51	GULLIVER	GULLIVER LC	MOJITO CUSTOM 2T MOTORE PIAGGIO	RALLY	RALLY LIQUID COOLED	SCARABEO	SCARABEO	SCARABEO	SCARABEO	SCARABEO 2T EU2 MOTORE PIAGGIO	SCARABEO 2T NET
98-00	95-98	96-98	04-10	95-03	96-99	93-97	98-98	99-99	00-05	10-12	09-09
50cc 2T LC	50cc 2T AC	50cc 2T LC	50cc 2T AC	50cc 2T AC	50cc 2T LC	50cc 2T AC	50cc 2T AC	50cc 2T AC	50cc 2T AC	50cc 2T AC	50cc 2T AC
MA	MY	MA	Motore Piaggio	MY	MA	MY	MY	MY	MY	Motore Piaggio	Motore Piaggio
9925910	9925910	9925910		9925910	9925910	9925910	9925910	9925910	9925910		
9928320	9928320	9928320	9926180	9928320	9928320	9928320	9928320	9928320	9928320	9926180	9926180
9930300	9930300	9930300		9930300	9930300	9930300	9930300	9930300	9930300		
9930200	9930200	9930200		9930200	9930200	9930200	9930200	9930200	9930200		
9929190	9929190	9929190	9929200	9929190	9929190	9929190	9929190	9929190	9929190	9929200	9929200
9927450	9927450	9927450	9928340	9927450	9927450	9927450	9927450	9927450	9927450	9928340	9928340
9912800	9930030	9912800	9930060	9930030	9912800	9930030	9930030	9930030	9930030	9930060	9930060
9921160		9921160			9921160						
	9911210			9911210		9911210	9911210	9911210	9911210		
9928480	9921630	9928480		9921630	9928480	9921630	9921630	9921630	9921630		
9928550		9928550	9921550		9928550					9921550	9921550
9930830	9930830	9930830	9930870	9930830	9930830	9930830	9930830	9930830	9930830	9930870	9930870
9931710	9931710	9931710	9931730	9931710	9931710	9931710	9931710	9931710	9931710	9931730	9931730
9926580		9926580			9926580						
9926560		9926560			9926560						
990875P	990875P	990875P		990875P	990875P						
9931440	9931440	9931440		9931440	9931440	9931440	9931440			9931460	9931460
9930140		9930140			9930140						
9931620	9931620	9931620	9931640	9931620	9931620	9931620	9931620	9931620	9931620	9931640	9931640
9931670	9931670	9931670	9931300	9931670	9931670	9931670	9931670	9931670	9931670		
9931650	9931650	9931650	9927610	9931650	9931650	9931650	9931650	9931650	9931650	9927610	9927610

SCOOTER 50cc
RACING

SCOOTER 50cc RACING



APRILIA	APRILIA	APRILIA	APRILIA
SCARABEO 2T NET	SCARABEO 4T	SCARABEO 4T 4V	SCARABEO 4T 4V NET
10-10	02-06	10-12	09-09
50cc 2T AC	50cc 4T AC	50cc 4T-4V AC	50cc 4T-4V AC
Motore Piaggio	Motore Piaggio	Motore Piaggio	Motore Piaggio

IT	EN	FR				
ALBERO MOTORE TPR CORSA STD Spinotto Ø 10	CRANKSHAFT TPR Standard stroke pin Ø10	VILEBREQUIN TPR COURSE STD Axe de piston Ø 10				
ALBERO MOTORE TPR CORSA STD Spinotto Ø 12	CRANKSHAFT TPR Standard stroke pin Ø12	VILEBREQUIN TPR COURSE STD Axe de piston Ø 12		9926180		
COPERCHIO INGRANAGGI	GEAR COVER	COUVERCLE ENGRENAGES				
COPERCHIO TRASMISSIONE	TRANSMISSION COVER	COUVERCLE TRANSMISSION				
CUSCINETTI DI BANCO TPR CARBONITRURATI Serie	BEARINGS TPR Carbonitrided Series	PALIERI DE VILEBREQUIN TPR CARBONITRURÉS Jeu		9929200		
FRIZIONE TPR GP REGOLABILE Patented	CLUTCH TPR GP Adjustable Patented	EMBAYAGE TPR GP RÉGLABLE Patented		9928340	9928340	9928340
GRUPPO TERMICO RACING MAGGIORATO C/TESTA (GHISA)	RACING CYLINDER KITS BIG BORE with head (CAST IRON)	CYLINDRE COMPLET RACING MAJORÉ AVEC CULASSE (FONTE)		9930060		
GRUPPO TERMICO RACING 2004 C/TESTA SCOMPOSTA (GHISA)	RACING CYLINDER KITS BIG BORE without head (CAST IRON)	CYLINDRE COMPLET RACING 2004 AVEC CULASSE DÉCOMPOSÉE (FONTE)				
GRUPPO TRASFORMAZIONE DA ARIA AD ACQUA (GHISA)	CYLINDER KIT Conversion AC to LC (CAST IRON)	GROUPE TRANSFORMATION DE L'AIR À L'EAU (FONTE)				
GRUPPO TERMICO TPR IN ALLUMINIO Ø 47,6 Spinotto Ø 10	CYLINDER KIT TPR ALLUMINIUM Ø 47,6 Pin Ø 10	CYLINDRE COMPLET TPR EN ALUMINIUM Ø 47,6 Axe de Piston Ø 10				
GRUPPO TERMICO TPR IN ALLUMINIO Ø 47,6 Spinotto Ø 12	CYLINDER KIT TPR ALLUMINIUM Ø 47,6 Pin Ø 12	CYLINDRE COMPLET TPR EN ALUMINIUM Ø 47,6 Axe de Piston Ø 12		9921550		
KIT ASPIRAZIONE COMPLETO MIKUNI TM 24 TPR 360	COMPLETE INLET KIT MIKUNI TM 24 TPR 360	KIT ASPIRATION COMPLET MIKUNI TM 24 TPR 360		9930870		
KIT ASPIRAZIONE COMPLETO OKO 28 TPR 360	COMPLETE INLET KIT OKO 28 TPR 360	KIT ASPIRATION COMPLET OKO 28 TPR 360		9931730		
MAXI KIT 77cc ALESAGGIO Ø 50 CORSA STD	MAXI KIT 77 cc Bore Ø 50 Standard stroke	MAXI KIT 77 cc ALÉSAGE Ø 50 COURSE STD				
MAXI KIT 86cc ALESAGGIO Ø 50 CORSA 44 mm	MAXI KIT 86 cc Bore Ø 50 stroke 44 mm	MAXI KIT 86 cc ALÉSAGE Ø 50 COURSE 44 mm				
RAPPORTO ALLUNGATO secondario	SHAFT/GEARS	RAPPORT ALLONGÉ secondaire				
SCARICO NARDÒ 2 omologato	EXHAUST NARDÒ 2 Approved	ÉCHAPPEMENT NARDÒ 2 homologué		9931460		
SCARICO TPR GP omologato	EXHAUST TPR GP Approved	ÉCHAPPEMENT TPR GP homologué				
VALVOLA LAMELLARE TPR	REED VALVE TPR	CLAPET À LAMELLES TPR		9931640		
VARIOTOP TPR con cinghia	VARIOTOP TPR with belt	VARIOTOP TPR avec courroie				
VARIOTOP TPR con molla	VARIOTOP TPR with spring	VARIOTOP TPR avec ressort		9927610	9927610	9927610

APRILIA	APRILIA	APRILIA	APRILIA	APRILIA	APRILIA	APRILIA	APRILIA	APRILIA	APRILIA	APRILIA	APRILIA
SCARABEO 4T 4V NET	SCARABEO 4T RESTYLING EU3	SCARABEO QUATTRO	SCARABEO STREET	SCARABEO STREET 2T RESTYLING	SONIC	SONIC GP	SPORT CITY ONE 2T	SPORT CITY ONE 4T	SR (ORIZZONTALE)	SR (VERTICALE)	SR LIQUID COOLED
10-10	06-09	09-09	05-06	06-09	98-07	98-08	08-11	08-10	94-96	93-93	94-96
50cc 4T-4V AC	50cc 4T AC	50cc 4T-4V AC	50cc 2T AC	50cc 2T AC	50cc 2T AC	50cc 2T LC	50cc 2T AC	50cc 4T AC	50cc 2T AC	50cc 2T AC	50cc 2T LC
Motore Piaggio	Motore Piaggio	Motore Piaggio	Motore Piaggio	Motore Piaggio	CY	CA	Motore Piaggio	Motore Piaggio	MY	CW	MA
					9925910	9925910			9925910	9927900	9925910
			9926180	9926180	9928320	9928320	9926180		9928320		9928320
									9930300	9930300	9930300
									9930200		9930200
			9929200	9929200	9929190	9929190	9929200		9929190	9929190	9929190
9928340	9928340	9928340	9928340	9928340	9927450	9927450	9928340	9928340	9927450	9927450	9927450
			9930060	9930060	9930030	9912800	9930060		9930030	9930000	9912800
						9921160					9921160
					9911210				9911210		
					9921630	9928480			9921630	9921640	9928480
			9921550	9921550		9928550	9921550				9928550
			9930870	9930870	9930830	9930830	9930870		9930830		9930830
			9931730	9931730	9931710	9931710	9931730		9931710		9931710
						9926580					9926580
						9926560					9926560
									990875P	990875P	990875P
			9931460	9931460	9931440	9931440			9931440	9931450	9931440
						9930140					9930140
			9931640	9931640	9931620	9931620	9931640		9931620		9931620
					9931690	9931690			9931670	9931670	9931670
	9927610	9927610	9927610	9927610	9931650	9931650	9927610	9927610	9931650	9931650	9931650

SCOOTER 50cc RACING

SCOOTER 50cc RACING



APRILIA	APRILIA	APRILIA	APRILIA
SR MOTARD	SR R	SR R FACTORY CARBURATORE	SR R FACTORY IE
12-14	04-09	10-14	10-12
50cc 2T LC	50cc 2T LC	50cc 2T LC	50cc 2T-IE LC
Motore Piaggio	Motore Piaggio	Motore Piaggio	Motore Piaggio

IT	EN	FR				
ALBERO MOTORE TPR CORSA STD Spinotto Ø 10	CRANKSHAFT TPR Standard stroke pin Ø10	VILEBREQUIN TPR COURSE STD Axe de piston Ø 10				
ALBERO MOTORE TPR CORSA STD Spinotto Ø 12	CRANKSHAFT TPR Standard stroke pin Ø12	VILEBREQUIN TPR COURSE STD Axe de piston Ø 12		9926180	9926180	9926180
COPERCHIO INGRANAGGI	GEAR COVER	COUVERCLE ENGRENAGES				
COPERCHIO TRASMISSIONE	TRANSMISSION COVER	COUVERCLE TRANSMISSION				
CUSCINETTI DI BANCO TPR CARBONITRURATI Serie	BEARINGS TPR Carbonitrided Series	PALIERI DE VILEBREQUIN TPR CARBONITRURÉS Jeu		9929200	9929200	9929200
FRIZIONE TPR GP REGOLABILE Patented	CLUTCH TPR GP Adjustable Patented	EMBAYAGE TPR GP RÉGLABLE Patented		9928340	9928340	9928340
GRUPPO TERMICO RACING MAGGIORATO C/TESTA (GHISA)	RACING CYLINDER KITS BIG BORE with head (CAST IRON)	CYLINDRE COMPLET RACING MAJORÉ AVEC CULASSE (FONTE)		9920590	9920590	9920590
GRUPPO TERMICO RACING 2004 C/TESTA SCOMPOSTA (GHISA)	RACING CYLINDER KITS BIG BORE without head (CAST IRON)	CYLINDRE COMPLET RACING 2004 AVEC CULASSE DÉCOMPOSÉE (FONTE)				
GRUPPO TRASFORMAZIONE DA ARIA AD ACQUA (GHISA)	CYLINDER KIT Conversion AC to LC (CAST IRON)	GROUPE TRANSFORMATION DE L'AIR À L'EAU (FONTE)				
GRUPPO TERMICO TPR IN ALLUMINIO Ø 47,6 Spinotto Ø 10	CYLINDER KIT TPR ALLUMINIUM Ø 47,6 Pin Ø 10	CYLINDRE COMPLET TPR EN ALUMINIUM Ø 47,6 Axe de Piston Ø 10				
GRUPPO TERMICO TPR IN ALLUMINIO Ø 47,6 Spinotto Ø 12	CYLINDER KIT TPR ALLUMINIUM Ø 47,6 Pin Ø 12	CYLINDRE COMPLET TPR EN ALUMINIUM Ø 47,6 Axe de Piston Ø 12		9928520	9928520	9928520
KIT ASPIRAZIONE COMPLETO MIKUNI TM 24 TPR 360	COMPLETE INLET KIT MIKUNI TM 24 TPR 360	KIT ASPIRATION COMPLET MIKUNI TM 24 TPR 360		9930870	9930870	9930870
KIT ASPIRAZIONE COMPLETO OKO 28 TPR 360	COMPLETE INLET KIT OKO 28 TPR 360	KIT ASPIRATION COMPLET OKO 28 TPR 360		9931730	9931730	9931730
MAXI KIT 77cc ALESAGGIO Ø 50 CORSA STD	MAXI KIT 77 cc Bore Ø 50 Standard stroke	MAXI KIT 77 cc ALÉSAGE Ø 50 COURSE STD		9928390	9928390	9928390
MAXI KIT 86cc ALESAGGIO Ø 50 CORSA 44 mm	MAXI KIT 86 cc Bore Ø 50 stroke 44 mm	MAXI KIT 86 cc ALÉSAGE Ø 50 COURSE 44 mm		9928440	9928440	9928440
RAPPORTO ALLUNGATO secondario	SHAFT/GEARS	RAPPORT ALLONGÉ secondaire				
SCARICO NARDÒ 2 omologato	EXHAUST NARDÒ 2 Approved	ÉCHAPPEMENT NARDÒ 2 homologué		9931460	9931460	9931460
SCARICO TPR GP omologato	EXHAUST TPR GP Approved	ÉCHAPPEMENT TPR GP homologué		9930160	9930160	9930160
VALVOLA LAMELLARE TPR	REED VALVE TPR	CLAPET À LAMELLES TPR		9931640	9931640	9931640
VARIOTOP TPR con cinghia	VARIOTOP TPR with belt	VARIOTOP TPR avec courroie		9931300	9931300	9931300
VARIOTOP TPR con molla	VARIOTOP TPR with spring	VARIOTOP TPR avec ressort		9927610	9927610	9927610

APRILIA	APRILIA	APRILIA	APRILIA	APRILIA	ATALA	BENELLI	BENELLI	BENELLI	BENELLI	BENELLI	BENELLI
SR R FACTORY IE	SR RACING	SR STEALTH	SR STREET CARBURATORE	SR WWW	CAROSELLO	491 GT	491 NAKED	491 RACING	491 RR	491 SP	491 SPORT
10-14	97-99	97-00	03-12	97-01	99-01	98-99	02-02	98-99	99-01	99-99	98-99
50cc 2T LC	50cc 2T LC	50cc 2T LC	50cc 2T LC	50cc 2T AC	50cc 2T AC	50cc 2T AC	50cc 2T AC	50cc 2T LC	50cc 2T LC	50cc 2T LC	50cc 2T LC
Motore Piaggio	MA	MA	Motore Piaggio	MY	MY	MY	MY	MA	MA	MA	MA
	9925910	9925910		9925910	9925910	9925910	9925910	9925910	9925910	9925910	9925910
9926180	9928320	9928320	9926180	9928320	9928320	9928320	9928320	9928320	9928320	9928320	9928320
	9930300	9930300		9930300	9930300	9930300	9930300	9930300	9930300	9930300	9930300
	9930200	9930200		9930200	9930200	9930200	9930200	9930200	9930200	9930200	9930200
9929200	9929190	9929190	9929200	9929190	9929190	9929190	9929190	9929190	9929190	9929190	9929190
9928340	9927450	9927450	9928340	9927450	9927450	9927450	9927450	9927450	9927450	9927450	9927450
9920590	9912800	9912800	9920590	9930030	9930030	9930030	9930030	9912800	9912800	9912800	9912800
	9921160	9921160						9921160	9921160	9921160	9921160
				9911210	9911210	9911210	9911210				
	9928480	9928480		9921630	9921630	9921630	9921630	9928480	9928480	9928480	9928480
9928520	9928550	9928550	9928520					9928550	9928550	9928550	9928550
9930870	9930830	9930830	9930870	9930830	9930830	9930830	9930830	9930830	9930830	9930830	9930830
9931730	9931710	9931710	9931730	9931710	9931710	9931710	9931710	9931710	9931710	9931710	9931710
9928390	9926580	9926580	9928390					9926580	9926580	9926580	9926580
9928440	9926560	9926560	9928440					9926560	9926560	9926560	9926560
	990875P	990875P		990875P	990875P	990875P	990875P	990875P	990875P	990875P	990875P
9931460	9931440	9931440		9931440		9931440		9931440			
9930160	9930140	9930140						9930140	9930140	9930140	9930140
9931640	9931620	9931620	9931640	9931620	9931620	9931620	9931620	9931620	9931620	9931620	9931620
9931300	9931670	9931670	9931300	9931670	9931670	9931670	9931670	9931670	9931670	9931670	9931670
9927610	9931650	9931650	9927610	9931650	9931650	9931650	9931650	9931650	9931650	9931650	9931650

SCOOTER 50cc RACING

SCOOTER 50cc RACING



BENELLI	BENELLI	BENELLI	BENELLI
491 ST	K2	K2 LIQUID COOLED	PEPE
99-01	98-01	98-01	99-01
50cc 2T AC	50cc 2T AC	50cc 2T LC	50cc 2T AC
MY	MY	MA	MY

IT	EN	FR					
ALBERO MOTORE TPR CORSA STD Spinotto Ø 10	CRANKSHAFT TPR Standard stroke pin Ø10	VILEBREQUIN TPR COURSE STD Axe de piston Ø 10		9925910	9925910	9925910	9925910
ALBERO MOTORE TPR CORSA STD Spinotto Ø 12	CRANKSHAFT TPR Standard stroke pin Ø12	VILEBREQUIN TPR COURSE STD Axe de piston Ø 12		9928320	9928320	9928320	9928320
COPERCHIO INGRANAGGI	GEAR COVER	COUVERCLE ENGRENAGES		9930300	9930300	9930300	9930300
COPERCHIO TRASMISSIONE	TRANSMISSION COVER	COUVERCLE TRANSMISSION		9930200	9930200	9930200	9930200
CUSCINETTI DI BANCO TPR CARBONITRURATI Serie	BEARINGS TPR Carbonitrided Series	PALIERI DE VILEBREQUIN TPR CARBONITRURÉS Jeu		9929190	9929190	9929190	9929190
FRIZIONE TPR GP REGOLABILE Patented	CLUTCH TPR GP Adjustable Patented	EMBAYAGE TPR GP RÉGLABLE Patented		9927450	9927450	9927450	9927450
GRUPPO TERMICO RACING MAGGIORATO C/TESTA (GHISA)	RACING CYLINDER KITS BIG BORE with head (CAST IRON)	CYLINDRE COMPLET RACING MAJORÉ AVEC CULASSE (FONTE)		9930030	9930030	9912800	9930030
GRUPPO TERMICO RACING 2004 C/TESTA SCOMPOSTA (GHISA)	RACING CYLINDER KITS BIG BORE without head (CAST IRON)	CYLINDRE COMPLET RACING 2004 AVEC CULASSE DÉCOMPOSÉE (FONTE)				9921160	
GRUPPO TRASFORMAZIONE DA ARIA AD ACQUA (GHISA)	CYLINDER KIT Conversion AC to LC (CAST IRON)	GROUPE TRANSFORMATION DE L'AIR À L'EAU (FONTE)		9911210	9911210		9911210
GRUPPO TERMICO TPR IN ALLUMINIO Ø 47,6 Spinotto Ø 10	CYLINDER KIT TPR ALLUMINIUM Ø 47,6 Pin Ø 10	CYLINDRE COMPLET TPR EN ALUMINIUM Ø 47,6 Axe de Piston Ø 10		9921630	9921630	9928480	9921630
GRUPPO TERMICO TPR IN ALLUMINIO Ø 47,6 Spinotto Ø 12	CYLINDER KIT TPR ALLUMINIUM Ø 47,6 Pin Ø 12	CYLINDRE COMPLET TPR EN ALUMINIUM Ø 47,6 Axe de Piston Ø 12				9928550	
KIT ASPIRAZIONE COMPLETO MIKUNI TM 24 TPR 360	COMPLETE INLET KIT MIKUNI TM 24 TPR 360	KIT ASPIRATION COMPLET MIKUNI TM 24 TPR 360		9930830	9930830	9930830	9930830
KIT ASPIRAZIONE COMPLETO OKO 28 TPR 360	COMPLETE INLET KIT OKO 28 TPR 360	KIT ASPIRATION COMPLET OKO 28 TPR 360		9931710	9931710	9931710	9931710
MAXI KIT 77cc ALESAGGIO Ø 50 CORSA STD	MAXI KIT 77 cc Bore Ø 50 Standard stroke	MAXI KIT 77 cc ALÉSAGE Ø 50 COURSE STD				9926580	
MAXI KIT 86cc ALESAGGIO Ø 50 CORSA 44 mm	MAXI KIT 86 cc Bore Ø 50 stroke 44 mm	MAXI KIT 86 cc ALÉSAGE Ø 50 COURSE 44 mm				9926560	
RAPPORTO ALLUNGATO secondario	SHAFT/GEARS	RAPPORT ALLONGÉ secondaire		990875P	990875P	990875P	990875P
SCARICO NARDÒ 2 omologato	EXHAUST NARDÒ 2 Approved	ÉCHAPPEMENT NARDÒ 2 homologué			9931440	9931440	9931440
SCARICO TPR GP omologato	EXHAUST TPR GP Approved	ÉCHAPPEMENT TPR GP homologué			9930140		
VALVOLA LAMELLARE TPR	REED VALVE TPR	CLAPET À LAMELLES TPR		9931620	9931620	9931620	9931620
VARIOTOP TPR con cinghia	VARIOTOP TPR with belt	VARIOTOP TPR avec courroie		9931670	9931670	9931670	9931670
VARIOTOP TPR con molla	VARIOTOP TPR with spring	VARIOTOP TPR avec ressort		9931650	9931650	9931650	9931650

BENELLI	BENELLI	BENELLI	BENELLI	BENELLI	BENELLI	BENELLI	BENELLI	BETA	BETA	BETA	BETA
PEPE	PEPE LX	PEPE LX	PEPE OLD	PEPE OLD	QUATTRONO-NEX	QUATTRONO-NEX	QUATTRONO-NEX	ARK	ARK LC	CHRONO	CHRONO
10-10	03-04	07-09	07-09	11-11	08-09	10-10	11-11	96-08	96-08	95-97	96-96
50cc 2T AC	50cc 2T AC	50cc 2T AC	50cc 2T AC	50cc 2T AC	50cc 2T AC	50cc 2T AC	50cc 2T AC	50cc 2T AC	50cc 2T LC	50cc 2T AC	50cc 2T AC
Tipo Keeway	MY	Tipo Keeway	Tipo Keeway	Tipo Keeway	Tipo Keeway	Tipo Keeway	Tipo Keeway	MY	MA	MY	MY
	9925910							9925910	9925910	9925910	9925910
	9928320							9928320	9928320	9928320	9928320
	9930300							9930300	9930300	9930300	9930300
	9930200							9930200	9930200	9930200	9930200
	9929190							9929190	9929190	9929190	9929190
	9927450							9927450	9927450	9927450	9927450
	9930030							9930030	9912800	9930030	9930030
									9921160		
	9911210							9911210		9911210	9911210
	9921630							9921630	9928480	9921630	9921630
									9928550		
9930830	9930830	9930830	9930830	9930830	9930830	9930830	9930830	9930830	9930830	9930830	9930830
9931710	9931710	9931710	9931710	9931710	9931710	9931710	9931710	9931710	9931710	9931710	9931710
									9926580		
									9926560		
	990875P							990875P	990875P	990875P	990875P
								9931440	9931440	9931440	9931440
									9930140		
9931620	9931620	9931620	9931620	9931620	9931620	9931620	9931620	9931620	9931620	9931620	9931620
	9931670							9931670	9931670	9931670	9931670
9924900	9931650	9924900	9924900	9924900	9924900	9924900	9924900	9931650	9931650	9931650	9931650

SCOOTER 50cc
RACING

SCOOTER 50cc RACING



BETA	BETA	BETA	BETA
EIKON	QUADRA	QUADRA	TEMPO
99-03	95-95	99-01	93-02
50cc 2T LC	50cc 2T AC	50cc 2T AC	50cc 2T AC
MA	MY	MY	MY

IT	EN	FR					
ALBERO MOTORE TPR CORSA STD Spinotto Ø 10	CRANKSHAFT TPR Standard stroke pin Ø10	VILEBREQUIN TPR COURSE STD Axe de piston Ø 10		9925910	9925910	9925910	9925910
ALBERO MOTORE TPR CORSA STD Spinotto Ø 12	CRANKSHAFT TPR Standard stroke pin Ø12	VILEBREQUIN TPR COURSE STD Axe de piston Ø 12		9928320	9928320	9928320	9928320
COPERCHIO INGRANAGGI	GEAR COVER	COUVERCLE ENGRENAGES		9930300	9930300	9930300	9930300
COPERCHIO TRASMISSIONE	TRANSMISSION COVER	COUVERCLE TRANSMISSION		9930200	9930200	9930200	9930200
CUSCINETTI DI BANCO TPR CARBONITRURATI Serie	BEARINGS TPR Carbonitrided Series	PALIERI DE VILEBREQUIN TPR CARBONITRURÉS Jeu		9929190	9929190	9929190	9929190
FRIZIONE TPR GP REGOLABILE Patented	CLUTCH TPR GP Adjustable Patented	EMBAYAGE TPR GP RÉGLABLE Patented		9927450	9927450		9927450
GRUPPO TERMICO RACING MAGGIORATO C/TESTA (GHISA)	RACING CYLINDER KITS BIG BORE with head (CAST IRON)	CYLINDRE COMPLET RACING MAJORÉ AVEC CULASSE (FONTE)		9912800	9930030	9930030	9930030
GRUPPO TERMICO RACING 2004 C/TESTA SCOMPOSTA (GHISA)	RACING CYLINDER KITS BIG BORE without head (CAST IRON)	CYLINDRE COMPLET RACING 2004 AVEC CULASSE DÉCOMPOSÉE (FONTE)		9921160			
GRUPPO TRASFORMAZIONE DA ARIA AD ACQUA (GHISA)	CYLINDER KIT Conversion AC to LC (CAST IRON)	GROUPE TRANSFORMATION DE L'AIR À L'EAU (FONTE)			9911210	9911210	9911210
GRUPPO TERMICO TPR IN ALLUMINIO Ø 47,6 Spinotto Ø 10	CYLINDER KIT TPR ALLUMINIUM Ø 47,6 Pin Ø 10	CYLINDRE COMPLET TPR EN ALUMINIUM Ø 47,6 Axe de Piston Ø 10		9928480	9921630	9921630	9921630
GRUPPO TERMICO TPR IN ALLUMINIO Ø 47,6 Spinotto Ø 12	CYLINDER KIT TPR ALLUMINIUM Ø 47,6 Pin Ø 12	CYLINDRE COMPLET TPR EN ALUMINIUM Ø 47,6 Axe de Piston Ø 12		9928550			
KIT ASPIRAZIONE COMPLETO MIKUNI TM 24 TPR 360	COMPLETE INLET KIT MIKUNI TM 24 TPR 360	KIT ASPIRATION COMPLET MIKUNI TM 24 TPR 360		9930830	9930830	9930830	9930830
KIT ASPIRAZIONE COMPLETO OKO 28 TPR 360	COMPLETE INLET KIT OKO 28 TPR 360	KIT ASPIRATION COMPLET OKO 28 TPR 360		9931710	9931710	9931710	9931710
MAXI KIT 77cc ALESAGGIO Ø 50 CORSA STD	MAXI KIT 77 cc Bore Ø 50 Standard stroke	MAXI KIT 77 cc ALÉSAGE Ø 50 COURSE STD		9926580			
MAXI KIT 86cc ALESAGGIO Ø 50 CORSA 44 mm	MAXI KIT 86 cc Bore Ø 50 stroke 44 mm	MAXI KIT 86 cc ALÉSAGE Ø 50 COURSE 44 mm		9926560			
RAPPORTO ALLUNGATO secondario	SHAFT/GEARS	RAPPORT ALLONGÉ secondaire		990875P	990875P	990875P	990875P
SCARICO NARDÒ 2 omologato	EXHAUST NARDÒ 2 Approved	ÉCHAPPEMENT NARDÒ 2 homologué		9931440	9931440	9931440	9931440
SCARICO TPR GP omologato	EXHAUST TPR GP Approved	ÉCHAPPEMENT TPR GP homologué		9930140			
VALVOLA LAMELLARE TPR	REED VALVE TPR	CLAPET À LAMELLES TPR		9931620	9931620	9931620	9931620
VARIOTOP TPR con cinghia	VARIOTOP TPR with belt	VARIOTOP TPR avec courroie		9931670	9931670	9931670	9931670
VARIOTOP TPR con molla	VARIOTOP TPR with spring	VARIOTOP TPR avec ressort		9931650	9931650	9931650	9931650

BETA	CPI	CPI	CPI	CPI	DERBI	DERBI	DERBI	DERBI	DERBI	DERBI	DERBI
TEMPO	ARAGON	HUSSAR	OLIVER	POP CORN	ATLANTIS 2T	ATLANTIS 2T EU2	ATLANTIS 4T	ATLANTIS 4T EU2	ATLANTIS 02	ATLANTIS 02 BULLET	ATLANTIS 02 CITY
95-95	03-03	03-03	03-03	03-03	10-10	07-09	04-06	07-07	02-02	03-05	04-06
50cc 2T AC	50cc 2T AC	50cc 2T AC	50cc 2T AC	50cc 2T AC	50cc 2T AC	50cc 2T AC	50cc 4T AC	50cc 4T AC	50cc 2T AC	50cc 2T AC	50cc 2T AC
MY	Tipo Keeway	Tipo Keeway	Tipo Keeway	Tipo Keeway	Motore Piaggio	Motore Piaggio	Motore Piaggio	Motore Piaggio	Motore Piaggio	Motore Piaggio	Motore Piaggio
9925910											
9928320					9926180	9926180			9926180	9926180	9926180
9930300											
9930200											
9929190					9929200	9929200				9929200	9929200
9927450					9928340	9928340	9928340	9928340	9928340	9928340	9928340
9930030					9930060	9930060			9930060	9930060	9930060
9911210											
9921630											
					9921550	9921550			9921550	9921550	9921550
9930830	9930830	9930830	9930830	9930830	9930870	9930870			9930870	9930870	9930870
9931710	9931710	9931710	9931710	9931710	9931730	9931730			9931730	9931730	9931730
990875P											
9931440					9931460	9931460			9931460	9931460	9931460
9931620	9931620	9931620	9931620	9931620	9931640	9931640			9931640	9931640	9931640
9931670					9931300	9931300			9931300	9931300	9931300
9931650	9924900	9924900	9924900	9924900	9927610	9927610			9927610	9927610	9927610

SCOOTER 50cc RACING

SCOOTER 50cc RACING



DERBI	DERBI	DERBI	DERBI
ATLANTIS 02 RED BULLET	ATLANTIS 02 TWO CHIC	BOULEVARD 2T	BOULEVARD 4T EU2 25KM/H
03-03	05-05	09-14	09-09
50cc 2T AC	50cc 2T AC	50cc 2T AC	50cc 4T AC
Motore Piaggio	Motore Piaggio	Motore Piaggio	Motore Piaggio

IT	EN	FR				
ALBERO MOTORE TPR CORSA STD Spinotto Ø 10	CRANKSHAFT TPR Standard stroke pin Ø10	VILEBREQUIN TPR COURSE STD Axe de piston Ø 10				
ALBERO MOTORE TPR CORSA STD Spinotto Ø 12	CRANKSHAFT TPR Standard stroke pin Ø12	VILEBREQUIN TPR COURSE STD Axe de piston Ø 12		9926180	9926180	9926180
COPERCHIO INGRANAGGI	GEAR COVER	COUVERCLE ENGRENAGES				
COPERCHIO TRASMISSIONE	TRANSMISSION COVER	COUVERCLE TRANSMISSION				
CUSCINETTI DI BANCO TPR CARBONITRURATI Serie	BEARINGS TPR Carbonitrided Series	PALIERI DE VILEBREQUIN TPR CARBONITRURÉS Jeu		9929200	9929200	
FRIZIONE TPR GP REGOLABILE Patented	CLUTCH TPR GP Adjustable Patented	EMBAYAGE TPR GP RÉGLABLE Patented		9928340	9928340	9928340
GRUPPO TERMICO RACING MAGGIORATO C/TESTA (GHISA)	RACING CYLINDER KITS BIG BORE with head (CAST IRON)	CYLINDRE COMPLET RACING MAJORÉ AVEC CULASSE (FONTE)		9930060	9930060	9930060
GRUPPO TERMICO RACING 2004 C/TESTA SCOMPOSTA (GHISA)	RACING CYLINDER KITS BIG BORE without head (CAST IRON)	CYLINDRE COMPLET RACING 2004 AVEC CULASSE DÉCOMPOSÉE (FONTE)				
GRUPPO TRASFORMAZIONE DA ARIA AD ACQUA (GHISA)	CYLINDER KIT Conversion AC to LC (CAST IRON)	GROUPE TRANSFORMATION DE L'AIR À L'EAU (FONTE)				
GRUPPO TERMICO TPR IN ALLUMINIO Ø 47,6 Spinotto Ø 10	CYLINDER KIT TPR ALLUMINIUM Ø 47,6 Pin Ø 10	CYLINDRE COMPLET TPR EN ALUMINIUM Ø 47,6 Axe de Piston Ø 10				
GRUPPO TERMICO TPR IN ALLUMINIO Ø 47,6 Spinotto Ø 12	CYLINDER KIT TPR ALLUMINIUM Ø 47,6 Pin Ø 12	CYLINDRE COMPLET TPR EN ALUMINIUM Ø 47,6 Axe de Piston Ø 12		9921550	9921550	9921550
KIT ASPIRAZIONE COMPLETO MIKUNI TM 24 TPR 360	COMPLETE INLET KIT MIKUNI TM 24 TPR 360	KIT ASPIRATION COMPLET MIKUNI TM 24 TPR 360		9930870	9930870	9930870
KIT ASPIRAZIONE COMPLETO OKO 28 TPR 360	COMPLETE INLET KIT OKO 28 TPR 360	KIT ASPIRATION COMPLET OKO 28 TPR 360		9931730	9931730	9931730
MAXI KIT 77cc ALESAGGIO Ø 50 CORSA STD	MAXI KIT 77 cc Bore Ø 50 Standard stroke	MAXI KIT 77 cc ALÉSAGE Ø 50 COURSE STD				
MAXI KIT 86cc ALESAGGIO Ø 50 CORSA 44 mm	MAXI KIT 86 cc Bore Ø 50 stroke 44 mm	MAXI KIT 86 cc ALÉSAGE Ø 50 COURSE 44 mm				
RAPPORTO ALLUNGATO secondario	SHAFT/GEARS	RAPPORT ALLONGÉ secondaire				
SCARICO NARDÒ 2 omologato	EXHAUST NARDÒ 2 Approved	ÉCHAPPEMENT NARDÒ 2 homologué		9931460	9931460	9931460
SCARICO TPR GP omologato	EXHAUST TPR GP Approved	ÉCHAPPEMENT TPR GP homologué				
VALVOLA LAMELLARE TPR	REED VALVE TPR	CLAPET À LAMELLES TPR		9931640	9931640	9931640
VARIOTOP TPR con cinghia	VARIOTOP TPR with belt	VARIOTOP TPR avec courroie		9931300	9931300	
VARIOTOP TPR con molla	VARIOTOP TPR with spring	VARIOTOP TPR avec ressort		9927610	9927610	9927610

DERBI	DERBI	DERBI	DERBI	DERBI	DERBI	EXPLORER	GARELLI	GILERA	GILERA	GILERA	GILERA
GP1	GP1	GP1 EU 2	GP1 OPEN EU2	GP1 RACE EU2	SONAR 2T	CRACKER	GPS	DNA	DNA	DNA GP EXPERIENCE	EASY MOVING
01-02	03-03	05-05	06-09	05-07	09-09	03-03	09-11	00-02	05-07	03-04	95-96
50cc 2T LC	50cc 2T LC	50cc 2T LC	50cc 2T LC	50cc 2T LC	50cc 2T AC	50cc 2T AC	50cc 2T LC	50cc 2T LC	50cc 2T LC	50cc 2T LC	50cc 2T AC
Motore Piaggio	Motore Piaggio	Motore Piaggio	Motore Piaggio	Motore Piaggio	Motore Piaggio	Tipo Keeway	Tipo MA	Motore Piaggio	Motore Piaggio	Motore Piaggio	Motore Piaggio
9926180	9926180	9926180	9926180	9926180	9926180			9926180	9926180	9926180	9926180
9929200	9929200	9929200	9929200	9929200	9929200			9929200	9929200	9929200	9929200
9928340	9928340	9928340	9928340	9928340	9928340			9928340	9928340	9928340	9928340
9920590	9920590	9920590	9920590	9920590	9930060			9920590	9920590	9920590	9930060
9928520	9928520	9928520	9928520	9928520	9921550			9928520	9928520	9928520	9921550
9930870	9930870	9930870	9930870	9930870	9930870	9930830	9930830	9930870	9930870	9930870	9930870
9931730	9931730	9931730	9931730	9931730	9931730	9931710	9931710	9931730	9931730	9931730	9931730
9928390	9928390	9928390	9928390	9928390				9928390	9928390	9928390	
9928440	9928440	9928440	9928440	9928440				9928440	9928440	9928440	
9931460	9931460	9931460	9931460	9931460	9931460			9931460	9931460	9931460	9931460
9930160	9930160	9930160	9930160	9930160				9930160	9930160	9930160	
9931640	9931640	9931640	9931640	9931640	9931640	9931620		9931640	9931640	9931640	9931640
9931300	9931300	9931300	9931300	9931300							
9927610	9927610	9927610	9927610	9927610	9927610	9924900		9927610	9927610	9927610	9927610

SCOOTER 50cc RACING

SCOOTER 50cc RACING



GILERA	GILERA	GILERA	GILERA
ICE	RUNNER	RUNNER POGGIALI	RUNNER PURE JET
01-05	97-00	02-02	02-04
50cc 2T AC	50cc 2T LC	50cc 2T LC	50cc 2T-IE LC
Motore Piaggio	Motore Piaggio	Motore Piaggio	Motore Piaggio

IT	EN	FR				
ALBERO MOTORE TPR CORSA STD Spinotto Ø 10	CRANKSHAFT TPR Standard stroke pin Ø10	VILEBREQUIN TPR COURSE STD Axe de piston Ø 10				
ALBERO MOTORE TPR CORSA STD Spinotto Ø 12	CRANKSHAFT TPR Standard stroke pin Ø12	VILEBREQUIN TPR COURSE STD Axe de piston Ø 12		9926180	9926180	9926180
COPERCHIO INGRANAGGI	GEAR COVER	COUVERCLE ENGRENAGES				
COPERCHIO TRASMISSIONE	TRANSMISSION COVER	COUVERCLE TRANSMISSION				
CUSCINETTI DI BANCO TPR CARBONITRURATI Serie	BEARINGS TPR Carbonitrided Series	PALIERI DE VILEBREQUIN TPR CARBONITRURÉS Jeu		9929200	9929200	9929200
FRIZIONE TPR GP REGOLABILE Patented	CLUTCH TPR GP Adjustable Patented	EMBAYAGE TPR GP RÉGLABLE Patented		9928340	9928340	9928340
GRUPPO TERMICO RACING MAGGIORATO C/TESTA (GHISA)	RACING CYLINDER KITS BIG BORE with head (CAST IRON)	CYLINDRE COMPLET RACING MAJORÉ AVEC CULASSE (FONTE)		9930060	9920590	9920590
GRUPPO TERMICO RACING 2004 C/TESTA SCOMPOSTA (GHISA)	RACING CYLINDER KITS BIG BORE without head (CAST IRON)	CYLINDRE COMPLET RACING 2004 AVEC CULASSE DÉCOMPOSÉE (FONTE)				
GRUPPO TRASFORMAZIONE DA ARIA AD ACQUA (GHISA)	CYLINDER KIT Conversion AC to LC (CAST IRON)	GROUPE TRANSFORMATION DE L'AIR À L'EAU (FONTE)				
GRUPPO TERMICO TPR IN ALLUMINIO Ø 47,6 Spinotto Ø 10	CYLINDER KIT TPR ALLUMINIUM Ø 47,6 Pin Ø 10	CYLINDRE COMPLET TPR EN ALUMINIUM Ø 47,6 Axe de Piston Ø 10				
GRUPPO TERMICO TPR IN ALLUMINIO Ø 47,6 Spinotto Ø 12	CYLINDER KIT TPR ALLUMINIUM Ø 47,6 Pin Ø 12	CYLINDRE COMPLET TPR EN ALUMINIUM Ø 47,6 Axe de Piston Ø 12		9921550	9928520	9928520
KIT ASPIRAZIONE COMPLETO MIKUNI TM 24 TPR 360	COMPLETE INLET KIT MIKUNI TM 24 TPR 360	KIT ASPIRATION COMPLET MIKUNI TM 24 TPR 360		9930870	9930870	9930870
KIT ASPIRAZIONE COMPLETO OKO 28 TPR 360	COMPLETE INLET KIT OKO 28 TPR 360	KIT ASPIRATION COMPLET OKO 28 TPR 360		9931730	9931730	9931730
MAXI KIT 77cc ALESAGGIO Ø 50 CORSA STD	MAXI KIT 77 cc Bore Ø 50 Standard stroke	MAXI KIT 77 cc ALÉSAGE Ø 50 COURSE STD			9928390	9928390
MAXI KIT 86cc ALESAGGIO Ø 50 CORSA 44 mm	MAXI KIT 86 cc Bore Ø 50 stroke 44 mm	MAXI KIT 86 cc ALÉSAGE Ø 50 COURSE 44 mm			9928440	9928440
RAPPORTO ALLUNGATO secondario	SHAFT/GEARS	RAPPORT ALLONGÉ secondaire				
SCARICO NARDÒ 2 omologato	EXHAUST NARDÒ 2 Approved	ÉCHAPPEMENT NARDÒ 2 homologué		9931460	9931460	9931460
SCARICO TPR GP omologato	EXHAUST TPR GP Approved	ÉCHAPPEMENT TPR GP homologué			9930160	9930160
VALVOLA LAMELLARE TPR	REED VALVE TPR	CLAPET À LAMELLES TPR		9931640	9931640	9931640
VARIOTOP TPR con cinghia	VARIOTOP TPR with belt	VARIOTOP TPR avec courroie		9931300	9931300	9931300
VARIOTOP TPR con molla	VARIOTOP TPR with spring	VARIOTOP TPR avec ressort		9927610	9927610	9927610

GILERA	GILERA	GILERA	GILERA	GILERA	GILERA	GILERA	GILERA	GILERA	GILERA	GILERA	GILERA
RUNNER PURE JET	RUNNER PURE JET	RUNNER PURE JET	RUNNER PURE JET ST	RUNNER SP	RUNNER SP	RUNNER SP	RUNNER SP	RUNNER SP SPECIAL EDITION	RUNNER SP ST & SIMONCELLI	STALKER	STALKER
05-06	07-07	10-11	08-08	02-04	05-06	07-07	10-12	07-07	08-09	97-04	05-06
50cc 2T-IE LC	50cc 2T-IE LC	50cc 2T-IE LC	50cc 2T-IE LC	50cc 2T LC	50cc 2T LC	50cc 2T LC	50cc 2T LC	50cc 2T LC	50cc 2T LC	50cc 2T AC	50cc 2T AC
Motore Piaggio	Motore Piaggio	Motore Piaggio	Motore Piaggio	Motore Piaggio	Motore Piaggio	Motore Piaggio	Motore Piaggio	Motore Piaggio	Motore Piaggio	Motore Piaggio	Motore Piaggio
				9926180	9926180	9926180	9926180	9926180	9926180	9926180	9926180
9929200	9929200	9929200	9929200	9929200	9929200	9929200	9929200	9929200	9929200	9929200	9929200
9928340	9928340	9928340	9928340	9928340	9928340	9928340	9928340	9928340	9928340	9928340	9928340
				9920590	9920590	9920590	9920590	9920590	9920590	9930060	9930060
				9928520	9928520	9928520	9928520	9928520	9928520	9921550	9921550
				9930870	9930870	9930870	9930870	9930870	9930870	9930870	9930870
				9931730	9931730	9931730	9931730	9931730	9931730	9931730	9931730
				9928390	9928390	9928390	9928390	9928390	9928390		
				9928440	9928440	9928440	9928440	9928440	9928440		
9931460	9931460	9931460	9931460	9931460	9931460	9931460	9931460	9931460	9931460	9931460	9931460
				9930160	9930160	9930160	9930160	9930160	9930160		
9931640	9931640	9931640	9931640	9931640	9931640	9931640	9931640	9931640	9931640	9931640	9931640
9931300	9931300	9931300		9931300						9931300	9931300
9927610	9927610	9927610		9927610	9927610	9927610	9927610	9927610	9927610	9927610	9927610

SCOOTER 50cc RACING

SCOOTER 50cc RACING



GILERA	GILERA	GILERA	GILERA
STALKER	STALKER	STALKER NAKED	STALKER SPECIAL EDITION
07-08	09-11	08-08	07-08
50cc 2T AC	50cc 2T AC	50cc 2T AC	50cc 2T AC
Motore Piaggio	Motore Piaggio	Motore Piaggio	Motore Piaggio

IT	EN	FR				
ALBERO MOTORE TPR CORSA STD Spinotto Ø 10	CRANKSHAFT TPR Standard stroke pin Ø10	VILEBREQUIN TPR COURSE STD Axe de piston Ø 10				
ALBERO MOTORE TPR CORSA STD Spinotto Ø 12	CRANKSHAFT TPR Standard stroke pin Ø12	VILEBREQUIN TPR COURSE STD Axe de piston Ø 12		9926180	9926180	9926180
COPERCHIO INGRANAGGI	GEAR COVER	COUVERCLE ENGRENAGES				
COPERCHIO TRASMISSIONE	TRANSMISSION COVER	COUVERCLE TRANSMISSION				
CUSCINETTI DI BANCO TPR CARBONITRURATI Serie	BEARINGS TPR Carbonitrided Series	PALIERI DE VILEBREQUIN TPR CARBONITRURÉS Jeu		9929200	9929200	9929200
FRIZIONE TPR GP REGOLABILE Patented	CLUTCH TPR GP Adjustable Patented	EMBAYAGE TPR GP RÉGLABLE Patented		9928340	9928340	9928340
GRUPPO TERMICO RACING MAGGIORATO C/TESTA (GHISA)	RACING CYLINDER KITS BIG BORE with head (CAST IRON)	CYLINDRE COMPLET RACING MAJORÉ AVEC CULASSE (FONTE)		9930060	9930060	9930060
GRUPPO TERMICO RACING 2004 C/TESTA SCOMPOSTA (GHISA)	RACING CYLINDER KITS BIG BORE without head (CAST IRON)	CYLINDRE COMPLET RACING 2004 AVEC CULASSE DÉCOMPOSÉE (FONTE)				
GRUPPO TRASFORMAZIONE DA ARIA AD ACQUA (GHISA)	CYLINDER KIT Conversion AC to LC (CAST IRON)	GROUPE TRANSFORMATION DE L'AIR À L'EAU (FONTE)				
GRUPPO TERMICO TPR IN ALLUMINIO Ø 47,6 Spinotto Ø 10	CYLINDER KIT TPR ALLUMINIUM Ø 47,6 Pin Ø 10	CYLINDRE COMPLET TPR EN ALUMINIUM Ø 47,6 Axe de Piston Ø 10				
GRUPPO TERMICO TPR IN ALLUMINIO Ø 47,6 Spinotto Ø 12	CYLINDER KIT TPR ALLUMINIUM Ø 47,6 Pin Ø 12	CYLINDRE COMPLET TPR EN ALUMINIUM Ø 47,6 Axe de Piston Ø 12		9921550	9921550	9921550
KIT ASPIRAZIONE COMPLETO MIKUNI TM 24 TPR 360	COMPLETE INLET KIT MIKUNI TM 24 TPR 360	KIT ASPIRATION COMPLET MIKUNI TM 24 TPR 360		9930870	9930870	9930870
KIT ASPIRAZIONE COMPLETO OKO 28 TPR 360	COMPLETE INLET KIT OKO 28 TPR 360	KIT ASPIRATION COMPLET OKO 28 TPR 360		9931730	9931730	9931730
MAXI KIT 77cc ALESAGGIO Ø 50 CORSA STD	MAXI KIT 77 cc Bore Ø 50 Standard stroke	MAXI KIT 77 cc ALÉSAGE Ø 50 COURSE STD				
MAXI KIT 86cc ALESAGGIO Ø 50 CORSA 44 mm	MAXI KIT 86 cc Bore Ø 50 stroke 44 mm	MAXI KIT 86 cc ALÉSAGE Ø 50 COURSE 44 mm				
RAPPORTO ALLUNGATO secondario	SHAFT/GEARS	RAPPORT ALLONGÉ secondaire				
SCARICO NARDÒ 2 omologato	EXHAUST NARDÒ 2 Approved	ÉCHAPPEMENT NARDÒ 2 homologué		9931460	9931460	9931460
SCARICO TPR GP omologato	EXHAUST TPR GP Approved	ÉCHAPPEMENT TPR GP homologué				
VALVOLA LAMELLARE TPR	REED VALVE TPR	CLAPET À LAMELLES TPR		9931640	9931640	9931640
VARIOTOP TPR con cinghia	VARIOTOP TPR with belt	VARIOTOP TPR avec courroie		9931300	9931300	9931300
VARIOTOP TPR con molla	VARIOTOP TPR with spring	VARIOTOP TPR avec ressort		9927610	9927610	9927610

GILERA	GILERA	GILERA	GILERA	GILERA	ITALJET	ITALJET	ITALJET	ITALJET	ITALJET	ITALJET	ITALJET
STORM	STORM EURO 2	TYPHOON	TYPHOON X	TYPHOON XR	BAZOOKA	DRAGSTER	JET SET	PISTA	PISTA 2	SCOOP	SCOOP 2
94-95	07-07	94-97	98-99	00-00	91-94	98-02	02-02	92-97	97-98	91-95	96-98
50cc 2T AC	50cc 2T AC	50cc 2T AC	50cc 2T AC	50cc 2T AC	50cc 2T AC	50cc 2T LC	50cc 2T AC	50cc 2T AC	50cc 2T AC	50cc 2T AC	50cc 2T AC
Motore Piaggio	Motore Piaggio	Motore Piaggio	Motore Piaggio	Motore Piaggio	Tipo CW	MA	Motore Piaggio	Tipo CW	Tipo CW	Tipo CW	Tipo CW
						9925910					
9926180	9926180	9926180	9926180	9926180		9928320	9926180				
						9930300					
						9930200					
9929200	9929200	9929200	9929200	9929200		9929190	9929200				
9928340	9928340	9928340	9928340	9928340	9927450	9927450	9928340	9927450	9927450	9927450	9927450
9930060	9930060	9930060	9930060	9930060		9912800	9930060				
						9921160					
						9928480					
9921550	9921550	9921550	9921550	9921550		9928550	9921550				
9930870	9930870	9930870	9930870	9930870		9930830	9930870				
9931730	9931730	9931730	9931730	9931730		9931710	9931730				
						9926580					
						9926560					
						990875P					
9931460	9931460	9931460	9931460	9931460	9931450	9931440	9931460	9931450	9931450	9931450	9931450
						9930140					
9931640	9931640	9931640	9931640	9931640		9931620	9931640				
	9931300			9931300		9931670					
9927610	9927610	9927610	9927610	9927610		9931650	9927610				

SCOOTER 50cc RACING

SCOOTER 50cc RACING



ITALJET	ITALJET	ITALJET	KEEWAY
TORPEDO	TORPEDO NEW	YANKEE	F-ACT
97-00	00-01	93-97	07-08
50cc 4T AC	50cc 2T AC	50cc 2T AC	50cc 2T AC
Motore Piaggio	Motore Piaggio	Tipo CW	Motore Keeway

IT	EN	FR				
ALBERO MOTORE TPR CORSA STD Spinotto Ø 10	CRANKSHAFT TPR Standard stroke pin Ø10	VILEBREQUIN TPR COURSE STD Axe de piston Ø 10				
ALBERO MOTORE TPR CORSA STD Spinotto Ø 12	CRANKSHAFT TPR Standard stroke pin Ø12	VILEBREQUIN TPR COURSE STD Axe de piston Ø 12			9926180	
COPERCHIO INGRANAGGI	GEAR COVER	COUVERCLE ENGRENAGES				
COPERCHIO TRASMISSIONE	TRANSMISSION COVER	COUVERCLE TRANSMISSION				
CUSCINETTI DI BANCO TPR CARBONITRURATI Serie	BEARINGS TPR Carbonitrided Series	PALIERI DE VILEBREQUIN TPR CARBONITRURÉS Jeu			9929200	
FRIZIONE TPR GP REGOLABILE Patented	CLUTCH TPR GP Adjustable Patented	EMBAYAGE TPR GP RÉGLABLE Patented		9928340	9928340	9927450
GRUPPO TERMICO RACING MAGGIORATO C/TESTA (GHISA)	RACING CYLINDER KITS BIG BORE with head (CAST IRON)	CYLINDRE COMPLET RACING MAJORÉ AVEC CULASSE (FONTE)			9930060	
GRUPPO TERMICO RACING 2004 C/TESTA SCOMPOSTA (GHISA)	RACING CYLINDER KITS BIG BORE without head (CAST IRON)	CYLINDRE COMPLET RACING 2004 AVEC CULASSE DÉCOMPOSÉE (FONTE)				
GRUPPO TRASFORMAZIONE DA ARIA AD ACQUA (GHISA)	CYLINDER KIT Conversion AC to LC (CAST IRON)	GROUPE TRANSFORMATION DE L'AIR À L'EAU (FONTE)				
GRUPPO TERMICO TPR IN ALLUMINIO Ø 47,6 Spinotto Ø 10	CYLINDER KIT TPR ALLUMINIUM Ø 47,6 Pin Ø 10	CYLINDRE COMPLET TPR EN ALUMINIUM Ø 47,6 Axe de Piston Ø 10				
GRUPPO TERMICO TPR IN ALLUMINIO Ø 47,6 Spinotto Ø 12	CYLINDER KIT TPR ALLUMINIUM Ø 47,6 Pin Ø 12	CYLINDRE COMPLET TPR EN ALUMINIUM Ø 47,6 Axe de Piston Ø 12			9921550	
KIT ASPIRAZIONE COMPLETO MIKUNI TM 24 TPR 360	COMPLETE INLET KIT MIKUNI TM 24 TPR 360	KIT ASPIRATION COMPLET MIKUNI TM 24 TPR 360			9930870	9930830
KIT ASPIRAZIONE COMPLETO OKO 28 TPR 360	COMPLETE INLET KIT OKO 28 TPR 360	KIT ASPIRATION COMPLET OKO 28 TPR 360			9931730	9931710
MAXI KIT 77cc ALESAGGIO Ø 50 CORSA STD	MAXI KIT 77 cc Bore Ø 50 Standard stroke	MAXI KIT 77 cc ALÉSAGE Ø 50 COURSE STD				
MAXI KIT 86cc ALESAGGIO Ø 50 CORSA 44 mm	MAXI KIT 86 cc Bore Ø 50 stroke 44 mm	MAXI KIT 86 cc ALÉSAGE Ø 50 COURSE 44 mm				
RAPPORTO ALLUNGATO secondario	SHAFT/GEARS	RAPPORT ALLONGÉ secondaire				
SCARICO NARDÒ 2 omologato	EXHAUST NARDÒ 2 Approved	ÉCHAPPEMENT NARDÒ 2 homologué			9931460	9931450
SCARICO TPR GP omologato	EXHAUST TPR GP Approved	ÉCHAPPEMENT TPR GP homologué				
VALVOLA LAMELLARE TPR	REED VALVE TPR	CLAPET À LAMELLES TPR			9931640	9931620
VARIOTOP TPR con cinghia	VARIOTOP TPR with belt	VARIOTOP TPR avec courroie				
VARIOTOP TPR con molla	VARIOTOP TPR with spring	VARIOTOP TPR avec ressort		9927610	9927610	9924900

KEEWAY	KEEWAY	KEEWAY	KEEWAY	KEEWAY	KEEWAY	KEEWAY	KTM	KYMC0	KYMC0	KYMC0	KYMC0																																																
FLASH	FOCUS	GOCCIA	HURRICANE	MATRIX	PIXEL EURO 2	RY8	K50	AGILITY 4T CARRY	AGILITY 4T R10	AGILITY 4T R10	AGILITY 4T R12																																																
07-08	06-06	09-09	06-08	06-08	09-12	08-08	96-01	11-11	06-06	07-08	07-08																																																
50cc 2T AC	50cc 2T AC	50cc 2T AC	50cc 2T AC	50cc 2T AC	50cc 2T AC	50cc 2T AC	50cc 2T AC	50cc 4T AC	50cc 4T AC	50cc 4T AC	50cc 4T AC																																																
Motore Keeway	Motore Keeway	Motore Keeway	Motore Keeway	Motore Keeway	Motore Keeway	Motore Keeway	MY	Motore Kymco	Motore Kymco	Motore Kymco	Motore Kymco																																																
							9925910	<div style="background-color: red; color: white; padding: 5px; text-align: center; font-weight: bold;"> Il codice 9937610 è applicabile anche ai modelli KYMCO sottostanti </div> <table border="1" style="width: 100%; border-collapse: collapse;"> <tr> <td>AGILITY 4T R16 PLUS EURO4</td> <td>19-19</td> <td>50cc 4T AC</td> </tr> <tr> <td>AGILITY CARRY 4T EURO4</td> <td>19-19</td> <td>50cc 4T AC</td> </tr> <tr> <td>AGILITY PLUS 4T</td> <td>14-14</td> <td>50cc 4T AC</td> </tr> <tr> <td>AGILITY R12</td> <td>05-05</td> <td>50cc 4T AC</td> </tr> <tr> <td>AGILITY R12 ECS</td> <td>16-16</td> <td>50cc 4T AC</td> </tr> <tr> <td>AGILITY R16</td> <td>08-08</td> <td>50cc 4T AC</td> </tr> <tr> <td>AGILITY R16</td> <td>09-09</td> <td>50cc 4T AC</td> </tr> <tr> <td>AGILITY R16</td> <td>12-12</td> <td>50cc 4T AC</td> </tr> <tr> <td>AGILITY RS</td> <td>09-09</td> <td>50cc 4T AC</td> </tr> <tr> <td>DINK 50 4T</td> <td>07-07</td> <td>50cc 4T AC</td> </tr> <tr> <td>FILLY</td> <td>98-00</td> <td>50cc 4T AC</td> </tr> <tr> <td>FILLY LX</td> <td>01-02</td> <td>50cc 4T AC</td> </tr> <tr> <td>LIKE</td> <td>09-09</td> <td>50cc 4T AC</td> </tr> <tr> <td>LIKE</td> <td>09-09</td> <td>50cc 4T AC</td> </tr> <tr> <td>LIKE EURO4 4T</td> <td>18-18</td> <td>50cc 4T AC</td> </tr> <tr> <td>PEOPLE S 4T</td> <td>06-08</td> <td>50cc 4T AC</td> </tr> </table>				AGILITY 4T R16 PLUS EURO4	19-19	50cc 4T AC	AGILITY CARRY 4T EURO4	19-19	50cc 4T AC	AGILITY PLUS 4T	14-14	50cc 4T AC	AGILITY R12	05-05	50cc 4T AC	AGILITY R12 ECS	16-16	50cc 4T AC	AGILITY R16	08-08	50cc 4T AC	AGILITY R16	09-09	50cc 4T AC	AGILITY R16	12-12	50cc 4T AC	AGILITY RS	09-09	50cc 4T AC	DINK 50 4T	07-07	50cc 4T AC	FILLY	98-00	50cc 4T AC	FILLY LX	01-02	50cc 4T AC	LIKE	09-09	50cc 4T AC	LIKE	09-09	50cc 4T AC	LIKE EURO4 4T	18-18	50cc 4T AC	PEOPLE S 4T	06-08	50cc 4T AC
AGILITY 4T R16 PLUS EURO4	19-19	50cc 4T AC																																																									
AGILITY CARRY 4T EURO4	19-19	50cc 4T AC																																																									
AGILITY PLUS 4T	14-14	50cc 4T AC																																																									
AGILITY R12	05-05	50cc 4T AC																																																									
AGILITY R12 ECS	16-16	50cc 4T AC																																																									
AGILITY R16	08-08	50cc 4T AC																																																									
AGILITY R16	09-09	50cc 4T AC																																																									
AGILITY R16	12-12	50cc 4T AC																																																									
AGILITY RS	09-09	50cc 4T AC																																																									
DINK 50 4T	07-07	50cc 4T AC																																																									
FILLY	98-00	50cc 4T AC																																																									
FILLY LX	01-02	50cc 4T AC																																																									
LIKE	09-09	50cc 4T AC																																																									
LIKE	09-09	50cc 4T AC																																																									
LIKE EURO4 4T	18-18	50cc 4T AC																																																									
PEOPLE S 4T	06-08	50cc 4T AC																																																									
							9928320																																																				
							9930300																																																				
							9930200																																																				
							9929190																																																				
							9927450																																																				
							9930030																																																				
							9911210																																																				
							9921630																																																				
9930830	9930830	9930830	9930830	9930830	9930830	9930830	9930830																																																				
9931710	9931710	9931710	9931710	9931710	9931710	9931710	9931710																																																				
							990875P																																																				
							9931620																																																				
							9931620																																																				
							9931620																																																				
							9931620																																																				
							9931670																																																				
9924900	9924900	9924900	9924900	9924900	9924900	9924900	9931650	9937610	9937610	9937610	9937610																																																

SCOOTER 50cc RACING

SCOOTER 50cc RACING



KYMCO	KYMCO	KYMCO	KYMCO
SENTO	SUPER 8 4T	SUPER 8 4T	VITALITY 4T
08-08	07-07	09-09	04-04
50cc 4T AC	50cc 4T AC	50cc 4T AC	50cc 4T AC
Motore Kymco	Motore Kymco	Motore Kymco	Motore Kymco

IT	EN	FR				
ALBERO MOTORE TPR CORSA STD Spinotto Ø 10	CRANKSHAFT TPR Standard stroke pin Ø10	VILEBREQUIN TPR COURSE STD Axe de piston Ø 10				
ALBERO MOTORE TPR CORSA STD Spinotto Ø 12	CRANKSHAFT TPR Standard stroke pin Ø12	VILEBREQUIN TPR COURSE STD Axe de piston Ø 12				
COPERCHIO INGRANAGGI	GEAR COVER	COUVERCLE ENGRENAGES				
COPERCHIO TRASMISSIONE	TRANSMISSION COVER	COUVERCLE TRANSMISSION				
CUSCINETTI DI BANCO TPR CARBONITRURATI Serie	BEARINGS TPR Carbonitrided Series	PALIERI DE VILEBREQUIN TPR CARBONITRURÉS Jeu				
FRIZIONE TPR GP REGOLABILE Patented	CLUTCH TPR GP Adjustable Patented	EMBAYAGE TPR GP RÉGLABLE Patented				
GRUPPO TERMICO RACING MAGGIORATO C/TESTA (GHISA)	RACING CYLINDER KITS BIG BORE with head (CAST IRON)	CYLINDRE COMPLET RACING MAJORÉ AVEC CULASSE (FONTE)				
GRUPPO TERMICO RACING 2004 C/TESTA SCOMPOSTA (GHISA)	RACING CYLINDER KITS BIG BORE without head (CAST IRON)	CYLINDRE COMPLET RACING 2004 AVEC CULASSE DÉCOMPOSÉE (FONTE)				
GRUPPO TRASFORMAZIONE DA ARIA AD ACQUA (GHISA)	CYLINDER KIT Conversion AC to LC (CAST IRON)	GROUPE TRANSFORMATION DE L'AIR À L'EAU (FONTE)				
GRUPPO TERMICO TPR IN ALLUMINIO Ø 47,6 Spinotto Ø 10	CYLINDER KIT TPR ALLUMINIUM Ø 47,6 Pin Ø 10	CYLINDRE COMPLET TPR EN ALUMINIUM Ø 47,6 Axe de Piston Ø 10				
GRUPPO TERMICO TPR IN ALLUMINIO Ø 47,6 Spinotto Ø 12	CYLINDER KIT TPR ALLUMINIUM Ø 47,6 Pin Ø 12	CYLINDRE COMPLET TPR EN ALUMINIUM Ø 47,6 Axe de Piston Ø 12				
KIT ASPIRAZIONE COMPLETO MIKUNI TM 24 TPR 360	COMPLETE INLET KIT MIKUNI TM 24 TPR 360	KIT ASPIRATION COMPLET MIKUNI TM 24 TPR 360				
KIT ASPIRAZIONE COMPLETO OKO 28 TPR 360	COMPLETE INLET KIT OKO 28 TPR 360	KIT ASPIRATION COMPLET OKO 28 TPR 360				
MAXI KIT 77cc ALESAGGIO Ø 50 CORSA STD	MAXI KIT 77 cc Bore Ø 50 Standard stroke	MAXI KIT 77 cc ALÉSAGE Ø 50 COURSE STD				
MAXI KIT 86cc ALESAGGIO Ø 50 CORSA 44 mm	MAXI KIT 86 cc Bore Ø 50 stroke 44 mm	MAXI KIT 86 cc ALÉSAGE Ø 50 COURSE 44 mm				
RAPPORTO ALLUNGATO secondario	SHAFT/GEARS	RAPPORT ALLONGÉ secondaire				
SCARICO NARDÒ 2 omologato	EXHAUST NARDÒ 2 Approved	ÉCHAPPEMENT NARDÒ 2 homologué				
SCARICO TPR GP omologato	EXHAUST TPR GP Approved	ÉCHAPPEMENT TPR GP homologué				
VALVOLA LAMELLARE TPR	REED VALVE TPR	CLAPET À LAMELLES TPR				
VARIOTOP TPR con cinghia	VARIOTOP TPR with belt	VARIOTOP TPR avec courroie				
VARIOTOP TPR con molla	VARIOTOP TPR with spring	VARIOTOP TPR avec ressort		9937610	9937610	9937610

MACAL	MACAL	MALAGUTI	MALAGUTI	MALAGUTI	MALAGUTI	MALAGUTI	MALAGUTI	MALAGUTI	MALAGUTI	MALAGUTI	MALAGUTI
STING	THUNDER	CENTRO EURO 2	CENTRO SL	CENTRO SL 4T	CIAK	CIAK EURO 2 2,3	CIAK EURO2	CIAK MASTER 4T	CIAK MASTER EURO 2	CIAK MASTER EURO 2	DVD
95-96	95-96	08-08	94-98	10-10	99-01	03-03	01-03	05-06	05-06	06-06	10-10
50cc 2T AC	50cc 2T AC	50cc 4T AC	50cc 2T AC	50cc 4T AC	50cc 2T AC	50cc 2T AC	50cc 2T AC	50cc 4T AC	50cc 4T AC	50cc 2T AC	50cc 4T AC
CY	MY	Motore Piaggio	MY	Motore Piaggio	MY	MY	MY	Motore Piaggio	Motore Piaggio	MY	Tipo Kymco
	9925910		9925910		9925910	9925910	9925910			9925910	
	9928320		9928320		9928320	9928320	9928320			9928320	
	9930300		9930300		9930300	9930300	9930300			9930300	
	9930200		9930200		9930200	9930200	9930200			9930200	
9929190	9929190		9929190		9929190	9929190	9929190			9929190	
	9927450	9928340	9927450	9928340	9927450	9927450	9927450	9928340	9928340		
9930030	9930030		9930030		9930030	9930030	9930030			9930030	
	9911210		9911210		9911210	9911210	9911210			9911210	
	9921630		9921630		9921630	9921630	9921630			9921630	
9930830	9930830		9930830		9930830	9930830	9930830			9930830	
9931710	9931710		9931710		9931710	9931710	9931710			9931710	
	990875P		990875P								
			9931440		9931440	9931440	9931440			9931440	
	9931620		9931620		9931620	9931620	9931620			9931620	
	9931670		9931670		9931670	9931670	9931670			9931670	
	9931650	9927610	9931650		9931650	9931650	9931650	9927610		9931650	9937610

SCOOTER 50cc RACING

SCOOTER 50cc RACING



MALAGUTI	MALAGUTI	MALAGUTI	MALAGUTI
F10	F10 AC WAP	F10 EURO 2	F10 EURO 2,2,3
92-00	08-08	02-06	03-04
50cc 2T AC	50cc 2T AC	50cc 2T AC	50cc 2T AC
CY	Tipo Keeway	CY	CY

IT	EN	FR					
ALBERO MOTORE TPR CORSA STD Spinotto Ø 10	CRANKSHAFT TPR Standard stroke pin Ø10	VILEBREQUIN TPR COURSE STD Axe de piston Ø 10		9925910		9925910	9925910
ALBERO MOTORE TPR CORSA STD Spinotto Ø 12	CRANKSHAFT TPR Standard stroke pin Ø12	VILEBREQUIN TPR COURSE STD Axe de piston Ø 12		9928320		9928320	9928320
COPERCHIO INGRANAGGI	GEAR COVER	COUVERCLE ENGRENAGES					
COPERCHIO TRASMISSIONE	TRANSMISSION COVER	COUVERCLE TRANSMISSION					
CUSCINETTI DI BANCO TPR CARBONITRURATI Serie	BEARINGS TPR Carbonitrided Series	PALIERI DE VILEBREQUIN TPR CARBONITRURÉS Jeu		9929190		9929190	9929190
FRIZIONE TPR GP REGOLABILE Patented	CLUTCH TPR GP Adjustable Patented	EMBAYAGE TPR GP RÉGLABLE Patented		9927450		9927450	9927450
GRUPPO TERMICO RACING MAGGIORATO C/TESTA (GHISA)	RACING CYLINDER KITS BIG BORE with head (CAST IRON)	CYLINDRE COMPLET RACING MAJORÉ AVEC CULASSE (FONTE)		9930030		9930030	9930030
GRUPPO TERMICO RACING 2004 C/TESTA SCOMPOSTA (GHISA)	RACING CYLINDER KITS BIG BORE without head (CAST IRON)	CYLINDRE COMPLET RACING 2004 AVEC CULASSE DÉCOMPOSÉE (FONTE)					
GRUPPO TRASFORMAZIONE DA ARIA AD ACQUA (GHISA)	CYLINDER KIT Conversion AC to LC (CAST IRON)	GROUPE TRANSFORMATION DE L'AIR À L'EAU (FONTE)		9911210		9911210	9911210
GRUPPO TERMICO TPR IN ALLUMINIO Ø 47,6 Spinotto Ø 10	CYLINDER KIT TPR ALLUMINIUM Ø 47,6 Pin Ø 10	CYLINDRE COMPLET TPR EN ALUMINIUM Ø 47,6 Axe de Piston Ø 10		9921630		9921630	9921630
GRUPPO TERMICO TPR IN ALLUMINIO Ø 47,6 Spinotto Ø 12	CYLINDER KIT TPR ALLUMINIUM Ø 47,6 Pin Ø 12	CYLINDRE COMPLET TPR EN ALUMINIUM Ø 47,6 Axe de Piston Ø 12					
KIT ASPIRAZIONE COMPLETO MIKUNI TM 24 TPR 360	COMPLETE INLET KIT MIKUNI TM 24 TPR 360	KIT ASPIRATION COMPLET MIKUNI TM 24 TPR 360		9930830	9930830	9930830	9930830
KIT ASPIRAZIONE COMPLETO OKO 28 TPR 360	COMPLETE INLET KIT OKO 28 TPR 360	KIT ASPIRATION COMPLET OKO 28 TPR 360		9931710	9931710	9931710	9931710
MAXI KIT 77cc ALESAGGIO Ø 50 CORSA STD	MAXI KIT 77 cc Bore Ø 50 Standard stroke	MAXI KIT 77 cc ALÉSAGE Ø 50 COURSE STD					
MAXI KIT 86cc ALESAGGIO Ø 50 CORSA 44 mm	MAXI KIT 86 cc Bore Ø 50 stroke 44 mm	MAXI KIT 86 cc ALÉSAGE Ø 50 COURSE 44 mm					
RAPPORTO ALLUNGATO secondario	SHAFT/GEARS	RAPPORT ALLONGÉ secondaire					
SCARICO NARDÒ 2 omologato	EXHAUST NARDÒ 2 Approved	ÉCHAPPEMENT NARDÒ 2 homologué		9931440		9931440	9931440
SCARICO TPR GP omologato	EXHAUST TPR GP Approved	ÉCHAPPEMENT TPR GP homologué					
VALVOLA LAMELLARE TPR	REED VALVE TPR	CLAPET À LAMELLES TPR		9931620	9931620	9931620	9931620
VARIOTOP TPR con cinghia	VARIOTOP TPR with belt	VARIOTOP TPR avec courroie		9931690		9931690	9931690
VARIOTOP TPR con molla	VARIOTOP TPR with spring	VARIOTOP TPR avec ressort		9931650	9924900	9931650	9931650

MALAGUTI	MALAGUTI	MALAGUTI	MALAGUTI	MALAGUTI	MALAGUTI	MALAGUTI	MALAGUTI	MALAGUTI	MALAGUTI	MALAGUTI	MALAGUTI
F10 RESTYLING EURO 2	F12 PHANTOM	F12 PHANTOM EURO 2	F12 PHANTOM EURO 2,2,3	F12 PHANTOM LC	F12 PHANTOM LC EURO 2,2,3	F12 R PHANTOM AC	F12 R PHANTOM LC	F12 RESTYLING EURO 1	F12 RESTYLING EURO 2	F12 RESTYLING LC EURO 2	F15 FIRE FOX
06-06	94-98	02-02	03-04	94-98	03-04	07-08	07-10	99-02	06-06	06-06	96-98
50cc 2T AC	50cc 2T AC	50cc 2T LC	50cc 2T AC	50cc 2T LC	50cc 2T LC	50cc 2T AC	50cc 2T LC	50cc 2T LC	50cc 2T AC	50cc 2T LC	50cc 2T LC
CY	MY	MA vent.	MY	MA	MA vent.	Tipo Keeway	MA	MA vent.	MY	MA vent.	MA
9925910	9925910		9925910	9925910			9925910		9925910		9925910
9928320	9928320		9928320	9928320			9928320		9928320		9928320
	9930300	9930300	9930300	9930300	9930300		9930300	9930300	9930300	9930300	9930300
	9930200		9930200	9930200			9930200		9930200		9930200
9929190	9929190	9929190	9929190	9929190	9929190		9929190	9929190	9929190	9929190	9929190
	9927450	9927450	9927450	9927450	9927450			9927450	9927450		9927450
9930030	9930030	9912800	9930030	9912800	9912800		9912800	9912800	9930030	9912800	9912800
		9921160		9921160	9921160		9921160	9921160		9921160	9921160
9911210	9911210		9911210						9911210		
9921630	9921630	9928480	9921630	9928480	9928480		9928480	9928480	9921630	9928480	9928480
		9928550		9928550	9928550		9928550	9928550		9928550	9928550
9930830	9930830	9930830	9930830	9930830	9930830	9930830	9930830	9930830	9930830	9930830	9930830
9931710	9931710	9931710	9931710	9931710	9931710	9931710	9931710	9931710	9931710	9931710	9931710
				9926580			9926580				9926580
				9926560			9926560				9926560
	990875P	990875P	990875P	990875P	990875P		990875P	990875P	990875P	990875P	990875P
9931440	9931440		9931440	9931440			9931440		9931440		9931440
				9930140			9930140				9930140
9931620	9931620	9931620	9931620	9931620	9931620	9931620	9931620	9931620	9931620	9931620	9931620
9931690	9931670	9931670	9931670	9931670	9931670		9931670	9931670	9931670	9931670	9931670
9931650	9931650	9931650	9931650	9931650	9931650	9924900	9931650	9931650	9931650	9931650	9931650

SCOOTER 50cc RACING

SCOOTER 50cc RACING



MALAGUTI	MALAGUTI	MALAGUTI	MALAGUTI
F15 FIRE FOX AIR COOLED	F15 FIRE FOX EURO 2	F15 FIRE FOX EURO 2	F15 FIRE FOX EURO 2 2,3
05-06	02-03	04-06	03-04
50cc 2T AC	50cc 2T LC	50cc 2T LC	50cc 2T LC
MY	MA	MA	MA

IT	EN	FR				
ALBERO MOTORE TPR CORSA STD Spinotto Ø 10	CRANKSHAFT TPR Standard stroke pin Ø10	VILEBREQUIN TPR COURSE STD Axe de piston Ø 10		9925910	9925910	9925910
ALBERO MOTORE TPR CORSA STD Spinotto Ø 12	CRANKSHAFT TPR Standard stroke pin Ø12	VILEBREQUIN TPR COURSE STD Axe de piston Ø 12		9928320	9928320	9928320
COPERCHIO INGRANAGGI	GEAR COVER	COUVERCLE ENGRENAGES		9930300	9930300	9930300
COPERCHIO TRASMISSIONE	TRANSMISSION COVER	COUVERCLE TRANSMISSION		9930200	9930200	9930200
CUSCINETTI DI BANCO TPR CARBONITRURATI Serie	BEARINGS TPR Carbonitrided Series	PALIERI DE VILEBREQUIN TPR CARBONITRURÉS Jeu		9929190	9929190	9929190
FRIZIONE TPR GP REGOLABILE Patented	CLUTCH TPR GP Adjustable Patented	EMBRYAGE TPR GP RÉGLABLE Patented			9927450	9927450
GRUPPO TERMICO RACING MAGGIORATO C/TESTA (GHISA)	RACING CYLINDER KITS BIG BORE with head (CAST IRON)	CYLINDRE COMPLET RACING MAJORÉ AVEC CULASSE (FONTE)		9930030	9912800	9912800
GRUPPO TERMICO RACING 2004 C/TESTA SCOMPOSTA (GHISA)	RACING CYLINDER KITS BIG BORE without head (CAST IRON)	CYLINDRE COMPLET RACING 2004 AVEC CULASSE DÉCOMPOSÉE (FONTE)			9921160	9921160
GRUPPO TRASFORMAZIONE DA ARIA AD ACQUA (GHISA)	CYLINDER KIT Conversion AC to LC (CAST IRON)	GROUPE TRANSFORMATION DE L'AIR À L'EAU (FONTE)		9911210		
GRUPPO TERMICO TPR IN ALLUMINIO Ø 47,6 Spinotto Ø 10	CYLINDER KIT TPR ALLUMINIUM Ø 47,6 Pin Ø 10	CYLINDRE COMPLET TPR EN ALUMINIUM Ø 47,6 Axe de Piston Ø 10		9921630	9928480	9928480
GRUPPO TERMICO TPR IN ALLUMINIO Ø 47,6 Spinotto Ø 12	CYLINDER KIT TPR ALLUMINIUM Ø 47,6 Pin Ø 12	CYLINDRE COMPLET TPR EN ALUMINIUM Ø 47,6 Axe de Piston Ø 12			9928550	9928550
KIT ASPIRAZIONE COMPLETO MIKUNI TM 24 TPR 360	COMPLETE INLET KIT MIKUNI TM 24 TPR 360	KIT ASPIRATION COMPLET MIKUNI TM 24 TPR 360		9930830	9930830	9930830
KIT ASPIRAZIONE COMPLETO OKO 28 TPR 360	COMPLETE INLET KIT OKO 28 TPR 360	KIT ASPIRATION COMPLET OKO 28 TPR 360		9931710	9931710	9931710
MAXI KIT 77cc ALESAGGIO Ø 50 CORSA STD	MAXI KIT 77 cc Bore Ø 50 Standard stroke	MAXI KIT 77 cc ALÉSAGE Ø 50 COURSE STD			9926580	9926580
MAXI KIT 86cc ALESAGGIO Ø 50 CORSA 44 mm	MAXI KIT 86 cc Bore Ø 50 stroke 44 mm	MAXI KIT 86 cc ALÉSAGE Ø 50 COURSE 44 mm			9926560	9926560
RAPPORTO ALLUNGATO secondario	SHAFT/GEARS	RAPPORT ALLONGÉ secondaire		990875P	990875P	990875P
SCARICO NARDÒ 2 omologato	EXHAUST NARDÒ 2 Approved	ÉCHAPPEMENT NARDÒ 2 homologué		9931440	9931440	9931440
SCARICO TPR GP omologato	EXHAUST TPR GP Approved	ÉCHAPPEMENT TPR GP homologué		9930140	9930140	9930140
VALVOLA LAMELLARE TPR	REED VALVE TPR	CLAPET À LAMELLES TPR		9931620	9931620	9931620
VARIOTOP TPR con cinghia	VARIOTOP TPR with belt	VARIOTOP TPR avec courroie		9931670	9931670	9931670
VARIOTOP TPR con molla	VARIOTOP TPR with spring	VARIOTOP TPR avec ressort		9931650	9931650	9931650

MALAGUTI	MBK	MBK	MBK	MBK	MBK	MBK	MBK	MBK	MBK	MBK	MBK
YESTERDAY	BOOSTER	BOOSTER	BOOSTER	BOOSTER EURO 2	BOOSTER NG	BOOSTER NG	BOOSTER ROCKET	BOOSTER SPIRIT	BOOSTER SPIRIT	BOOSTER SPIRIT	BOOSTER SPIRIT
97-00	90-91	90-04	92-94	04-04	95-03	03-03	97-98	96-98	99-00	00-00	03-03
50cc 2T AC	50cc 2T AC	50cc 2T AC	50cc 2T AC	50cc 2T AC	50cc 2T AC	50cc 2T AC	50cc 2T AC	50cc 2T AC	50cc 2T AC	50cc 2T AC	50cc 2T AC
CY	CW	CW	CW	CW	CW	CW	CW	CW	CW	CW	CW
9925910	9927900	9927900	9927900	9927900	9927900	9927900	9927900	9927900	9927900	9927900	9927900
9928320											
	9930300	9930300	9930300	9930300	9930300	9930300	9930300	9930300	9930300	9930300	9930300
9929190	9929190	9929190	9929190	9929190	9929190	9929190	9929190	9929190	9929190	9929190	9929190
9927450	9927450	9927450	9927450	9927450	9927450	9927450	9927450	9927450	9927450	9927450	9927450
9930030	9930000	9930000	9930000	9930000	9930000	9930000	9930000	9930000	9930000	9930000	9930000
9911210											
9921630	9921640	9921640	9921640	9921640	9921640	9921640	9921640	9921640	9921640	9921640	9921640
9930830											
9931710											
	990875P	990875P	990875P	990875P	990875P	990875P	990875P	990875P	990875P	990875P	990875P
9931440	9931450	9931450	9931450		9931450		9931450	9931450	9931450	9931450	9931450
9931620											
9931690	9931670	9931670	9931670	9931670	9931670	9931670	9931670	9931670	9931670	9931670	9931670
9931650	9931650	9931650	9931650	9931650	9931650	9931650	9931650	9931650	9931650	9931650	9931650

SCOOTER 50cc RACING

SCOOTER 50cc RACING



MBK	MBK	MBK	MBK
BOOSTER SPIRIT EURO2	BOOSTER TRACK	BOOSTER X IE	EVOLIS
03-03	96-98	08-08	92-95
50cc 2T AC	50cc 2T AC	50cc 4T-3V LC	50cc 2T AC
CW	CW	15P1	CY

IT	EN	FR				
ALBERO MOTORE TPR CORSA STD Spinotto Ø 10	CRANKSHAFT TPR Standard stroke pin Ø10	VILEBREQUIN TPR COURSE STD Axe de piston Ø 10		9927900	9927900	9925910
ALBERO MOTORE TPR CORSA STD Spinotto Ø 12	CRANKSHAFT TPR Standard stroke pin Ø12	VILEBREQUIN TPR COURSE STD Axe de piston Ø 12				9928320
COPERCHIO INGRANAGGI	GEAR COVER	COUVERCLE ENGRENAGES		9930300	9930300	
COPERCHIO TRASMISSIONE	TRANSMISSION COVER	COUVERCLE TRANSMISSION				
CUSCINETTI DI BANCO TPR CARBONITRURATI Serie	BEARINGS TPR Carbonitrided Series	PALIERI DE VILEBREQUIN TPR CARBONITRURÉS Jeu		9929190	9929190	9929190
FRIZIONE TPR GP REGOLABILE Patented	CLUTCH TPR GP Adjustable Patented	EMBAYAGE TPR GP RÉGLABLE Patented		9927450	9927450	
GRUPPO TERMICO RACING MAGGIORATO C/TESTA (GHISA)	RACING CYLINDER KITS BIG BORE with head (CAST IRON)	CYLINDRE COMPLET RACING MAJORÉ AVEC CULASSE (FONTE)		9930000	9930000	9930030
GRUPPO TERMICO RACING 2004 C/TESTA SCOMPOSTA (GHISA)	RACING CYLINDER KITS BIG BORE without head (CAST IRON)	CYLINDRE COMPLET RACING 2004 AVEC CULASSE DÉCOMPOSÉE (FONTE)				
GRUPPO TRASFORMAZIONE DA ARIA AD ACQUA (GHISA)	CYLINDER KIT Conversion AC to LC (CAST IRON)	GROUPE TRANSFORMATION DE L'AIR À L'EAU (FONTE)				9911210
GRUPPO TERMICO TPR IN ALLUMINIO Ø 47,6 Spinotto Ø 10	CYLINDER KIT TPR ALLUMINIUM Ø 47,6 Pin Ø 10	CYLINDRE COMPLET TPR EN ALUMINIUM Ø 47,6 Axe de Piston Ø 10		9921640	9921640	9926330
GRUPPO TERMICO TPR IN ALLUMINIO Ø 47,6 Spinotto Ø 12	CYLINDER KIT TPR ALLUMINIUM Ø 47,6 Pin Ø 12	CYLINDRE COMPLET TPR EN ALUMINIUM Ø 47,6 Axe de Piston Ø 12				
KIT ASPIRAZIONE COMPLETO MIKUNI TM 24 TPR 360	COMPLETE INLET KIT MIKUNI TM 24 TPR 360	KIT ASPIRATION COMPLET MIKUNI TM 24 TPR 360				9930830
KIT ASPIRAZIONE COMPLETO OKO 28 TPR 360	COMPLETE INLET KIT OKO 28 TPR 360	KIT ASPIRATION COMPLET OKO 28 TPR 360				9931710
MAXI KIT 77cc ALESAGGIO Ø 50 CORSA STD	MAXI KIT 77 cc Bore Ø 50 Standard stroke	MAXI KIT 77 cc ALÉSAGE Ø 50 COURSE STD				
MAXI KIT 86cc ALESAGGIO Ø 50 CORSA 44 mm	MAXI KIT 86 cc Bore Ø 50 stroke 44 mm	MAXI KIT 86 cc ALÉSAGE Ø 50 COURSE 44 mm				
RAPPORTO ALLUNGATO secondario	SHAFT/GEARS	RAPPORT ALLONGÉ secondaire		990875P	990875P	
SCARICO NARDÒ 2 omologato	EXHAUST NARDÒ 2 Approved	ÉCHAPPEMENT NARDÒ 2 homologué			9931450	9931440
SCARICO TPR GP omologato	EXHAUST TPR GP Approved	ÉCHAPPEMENT TPR GP homologué				
VALVOLA LAMELLARE TPR	REED VALVE TPR	CLAPET À LAMELLES TPR				9931620
VARIOTOP TPR con cinghia	VARIOTOP TPR with belt	VARIOTOP TPR avec courroie		9931670	9931670	9931690
VARIOTOP TPR con molla	VARIOTOP TPR with spring	VARIOTOP TPR avec ressort		9931650	9931650	9926130

MBK	MBK	MBK	MBK	MBK	MBK	MBK	MBK	MBK	MBK	MBK	MBK
FIZZ	FLIPPER	FLIPPER EURO 2	FORTE	MACH G	MACH G LC	NITRO	NITRO EURO 2	OVETTO	OVETTO 4T	OVETTO EURO 2	SORRISO
94-95	98-04	03-03	94-96	02-04	02-04	97-04	03-03	97-04	09-11	02-02	95-96
50cc 2T AC	50cc 2T AC	50cc 2T AC	50cc 2T AC	50cc 2T AC	50cc 2T LC	50cc 2T LC	50cc 2T LC	50cc 2T AC	50cc 4T-3V LC	50cc 2T AC	50cc 2T AC
CY	MY	MY	CY	MY	MA	MA	MA	MY	5C3	MY	Tipo CW
9925910	9925910	9925910	9925910	9925910	9925910	9925910	9925910	9925910		9925910	
9928320	9928320	9928320	9928320	9928320	9928320	9928320	9928320	9928320		9928320	
	9930300	9930300		9930300	9930300	9930300	9930300	9930300		9930300	
	9930200	9930200		9930200	9930200	9930200	9930200	9930200		9930200	
9929190	9929190	9929190	9929190	9929190	9929190	9929190	9929190	9929190		9929190	
		9927450		9927450	9927450	9927450	9927450	9927450		9927450	9927450
9930030	9930030	9930030	9930030	9930030	9912800	9912800	9912800	9930030		9930030	
					9921160	9921160	9921160				
9911210	9911210	9911210	9911210	9911210				9911210		9911210	
9921630	9921630	9921630	9921630	9921630	9928480	9928480	9928480	9921630	9926330	9921630	
					9928550	9928550	9928550				
9930830	9930830	9930830	9930830	9930830	9930830	9930830	9930830	9930830		9930830	
9931710	9931710	9931710	9931710	9931710	9931710	9931710	9931710	9931710		9931710	
					9926580	9926580	9926580				
					9926560	9926560	9926560				
				990875P	990875P	990875P	990875P	990875P		990875P	
9931440	9931440	9931440	9931440	9931440	9931440	9931440	9931440	9931440		9931440	
					9930140	9930140	9930140				
9931620	9931620	9931620	9931620	9931620	9931620	9931620	9931620	9931620		9931620	
9931690	9931670	9931670	9931690	9931670	9931670	9931670	9931670	9931670		9931670	
9931650	9931650	9931650	9931650	9931650	9931650	9931650	9931650	9931650	9926130	9931650	

SCOOTER 50cc RACING

SCOOTER 50cc RACING



MBK	MBK	MOTRON	MOTRON
STUNT	TARGET	STING	SYNCRO
00-02	91-95	95-96	98-00
50cc 2T AC	50cc 2T AC	50cc 2T AC	50cc 2T AC
CW	Tipo CW	CY	MY

IT	EN	FR				
ALBERO MOTORE TPR CORSA STD Spinotto Ø 10	CRANKSHAFT TPR Standard stroke pin Ø10	VILEBREQUIN TPR COURSE STD Axe de piston Ø 10		9927900		9925910
ALBERO MOTORE TPR CORSA STD Spinotto Ø 12	CRANKSHAFT TPR Standard stroke pin Ø12	VILEBREQUIN TPR COURSE STD Axe de piston Ø 12				9928320
COPERCHIO INGRANAGGI	GEAR COVER	COUVERCLE ENGRENAGES		9930300		9930300
COPERCHIO TRASMISSIONE	TRANSMISSION COVER	COUVERCLE TRANSMISSION				9930200
CUSCINETTI DI BANCO TPR CARBONITRURATI Serie	BEARINGS TPR Carbonitrided Series	PALIERI DE VILEBREQUIN TPR CARBONITRURÉS Jeu		9929190		9929190
FRIZIONE TPR GP REGOLABILE Patented	CLUTCH TPR GP Adjustable Patented	EMBAYAGE TPR GP RÉGLABLE Patented		9927450	9927450	9927450
GRUPPO TERMICO RACING MAGGIORATO C/TESTA (GHISA)	RACING CYLINDER KITS BIG BORE with head (CAST IRON)	CYLINDRE COMPLET RACING MAJORÉ AVEC CULASSE (FONTE)		9930000		9930030
GRUPPO TERMICO RACING 2004 C/TESTA SCOMPOSTA (GHISA)	RACING CYLINDER KITS BIG BORE without head (CAST IRON)	CYLINDRE COMPLET RACING 2004 AVEC CULASSE DÉCOMPOSÉE (FONTE)				
GRUPPO TRASFORMAZIONE DA ARIA AD ACQUA (GHISA)	CYLINDER KIT Conversion AC to LC (CAST IRON)	GROUPE TRANSFORMATION DE L'AIR À L'EAU (FONTE)				9911210
GRUPPO TERMICO TPR IN ALLUMINIO Ø 47,6 Spinotto Ø 10	CYLINDER KIT TPR ALLUMINIUM Ø 47,6 Pin Ø 10	CYLINDRE COMPLET TPR EN ALUMINIUM Ø 47,6 Axe de Piston Ø 10		9921640		9921630
GRUPPO TERMICO TPR IN ALLUMINIO Ø 47,6 Spinotto Ø 12	CYLINDER KIT TPR ALLUMINIUM Ø 47,6 Pin Ø 12	CYLINDRE COMPLET TPR EN ALUMINIUM Ø 47,6 Axe de Piston Ø 12				
KIT ASPIRAZIONE COMPLETO MIKUNI TM 24 TPR 360	COMPLETE INLET KIT MIKUNI TM 24 TPR 360	KIT ASPIRATION COMPLET MIKUNI TM 24 TPR 360				9930830
KIT ASPIRAZIONE COMPLETO OKO 28 TPR 360	COMPLETE INLET KIT OKO 28 TPR 360	KIT ASPIRATION COMPLET OKO 28 TPR 360				9931710
MAXI KIT 77cc ALESAGGIO Ø 50 CORSA STD	MAXI KIT 77 cc Bore Ø 50 Standard stroke	MAXI KIT 77 cc ALÉSAGE Ø 50 COURSE STD				
MAXI KIT 86cc ALESAGGIO Ø 50 CORSA 44 mm	MAXI KIT 86 cc Bore Ø 50 stroke 44 mm	MAXI KIT 86 cc ALÉSAGE Ø 50 COURSE 44 mm				
RAPPORTO ALLUNGATO secondario	SHAFT/GEARS	RAPPORT ALLONGÉ secondaire		990875P		990875P
SCARICO NARDÒ 2 omologato	EXHAUST NARDÒ 2 Approved	ÉCHAPPEMENT NARDÒ 2 homologué		9931450		
SCARICO TPR GP omologato	EXHAUST TPR GP Approved	ÉCHAPPEMENT TPR GP homologué				
VALVOLA LAMELLARE TPR	REED VALVE TPR	CLAPET À LAMELLES TPR				9931620
VARIOTOP TPR con cinghia	VARIOTOP TPR with belt	VARIOTOP TPR avec courroie		9931670		9931670
VARIOTOP TPR con molla	VARIOTOP TPR with spring	VARIOTOP TPR avec ressort		9931650		9931650

MOTRON	PEUGEOT	PEUGEOT	PEUGEOT	PGO	PIAGGIO	PIAGGIO	PIAGGIO	PIAGGIO	PIAGGIO	PIAGGIO	PIAGGIO
THUNDER	BUXY	BUXY RS	SPEEDAKE	BIG MAX	DIESIS	FLY 2T	FLY 2T	FLY 4T	FLY 4T & 25-30 KM/H	FLY 4T 4V	FLY 4T MOTORE CHN
95-98	90-02	90-02	90-02	95-97	01-01	05-07	10-11	05-07	08-11	12-13	06-07
50cc 2T AC	50cc 2T AC	50cc 2T AC	50cc 2T AC	50cc 2T AC	50cc 2T AC	50cc 2T AC	50cc 2T AC	50cc 4T AC	50cc 4T AC	50cc 4T-4V AC	50cc 4T AC
MY	Motore Peugeot	Motore Peugeot	Motore Peugeot	Tipo MY	Motore Piaggio	Motore Piaggio	Motore Piaggio	Motore Piaggio	Motore Piaggio	Motore Piaggio	Motore Piaggio
9925910											
9928320					9926180	9926180	9926180				
9930300											
9930200											
9929190				9929190	9929200	9929200	9929200				
9927450					9928340	9928340	9928340	9928340	9928340	9928340	9928340
9930030				9930030	9930060	9930060	9930060				
9911210											
9921630				9921630							
					9921550	9921550	9921550				
9930830				9930830	9930870	9930870	9930870				
9931710				9931710	9931730	9931730	9931730				
990875P											
					9931460	9931460	9931460				
9931620					9931640	9931640	9931640				
9931670	9910780	9910780	9910780		9931300						
9931650					9927610	9927610	9927610	9927610	9927610	9927610	9927610

SCOOTER 50cc RACING

SCOOTER 50cc RACING



PIAGGIO	PIAGGIO	PIAGGIO	PIAGGIO
FREE	FREE DELIVERY	FREE FL	LIBERTY
92-94	00-01	95-02	97-05
50cc 2T AC	50cc 2T AC	50cc 2T AC	50cc 2T AC
Motore Piaggio	Motore Piaggio	Motore Piaggio	Motore Piaggio

IT	EN	FR				
ALBERO MOTORE TPR CORSA STD Spinotto Ø 10	CRANKSHAFT TPR Standard stroke pin Ø10	VILEBREQUIN TPR COURSE STD Axe de piston Ø 10				
ALBERO MOTORE TPR CORSA STD Spinotto Ø 12	CRANKSHAFT TPR Standard stroke pin Ø12	VILEBREQUIN TPR COURSE STD Axe de piston Ø 12		9926180	9926180	9926180
COPERCHIO INGRANAGGI	GEAR COVER	COUVERCLE ENGRENAGES				
COPERCHIO TRASMISSIONE	TRANSMISSION COVER	COUVERCLE TRANSMISSION				
CUSCINETTI DI BANCO TPR CARBONITRURATI Serie	BEARINGS TPR Carbonitrided Series	PALIERI DE VILEBREQUIN TPR CARBONITRURÉS Jeu		9929200	9929200	9929200
FRIZIONE TPR GP REGOLABILE Patented	CLUTCH TPR GP Adjustable Patented	EMBAYAGE TPR GP RÉGLABLE Patented		9928340	9928340	9928340
GRUPPO TERMICO RACING MAGGIORATO C/TESTA (GHISA)	RACING CYLINDER KITS BIG BORE with head (CAST IRON)	CYLINDRE COMPLET RACING MAJORÉ AVEC CULASSE (FONTE)		9930060	9930060	9930060
GRUPPO TERMICO RACING 2004 C/TESTA SCOMPOSTA (GHISA)	RACING CYLINDER KITS BIG BORE without head (CAST IRON)	CYLINDRE COMPLET RACING 2004 AVEC CULASSE DÉCOMPOSÉE (FONTE)				
GRUPPO TRASFORMAZIONE DA ARIA AD ACQUA (GHISA)	CYLINDER KIT Conversion AC to LC (CAST IRON)	GROUPE TRANSFORMATION DE L'AIR À L'EAU (FONTE)				
GRUPPO TERMICO TPR IN ALLUMINIO Ø 47,6 Spinotto Ø 10	CYLINDER KIT TPR ALLUMINIUM Ø 47,6 Pin Ø 10	CYLINDRE COMPLET TPR EN ALUMINIUM Ø 47,6 Axe de Piston Ø 10				
GRUPPO TERMICO TPR IN ALLUMINIO Ø 47,6 Spinotto Ø 12	CYLINDER KIT TPR ALLUMINIUM Ø 47,6 Pin Ø 12	CYLINDRE COMPLET TPR EN ALUMINIUM Ø 47,6 Axe de Piston Ø 12		9921550	9921550	9921550
KIT ASPIRAZIONE COMPLETO MIKUNI TM 24 TPR 360	COMPLETE INLET KIT MIKUNI TM 24 TPR 360	KIT ASPIRATION COMPLET MIKUNI TM 24 TPR 360		9930870	9930870	9930870
KIT ASPIRAZIONE COMPLETO OKO 28 TPR 360	COMPLETE INLET KIT OKO 28 TPR 360	KIT ASPIRATION COMPLET OKO 28 TPR 360		9931730	9931730	9931730
MAXI KIT 77cc ALESAGGIO Ø 50 CORSA STD	MAXI KIT 77 cc Bore Ø 50 Standard stroke	MAXI KIT 77 cc ALÉSAGE Ø 50 COURSE STD				
MAXI KIT 86cc ALESAGGIO Ø 50 CORSA 44 mm	MAXI KIT 86 cc Bore Ø 50 stroke 44 mm	MAXI KIT 86 cc ALÉSAGE Ø 50 COURSE 44 mm				
RAPPORTO ALLUNGATO secondario	SHAFT/GEARS	RAPPORT ALLONGÉ secondaire				
SCARICO NARDÒ 2 omologato	EXHAUST NARDÒ 2 Approved	ÉCHAPPEMENT NARDÒ 2 homologué		9931460	9931460	9931460
SCARICO TPR GP omologato	EXHAUST TPR GP Approved	ÉCHAPPEMENT TPR GP homologué				
VALVOLA LAMELLARE TPR	REED VALVE TPR	CLAPET À LAMELLES TPR		9931640	9931640	9931640
VARIOTOP TPR con cinghia	VARIOTOP TPR with belt	VARIOTOP TPR avec courroie				
VARIOTOP TPR con molla	VARIOTOP TPR with spring	VARIOTOP TPR avec ressort		9927610	9927610	9927610

PIAGGIO	PIAGGIO	PIAGGIO	PIAGGIO	PIAGGIO	PIAGGIO	PIAGGIO	PIAGGIO	PIAGGIO	PIAGGIO	PIAGGIO	PIAGGIO
LIBERTY 2T	LIBERTY 2T	LIBERTY 2T PTT EU2	LIBERTY 2T RST	LIBERTY 2T SPORT	LIBERTY 2T SPORT	LIBERTY 4T	LIBERTY 4T	LIBERTY 4T 3V IE	LIBERTY 4T 3V IE E4	LIBERTY 4T DELIVERY - SINGLE	LIBERTY 4T DELIVERY TNT
06-06	07-08	04-05	04-04	06-06	07-08	00-02	05-08	15-17	17-18	10-14	09-09
50cc 2T AC	50cc 2T AC	50cc 2T AC	50cc 2T AC	50cc 2T AC	50cc 2T AC	50cc 4T AC	50cc 4T AC	50cc 4T-3V AC	50cc 4T-3V AC	50cc 4T AC	50cc 4T AC
Motore Piaggio	Motore Piaggio	Motore Piaggio	Motore Piaggio	Motore Piaggio	Motore Piaggio	Motore Piaggio	Motore Piaggio	Motore Piaggio	Motore Piaggio	Motore Piaggio	Motore Piaggio
9926180	9926180	9926180	9926180	9926180	9926180						
9929200	9929200	9929200	9929200	9929200	9929200						
9928340	9928340	9928340	9928340	9928340	9928340	9928340	9928340	9928340	9928340	9928340	9928340
9930060	9930060	9930060	9930060	9930060	9930060						
9921550	9921550	9921550	9921550	9921550	9921550						
9930870	9930870	9930870	9930870	9930870	9930870						
9931730	9931730	9931730	9931730	9931730	9931730						
9931460	9931460	9931460	9931460	9931460	9931460						
9931640	9931640	9931640	9931640	9931640	9931640						
9927610	9927610	9927610	9927610	9927610	9927610	9927610		9927610	9927610	9927610	9927610

SCOOTER 50cc
RACING

SCOOTER 50cc RACING



PIAGGIO	PIAGGIO	PIAGGIO	PIAGGIO
LIBERTY 4T IGET CORPORATE E4	LIBERTY 4T PTT - DOUBLE - NEXIVE	LIBERTY 4T RST	LIBERTY 4T SPORT
18-18	09-17	04-04	06-06
50cc 4T-3V AC	50cc 4T AC	50cc 4T AC	50cc 4T AC
Motore Piaggio	Motore Piaggio	Motore Piaggio	Motore Piaggio

IT	EN	FR				
ALBERO MOTORE TPR CORSA STD Spinotto Ø 10	CRANKSHAFT TPR Standard stroke pin Ø10	VILEBREQUIN TPR COURSE STD Axe de piston Ø 10				
ALBERO MOTORE TPR CORSA STD Spinotto Ø 12	CRANKSHAFT TPR Standard stroke pin Ø12	VILEBREQUIN TPR COURSE STD Axe de piston Ø 12				
COPERCHIO INGRANAGGI	GEAR COVER	COUVERCLE ENGRENAGES				
COPERCHIO TRASMISSIONE	TRANSMISSION COVER	COUVERCLE TRANSMISSION				
CUSCINETTI DI BANCO TPR CARBONITRURATI Serie	BEARINGS TPR Carbonitrided Series	PALIERI DE VILEBREQUIN TPR CARBONITRURÉS Jeu				
FRIZIONE TPR GP REGOLABILE Patented	CLUTCH TPR GP Adjustable Patented	EMBRYAGE TPR GP RÉGLABLE Patented			9928340	9928340
GRUPPO TERMICO RACING MAGGIORATO C/TESTA (GHISA)	RACING CYLINDER KITS BIG BORE with head (CAST IRON)	CYLINDRE COMPLET RACING MAJORÉ AVEC CULASSE (FONTE)				
GRUPPO TERMICO RACING 2004 C/TESTA SCOMPOSTA (GHISA)	RACING CYLINDER KITS BIG BORE without head (CAST IRON)	CYLINDRE COMPLET RACING 2004 AVEC CULASSE DÉCOMPOSÉE (FONTE)				
GRUPPO TRASFORMAZIONE DA ARIA AD ACQUA (GHISA)	CYLINDER KIT Conversion AC to LC (CAST IRON)	GROUPE TRANSFORMATION DE L'AIR À L'EAU (FONTE)				
GRUPPO TERMICO TPR IN ALLUMINIO Ø 47,6 Spinotto Ø 10	CYLINDER KIT TPR ALLUMINIUM Ø 47,6 Pin Ø 10	CYLINDRE COMPLET TPR EN ALUMINIUM Ø 47,6 Axe de Piston Ø 10				
GRUPPO TERMICO TPR IN ALLUMINIO Ø 47,6 Spinotto Ø 12	CYLINDER KIT TPR ALLUMINIUM Ø 47,6 Pin Ø 12	CYLINDRE COMPLET TPR EN ALUMINIUM Ø 47,6 Axe de Piston Ø 12				
KIT ASPIRAZIONE COMPLETO MIKUNI TM 24 TPR 360	COMPLETE INLET KIT MIKUNI TM 24 TPR 360	KIT ASPIRATION COMPLET MIKUNI TM 24 TPR 360				
KIT ASPIRAZIONE COMPLETO OKO 28 TPR 360	COMPLETE INLET KIT OKO 28 TPR 360	KIT ASPIRATION COMPLET OKO 28 TPR 360				
MAXI KIT 77cc ALESAGGIO Ø 50 CORSA STD	MAXI KIT 77 cc Bore Ø 50 Standard stroke	MAXI KIT 77 cc ALÉSAGE Ø 50 COURSE STD				
MAXI KIT 86cc ALESAGGIO Ø 50 CORSA 44 mm	MAXI KIT 86 cc Bore Ø 50 stroke 44 mm	MAXI KIT 86 cc ALÉSAGE Ø 50 COURSE 44 mm				
RAPPORTO ALLUNGATO secondario	SHAFT/GEARS	RAPPORT ALLONGÉ secondaire				
SCARICO NARDÒ 2 omologato	EXHAUST NARDÒ 2 Approved	ÉCHAPPEMENT NARDÒ 2 homologué				
SCARICO TPR GP omologato	EXHAUST TPR GP Approved	ÉCHAPPEMENT TPR GP homologué				
VALVOLA LAMELLARE TPR	REED VALVE TPR	CLAPET À LAMELLES TPR				
VARIOTOP TPR con cinghia	VARIOTOP TPR with belt	VARIOTOP TPR avec courroie				
VARIOTOP TPR con molla	VARIOTOP TPR with spring	VARIOTOP TPR avec ressort		9927610	9927610	9927610

PIAGGIO	PIAGGIO	PIAGGIO	PIAGGIO	PIAGGIO	PIAGGIO	PIAGGIO	PIAGGIO	PIAGGIO	PIAGGIO	PIAGGIO	PIAGGIO
LIBERTY 4T SPORT	LIBERTY 1GET 4T 3V IE E4 EMEA	LIBERTY MOC 2T & ELLE	LIBERTY MOC 4T & ELLE	NRG	NRG EXTREME LC	NRG MC3	NRG POWER DD	NRG POWER DD	NRG POWER DD	NRG POWER DD SERIE SPECIALE	NRG POWER DT
07-08	17-18	09-13	09-16	94-96	99-00	01-04	05-05	06-06	07-17	07-12	06-06
50cc 4T AC	50cc 4T-3V AC	50cc 2T AC	50cc 4T AC	50cc 2T LC	50cc 2T LC	50cc 2T LC	50cc 2T LC	50cc 2T LC	50cc 2T LC	50cc 2T LC	50cc 2T AC
Motore Piaggio	Motore Piaggio	Motore Piaggio	Motore Piaggio	Motore Piaggio	Motore Piaggio	Motore Piaggio	Motore Piaggio	Motore Piaggio	Motore Piaggio	Motore Piaggio	Motore Piaggio
		9926180		9926180	9926180	9926180	9926180	9926180	9926180	9926180	9926180
		9929200		9929200	9929200	9929200	9929200	9929200	9929200	9929200	9929200
9928340		9928340	9928340	9928340	9928340	9928340	9928340	9928340	9928340	9928340	9928340
		9930060		9920590	9920590	9920590	9920590	9920590	9920590	9920590	9930060
		9921550		9928520	9928520	9928520	9928520	9928520	9928520	9928520	9921550
		9930870		9930870	9930870	9930870	9930870	9930870	9930870	9930870	9930870
		9931730		9931730	9931730	9931730	9931730	9931730	9931730	9931730	9931730
				9928390	9928390	9928390	9928390	9928390	9928390	9928390	
				9928440	9928440	9928440	9928440	9928440	9928440	9928440	
		9931460		9931460	9931460	9931460	9931460	9931460	9931460	9931460	9931460
				9930160	9930160	9930160	9930160	9930160	9930160	9930160	
		9931640		9931640	9931640	9931640	9931640	9931640	9931640	9931640	9931640
						9931300	9931300	9931300	9931300	9931300	9931300
9927610	9927610	9927610	9927610	9927610	9927610	9927610	9927610	9927610	9927610	9927610	9927610

SCOOTER 50cc RACING

SCOOTER 50cc RACING



PIAGGIO	PIAGGIO	PIAGGIO	PIAGGIO
NRG POWER DT	NRG POWER DT SERIE SPECIALE	NRG POWER PUREJET	NRG POWER PUREJET
07-15	07-08	04-05	06-06
50cc 2T AC	50cc 2T AC	50cc 2T-IE LC	50cc 2T-IE LC
Motore Piaggio	Motore Piaggio	Motore Piaggio	Motore Piaggio

IT	EN	FR				
ALBERO MOTORE TPR CORSA STD Spinotto Ø 10	CRANKSHAFT TPR Standard stroke pin Ø10	VILEBREQUIN TPR COURSE STD Axe de piston Ø 10				
ALBERO MOTORE TPR CORSA STD Spinotto Ø 12	CRANKSHAFT TPR Standard stroke pin Ø12	VILEBREQUIN TPR COURSE STD Axe de piston Ø 12		9926180	9926180	
COPERCHIO INGRANAGGI	GEAR COVER	COUVERCLE ENGRENAGES				
COPERCHIO TRASMISSIONE	TRANSMISSION COVER	COUVERCLE TRANSMISSION				
CUSCINETTI DI BANCO TPR CARBONITRURATI Serie	BEARINGS TPR Carbonitrided Series	PALIERI DE VILEBREQUIN TPR CARBONITRURÉS Jeu		9929200	9929200	9929200
FRIZIONE TPR GP REGOLABILE Patented	CLUTCH TPR GP Adjustable Patented	EMBAYAGE TPR GP RÉGLABLE Patented		9928340	9928340	9928340
GRUPPO TERMICO RACING MAGGIORATO C/TESTA (GHISA)	RACING CYLINDER KITS BIG BORE with head (CAST IRON)	CYLINDRE COMPLET RACING MAJORÉ AVEC CULASSE (FONTE)		9930060	9930060	
GRUPPO TERMICO RACING 2004 C/TESTA SCOMPOSTA (GHISA)	RACING CYLINDER KITS BIG BORE without head (CAST IRON)	CYLINDRE COMPLET RACING 2004 AVEC CULASSE DÉCOMPOSÉE (FONTE)				
GRUPPO TRASFORMAZIONE DA ARIA AD ACQUA (GHISA)	CYLINDER KIT Conversion AC to LC (CAST IRON)	GROUPE TRANSFORMATION DE L'AIR À L'EAU (FONTE)				
GRUPPO TERMICO TPR IN ALLUMINIO Ø 47,6 Spinotto Ø 10	CYLINDER KIT TPR ALLUMINIUM Ø 47,6 Pin Ø 10	CYLINDRE COMPLET TPR EN ALUMINIUM Ø 47,6 Axe de Piston Ø 10				
GRUPPO TERMICO TPR IN ALLUMINIO Ø 47,6 Spinotto Ø 12	CYLINDER KIT TPR ALLUMINIUM Ø 47,6 Pin Ø 12	CYLINDRE COMPLET TPR EN ALUMINIUM Ø 47,6 Axe de Piston Ø 12		9921550	9921550	
KIT ASPIRAZIONE COMPLETO MIKUNI TM 24 TPR 360	COMPLETE INLET KIT MIKUNI TM 24 TPR 360	KIT ASPIRATION COMPLET MIKUNI TM 24 TPR 360		9930870	9930870	9930870
KIT ASPIRAZIONE COMPLETO OKO 28 TPR 360	COMPLETE INLET KIT OKO 28 TPR 360	KIT ASPIRATION COMPLET OKO 28 TPR 360		9931730	9931730	9931730
MAXI KIT 77cc ALESAGGIO Ø 50 CORSA STD	MAXI KIT 77 cc Bore Ø 50 Standard stroke	MAXI KIT 77 cc ALÉSAGE Ø 50 COURSE STD				
MAXI KIT 86cc ALESAGGIO Ø 50 CORSA 44 mm	MAXI KIT 86 cc Bore Ø 50 stroke 44 mm	MAXI KIT 86 cc ALÉSAGE Ø 50 COURSE 44 mm				
RAPPORTO ALLUNGATO secondario	SHAFT/GEARS	RAPPORT ALLONGÉ secondaire				
SCARICO NARDÒ 2 omologato	EXHAUST NARDÒ 2 Approved	ÉCHAPPEMENT NARDÒ 2 homologué		9931460	9931460	9931460
SCARICO TPR GP omologato	EXHAUST TPR GP Approved	ÉCHAPPEMENT TPR GP homologué				
VALVOLA LAMELLARE TPR	REED VALVE TPR	CLAPET À LAMELLES TPR		9931640	9931640	9931640
VARIOTOP TPR con cinghia	VARIOTOP TPR with belt	VARIOTOP TPR avec courroie		9931300	9931300	9931300
VARIOTOP TPR con molla	VARIOTOP TPR with spring	VARIOTOP TPR avec ressort		9927610	9927610	9927610

PIAGGIO	PIAGGIO	PIAGGIO	PIAGGIO	PIAGGIO	PIAGGIO	PIAGGIO	PIAGGIO	PIAGGIO	PIAGGIO	PIAGGIO	PIAGGIO
NRG POWER PUREJET	NRG POWER PUREJET	NRG PUREJET	NRG PUREJET	NRG RST MC2	NTT	QUARTZ	SFERA	SFERA MAQUILLAGE 2	SFERA RST	TYPHOON	TYPHOON
07-09	10-11	02-04	10-10	96-98	95-96	92-96	91-93	94-94	95-97	01-04	05-08
50cc 2T-IE LC	50cc 2T-IE LC	50cc 2T-IE LC	50cc 2T-IE LC	50cc 2T LC	50cc 2T LC	50cc 2T LC	50cc 2T AC	50cc 2T AC	50cc 2T AC	50cc 2T AC	50cc 2T AC
Motore Piaggio	Motore Piaggio	Motore Piaggio	Motore Piaggio	Motore Piaggio	Motore Piaggio	Motore Piaggio	Motore Piaggio	Motore Piaggio	Motore Piaggio	Motore Piaggio	Motore Piaggio
				9926180	9926180	9926180	9926180	9926180	9926180	9926180	9926180
9929200	9929200	9929200	9929200	9929200	9929200	9929200	9929200	9929200	9929200	9929200	9929200
9928340	9928340	9928340	9928340	9928340	9928340	9928340	9928340	9928340	9928340	9928340	9928340
				9920590	9920590	9920590	9930060	9930060	9930060	9930060	9930060
				9928520	9928520	9928520	9921550	9921550	9921550	9921550	9921550
9930870	9930870	9930870	9930870	9930870	9930870	9930870	9930870	9930870	9930870	9930870	9930870
9931730	9931730	9931730	9931730	9931730	9931730	9931730	9931730	9931730	9931730	9931730	9931730
				9928390	9928390	9928390					
				9928440	9928440	9928440					
9931460	9931460	9931460	9931460	9931460	9931460	9931460	9931460	9931460	9931460	9931460	9931460
				9930160	9930160	9930160					
9931640	9931640	9931640	9931640	9931640	9931640	9931640	9931640	9931640	9931640	9931640	9931640
9931300	9931300	9931300	9931300							9931300	9931300
9927610	9927610	9927610	9927610	9927610	9927610	9927610	9927610	9927610	9927610	9927610	9927610

SCOOTER 50cc RACING

SCOOTER 50cc RACING



PIAGGIO	PIAGGIO	PIAGGIO	PIAGGIO
TYPHOON	TYPHOON 2T E2	TYPHOON 2T E3 CH	VESPA ET2
09-11	10-12	11-11	97-98
50cc 2T AC	50cc 2T AC	50cc 2T AC	50cc 2T AC
Motore Piaggio	Motore Piaggio	Motore Piaggio	Motore Piaggio

IT	EN	FR				
ALBERO MOTORE TPR CORSA STD Spinotto Ø 10	CRANKSHAFT TPR Standard stroke pin Ø10	VILEBREQUIN TPR COURSE STD Axe de piston Ø 10				
ALBERO MOTORE TPR CORSA STD Spinotto Ø 12	CRANKSHAFT TPR Standard stroke pin Ø12	VILEBREQUIN TPR COURSE STD Axe de piston Ø 12		9926180	9926180	9926180
COPERCHIO INGRANAGGI	GEAR COVER	COUVERCLE ENGRENAGES				
COPERCHIO TRASMISSIONE	TRANSMISSION COVER	COUVERCLE TRANSMISSION				
CUSCINETTI DI BANCO TPR CARBONITRURATI Serie	BEARINGS TPR Carbonitrided Series	PALIERI DE VILEBREQUIN TPR CARBONITRURÉS Jeu		9929200	9929200	9929200
FRIZIONE TPR GP REGOLABILE Patented	CLUTCH TPR GP Adjustable Patented	EMBAYAGE TPR GP RÉGLABLE Patented		9928340	9928340	9928340
GRUPPO TERMICO RACING MAGGIORATO C/TESTA (GHISA)	RACING CYLINDER KITS BIG BORE with head (CAST IRON)	CYLINDRE COMPLET RACING MAJORÉ AVEC CULASSE (FONTE)		9930060	9930060	9930060
GRUPPO TERMICO RACING 2004 C/TESTA SCOMPOSTA (GHISA)	RACING CYLINDER KITS BIG BORE without head (CAST IRON)	CYLINDRE COMPLET RACING 2004 AVEC CULASSE DÉCOMPOSÉE (FONTE)				
GRUPPO TRASFORMAZIONE DA ARIA AD ACQUA (GHISA)	CYLINDER KIT Conversion AC to LC (CAST IRON)	GROUPE TRANSFORMATION DE L'AIR À L'EAU (FONTE)				
GRUPPO TERMICO TPR IN ALLUMINIO Ø 47,6 Spinotto Ø 10	CYLINDER KIT TPR ALLUMINIUM Ø 47,6 Pin Ø 10	CYLINDRE COMPLET TPR EN ALUMINIUM Ø 47,6 Axe de Piston Ø 10				
GRUPPO TERMICO TPR IN ALLUMINIO Ø 47,6 Spinotto Ø 12	CYLINDER KIT TPR ALLUMINIUM Ø 47,6 Pin Ø 12	CYLINDRE COMPLET TPR EN ALUMINIUM Ø 47,6 Axe de Piston Ø 12		9921550	9921550	9921550
KIT ASPIRAZIONE COMPLETO MIKUNI TM 24 TPR 360	COMPLETE INLET KIT MIKUNI TM 24 TPR 360	KIT ASPIRATION COMPLET MIKUNI TM 24 TPR 360		9930870	9930870	9930870
KIT ASPIRAZIONE COMPLETO OKO 28 TPR 360	COMPLETE INLET KIT OKO 28 TPR 360	KIT ASPIRATION COMPLET OKO 28 TPR 360		9931730	9931730	9931730
MAXI KIT 77cc ALESAGGIO Ø 50 CORSA STD	MAXI KIT 77 cc Bore Ø 50 Standard stroke	MAXI KIT 77 cc ALÉSAGE Ø 50 COURSE STD				
MAXI KIT 86cc ALESAGGIO Ø 50 CORSA 44 mm	MAXI KIT 86 cc Bore Ø 50 stroke 44 mm	MAXI KIT 86 cc ALÉSAGE Ø 50 COURSE 44 mm				
RAPPORTO ALLUNGATO secondario	SHAFT/GEARS	RAPPORT ALLONGÉ secondaire				
SCARICO NARDÒ 2 omologato	EXHAUST NARDÒ 2 Approved	ÉCHAPPEMENT NARDÒ 2 homologué		9931460	9931460	9931460
SCARICO TPR GP omologato	EXHAUST TPR GP Approved	ÉCHAPPEMENT TPR GP homologué				
VALVOLA LAMELLARE TPR	REED VALVE TPR	CLAPET À LAMELLES TPR		9931640	9931640	9931640
VARIOTOP TPR con cinghia	VARIOTOP TPR with belt	VARIOTOP TPR avec courroie		9931300		
VARIOTOP TPR con molla	VARIOTOP TPR with spring	VARIOTOP TPR avec ressort		9927610	9927610	9927610

PIAGGIO	PIAGGIO	PIAGGIO	PIAGGIO	PIAGGIO	PIAGGIO	PIAGGIO	PIAGGIO	PIAGGIO	PIAGGIO	PIAGGIO	PIAGGIO
VESPA ET2	VESPA ET2 INIEZIONE	VESPA ET4	VESPA LX 2T	VESPA LX 2T	VESPA LX 2T TOURING & 30KM	VESPA LX 4T	VESPA LXV 2T	VESPA LXV 2T NAVY	VESPA S 2T & COLLEGE	ZIP	ZIP
98-05	97-00	00-05	05-08	09-13	10-13	05-09	06-09	08-08	07-12	92-93	95-96
50cc 2T AC	50cc 2T AC	50cc 4T AC	50cc 2T AC	50cc 2T AC	50cc 2T AC	50cc 4T AC	50cc 2T AC	50cc 2T AC	50cc 2T AC	50cc 2T AC	50cc 2T AC
Motore Piaggio	Motore Piaggio	Motore Piaggio	Motore Piaggio	Motore Piaggio	Motore Piaggio	Motore Piaggio	Motore Piaggio	Motore Piaggio	Motore Piaggio	Motore Piaggio	Motore Piaggio
9926180	9926180		9926180	9926180	9926180		9926180	9926180	9926180	9926180	9926180
9929200	9929200		9929200	9929200	9929200		9929200	9929200	9929200	9929200	9929200
9928340	9928340	9928340	9928340	9928340	9928340	9928340	9928340	9928340	9928340	9928340	9928340
9930060	9930060		9930060	9930060	9930060		9930060	9930060	9930060	9930060	9930060
9921550	9921550		9921550	9921550	9921550		9921550	9921550	9921550	9921550	9921550
9930870	9930870		9930870	9930870	9930870		9930870	9930870	9930870	9930870	9930870
9931730	9931730		9931730	9931730	9931730		9931730	9931730	9931730	9931730	9931730
9931460	9931460		9931460	9931460	9931460		9931460	9931460	9931460	9931460	9931460
9931640	9931640		9931640	9931640	9931640		9931640	9931640	9931640	9931640	9931640
	9931260	9931260	9931260	9931260	9931260	9931260	9931260	9931260	9931260		
9927610	9927610	9927610	9927610	9927610	9927610	9927610	9927610	9927610	9927610	9927610	9927610

SCOOTER 50cc RACING

SCOOTER 50cc RACING



PIAGGIO	PIAGGIO	PIAGGIO	PIAGGIO
ZIP 2T	ZIP 4T	ZIP 4T	ZIP BIMODALE
08-13	00-05	06-13	94-97
50cc 2T LC	50cc 4T AC	50cc 4T AC	50cc 2T AC
Motore Piaggio	Motore Piaggio	Motore Piaggio	Motore Piaggio

IT	EN	FR				
ALBERO MOTORE TPR CORSA STD Spinotto Ø 10	CRANKSHAFT TPR Standard stroke pin Ø10	VILEBREQUIN TPR COURSE STD Axe de piston Ø 10				
ALBERO MOTORE TPR CORSA STD Spinotto Ø 12	CRANKSHAFT TPR Standard stroke pin Ø12	VILEBREQUIN TPR COURSE STD Axe de piston Ø 12		9926180		9926180
COPERCHIO INGRANAGGI	GEAR COVER	COUVERCLE ENGRENAGES				
COPERCHIO TRASMISSIONE	TRANSMISSION COVER	COUVERCLE TRANSMISSION				
CUSCINETTI DI BANCO TPR CARBONITRURATI Serie	BEARINGS TPR Carbonitrided Series	PALIERI DE VILEBREQUIN TPR CARBONITRURÉS Jeu		9929200		9929200
FRIZIONE TPR GP REGOLABILE Patented	CLUTCH TPR GP Adjustable Patented	EMBAYAGE TPR GP RÉGLABLE Patented		9928340	9928340	9928340
GRUPPO TERMICO RACING MAGGIORATO C/TESTA (GHISA)	RACING CYLINDER KITS BIG BORE with head (CAST IRON)	CYLINDRE COMPLET RACING MAJORÉ AVEC CULASSE (FONTE)		9920590		9930060
GRUPPO TERMICO RACING 2004 C/TESTA SCOMPOSTA (GHISA)	RACING CYLINDER KITS BIG BORE without head (CAST IRON)	CYLINDRE COMPLET RACING 2004 AVEC CULASSE DÉCOMPOSÉE (FONTE)				
GRUPPO TRASFORMAZIONE DA ARIA AD ACQUA (GHISA)	CYLINDER KIT Conversion AC to LC (CAST IRON)	GROUPE TRANSFORMATION DE L'AIR À L'EAU (FONTE)				
GRUPPO TERMICO TPR IN ALLUMINIO Ø 47,6 Spinotto Ø 10	CYLINDER KIT TPR ALLUMINIUM Ø 47,6 Pin Ø 10	CYLINDRE COMPLET TPR EN ALUMINIUM Ø 47,6 Axe de Piston Ø 10				
GRUPPO TERMICO TPR IN ALLUMINIO Ø 47,6 Spinotto Ø 12	CYLINDER KIT TPR ALLUMINIUM Ø 47,6 Pin Ø 12	CYLINDRE COMPLET TPR EN ALUMINIUM Ø 47,6 Axe de Piston Ø 12		9928520		9921550
KIT ASPIRAZIONE COMPLETO MIKUNI TM 24 TPR 360	COMPLETE INLET KIT MIKUNI TM 24 TPR 360	KIT ASPIRATION COMPLET MIKUNI TM 24 TPR 360		9930870		9930870
KIT ASPIRAZIONE COMPLETO OKO 28 TPR 360	COMPLETE INLET KIT OKO 28 TPR 360	KIT ASPIRATION COMPLET OKO 28 TPR 360		9931730		9931730
MAXI KIT 77cc ALESAGGIO Ø 50 CORSA STD	MAXI KIT 77 cc Bore Ø 50 Standard stroke	MAXI KIT 77 cc ALÉSAGE Ø 50 COURSE STD		9928390		
MAXI KIT 86cc ALESAGGIO Ø 50 CORSA 44 mm	MAXI KIT 86 cc Bore Ø 50 stroke 44 mm	MAXI KIT 86 cc ALÉSAGE Ø 50 COURSE 44 mm		9928440		
RAPPORTO ALLUNGATO secondario	SHAFT/GEARS	RAPPORT ALLONGÉ secondaire				
SCARICO NARDÒ 2 omologato	EXHAUST NARDÒ 2 Approved	ÉCHAPPEMENT NARDÒ 2 homologué		9931460		9931460
SCARICO TPR GP omologato	EXHAUST TPR GP Approved	ÉCHAPPEMENT TPR GP homologué		9930160		
VALVOLA LAMELLARE TPR	REED VALVE TPR	CLAPET À LAMELLES TPR		9931640		9931640
VARIOTOP TPR con cinghia	VARIOTOP TPR with belt	VARIOTOP TPR avec courroie		9931260	9931260	9931260
VARIOTOP TPR con molla	VARIOTOP TPR with spring	VARIOTOP TPR avec ressort		9927610	9927610	9927610

PIAGGIO	PIAGGIO	PIAGGIO	PIAGGIO	PIAGGIO	PIAGGIO	PIAGGIO	RIEJU	RIEJU	SYM	YAMAHA	YAMAHA
ZIP FAST RIDER	ZIP FAST RIDER RST	ZIP LC	ZIP RST	ZIP SP	ZIP SP	ZIP SP EURO 2	FIRST	WINDY	SYMPLY EURO 2	AEROX	AEROX
93-94	96-97	00-04	96-99	96-00	01-04	06-13	95-98	95-98	07-08	97-12	01-02
50cc 2T AC	50cc 2T AC	50cc 2T LC	50cc 2T AC	50cc 2T LC	50cc 2T LC	50cc 2T LC	50cc 2T AC	50cc 2T AC	50cc 4T AC	50cc 2T LC	50cc 2T LC
Motore Piaggio	Motore Piaggio	Motore Piaggio	Motore Piaggio	Motore Piaggio	Motore Piaggio	Motore Piaggio	MY	MY	Tipo Kymco	MA	MA
							9925910	9925910		9925910	9925910
9926180	9926180	9926180	9926180	9926180	9926180	9926180	9928320	9928320		9928320	9928320
							9930300	9930300		9930300	9930300
							9930200	9930200		9930200	9930200
9929200	9929200	9929200	9929200	9929200	9929200	9929200	9929190	9929190		9929190	9929190
9928340	9928340	9928340	9928340	9928340	9928340	9928340	9927450	9927450		9927450	9927450
9930060	9930060	9920590	9930060	9920590	9920590	9920590	9930030	9930030		9912800	9912800
										9921160	9921160
							9911210	9911210			
							9921630	9921630		9928480	9928480
9921550	9921550	9928520	9921550	9928520	9928520	9928520				9928550	9928550
9930870	9930870	9930870	9930870	9930870	9930870	9930870	9930830	9930830		9930830	9930830
9931730	9931730	9931730	9931730	9931730	9931730	9931730	9931710	9931710		9931710	9931710
		9928390		9928390	9928390	9928390				9926580	9926580
		9928440		9928440	9928440	9928440				9926560	9926560
							990875P	990875P		990875P	990875P
9931460	9931460	9931460	9931460	9931460	9931460	9931460				9931440	9931440
		9930160		9930160	9930160	9930160				9930140	9930140
9931640	9931640	9931640	9931640	9931640	9931640	9931640	9931620	9931620		9931620	9931620
		9931260		9931260	9931260	9931260	9931670	9931670		9931670	9931670
9927610	9927610	9927610	9927610	9927610	9927610	9927610	9931650	9931650	9937610	9931650	9931650

SCOOTER 50cc RACING

SCOOTER 50cc RACING



YAMAHA	YAMAHA	YAMAHA	YAMAHA
AEROX	AEROX	AEROX	AEROX
04-04	05-05	06-06	07-07
50cc 2T LC	50cc 2T LC	50cc 2T LC	50cc 2T LC
MA	MA	MA	MA

IT	EN	FR					
ALBERO MOTORE TPR CORSA STD Spinotto Ø 10	CRANKSHAFT TPR Standard stroke pin Ø10	VILEBREQUIN TPR COURSE STD Axe de piston Ø 10		9925910	9925910	9925910	9925910
ALBERO MOTORE TPR CORSA STD Spinotto Ø 12	CRANKSHAFT TPR Standard stroke pin Ø12	VILEBREQUIN TPR COURSE STD Axe de piston Ø 12		9928320	9928320	9928320	9928320
COPERCHIO INGRANAGGI	GEAR COVER	COUVERCLE ENGRENAGES		9930300	9930300	9930300	9930300
COPERCHIO TRASMISSIONE	TRANSMISSION COVER	COUVERCLE TRANSMISSION		9930200	9930200	9930200	9930200
CUSCINETTI DI BANCO TPR CARBONITRURATI Serie	BEARINGS TPR Carbonitrided Series	PALIERI DE VILEBREQUIN TPR CARBONITRURÉS Jeu		9929190	9929190	9929190	9929190
FRIZIONE TPR GP REGOLABILE Patented	CLUTCH TPR GP Adjustable Patented	EMBAYAGE TPR GP RÉGLABLE Patented		9927450	9927450	9927450	9927450
GRUPPO TERMICO RACING MAGGIORATO C/TESTA (GHISA)	RACING CYLINDER KITS BIG BORE with head (CAST IRON)	CYLINDRE COMPLET RACING MAJORÉ AVEC CULASSE (FONTE)		9912800	9912800	9912800	9912800
GRUPPO TERMICO RACING 2004 C/TESTA SCOMPOSTA (GHISA)	RACING CYLINDER KITS BIG BORE without head (CAST IRON)	CYLINDRE COMPLET RACING 2004 AVEC CULASSE DÉCOMPOSÉE (FONTE)		9921160	9921160	9921160	9921160
GRUPPO TRASFORMAZIONE DA ARIA AD ACQUA (GHISA)	CYLINDER KIT Conversion AC to LC (CAST IRON)	GROUPE TRANSFORMATION DE L'AIR À L'EAU (FONTE)					
GRUPPO TERMICO TPR IN ALLUMINIO Ø 47,6 Spinotto Ø 10	CYLINDER KIT TPR ALLUMINIUM Ø 47,6 Pin Ø 10	CYLINDRE COMPLET TPR EN ALUMINIUM Ø 47,6 Axe de Piston Ø 10		9928480	9928480	9928480	9928480
GRUPPO TERMICO TPR IN ALLUMINIO Ø 47,6 Spinotto Ø 12	CYLINDER KIT TPR ALLUMINIUM Ø 47,6 Pin Ø 12	CYLINDRE COMPLET TPR EN ALUMINIUM Ø 47,6 Axe de Piston Ø 12		9928550	9928550	9928550	9928550
KIT ASPIRAZIONE COMPLETO MIKUNI TM 24 TPR 360	COMPLETE INLET KIT MIKUNI TM 24 TPR 360	KIT ASPIRATION COMPLET MIKUNI TM 24 TPR 360		9930830	9930830	9930830	9930830
KIT ASPIRAZIONE COMPLETO OKO 28 TPR 360	COMPLETE INLET KIT OKO 28 TPR 360	KIT ASPIRATION COMPLET OKO 28 TPR 360		9931710	9931710	9931710	9931710
MAXI KIT 77cc ALESAGGIO Ø 50 CORSA STD	MAXI KIT 77 cc Bore Ø 50 Standard stroke	MAXI KIT 77 cc ALÉSAGE Ø 50 COURSE STD		9926580	9926580	9926580	9926580
MAXI KIT 86cc ALESAGGIO Ø 50 CORSA 44 mm	MAXI KIT 86 cc Bore Ø 50 stroke 44 mm	MAXI KIT 86 cc ALÉSAGE Ø 50 COURSE 44 mm		9926560	9926560	9926560	9926560
RAPPORTO ALLUNGATO secondario	SHAFT/GEARS	RAPPORT ALLONGÉ secondaire		990875P	990875P	990875P	990875P
SCARICO NARDÒ 2 omologato	EXHAUST NARDÒ 2 Approved	ÉCHAPPEMENT NARDÒ 2 homologué		9931440	9931440	9931440	9931440
SCARICO TPR GP omologato	EXHAUST TPR GP Approved	ÉCHAPPEMENT TPR GP homologué		9930140	9930140	9930140	9930140
VALVOLA LAMELLARE TPR	REED VALVE TPR	CLAPET À LAMELLES TPR		9931620	9931620	9931620	9931620
VARIOTOP TPR con cinghia	VARIOTOP TPR with belt	VARIOTOP TPR avec courroie		9931670	9931670	9931670	9931670
VARIOTOP TPR con molla	VARIOTOP TPR with spring	VARIOTOP TPR avec ressort		9931650	9931650	9931650	9931650

YAMAHA	YAMAHA	YAMAHA	YAMAHA	YAMAHA	YAMAHA	YAMAHA	YAMAHA	YAMAHA	YAMAHA	YAMAHA	YAMAHA
AEROX	AEROX	AEROX	AEROX	AEROX EURO 2	AEROX NAKED	AEROX R	AEROX R	AXIS	BREEZE	BW'S	BW'S
08-08	09-09	10-12	13-16	03-03	13-16	99-99	99-00	95-96	94-95	97-04	04-05
50cc 2T LC	50cc 2T LC	50cc 2T LC	50cc 2T LC	50cc 2T LC	50cc 2T LC	50cc 2T LC	50cc 2T LC	50cc 2T AC	50cc 2T AC	50cc 2T AC	50cc 2T AC
MA	MA	MA	MA	MA	MA	MA	MA	CY	CY	CW	CW
9925910	9925910	9925910	9925910	9925910	9925910	9925910	9925910	9925910	9925910	9927900	9927900
9928320	9928320	9928320	9928320	9928320	9928320	9928320	9928320	9928320	9928320		
9930300	9930300	9930300	9930300	9930300	9930300	9930300	9930300			9930300	9930300
9930200	9930200	9930200	9930200	9930200	9930200	9930200	9930200				
9929190	9929190	9929190	9929190	9929190	9929190	9929190	9929190	9929190	9929190	9929190	9929190
9927450	9927450	9927450	9927450	9927450	9927450	9927450	9927450			9927450	9927450
9912800	9912800	9912800	9912800	9912800	9912800	9912800	9912800	9930030	9930030	9930000	9930000
9921160	9921160	9921160	9921160	9921160	9921160	9921160	9921160				
								9911210	9911210		
9928480	9928480	9928480	9928480	9928480	9928480	9928480	9928480	9921630	9921630	9921640	9921640
9928550	9928550	9928550	9928550	9928550	9928550	9928550	9928550				
9930830	9930830	9930830	9930830	9930830	9930830	9930830	9930830	9930830	9930830		
9931710	9931710	9931710	9931710	9931710	9931710	9931710	9931710	9931710	9931710		
9926580	9926580	9926580	9926580	9926580	9926580	9926580	9926580				
9926560	9926560	9926560	9926560	9926560	9926560	9926560	9926560				
990875P	990875P	990875P	990875P	990875P	990875P	990875P	990875P			990875P	990875P
9931440	9931440	9931440	9931440	9931440	9931440	9931440	9931440	9931440	9931440	9931450	
9930140	9930140	9930140	9930140	9930140	9930140	9930140	9930140				
9931620	9931620	9931620	9931620	9931620	9931620	9931620	9931620	9931620	9931620		
9931670	9931670	9931670	9931670	9931670	9931670	9931670	9931670	9931690	9931690	9931670	9931670
9931650	9931650	9931650	9931650	9931650	9931650	9931650	9931650	9931650	9931650	9931650	9931650

SCOOTER 50cc
RACING

SCOOTER 50cc RACING



YAMAHA	YAMAHA	YAMAHA	YAMAHA
BW'S	BW'S	BW'S	BW'S BUMP
06-07	08-12	13-16	97-98
50cc 2T AC	50cc 2T AC	50cc 2T AC	50cc 2T AC
CW	CW	CW	CW

IT	EN	FR					
ALBERO MOTORE TPR CORSA STD Spinotto Ø 10	CRANKSHAFT TPR Standard stroke pin Ø10	VILEBREQUIN TPR COURSE STD Axe de piston Ø 10		9927900	9927900	9927900	9927900
ALBERO MOTORE TPR CORSA STD Spinotto Ø 12	CRANKSHAFT TPR Standard stroke pin Ø12	VILEBREQUIN TPR COURSE STD Axe de piston Ø 12					
COPERCHIO INGRANAGGI	GEAR COVER	COUVERCLE ENGRENAGES		9930300	9930300	9930300	9930300
COPERCHIO TRASMISSIONE	TRANSMISSION COVER	COUVERCLE TRANSMISSION					
CUSCINETTI DI BANCO TPR CARBONITRURATI Serie	BEARINGS TPR Carbonitrided Series	PALIERI DE VILEBREQUIN TPR CARBONITRURÉS Jeu		9929190	9929190	9929190	9929190
FRIZIONE TPR GP REGOLABILE Patented	CLUTCH TPR GP Adjustable Patented	EMBAYAGE TPR GP RÉGLABLE Patented		9927450	9927450	9927450	9927450
GRUPPO TERMICO RACING MAGGIORATO C/TESTA (GHISA)	RACING CYLINDER KITS BIG BORE with head (CAST IRON)	CYLINDRE COMPLET RACING MAJORÉ AVEC CULASSE (FONTE)		9930000	9930000	9930000	9930000
GRUPPO TERMICO RACING 2004 C/TESTA SCOMPOSTA (GHISA)	RACING CYLINDER KITS BIG BORE without head (CAST IRON)	CYLINDRE COMPLET RACING 2004 AVEC CULASSE DÉCOMPOSÉE (FONTE)					
GRUPPO TRASFORMAZIONE DA ARIA AD ACQUA (GHISA)	CYLINDER KIT Conversion AC to LC (CAST IRON)	GROUPE TRANSFORMATION DE L'AIR À L'EAU (FONTE)					
GRUPPO TERMICO TPR IN ALLUMINIO Ø 47,6 Spinotto Ø 10	CYLINDER KIT TPR ALLUMINIUM Ø 47,6 Pin Ø 10	CYLINDRE COMPLET TPR EN ALUMINIUM Ø 47,6 Axe de Piston Ø 10		9921640	9921640	9921640	9921640
GRUPPO TERMICO TPR IN ALLUMINIO Ø 47,6 Spinotto Ø 12	CYLINDER KIT TPR ALLUMINIUM Ø 47,6 Pin Ø 12	CYLINDRE COMPLET TPR EN ALUMINIUM Ø 47,6 Axe de Piston Ø 12					
KIT ASPIRAZIONE COMPLETO MIKUNI TM 24 TPR 360	COMPLETE INLET KIT MIKUNI TM 24 TPR 360	KIT ASPIRATION COMPLET MIKUNI TM 24 TPR 360					
KIT ASPIRAZIONE COMPLETO OKO 28 TPR 360	COMPLETE INLET KIT OKO 28 TPR 360	KIT ASPIRATION COMPLET OKO 28 TPR 360					
MAXI KIT 77cc ALESAGGIO Ø 50 CORSA STD	MAXI KIT 77 cc Bore Ø 50 Standard stroke	MAXI KIT 77 cc ALÉSAGE Ø 50 COURSE STD					
MAXI KIT 86cc ALESAGGIO Ø 50 CORSA 44 mm	MAXI KIT 86 cc Bore Ø 50 stroke 44 mm	MAXI KIT 86 cc ALÉSAGE Ø 50 COURSE 44 mm					
RAPPORTO ALLUNGATO secondario	SHAFT/GEARS	RAPPORT ALLONGÉ secondaire		990875P	990875P	990875P	990875P
SCARICO NARDÒ 2 omologato	EXHAUST NARDÒ 2 Approved	ÉCHAPPEMENT NARDÒ 2 homologué					9931450
SCARICO TPR GP omologato	EXHAUST TPR GP Approved	ÉCHAPPEMENT TPR GP homologué					
VALVOLA LAMELLARE TPR	REED VALVE TPR	CLAPET À LAMELLES TPR					
VARIOTOP TPR con cinghia	VARIOTOP TPR with belt	VARIOTOP TPR avec courroie		9931670	9931670	9931670	9931670
VARIOTOP TPR con molla	VARIOTOP TPR with spring	VARIOTOP TPR avec ressort		9931650	9931650	9931650	9931650

YAMAHA	YAMAHA	YAMAHA	YAMAHA	YAMAHA	YAMAHA	YAMAHA	YAMAHA	YAMAHA	YAMAHA	YAMAHA	YAMAHA
BW'S EASY	BW'S NAKED	BW'S NAKED	BW'S NAKED	BW'S NAKED	BW'S NEXT GENERATION	BW'S NEXT GENERATION	BW'S NEXT GENERATION	BW'S NEXT GENERATION	BW'S NEXT GENERATION	BW'S NEXT GENERATION	BW'S ORIGINAL
13-13	03-03	04-04	09-12	13-16	97-98	99-99	99-00	01-02	03-03	04-06	99-99
50cc 2T AC	50cc 2T AC	50cc 2T AC	50cc 2T AC	50cc 2T AC	50cc 2T AC	50cc 2T AC	50cc 2T AC	50cc 2T AC	50cc 2T AC	50cc 2T AC	50cc 2T AC
CW	CW	CW	CW	CW	CW	CW	CW	CW	CW	CW	CW
9927900	9927900	9927900	9927900	9927900	9927900	9927900	9927900	9927900	9927900	9927900	9927900
9930300	9930300	9930300	9930300	9930300	9930300	9930300	9930300	9930300	9930300	9930300	9930300
9929190	9929190	9929190	9929190	9929190	9929190	9929190	9929190	9929190	9929190	9929190	9929190
9927450	9927450	9927450	9927450	9927450	9927450	9927450	9927450	9927450	9927450	9927450	9927450
9930000	9930000	9930000	9930000	9930000	9930000	9930000	9930000	9930000	9930000	9930000	9930000
9921640	9921640	9921640	9921640	9921640	9921640	9921640	9921640	9921640	9921640	9921640	9921640
990875P	990875P	990875P	990875P	990875P	990875P	990875P	990875P	990875P	990875P	990875P	990875P
	9931450				9931450	9931450	9931450	9931450			9931450
9931670	9931670	9931670	9931670	9931670	9931670	9931670	9931670	9931670	9931670	9931670	9931670
9931650	9931650	9931650	9931650	9931650	9931650	9931650	9931650	9931650	9931650	9931650	9931650

SCOOTER 50cc RACING

SCOOTER 50cc RACING



YAMAHA	YAMAHA	YAMAHA	YAMAHA
BW'S ORIGINAL	BW'S ORIGINAL	BW'S ORIGINAL	BW'S ORIGINAL EURO 2
99-00	01-01	01-02	03-03
50cc 2T AC	50cc 2T AC	50cc 2T AC	50cc 2T AC
CW	CW	CW	CW

IT	EN	FR					
ALBERO MOTORE TPR CORSA STD Spinotto Ø 10	CRANKSHAFT TPR Standard stroke pin Ø10	VILEBREQUIN TPR COURSE STD Axe de piston Ø 10		9927900	9927900	9927900	9927900
ALBERO MOTORE TPR CORSA STD Spinotto Ø 12	CRANKSHAFT TPR Standard stroke pin Ø12	VILEBREQUIN TPR COURSE STD Axe de piston Ø 12					
COPERCHIO INGRANAGGI	GEAR COVER	COUVERCLE ENGRENAGES		9930300	9930300	9930300	9930300
COPERCHIO TRASMISSIONE	TRANSMISSION COVER	COUVERCLE TRANSMISSION					
CUSCINETTI DI BANCO TPR CARBONITRURATI Serie	BEARINGS TPR Carbonitrided Series	PALIERI DE VILEBREQUIN TPR CARBONITRURÉS Jeu		9929190	9929190	9929190	9929190
FRIZIONE TPR GP REGOLABILE Patented	CLUTCH TPR GP Adjustable Patented	EMBAYAGE TPR GP RÉGLABLE Patented		9927450	9927450	9927450	9927450
GRUPPO TERMICO RACING MAGGIORATO C/TESTA (GHISA)	RACING CYLINDER KITS BIG BORE with head (CAST IRON)	CYLINDRE COMPLET RACING MAJORÉ AVEC CULASSE (FONTE)		9930000	9930000	9930000	9930000
GRUPPO TERMICO RACING 2004 C/TESTA SCOMPOSTA (GHISA)	RACING CYLINDER KITS BIG BORE without head (CAST IRON)	CYLINDRE COMPLET RACING 2004 AVEC CULASSE DÉCOMPOSÉE (FONTE)					
GRUPPO TRASFORMAZIONE DA ARIA AD ACQUA (GHISA)	CYLINDER KIT Conversion AC to LC (CAST IRON)	GROUPE TRANSFORMATION DE L'AIR À L'EAU (FONTE)					
GRUPPO TERMICO TPR IN ALLUMINIO Ø 47,6 Spinotto Ø 10	CYLINDER KIT TPR ALLUMINIUM Ø 47,6 Pin Ø 10	CYLINDRE COMPLET TPR EN ALUMINIUM Ø 47,6 Axe de Piston Ø 10		9921640	9921640	9921640	9921640
GRUPPO TERMICO TPR IN ALLUMINIO Ø 47,6 Spinotto Ø 12	CYLINDER KIT TPR ALLUMINIUM Ø 47,6 Pin Ø 12	CYLINDRE COMPLET TPR EN ALUMINIUM Ø 47,6 Axe de Piston Ø 12					
KIT ASPIRAZIONE COMPLETO MIKUNI TM 24 TPR 360	COMPLETE INLET KIT MIKUNI TM 24 TPR 360	KIT ASPIRATION COMPLET MIKUNI TM 24 TPR 360					
KIT ASPIRAZIONE COMPLETO OKO 28 TPR 360	COMPLETE INLET KIT OKO 28 TPR 360	KIT ASPIRATION COMPLET OKO 28 TPR 360					
MAXI KIT 77cc ALESAGGIO Ø 50 CORSA STD	MAXI KIT 77 cc Bore Ø 50 Standard stroke	MAXI KIT 77 cc ALÉSAGE Ø 50 COURSE STD					
MAXI KIT 86cc ALESAGGIO Ø 50 CORSA 44 mm	MAXI KIT 86 cc Bore Ø 50 stroke 44 mm	MAXI KIT 86 cc ALÉSAGE Ø 50 COURSE 44 mm					
RAPPORTO ALLUNGATO secondario	SHAFT/GEARS	RAPPORT ALLONGÉ secondaire		990875P	990875P	990875P	990875P
SCARICO NARDÒ 2 omologato	EXHAUST NARDÒ 2 Approved	ÉCHAPPEMENT NARDÒ 2 homologué		9931450	9931450	9931450	
SCARICO TPR GP omologato	EXHAUST TPR GP Approved	ÉCHAPPEMENT TPR GP homologué					
VALVOLA LAMELLARE TPR	REED VALVE TPR	CLAPET À LAMELLES TPR					
VARIOTOP TPR con cinghia	VARIOTOP TPR with belt	VARIOTOP TPR avec courroie		9931670	9931670	9931670	9931670
VARIOTOP TPR con molla	VARIOTOP TPR with spring	VARIOTOP TPR avec ressort		9931650	9931650	9931650	9931650

YAMAHA	YAMAHA	YAMAHA	YAMAHA	YAMAHA	YAMAHA	YAMAHA	YAMAHA	YAMAHA	YAMAHA	YAMAHA	YAMAHA
CRZ	CT	GIGGLE	JOG	JOG ER	JOG R	JOG R EURO2	JOG R EURO2	JOG R EURO2	JOG R LC	JOG Z	NEO'S
91-95	90-95	08-08	92-01	00-02	02-02	02-02	06-12	13-15	02-15	95-95	97-13
50cc 2T AC	50cc 2T AC	50cc 4T-3V LC	50cc 2T AC	50cc 2T AC	50cc 2T AC	50cc 2T AC	50cc 2T AC	50cc 2T AC	50cc 2T LC	50cc 2T AC	50cc 2T AC
Tipo CW	Tipo CW	15P1	Tipo CY	Tipo CY	MY	MY	MY	MY	MA	Tipo CY	MY
			9925910		9925910	9925910	9925910	9925910	9925910		9925910
			9928320		9928320	9928320	9928320	9928320	9928320		9928320
					9930300	9930300	9930300	9930300	9930300		9930300
					9930200	9930200	9930200	9930200	9930200		9930200
			9929190	9929190	9929190	9929190	9929190	9929190	9929190	9929190	9929190
9927450	9927450				9927450	9927450	9927450	9927450	9927450		9927450
			9930030	9930030	9930030	9930030	9930030	9930030	9912800	9930030	9930030
									9921160		
			9911210	9911210	9911210	9911210	9911210	9911210		9911210	9911210
		9926330	9921630	9921630	9921630	9921630	9921630	9921630	9928480	9921630	9921630
									9928550		
			9930830	9930830	9930830	9930830	9930830	9930830	9930830	9930830	9930830
			9931710	9931710	9931710	9931710	9931710	9931710	9931710	9931710	9931710
									9926580		
									9926560		
					990875P	990875P	990875P	990875P	990875P		990875P
			9931440	9931440	9931440	9931440	9931440	9931440	9931440	9931440	9931440
									9930140		
			9931620		9931620	9931620	9931620	9931620	9931620		9931620
			9931690		9931670	9931670	9931670	9931670	9931670		9931670
		9926130	9931650		9931650	9931650	9931650	9931650	9931650		9931650

SCOOTER 50cc
RACING

SCOOTER 50cc RACING



YAMAHA	YAMAHA	YAMAHA	YAMAHA
NEO'S	NEO'S	NEO'S	NEO'S
02-02	04-06	07-12	12-16
50cc 2T AC	50cc 2T AC	50cc 2T AC	50cc 2T AC
MY	MY	MY	MY

IT	EN	FR				
ALBERO MOTORE TPR CORSA STD Spinotto Ø 10	CRANKSHAFT TPR Standard stroke pin Ø10	VILEBREQUIN TPR COURSE STD Axe de piston Ø 10		9925910	9925910	9925910
ALBERO MOTORE TPR CORSA STD Spinotto Ø 12	CRANKSHAFT TPR Standard stroke pin Ø12	VILEBREQUIN TPR COURSE STD Axe de piston Ø 12		9928320	9928320	9928320
COPERCHIO INGRANAGGI	GEAR COVER	COUVERCLE ENGRENAGES		9930300	9930300	9930300
COPERCHIO TRASMISSIONE	TRANSMISSION COVER	COUVERCLE TRANSMISSION		9930200	9930200	9930200
CUSCINETTI DI BANCO TPR CARBONITRURATI Serie	BEARINGS TPR Carbonitrided Series	PALIERI DE VILEBREQUIN TPR CARBONITRURÉS Jeu		9929190	9929190	9929190
FRIZIONE TPR GP REGOLABILE Patented	CLUTCH TPR GP Adjustable Patented	EMBAYAGE TPR GP RÉGLABLE Patented		9927450	9927450	9927450
GRUPPO TERMICO RACING MAGGIORATO C/TESTA (GHISA)	RACING CYLINDER KITS BIG BORE with head (CAST IRON)	CYLINDRE COMPLET RACING MAJORÉ AVEC CULASSE (FONTE)		9930030	9930030	9930030
GRUPPO TERMICO RACING 2004 C/TESTA SCOMPOSTA (GHISA)	RACING CYLINDER KITS BIG BORE without head (CAST IRON)	CYLINDRE COMPLET RACING 2004 AVEC CULASSE DÉCOMPOSÉE (FONTE)				
GRUPPO TRASFORMAZIONE DA ARIA AD ACQUA (GHISA)	CYLINDER KIT Conversion AC to LC (CAST IRON)	GROUPE TRANSFORMATION DE L'AIR À L'EAU (FONTE)		9911210	9911210	9911210
GRUPPO TERMICO TPR IN ALLUMINIO Ø 47,6 Spinotto Ø 10	CYLINDER KIT TPR ALLUMINIUM Ø 47,6 Pin Ø 10	CYLINDRE COMPLET TPR EN ALUMINIUM Ø 47,6 Axe de Piston Ø 10		9921630	9921630	9921630
GRUPPO TERMICO TPR IN ALLUMINIO Ø 47,6 Spinotto Ø 12	CYLINDER KIT TPR ALLUMINIUM Ø 47,6 Pin Ø 12	CYLINDRE COMPLET TPR EN ALUMINIUM Ø 47,6 Axe de Piston Ø 12				
KIT ASPIRAZIONE COMPLETO MIKUNI TM 24 TPR 360	COMPLETE INLET KIT MIKUNI TM 24 TPR 360	KIT ASPIRATION COMPLET MIKUNI TM 24 TPR 360		9930830	9930830	9930830
KIT ASPIRAZIONE COMPLETO OKO 28 TPR 360	COMPLETE INLET KIT OKO 28 TPR 360	KIT ASPIRATION COMPLET OKO 28 TPR 360		9931710	9931710	9931710
MAXI KIT 77cc ALESAGGIO Ø 50 CORSA STD	MAXI KIT 77 cc Bore Ø 50 Standard stroke	MAXI KIT 77 cc ALÉSAGE Ø 50 COURSE STD				
MAXI KIT 86cc ALESAGGIO Ø 50 CORSA 44 mm	MAXI KIT 86 cc Bore Ø 50 stroke 44 mm	MAXI KIT 86 cc ALÉSAGE Ø 50 COURSE 44 mm				
RAPPORTO ALLUNGATO secondario	SHAFT/GEARS	RAPPORT ALLONGÉ secondaire		990875P	990875P	990875P
SCARICO NARDÒ 2 omologato	EXHAUST NARDÒ 2 Approved	ÉCHAPPEMENT NARDÒ 2 homologué		9931440	9931440	9931440
SCARICO TPR GP omologato	EXHAUST TPR GP Approved	ÉCHAPPEMENT TPR GP homologué				
VALVOLA LAMELLARE TPR	REED VALVE TPR	CLAPET À LAMELLES TPR		9931620	9931620	9931620
VARIOTOP TPR con cinghia	VARIOTOP TPR with belt	VARIOTOP TPR avec courroie		9931670	9931670	9931670
VARIOTOP TPR con molla	VARIOTOP TPR with spring	VARIOTOP TPR avec ressort		9931650	9931650	9931650

YAMAHA	YAMAHA	YAMAHA	YAMAHA	YAMAHA	YAMAHA	YAMAHA	YAMAHA	YAMAHA	YAMAHA	YAMAHA
NEO'S 4	NEO'S 4	NEO'S 4	NEO'S EASY	NEO'S EURO 2	RS SPY	SLIDER	WHY	WHY EURO 2	ZEST	ZUMA
09-10	11-12	12-15	13-13	02-02	95-98	00-02	98-05	03-05	95-92	97-01
50cc 4T-3V LC	50cc 4T-3V LC	50cc 4T-3V LC	50cc 2T AC	50cc 2T AC	50cc 2T AC	50cc 2T AC	50cc 2T AC	50cc 2T AC	50cc 2T AC	50cc 2T AC
5C3	5C3	5C3	MY	MY	CW	CW	MY	MY	CY	CW
			9925910	9925910	9927900	9927900	9925910	9925910	9925910	9927900
			9928320	9928320			9928320	9928320	9928320	
			9930300	9930300	9930300	9930300	9930300	9930300		9930300
			9930200	9930200			9930200	9930200		
			9929190	9929190	9929190	9929190	9929190	9929190	9929190	9929190
			9927450	9927450	9927450	9927450	9927450	9927450		9927450
			9930030	9930030	9930000	9930000	9930030	9930030	9930030	9930000
			9911210	9911210			9911210	9911210	9911210	
9926330	9926330	9926330	9921630	9921630	9921640	9921640	9921630	9921630	9921630	9921640
			9930830	9930830			9930830	9930830	9930830	
			9931710	9931710			9931710	9931710	9931710	
			990875P	990875P	990875P	990875P				990875P
			9931440	9931440	9931450	9931450	9931440	9931440	9931440	9931450
			9931620	9931620			9931620	9931620	9931620	
			9931670	9931670	9931670	9931670	9931670	9931670	9931690	9931670
9926130	9926130	9926130	9931650	9931650	9931650	9931650	9931650	9931650	9931650	9931650

SCOOTER 50cc
RACING



APRILIA	APRILIA	APRILIA	APRILIA
ATLANTIC	ATLANTIC	ATLANTIC	ATLANTIC
03-05	03-05	03-05	10-11
125cc 4T LC	200cc 4T LC	250cc 4T LC	300cc 4T LC
	Piaggio M234M	Piaggio	Piaggio

IT	EN	FR				
ALBERO A CAMME	CAM SHAFT	ARBRE À CAMES				
ALBERO MOTORE Sel 1	Crankshaft Sel 1	VILEBREQUIN Sél 1				
ALBERO MOTORE Sel 2	Crankshaft Sel 2	VILEBREQUIN Sél 2				
BIELLA	CONROD	BIELLE				
CAMPANA FRIZIONE	CLUTCH HOUSING	CLOCHE EMBRAYAGE				
CINGHIA DI TRASMISSIONE Bando	TRANSMISSION BELT Bando	COURROIE DE TRANSMISSION Bando		9927650		
CINGHIA DI TRASMISSIONE Mitsuboshi	TRANSMISSION BELT Mitsuboshi	COURROIE DE TRANSMISSION Mitsuboshi			9935920	9935470
CINGHIA DI TRASMISSIONE Altro	TRANSMISSION BELT Other	COURROIE DE TRANSMISSION Autres				9935470
COLLETTORE ASPIRAZIONE	INLET MANIFOLD	COLLECTEUR ASPIRATION		CT00734	CT00734	CT00735
COLLETTORE ASPIRAZIONE SX	INLET MANIFOLD LEFT	COLLECTEUR ASPIRATION GAUCHE				
COLLETTORE ASPIRAZIONE DX	INLET MANIFOLD RIGHT	COLLECTEUR ASPIRATION DROITE				
FILTRO OLIO	OIL FILTER	FILTRE À HUILE		F007515	F007515	F007515
FRIZIONE	CLUTCH	EMBRAYAGE				
GRUPPO TERMICO Standard	CYLINDER KIT Ø standard	CYLINDRE COMPLET Standard				
GRUPPO TERMICO Maggiorato	CYLINDER KIT BIG BORE	CYLINDRE COMPLET Majoré				
KIT CUSCINETTI PARAOLI DI BANCO Serie	BEARINGS AND OIL SEALS KIT	KIT PALIERS JOINTS D'HUILE DE VILEBREQUIN Jeu				
KIT REVISIONE POMPA ACQUA	WATER PUMP REPAIR KIT	KIT RÉVISION POMPE À EAU		AA00817	AA00817	AA00828
KIT TAGLIANDO	SERVICE KIT	KIT COUPON				
MASSE CENTRIFUGHE PESO ORIGINALE	ROLLER WEIGHTS Standard weight	MASSELOTTE CENTRIFUGES POIDS D'ORIGINE			9932790	9931880
MEMBRANA CARBURATORE TIPO ORIGINALE	CARBURETOR DIAPHRAGM OEM	MEMBRANE CARBURATEUR TYPE ORIGINAL				
MEMBRANA CARBURATORE ADATTABILE	CARBURETOR DIAPHRAGM Adaptable	MEMBRANE CARBURATEUR ADAPTABLE		MC12106		
MOLLE CONTRASTO VARIATORE	REAR VARIATOR SPRING	RESSORTS CONTRASTE VARIATEUR				
MOLLA A GAS PER SELLA	SEAT GAS SPRING	RESSORT À GAZ POUR SELLE				
MOTORINO D'AVVIAMENTO	STARTER ENGINE	DÉMARREUR ÉLECTRIQUE		MA00012		MA00016
POMPA BENZINA	FUEL PUMP	POMPE À ESSENCE				
REGOLATORE DI TENSIONE	RECTIFIER	RÉGULATEUR DE TENSION		RE00011		
RUOTA LIBERA Completa	STARTER CLUTCH SET	ROUE LIBRE Complète				
RUOTA LIBERA RL + flangia	STARTER CLUTCH + FLANGE	ROUE LIBRE RL + flasque				RL00021
RUOTA LIBERA RL nuda	STARTER CLUTCH	ROUE LIBRE RL nue				
RUOTA LIBERA Ingranaggio	STARTER CLUTCH GEAR	ROUE LIBRE Engrenage		RL00022	RL00022	RL00023
RUOTA LIBERA Flangia	STARTER CLUTCH FLANGE	ROUE LIBRE Flasque				
SERIE DISCHI FRIZIONE	CLUTCH PLATES KIT	JEU DISQUES EMBRAYAGE				
STATORE	STATOR	STATOR				
VARIOTOP TPR	VARIOTOP TPR	VARIOTOP TPR		9923600	9923650	9923650

APRILIA	APRILIA	APRILIA	APRILIA	APRILIA	APRILIA	APRILIA	APRILIA	APRILIA	APRILIA	APRILIA	APRILIA
ATLANTIC	ATLANTIC ARRECIFE	ATLANTIC ARRECIFE	ATLANTIC ARRECIFE	ATLANTIC ARRECIFE	ATLANTIC ARRECIFE	ATLANTIC EU3	ATLANTIC EU3	ATLANTIC EU3	ATLANTIC SPRINT	ATLANTIC SPRINT	LEONARDO
01-04	03-05	03-05	03-05	05-08	05-08	06-08	10-12	06-08	05-08	05-08	96-98
500cc 4T LC	125cc 4T LC	200cc 4T LC	250cc 4T LC	400cc 4T LC	500cc 4T LC	125cc 4T LC	125cc 4T LC	250cc 4T LC	400cc 4T LC	500cc 4T LC	125cc 4T LC
		Piaggio M234M	Piaggio M237M	Piaggio M348M	Piaggio M273M	Piaggio	Piaggio	Piaggio M237M	Piaggio M348M	Piaggio M273M	Rotax
						IM070701	IM070701				
						IM070702	IM070702				
	9927650			9927630	9927630	9927650	9927650		9927630	9927630	9915220
9935460								9935470			9935660
F007524	F007515	F007515	F007515	F007524	F007524	F007515	F007515	F007515	F007524	F007524	F007516
	AA00817	AA00817				AA00826	AA00826	AA00828			AA00811
9922330								9931880			9916260
						MC12106	MC12106				
9926780				9926780	9926780				9926780	9926780	
MA00030						MA00012	MA00012	MA00016	MA00030	MA00030	MA00022
RE00004						RE00011	RE00011	RE00004	RE00004	RE00004	
RL00021		RL00021	RL00021	RL00021	RL00021	RL00041		RL00041	RL00021	RL00021	RL00005
RL00023				RL00023	RL00023	RL00022	RL00022	RL00023	RL00023	RL00023	RL00013
											RL00014
ST00005						ST00023		ST00023	ST00005	ST00005	
9923250	9923600	9923650	9923650		9923250	9923600	9923600	9923650		9923250	

MAXI SCOOTER



APRILIA	APRILIA	APRILIA	APRILIA
LEONARDO	LEONARDO	LEONARDO	LEONARDO
99-02	96-98	99-02	99-01
125cc 4T LC	150cc 4T LC	150cc 4T LC	250cc 4T LC
Rotax	Rotax	Rotax	Minarelli YP

IT	EN	FR				
ALBERO A CAMME	CAM SHAFT	ARBRE À CAMES				
ALBERO MOTORE Sel 1	Crankshaft Sel 1	VILEBREQUIN Sél 1				IM07054
ALBERO MOTORE Sel 2	Crankshaft Sel 2	VILEBREQUIN Sél 2				
BIELLA	CONROD	BIELLE				IM07037
CAMPANA FRIZIONE	CLUTCH HOUSING	CLOCHE EMBRAYAGE				
CINGHIA DI TRASMISSIONE Bando	TRANSMISSION BELT Bando	COURROIE DE TRANSMISSION Bando		9915220	9915220	9915220
CINGHIA DI TRASMISSIONE Mitsuboshi	TRANSMISSION BELT Mitsuboshi	COURROIE DE TRANSMISSION Mitsuboshi		9935660	9935660	9935660
CINGHIA DI TRASMISSIONE Altro	TRANSMISSION BELT Other	COURROIE DE TRANSMISSION Autres				
COLLETTORE ASPIRAZIONE	INLET MANIFOLD	COLLECTEUR ASPIRATION				
COLLETTORE ASPIRAZIONE SX	INLET MANIFOLD LEFT	COLLECTEUR ASPIRATION GAUCHE				
COLLETTORE ASPIRAZIONE DX	INLET MANIFOLD RIGHT	COLLECTEUR ASPIRATION DROITE				
FILTRO OLIO	OIL FILTER	FILTRE À HUILE		F007516	F007516	F007516
FRIZIONE	CLUTCH	EMBRAYAGE				
GRUPPO TERMICO Standard	CYLINDER KIT Ø standard	CYLINDRE COMPLET Standard				9926850
GRUPPO TERMICO Maggiorato	CYLINDER KIT BIG BORE	CYLINDRE COMPLET Majoré				
KIT CUSCINETTI PARAOLI DI BANCO Serie	BEARINGS AND OIL SEALS KIT	KIT PALIERS JOINTS D'HUILE DE VILEBREQUIN Jeu				KK01007
KIT REVISIONE POMPA ACQUA	WATER PUMP REPAIR KIT	KIT RÉVISION POMPE À EAU		AA00810	AA00811	AA00810
KIT TAGLIANDO	SERVICE KIT	KIT COUPON				
MASSE CENTRIFUGHE PESO ORIGINALE	ROLLER WEIGHTS Standard weight	MASSELOTES CENTRIFUGES POIDS D'ORIGINE		9916260	9915310	9918020
MEMBRANA CARBURATORE TIPO ORIGINALE	CARBURETOR DIAPHRAGM OEM	MEMBRANE CARBURATEUR TYPE ORIGINAL				MC12001
MEMBRANA CARBURATORE ADATTABILE	CARBURETOR DIAPHRAGM Adaptable	MEMBRANE CARBURATEUR ADAPTABLE				MC12101
MOLLE CONTRASTO VARIATORE	REAR VARIATOR SPRING	RESSORTS CONTRASTE VARIATEUR				9929870
MOLLA A GAS PER SELLA	SEAT GAS SPRING	RESSORT À GAZ POUR SELLE				
MOTORINO D'AVVIAMENTO	STARTER ENGINE	DÉMARREUR ÉLECTRIQUE		MA00022	MA00022	MA00022
POMPA BENZINA	FUEL PUMP	POMPE À ESSENCE				
REGOLATORE DI TENSIONE	RECTIFIER	RÉGULATEUR DE TENSION				
RUOTA LIBERA Completa	STARTER CLUTCH SET	ROUE LIBRE Complète				
RUOTA LIBERA RL + flangia	STARTER CLUTCH + FLANGE	ROUE LIBRE RL + flasque				RL00010
RUOTA LIBERA RL nuda	STARTER CLUTCH	ROUE LIBRE RL nue		RL00005	RL00005	RL00005
RUOTA LIBERA Ingranaggio	STARTER CLUTCH GEAR	ROUE LIBRE Engrenage		RL00013	RL00013	RL00013
RUOTA LIBERA Flangia	STARTER CLUTCH FLANGE	ROUE LIBRE Flasque		RL00014	RL00014	RL00014
SERIE DISCHI FRIZIONE	CLUTCH PLATES KIT	JEU DISQUES EMBRAYAGE				
STATORE	STATOR	STATOR				
VARIOTOP TPR	VARIOTOP TPR	VARIOTOP TPR				9931790

APRILIA	APRILIA	APRILIA	APRILIA	APRILIA	APRILIA	APRILIA	APRILIA	APRILIA	APRILIA	APRILIA	APRILIA
LEONARDO	LEONARDO	LEONARDO ST	LEONARDO ST	MOJITO	MOJITO	MOJITO	MOJITO RETRO' CUSTOM	SCARABEO	SCARABEO	SCARABEO	SCARABEO
02-04	02-04	03-04	01-01	03-07	08-08	03-07	99-01	99-03	03-03	04-06	99-03
250cc 4T LC	300cc 4T LC	125cc 4T LC	250cc 4T LC	125cc 4T AC	125cc 4T AC	150cc 4T AC	125cc 4T AC	125cc 4T LC	125cc 4T LC	125cc 4T LC	150cc 4T LC
Minarelli YP	Minarelli YP	Rotax	Minarelli YP	Leader	Piaggio			Rotax	Piaggio	Piaggio	Rotax
IM07054			IM07054	IM070701	IM070701						
				IM070702	IM070702						
IM07037	IM07037		IM07037								
9915800	9915800	9915220	9915800	9927650	9927650	9927650		9915220	9928540	9928540	9915220
9935710	9935710	9935660	9935710				9935430	9935660			9935660
				CT00736	CT00736				CT00734	CT00734	
		F007516		F007515	F007515	F007515	F007514	F007516	F007515	F007515	F007516
9926850			9926850								
KK01007	KK01007		KK01007								
AA00806	AA00806	AA00810	AA00806					AA00810		AA00817	AA00810
9918020	9918020	9916260	9918020					9916260			9915310
MC12001	MC12001		MC12001	MC12002	MC12002	MC12002					
MC12101	MC12101		MC12101	MC12107	MC12107					MC12106	
9929870			9929870								
MA00010	MA00010	MA00022	MA00010	MA00012	MA00012			MA00022	MA00012	MA00012	MA00022
				RE00011	RE00011	RE00011	RE00012		RE00011	RE00011	
RL00010	RL00010		RL00010								
		RL00005						RL00005			RL00005
RL00011	RL00011	RL00013	RL00011	RL00022	RL00022	RL00022		RL00013	RL00022	RL00022	RL00013
		RL00014						RL00014			RL00014
9931790			9931790	9923600	9923600	9923600		9923600	9923600		

MAXI SCOOTER



APRILIA	APRILIA	APRILIA	APRILIA
SCARABEO	SCARABEO	SCARABEO	SCARABEO
04-06	01-03	03-03	04-06
150cc 4T LC	200cc 4T LC	200cc 4T LC	250cc 4T LC
Piaggio	Rotax	Piaggio	Piaggio M258M

IT	EN	FR				
ALBERO A CAMME	CAM SHAFT	ARBRE À CAMES				
ALBERO MOTORE Sel 1	Crankshaft Sel 1	VILEBREQUIN Sél 1				
ALBERO MOTORE Sel 2	Crankshaft Sel 2	VILEBREQUIN Sél 2				
BIELLA	CONROD	BIELLE				
CAMPANA FRIZIONE	CLUTCH HOUSING	CLOCHE EMBRAYAGE				
CINGHIA DI TRASMISSIONE Bando	TRANSMISSION BELT Bando	COURROIE DE TRANSMISSION Bando		9928540		9927640
CINGHIA DI TRASMISSIONE Mitsuboshi	TRANSMISSION BELT Mitsuboshi	COURROIE DE TRANSMISSION Mitsuboshi			9935450	
CINGHIA DI TRASMISSIONE Altro	TRANSMISSION BELT Other	COURROIE DE TRANSMISSION Autres				
COLLETTORE ASPIRAZIONE	INLET MANIFOLD	COLLECTEUR ASPIRATION				CT00735
COLLETTORE ASPIRAZIONE SX	INLET MANIFOLD LEFT	COLLECTEUR ASPIRATION GAUCHE				
COLLETTORE ASPIRAZIONE DX	INLET MANIFOLD RIGHT	COLLECTEUR ASPIRATION DROITE				
FILTRO OLIO	OIL FILTER	FILTRE À HUILE		F007515	F007516	F007515
FRIZIONE	CLUTCH	EMBRAYAGE				
GRUPPO TERMICO Standard	CYLINDER KIT Ø standard	CYLINDRE COMPLET Standard				
GRUPPO TERMICO Maggiorato	CYLINDER KIT BIG BORE	CYLINDRE COMPLET Majoré				
KIT CUSCINETTI PARAOLI DI BANCO Serie	BEARINGS AND OIL SEALS KIT	KIT PALIERS JOINTS D'HUILE DE VILEBREQUIN Jeu				
KIT REVISIONE POMPA ACQUA	WATER PUMP REPAIR KIT	KIT RÉVISION POMPE À EAU		AA00817		AA00828
KIT TAGLIANDO	SERVICE KIT	KIT COUPON				
MASSE CENTRIFUGHE PESO ORIGINALE	ROLLER WEIGHTS Standard weight	MASSELOTES CENTRIFUGES POIDS D'ORIGINE			9932790	
MEMBRANA CARBURATORE TIPO ORIGINALE	CARBURETOR DIAPHRAGM OEM	MEMBRANE CARBURATEUR TYPE ORIGINAL				
MEMBRANA CARBURATORE ADATTABILE	CARBURETOR DIAPHRAGM Adaptable	MEMBRANE CARBURATEUR ADAPTABLE				
MOLLE CONTRASTO VARIATORE	REAR VARIATOR SPRING	RESSORTS CONTRASTE VARIATEUR				
MOLLA A GAS PER SELLA	SEAT GAS SPRING	RESSORT À GAZ POUR SELLE				
MOTORINO D'AVVIAMENTO	STARTER ENGINE	DÉMARREUR ÉLECTRIQUE			MA00022	MA00016
POMPA BENZINA	FUEL PUMP	POMPE À ESSENCE				
REGOLATORE DI TENSIONE	RECTIFIER	RÉGULATEUR DE TENSION		RE00011		
RUOTA LIBERA Completa	STARTER CLUTCH SET	ROUE LIBRE Complète				
RUOTA LIBERA RL + flangia	STARTER CLUTCH + FLANGE	ROUE LIBRE RL + flasque				
RUOTA LIBERA RL nuda	STARTER CLUTCH	ROUE LIBRE RL nue			RL00005	
RUOTA LIBERA Ingranaggio	STARTER CLUTCH GEAR	ROUE LIBRE Engrenage		RL00022	RL00013	RL00022
RUOTA LIBERA Flangia	STARTER CLUTCH FLANGE	ROUE LIBRE Flasque			RL00014	
SERIE DISCHI FRIZIONE	CLUTCH PLATES KIT	JEU DISQUES EMBRAYAGE				
STATORE	STATOR	STATOR				
VARIOTOP TPR	VARIOTOP TPR	VARIOTOP TPR		9923600		9923650

APRILIA	APRILIA	APRILIA	APRILIA	APRILIA	APRILIA	APRILIA	APRILIA	APRILIA	APRILIA	APRILIA	APRILIA
SCARABEO	SCARABEO EU3	SCARABEO EU3	SCARABEO IE LIGHT	SCARABEO IE LIGHT	SCARABEO IE LIGHT	SCARABEO LIGHT	SCARABEO LIGHT	SCARABEO LIGHT	SCARABEO LIGHT	SCARABEO LIGHT	SCARABEO LIGHT
03-06	06-07	06-06	09-10	11-12	11-12	07-08	07-08	06-08	09-10	06-08	06-08
500cc 4T LC	125cc 4T LC	200cc 4T LC	125cc 4T LC	125cc 4T LC	200cc 4T LC	125cc 4T LC	200cc 4T LC	250cc 4T LC	300cc 4T LC	400cc 4T LC	500cc 4T LC
Piaggio	Piaggio	Piaggio	Motore Aprilia	Motore Aprilia	Motore Aprilia	Aprilia BA03	Aprilia CA03	Piaggio	Piaggio	Piaggio	Piaggio
	IM070701										
	IM070702										
9927630	9928540							9927640	9927640	9927630	9927630
		9935450	9935220	9935220	9935220	9935220					9935500
F007524	F007515	F007515						F007515	F007515	F007524	F007524
	AA00826							AA00828	AA00828	AA00824	AA00824
									TG00102		
9922330		9932790						9931880	9931880	9924530	9935990
	MC12106										
9926780										9926780	9926780
MA00030	MA00012							MA00016	MA00016	MA00030	MA00030
RE00004	RE00011							RE00004	RE00004	RE00004	RE00004
RL00021								RL00041	RL00021	RL00021	RL00021
RL00023	RL00022	RL00022						RL00023	RL00023	RL00023	RL00023
ST00005								ST00023	ST00023	ST00005	ST00005
9923250	9923600	9923650	9923600	9923600	9923600	9923600	9923650	9923650	9923650		9923250



APRILIA	APRILIA	APRILIA	APRILIA
SPORT CITY	SPORT CITY	SPORT CITY CUBE	SPORT CITY CUBE
04-06	04-06	08-10	08-10
125cc 4T LC	200cc 4T LC	125cc 4T LC	200cc 4T LC
Piaggio M281M		Piaggio	Piaggio

IT	EN	FR	Image			
ALBERO A CAMME	CAM SHAFT	ARBRE À CAMES				
ALBERO MOTORE Sel 1	Crankshaft Sel 1	VILEBREQUIN Sél 1				
ALBERO MOTORE Sel 2	Crankshaft Sel 2	VILEBREQUIN Sél 2				
BIELLA	CONROD	BIELLE				
CAMPANA FRIZIONE	CLUTCH HOUSING	CLOCHE EMBRAYAGE				
CINGHIA DI TRASMISSIONE Bando	TRANSMISSION BELT Bando	COURROIE DE TRANSMISSION Bando				
CINGHIA DI TRASMISSIONE Mitsuboshi	TRANSMISSION BELT Mitsuboshi	COURROIE DE TRANSMISSION Mitsuboshi				
CINGHIA DI TRASMISSIONE Altro	TRANSMISSION BELT Other	COURROIE DE TRANSMISSION Autres				
COLLETTORE ASPIRAZIONE	INLET MANIFOLD	COLLECTEUR ASPIRATION				
COLLETTORE ASPIRAZIONE SX	INLET MANIFOLD LEFT	COLLECTEUR ASPIRATION GAUCHE				
COLLETTORE ASPIRAZIONE DX	INLET MANIFOLD RIGHT	COLLECTEUR ASPIRATION DROITE				
FILTRO OLIO	OIL FILTER	FILTRE À HUILE				
FRIZIONE	CLUTCH	EMBRAYAGE				
GRUPPO TERMICO Standard	CYLINDER KIT Ø standard	CYLINDRE COMPLET Standard				
GRUPPO TERMICO Maggiorato	CYLINDER KIT BIG BORE	CYLINDRE COMPLET Majoré				
KIT CUSCINETTI PARAOLI DI BANCO Serie	BEARINGS AND OIL SEALS KIT	KIT PALIERS JOINTS D'HUILE DE VILEBREQUIN Jeu				
KIT REVISIONE POMPA ACQUA	WATER PUMP REPAIR KIT	KIT RÉVISION POMPE À EAU				
KIT TAGLIANDO	SERVICE KIT	KIT COUPON				
MASSE CENTRIFUGHE PESO ORIGINALE	ROLLER WEIGHTS Standard weight	MASSELOTES CENTRIFUGES POIDS D'ORIGINE				
MEMBRANA CARBURATORE TIPO ORIGINALE	CARBURETOR DIAPHRAGM OEM	MEMBRANE CARBURATEUR TYPE ORIGINAL				
MEMBRANA CARBURATORE ADATTABILE	CARBURETOR DIAPHRAGM Adaptable	MEMBRANE CARBURATEUR ADAPTABLE				
MOLLE CONTRASTO VARIATORE	REAR VARIATOR SPRING	RESSORTS CONTRASTE VARIATEUR				
MOLLA A GAS PER SELLA	SEAT GAS SPRING	RESSORT À GAZ POUR SELLE				
MOTORINO D'AVVIAMENTO	STARTER ENGINE	DÉMARREUR ÉLECTRIQUE				
POMPA BENZINA	FUEL PUMP	POMPE À ESSENCE				
REGOLATORE DI TENSIONE	RECTIFIER	RÉGULATEUR DE TENSION				
RUOTA LIBERA Completa	STARTER CLUTCH SET	ROUE LIBRE Complète				
RUOTA LIBERA RL + flangia	STARTER CLUTCH + FLANGE	ROUE LIBRE RL + flasque				
RUOTA LIBERA RL nuda	STARTER CLUTCH	ROUE LIBRE RL nue				
RUOTA LIBERA Ingranaggio	STARTER CLUTCH GEAR	ROUE LIBRE Engrenage				
RUOTA LIBERA Flangia	STARTER CLUTCH FLANGE	ROUE LIBRE Flasque				
SERIE DISCHI FRIZIONE	CLUTCH PLATES KIT	JEU DISQUES EMBRAYAGE				
STATORE	STATOR	STATOR				
VARIOTOP TPR	VARIOTOP TPR	VARIOTOP TPR				

APRILIA	APRILIA	APRILIA	APRILIA	APRILIA	APRILIA	APRILIA	APRILIA	APRILIA	APRILIA	APRILIA	APRILIA
SPORT CITY CUBE	SPORT CITY CUBE	SPORT CITY EU3	SPORT CITY EU3	SPORT CITY EU3	SPORT CITY ONE 4T EU3	SPORT CITY STREET	SPORT CITY STREET	SR	SR	SR MAX	SR MAX
08-12	08-10	06-08	06-08	06-08	08-11	12-12	12-12	99-01	99-01	11-14	11-14
250cc 4T LC	300cc 4T LC	125cc 4T LC	200cc 4T LC	250cc 4T LC	125cc 4T AC	125cc 4T LC	300cc 4T-4V LC	125cc 2T AC	150cc 2T AC	125cc 4T LC	125cc 4T-4V LC
Piaggio	Leader M28LM	Piaggio	Piaggio M288M	Piaggio M288M	Leader M38AM	Piaggio	Piaggio	Piaggio	Piaggio	Piaggio	Piaggio
		IM070701			IM070701						
		IM070702			IM070702						
9927640	9927640	9928540		9927640	9927650	9928540	9927640	9915350	9915350	9927650	
			9935450					9935670	9935670		
					CT00736			CT00728	CT00728		
F007515	F007515	F007515	F007515	F007515	F007515	F007515	F007515			F007515	
		AA00826				AA00826	AA00828				
TG00102							TG00102				
9931880			9932790	9931880			9931880				
		MC12106			MC12107	MC12106					
MA00016		MA00012		MA00016	MA00012	MA00012	MA00016			MA00016	
RE00004		RE00011		RE00004	RE00011	RE00011	RE00004			RE00004	
RL00041	RL00021	RL00041					RL00021			RL00041	
RL00023	RL00023	RL00022	RL00022	RL00023	RL00022	RL00022	RL00023			RL00023	
ST00023		ST00023									ST00023
9923650	9923650	9923600	9923650	9923650	9923600	9923600	9923650			9923600	

MAXI SCOOTER

MAXI SCOOTER



APRILIA	APRILIA	APRILIA	BENELLI
SR MAX	SR MOTARD	SRV - SRV ABS ATC	ADIVA
11-14	12-14	12-14	01-02
300cc 4T LC	125cc 4T-2V AC	850cc 4T-4V LC	125cc 4T AC
Piaggio	Piaggio		Leader

IT	EN	FR				
ALBERO A CAMME	CAM SHAFT	ARBRE À CAMES				
ALBERO MOTORE Sel 1	Crankshaft Sel 1	VILEBREQUIN Sél 1				
ALBERO MOTORE Sel 2	Crankshaft Sel 2	VILEBREQUIN Sél 2				
BIELLA	CONROD	BIELLE				
CAMPANA FRIZIONE	CLUTCH HOUSING	CLOCHE EMBRAYAGE				
CINGHIA DI TRASMISSIONE Bando	TRANSMISSION BELT Bando	COURROIE DE TRANSMISSION Bando			9927650	9927650
CINGHIA DI TRASMISSIONE Mitsuboshi	TRANSMISSION BELT Mitsuboshi	COURROIE DE TRANSMISSION Mitsuboshi		9935470		9935930
CINGHIA DI TRASMISSIONE Altro	TRANSMISSION BELT Other	COURROIE DE TRANSMISSION Autres				
COLLETTORE ASPIRAZIONE	INLET MANIFOLD	COLLECTEUR ASPIRATION			CT00736	
COLLETTORE ASPIRAZIONE SX	INLET MANIFOLD LEFT	COLLECTEUR ASPIRATION GAUCHE				
COLLETTORE ASPIRAZIONE DX	INLET MANIFOLD RIGHT	COLLECTEUR ASPIRATION DROITE				
FILTRO OLIO	OIL FILTER	FILTRE À HUILE		F007515	F007515	F007515
FRIZIONE	CLUTCH	EMBRAYAGE				
GRUPPO TERMICO Standard	CYLINDER KIT Ø standard	CYLINDRE COMPLET Standard				
GRUPPO TERMICO Maggiorato	CYLINDER KIT BIG BORE	CYLINDRE COMPLET Majoré				
KIT CUSCINETTI PARAOLI DI BANCO Serie	BEARINGS AND OIL SEALS KIT	KIT PALIERS JOINTS D'HUILE DE VILEBREQUIN Jeu				
KIT REVISIONE POMPA ACQUA	WATER PUMP REPAIR KIT	KIT RÉVISION POMPE À EAU		AA00828		
KIT TAGLIANDO	SERVICE KIT	KIT COUPON				
MASSE CENTRIFUGHE PESO ORIGINALE	ROLLER WEIGHTS Standard weight	MASSELOTES CENTRIFUGES POIDS D'ORIGINE		9931880		
MEMBRANA CARBURATORE TIPO ORIGINALE	CARBURETOR DIAPHRAGM OEM	MEMBRANE CARBURATEUR TYPE ORIGINAL				
MEMBRANA CARBURATORE ADATTABILE	CARBURETOR DIAPHRAGM Adaptable	MEMBRANE CARBURATEUR ADAPTABLE			MC12107	
MOLLE CONTRASTO VARIATORE	REAR VARIATOR SPRING	RESSORTS CONTRASTE VARIATEUR				
MOLLA A GAS PER SELLA	SEAT GAS SPRING	RESSORT À GAZ POUR SELLE				
MOTORINO D'AVVIAMENTO	STARTER ENGINE	DÉMARREUR ÉLECTRIQUE		MA00016	MA00012	
POMPA BENZINA	FUEL PUMP	POMPE À ESSENCE				
REGOLATORE DI TENSIONE	RECTIFIER	RÉGULATEUR DE TENSION		RE00004	RE00012	
RUOTA LIBERA Completa	STARTER CLUTCH SET	ROUE LIBRE Complète				
RUOTA LIBERA RL + flangia	STARTER CLUTCH + FLANGE	ROUE LIBRE RL + flasque		RL00021		
RUOTA LIBERA RL nuda	STARTER CLUTCH	ROUE LIBRE RL nue				
RUOTA LIBERA Ingranaggio	STARTER CLUTCH GEAR	ROUE LIBRE Engrenage		RL00023	RL00022	
RUOTA LIBERA Flangia	STARTER CLUTCH FLANGE	ROUE LIBRE Flasque				
SERIE DISCHI FRIZIONE	CLUTCH PLATES KIT	JEU DISQUES EMBRAYAGE				
STATORE	STATOR	STATOR				
VARIOTOP TPR	VARIOTOP TPR	VARIOTOP TPR		9923650	9923600	9923600

BENELLI	BENELLI	BENELLI	BENELLI	BENELLI	BENELLI	BENELLI	BENELLI	BENELLI	BETA	BETA	BMW
ADIVA	ADIVA EU2	VELVET	VELVET	VELVET	VELVET	VELVET DUSK	VELVET TOURING	VELVET TOURING	EIKON	EIKON	BMW C 600 SPORT [K18]
01-02	06-08	99-01	99-01	99-01	02-03	03-04	02-03	02-03	00-02	00-02	11-15
150cc 4T AC	250cc 4T LC	125cc 4T LC	150cc 4T LC	250cc 4T LC	250cc 4T LC	400cc 4T LC	125cc 4T LC	150cc 4T LC	125cc 4T LC	150cc 4T LC	650cc 4T LC
Leader	Leader	Minarelli YP	Minarelli YP	Minarelli YP	Minarelli YP	Morini	Minarelli YP	Minarelli YP			
		IM07045		IM07054	IM07054						
				IM07037	IM07037						
9927650		9915380	9915380	9915800	9915800		9915380	9915380	9915220	9915220	
		9935700	9935700	9935710	9935710		9935700	9935700	9935660	9935660	9935230
		CT00730	CT00730								
F007515	F007515					F007510					
				9926850	9926850						
		9929380	9929380								
		KK01010	KK01010	KK01007	KK01007						
		AA00805	AA00805	AA00806	AA00806						AA00839
		9915270		9918020	9918020	9922390			9916710	9916710	
				MC12001	MC12001						
		MC12100	MC12100	MC12101	MC12101						
		9929170	9929170	9929870	9929870						
		MA00017	MA00017	MA00010	MA00010		MA00017	MA00017			
		RL00002	RL00002	RL00010	RL00010						
				RL00011	RL00011						
9923600	9923650	9923550	9923550	9931790	9931790						

MAXI SCOOTER



BMW	BMW	BMW	BMW
BMW C 650 GT 2016 [K19]	BMW C 650 GT [K19]	BMW C 650 SPORT 2016 [K18]	C1
16-16	11-15	16-16	00-03
650cc 4T LC	650cc 4T LC	650cc 4T LC	125cc 4T LC
			Tipo Rotax

IT	EN	FR				
ALBERO A CAMME	CAM SHAFT	ARBRE À CAMES				
ALBERO MOTORE Sel 1	Crankshaft Sel 1	VILEBREQUIN Sél 1				
ALBERO MOTORE Sel 2	Crankshaft Sel 2	VILEBREQUIN Sél 2				
BIELLA	CONROD	BIELLE				
CAMPANA FRIZIONE	CLUTCH HOUSING	CLOCHE EMBRAYAGE				
CINGHIA DI TRASMISSIONE Bando	TRANSMISSION BELT Bando	COURROIE DE TRANSMISSION Bando				9915220
CINGHIA DI TRASMISSIONE Mitsuboshi	TRANSMISSION BELT Mitsuboshi	COURROIE DE TRANSMISSION Mitsuboshi		9935230	9935230	9935660
CINGHIA DI TRASMISSIONE Altro	TRANSMISSION BELT Other	COURROIE DE TRANSMISSION Autres				
COLLETTORE ASPIRAZIONE	INLET MANIFOLD	COLLECTEUR ASPIRATION				
COLLETTORE ASPIRAZIONE SX	INLET MANIFOLD LEFT	COLLECTEUR ASPIRATION GAUCHE				
COLLETTORE ASPIRAZIONE DX	INLET MANIFOLD RIGHT	COLLECTEUR ASPIRATION DROITE				
FILTRO OLIO	OIL FILTER	FILTRE À HUILE				FO07516
FRIZIONE	CLUTCH	EMBRAYAGE				
GRUPPO TERMICO Standard	CYLINDER KIT Ø standard	CYLINDRE COMPLET Standard				
GRUPPO TERMICO Maggiorato	CYLINDER KIT BIG BORE	CYLINDRE COMPLET Majoré				
KIT CUSCINETTI PARAOLI DI BANCO Serie	BEARINGS AND OIL SEALS KIT	KIT PALIERS JOINTS D'HUILE DE VILEBREQUIN Jeu				
KIT REVISIONE POMPA ACQUA	WATER PUMP REPAIR KIT	KIT RÉVISION POMPE À EAU		AA00839	AA00839	AA00839 AA00810
KIT TAGLIANDO	SERVICE KIT	KIT COUPON				
MASSE CENTRIFUGHE PESO ORIGINALE	ROLLER WEIGHTS Standard weight	MASSELOTTE CENTRIFUGES POIDS D'ORIGINE				
MEMBRANA CARBURATORE TIPO ORIGINALE	CARBURETOR DIAPHRAGM OEM	MEMBRANE CARBURATEUR TYPE ORIGINAL				
MEMBRANA CARBURATORE ADATTABILE	CARBURETOR DIAPHRAGM Adaptable	MEMBRANE CARBURATEUR ADAPTABLE				
MOLLE CONTRASTO VARIATORE	REAR VARIATOR SPRING	RESSORTS CONTRASTE VARIATEUR				
MOLLA A GAS PER SELLA	SEAT GAS SPRING	RESSORT À GAZ POUR SELLE				
MOTORINO D'AVVIAMENTO	STARTER ENGINE	DÉMARREUR ÉLECTRIQUE				
POMPA BENZINA	FUEL PUMP	POMPE À ESSENCE				
REGOLATORE DI TENSIONE	RECTIFIER	RÉGULATEUR DE TENSION				
RUOTA LIBERA Completa	STARTER CLUTCH SET	ROUE LIBRE Complète				
RUOTA LIBERA RL + flangia	STARTER CLUTCH + FLANGE	ROUE LIBRE RL + flasque				
RUOTA LIBERA RL nuda	STARTER CLUTCH	ROUE LIBRE RL nue				RL00005
RUOTA LIBERA Ingranaggio	STARTER CLUTCH GEAR	ROUE LIBRE Engrenage				RL00013
RUOTA LIBERA Flangia	STARTER CLUTCH FLANGE	ROUE LIBRE Flasque				RL00014
SERIE DISCHI FRIZIONE	CLUTCH PLATES KIT	JEU DISQUES EMBRAYAGE				
STATORE	STATOR	STATOR				
VARIOTOP TPR	VARIOTOP TPR	VARIOTOP TPR		9934100		9934100

BMW	DERBI	DERBI	DERBI	DERBI	DERBI	DERBI	DERBI	DERBI	DERBI	DERBI	DERBI
C1	BOULEVARD	BOULEVARD	BOULEVARD	BOULEVARD	BOULEVARD 4T E3	BOULEVARD 4T EU3	BOULEVARD EU2	BOULEVARD EU2	BOULEVARD EU3	GP1	GP1 EU 2
02-03	02-02	03-04	02-02	03-04	10-10	08-12	04-07	05-06	04-07	06-07	06-06
200cc 4T LC	125cc 4T AC	125cc 4T AC	150cc 4T AC	150cc 4T AC	150cc 4T AC	125cc 4T AC	125cc 4T AC	200cc 4T AC	150cc 4T AC	250cc 4T LC	125cc 4T LC
Tipo Rotax	Leader	Piaggio	Leader	Piaggio	Piaggio	Piaggio	Piaggio	Piaggio M387M	Piaggio	Piaggio	
					IM070701	IM070701	IM070701		IM070701		IM070701
					IM070702	IM070702	IM070702		IM070702		IM070702
9915220	9927650	9927650	9927650	9927650	9927650	9927650	9927650		9927650		9927650
9935660								9935920		9935470	
	CT00740	CT00736	CT00740	CT00736	CT00736	CT00736	CT00736	CT00736	CT00736	CT00735	CT00735
F007516	F007515	F007515	F007515	F007515	F007515	F007515	F007515	F007515	F007515	F007515	F007515
											AA00826
								9932790			
				MC12002			MC12002				
					MC12107	MC12107	MC12107	MC12107			MC12106
	MA00012	MA00012	MA00012	MA00012	MA00012	MA00012	MA00012	MA00012	MA00012	MA00016	MA00012
	RE00011	RE00011	RE00011	RE00011	RE00011	RE00011	RE00011	RE00011	RE00011	RE00011	RE00011
RL00005										RL00021	
RL00013	RL00022	RL00022	RL00022	RL00022	RL00022	RL00022	RL00022	RL00022	RL00022	RL00023	RL00022
RL00014											
	9923600	9923600	9923600	9923600				9923650		9923650	9923600

MAXI SCOOTER



DERBI	DERBI	DERBI	DERBI
GP1 LOW SEAT EU3	GP1 LOW SEAT EU3	RAMBLA	RAMBLA
07-08	07-08	08-09	08-09
125cc 4T LC	250cc 4T LC	125cc 4T LC	250cc 4T LC
Piaggio	Piaggio	Piaggio M287M	Piaggio

IT	EN	FR				
ALBERO A CAMME	CAM SHAFT	ARBRE À CAMES				
ALBERO MOTORE Sel 1	Crankshaft Sel 1	VILEBREQUIN Sél 1		IM070701		IM070701
ALBERO MOTORE Sel 2	Crankshaft Sel 2	VILEBREQUIN Sél 2		IM070702		IM070702
BIELLA	CONROD	BIELLE				
CAMPANA FRIZIONE	CLUTCH HOUSING	CLOCHE EMBRAYAGE				
CINGHIA DI TRASMISSIONE Bando	TRANSMISSION BELT Bando	COURROIE DE TRANSMISSION Bando		9927650		9928540
CINGHIA DI TRASMISSIONE Mitsuboshi	TRANSMISSION BELT Mitsuboshi	COURROIE DE TRANSMISSION Mitsuboshi			9935470	
CINGHIA DI TRASMISSIONE Altro	TRANSMISSION BELT Other	COURROIE DE TRANSMISSION Autres				
COLLETTORE ASPIRAZIONE	INLET MANIFOLD	COLLECTEUR ASPIRATION				
COLLETTORE ASPIRAZIONE SX	INLET MANIFOLD LEFT	COLLECTEUR ASPIRATION GAUCHE				
COLLETTORE ASPIRAZIONE DX	INLET MANIFOLD RIGHT	COLLECTEUR ASPIRATION DROITE				
FILTRO OLIO	OIL FILTER	FILTRE À HUILE		F007515	F007515	F007515
FRIZIONE	CLUTCH	EMBRAYAGE				
GRUPPO TERMICO Standard	CYLINDER KIT Ø standard	CYLINDRE COMPLET Standard				
GRUPPO TERMICO Maggiorato	CYLINDER KIT BIG BORE	CYLINDRE COMPLET Majoré				
KIT CUSCINETTI PARAOLI DI BANCO Serie	BEARINGS AND OIL SEALS KIT	KIT PALIERS JOINTS D'HUILE DE VILEBREQUIN Jeu				
KIT REVISIONE POMPA ACQUA	WATER PUMP REPAIR KIT	KIT RÉVISION POMPE À EAU		AA00826		AA00826
KIT TAGLIANDO	SERVICE KIT	KIT COUPON				
MASSE CENTRIFUGHE PESO ORIGINALE	ROLLER WEIGHTS Standard weight	MASSELOTES CENTRIFUGES POIDS D'ORIGINE				9931880
MEMBRANA CARBURATORE TIPO ORIGINALE	CARBURETOR DIAPHRAGM OEM	MEMBRANE CARBURATEUR TYPE ORIGINAL				
MEMBRANA CARBURATORE ADATTABILE	CARBURETOR DIAPHRAGM Adaptable	MEMBRANE CARBURATEUR ADAPTABLE		MC12106		MC12106
MOLLE CONTRASTO VARIATORE	REAR VARIATOR SPRING	RESSORTS CONTRASTE VARIATEUR				
MOLLA A GAS PER SELLA	SEAT GAS SPRING	RESSORT À GAZ POUR SELLE				
MOTORINO D'AVVIAMENTO	STARTER ENGINE	DÉMARREUR ÉLECTRIQUE		MA00012	MA00016	MA00012
POMPA BENZINA	FUEL PUMP	POMPE À ESSENCE				
REGOLATORE DI TENSIONE	RECTIFIER	RÉGULATEUR DE TENSION		RE00011	RE00004	RE00011
RUOTA LIBERA Completa	STARTER CLUTCH SET	ROUE LIBRE Complète				
RUOTA LIBERA RL + flangia	STARTER CLUTCH + FLANGE	ROUE LIBRE RL + flasque			RL00041	RL00041
RUOTA LIBERA RL nuda	STARTER CLUTCH	ROUE LIBRE RL nue				
RUOTA LIBERA Ingranaggio	STARTER CLUTCH GEAR	ROUE LIBRE Engrenage		RL00022	RL00023	RL00022
RUOTA LIBERA Flangia	STARTER CLUTCH FLANGE	ROUE LIBRE Flasque				
SERIE DISCHI FRIZIONE	CLUTCH PLATES KIT	JEU DISQUES EMBRAYAGE				
STATORE	STATOR	STATOR			ST00023	ST00023
VARIOTOP TPR	VARIOTOP TPR	VARIOTOP TPR				9923600

DERBI	DERBI	DERBI	DERBI	DERBI	DERBI	GILERA	GILERA	GILERA	GILERA	GILERA	GILERA
RAMBLA	RAMBLA EU3 2VER	RAMBLA EU3 2VER	SONAR 4T	SONAR 4T	VARIANT SPORT 4T EU3	DNA	DNA	FUOCO 4T-4V IE E3 LT	FUOCO IE EU3	GP	GP
10-11	08-08	08-08	09-11	09-09	12-12	01-01	01-01	13-14	07-13	07-08	09-11
300cc 4T LC	125cc 4T LC	250cc 4T LC	125cc 4T AC	150cc 4T AC	125cc 4T AC	125cc 4T LC	180cc 4T LC	500cc 4T LC	500cc 4T LC	800cc 4T-4V LC	800cc 4T-4V LC
Piaggio	Piaggio	Piaggio	Piaggio	Piaggio	Motore Piaggio	Piaggio	Piaggio	Piaggio	Piaggio	Piaggio	Piaggio
	IM070701		IM070701	IM070701	IM070701						
	IM070702		IM070702	IM070702							
9927640	9928540	9927640	9927650	9927650	9927650	9927650					
							9935920	9935500	9935500	9935930	9935930
			CT00736	CT00736	CT00736	CT00734	CT00734				
F007515	F007515	F007515	F007515	F007515	F007515	F007515	F007515	F007524	F007524	F007524	F007524
AA00828	AA00826	AA00828				AA00817			AA00824		
TG00102			TG00100	TG00100				TG00112	TG00112		
9931880		9931880					9932790	9935990	9935990		
	MC12106		MC12107	MC12107	MC12107						
MA00016	MA00012	MA00016	MA00012	MA00012	MA00012	MA00012	MA00012	MA00030	MA00030		
RE00004	RE00011	RE00004	RE00011	RE00011	RE00011	RE00011	RE00011		RE00004		
RL00021	RL00041	RL00041							RL00021		
RL00023	RL00022	RL00023	RL00022	RL00022	RL00022	RL00022	RL00022		RL00023		
ST00023	ST00023										
		9923650				9923600		9923250	9923250		



GILERA	GILERA	GILERA	GILERA
GP CENTENARIO	NEXUS	NEXUS EU3	NEXUS EU3
09-09	03-05	07-08	06-06
800cc 4T-4V LC	500cc 4T LC	125cc 4T LC	250cc 4T LC
Piaggio	Piaggio	Piaggio	Piaggio

IT	EN	FR				
ALBERO A CAMME	CAM SHAFT	ARBRE À CAMES				
ALBERO MOTORE Sel 1	Crankshaft Sel 1	VILEBREQUIN Sél 1			IM070701	
ALBERO MOTORE Sel 2	Crankshaft Sel 2	VILEBREQUIN Sél 2			IM070702	
BIELLA	CONROD	BIELLE				
CAMPANA FRIZIONE	CLUTCH HOUSING	CLOCHE EMBRAYAGE				
CINGHIA DI TRASMISSIONE Bando	TRANSMISSION BELT Bando	COURROIE DE TRANSMISSION Bando			9927630	9927650
CINGHIA DI TRASMISSIONE Mitsuboshi	TRANSMISSION BELT Mitsuboshi	COURROIE DE TRANSMISSION Mitsuboshi			9935930	9935470
CINGHIA DI TRASMISSIONE Altro	TRANSMISSION BELT Other	COURROIE DE TRANSMISSION Autres				
COLLETTORE ASPIRAZIONE	INLET MANIFOLD	COLLECTEUR ASPIRATION				
COLLETTORE ASPIRAZIONE SX	INLET MANIFOLD LEFT	COLLECTEUR ASPIRATION GAUCHE				
COLLETTORE ASPIRAZIONE DX	INLET MANIFOLD RIGHT	COLLECTEUR ASPIRATION DROITE				
FILTRO OLIO	OIL FILTER	FILTRE À HUILE		F007524	F007524	F007515 F007515
FRIZIONE	CLUTCH	EMBRAYAGE				
GRUPPO TERMICO Standard	CYLINDER KIT Ø standard	CYLINDRE COMPLET Standard				
GRUPPO TERMICO Maggiorato	CYLINDER KIT BIG BORE	CYLINDRE COMPLET Majoré				
KIT CUSCINETTI PARAOLI DI BANCO Serie	BEARINGS AND OIL SEALS KIT	KIT PALIERS JOINTS D'HUILE DE VILEBREQUIN Jeu				
KIT REVISIONE POMPA ACQUA	WATER PUMP REPAIR KIT	KIT RÉVISION POMPE À EAU			AA00826	AA00828
KIT TAGLIANDO	SERVICE KIT	KIT COUPON				
MASSE CENTRIFUGHE PESO ORIGINALE	ROLLER WEIGHTS Standard weight	MASSELOTES CENTRIFUGES POIDS D'ORIGINE			9922330	9931880
MEMBRANA CARBURATORE TIPO ORIGINALE	CARBURETOR DIAPHRAGM OEM	MEMBRANE CARBURATEUR TYPE ORIGINAL				
MEMBRANA CARBURATORE ADATTABILE	CARBURETOR DIAPHRAGM Adaptable	MEMBRANE CARBURATEUR ADAPTABLE			MC12106	
MOLLE CONTRASTO VARIATORE	REAR VARIATOR SPRING	RESSORTS CONTRASTE VARIATEUR			9926780	
MOLLA A GAS PER SELLA	SEAT GAS SPRING	RESSORT À GAZ POUR SELLE				
MOTORINO D'AVVIAMENTO	STARTER ENGINE	DÉMARREUR ÉLECTRIQUE			MA00030	MA00012 MA00016
POMPA BENZINA	FUEL PUMP	POMPE À ESSENCE				
REGOLATORE DI TENSIONE	RECTIFIER	RÉGULATEUR DE TENSION			RE00004	RE00011 RE00004
RUOTA LIBERA Completa	STARTER CLUTCH SET	ROUE LIBRE Complète				
RUOTA LIBERA RL + flangia	STARTER CLUTCH + FLANGE	ROUE LIBRE RL + flasque			RL00021	RL00041
RUOTA LIBERA RL nuda	STARTER CLUTCH	ROUE LIBRE RL nue				
RUOTA LIBERA Ingranaggio	STARTER CLUTCH GEAR	ROUE LIBRE Engrenage			RL00023	RL00022 RL00023
RUOTA LIBERA Flangia	STARTER CLUTCH FLANGE	ROUE LIBRE Flasque				
SERIE DISCHI FRIZIONE	CLUTCH PLATES KIT	JEU DISQUES EMBRAYAGE				
STATORE	STATOR	STATOR			ST00005	ST00023
VARIOTOP TPR	VARIOTOP TPR	VARIOTOP TPR			9923250	9923600 9923650

GILERA	GILERA	GILERA	GILERA	GILERA	GILERA	GILERA	GILERA	GILERA	GILERA	GILERA	GILERA
NEXUS EU3	NEXUS EU3	NEXUS EU3	NEXUS EU3	NEXUS EU3	NEXUS IE EU3	NEXUS IE EU3	NEXUS SP EU3	NEXUS SP EU3	RUNNER	RUNNER 4T ST EU3	RUNNER FX
07-07	08-08	09-11	06-08	09-11	08-08	09-10	06-07	06-07	00-01	08-16	97-02
250cc 4T LC	300cc 4T LC	300cc 4T LC	500cc 4T LC	500cc 4T LC	125cc 4T LC	125cc 4T LC	250cc 4T LC	500cc 4T LC	180cc 4T LC	125cc 4T LC	125cc 2T LC
Piaggio	Piaggio	Piaggio	Piaggio	Piaggio	Piaggio	Piaggio	Piaggio	Piaggio	Piaggio	Piaggio	Piaggio
				9927630	9927650	9927650				9927650	9915350
9935470	9935470	9935470	9935500					9935500			9935670
										CT00735	CT00728
F007515	F007515	F007515	F007524	F007524	F007515	F007515	F007515	F007524	F007515	F007515	
AA00828	AA00828	AA00828	AA00824				AA00828		AA00817	AA00826	
	9931880	9931880	9935990	9935990			9931880	9935990			
										MC12106	
MA00016	MA00016	MA00016	MA00030	MA00030	MA00016	MA00016	MA00016	MA00030		MA00012	
RE00004	RE00004	RE00004	RE00004	RE00004	RE00004	RE00004	RE00004	RE00004		RE00011	
RL00041	RL00021	RL00021	RL00021	RL00021	RL00041	RL00041	RL00041	RL00021			
RL00023	RL00023	RL00023	RL00023	RL00023	RL00023	RL00023	RL00023	RL00023		RL00022	
ST00023	ST00023	ST00023	ST00005	ST00005	ST00023	ST00023	ST00023	ST00005			
9923650	9923650	9923650	9923250		9923600	9923600		9923250	9923600		



GILERA	GILERA	GILERA	GILERA
RUNNER FXR	RUNNER VX	RUNNER VX	RUNNER VX
97-02	00-01	02-04	05-06
180cc 2T LC	125cc 4T LC	125cc 4T LC	125cc 4T LC
Piaggio	Piaggio	Piaggio	Piaggio

IT	EN	FR				
ALBERO A CAMME	CAM SHAFT	ARBRE À CAMES				
ALBERO MOTORE Sel 1	Crankshaft Sel 1	VILEBREQUIN Sél 1			IM070701	IM070701
ALBERO MOTORE Sel 2	Crankshaft Sel 2	VILEBREQUIN Sél 2			IM070702	IM070702
BIELLA	CONROD	BIELLE				
CAMPANA FRIZIONE	CLUTCH HOUSING	CLOCHE EMBRAYAGE				
CINGHIA DI TRASMISSIONE Bando	TRANSMISSION BELT Bando	COURROIE DE TRANSMISSION Bando		9915340	9927650	9927650
CINGHIA DI TRASMISSIONE Mitsuboshi	TRANSMISSION BELT Mitsuboshi	COURROIE DE TRANSMISSION Mitsuboshi		9935780		
CINGHIA DI TRASMISSIONE Altro	TRANSMISSION BELT Other	COURROIE DE TRANSMISSION Autres				
COLLETTORE ASPIRAZIONE	INLET MANIFOLD	COLLECTEUR ASPIRATION		CT00728	CT00734	CT00734
COLLETTORE ASPIRAZIONE SX	INLET MANIFOLD LEFT	COLLECTEUR ASPIRATION GAUCHE				
COLLETTORE ASPIRAZIONE DX	INLET MANIFOLD RIGHT	COLLECTEUR ASPIRATION DROITE				
FILTRO OLIO	OIL FILTER	FILTRE À HUILE			F007515	F007515
FRIZIONE	CLUTCH	EMBRAYAGE				
GRUPPO TERMICO Standard	CYLINDER KIT Ø standard	CYLINDRE COMPLET Standard				
GRUPPO TERMICO Maggiorato	CYLINDER KIT BIG BORE	CYLINDRE COMPLET Majoré				
KIT CUSCINETTI PARAOLI DI BANCO Serie	BEARINGS AND OIL SEALS KIT	KIT PALIERS JOINTS D'HUILE DE VILEBREQUIN Jeu				
KIT REVISIONE POMPA ACQUA	WATER PUMP REPAIR KIT	KIT RÉVISION POMPE À EAU			AA00817	AA00817
KIT TAGLIANDO	SERVICE KIT	KIT COUPON				
MASSE CENTRIFUGHE PESO ORIGINALE	ROLLER WEIGHTS Standard weight	MASSELOTES CENTRIFUGES POIDS D'ORIGINE		9922670		
MEMBRANA CARBURATORE TIPO ORIGINALE	CARBURETOR DIAPHRAGM OEM	MEMBRANE CARBURATEUR TYPE ORIGINAL				
MEMBRANA CARBURATORE ADATTABILE	CARBURETOR DIAPHRAGM Adaptable	MEMBRANE CARBURATEUR ADAPTABLE				MC12106
MOLLE CONTRASTO VARIATORE	REAR VARIATOR SPRING	RESSORTS CONTRASTE VARIATEUR				
MOLLA A GAS PER SELLA	SEAT GAS SPRING	RESSORT À GAZ POUR SELLE				
MOTORINO D'AVVIAMENTO	STARTER ENGINE	DÉMARREUR ÉLECTRIQUE			MA00012	MA00012
POMPA BENZINA	FUEL PUMP	POMPE À ESSENCE				
REGOLATORE DI TENSIONE	RECTIFIER	RÉGULATEUR DE TENSION			RE00011	RE00011
RUOTA LIBERA Completa	STARTER CLUTCH SET	ROUE LIBRE Complète				
RUOTA LIBERA RL + flangia	STARTER CLUTCH + FLANGE	ROUE LIBRE RL + flasque				
RUOTA LIBERA RL nuda	STARTER CLUTCH	ROUE LIBRE RL nue				
RUOTA LIBERA Ingranaggio	STARTER CLUTCH GEAR	ROUE LIBRE Engrenage			RL00022	RL00022
RUOTA LIBERA Flangia	STARTER CLUTCH FLANGE	ROUE LIBRE Flasque				
SERIE DISCHI FRIZIONE	CLUTCH PLATES KIT	JEU DISQUES EMBRAYAGE				
STATORE	STATOR	STATOR				
VARIOTOP TPR	VARIOTOP TPR	VARIOTOP TPR			9923600	9923600

GILERA	GILERA	GILERA	GILERA	GILERA	GILERA	GILERA	GILERA	GILERA	GILERA	GILERA	HONDA
RUNNER VX 4T EU3	RUNNER VX RACE	RUNNER VX SC	RUNNER VXR	RUNNER VXR	RUNNER VXR	RUNNER VXR 4T ST EU3	RUNNER VXR EU3	RUNNER VXR RACE 200	TYPHOON	TYPHOON X-XR	@ [NES]
06-07	06-06	06-07	00-01	02-04	05-06	08-11	07-07	06-06	95-98	99-00	00-06
125cc 4T LC	125cc 4T LC	125cc 4T LC	180cc 4T LC	200cc 4T LC	200cc 4T LC	200cc 4T LC	200cc 4T LC	125cc 4T LC	125cc 2T AC	125cc 2T AC	125cc 4T LC
Piaggio	Piaggio	Piaggio	Piaggio	Piaggio	Piaggio	Piaggio	Piaggio	Piaggio	Piaggio	Piaggio	Honda
IM070701	IM070701	IM070701									IM07055
IM070702	IM070702	IM070702									
9927650	9927650	9927650							9915350	9915350	
			9935920	9935920	9935920	9935920	9935920		9935670	9935670	9935770
											9923140
	CT00735	CT00735	CT00734	CT00734	CT00735		CT00735	CT00735	CT00728	CT00728	
F007515	F007515	F007515	F007515	F007515	F007515	F007515	F007515	F007515			
											9929650
											9929450
AA00826	AA00826	AA00826	AA00817	AA00826	AA00826	AA00826	AA00826				AA00813
			9932790	9932790	9932790	9932790	9932790				9916670
											MC12004
MC12106	MC12106	MC12106				MC12106	MC12106	MC12106			MC12104
											9926770
MA00012	MA00012	MA00012	MA00012	MA00012	MA00012	MA00012	MA00012	MA00012			MA00006
RE00011	RE00011	RE00011		RE00011	RE00011	RE00011	RE00011	RE00011			
											RL00003
											RL00028
											RL00005
RL00022	RL00022	RL00022	RL00022	RL00022	RL00022	RL00022	RL00022	RL00022			
			9923600	9923650	9923650						9923410

MAXI SCOOTER



HONDA	HONDA	HONDA	HONDA
@ [NES]	BALI	BALI	CN SPAZIO/ HELIX
00-06	96-01	96-01	86-99
150cc 4T LC	125cc 4T AC	150cc 4T AC	250cc 4T LC
Honda	Honda	Honda	Honda

IT	EN	FR				
ALBERO A CAMME	CAM SHAFT	ARBRE À CAMES				
ALBERO MOTORE Sel 1	Crankshaft Sel 1	VILEBREQUIN Sél 1		IM07056		
ALBERO MOTORE Sel 2	Crankshaft Sel 2	VILEBREQUIN Sél 2				
BIELLA	CONROD	BIELLE				
CAMPANA FRIZIONE	CLUTCH HOUSING	CLOCHE EMBRAYAGE				
CINGHIA DI TRASMISSIONE Bando	TRANSMISSION BELT Bando	COURROIE DE TRANSMISSION Bando				9915410
CINGHIA DI TRASMISSIONE Mitsuboshi	TRANSMISSION BELT Mitsuboshi	COURROIE DE TRANSMISSION Mitsuboshi		9935770	9935770	9935770
CINGHIA DI TRASMISSIONE Altro	TRANSMISSION BELT Other	COURROIE DE TRANSMISSION Autres		9923140	9923140	9923140
COLLETTORE ASPIRAZIONE	INLET MANIFOLD	COLLECTEUR ASPIRATION				
COLLETTORE ASPIRAZIONE SX	INLET MANIFOLD LEFT	COLLECTEUR ASPIRATION GAUCHE				
COLLETTORE ASPIRAZIONE DX	INLET MANIFOLD RIGHT	COLLECTEUR ASPIRATION DROITE				
FILTRO OLIO	OIL FILTER	FILTRE À HUILE				
FRIZIONE	CLUTCH	EMBAYAGE				
GRUPPO TERMICO Standard	CYLINDER KIT Ø standard	CYLINDRE COMPLET Standard		9929950		
GRUPPO TERMICO Maggiorato	CYLINDER KIT BIG BORE	CYLINDRE COMPLET Majoré				
KIT CUSCINETTI PARAOLI DI BANCO Serie	BEARINGS AND OIL SEALS KIT	KIT PALIERS JOINTS D'HUILE DE VILEBREQUIN Jeu				
KIT REVISIONE POMPA ACQUA	WATER PUMP REPAIR KIT	KIT RÉVISION POMPE À EAU		AA00813		
KIT TAGLIANDO	SERVICE KIT	KIT COUPON				
MASSE CENTRIFUGHE PESO ORIGINALE	ROLLER WEIGHTS Standard weight	MASSELOTES CENTRIFUGES POIDS D'ORIGINE		9924320		
MEMBRANA CARBURATORE TIPO ORIGINALE	CARBURETOR DIAPHRAGM OEM	MEMBRANE CARBURATEUR TYPE ORIGINAL		MC12004		
MEMBRANA CARBURATORE ADATTABILE	CARBURETOR DIAPHRAGM Adaptable	MEMBRANE CARBURATEUR ADAPTABLE		MC12104		
MOLLE CONTRASTO VARIATORE	REAR VARIATOR SPRING	RESSORTS CONTRASTE VARIATEUR		9926770		
MOLLA A GAS PER SELLA	SEAT GAS SPRING	RESSORT À GAZ POUR SELLE				
MOTORINO D'AVVIAMENTO	STARTER ENGINE	DÉMARREUR ÉLECTRIQUE		MA00006		
POMPA BENZINA	FUEL PUMP	POMPE À ESSENCE				
REGOLATORE DI TENSIONE	RECTIFIER	RÉGULATEUR DE TENSION				
RUOTA LIBERA Completa	STARTER CLUTCH SET	ROUE LIBRE Complète				
RUOTA LIBERA RL + flangia	STARTER CLUTCH + FLANGE	ROUE LIBRE RL + flasque		RL00003 RL00028		RL00004
RUOTA LIBERA RL nuda	STARTER CLUTCH	ROUE LIBRE RL nue		RL00005		
RUOTA LIBERA Ingranaggio	STARTER CLUTCH GEAR	ROUE LIBRE Engrenage				
RUOTA LIBERA Flangia	STARTER CLUTCH FLANGE	ROUE LIBRE Flasque				
SERIE DISCHI FRIZIONE	CLUTCH PLATES KIT	JEU DISQUES EMBRAYAGE				
STATORE	STATOR	STATOR				
VARIOTOP TPR	VARIOTOP TPR	VARIOTOP TPR		9923410	9923410	9923410

HONDA	HONDA	HONDA	HONDA	HONDA	HONDA	HONDA	HONDA	HONDA	HONDA	HONDA	HONDA
DYLAN [SES]	DYLAN [SES]	FORESIGHT [FES]	FORESIGHT [FES] D.D.	FORZA	FORZA	FORZA EX [NSS]	FORZA X [NSS]	FORZA [NSS A]	FORZA [NSS S]	FORZA [NSS]	JAZZ ES REFLEX [NSS]
02-04	02-04	98-99	00-05	13-17	13-17	05-07	05-07	08-11	08-11	02-07	01-04
125cc 4T LC	150cc 4T LC	250cc 4T LC	250cc 4T LC	125cc 4T-2V LC	300cc 4T 4V LC	250cc 4T-2V LC	250cc 4T-2V LC	250cc 4T-4V LC	250cc 4T-4V LC	250cc 4T-2V LC	250cc 4T-2V LC
Honda	Honda	Honda	Honda	Honda		Honda	Honda	Honda	Honda	Honda	Honda
IM07055	IM07056										
		9917990	9917990		9927480					9917990	9917990
9935770	9935770	9935720	9935720							9935720	9935720
9923140	9923140										
								F007513	F007513		
9929650	9929950			9936650 9937450							
9929450											
AA00813	AA00813	AA00814	AA00814								
9916670	9924320	9915990									
MC12004	MC12004										
MC12104	MC12104										
9926770	9926770		9926800				9926800			9926800	9926800
MA00006	MA00006										
RL00003 RL00028	RL00003 RL00028	RL00004	RL00004			RL00030	RL00030	RL00030	RL00030	RL00004	RL00004
RL00005	RL00005										
								RL00029	RL00029		
9923410	9923410										

MAXI SCOOTER

MAXI SCOOTER



HONDA	HONDA	HONDA	HONDA
JAZZ REFLEX[INSS]	PANTHEON IE [FES]	PANTHEON IE [FES]	PANTHEON [FES]
01-01	03-05	03-05	98-02
250cc 4T-2V LC	125cc 4T-2V LC	150cc 4T-2V LC	125cc 2T LC
Honda	Honda	Honda	Honda

IT	EN	FR					
ALBERO A CAMME	CAM SHAFT	ARBRE À CAMES					
ALBERO MOTORE Sel 1	Crankshaft Sel 1	VILEBREQUIN Sél 1			IM07055	IM07056	
ALBERO MOTORE Sel 2	Crankshaft Sel 2	VILEBREQUIN Sél 2					
BIELLA	CONROD	BIELLE					
CAMPANA FRIZIONE	CLUTCH HOUSING	CLOCHE EMBRAYAGE					
CINGHIA DI TRASMISSIONE Bando	TRANSMISSION BELT Bando	COURROIE DE TRANSMISSION Bando		9917990		9918000	
CINGHIA DI TRASMISSIONE Mitsuboshi	TRANSMISSION BELT Mitsuboshi	COURROIE DE TRANSMISSION Mitsuboshi		9935720	9935770	9935770	
CINGHIA DI TRASMISSIONE Altro	TRANSMISSION BELT Other	COURROIE DE TRANSMISSION Autres			9923140	9923140	
COLLETTORE ASPIRAZIONE	INLET MANIFOLD	COLLECTEUR ASPIRATION					
COLLETTORE ASPIRAZIONE SX	INLET MANIFOLD LEFT	COLLECTEUR ASPIRATION GAUCHE					
COLLETTORE ASPIRAZIONE DX	INLET MANIFOLD RIGHT	COLLECTEUR ASPIRATION DROITE					
FILTRO OLIO	OIL FILTER	FILTRE À HUILE					
FRIZIONE	CLUTCH	EMBAYAGE					
GRUPPO TERMICO Standard	CYLINDER KIT Ø standard	CYLINDRE COMPLET Standard			9929650	9929950	
GRUPPO TERMICO Maggiorato	CYLINDER KIT BIG BORE	CYLINDRE COMPLET Majoré			9929450		
KIT CUSCINETTI PARAOLI DI BANCO Serie	BEARINGS AND OIL SEALS KIT	KIT PALIERS JOINTS D'HUILE DE VILEBREQUIN Jeu					
KIT REVISIONE POMPA ACQUA	WATER PUMP REPAIR KIT	KIT RÉVISION POMPE À EAU			AA00813	AA00813	AA00812
KIT TAGLIANDO	SERVICE KIT	KIT COUPON					
MASSE CENTRIFUGHE PESO ORIGINALE	ROLLER WEIGHTS Standard weight	MASSELOTTE CENTRIFUGES POIDS D'ORIGINE			9916670		
MEMBRANA CARBURATORE TIPO ORIGINALE	CARBURETOR DIAPHRAGM OEM	MEMBRANE CARBURATEUR TYPE ORIGINAL					
MEMBRANA CARBURATORE ADATTABILE	CARBURETOR DIAPHRAGM Adaptable	MEMBRANE CARBURATEUR ADAPTABLE					
MOLLE CONTRASTO VARIATORE	REAR VARIATOR SPRING	RESSORTS CONTRASTE VARIATEUR		9926800	9926770	9926770	
MOLLA A GAS PER SELLA	SEAT GAS SPRING	RESSORT À GAZ POUR SELLE					
MOTORINO D'AVVIAMENTO	STARTER ENGINE	DÉMARREUR ÉLECTRIQUE			MA00006	MA00006	
POMPA BENZINA	FUEL PUMP	POMPE À ESSENCE					
REGOLATORE DI TENSIONE	RECTIFIER	RÉGULATEUR DE TENSION					
RUOTA LIBERA Completa	STARTER CLUTCH SET	ROUE LIBRE Complète					
RUOTA LIBERA RL + flangia	STARTER CLUTCH + FLANGE	ROUE LIBRE RL + flasque		RL00004	RL00003 RL00028	RL00003 RL00028	
RUOTA LIBERA RL nuda	STARTER CLUTCH	ROUE LIBRE RL nue			RL00005	RL00005	
RUOTA LIBERA Ingranaggio	STARTER CLUTCH GEAR	ROUE LIBRE Engrenage					
RUOTA LIBERA Flangia	STARTER CLUTCH FLANGE	ROUE LIBRE Flasque					
SERIE DISCHI FRIZIONE	CLUTCH PLATES KIT	JEU DISQUES EMBRAYAGE					
STATORE	STATOR	STATOR					
VARIOTOP TPR	VARIOTOP TPR	VARIOTOP TPR			9923410	9923410	

HONDA	HONDA	HONDA	HONDA	HONDA	HONDA	HONDA	HONDA	HONDA	HONDA	HONDA	HONDA
PANTHEON [FES]	PCX	PCX	PCX	PCX	PCX	PCX	PS I [PES]	PS I [PES]	SH	SH	SH I ABS
98-02	10-11	12-12	13-13	14-14	15-18	13-17	06-10	06-10	01-04	01-04	13-17
150cc 2T LC	125cc 4T-2V LC	125cc 4T-2V LC	125cc 4T-2V LC	125cc 4T-2V LC	125cc 4T-2V LC	150cc 4T-2V LC	125cc 4T LC	150cc 4T LC	125cc 4T-2V LC	150cc 4T-2V LC	125cc 4T-2V LC
Honda	Honda	Honda	Honda	Honda	Honda	Honda	Honda	Honda	Honda	Honda	Honda
							IM07055	IM07056	IM07055	IM07056	
9918000											
							9935770	9935770	9935770	9935770	9935870
							9923140	9923140	9923140	9923140	
			9936650 9937450	9936650	9936650	9936950	9929650	9929950	9929650	9929950	9936650 9937450
							9929450		9929450		
AA00812	AA00834	AA00834	AA00834			AA00834	AA00813	AA00813	AA00813	AA00813	AA00834
									TG00105	TG00105	
							9916670	9924320	9916670	9924320	9916710
									MC12004	MC12004	
									MC12104	MC12104	
							9926770	9926770	9926770	9926770	
							MA00006	MA00006	MA00006	MA00006	
											PB00907
							RL00003 RL00028	RL00003 RL00028	RL00003 RL00028	RL00003 RL00028	
							RL00005	RL00005	RL00005	RL00005	
							9923410	9923410	9923410	9923410	

MAXI SCOOTER



HONDA	HONDA	HONDA	HONDA
SH I ABS	SH IE SCOOPY	SH IE SCOOPY	SH IE SCOOPY
13-17	05-12	05-12	07-10
150cc 4T-2V LC	125cc 4T-2V LC	150cc 4T LC	300cc 4T-4V LC
Honda	Honda	Honda	(NF02E)

IT	EN	FR				
ALBERO A CAMME	CAM SHAFT	ARBRE À CAMES				
ALBERO MOTORE Sel 1	Crankshaft Sel 1	VILEBREQUIN Sél 1				
ALBERO MOTORE Sel 2	Crankshaft Sel 2	VILEBREQUIN Sél 2				
BIELLA	CONROD	BIELLE				
CAMPANA FRIZIONE	CLUTCH HOUSING	CLOCHE EMBRAYAGE				
CINGHIA DI TRASMISSIONE Bando	TRANSMISSION BELT Bando	COURROIE DE TRANSMISSION Bando				
CINGHIA DI TRASMISSIONE Mitsuboshi	TRANSMISSION BELT Mitsuboshi	COURROIE DE TRANSMISSION Mitsuboshi	9935870	9935770	9935770	9927480
CINGHIA DI TRASMISSIONE Altro	TRANSMISSION BELT Other	COURROIE DE TRANSMISSION Autres	9923140	9923140		
COLLETTORE ASPIRAZIONE	INLET MANIFOLD	COLLECTEUR ASPIRATION				
COLLETTORE ASPIRAZIONE SX	INLET MANIFOLD LEFT	COLLECTEUR ASPIRATION GAUCHE				
COLLETTORE ASPIRAZIONE DX	INLET MANIFOLD RIGHT	COLLECTEUR ASPIRATION DROITE				
FILTRO OLIO	OIL FILTER	FILTRE À HUILE				
FRIZIONE	CLUTCH	EMBRAYAGE				
GRUPPO TERMICO Standard	CYLINDER KIT Ø standard	CYLINDRE COMPLET Standard	9936950	9929650	9929950	
GRUPPO TERMICO Maggiorato	CYLINDER KIT BIG BORE	CYLINDRE COMPLET Majoré		9929450		
KIT CUSCINETTI PARAOLI DI BANCO Serie	BEARINGS AND OIL SEALS KIT	KIT PALIERS JOINTS D'HUILE DE VILEBREQUIN Jeu				
KIT REVISIONE POMPA ACQUA	WATER PUMP REPAIR KIT	KIT RÉVISION POMPE À EAU	AA00834	AA00813	AA00813	AA00822
KIT TAGLIANDO	SERVICE KIT	KIT COUPON		TG00105	TG00105	TG00106
MASSE CENTRIFUGHE PESO ORIGINALE	ROLLER WEIGHTS Standard weight	MASSELOTES CENTRIFUGES POIDS D'ORIGINE				
MEMBRANA CARBURATORE TIPO ORIGINALE	CARBURETOR DIAPHRAGM OEM	MEMBRANE CARBURATEUR TYPE ORIGINAL				
MEMBRANA CARBURATORE ADATTABILE	CARBURETOR DIAPHRAGM Adaptable	MEMBRANE CARBURATEUR ADAPTABLE				
MOLLE CONTRASTO VARIATORE	REAR VARIATOR SPRING	RESSORTS CONTRASTE VARIATEUR	9926770	9926770	9929890	
MOLLA A GAS PER SELLA	SEAT GAS SPRING	RESSORT À GAZ POUR SELLE				
MOTORINO D'AVVIAMENTO	STARTER ENGINE	DÉMARREUR ÉLECTRIQUE		MA00006	MA00006	MA00032
POMPA BENZINA	FUEL PUMP	POMPE À ESSENCE	PB00907			
REGOLATORE DI TENSIONE	RECTIFIER	RÉGULATEUR DE TENSION		RE00021	RE00021	RE00031
RUOTA LIBERA Completa	STARTER CLUTCH SET	ROUE LIBRE Complète				
RUOTA LIBERA RL + flangia	STARTER CLUTCH + FLANGE	ROUE LIBRE RL + flasque		RL00003 RL00028	RL00003 RL00028	RL00030
RUOTA LIBERA RL nuda	STARTER CLUTCH	ROUE LIBRE RL nue		RL00005	RL00005	
RUOTA LIBERA Ingranaggio	STARTER CLUTCH GEAR	ROUE LIBRE Engrenage				
RUOTA LIBERA Flangia	STARTER CLUTCH FLANGE	ROUE LIBRE Flasque				
SERIE DISCHI FRIZIONE	CLUTCH PLATES KIT	JEU DISQUES EMBRAYAGE				
STATORE	STATOR	STATOR		ST00026	ST00026	ST00024
VARIOTOP TPR	VARIOTOP TPR	VARIOTOP TPR		9923410	9923410	9926040

HONDA	HONDA	HONDA	HONDA	HONDA	HONDA	HONDA	ITALJET	ITALJET	ITALJET	ITALJET	ITALJET
SH IE SCOOPY	SILVER WING [FES]	SILVER WING [FES]	SILVER WING [FJS]	SILVER WING [FJS]	SW-T [FJS]	SW-T [FJS]	DRAGSTER	JET SET	JET SET	JUPITER	JUPITER
11-19	07-12	07-12	06-08	01-10	09-13	11-13	99-01	01-01	01-01	01-02	01-02
300cc 4T-4V LC	125cc 4T-2V LC	150cc 4T-2V LC	400cc 4T LC	600cc 4T LC	400cc 4T LC	600cc 4T LC	180cc 2T LC	125cc 4T AC	150cc 4T AC	125cc 4T LC	150cc 4T LC
	Honda	(KF06E)	Honda	Honda	Honda	Honda		Leader	Leader	Minarelli YP	Minarelli YP
	IM07055	IM07056								IM07045	
9927480			9927490		9927490					9915380	9915380
	9935770	9935770		9935250		9935250				9935700	9935700
	9923140	9923140									
										CT00730	CT00730
F007513			F007513	F007513	F007513	F007513		F007515	F007515		
	9929650	9929950									
	9929450									9929380	9929380
										KK01010	KK01010
AA00822	AA00813	AA00813	AA00836	AA00836	AA00836	AA00836				AA00805	AA00805
TG00106											
9931890	9924320	9924320	9931840	9931860	9931840	9931860	9922670			9915270	
										MC12100	MC12100
9929890	9926770	9926770								9929170	9929170
			9980220	9980220	9980220	9980220					
MA00032	MA00006	MA00006								MA00017	MA00017
RE00029											
RL00030	RL00003 RL00028	RL00003 RL00028								RL00002	RL00002
	RL00005	RL00005									
RL00029											
9926040	9923410	9923410						9923600	9923600	9923550	9923550



ITALJET	ITALJET	ITALJET	ITALJET
JUPITER	JUPITER	MILLENNIUM	MILLENNIUM
00-00	01-02	00-02	00-02
250cc 4T LC	250cc 4T LC	125cc 4T LC	150cc 4T LC
Minarelli YP	Minarelli YP	Minarelli YP	Minarelli YP

IT	EN	FR				
ALBERO A CAMME	CAM SHAFT	ARBRE À CAMES				
ALBERO MOTORE Sel 1	Crankshaft Sel 1	VILEBREQUIN Sél 1		IM07054	IM07054	IM07045
ALBERO MOTORE Sel 2	Crankshaft Sel 2	VILEBREQUIN Sél 2				
BIELLA	CONROD	BIELLE		IM07037	IM07037	
CAMPANA FRIZIONE	CLUTCH HOUSING	CLOCHE EMBRAYAGE				
CINGHIA DI TRASMISSIONE Bando	TRANSMISSION BELT Bando	COURROIE DE TRANSMISSION Bando		9915800	9915800	9915380
CINGHIA DI TRASMISSIONE Mitsuboshi	TRANSMISSION BELT Mitsuboshi	COURROIE DE TRANSMISSION Mitsuboshi		9935710	9935710	9935700
CINGHIA DI TRASMISSIONE Altro	TRANSMISSION BELT Other	COURROIE DE TRANSMISSION Autres				
COLLETTORE ASPIRAZIONE	INLET MANIFOLD	COLLECTEUR ASPIRATION				CT00730
COLLETTORE ASPIRAZIONE SX	INLET MANIFOLD LEFT	COLLECTEUR ASPIRATION GAUCHE				
COLLETTORE ASPIRAZIONE DX	INLET MANIFOLD RIGHT	COLLECTEUR ASPIRATION DROITE				
FILTRO OLIO	OIL FILTER	FILTRE À HUILE				
FRIZIONE	CLUTCH	EMBRAYAGE				
GRUPPO TERMICO Standard	CYLINDER KIT Ø standard	CYLINDRE COMPLET Standard		9926850	9926850	
GRUPPO TERMICO Maggiorato	CYLINDER KIT BIG BORE	CYLINDRE COMPLET Majoré				9929380
KIT CUSCINETTI PARAOLI DI BANCO Serie	BEARINGS AND OIL SEALS KIT	KIT PALIERS JOINTS D'HUILE DE VILEBREQUIN Jeu		KK01007	KK01007	KK01010
KIT REVISIONE POMPA ACQUA	WATER PUMP REPAIR KIT	KIT RÉVISION POMPE À EAU		AA00806	AA00806	AA00805
KIT TAGLIANDO	SERVICE KIT	KIT COUPON				
MASSE CENTRIFUGHE PESO ORIGINALE	ROLLER WEIGHTS Standard weight	MASSELOTTE CENTRIFUGES POIDS D'ORIGINE			9918020	9915270
MEMBRANA CARBURATORE TIPO ORIGINALE	CARBURETOR DIAPHRAGM OEM	MEMBRANE CARBURATEUR TYPE ORIGINAL		MC12001	MC12001	
MEMBRANA CARBURATORE ADATTABILE	CARBURETOR DIAPHRAGM Adaptable	MEMBRANE CARBURATEUR ADAPTABLE		MC12101	MC12101	MC12100
MOLLE CONTRASTO VARIATORE	REAR VARIATOR SPRING	RESSORTS CONTRASTE VARIATEUR		9929870	9929870	9929170
MOLLA A GAS PER SELLA	SEAT GAS SPRING	RESSORT À GAZ POUR SELLE				
MOTORINO D'AVVIAMENTO	STARTER ENGINE	DÉMARREUR ÉLECTRIQUE		MA00010	MA00010	MA00017
POMPA BENZINA	FUEL PUMP	POMPE À ESSENCE				
REGOLATORE DI TENSIONE	RECTIFIER	RÉGULATEUR DE TENSION				
RUOTA LIBERA Completa	STARTER CLUTCH SET	ROUE LIBRE Complète				
RUOTA LIBERA RL + flangia	STARTER CLUTCH + FLANGE	ROUE LIBRE RL + flasque		RL00010	RL00010	RL00002
RUOTA LIBERA RL nuda	STARTER CLUTCH	ROUE LIBRE RL nue				
RUOTA LIBERA Ingranaggio	STARTER CLUTCH GEAR	ROUE LIBRE Engrenage		RL00011	RL00011	
RUOTA LIBERA Flangia	STARTER CLUTCH FLANGE	ROUE LIBRE Flasque				
SERIE DISCHI FRIZIONE	CLUTCH PLATES KIT	JEU DISQUES EMBRAYAGE				
STATORE	STATOR	STATOR				
VARIOTOP TPR	VARIOTOP TPR	VARIOTOP TPR		9931790	9931790	9923550

ITALJET	ITALJET	KEEWAY	KEEWAY	KEEWAY	KEEWAY	KEEWAY	KEEWAY	KEEWAY	KEEWAY	KEEWAY	KEEWAY
TORPEDO	TORPEDO	ARN	ARN	ARN	ARN	F-ACT	F-ACT	FOCUS	FOCUS	MATRIX	MATRIX
99-02	99-02	06-06	07-08	06-06	07-08	07-08	07-08	06-06	06-06	06-06	07-08
125cc 4T AC	150cc 4T AC	125cc 4T AC	125cc 4T AC	150cc 4T AC	150cc 4T AC	125cc 4T AC	150cc 4T AC	125cc 4T AC	150cc 4T AC	125cc 4T AC	125cc 4T AC
Leader	Leader										
		9935260	9935260	9935260	9935260	9935260	9935260	9935260	9935260	9935260	9935260
F007515	F007515										
9923600	9923600										

MAXI SCOOTER



KEEWAY	KEEWAY	KEEWAY	KEEWAY
MATRIX	MATRIX	OUTLOOK	OUTLOOK
06-06	07-08	07-08	07-08
150cc 4T AC	150cc 4T AC	125cc 4T LC	150cc 4T LC
		(QJ153MJ-2)	(QJ158MJ)

IT	EN	FR				
ALBERO A CAMME	CAM SHAFT	ARBRE À CAMES				
ALBERO MOTORE Sel 1	Crankshaft Sel 1	VILEBREQUIN Sél 1				
ALBERO MOTORE Sel 2	Crankshaft Sel 2	VILEBREQUIN Sél 2				
BIELLA	CONROD	BIELLE				
CAMPANA FRIZIONE	CLUTCH HOUSING	CLOCHE EMBRAYAGE				
CINGHIA DI TRASMISSIONE Bando	TRANSMISSION BELT Bando	COURROIE DE TRANSMISSION Bando				
CINGHIA DI TRASMISSIONE Mitsuboshi	TRANSMISSION BELT Mitsuboshi	COURROIE DE TRANSMISSION Mitsuboshi		9935260	9935260	9935770
CINGHIA DI TRASMISSIONE Altro	TRANSMISSION BELT Other	COURROIE DE TRANSMISSION Autres				9923140
COLLETTORE ASPIRAZIONE	INLET MANIFOLD	COLLECTEUR ASPIRATION				
COLLETTORE ASPIRAZIONE SX	INLET MANIFOLD LEFT	COLLECTEUR ASPIRATION GAUCHE				
COLLETTORE ASPIRAZIONE DX	INLET MANIFOLD RIGHT	COLLECTEUR ASPIRATION DROITE				
FILTRO OLIO	OIL FILTER	FILTRE À HUILE				
FRIZIONE	CLUTCH	EMBRAYAGE				
GRUPPO TERMICO Standard	CYLINDER KIT Ø standard	CYLINDRE COMPLET Standard				9929650
GRUPPO TERMICO Maggiorato	CYLINDER KIT BIG BORE	CYLINDRE COMPLET Majoré				9929450
KIT CUSCINETTI PARAOLI DI BANCO Serie	BEARINGS AND OIL SEALS KIT	KIT PALIERS JOINTS D'HUILE DE VILEBREQUIN Jeu				
KIT REVISIONE POMPA ACQUA	WATER PUMP REPAIR KIT	KIT RÉVISION POMPE À EAU				
KIT TAGLIANDO	SERVICE KIT	KIT COUPON				
MASSE CENTRIFUGHE PESO ORIGINALE	ROLLER WEIGHTS Standard weight	MASSELOTTE CENTRIFUGES POIDS D'ORIGINE				
MEMBRANA CARBURATORE TIPO ORIGINALE	CARBURETOR DIAPHRAGM OEM	MEMBRANE CARBURATEUR TYPE ORIGINAL				
MEMBRANA CARBURATORE ADATTABILE	CARBURETOR DIAPHRAGM Adaptable	MEMBRANE CARBURATEUR ADAPTABLE				
MOLLE CONTRASTO VARIATORE	REAR VARIATOR SPRING	RESSORTS CONTRASTE VARIATEUR				9926770
MOLLA A GAS PER SELLA	SEAT GAS SPRING	RESSORT À GAZ POUR SELLE				
MOTORINO D'AVVIAMENTO	STARTER ENGINE	DÉMARREUR ÉLECTRIQUE				
POMPA BENZINA	FUEL PUMP	POMPE À ESSENCE				
REGOLATORE DI TENSIONE	RECTIFIER	RÉGULATEUR DE TENSION				
RUOTA LIBERA Completa	STARTER CLUTCH SET	ROUE LIBRE Complète				
RUOTA LIBERA RL + flangia	STARTER CLUTCH + FLANGE	ROUE LIBRE RL + flasque				
RUOTA LIBERA RL nuda	STARTER CLUTCH	ROUE LIBRE RL nue				
RUOTA LIBERA Ingranaggio	STARTER CLUTCH GEAR	ROUE LIBRE Engrenage				
RUOTA LIBERA Flangia	STARTER CLUTCH FLANGE	ROUE LIBRE Flasque				
SERIE DISCHI FRIZIONE	CLUTCH PLATES KIT	JEU DISQUES EMBRAYAGE				
STATORE	STATOR	STATOR				
VARIOTOP TPR	VARIOTOP TPR	VARIOTOP TPR				9923410



KYMCO	KYMCO	KYMCO	KYMCO
AGILITY R16	AGILITY R16	AGILITY R16	AGILITY R16
12-12	12-12	08-08	09-09
125cc 4T AC	125cc 4T AC	150cc 4T AC	150cc 4T AC

IT	EN	FR				
ALBERO A CAMME	CAM SHAFT	ARBRE À CAMES				
ALBERO MOTORE Sel 1	Crankshaft Sel 1	VILEBREQUIN Sél 1			IM07071	IM07071
ALBERO MOTORE Sel 2	Crankshaft Sel 2	VILEBREQUIN Sél 2				
BIELLA	CONROD	BIELLE				
CAMPANA FRIZIONE	CLUTCH HOUSING	CLOCHE EMBRAYAGE				
CINGHIA DI TRASMISSIONE Bando	TRANSMISSION BELT Bando	COURROIE DE TRANSMISSION Bando			9926430	9926430
CINGHIA DI TRASMISSIONE Mitsuboshi	TRANSMISSION BELT Mitsuboshi	COURROIE DE TRANSMISSION Mitsuboshi			9935740	9935740
CINGHIA DI TRASMISSIONE Altro	TRANSMISSION BELT Other	COURROIE DE TRANSMISSION Autres				
COLLETTORE ASPIRAZIONE	INLET MANIFOLD	COLLECTEUR ASPIRATION			CT00742	CT00742
COLLETTORE ASPIRAZIONE SX	INLET MANIFOLD LEFT	COLLECTEUR ASPIRATION GAUCHE				
COLLETTORE ASPIRAZIONE DX	INLET MANIFOLD RIGHT	COLLECTEUR ASPIRATION DROITE				
FILTRO OLIO	OIL FILTER	FILTRE À HUILE				
FRIZIONE	CLUTCH	EMBRAYAGE				
GRUPPO TERMICO Standard	CYLINDER KIT Ø standard	CYLINDRE COMPLET Standard				
GRUPPO TERMICO Maggiorato	CYLINDER KIT BIG BORE	CYLINDRE COMPLET Majoré				
KIT CUSCINETTI PARAOLI DI BANCO Serie	BEARINGS AND OIL SEALS KIT	KIT PALIERS JOINTS D'HUILE DE VILEBREQUIN Jeu				
KIT REVISIONE POMPA ACQUA	WATER PUMP REPAIR KIT	KIT RÉVISION POMPE À EAU				
KIT TAGLIANDO	SERVICE KIT	KIT COUPON			TG00103	TG00103
MASSE CENTRIFUGHE PESO ORIGINALE	ROLLER WEIGHTS Standard weight	MASSELOTES CENTRIFUGES POIDS D'ORIGINE			9917640	9917640
MEMBRANA CARBURATORE TIPO ORIGINALE	CARBURETOR DIAPHRAGM OEM	MEMBRANE CARBURATEUR TYPE ORIGINAL				
MEMBRANA CARBURATORE ADATTABILE	CARBURETOR DIAPHRAGM Adaptable	MEMBRANE CARBURATEUR ADAPTABLE			MC12103	MC12103
MOLLE CONTRASTO VARIATORE	REAR VARIATOR SPRING	RESSORTS CONTRASTE VARIATEUR				
MOLLA A GAS PER SELLA	SEAT GAS SPRING	RESSORT À GAZ POUR SELLE				
MOTORINO D'AVVIAMENTO	STARTER ENGINE	DÉMARREUR ÉLECTRIQUE			MA00007	MA00007
POMPA BENZINA	FUEL PUMP	POMPE À ESSENCE				
REGOLATORE DI TENSIONE	RECTIFIER	RÉGULATEUR DE TENSION			RE00019	RE00019
RUOTA LIBERA Completa	STARTER CLUTCH SET	ROUE LIBRE Complète				
RUOTA LIBERA RL + flangia	STARTER CLUTCH + FLANGE	ROUE LIBRE RL + flasque				
RUOTA LIBERA RL nuda	STARTER CLUTCH	ROUE LIBRE RL nue				
RUOTA LIBERA Ingranaggio	STARTER CLUTCH GEAR	ROUE LIBRE Engrenage				
RUOTA LIBERA Flangia	STARTER CLUTCH FLANGE	ROUE LIBRE Flasque				
SERIE DISCHI FRIZIONE	CLUTCH PLATES KIT	JEU DISQUES EMBRAYAGE				
STATORE	STATOR	STATOR			ST00025	ST00025
VARIOTOP TPR	VARIOTOP TPR	VARIOTOP TPR			9927830	9927830

KYMCO	KYMCO	KYMCO	KYMCO	KYMCO	KYMCO	KYMCO	KYMCO	KYMCO	KYMCO	KYMCO	KYMCO
AGILITY R16	AGILITY RS	AGILITY R16	B&W	B&W	B&W	B&W EU2	B&W EU2	B&W EU2	DINK	DINK	DINK CLASSIC
12-12	09-09	10-10	00-00	00-00	00-00	03-04	03-04	03-03	97-98	97-98	02-02
200cc 4T AC	125cc 4T AC	200cc 4T AC	125cc 4T LC	150cc 4T LC	250cc 4T LC	125cc 4T LC	150cc 4T LC	250cc 4T LC	125cc 4T LC	150cc 4T LC	125cc 4T LC
	IM07071				IM07057			IM07057			
9926430	9926430	9926430	9915220	9915220		9915220	9915220		9915220	9915220	9915220
	9935740		9935660	9935660		9935660	9935660		9935660	9935660	9935660
					9922420			9922420			
			AA00815	AA00815	AA00816	AA00815	AA00815	AA00816	AA00815	AA00815	AA00815
9917640			9916710	9916710	9916080			9916080	9916710		
MA00007	MA00007	MA00007	MA00007	MA00007	MA00031	MA00007	MA00007	MA00031	MA00007	MA00007	MA00007
	RE00019		RE00026	RE00026	RE00026	RE00026	RE00026	RE00026	RE00026	RE00026	RE00026
			RL00006	RL00006	RL00008	RL00006	RL00006	RL00008	RL00006	RL00006	RL00006
			RL00007	RL00007	RL00009			RL00009	RL00007	RL00007	RL00007
	ST00025										
9927830	9927830	9927830			9923670						



KYMCO	KYMCO	KYMCO	KYMCO
DINK CLASSIC	DINK CLASSIC	DINK CLASSIC EU2	DINK CLASSIC EU2
02-02	04-04	03-03	03-03
150cc 4T LC	200cc 4T LC	125cc 4T LC	150cc 4T LC

IT	EN	FR				
ALBERO A CAMME	CAM SHAFT	ARBRE À CAMES				
ALBERO MOTORE Sel 1	Crankshaft Sel 1	VILEBREQUIN Sél 1				
ALBERO MOTORE Sel 2	Crankshaft Sel 2	VILEBREQUIN Sél 2				
BIELLA	CONROD	BIELLE				
CAMPANA FRIZIONE	CLUTCH HOUSING	CLOCHE EMBRAYAGE				
CINGHIA DI TRASMISSIONE Bando	TRANSMISSION BELT Bando	COURROIE DE TRANSMISSION Bando		9915220	9915220	9915220
CINGHIA DI TRASMISSIONE Mitsuboshi	TRANSMISSION BELT Mitsuboshi	COURROIE DE TRANSMISSION Mitsuboshi		9935660	9935660	9935660
CINGHIA DI TRASMISSIONE Altro	TRANSMISSION BELT Other	COURROIE DE TRANSMISSION Autres				
COLLETTORE ASPIRAZIONE	INLET MANIFOLD	COLLECTEUR ASPIRATION				
COLLETTORE ASPIRAZIONE SX	INLET MANIFOLD LEFT	COLLECTEUR ASPIRATION GAUCHE				
COLLETTORE ASPIRAZIONE DX	INLET MANIFOLD RIGHT	COLLECTEUR ASPIRATION DROITE				
FILTRO OLIO	OIL FILTER	FILTRE À HUILE				
FRIZIONE	CLUTCH	EMBRAYAGE				
GRUPPO TERMICO Standard	CYLINDER KIT Ø standard	CYLINDRE COMPLET Standard				
GRUPPO TERMICO Maggiorato	CYLINDER KIT BIG BORE	CYLINDRE COMPLET Majoré				
KIT CUSCINETTI PARAOLI DI BANCO Serie	BEARINGS AND OIL SEALS KIT	KIT PALIERS JOINTS D'HUILE DE VILEBREQUIN Jeu				
KIT REVISIONE POMPA ACQUA	WATER PUMP REPAIR KIT	KIT RÉVISION POMPE À EAU		AA00815	AA00815	AA00815
KIT TAGLIANDO	SERVICE KIT	KIT COUPON				
MASSE CENTRIFUGHE PESO ORIGINALE	ROLLER WEIGHTS Standard weight	MASSELOTTE CENTRIFUGES POIDS D'ORIGINE				
MEMBRANA CARBURATORE TIPO ORIGINALE	CARBURETOR DIAPHRAGM OEM	MEMBRANE CARBURATEUR TYPE ORIGINAL				
MEMBRANA CARBURATORE ADATTABILE	CARBURETOR DIAPHRAGM Adaptable	MEMBRANE CARBURATEUR ADAPTABLE				
MOLLE CONTRASTO VARIATORE	REAR VARIATOR SPRING	RESSORTS CONTRASTE VARIATEUR				
MOLLA A GAS PER SELLA	SEAT GAS SPRING	RESSORT À GAZ POUR SELLE				
MOTORINO D'AVVIAMENTO	STARTER ENGINE	DÉMARREUR ÉLECTRIQUE		MA00007	MA00007	MA00007
POMPA BENZINA	FUEL PUMP	POMPE À ESSENCE				
REGOLATORE DI TENSIONE	RECTIFIER	RÉGULATEUR DE TENSION		RE00026	RE00026	RE00026
RUOTA LIBERA Completa	STARTER CLUTCH SET	ROUE LIBRE Complète				
RUOTA LIBERA RL + flangia	STARTER CLUTCH + FLANGE	ROUE LIBRE RL + flasque		RL00006	RL00008	RL00006
RUOTA LIBERA RL nuda	STARTER CLUTCH	ROUE LIBRE RL nue				
RUOTA LIBERA Ingranaggio	STARTER CLUTCH GEAR	ROUE LIBRE Engrenage		RL00007	RL00007	RL00007
RUOTA LIBERA Flangia	STARTER CLUTCH FLANGE	ROUE LIBRE Flasque				
SERIE DISCHI FRIZIONE	CLUTCH PLATES KIT	JEU DISQUES EMBRAYAGE				
STATORE	STATOR	STATOR				
VARIOTOP TPR	VARIOTOP TPR	VARIOTOP TPR				

MAXI SCOOTER



KYMC0	KYMC0	KYMC0	KYMC0
DOWNTOWN I ABS	G-DINK	G-DINK	G-DINK I ABS E4
15-15	12-12	12-12	17-17
350cc 4T LC	125cc 4T LC	300cc 4T-2V LC	300cc 4T-2V LC

IT	EN	FR				
ALBERO A CAMME	CAM SHAFT	ARBRE À CAMES				
ALBERO MOTORE Sel 1	Crankshaft Sel 1	VILEBREQUIN Sél 1				
ALBERO MOTORE Sel 2	Crankshaft Sel 2	VILEBREQUIN Sél 2				
BIELLA	CONROD	BIELLE				
CAMPANA FRIZIONE	CLUTCH HOUSING	CLOCHE EMBRAYAGE				
CINGHIA DI TRASMISSIONE Bando	TRANSMISSION BELT Bando	COURROIE DE TRANSMISSION Bando				
CINGHIA DI TRASMISSIONE Mitsuboshi	TRANSMISSION BELT Mitsuboshi	COURROIE DE TRANSMISSION Mitsuboshi		9935320	9935910	9935910
CINGHIA DI TRASMISSIONE Altro	TRANSMISSION BELT Other	COURROIE DE TRANSMISSION Autres				
COLLETTORE ASPIRAZIONE	INLET MANIFOLD	COLLECTEUR ASPIRATION				
COLLETTORE ASPIRAZIONE SX	INLET MANIFOLD LEFT	COLLECTEUR ASPIRATION GAUCHE				
COLLETTORE ASPIRAZIONE DX	INLET MANIFOLD RIGHT	COLLECTEUR ASPIRATION DROITE				
FILTRO OLIO	OIL FILTER	FILTRE À HUILE				
FRIZIONE	CLUTCH	EMBRAYAGE				
GRUPPO TERMICO Standard	CYLINDER KIT Ø standard	CYLINDRE COMPLET Standard				
GRUPPO TERMICO Maggiorato	CYLINDER KIT BIG BORE	CYLINDRE COMPLET Majoré				
KIT CUSCINETTI PARAOLI DI BANCO Serie	BEARINGS AND OIL SEALS KIT	KIT PALIERS JOINTS D'HUILE DE VILEBREQUIN Jeu				
KIT REVISIONE POMPA ACQUA	WATER PUMP REPAIR KIT	KIT RÉVISION POMPE À EAU				
KIT TAGLIANDO	SERVICE KIT	KIT COUPON				
MASSE CENTRIFUGHE PESO ORIGINALE	ROLLER WEIGHTS Standard weight	MASSELOTES CENTRIFUGES POIDS D'ORIGINE				
MEMBRANA CARBURATORE TIPO ORIGINALE	CARBURETOR DIAPHRAGM OEM	MEMBRANE CARBURATEUR TYPE ORIGINAL				
MEMBRANA CARBURATORE ADATTABILE	CARBURETOR DIAPHRAGM Adaptable	MEMBRANE CARBURATEUR ADAPTABLE				
MOLLE CONTRASTO VARIATORE	REAR VARIATOR SPRING	RESSORTS CONTRASTE VARIATEUR				
MOLLA A GAS PER SELLA	SEAT GAS SPRING	RESSORT À GAZ POUR SELLE				
MOTORINO D'AVVIAMENTO	STARTER ENGINE	DÉMARREUR ÉLECTRIQUE			MA00027	MA00031
POMPA BENZINA	FUEL PUMP	POMPE À ESSENCE				
REGOLATORE DI TENSIONE	RECTIFIER	RÉGULATEUR DE TENSION				
RUOTA LIBERA Completa	STARTER CLUTCH SET	ROUE LIBRE Complète				
RUOTA LIBERA RL + flangia	STARTER CLUTCH + FLANGE	ROUE LIBRE RL + flasque		RL00028	RL00028	RL00028
RUOTA LIBERA RL nuda	STARTER CLUTCH	ROUE LIBRE RL nue				
RUOTA LIBERA Ingranaggio	STARTER CLUTCH GEAR	ROUE LIBRE Engrenage				
RUOTA LIBERA Flangia	STARTER CLUTCH FLANGE	ROUE LIBRE Flasque				
SERIE DISCHI FRIZIONE	CLUTCH PLATES KIT	JEU DISQUES EMBRAYAGE				
STATORE	STATOR	STATOR				
VARIOTOP TPR	VARIOTOP TPR	VARIOTOP TPR				

KYMCO	KYMCO	KYMCO	KYMCO	KYMCO	KYMCO	KYMCO	KYMCO	KYMCO	KYMCO	KYMCO	KYMCO
GRAND DINK	GRAND DINK	GRAND DINK	GRAND DINK EU2	GRAND DINK EU2	GRAND DINK EU2	HEROISM	HEROISM	K-XCT I	K-XCT I	K-XCT I ABS	LIKE
01-02	01-02	01-02	03-04	03-04	03-04	95-97	95-97	12-14	12-12	14-14	09-09
125cc 4T LC	150cc 4T LC	250cc 4T LC	125cc 4T LC	150cc 4T LC	250cc 4T LC	125cc 4T AC	150cc 4T AC	125cc 4T LC	300cc 4T LC	300cc 4T LC	125cc 4T AC
		IM07057				IM07057					IM07071
9915220	9915220		9915220	9915220		9915640	9915640				9926430
9935660	9935660		9935660	9935660				9935310	9935320	9935320	9935740
		9922420				9922420					
AA00815	AA00815	AA00816	AA00815	AA00815	AA00816						
9924320		9916080			9916080	9917640					
											MC12103
MA00027	MA00027	MA00031	MA00027	MA00027	MA00031	MA00007	MA00007				MA00007
RE00026	RE00026	RE00026	RE00026	RE00026	RE00026	RE00026	RE00026				RE00019
RL00006	RL00006	RL00008	RL00006	RL00006	RL00008			RL00006	RL00028	RL00028	
RL00007	RL00007	RL00009			RL00009	RL00024	RL00024				
											ST00025
		9923670									



KYMCO	KYMCO	KYMCO	KYMCO
LIKE IE	LIKE LX	LIKE LX	LIKE LX
09-09	09-09	12-12	12-12
200cc 4T AC	125cc 4T AC	125cc 4T AC	200cc 4T AC

IT	EN	FR				
ALBERO A CAMME	CAM SHAFT	ARBRE À CAMES				
ALBERO MOTORE Sel 1	Crankshaft Sel 1	VILEBREQUIN Sél 1			IM07071	
ALBERO MOTORE Sel 2	Crankshaft Sel 2	VILEBREQUIN Sél 2				
BIELLA	CONROD	BIELLE				
CAMPANA FRIZIONE	CLUTCH HOUSING	CLOCHE EMBRAYAGE				
CINGHIA DI TRASMISSIONE Bando	TRANSMISSION BELT Bando	COURROIE DE TRANSMISSION Bando		9926430		9926430
CINGHIA DI TRASMISSIONE Mitsuboshi	TRANSMISSION BELT Mitsuboshi	COURROIE DE TRANSMISSION Mitsuboshi			9935740	
CINGHIA DI TRASMISSIONE Altro	TRANSMISSION BELT Other	COURROIE DE TRANSMISSION Autres				
COLLETTORE ASPIRAZIONE	INLET MANIFOLD	COLLECTEUR ASPIRATION				
COLLETTORE ASPIRAZIONE SX	INLET MANIFOLD LEFT	COLLECTEUR ASPIRATION GAUCHE				
COLLETTORE ASPIRAZIONE DX	INLET MANIFOLD RIGHT	COLLECTEUR ASPIRATION DROITE				
FILTRO OLIO	OIL FILTER	FILTRE À HUILE				
FRIZIONE	CLUTCH	EMBRAYAGE				
GRUPPO TERMICO Standard	CYLINDER KIT Ø standard	CYLINDRE COMPLET Standard				
GRUPPO TERMICO Maggiorato	CYLINDER KIT BIG BORE	CYLINDRE COMPLET Majoré				
KIT CUSCINETTI PARAOLI DI BANCO Serie	BEARINGS AND OIL SEALS KIT	KIT PALIERS JOINTS D'HUILE DE VILEBREQUIN Jeu				
KIT REVISIONE POMPA ACQUA	WATER PUMP REPAIR KIT	KIT RÉVISION POMPE À EAU				
KIT TAGLIANDO	SERVICE KIT	KIT COUPON				
MASSE CENTRIFUGHE PESO ORIGINALE	ROLLER WEIGHTS Standard weight	MASSELOTES CENTRIFUGES POIDS D'ORIGINE				
MEMBRANA CARBURATORE TIPO ORIGINALE	CARBURETOR DIAPHRAGM OEM	MEMBRANE CARBURATEUR TYPE ORIGINAL				
MEMBRANA CARBURATORE ADATTABILE	CARBURETOR DIAPHRAGM Adaptable	MEMBRANE CARBURATEUR ADAPTABLE				MC12103
MOLLE CONTRASTO VARIATORE	REAR VARIATOR SPRING	RESSORTS CONTRASTE VARIATEUR				
MOLLA A GAS PER SELLA	SEAT GAS SPRING	RESSORT À GAZ POUR SELLE				
MOTORINO D'AVVIAMENTO	STARTER ENGINE	DÉMARREUR ÉLECTRIQUE		MA00007		MA00007
POMPA BENZINA	FUEL PUMP	POMPE À ESSENCE				
REGOLATORE DI TENSIONE	RECTIFIER	RÉGULATEUR DE TENSION				RE00019
RUOTA LIBERA Completa	STARTER CLUTCH SET	ROUE LIBRE Complète				
RUOTA LIBERA RL + flangia	STARTER CLUTCH + FLANGE	ROUE LIBRE RL + flasque				
RUOTA LIBERA RL nuda	STARTER CLUTCH	ROUE LIBRE RL nue				
RUOTA LIBERA Ingranaggio	STARTER CLUTCH GEAR	ROUE LIBRE Engrenage				
RUOTA LIBERA Flangia	STARTER CLUTCH FLANGE	ROUE LIBRE Flasque				
SERIE DISCHI FRIZIONE	CLUTCH PLATES KIT	JEU DISQUES EMBRAYAGE				
STATORE	STATOR	STATOR			ST00025	ST00025
VARIOTOP TPR	VARIOTOP TPR	VARIOTOP TPR		9927830		9927830



KYMCO	KYMCO	KYMCO	KYMCO
PEOPLE EU3	PEOPLE EU3	PEOPLE EU3	PEOPLE GTI
07-07	08-08	11-11	10-10
125cc 4T AC	125cc 4T AC	125cc 4T AC	125cc 4T LC

IT	EN	FR				
ALBERO A CAMME	CAM SHAFT	ARBRE À CAMES				
ALBERO MOTORE Sel 1	Crankshaft Sel 1	VILEBREQUIN Sél 1		IM07071	IM07071	IM07071
ALBERO MOTORE Sel 2	Crankshaft Sel 2	VILEBREQUIN Sél 2				
BIELLA	CONROD	BIELLE				
CAMPANA FRIZIONE	CLUTCH HOUSING	CLOCHE EMBRAYAGE				
CINGHIA DI TRASMISSIONE Bando	TRANSMISSION BELT Bando	COURROIE DE TRANSMISSION Bando		9926430	9926430	9926430
CINGHIA DI TRASMISSIONE Mitsuboshi	TRANSMISSION BELT Mitsuboshi	COURROIE DE TRANSMISSION Mitsuboshi		9935740	9935740	9935740
CINGHIA DI TRASMISSIONE Altro	TRANSMISSION BELT Other	COURROIE DE TRANSMISSION Autres				9935310
COLLETTORE ASPIRAZIONE	INLET MANIFOLD	COLLECTEUR ASPIRATION				
COLLETTORE ASPIRAZIONE SX	INLET MANIFOLD LEFT	COLLECTEUR ASPIRATION GAUCHE				
COLLETTORE ASPIRAZIONE DX	INLET MANIFOLD RIGHT	COLLECTEUR ASPIRATION DROITE				
FILTRO OLIO	OIL FILTER	FILTRE À HUILE				
FRIZIONE	CLUTCH	EMBAYAGE				
GRUPPO TERMICO Standard	CYLINDER KIT Ø standard	CYLINDRE COMPLET Standard				
GRUPPO TERMICO Maggiorato	CYLINDER KIT BIG BORE	CYLINDRE COMPLET Majoré				
KIT CUSCINETTI PARAOLI DI BANCO Serie	BEARINGS AND OIL SEALS KIT	KIT PALIERS JOINTS D'HUILE DE VILEBREQUIN Jeu				
KIT REVISIONE POMPA ACQUA	WATER PUMP REPAIR KIT	KIT RÉVISION POMPE À EAU				
KIT TAGLIANDO	SERVICE KIT	KIT COUPON		TG00103	TG00103	TG00103
MASSE CENTRIFUGHE PESO ORIGINALE	ROLLER WEIGHTS Standard weight	MASSELOTES CENTRIFUGES POIDS D'ORIGINE		9917640	9917640	9917640
MEMBRANA CARBURATORE TIPO ORIGINALE	CARBURETOR DIAPHRAGM OEM	MEMBRANE CARBURATEUR TYPE ORIGINAL				
MEMBRANA CARBURATORE ADATTABILE	CARBURETOR DIAPHRAGM Adaptable	MEMBRANE CARBURATEUR ADAPTABLE		MC12103	MC12103	MC12103
MOLLE CONTRASTO VARIATORE	REAR VARIATOR SPRING	RESSORTS CONTRASTE VARIATEUR				
MOLLA A GAS PER SELLA	SEAT GAS SPRING	RESSORT À GAZ POUR SELLE				
MOTORINO D'AVVIAMENTO	STARTER ENGINE	DÉMARREUR ÉLECTRIQUE		MA00007	MA00007	MA00007
POMPA BENZINA	FUEL PUMP	POMPE À ESSENCE				
REGOLATORE DI TENSIONE	RECTIFIER	RÉGULATEUR DE TENSION		RE00013	RE00013	RE00028
RUOTA LIBERA Completa	STARTER CLUTCH SET	ROUE LIBRE Complète				
RUOTA LIBERA RL + flangia	STARTER CLUTCH + FLANGE	ROUE LIBRE RL + flasque		RL00025	RL00025	RL00006
RUOTA LIBERA RL nuda	STARTER CLUTCH	ROUE LIBRE RL nue				
RUOTA LIBERA Ingranaggio	STARTER CLUTCH GEAR	ROUE LIBRE Engrenage		RL00024	RL00024	
RUOTA LIBERA Flangia	STARTER CLUTCH FLANGE	ROUE LIBRE Flasque				
SERIE DISCHI FRIZIONE	CLUTCH PLATES KIT	JEU DISQUES EMBRAYAGE				
STATORE	STATOR	STATOR		ST00027	ST00027	ST00027
VARIOTOP TPR	VARIOTOP TPR	VARIOTOP TPR		9927830	9927830	



KYMCO	KYMCO	KYMCO	KYMCO
PEOPLE ONE I	PEOPLE ONE I DD	PEOPLE S	PEOPLE S
13-13	15-15	05-05	05-05
125cc 4T AC	125cc 4T AC	125cc 4T AC	200cc 4T AC

IT	EN	FR				
ALBERO A CAMME	CAM SHAFT	ARBRE À CAMES				
ALBERO MOTORE Sel 1	Crankshaft Sel 1	VILEBREQUIN Sél 1			IM07071	IM07071
ALBERO MOTORE Sel 2	Crankshaft Sel 2	VILEBREQUIN Sél 2				
BIELLA	CONROD	BIELLE				
CAMPANA FRIZIONE	CLUTCH HOUSING	CLOCHE EMBRAYAGE				
CINGHIA DI TRASMISSIONE Bando	TRANSMISSION BELT Bando	COURROIE DE TRANSMISSION Bando				9926430 9926430
CINGHIA DI TRASMISSIONE Mitsuboshi	TRANSMISSION BELT Mitsuboshi	COURROIE DE TRANSMISSION Mitsuboshi		9935740	9935740	9935740
CINGHIA DI TRASMISSIONE Altro	TRANSMISSION BELT Other	COURROIE DE TRANSMISSION Autres				
COLLETTORE ASPIRAZIONE	INLET MANIFOLD	COLLECTEUR ASPIRATION				
COLLETTORE ASPIRAZIONE SX	INLET MANIFOLD LEFT	COLLECTEUR ASPIRATION GAUCHE				
COLLETTORE ASPIRAZIONE DX	INLET MANIFOLD RIGHT	COLLECTEUR ASPIRATION DROITE				
FILTRO OLIO	OIL FILTER	FILTRE À HUILE				
FRIZIONE	CLUTCH	EMBRAYAGE				
GRUPPO TERMICO Standard	CYLINDER KIT Ø standard	CYLINDRE COMPLET Standard				
GRUPPO TERMICO Maggiorato	CYLINDER KIT BIG BORE	CYLINDRE COMPLET Majoré				
KIT CUSCINETTI PARAOLI DI BANCO Serie	BEARINGS AND OIL SEALS KIT	KIT PALIERS JOINTS D'HUILE DE VILEBREQUIN Jeu				
KIT REVISIONE POMPA ACQUA	WATER PUMP REPAIR KIT	KIT RÉVISION POMPE À EAU				
KIT TAGLIANDO	SERVICE KIT	KIT COUPON		TG00103	TG00103	TG00103
MASSE CENTRIFUGHE PESO ORIGINALE	ROLLER WEIGHTS Standard weight	MASSELOTES CENTRIFUGES POIDS D'ORIGINE				9917640 9917640
MEMBRANA CARBURATORE TIPO ORIGINALE	CARBURETOR DIAPHRAGM OEM	MEMBRANE CARBURATEUR TYPE ORIGINAL				
MEMBRANA CARBURATORE ADATTABILE	CARBURETOR DIAPHRAGM Adaptable	MEMBRANE CARBURATEUR ADAPTABLE				MC12103 MC12103
MOLLE CONTRASTO VARIATORE	REAR VARIATOR SPRING	RESSORTS CONTRASTE VARIATEUR				
MOLLA A GAS PER SELLA	SEAT GAS SPRING	RESSORT À GAZ POUR SELLE				
MOTORINO D'AVVIAMENTO	STARTER ENGINE	DÉMARREUR ÉLECTRIQUE				MA00007 MA00007
POMPA BENZINA	FUEL PUMP	POMPE À ESSENCE				
REGOLATORE DI TENSIONE	RECTIFIER	RÉGULATEUR DE TENSION				RE00019 RE00019
RUOTA LIBERA Completa	STARTER CLUTCH SET	ROUE LIBRE Complète				
RUOTA LIBERA RL + flangia	STARTER CLUTCH + FLANGE	ROUE LIBRE RL + flasque				RL00025 RL00025
RUOTA LIBERA RL nuda	STARTER CLUTCH	ROUE LIBRE RL nue				
RUOTA LIBERA Ingranaggio	STARTER CLUTCH GEAR	ROUE LIBRE Engrenage				RL00024 RL00024
RUOTA LIBERA Flangia	STARTER CLUTCH FLANGE	ROUE LIBRE Flasque				
SERIE DISCHI FRIZIONE	CLUTCH PLATES KIT	JEU DISQUES EMBRAYAGE				
STATORE	STATOR	STATOR				
VARIOTOP TPR	VARIOTOP TPR	VARIOTOP TPR				9927830

KYMC0	KYMC0	KYMC0	KYMC0	KYMC0	KYMC0	KYMC0	KYMC0	KYMC0	KYMC0	KYMC0	KYMC0
PEOPLE S	PEOPLE S DD EU3	PEOPLE S I	PEOPLE S I	PEOPLE S I	SUPER 8	SUPER 8	VIVIO	VIVIO	X CITING	X CITING	X CITING I
06-06	07-08	07-07	07-07	08-08	08-08	09-09	00-00	00-00	05-05	05-05	06-07
250cc 4T LC	125cc 4T AC	200cc 4T AC	250cc 4T LC	300cc 4T LC	125cc 4T AC	125cc 4T AC	125cc 4T AC	150cc 4T AC	250cc 4T LC	500cc 4T LC	250cc 4T LC
				(BB60)	(KL25)	(KL25)					
IM07057	IM07071		IM07057		IM07071	IM07071	IM07071	IM07071	IM07057		IM07057
	9926430	9926430			9926430	9926430	9915640	9915640			
9935280	9935740		9935280	9935280	9935740	9935740			9935280	9935290	9935300
					CT00742	CT00742					
AA00816			AA00816	AA00816					AA00816	AA00840	AA00816
	TG00103				TG00103	TG00103					
9916080	9917640	9917640	9916080	9932390	9917640	9917640	9917640		9916080		9916080
	MC12103				MC12103						
MA00031	MA00007	MA00007	MA00031	MA00031	MA00007	MA00007	MA00007	MA00007	MA00031		MA00031
	RE00019	RE00026	RE00028	RE00028	RE00019	RE00019	RE00013	RE00013	RE00026	RE00028	RE00028
RL00028			RL00028	RL00028	RL00025	RL00025	RL00025	RL00025	RL00028	RL00027	RL00028
RL00031			RL00031	RL00031	RL00024	RL00024	RL00024	RL00024	RL00031	RL00026	RL00031
9923670			9923670		9927830	9927830	9927830	9927830	9923670		9923670



KYMCO	KYMCO	KYMCO	KYMCO
X CITING I	X CITING I	X CITING I	X CITING I
08-08	15-15	06-07	08-08
300cc 4T LC	400cc 4T LC	500cc 4T LC	500cc 4T LC
		(SAAO)	

IT	EN	FR				
ALBERO A CAMME	CAM SHAFT	ARBRE À CAMES				
ALBERO MOTORE Sel 1	Crankshaft Sel 1	VILEBREQUIN Sél 1				
ALBERO MOTORE Sel 2	Crankshaft Sel 2	VILEBREQUIN Sél 2				
BIELLA	CONROD	BIELLE				
CAMPANA FRIZIONE	CLUTCH HOUSING	CLOCHE EMBRAYAGE				
CINGHIA DI TRASMISSIONE Bando	TRANSMISSION BELT Bando	COURROIE DE TRANSMISSION Bando		9929770		
CINGHIA DI TRASMISSIONE Mitsuboshi	TRANSMISSION BELT Mitsuboshi	COURROIE DE TRANSMISSION Mitsuboshi			9935900	9935290
CINGHIA DI TRASMISSIONE Altro	TRANSMISSION BELT Other	COURROIE DE TRANSMISSION Autres				9935290
COLLETTORE ASPIRAZIONE	INLET MANIFOLD	COLLECTEUR ASPIRATION				
COLLETTORE ASPIRAZIONE SX	INLET MANIFOLD LEFT	COLLECTEUR ASPIRATION GAUCHE				
COLLETTORE ASPIRAZIONE DX	INLET MANIFOLD RIGHT	COLLECTEUR ASPIRATION DROITE				
FILTRO OLIO	OIL FILTER	FILTRE À HUILE				
FRIZIONE	CLUTCH	EMBAYAGE				
GRUPPO TERMICO Standard	CYLINDER KIT Ø standard	CYLINDRE COMPLET Standard				
GRUPPO TERMICO Maggiorato	CYLINDER KIT BIG BORE	CYLINDRE COMPLET Majoré				
KIT CUSCINETTI PARAOLI DI BANCO Serie	BEARINGS AND OIL SEALS KIT	KIT PALIERS JOINTS D'HUILE DE VILEBREQUIN Jeu				
KIT REVISIONE POMPA ACQUA	WATER PUMP REPAIR KIT	KIT RÉVISION POMPE À EAU		AA00816	AA00837	AA00840
KIT TAGLIANDO	SERVICE KIT	KIT COUPON				
MASSE CENTRIFUGHE PESO ORIGINALE	ROLLER WEIGHTS Standard weight	MASSELOTES CENTRIFUGES POIDS D'ORIGINE		9932390		
MEMBRANA CARBURATORE TIPO ORIGINALE	CARBURETOR DIAPHRAGM OEM	MEMBRANE CARBURATEUR TYPE ORIGINAL				
MEMBRANA CARBURATORE ADATTABILE	CARBURETOR DIAPHRAGM Adaptable	MEMBRANE CARBURATEUR ADAPTABLE				
MOLLE CONTRASTO VARIATORE	REAR VARIATOR SPRING	RESSORTS CONTRASTE VARIATEUR				
MOLLA A GAS PER SELLA	SEAT GAS SPRING	RESSORT À GAZ POUR SELLE				
MOTORINO D'AVVIAMENTO	STARTER ENGINE	DÉMARREUR ÉLECTRIQUE		MA00031		
POMPA BENZINA	FUEL PUMP	POMPE À ESSENCE				
REGOLATORE DI TENSIONE	RECTIFIER	RÉGULATEUR DE TENSION		RE00028		
RUOTA LIBERA Completa	STARTER CLUTCH SET	ROUE LIBRE Complète				
RUOTA LIBERA RL + flangia	STARTER CLUTCH + FLANGE	ROUE LIBRE RL + flasque		RL00028		RL00027
RUOTA LIBERA RL nuda	STARTER CLUTCH	ROUE LIBRE RL nue				
RUOTA LIBERA Ingranaggio	STARTER CLUTCH GEAR	ROUE LIBRE Engrenage		RL00031		RL00026
RUOTA LIBERA Flangia	STARTER CLUTCH FLANGE	ROUE LIBRE Flasque				
SERIE DISCHI FRIZIONE	CLUTCH PLATES KIT	JEU DISQUES EMBRAYAGE				
STATORE	STATOR	STATOR				
VARIOTOP TPR	VARIOTOP TPR	VARIOTOP TPR			9932860	

KYMC0	KYMC0	KYMC0	KYMC0	KYMC0	KYMC0	KYMC0	KYMC0	KYMC0	KYMC0	KYMC0	MALAGUTI
X CITING I ABS	X CITING I ABS	X CITING I ABS E4	X CITING I ABS E4	X CITING I R	X CITING I R	X CITING I R	X CITING R	X-TOWN CBS	XCITING I	YUP	BLOG
14-14	15-15	16-16	17-17	08-08	09-09	07-08	09-09	16-16	13-13	03-03	11-11
400cc 4T LC	400cc 4T LC	400cc 4T LC	400cc 4T LC	300cc 4T LC	300cc 4T LC	500cc 4T LC	500cc 4T LC	125cc 4T-4V LC	400cc 4T LC	250cc 4T LC	125cc 4T LC
										(SH50D)	
										IM07057	
				9929770	9929770						
9935900	9935900	9935900	9935900			9935290	9935290	9935310	9935900		9935770
										9922420	9923140
AA00837	AA00837			AA00816	AA00816	AA00840	AA00840		AA00837	AA00816	
				9932390	9932390					9916080	
				MA00031	MA00031					MA00031	MA00022
				RE00028	RE00028					RE00026	
				RL00028	RL00028	RL00027	RL00027	RL00006		RL00008	
				RL00031	RL00031	RL00026	RL00026			RL00009	
9932860	9932860								9932860	9923670	

MAXI SCOOTER



MALAGUTI	MALAGUTI	MALAGUTI	MALAGUTI
BLOG	BLOG IE	BLOG IE	CENTRO IE EU3
11-11	09-10	09-10	08-09
160cc 4T LC	125cc 4T LC	160cc 4T LC	125cc 4T LC

IT	EN	FR				
ALBERO A CAMME	CAM SHAFT	ARBRE À CAMES				
ALBERO MOTORE Sel 1	Crankshaft Sel 1	VILEBREQUIN Sél 1				
ALBERO MOTORE Sel 2	Crankshaft Sel 2	VILEBREQUIN Sél 2				
BIELLA	CONROD	BIELLE				
CAMPANA FRIZIONE	CLUTCH HOUSING	CLOCHE EMBRAYAGE				
CINGHIA DI TRASMISSIONE Bando	TRANSMISSION BELT Bando	COURROIE DE TRANSMISSION Bando				
CINGHIA DI TRASMISSIONE Mitsuboshi	TRANSMISSION BELT Mitsuboshi	COURROIE DE TRANSMISSION Mitsuboshi		9935770	9935770	9935770
CINGHIA DI TRASMISSIONE Altro	TRANSMISSION BELT Other	COURROIE DE TRANSMISSION Autres		9923140	9923140	9923140
COLLETTORE ASPIRAZIONE	INLET MANIFOLD	COLLECTEUR ASPIRATION				
COLLETTORE ASPIRAZIONE SX	INLET MANIFOLD LEFT	COLLECTEUR ASPIRATION GAUCHE				
COLLETTORE ASPIRAZIONE DX	INLET MANIFOLD RIGHT	COLLECTEUR ASPIRATION DROITE				
FILTRO OLIO	OIL FILTER	FILTRE À HUILE				
FRIZIONE	CLUTCH	EMBRAYAGE				
GRUPPO TERMICO Standard	CYLINDER KIT Ø standard	CYLINDRE COMPLET Standard				
GRUPPO TERMICO Maggiorato	CYLINDER KIT BIG BORE	CYLINDRE COMPLET Majoré				
KIT CUSCINETTI PARAOLI DI BANCO Serie	BEARINGS AND OIL SEALS KIT	KIT PALIERS JOINTS D'HUILE DE VILEBREQUIN Jeu				
KIT REVISIONE POMPA ACQUA	WATER PUMP REPAIR KIT	KIT RÉVISION POMPE À EAU				
KIT TAGLIANDO	SERVICE KIT	KIT COUPON				
MASSE CENTRIFUGHE PESO ORIGINALE	ROLLER WEIGHTS Standard weight	MASSELOTTE CENTRIFUGES POIDS D'ORIGINE				
MEMBRANA CARBURATORE TIPO ORIGINALE	CARBURETOR DIAPHRAGM OEM	MEMBRANE CARBURATEUR TYPE ORIGINAL				
MEMBRANA CARBURATORE ADATTABILE	CARBURETOR DIAPHRAGM Adaptable	MEMBRANE CARBURATEUR ADAPTABLE				
MOLLE CONTRASTO VARIATORE	REAR VARIATOR SPRING	RESSORTS CONTRASTE VARIATEUR				
MOLLA A GAS PER SELLA	SEAT GAS SPRING	RESSORT À GAZ POUR SELLE				
MOTORINO D'AVVIAMENTO	STARTER ENGINE	DÉMARREUR ÉLECTRIQUE		MA00022	MA00022	MA00022
POMPA BENZINA	FUEL PUMP	POMPE À ESSENCE				
REGOLATORE DI TENSIONE	RECTIFIER	RÉGULATEUR DE TENSION				
RUOTA LIBERA Completa	STARTER CLUTCH SET	ROUE LIBRE Complète				
RUOTA LIBERA RL + flangia	STARTER CLUTCH + FLANGE	ROUE LIBRE RL + flasque				
RUOTA LIBERA RL nuda	STARTER CLUTCH	ROUE LIBRE RL nue				
RUOTA LIBERA Ingranaggio	STARTER CLUTCH GEAR	ROUE LIBRE Engrenage				
RUOTA LIBERA Flangia	STARTER CLUTCH FLANGE	ROUE LIBRE Flasque				
SERIE DISCHI FRIZIONE	CLUTCH PLATES KIT	JEU DISQUES EMBRAYAGE				
STATORE	STATOR	STATOR				
VARIOTOP TPR	VARIOTOP TPR	VARIOTOP TPR				

MALAGUTI	MALAGUTI	MALAGUTI	MALAGUTI	MALAGUTI	MALAGUTI	MALAGUTI	MALAGUTI	MALAGUTI	MALAGUTI	MALAGUTI	MALAGUTI
CENTRO IE EU3	CENTRO SL	CENTRO SL	CENTRO SL IE EU3	CENTRO SL IE EU3	CIAK	CIAK	CIAK MASTER	CIAK MASTER	CIAK MASTER EU3	CIAK MASTER EURO 2	CIAK RESTYKING EU2
08-09	11-11	11-11	09-10	09-10	00-01	00-02	04-04	04-04	06-06	06-06	03-03
160cc 4T LC	125cc 4T LC	160cc 4T LC	125cc 4T LC	160cc 4T LC	125cc 4T AC	150cc 4T AC	125cc 4T AC	150cc 4T AC	125cc 4T AC	200cc 4T AC	125cc 4T AC
					Kymco	Kymco	Kymco	Kymco	Kymco	Kymco	Kymco
					9926430	9926430	9926430	9926430	9926430	9926430	9926430
9935770	9935770	9935770	9935770	9935770							
9923140	9923140	9923140	9923140	9923140							
					9924320						
MA00022	MA00022	MA00022	MA00022	MA00022	MA00007	MA00007	MA00007	MA00007	MA00007	MA00007	MA00007
					RE00013	RE00013	RE00013	RE00013	RE00019	RE00019	RE00013
							RL00025	RL00025		RL00025	
							RL00024	RL00024		RL00024	
							9927830	9927830		9927830	

MAXI SCOOTER



MALAGUTI	MALAGUTI	MALAGUTI	MALAGUTI
CIAK RESTYKING EU2	F18 WARRIOR	F18 WARRIOR	MADISON
03-03	00-02	00-02	99-01
150cc 4T AC	125cc 4T LC	150cc 4T LC	125cc 4T LC
Kymco	Kymco	Kymco	Minarelli YP

IT	EN	FR				
ALBERO A CAMME	CAM SHAFT	ARBRE À CAMES				
ALBERO MOTORE Sel 1	Crankshaft Sel 1	VILEBREQUIN Sél 1				IM07045
ALBERO MOTORE Sel 2	Crankshaft Sel 2	VILEBREQUIN Sél 2				
BIELLA	CONROD	BIELLE				
CAMPANA FRIZIONE	CLUTCH HOUSING	CLOCHE EMBRAYAGE				
CINGHIA DI TRASMISSIONE Bando	TRANSMISSION BELT Bando	COURROIE DE TRANSMISSION Bando		9926430	9915220	9915220 9915380
CINGHIA DI TRASMISSIONE Mitsuboshi	TRANSMISSION BELT Mitsuboshi	COURROIE DE TRANSMISSION Mitsuboshi			9935660	9935660 9935700
CINGHIA DI TRASMISSIONE Altro	TRANSMISSION BELT Other	COURROIE DE TRANSMISSION Autres				
COLLETTORE ASPIRAZIONE	INLET MANIFOLD	COLLECTEUR ASPIRATION				CT00730
COLLETTORE ASPIRAZIONE SX	INLET MANIFOLD LEFT	COLLECTEUR ASPIRATION GAUCHE				
COLLETTORE ASPIRAZIONE DX	INLET MANIFOLD RIGHT	COLLECTEUR ASPIRATION DROITE				
FILTRO OLIO	OIL FILTER	FILTRE À HUILE				
FRIZIONE	CLUTCH	EMBAYAGE				
GRUPPO TERMICO Standard	CYLINDER KIT Ø standard	CYLINDRE COMPLET Standard				
GRUPPO TERMICO Maggiorato	CYLINDER KIT BIG BORE	CYLINDRE COMPLET Majoré				9929380
KIT CUSCINETTI PARAOLI DI BANCO Serie	BEARINGS AND OIL SEALS KIT	KIT PALIERS JOINTS D'HUILE DE VILEBREQUIN Jeu				KK01010
KIT REVISIONE POMPA ACQUA	WATER PUMP REPAIR KIT	KIT RÉVISION POMPE À EAU				AA00805
KIT TAGLIANDO	SERVICE KIT	KIT COUPON				
MASSE CENTRIFUGHE PESO ORIGINALE	ROLLER WEIGHTS Standard weight	MASSELOTES CENTRIFUGES POIDS D'ORIGINE				9915270
MEMBRANA CARBURATORE TIPO ORIGINALE	CARBURETOR DIAPHRAGM OEM	MEMBRANE CARBURATEUR TYPE ORIGINAL				
MEMBRANA CARBURATORE ADATTABILE	CARBURETOR DIAPHRAGM Adaptable	MEMBRANE CARBURATEUR ADAPTABLE				MC12100
MOLLE CONTRASTO VARIATORE	REAR VARIATOR SPRING	RESSORTS CONTRASTE VARIATEUR				9929170
MOLLA A GAS PER SELLA	SEAT GAS SPRING	RESSORT À GAZ POUR SELLE				
MOTORINO D'AVVIAMENTO	STARTER ENGINE	DÉMARREUR ÉLECTRIQUE		MA00007	MA00007	MA00007 MA00017
POMPA BENZINA	FUEL PUMP	POMPE À ESSENCE				
REGOLATORE DI TENSIONE	RECTIFIER	RÉGULATEUR DE TENSION		RE00013		
RUOTA LIBERA Completa	STARTER CLUTCH SET	ROUE LIBRE Complète				
RUOTA LIBERA RL + flangia	STARTER CLUTCH + FLANGE	ROUE LIBRE RL + flasque				RL00002
RUOTA LIBERA RL nuda	STARTER CLUTCH	ROUE LIBRE RL nue				
RUOTA LIBERA Ingranaggio	STARTER CLUTCH GEAR	ROUE LIBRE Engrenage				
RUOTA LIBERA Flangia	STARTER CLUTCH FLANGE	ROUE LIBRE Flasque				
SERIE DISCHI FRIZIONE	CLUTCH PLATES KIT	JEU DISQUES EMBRAYAGE				
STATORE	STATOR	STATOR				
VARIOTOP TPR	VARIOTOP TPR	VARIOTOP TPR				9923550

MALAGUTI	MALAGUTI	MALAGUTI	MALAGUTI	MALAGUTI	MALAGUTI	MALAGUTI	MALAGUTI	MALAGUTI	MALAGUTI	MALAGUTI	MALAGUTI
MADISON 3	MADISON 3	MADISON K	MADISON R	MADISON R RETYLING	MADISON R RETYLING EU2	MADISON RS	MADISON S	MADISON S RETYLING	MADISON T	PASSWORD	PASSWORD EU3
06-09	06-09	02-02	01-02	02-02	03-04	04-04	99-01	02-02	99-01	05-06	07-08
125cc 4T LC	250cc 4T LC	400cc 4T LC	180cc 4T LC	125cc 4T LC	125cc 4T LC	250cc 4T LC	250cc 4T LC	200cc 4T LC	150cc 4T LC	250cc 4T LC	250cc 4T LC
Piaggio	Piaggio	Morini	Piaggio	Minarelli YP	Minarelli YP	Piaggio M237M	Minarelli YP	Piaggio	Minarelli YP	Minarelli YP	Minarelli YP
				IM07045	IM07045		IM07054			IM07054	IM07054
							IM07037			IM07037	IM07037
				9915380	9915380		9915800		9915380	9925600	9925600
	9935470			9935700	9935700	9935470	9935710		9935700		
				CT00730					CT00730		
F007515	F007515		F007515			F007515		F007515			
							9926850			9926850	9926850
				9929380	9929380				9929380		
				KK01010	KK01010		KK01007		KK01010	KK01007	KK01007
				AA00805	AA00805		AA00806		AA00805	AA00806	AA00806
		9922390		9915270	9915270		9918020			9918060	9918060
					MC12001		MC12001				
				MC12100	MC12101		MC12101		MC12100		
				9929170	9929170		9929870		9929170	9929870	9929870
				MA00017	MA00017		MA00010		MA00017	MA00010	MA00010
				RL00002	RL00002	RL00021	RL00010		RL00002	RL00010	RL00010
	RL00023					RL00023	RL00011			RL00011	RL00011
9923600	9923650		9923650	9923550	9923550	9923650	9931790	9923650	9923550	9931790	9931790

MAXI SCOOTER



MALAGUTI	MALAGUTI	MALAGUTI	MALAGUTI
PHANTOM MAX	PHANTOM MAX	PHANTOM MAX	SPIDER MAX GT
03-03	03-03	04-04	04-05
125cc 4T LC	200cc 4T LC	250cc 4T LC	500cc 4T LC
Minarelli YP	Piaggio	Piaggio M361M	Piaggio

IT	EN	FR				
ALBERO A CAMME	CAM SHAFT	ARBRE À CAMES				
ALBERO MOTORE Sel 1	Crankshaft Sel 1	VILEBREQUIN Sél 1		IM07045		
ALBERO MOTORE Sel 2	Crankshaft Sel 2	VILEBREQUIN Sél 2				
BIELLA	CONROD	BIELLE				
CAMPANA FRIZIONE	CLUTCH HOUSING	CLOCHE EMBRAYAGE				
CINGHIA DI TRASMISSIONE Bando	TRANSMISSION BELT Bando	COURROIE DE TRANSMISSION Bando		9915380		9927630
CINGHIA DI TRASMISSIONE Mitsuboshi	TRANSMISSION BELT Mitsuboshi	COURROIE DE TRANSMISSION Mitsuboshi		9935700		9935470
CINGHIA DI TRASMISSIONE Altro	TRANSMISSION BELT Other	COURROIE DE TRANSMISSION Autres				
COLLETTORE ASPIRAZIONE	INLET MANIFOLD	COLLECTEUR ASPIRATION		CT00730		
COLLETTORE ASPIRAZIONE SX	INLET MANIFOLD LEFT	COLLECTEUR ASPIRATION GAUCHE				
COLLETTORE ASPIRAZIONE DX	INLET MANIFOLD RIGHT	COLLECTEUR ASPIRATION DROITE				
FILTRO OLIO	OIL FILTER	FILTRE À HUILE			F007515	F007515 F007524
FRIZIONE	CLUTCH	EMBAYAGE				
GRUPPO TERMICO Standard	CYLINDER KIT Ø standard	CYLINDRE COMPLET Standard				
GRUPPO TERMICO Maggiorato	CYLINDER KIT BIG BORE	CYLINDRE COMPLET Majoré		9929380		
KIT CUSCINETTI PARAOLI DI BANCO Serie	BEARINGS AND OIL SEALS KIT	KIT PALIERS JOINTS D'HUILE DE VILEBREQUIN Jeu		KK01010		
KIT REVISIONE POMPA ACQUA	WATER PUMP REPAIR KIT	KIT RÉVISION POMPE À EAU		AA00805		
KIT TAGLIANDO	SERVICE KIT	KIT COUPON				
MASSE CENTRIFUGHE PESO ORIGINALE	ROLLER WEIGHTS Standard weight	MASSELOTES CENTRIFUGES POIDS D'ORIGINE		9915270		9922330
MEMBRANA CARBURATORE TIPO ORIGINALE	CARBURETOR DIAPHRAGM OEM	MEMBRANE CARBURATEUR TYPE ORIGINAL				
MEMBRANA CARBURATORE ADATTABILE	CARBURETOR DIAPHRAGM Adaptable	MEMBRANE CARBURATEUR ADAPTABLE		MC12100		
MOLLE CONTRASTO VARIATORE	REAR VARIATOR SPRING	RESSORTS CONTRASTE VARIATEUR		9929170		9926780
MOLLA A GAS PER SELLA	SEAT GAS SPRING	RESSORT À GAZ POUR SELLE				
MOTORINO D'AVVIAMENTO	STARTER ENGINE	DÉMARREUR ÉLECTRIQUE		MA00017		
POMPA BENZINA	FUEL PUMP	POMPE À ESSENCE				
REGOLATORE DI TENSIONE	RECTIFIER	RÉGULATEUR DE TENSION				
RUOTA LIBERA Completa	STARTER CLUTCH SET	ROUE LIBRE Complète				
RUOTA LIBERA RL + flangia	STARTER CLUTCH + FLANGE	ROUE LIBRE RL + flasque		RL00002		RL00021 RL00021
RUOTA LIBERA RL nuda	STARTER CLUTCH	ROUE LIBRE RL nue				
RUOTA LIBERA Ingranaggio	STARTER CLUTCH GEAR	ROUE LIBRE Engrenage				RL00023 RL00023
RUOTA LIBERA Flangia	STARTER CLUTCH FLANGE	ROUE LIBRE Flasque				
SERIE DISCHI FRIZIONE	CLUTCH PLATES KIT	JEU DISQUES EMBRAYAGE				
STATORE	STATOR	STATOR				
VARIOTOP TPR	VARIOTOP TPR	VARIOTOP TPR		9923550	9923650	9923650 9923250

MALAGUTI	MALAGUTI	MBK	MBK	MBK	MBK	MBK	MBK	MBK	MBK	MBK	MBK
SPIDER MAX GT EU3	SPIDER MAX RS	CITYLINER EU3	D00D0	D00D0	FLAME F	FLAME R	FLAME T	KILIBRE	SKYCRUISER	SKYLINER	SKYLINER
06-06	08-08	08-10	00-00	01-02	00-00	96-99	95-99	03-06	07-07	98-00	01-02
500cc 4T LC	500cc 4T LC	125cc 4T-4V LC	125cc 4T LC	150cc 4T LC	125cc 4T AC	125cc 4T AC	125cc 4T AC	300cc 4T LC	125cc 4T-4V LC	125cc 4T LC	125cc 4T LC
Piaggio M341M	Piaggio	Minarelli	Minarelli YP	Minarelli YP				Minarelli YP	Minarelli	Minarelli YP	Minarelli YP
		9927230							9927230		
		IM07072	IM07045						IM07072	IM07045	IM07045
								IM07037			
9927630	9927630	9925280	9915380	9915380	9931550	9931550	9931550	9925600	9925280	9915380	9915380
			9935700	9935700						9935700	9935700
			CT00730	CT00730			CT00730			CT00730	CT00730
F007524	F007524	F007523							F007523		
		9932700							9932700		
		9925180	9929380	9929380				9925180	9929380	9929380	9929380
			KK01010	KK01010				KK01007		KK01010	KK01010
		AA00823	AA00805	AA00805				AA00806	AA00823	AA00805	AA00805
			9915270					9918020		9915270	9915270
								MC12001			
			MC12100	MC12100				MC12101		MC12100	MC12100
9926780	9926780	9926760	9929170	9929170					9926760	9929170	9929170
		MA00028	MA00017	MA00017				MA00010	MA00028	MA00017	MA00017
				RE00020						RE00020	RE00020
RL00021	RL00021	RL00034	RL00002	RL00002			RL00002	RL00010	RL00034	RL00002	RL00002
RL00023	RL00023	RL00035						RL00011	RL00035		
			ST00002	ST00002						ST00002	ST00002
9923250	9923250	9925020	9923550	9923550				9931790	9925020	9923550	9923550



MBK	MBK	MBK	MBK
SKYLINER	SKYLINER	SKYLINER	SKYLINER
00-00	01-02	00-01	02-03
150cc 4T LC	150cc 4T LC	250cc 4T LC	250cc 4T LC
Minarelli YP	Minarelli YP	Minarelli YP	Minarelli YP

IT	EN	FR				
ALBERO A CAMME	CAM SHAFT	ARBRE À CAMES				
ALBERO MOTORE Sel 1	Crankshaft Sel 1	VILEBREQUIN Sél 1				IM07054
ALBERO MOTORE Sel 2	Crankshaft Sel 2	VILEBREQUIN Sél 2				IM07054
BIELLA	CONROD	BIELLE				IM07037
CAMPANA FRIZIONE	CLUTCH HOUSING	CLOCHE EMBRAYAGE				
CINGHIA DI TRASMISSIONE Bando	TRANSMISSION BELT Bando	COURROIE DE TRANSMISSION Bando		9915380	9915380	9915800
CINGHIA DI TRASMISSIONE Mitsuboshi	TRANSMISSION BELT Mitsuboshi	COURROIE DE TRANSMISSION Mitsuboshi		9935700	9935700	9935710
CINGHIA DI TRASMISSIONE Altro	TRANSMISSION BELT Other	COURROIE DE TRANSMISSION Autres				
COLLETTORE ASPIRAZIONE	INLET MANIFOLD	COLLECTEUR ASPIRATION		CT00730	CT00730	
COLLETTORE ASPIRAZIONE SX	INLET MANIFOLD LEFT	COLLECTEUR ASPIRATION GAUCHE				
COLLETTORE ASPIRAZIONE DX	INLET MANIFOLD RIGHT	COLLECTEUR ASPIRATION DROITE				
FILTRO OLIO	OIL FILTER	FILTRE À HUILE				
FRIZIONE	CLUTCH	EMBAYAGE				
GRUPPO TERMICO Standard	CYLINDER KIT Ø standard	CYLINDRE COMPLET Standard				9926850
GRUPPO TERMICO Maggiorato	CYLINDER KIT BIG BORE	CYLINDRE COMPLET Majoré		9929380	9929380	
KIT CUSCINETTI PARAOLI DI BANCO Serie	BEARINGS AND OIL SEALS KIT	KIT PALIERS JOINTS D'HUILE DE VILEBREQUIN Jeu		KK01010	KK01010	KK01007
KIT REVISIONE POMPA ACQUA	WATER PUMP REPAIR KIT	KIT RÉVISION POMPE À EAU		AA00805	AA00805	AA00806
KIT TAGLIANDO	SERVICE KIT	KIT COUPON				
MASSE CENTRIFUGHE PESO ORIGINALE	ROLLER WEIGHTS Standard weight	MASSELOTES CENTRIFUGES POIDS D'ORIGINE				9918060
MEMBRANA CARBURATORE TIPO ORIGINALE	CARBURETOR DIAPHRAGM OEM	MEMBRANE CARBURATEUR TYPE ORIGINAL				MC12001
MEMBRANA CARBURATORE ADATTABILE	CARBURETOR DIAPHRAGM Adaptable	MEMBRANE CARBURATEUR ADAPTABLE				MC12101
MOLLE CONTRASTO VARIATORE	REAR VARIATOR SPRING	RESSORTS CONTRASTE VARIATEUR		9929170	9929170	9929870
MOLLA A GAS PER SELLA	SEAT GAS SPRING	RESSORT À GAZ POUR SELLE				
MOTORINO D'AVVIAMENTO	STARTER ENGINE	DÉMARREUR ÉLECTRIQUE		MA00017	MA00017	MA00010
POMPA BENZINA	FUEL PUMP	POMPE À ESSENCE				
REGOLATORE DI TENSIONE	RECTIFIER	RÉGULATEUR DE TENSION		RE00020	RE00020	
RUOTA LIBERA Completa	STARTER CLUTCH SET	ROUE LIBRE Complète				
RUOTA LIBERA RL + flangia	STARTER CLUTCH + FLANGE	ROUE LIBRE RL + flasque		RL00002	RL00002	RL00010
RUOTA LIBERA RL nuda	STARTER CLUTCH	ROUE LIBRE RL nue				
RUOTA LIBERA Ingranaggio	STARTER CLUTCH GEAR	ROUE LIBRE Engrenage				RL00011
RUOTA LIBERA Flangia	STARTER CLUTCH FLANGE	ROUE LIBRE Flasque				
SERIE DISCHI FRIZIONE	CLUTCH PLATES KIT	JEU DISQUES EMBRAYAGE				
STATORE	STATOR	STATOR		ST00002	ST00002	
VARIOTOP TPR	VARIOTOP TPR	VARIOTOP TPR		9923550	9923550	9931790

MBK	MBK	MBK	MBK	MBK	PEUGEOT	PEUGEOT	PEUGEOT	PEUGEOT	PEUGEOT	PEUGEOT	PEUGEOT
SKYLINER ABS	SKYLINER E	SKYLINER E	THUNDER	THUNDER	CITYSTAR	CITYSTAR LC	CITYSTAR LC	GEOPOLIS	GEOPOLIS IE EU3	GEOPOLIS IE EU3	GEOPOLIS IE EU3
03-03	03-03	03-03	01-02	01-02	11-14	11-16	12-15	06-13	90-02	90-02	90-02
250cc 4T LC	125cc 4T LC	180cc 4T LC	125cc 4T LC	150cc 4T LC	125cc 4T-2V AC	125cc 4T-4V LC	200cc 4T-4V LC	125cc 4T-4V LC	250cc 4T-4V LC	400cc 4T-4V LC	500cc 4T-4V LC
Minarelli YP	Minarelli YP	Minarelli YP	Minarelli YP	Minarelli YP					Piaggio	Piaggio	Piaggio
IM07054	IM07045		IM07045								
IM07037											
9915800	9915380		9915380	9915380						9927630	9927630
9935710	9935700		9935700	9935700	9935350	9935350	9935390	9935380			
	CT00729	CT00729	CT00730	CT00730							
									F007515	F007524	F007524
9926850											
	9929380		9929380	9929380							
KK01007	KK01010	KK01010	KK01010	KK01010							
AA00806	AA00805	AA00805	AA00805	AA00805							
9918060	9915270		9915270							9924530	
MC12001	MC12001	MC12001									
MC12101	MC12101	MC12101	MC12100	MC12100							
9929870	9929170		9929170	9929170						9926780	9926780
MA00010	MA00017	MA00017	MA00017	MA00017							
	RE00030	RE00030									
RL00010	RL00032	RL00032	RL00002	RL00002						RL00021	RL00021
RL00011										RL00023	RL00023
	ST00002	ST00002	ST00002	ST00002							
9931790	9923550	9923550	9923550	9923550					9923650		9923250



PEUGEOT	PEUGEOT	PEUGEOT	PEUGEOT
METROPOLIS	SATELIS	SATELIS	SATELIS 2 PREMIUM
13-16	06-11	13-16	12-14
400cc 4T LC	125cc 4T-4V LC	400cc 4T LC	125cc 4T-4V LC
Piaggio		Piaggio	

IT	EN	FR				
ALBERO A CAMME	CAM SHAFT	ARBRE À CAMES				
ALBERO MOTORE Sel 1	Crankshaft Sel 1	VILEBREQUIN Sél 1				
ALBERO MOTORE Sel 2	Crankshaft Sel 2	VILEBREQUIN Sél 2				
BIELLA	CONROD	BIELLE				
CAMPANA FRIZIONE	CLUTCH HOUSING	CLOCHE EMBRAYAGE				
CINGHIA DI TRASMISSIONE Bando	TRANSMISSION BELT Bando	COURROIE DE TRANSMISSION Bando				
CINGHIA DI TRASMISSIONE Mitsuboshi	TRANSMISSION BELT Mitsuboshi	COURROIE DE TRANSMISSION Mitsuboshi		9935400	9935350	9935400
CINGHIA DI TRASMISSIONE Altro	TRANSMISSION BELT Other	COURROIE DE TRANSMISSION Autres				
COLLETTORE ASPIRAZIONE	INLET MANIFOLD	COLLECTEUR ASPIRATION				
COLLETTORE ASPIRAZIONE SX	INLET MANIFOLD LEFT	COLLECTEUR ASPIRATION GAUCHE				
COLLETTORE ASPIRAZIONE DX	INLET MANIFOLD RIGHT	COLLECTEUR ASPIRATION DROITE				
FILTRO OLIO	OIL FILTER	FILTRE À HUILE				
FRIZIONE	CLUTCH	EMBRAYAGE				
GRUPPO TERMICO Standard	CYLINDER KIT Ø standard	CYLINDRE COMPLET Standard				
GRUPPO TERMICO Maggiorato	CYLINDER KIT BIG BORE	CYLINDRE COMPLET Majoré				
KIT CUSCINETTI PARAOLI DI BANCO Serie	BEARINGS AND OIL SEALS KIT	KIT PALIERS JOINTS D'HUILE DE VILEBREQUIN Jeu				
KIT REVISIONE POMPA ACQUA	WATER PUMP REPAIR KIT	KIT RÉVISION POMPE À EAU				
KIT TAGLIANDO	SERVICE KIT	KIT COUPON				
MASSE CENTRIFUGHE PESO ORIGINALE	ROLLER WEIGHTS Standard weight	MASSELOTES CENTRIFUGES POIDS D'ORIGINE				
MEMBRANA CARBURATORE TIPO ORIGINALE	CARBURETOR DIAPHRAGM OEM	MEMBRANE CARBURATEUR TYPE ORIGINAL				
MEMBRANA CARBURATORE ADATTABILE	CARBURETOR DIAPHRAGM Adaptable	MEMBRANE CARBURATEUR ADAPTABLE				
MOLLE CONTRASTO VARIATORE	REAR VARIATOR SPRING	RESSORTS CONTRASTE VARIATEUR				
MOLLA A GAS PER SELLA	SEAT GAS SPRING	RESSORT À GAZ POUR SELLE				
MOTORINO D'AVVIAMENTO	STARTER ENGINE	DÉMARREUR ÉLECTRIQUE				
POMPA BENZINA	FUEL PUMP	POMPE À ESSENCE				
REGOLATORE DI TENSIONE	RECTIFIER	RÉGULATEUR DE TENSION				
RUOTA LIBERA Completa	STARTER CLUTCH SET	ROUE LIBRE Complète				
RUOTA LIBERA RL + flangia	STARTER CLUTCH + FLANGE	ROUE LIBRE RL + flasque				
RUOTA LIBERA RL nuda	STARTER CLUTCH	ROUE LIBRE RL nue				
RUOTA LIBERA Ingranaggio	STARTER CLUTCH GEAR	ROUE LIBRE Engrenage				
RUOTA LIBERA Flangia	STARTER CLUTCH FLANGE	ROUE LIBRE Flasque				
SERIE DISCHI FRIZIONE	CLUTCH PLATES KIT	JEU DISQUES EMBRAYAGE				
STATORE	STATOR	STATOR				
VARIOTOP TPR	VARIOTOP TPR	VARIOTOP TPR				

PEUGEOT	PEUGEOT	PEUGEOT	PEUGEOT	PEUGEOT	PIAGGIO	PIAGGIO	PIAGGIO	PIAGGIO	PIAGGIO	PIAGGIO	PIAGGIO
SATELIS COMPRESSOR	SATELIS EU3	SATELIS EU3	SATELIS EU3	SATELIS RS IE	BEVERLY	BEVERLY	BEVERLY	BEVERLY	BEVERLY	BEVERLY EU3	BEVERLY 4T 4V IE EU3
06-06	90-02	07-12	90-02	06-11	01-03	01-03	05-07	02-04	05-06	06-07	11-14
125cc 4T-4V LC	250cc 4T LC	400cc 4T LC	500cc 4T LC	125cc 4T-4V LC	125cc 4T LC	200cc 4T LC	250cc 4T LC	500cc 4T LC	500cc 4T LC	400cc 4T LC	350cc 4T LC
	Piaggio	Piaggio	Piaggio				Piaggio M285M		Piaggio	Piaggio M345M	Piaggio
					IM070701						
					IM070702						
		9927630	9927630		9928540		9927640	9927630	9927630	9927630	
9935390				9935350		9935450					9935490
					CT00734		CT00735				
	F007515	F007524	F007524		F007515	F007515	F007515	F007524	F007524	F007524	
					AA00817	AA00817	AA00828			AA00824	AA00829
							TG00101				
		9924530	9924530			9932790		9922330	9935990	9924530	
					MC12002						
							MC12106				
		9926780	9926780					9926780	9926780	9926780	
					MA00012		MA00016	MA00030	MA00030	MA00030	
					RE00011		RE00011	RE00004	RE00004	RE00004	
		RL00021	RL00021					RL00021	RL00021	RL00021	RL00021
		RL00023	RL00023		RL00022	RL00022	RL00023	RL00023	RL00023	RL00023	RL00023
											9931020
								ST00005	ST00005	ST00005	
	9923650		9923250		9923600	9923650	9923650	9923250	9923250		

MAXI SCOOTER



PIAGGIO	PIAGGIO	PIAGGIO	PIAGGIO
BEVERLY 4T ST IE ABS	BEVERLY CRUISER	BEVERLY CRUISER	BEVERLY EU3
16-16	07-09	07-12	07-08
350cc 4T LC	250cc 4T LC	500cc 4T LC	125cc 4T LC
Piaggio		Piaggio Master	

IT	EN	FR				
ALBERO A CAMME	CAM SHAFT	ARBRE À CAMES				
ALBERO MOTORE Sel 1	Crankshaft Sel 1	VILEBREQUIN Sél 1				IM070701
ALBERO MOTORE Sel 2	Crankshaft Sel 2	VILEBREQUIN Sél 2				IM070702
BIELLA	CONROD	BIELLE				
CAMPANA FRIZIONE	CLUTCH HOUSING	CLOCHE EMBRAYAGE				
CINGHIA DI TRASMISSIONE Bando	TRANSMISSION BELT Bando	COURROIE DE TRANSMISSION Bando		9927640		9928540
CINGHIA DI TRASMISSIONE Mitsuboshi	TRANSMISSION BELT Mitsuboshi	COURROIE DE TRANSMISSION Mitsuboshi		9935490		9935500
CINGHIA DI TRASMISSIONE Altro	TRANSMISSION BELT Other	COURROIE DE TRANSMISSION Autres				
COLLETTORE ASPIRAZIONE	INLET MANIFOLD	COLLECTEUR ASPIRATION				
COLLETTORE ASPIRAZIONE SX	INLET MANIFOLD LEFT	COLLECTEUR ASPIRATION GAUCHE				
COLLETTORE ASPIRAZIONE DX	INLET MANIFOLD RIGHT	COLLECTEUR ASPIRATION DROITE				
FILTRO OLIO	OIL FILTER	FILTRE À HUILE		F007515	F007524	F007515
FRIZIONE	CLUTCH	EMBRAYAGE				
GRUPPO TERMICO Standard	CYLINDER KIT Ø standard	CYLINDRE COMPLET Standard				
GRUPPO TERMICO Maggiorato	CYLINDER KIT BIG BORE	CYLINDRE COMPLET Majoré				
KIT CUSCINETTI PARAOLI DI BANCO Serie	BEARINGS AND OIL SEALS KIT	KIT PALIERS JOINTS D'HUILE DE VILEBREQUIN Jeu				
KIT REVISIONE POMPA ACQUA	WATER PUMP REPAIR KIT	KIT RÉVISION POMPE À EAU		AA00829	AA00828	AA00824 AA00826
KIT TAGLIANDO	SERVICE KIT	KIT COUPON			TG00101	TG00112
MASSE CENTRIFUGHE PESO ORIGINALE	ROLLER WEIGHTS Standard weight	MASSELOTES CENTRIFUGES POIDS D'ORIGINE		9931880	9935990	
MEMBRANA CARBURATORE TIPO ORIGINALE	CARBURETOR DIAPHRAGM OEM	MEMBRANE CARBURATEUR TYPE ORIGINAL				
MEMBRANA CARBURATORE ADATTABILE	CARBURETOR DIAPHRAGM Adaptable	MEMBRANE CARBURATEUR ADAPTABLE				MC12106
MOLLE CONTRASTO VARIATORE	REAR VARIATOR SPRING	RESSORTS CONTRASTE VARIATEUR			9926780	
MOLLA A GAS PER SELLA	SEAT GAS SPRING	RESSORT À GAZ POUR SELLE				
MOTORINO D'AVVIAMENTO	STARTER ENGINE	DÉMARREUR ÉLECTRIQUE		MA00016	MA00030	MA00012
POMPA BENZINA	FUEL PUMP	POMPE À ESSENCE				
REGOLATORE DI TENSIONE	RECTIFIER	RÉGULATEUR DE TENSION		RE00004	RE00004	RE00011
RUOTA LIBERA Completa	STARTER CLUTCH SET	ROUE LIBRE Complète				
RUOTA LIBERA RL + flangia	STARTER CLUTCH + FLANGE	ROUE LIBRE RL + flasque		RL00021	RL00041	RL00021
RUOTA LIBERA RL nuda	STARTER CLUTCH	ROUE LIBRE RL nue				
RUOTA LIBERA Ingranaggio	STARTER CLUTCH GEAR	ROUE LIBRE Engrenage		RL00023	RL00023	RL00023 RL00022
RUOTA LIBERA Flangia	STARTER CLUTCH FLANGE	ROUE LIBRE Flasque				
SERIE DISCHI FRIZIONE	CLUTCH PLATES KIT	JEU DISQUES EMBRAYAGE		9931020		
STATORE	STATOR	STATOR			ST00023	
VARIOTOP TPR	VARIOTOP TPR	VARIOTOP TPR			9923250	9923600

PIAGGIO	PIAGGIO	PIAGGIO	PIAGGIO	PIAGGIO	PIAGGIO	PIAGGIO	PIAGGIO	PIAGGIO	PIAGGIO	PIAGGIO	PIAGGIO
BEVERLY EURO 3 MIC	BEVERLY EURO 3 MIC	BEVERLY EURO 3 SPORT	BEVERLY IE EU3	BEVERLY IE EU3	BEVERLY RST	BEVERLY RST	BEVERLY RST	BEVERLY RST 4T 4V IE EU3	BEVERLY RST 4T 4V IE EU3	BEVERLY SPORT	BEVERLY TOURER EU3
07-07	07-07	07-08	06-08	06-08	04-05	05-07	04-05	10-15	10-16	06-08	07-10
125cc 4T LC	250cc 4T LC	125cc 4T LC	250cc 4T LC	500cc 4T LC	125cc 4T LC	125cc 4T LC	250cc 4T LC	125cc 4T LC	300cc 4T LC	250cc 4T LC	125cc 4T LC
				Piaggio M343M	M28400						
						IM070701					IM070701
						IM070702					IM070702
9928540	9927640	9928540	9927640	9927630	9928540	9928540	9927640	9928540	9927640	9927640	9928540
					CT00735	CT00735	CT00735				
F007515	F007515	F007515	F007515	F007524	F007515	F007515	F007515	F007515	F007515	F007515	F007515
AA00826	AA00828	AA00826	AA00828	AA00824	AA00817	AA00826		AA00826	AA00828	AA00828	AA00826
	TG00101		TG00101				TG00101		TG00102	TG00101	
			9931880	9935990					9931880	9931880	
MC12106		MC12106				MC12106					MC12106
				9926780							
MA00012		MA00012	MA00016	MA00030	MA00012	MA00012	MA00016		MA00016		MA00012
RE00011		RE00011	RE00004	RE00004	RE00011	RE00011	RE00011			RE00004	RE00011
	RL00041		RL00041	RL00021			RL00021	RL00041	RL00021	RL00041	
RL00022	RL00023	RL00022	RL00023	RL00023	RL00022	RL00022	RL00023		RL00023	RL00023	RL00022
	ST00023		ST00023	ST00005						ST00023	
9923600		9923600	9923650	9923250	9923600	9923600	9923650	9923600			9923600

MAXI SCOOTER



PIAGGIO	PIAGGIO	PIAGGIO	PIAGGIO
BEVERLY TOURER EU3	BEVERLY TOURER EU3	BEVERLY TOURER EU3	CARNABY
07-09	09-10	08-10	07-10
250cc 4T LC	300cc 4T LC	400cc 4T LC	125cc 4T LC
	Piaggio M28MM	Piaggio M349M	Leader M28FM

IT	EN	FR				
ALBERO A CAMME	CAM SHAFT	ARBRE À CAMES				
ALBERO MOTORE Sel 1	Crankshaft Sel 1	VILEBREQUIN Sél 1				IM070701
ALBERO MOTORE Sel 2	Crankshaft Sel 2	VILEBREQUIN Sél 2				IM070702
BIELLA	CONROD	BIELLE				
CAMPANA FRIZIONE	CLUTCH HOUSING	CLOCHE EMBRAYAGE				
CINGHIA DI TRASMISSIONE Bando	TRANSMISSION BELT Bando	COURROIE DE TRANSMISSION Bando		9927640	9927640	9927630
CINGHIA DI TRASMISSIONE Mitsuboshi	TRANSMISSION BELT Mitsuboshi	COURROIE DE TRANSMISSION Mitsuboshi				
CINGHIA DI TRASMISSIONE Altro	TRANSMISSION BELT Other	COURROIE DE TRANSMISSION Autres				
COLLETTORE ASPIRAZIONE	INLET MANIFOLD	COLLECTEUR ASPIRATION				
COLLETTORE ASPIRAZIONE SX	INLET MANIFOLD LEFT	COLLECTEUR ASPIRATION GAUCHE				
COLLETTORE ASPIRAZIONE DX	INLET MANIFOLD RIGHT	COLLECTEUR ASPIRATION DROITE				
FILTRO OLIO	OIL FILTER	FILTRE À HUILE		F007515	F007515	F007524
FRIZIONE	CLUTCH	EMBRAYAGE				
GRUPPO TERMICO Standard	CYLINDER KIT Ø standard	CYLINDRE COMPLET Standard				
GRUPPO TERMICO Maggiorato	CYLINDER KIT BIG BORE	CYLINDRE COMPLET Majoré				
KIT CUSCINETTI PARAOLI DI BANCO Serie	BEARINGS AND OIL SEALS KIT	KIT PALIERS JOINTS D'HUILE DE VILEBREQUIN Jeu				
KIT REVISIONE POMPA ACQUA	WATER PUMP REPAIR KIT	KIT RÉVISION POMPE À EAU		AA00828	AA00828	AA00824
KIT TAGLIANDO	SERVICE KIT	KIT COUPON		TG00101	TG00102	
MASSE CENTRIFUGHE PESO ORIGINALE	ROLLER WEIGHTS Standard weight	MASSELOTES CENTRIFUGES POIDS D'ORIGINE		9931880	9931880	
MEMBRANA CARBURATORE TIPO ORIGINALE	CARBURETOR DIAPHRAGM OEM	MEMBRANE CARBURATEUR TYPE ORIGINAL				
MEMBRANA CARBURATORE ADATTABILE	CARBURETOR DIAPHRAGM Adaptable	MEMBRANE CARBURATEUR ADAPTABLE				MC12106
MOLLE CONTRASTO VARIATORE	REAR VARIATOR SPRING	RESSORTS CONTRASTE VARIATEUR				9926780
MOLLA A GAS PER SELLA	SEAT GAS SPRING	RESSORT À GAZ POUR SELLE				
MOTORINO D'AVVIAMENTO	STARTER ENGINE	DÉMARREUR ÉLECTRIQUE		MA00016	MA00016	MA00030
POMPA BENZINA	FUEL PUMP	POMPE À ESSENCE				
REGOLATORE DI TENSIONE	RECTIFIER	RÉGULATEUR DE TENSION		RE00004	RE00004	RE00004
RUOTA LIBERA Completa	STARTER CLUTCH SET	ROUE LIBRE Complète				
RUOTA LIBERA RL + flangia	STARTER CLUTCH + FLANGE	ROUE LIBRE RL + flasque		RL00041	RL00021	RL00021
RUOTA LIBERA RL nuda	STARTER CLUTCH	ROUE LIBRE RL nue				
RUOTA LIBERA Ingranaggio	STARTER CLUTCH GEAR	ROUE LIBRE Engrenage		RL00023	RL00023	RL00023
RUOTA LIBERA Flangia	STARTER CLUTCH FLANGE	ROUE LIBRE Flasque				
SERIE DISCHI FRIZIONE	CLUTCH PLATES KIT	JEU DISQUES EMBRAYAGE				
STATORE	STATOR	STATOR		ST00023	ST00023	
VARIOTOP TPR	VARIOTOP TPR	VARIOTOP TPR			9923650	9923600

PIAGGIO	PIAGGIO	PIAGGIO	PIAGGIO	PIAGGIO	PIAGGIO	PIAGGIO	PIAGGIO	PIAGGIO	PIAGGIO	PIAGGIO	PIAGGIO
CARNABY	CARNABY	CARNABY CRUISER	FLY	FLY	FLY EU3	FLY EU3	FLY EU3	HEXAGON	HEXAGON	HEXAGON GT	HEXAGON GTX
07-08	08-09	09-12	05-07	05-07	07-07	08-11	08-11	94-97	94-97	98-00	00-00
200cc 4T LC	250cc 4T LC	300cc 4T LC	125cc 4T AC	150cc 4T AC	125cc 4T AC	125cc 4T AC	150cc 4T AC	125cc 2T LC	150cc 2T LC	250cc 4T LC	125cc 4T LC
Leader M601M		Piaggio M604M	Leader M422M	Leader M422M						Motore Honda	
			IM070701	IM070701	IM070701	IM070701	IM070701				IM070701
			IM070702	IM070702	IM070702	IM070702	IM070702				IM070702
	9927640	9927640	9927650	9927650	9927650	9927650	9927650	9915360	9915350	9915410	9927650
9935450								9935680	9935670		
			CT00736	CT00736	CT00736	CT00736	CT00736	CT00728	CT00728		CT00734
F007515	F007515	F007515	F007515	F007515	F007515	F007515	F007515				F007515
AA00826	AA00828	AA00828									AA00817
	TG00101	TG00102									
9932790	9931880	9931880									
											MC12002
MC12106			MC12107	MC12107	MC12107	MC12107	MC12107				
MA00012	MA00016	MA00016	MA00012	MA00012	MA00012	MA00012	MA00012				MA00012
RE00011	RE00004	RE00004	RE00011	RE00011	RE00011	RE00011	RE00011				RE00011
	RL00041	RL00021									
RL00022	RL00023		RL00022	RL00022	RL00022	RL00022	RL00022				RL00022
	ST00023	ST00023									
9923650	9923650	9923650	9923600	9923600							9923600

MAXI SCOOTER



PIAGGIO	PIAGGIO	PIAGGIO	PIAGGIO
HEXAGON GTX	HEXAGON LX	HEXAGON LX4	HEXAGON LXT180
00-00	98-99	98-99	98-99
180cc 4T LC	125cc 2T LC	125cc 4T AC	180cc 2T LC

IT	EN	FR				
ALBERO A CAMME	CAM SHAFT	ARBRE À CAMES				
ALBERO MOTORE Sel 1	Crankshaft Sel 1	VILEBREQUIN Sél 1				
ALBERO MOTORE Sel 2	Crankshaft Sel 2	VILEBREQUIN Sél 2				
BIELLA	CONROD	BIELLE				
CAMPANA FRIZIONE	CLUTCH HOUSING	CLOCHE EMBRAYAGE				
CINGHIA DI TRASMISSIONE Bando	TRANSMISSION BELT Bando	COURROIE DE TRANSMISSION Bando			9915360	9915340
CINGHIA DI TRASMISSIONE Mitsuboshi	TRANSMISSION BELT Mitsuboshi	COURROIE DE TRANSMISSION Mitsuboshi		9935920	9935680	9935430
CINGHIA DI TRASMISSIONE Altro	TRANSMISSION BELT Other	COURROIE DE TRANSMISSION Autres				
COLLETTORE ASPIRAZIONE	INLET MANIFOLD	COLLECTEUR ASPIRATION				CT00728
COLLETTORE ASPIRAZIONE SX	INLET MANIFOLD LEFT	COLLECTEUR ASPIRATION GAUCHE				
COLLETTORE ASPIRAZIONE DX	INLET MANIFOLD RIGHT	COLLECTEUR ASPIRATION DROITE				
FILTRO OLIO	OIL FILTER	FILTRE À HUILE		F007515		F007514
FRIZIONE	CLUTCH	EMBRAYAGE				
GRUPPO TERMICO Standard	CYLINDER KIT Ø standard	CYLINDRE COMPLET Standard				
GRUPPO TERMICO Maggiorato	CYLINDER KIT BIG BORE	CYLINDRE COMPLET Majoré				
KIT CUSCINETTI PARAOLI DI BANCO Serie	BEARINGS AND OIL SEALS KIT	KIT PALIERS JOINTS D'HUILE DE VILEBREQUIN Jeu				
KIT REVISIONE POMPA ACQUA	WATER PUMP REPAIR KIT	KIT RÉVISION POMPE À EAU		AA00817		
KIT TAGLIANDO	SERVICE KIT	KIT COUPON				
MASSE CENTRIFUGHE PESO ORIGINALE	ROLLER WEIGHTS Standard weight	MASSELOTES CENTRIFUGES POIDS D'ORIGINE		9932790		9922670
MEMBRANA CARBURATORE TIPO ORIGINALE	CARBURETOR DIAPHRAGM OEM	MEMBRANE CARBURATEUR TYPE ORIGINAL		MC12002		
MEMBRANA CARBURATORE ADATTABILE	CARBURETOR DIAPHRAGM Adaptable	MEMBRANE CARBURATEUR ADAPTABLE				
MOLLE CONTRASTO VARIATORE	REAR VARIATOR SPRING	RESSORTS CONTRASTE VARIATEUR				
MOLLA A GAS PER SELLA	SEAT GAS SPRING	RESSORT À GAZ POUR SELLE				
MOTORINO D'AVVIAMENTO	STARTER ENGINE	DÉMARREUR ÉLECTRIQUE		MA00012		
POMPA BENZINA	FUEL PUMP	POMPE À ESSENCE				
REGOLATORE DI TENSIONE	RECTIFIER	RÉGULATEUR DE TENSION				RE00012
RUOTA LIBERA Completa	STARTER CLUTCH SET	ROUE LIBRE Complète				
RUOTA LIBERA RL + flangia	STARTER CLUTCH + FLANGE	ROUE LIBRE RL + flasque				
RUOTA LIBERA RL nuda	STARTER CLUTCH	ROUE LIBRE RL nue				
RUOTA LIBERA Ingranaggio	STARTER CLUTCH GEAR	ROUE LIBRE Engrenage		RL00022		
RUOTA LIBERA Flangia	STARTER CLUTCH FLANGE	ROUE LIBRE Flasque				
SERIE DISCHI FRIZIONE	CLUTCH PLATES KIT	JEU DISQUES EMBRAYAGE				
STATORE	STATOR	STATOR				
VARIOTOP TPR	VARIOTOP TPR	VARIOTOP TPR				

PIAGGIO	PIAGGIO	PIAGGIO	PIAGGIO	PIAGGIO	PIAGGIO	PIAGGIO	PIAGGIO	PIAGGIO	PIAGGIO	PIAGGIO	PIAGGIO	
LIBERTY	LIBERTY	LIBERTY	LIBERTY	LIBERTY 4T	LIBERTY 4T 2V EURO3	LIBERTY 4T EU3	LIBERTY 4T EU3	LIBERTY 4T EU3	LIBERTY 4T EU3	LIBERTY 4T EU3 DELIVERY - SINGLE	LIBERTY 4T EU3 DELIVERY - TNT	LIBERTY 4T SPORT EU3
98-00	01-02	01-02	06-06	06-07	09-12	06-08	08-08	06-08	07-15	08-15	06-08	
125cc 4T AC	125cc 4T AC	150cc 4T AC	200cc 4T AC	125cc 4T AC	125cc 4T AC	125cc 4T AC	150cc 4T AC	200cc 4T AC	125cc 4T AC	125cc 4T AC	125cc 4T AC	
	Leader	Leader										
	IM070701	IM070701		IM070701		IM070701	IM070701			IM070701	IM070701	
	IM070702	IM070702		IM070702		IM070702	IM070702			IM070702	IM070702	
	9927650	9927650		9927650	9927650	9927650	9927650			9927650	9927650	
9935430			9935920					9935920				
CT00739	CT00740		CT00736	CT00736	CT00736					CT00736		
F007514	F007515	F007515	F007515	F007515	F007515	F007515		F007515		F007515	F007515	
				TG00100		TG00100	TG00100			TG00100	TG00100	
			9932790					9932790				
MC12002	MC12002	MC12002										
			MC12107	MC12107	MC12107	MC12107	MC12107	MC12107	MC12107	MC12107	MC12107	
	MA00012		MA00012	MA00012	MA00012	MA00012	MA00012	MA00012		MA00012	MA00012	
RE00012	RE00011		RE00011	RE00011		RE00011	RE00011	RE00011		RE00011	RE00011	
RL00022	RL00022	RL00022	RL00022	RL00022	RL00022	RL00022	RL00022	RL00022		RL00022	RL00022	
9923600	9923600	9923600	9923650									

MAXI SCOOTER

MAXI SCOOTER



PIAGGIO	PIAGGIO	PIAGGIO	PIAGGIO
LIBERTY 4T SPORT EU3	LIBERTY 4T SPORT EU3	LIBERTY MOC 4T	LIBERTY RST
08-08	06-07	09-13	04-05
150cc 4T AC	200cc 4T AC	150cc 4T AC	125cc 4T AC
	Leader		

IT	EN	FR				
ALBERO A CAMME	CAM SHAFT	ARBRE À CAMES				
ALBERO MOTORE Sel 1	Crankshaft Sel 1	VILEBREQUIN Sél 1		IM070701	IM070701	
ALBERO MOTORE Sel 2	Crankshaft Sel 2	VILEBREQUIN Sél 2		IM070702	IM070702	
BIELLA	CONROD	BIELLE				
CAMPANA FRIZIONE	CLUTCH HOUSING	CLOCHE EMBRAYAGE				
CINGHIA DI TRASMISSIONE Bando	TRANSMISSION BELT Bando	COURROIE DE TRANSMISSION Bando		9927650	9927650	9927650
CINGHIA DI TRASMISSIONE Mitsuboshi	TRANSMISSION BELT Mitsuboshi	COURROIE DE TRANSMISSION Mitsuboshi			9935920	
CINGHIA DI TRASMISSIONE Altro	TRANSMISSION BELT Other	COURROIE DE TRANSMISSION Autres				
COLLETTORE ASPIRAZIONE	INLET MANIFOLD	COLLECTEUR ASPIRATION			CT00736	CT00736
COLLETTORE ASPIRAZIONE SX	INLET MANIFOLD LEFT	COLLECTEUR ASPIRATION GAUCHE				
COLLETTORE ASPIRAZIONE DX	INLET MANIFOLD RIGHT	COLLECTEUR ASPIRATION DROITE				
FILTRO OLIO	OIL FILTER	FILTRE À HUILE		F007515	F007515	F007515
FRIZIONE	CLUTCH	EMBRAYAGE				
GRUPPO TERMICO Standard	CYLINDER KIT Ø standard	CYLINDRE COMPLET Standard				
GRUPPO TERMICO Maggiorato	CYLINDER KIT BIG BORE	CYLINDRE COMPLET Majoré				
KIT CUSCINETTI PARAOLI DI BANCO Serie	BEARINGS AND OIL SEALS KIT	KIT PALIERS JOINTS D'HUILE DE VILEBREQUIN Jeu				
KIT REVISIONE POMPA ACQUA	WATER PUMP REPAIR KIT	KIT RÉVISION POMPE À EAU				
KIT TAGLIANDO	SERVICE KIT	KIT COUPON		TG00100		
MASSE CENTRIFUGHE PESO ORIGINALE	ROLLER WEIGHTS Standard weight	MASSELOTES CENTRIFUGES POIDS D'ORIGINE			9932790	
MEMBRANA CARBURATORE TIPO ORIGINALE	CARBURETOR DIAPHRAGM OEM	MEMBRANE CARBURATEUR TYPE ORIGINAL				
MEMBRANA CARBURATORE ADATTABILE	CARBURETOR DIAPHRAGM Adaptable	MEMBRANE CARBURATEUR ADAPTABLE		MC12107	MC12107	MC12107
MOLLE CONTRASTO VARIATORE	REAR VARIATOR SPRING	RESSORTS CONTRASTE VARIATEUR				
MOLLA A GAS PER SELLA	SEAT GAS SPRING	RESSORT À GAZ POUR SELLE				
MOTORINO D'AVVIAMENTO	STARTER ENGINE	DÉMARREUR ÉLECTRIQUE		MA00012	MA00012	MA00012
POMPA BENZINA	FUEL PUMP	POMPE À ESSENCE				
REGOLATORE DI TENSIONE	RECTIFIER	RÉGULATEUR DE TENSION		RE00011	RE00011	RE00011
RUOTA LIBERA Completa	STARTER CLUTCH SET	ROUE LIBRE Complète				
RUOTA LIBERA RL + flangia	STARTER CLUTCH + FLANGE	ROUE LIBRE RL + flasque				
RUOTA LIBERA RL nuda	STARTER CLUTCH	ROUE LIBRE RL nue				
RUOTA LIBERA Ingranaggio	STARTER CLUTCH GEAR	ROUE LIBRE Engrenage		RL00022	RL00022	RL00022
RUOTA LIBERA Flangia	STARTER CLUTCH FLANGE	ROUE LIBRE Flasque				
SERIE DISCHI FRIZIONE	CLUTCH PLATES KIT	JEU DISQUES EMBRAYAGE				
STATORE	STATOR	STATOR				
VARIOTOP TPR	VARIOTOP TPR	VARIOTOP TPR			9923650	9923600

PIAGGIO	PIAGGIO	PIAGGIO	PIAGGIO	PIAGGIO	PIAGGIO	PIAGGIO	PIAGGIO	PIAGGIO	PIAGGIO	PIAGGIO	PIAGGIO
LIBERTY RST	LIBERTY RST PTT	LIBERTY SPORT	LIBERTY SPORT	MP3	MP3	MP3	MP3 4T 4V IERL IBRIDO	MP3 4T 4V IELT IBRIDO	MP3 IBRIDO	MP3 IE	MP3 IELT
04-04	05-11	06-06	06-06	06-08	06-08	07-08	10-13	10-11	09-10	08-09	10-11
200cc 4T AC	125cc 4T AC	125cc 4T AC	200cc 4T AC	125cc 4T LC	250cc 4T LC	400cc 4T LC	300cc 4T-4V LC	300cc 4T LC	125cc 4T LC	125cc 4T LC	300cc 4T LC
				Piaggio M631M	Quasar M472M	Piaggio M474M					
	IM070701	IM070701		IM070701							
	IM070702	IM070702		IM070702							
	9927650	9927650		9927650		9927630			9927650	9927650	
9935920			9935920		9935470		9935470	9935470			9935470
CT00736		CT00736	CT00736								
F007515	F007515	F007515	F007515	F007515	F007515	F007524		F007515	F007515	F007515	F007515
				AA00826	AA00828	AA00824		AA00828			AA00828
		TG00100		TG00111					TG00111	TG00111	
9932790			9932790					9931880			9931880
	MC12107	MC12107	MC12107	MC12106							
							9926780				
MA00012		MA00012	MA00012	MA00012	MA00016	MA00030					
RE00011		RE00011	RE00011	RE00011	RE00004	RE00004			RE00004	RE00004	
					RL00041	RL00021		RL00021	RL00041	RL00041	RL00021
RL00022	RL00022	RL00022	RL00022	RL00022	RL00023	RL00023		RL00023	RL00023	RL00023	RL00023
					ST00023				ST00023	ST00023	
9923600				9923600	9923650			9923650	9923600	9923600	9923650



PIAGGIO	PIAGGIO	PIAGGIO	PIAGGIO
MP3 IE LT TOURING	MP3 IE LT TOURING	MP3 IE LT/ SPORT	MP3 IE LT/ SPORT
11-13	11-11	11-14	08-10
300cc 4T LC	400cc 4T LC	300cc 4T LC	400cc 4T LC

IT	EN	FR				
ALBERO A CAMME	CAM SHAFT	ARBRE À CAMES				
ALBERO MOTORE Sel 1	Crankshaft Sel 1	VILEBREQUIN Sél 1				
ALBERO MOTORE Sel 2	Crankshaft Sel 2	VILEBREQUIN Sél 2				
BIELLA	CONROD	BIELLE				
CAMPANA FRIZIONE	CLUTCH HOUSING	CLOCHE EMBRAYAGE				
CINGHIA DI TRASMISSIONE Bando	TRANSMISSION BELT Bando	COURROIE DE TRANSMISSION Bando		9927630		9927630
CINGHIA DI TRASMISSIONE Mitsuboshi	TRANSMISSION BELT Mitsuboshi	COURROIE DE TRANSMISSION Mitsuboshi		9935470		9935470
CINGHIA DI TRASMISSIONE Altro	TRANSMISSION BELT Other	COURROIE DE TRANSMISSION Autres				
COLLETTORE ASPIRAZIONE	INLET MANIFOLD	COLLECTEUR ASPIRATION				
COLLETTORE ASPIRAZIONE SX	INLET MANIFOLD LEFT	COLLECTEUR ASPIRATION GAUCHE				
COLLETTORE ASPIRAZIONE DX	INLET MANIFOLD RIGHT	COLLECTEUR ASPIRATION DROITE				
FILTRO OLIO	OIL FILTER	FILTRE À HUILE		F007515	F007524	F007515 F007524
FRIZIONE	CLUTCH	EMBRAYAGE				
GRUPPO TERMICO Standard	CYLINDER KIT Ø standard	CYLINDRE COMPLET Standard				
GRUPPO TERMICO Maggiorato	CYLINDER KIT BIG BORE	CYLINDRE COMPLET Majoré				
KIT CUSCINETTI PARAOLI DI BANCO Serie	BEARINGS AND OIL SEALS KIT	KIT PALIERS JOINTS D'HUILE DE VILEBREQUIN Jeu				
KIT REVISIONE POMPA ACQUA	WATER PUMP REPAIR KIT	KIT RÉVISION POMPE À EAU		AA00828	AA00824	AA00828 AA00824
KIT TAGLIANDO	SERVICE KIT	KIT COUPON				
MASSE CENTRIFUGHE PESO ORIGINALE	ROLLER WEIGHTS Standard weight	MASSELOTES CENTRIFUGES POIDS D'ORIGINE		9931880		9931880
MEMBRANA CARBURATORE TIPO ORIGINALE	CARBURETOR DIAPHRAGM OEM	MEMBRANE CARBURATEUR TYPE ORIGINAL				
MEMBRANA CARBURATORE ADATTABILE	CARBURETOR DIAPHRAGM Adaptable	MEMBRANE CARBURATEUR ADAPTABLE				
MOLLE CONTRASTO VARIATORE	REAR VARIATOR SPRING	RESSORTS CONTRASTE VARIATEUR			9926780	9926780
MOLLA A GAS PER SELLA	SEAT GAS SPRING	RESSORT À GAZ POUR SELLE				
MOTORINO D'AVVIAMENTO	STARTER ENGINE	DÉMARREUR ÉLECTRIQUE			MA00030	MA00030
POMPA BENZINA	FUEL PUMP	POMPE À ESSENCE				
REGOLATORE DI TENSIONE	RECTIFIER	RÉGULATEUR DE TENSION			RE00004	RE00004
RUOTA LIBERA Completa	STARTER CLUTCH SET	ROUE LIBRE Complète				
RUOTA LIBERA RL + flangia	STARTER CLUTCH + FLANGE	ROUE LIBRE RL + flasque		RL00021	RL00021	RL00021 RL00021
RUOTA LIBERA RL nuda	STARTER CLUTCH	ROUE LIBRE RL nue				
RUOTA LIBERA Ingranaggio	STARTER CLUTCH GEAR	ROUE LIBRE Engrenage		RL00023	RL00023	RL00023 RL00023
RUOTA LIBERA Flangia	STARTER CLUTCH FLANGE	ROUE LIBRE Flasque				
SERIE DISCHI FRIZIONE	CLUTCH PLATES KIT	JEU DISQUES EMBRAYAGE				
STATORE	STATOR	STATOR				
VARIOTOP TPR	VARIOTOP TPR	VARIOTOP TPR		9923650		9923650

PIAGGIO	PIAGGIO	PIAGGIO	PIAGGIO	PIAGGIO	PIAGGIO	PIAGGIO	PIAGGIO	PIAGGIO	PIAGGIO	PIAGGIO	PIAGGIO
MP3 IE MIC	MP3 IE MIC	MP3 IE TOURING	MP3 IE TOURING	MP3 LT	MP3 LT BUSINESS - SPORT ABS - ENJOY	MP3 LT BUSINESS ABS	MP3 LT E4 SPORT/BUSINESS	MP3 LT SPORT/BUSINESS	MP3 MIC	MP3 MIC	MP3 RL SPORT-BUSINESS
10-10	11-11	11-12	11-12	08-09	14-15	14-16	16-17	11-13	08-09	08-10	11-12
300cc 4T LC	300cc 4T LC	125cc 4T LC	300cc 4T LC	250cc 4T LC	300cc 4T LC	500cc 4T LC	500cc 4T LC	500cc 4T LC	250cc 4T LC	400cc 4T LC	500cc 4T LC
		9927650								9927630	
9935470	9935470		9935470	9935470	9935470	9935500		9935500	9935470		9935500
F007515	F007515	F007515	F007515	F007515		F007524		F007524	F007515	F007524	F007524
AA00828	AA00828		AA00828	AA00828				AA00824	AA00828	AA00824	AA00824
		TG00111						TG00112			TG00112
9931880	9931880		9931880					9935990			9935990
								9926780		9926780	9926780
				MA00016		MA00030	MA00030	MA00030	MA00016	MA00030	MA00030
				RE00004				RE00004	RE00004	RE00004	RE00004
RL00021	RL00021	RL00041	RL00021	RL00041				RL00021	RL00041	RL00021	RL00021
RL00023	RL00023	RL00023	RL00023	RL00023				RL00023	RL00023	RL00023	RL00023
				ST00023					ST00023		
9923650	9923650	9923600	9923650	9923650		9923250		9923250	9923650		9923250



PIAGGIO	PIAGGIO	PIAGGIO	PIAGGIO
MP3 RL TOURING	MP3 SPORT ABS	MP3 YOURBAN ERL	MP3 YOURBAN ERL
11-11	14-16	11-13	11-15
400cc 4T LC	500cc 4T LC	125cc 4T LC	300cc 4T LC

IT	EN	FR				
ALBERO A CAMME	CAM SHAFT	ARBRE À CAMES				
ALBERO MOTORE Sel 1	Crankshaft Sel 1	VILEBREQUIN Sél 1				
ALBERO MOTORE Sel 2	Crankshaft Sel 2	VILEBREQUIN Sél 2				
BIELLA	CONROD	BIELLE				
CAMPANA FRIZIONE	CLUTCH HOUSING	CLOCHE EMBRAYAGE				
CINGHIA DI TRASMISSIONE Bando	TRANSMISSION BELT Bando	COURROIE DE TRANSMISSION Bando		9927630		9927650
CINGHIA DI TRASMISSIONE Mitsuboshi	TRANSMISSION BELT Mitsuboshi	COURROIE DE TRANSMISSION Mitsuboshi			9935500	9935470
CINGHIA DI TRASMISSIONE Altro	TRANSMISSION BELT Other	COURROIE DE TRANSMISSION Autres				
COLLETTORE ASPIRAZIONE	INLET MANIFOLD	COLLECTEUR ASPIRATION				
COLLETTORE ASPIRAZIONE SX	INLET MANIFOLD LEFT	COLLECTEUR ASPIRATION GAUCHE				
COLLETTORE ASPIRAZIONE DX	INLET MANIFOLD RIGHT	COLLECTEUR ASPIRATION DROITE				
FILTRO OLIO	OIL FILTER	FILTRE À HUILE		F007524	F007524	F007515 F007515
FRIZIONE	CLUTCH	EMBRAYAGE				
GRUPPO TERMICO Standard	CYLINDER KIT Ø standard	CYLINDRE COMPLET Standard				
GRUPPO TERMICO Maggiorato	CYLINDER KIT BIG BORE	CYLINDRE COMPLET Majoré				
KIT CUSCINETTI PARAOLI DI BANCO Serie	BEARINGS AND OIL SEALS KIT	KIT PALIERS JOINTS D'HUILE DE VILEBREQUIN Jeu				
KIT REVISIONE POMPA ACQUA	WATER PUMP REPAIR KIT	KIT RÉVISION POMPE À EAU		AA00824		AA00828
KIT TAGLIANDO	SERVICE KIT	KIT COUPON				
MASSE CENTRIFUGHE PESO ORIGINALE	ROLLER WEIGHTS Standard weight	MASSELOTES CENTRIFUGES POIDS D'ORIGINE				9931880
MEMBRANA CARBURATORE TIPO ORIGINALE	CARBURETOR DIAPHRAGM OEM	MEMBRANE CARBURATEUR TYPE ORIGINAL				
MEMBRANA CARBURATORE ADATTABILE	CARBURETOR DIAPHRAGM Adaptable	MEMBRANE CARBURATEUR ADAPTABLE				
MOLLE CONTRASTO VARIATORE	REAR VARIATOR SPRING	RESSORTS CONTRASTE VARIATEUR		9926780		
MOLLA A GAS PER SELLA	SEAT GAS SPRING	RESSORT À GAZ POUR SELLE				
MOTORINO D'AVVIAMENTO	STARTER ENGINE	DÉMARREUR ÉLECTRIQUE		MA00030	MA00030	
POMPA BENZINA	FUEL PUMP	POMPE À ESSENCE				
REGOLATORE DI TENSIONE	RECTIFIER	RÉGULATEUR DE TENSION		RE00004		
RUOTA LIBERA Completa	STARTER CLUTCH SET	ROUE LIBRE Complète				
RUOTA LIBERA RL + flangia	STARTER CLUTCH + FLANGE	ROUE LIBRE RL + flasque		RL00021		
RUOTA LIBERA RL nuda	STARTER CLUTCH	ROUE LIBRE RL nue				
RUOTA LIBERA Ingranaggio	STARTER CLUTCH GEAR	ROUE LIBRE Engrenage		RL00023	RL00023	RL00023
RUOTA LIBERA Flangia	STARTER CLUTCH FLANGE	ROUE LIBRE Flasque				
SERIE DISCHI FRIZIONE	CLUTCH PLATES KIT	JEU DISQUES EMBRAYAGE				
STATORE	STATOR	STATOR				
VARIOTOP TPR	VARIOTOP TPR	VARIOTOP TPR			9923250	9923600 9923650

PIAGGIO	PIAGGIO	PIAGGIO	PIAGGIO	PIAGGIO	PIAGGIO	PIAGGIO	PIAGGIO	PIAGGIO	PIAGGIO	PIAGGIO	PIAGGIO
MP3 YOURBAN L T E R L	SFERA	SKIPPER LX	SKIPPER LX	SKYPPER	SKYPPER	SKYPPER 4T	SKYPPER 4T	SUPER HEXAGON GTX 12	SUPER HEXAGON GTX 12	TYPHOON 4T 2V E3	X-EVO
11-12	95-97	98-99	98-99	94-97	94-97	00-02	00-02	01-02	01-02	10-11	07-16
300cc 4T LC	125cc 4T AC	125cc 2T AC	150cc 2T AC	125cc 2T AC	150cc 2T AC	125cc 4T AC	150cc 4T AC	125cc 4T LC	180cc 4T LC	125cc 4T AC	125cc 4T LC
						IM070701				IM070701	IM070701
						IM070702				IM070702	IM070702
	9915370	9915350	9915350	9915360	9915350	9927650	9927650	9927650		9927650	9927650
9935470	9935690	9935670	9935670	9935680	9935670				9935920		
	CT00739			CT00728	CT00728	CT00740	CT00740	CT00734		CT00736	
F007515	F007514					F007515	F007515	F007515	F007515	F007515	F007515
AA00828								AA00817	AA00817		AA00826
											TG00111
9931880									9932790		
						MC12002	MC12002				
											MC12106
						MA00012	MA00012	MA00012	MA00012	MA00012	MA00012
	RE00009					RE00011		RE00011	RE00011	RE00011	RE00011
RL00023						RL00022	RL00022	RL00022	RL00022	RL00022	RL00022
9923650						9923600	9923600	9923600	9923600		9923600

MAXI SCOOTER



PIAGGIO	PIAGGIO	PIAGGIO	PIAGGIO
X-EVO	X-EVO	X10 4T 4V EU3	X10 4T 4V IE EURO3
07-16	07-11	12-15	12-15
250cc 4T LC	400cc 4T LC	125cc 4T-4V LC	350cc 4T LC
	Piaggio M521M		Piaggio

IT	EN	FR				
ALBERO A CAMME	CAM SHAFT	ARBRE À CAMES				
ALBERO MOTORE Sel 1	Crankshaft Sel 1	VILEBREQUIN Sél 1				
ALBERO MOTORE Sel 2	Crankshaft Sel 2	VILEBREQUIN Sél 2				
BIELLA	CONROD	BIELLE				
CAMPANA FRIZIONE	CLUTCH HOUSING	CLOCHE EMBRAYAGE				
CINGHIA DI TRASMISSIONE Bando	TRANSMISSION BELT Bando	COURROIE DE TRANSMISSION Bando			9927630	9928540
CINGHIA DI TRASMISSIONE Mitsuboshi	TRANSMISSION BELT Mitsuboshi	COURROIE DE TRANSMISSION Mitsuboshi		9935470		9935490
CINGHIA DI TRASMISSIONE Altro	TRANSMISSION BELT Other	COURROIE DE TRANSMISSION Autres				
COLLETTORE ASPIRAZIONE	INLET MANIFOLD	COLLECTEUR ASPIRATION				
COLLETTORE ASPIRAZIONE SX	INLET MANIFOLD LEFT	COLLECTEUR ASPIRATION GAUCHE				
COLLETTORE ASPIRAZIONE DX	INLET MANIFOLD RIGHT	COLLECTEUR ASPIRATION DROITE				
FILTRO OLIO	OIL FILTER	FILTRE À HUILE		F007515	F007524	
FRIZIONE	CLUTCH	EMBAYAGE				
GRUPPO TERMICO Standard	CYLINDER KIT Ø standard	CYLINDRE COMPLET Standard				
GRUPPO TERMICO Maggiorato	CYLINDER KIT BIG BORE	CYLINDRE COMPLET Majoré				
KIT CUSCINETTI PARAOLI DI BANCO Serie	BEARINGS AND OIL SEALS KIT	KIT PALIERS JOINTS D'HUILE DE VILEBREQUIN Jeu				
KIT REVISIONE POMPA ACQUA	WATER PUMP REPAIR KIT	KIT RÉVISION POMPE À EAU		AA00828	AA00824	AA00829
KIT TAGLIANDO	SERVICE KIT	KIT COUPON				
MASSE CENTRIFUGHE PESO ORIGINALE	ROLLER WEIGHTS Standard weight	MASSELOTES CENTRIFUGES POIDS D'ORIGINE			9924530	
MEMBRANA CARBURATORE TIPO ORIGINALE	CARBURETOR DIAPHRAGM OEM	MEMBRANE CARBURATEUR TYPE ORIGINAL				
MEMBRANA CARBURATORE ADATTABILE	CARBURETOR DIAPHRAGM Adaptable	MEMBRANE CARBURATEUR ADAPTABLE				
MOLLE CONTRASTO VARIATORE	REAR VARIATOR SPRING	RESSORTS CONTRASTE VARIATEUR			9926780	
MOLLA A GAS PER SELLA	SEAT GAS SPRING	RESSORT À GAZ POUR SELLE				
MOTORINO D'AVVIAMENTO	STARTER ENGINE	DÉMARREUR ÉLECTRIQUE		MA00016	MA00030	
POMPA BENZINA	FUEL PUMP	POMPE À ESSENCE				
REGOLATORE DI TENSIONE	RECTIFIER	RÉGULATEUR DE TENSION		RE00004	RE00004	
RUOTA LIBERA Completa	STARTER CLUTCH SET	ROUE LIBRE Complète				
RUOTA LIBERA RL + flangia	STARTER CLUTCH + FLANGE	ROUE LIBRE RL + flasque		RL00041	RL00021	RL00021
RUOTA LIBERA RL nuda	STARTER CLUTCH	ROUE LIBRE RL nue				
RUOTA LIBERA Ingranaggio	STARTER CLUTCH GEAR	ROUE LIBRE Engrenage		RL00023	RL00023	RL00023
RUOTA LIBERA Flangia	STARTER CLUTCH FLANGE	ROUE LIBRE Flasque				
SERIE DISCHI FRIZIONE	CLUTCH PLATES KIT	JEU DISQUES EMBRAYAGE				9931020
STATORE	STATOR	STATOR		ST00023	ST00005	
VARIOTOP TPR	VARIOTOP TPR	VARIOTOP TPR		9923650		

PIAGGIO	PIAGGIO	PIAGGIO	PIAGGIO	PIAGGIO	PIAGGIO	PIAGGIO	PIAGGIO	PIAGGIO	PIAGGIO	PIAGGIO	PIAGGIO
X10 4T-4V IE EU3	X7 EU3	X7 EU3	X7 EVO IE EU3	X7 EVO IE EU3	X8	X8	X8	X8	X8 EU3	X8 EU3	X8 PREMIUM EU2
12-14	08-08	08-08	09-10	09-10	04-04	05-06	04-04	05-07	05-08	06-08	06-06
500cc 4T LC	125cc 4T LC	250cc 4T LC	125cc 4T LC	300cc 4T LC	125cc 4T LC	125cc 4T LC	200cc 4T LC	200cc 4T LC	250cc 4T LC	400cc 4T LC	125cc 4T LC
	Leader	Piaggio M622M		Piaggio M624M	Leader				Quasar	Piaggio M521M	
	IM070701				IM070701	IM070701					IM070701
	IM070702				IM070702	IM070702					IM070702
	9927650		9927650		9927650	9927650				9927630	9927650
9935500		9935470		9935470			9935920	9935920	9935470		
					CT00735	CT00735	CT00735	CT00735			CT00735
F007524	F007515	F007515	F007515	F007515	F007515	F007515	F007515	F007515	F007515	F007515	F007515
	AA00826	AA00828		AA00828	AA00817	AA00826	AA00817	AA00826	AA00828		AA00826
TG00112											TG00111
9935990				9931880			9932790	9932790		9924530	
	MC12106					MC12106		MC12106			MC12106
										9926780	
MA00030	MA00012	MA00016	MA00016	MA00016	MA00012	MA00012		MA00012	MA00016	MA00030	MA00012
	RE00011	RE00004			RE00011	RE00011		RE00011	RE00004	RE00004	RE00011
		RL00041	RL00041	RL00021					RL00041	RL00021	
	RL00022	RL00023	RL00023	RL00023	RL00022	RL00022	RL00022	RL00022	RL00023	RL00023	RL00022
		ST00023							ST00023	ST00005	
9923250	9923600	9923650	9923600	9923650	9923600	9923600	9923650	9923650	9923650		9923600

MAXI SCOOTER



PIAGGIO	PIAGGIO	PIAGGIO	PIAGGIO
X8 PREMIUM EU3	X8 STREET EU2	X8 STREET EU2	X9
06-07	06-07	06-08	01-02
125cc 4T LC	125cc 4T AC	150cc 4T AC	125cc 4T LC

IT	EN	FR				
ALBERO A CAMME	CAM SHAFT	ARBRE À CAMES				
ALBERO MOTORE Sel 1	Crankshaft Sel 1	VILEBREQUIN Sél 1		IM070701	IM070701	IM070701
ALBERO MOTORE Sel 2	Crankshaft Sel 2	VILEBREQUIN Sél 2		IM070702	IM070702	IM070702
BIELLA	CONROD	BIELLE				
CAMPANA FRIZIONE	CLUTCH HOUSING	CLOCHE EMBRAYAGE				
CINGHIA DI TRASMISSIONE Bando	TRANSMISSION BELT Bando	COURROIE DE TRANSMISSION Bando		9927650	9927650	9927650
CINGHIA DI TRASMISSIONE Mitsuboshi	TRANSMISSION BELT Mitsuboshi	COURROIE DE TRANSMISSION Mitsuboshi				
CINGHIA DI TRASMISSIONE Altro	TRANSMISSION BELT Other	COURROIE DE TRANSMISSION Autres				
COLLETTORE ASPIRAZIONE	INLET MANIFOLD	COLLECTEUR ASPIRATION			CT00736	CT00736
COLLETTORE ASPIRAZIONE SX	INLET MANIFOLD LEFT	COLLECTEUR ASPIRATION GAUCHE				
COLLETTORE ASPIRAZIONE DX	INLET MANIFOLD RIGHT	COLLECTEUR ASPIRATION DROITE				
FILTRO OLIO	OIL FILTER	FILTRE À HUILE		F007515	F007515	F007515
FRIZIONE	CLUTCH	EMBRAYAGE				
GRUPPO TERMICO Standard	CYLINDER KIT Ø standard	CYLINDRE COMPLET Standard				
GRUPPO TERMICO Maggiorato	CYLINDER KIT BIG BORE	CYLINDRE COMPLET Majoré				
KIT CUSCINETTI PARAOLI DI BANCO Serie	BEARINGS AND OIL SEALS KIT	KIT PALIERS JOINTS D'HUILE DE VILEBREQUIN Jeu				
KIT REVISIONE POMPA ACQUA	WATER PUMP REPAIR KIT	KIT RÉVISION POMPE À EAU		AA00826		AA00817
KIT TAGLIANDO	SERVICE KIT	KIT COUPON		TG00111		
MASSE CENTRIFUGHE PESO ORIGINALE	ROLLER WEIGHTS Standard weight	MASSELOTTE CENTRIFUGES POIDS D'ORIGINE				
MEMBRANA CARBURATORE TIPO ORIGINALE	CARBURETOR DIAPHRAGM OEM	MEMBRANE CARBURATEUR TYPE ORIGINAL				MC12002
MEMBRANA CARBURATORE ADATTABILE	CARBURETOR DIAPHRAGM Adaptable	MEMBRANE CARBURATEUR ADAPTABLE		MC12106	MC12107	MC12107
MOLLE CONTRASTO VARIATORE	REAR VARIATOR SPRING	RESSORTS CONTRASTE VARIATEUR				
MOLLA A GAS PER SELLA	SEAT GAS SPRING	RESSORT À GAZ POUR SELLE				
MOTORINO D'AVVIAMENTO	STARTER ENGINE	DÉMARREUR ÉLECTRIQUE		MA00012	MA00012	MA00012
POMPA BENZINA	FUEL PUMP	POMPE À ESSENCE				
REGOLATORE DI TENSIONE	RECTIFIER	RÉGULATEUR DE TENSION		RE00011	RE00011	RE00011
RUOTA LIBERA Completa	STARTER CLUTCH SET	ROUE LIBRE Complète				
RUOTA LIBERA RL + flangia	STARTER CLUTCH + FLANGE	ROUE LIBRE RL + flasque				
RUOTA LIBERA RL nuda	STARTER CLUTCH	ROUE LIBRE RL nue				
RUOTA LIBERA Ingranaggio	STARTER CLUTCH GEAR	ROUE LIBRE Engrenage		RL00022	RL00022	RL00022
RUOTA LIBERA Flangia	STARTER CLUTCH FLANGE	ROUE LIBRE Flasque				
SERIE DISCHI FRIZIONE	CLUTCH PLATES KIT	JEU DISQUES EMBRAYAGE				
STATORE	STATOR	STATOR				
VARIOTOP TPR	VARIOTOP TPR	VARIOTOP TPR		9923600	9923600	9923600

PIAGGIO	PIAGGIO	PIAGGIO	PIAGGIO	PIAGGIO	PIAGGIO	PIAGGIO	PIAGGIO	PIAGGIO	PIAGGIO	PIAGGIO	PIAGGIO
X9	X9	X9	X9 AMALFI	X9 EVOLUTION	X9 EVOLUTION	X9 EVOLUTION	X9 EVOLUTION	X9 EVOLUTION	X9 EVOLUTION	X9 EVOLUTION	X9 EVOLUTION ABS
02-03	00-01	01-02	00-03	03-03	05-06	03-03	04-04	06-06	03-05	06-07	06-07
200cc 4T LC	250cc 4T LC	500cc 4T LC	180cc 4T LC	125cc 4T LC	125cc 4T LC	200cc 4T LC	250cc 4T LC	250cc 4T LC	500cc 4T LC	500cc 4T LC	500cc 4T LC
	Motore Honda						Piaggio M237M		Piaggio	Piaggio	Piaggio
				IM070701	IM070701						
				IM070702	IM070702						
	9917990			9927650	9927650				9927630	9927630	9927630
9935920	9935720	9935460	9935920			9935920	9935470	9935470			
CT00734			CT00734	CT00734	CT00735	CT00734	CT00735	CT00735			
F007515		F007524	F007515	F007515	F007515	F007515	F007515	F007515	F007515	F007524	F007524
AA00817			AA00817	AA00817	AA00826	AA00817		AA00828			
9932790		9922330	9932790			9932790			9922330	9935990	9935990
					MC12106		MC12106	MC12106			
		9926780							9926780	9926780	9926780
MA00012		MA00030	MA00012	MA00012	MA00012	MA00012	MA00016	MA00016	MA00030	MA00030	MA00030
RE00011		RE00004	RE00011	RE00011	RE00011	RE00011	RE00011	RE00011	RE00004	RE00004	RE00004
		RL00021					RL00021	RL00021	RL00021	RL00021	RL00021
RL00022		RL00023	RL00022	RL00022	RL00022	RL00022	RL00023	RL00023	RL00023	RL00023	RL00023
		ST00005							ST00005	ST00005	ST00005
9923650		9923250		9923600	9923600		9923650	9923650	9923250	9923250	9923250

MAXI SCOOTER



PIAGGIO	PIAGGIO	RENAULT	SUZUKI
X9 EVOLUTION EU3	ZIP	FULLTIME	AN BURGMAN K1/K2
07-07	00-02	02-03	01-02
125cc 4T LC	125cc 4T AC	125cc 4T AC	250cc 4T LC
	Leader	Leader	

IT	EN	FR				
ALBERO A CAMME	CAM SHAFT	ARBRE À CAMES				
ALBERO MOTORE Sel 1	Crankshaft Sel 1	VILEBREQUIN Sél 1		IM070701	IM070701	
ALBERO MOTORE Sel 2	Crankshaft Sel 2	VILEBREQUIN Sél 2		IM070702	IM070702	
BIELLA	CONROD	BIELLE				
CAMPANA FRIZIONE	CLUTCH HOUSING	CLOCHE EMBRAYAGE				
CINGHIA DI TRASMISSIONE Bando	TRANSMISSION BELT Bando	COURROIE DE TRANSMISSION Bando		9927650	9927650	9927650
CINGHIA DI TRASMISSIONE Mitsuboshi	TRANSMISSION BELT Mitsuboshi	COURROIE DE TRANSMISSION Mitsuboshi				9935510
CINGHIA DI TRASMISSIONE Altro	TRANSMISSION BELT Other	COURROIE DE TRANSMISSION Autres				
COLLETTORE ASPIRAZIONE	INLET MANIFOLD	COLLECTEUR ASPIRATION			CT00740	
COLLETTORE ASPIRAZIONE SX	INLET MANIFOLD LEFT	COLLECTEUR ASPIRATION GAUCHE				
COLLETTORE ASPIRAZIONE DX	INLET MANIFOLD RIGHT	COLLECTEUR ASPIRATION DROITE				
FILTRO OLIO	OIL FILTER	FILTRE À HUILE		F007515	F007515	F007515
FRIZIONE	CLUTCH	EMBRAYAGE				
GRUPPO TERMICO Standard	CYLINDER KIT Ø standard	CYLINDRE COMPLET Standard				
GRUPPO TERMICO Maggiorato	CYLINDER KIT BIG BORE	CYLINDRE COMPLET Majoré				
KIT CUSCINETTI PARAOLI DI BANCO Serie	BEARINGS AND OIL SEALS KIT	KIT PALIERS JOINTS D'HUILE DE VILEBREQUIN Jeu				
KIT REVISIONE POMPA ACQUA	WATER PUMP REPAIR KIT	KIT RÉVISION POMPE À EAU		AA00826		AA00817
KIT TAGLIANDO	SERVICE KIT	KIT COUPON		TG00111		
MASSE CENTRIFUGHE PESO ORIGINALE	ROLLER WEIGHTS Standard weight	MASSELOTTE CENTRIFUGES POIDS D'ORIGINE				
MEMBRANA CARBURATORE TIPO ORIGINALE	CARBURETOR DIAPHRAGM OEM	MEMBRANE CARBURATEUR TYPE ORIGINAL			MC12002	
MEMBRANA CARBURATORE ADATTABILE	CARBURETOR DIAPHRAGM Adaptable	MEMBRANE CARBURATEUR ADAPTABLE		MC12106		
MOLLE CONTRASTO VARIATORE	REAR VARIATOR SPRING	RESSORTS CONTRASTE VARIATEUR				
MOLLA A GAS PER SELLA	SEAT GAS SPRING	RESSORT À GAZ POUR SELLE				
MOTORINO D'AVVIAMENTO	STARTER ENGINE	DÉMARREUR ÉLECTRIQUE		MA00012	MA00012	MA00021
POMPA BENZINA	FUEL PUMP	POMPE À ESSENCE				
REGOLATORE DI TENSIONE	RECTIFIER	RÉGULATEUR DE TENSION		RE00011	RE00011	
RUOTA LIBERA Completa	STARTER CLUTCH SET	ROUE LIBRE Complète				RL00018
RUOTA LIBERA RL + flangia	STARTER CLUTCH + FLANGE	ROUE LIBRE RL + flasque				
RUOTA LIBERA RL nuda	STARTER CLUTCH	ROUE LIBRE RL nue				
RUOTA LIBERA Ingranaggio	STARTER CLUTCH GEAR	ROUE LIBRE Engrenage		RL00022	RL00022	
RUOTA LIBERA Flangia	STARTER CLUTCH FLANGE	ROUE LIBRE Flasque				
SERIE DISCHI FRIZIONE	CLUTCH PLATES KIT	JEU DISQUES EMBRAYAGE				
STATORE	STATOR	STATOR				
VARIOTOP TPR	VARIOTOP TPR	VARIOTOP TPR		9923600	9923600	9923600

SUZUKI	SUZUKI	SUZUKI	SUZUKI	SUZUKI	SUZUKI	SUZUKI	SUZUKI	SUZUKI	SUZUKI	SUZUKI	SUZUKI
AN BURGMAN K3-K5	AN BURGMAN K3/K6	AN BURGMAN K3/K6	AN BURGMAN K6-L0	AN BURGMAN K7/L0	AN BURGMAN L1	AN BURGMAN L1	AN BURGMAN L2	AN BURGMAN L2	AN BURGMAN L3	AN BURGMAN L3	AN BURGMAN L4
03-05	03-06	03-06	06-10	07-10	11-11	11-11	12-12	12-12	13-13	13-13	14-14
650cc 4T LC	250cc 4T LC	400cc 4T LC	650cc 4T LC	400cc 4T LC	400cc 4T LC	650cc 4T LC	400cc 4T LC	650cc 4T LC	400cc 4T LC	650cc 4T LC	400cc 4T LC
	IM07050										
	9915790	9920430		9927660	9927660		9927660		9927660		9927660
		9935730									
F007511	F007510	F007510		F007522	F007522		F007522		F007522		F007522
	KK01006	KK01006		KK01006							
	AA00819	AA00819									
TG00119			TG00119	TG00104	TG00104	TG00119	TG00104	TG00119	TG00104	TG00119	TG00104
		9918410		9922390							
		9926790		9926790							
				9980260	9980260		9980260		9980260		9980260
	MA00021	MA00021									
	RL00018	RL00012									
	9923790			9926010							



SUZUKI	SUZUKI	SUZUKI	SUZUKI
AN BURGMAN L4	AN BURGMAN L5	AN BURGMAN L5	AN BURGMAN L6
14-14	15-15	15-15	16-16
650cc 4T LC	400cc 4T LC	650cc 4T LC	400cc 4T LC

IT	EN	FR				
ALBERO A CAMME	CAM SHAFT	ARBRE À CAMES				
ALBERO MOTORE Sel 1	Crankshaft Sel 1	VILEBREQUIN Sél 1				
ALBERO MOTORE Sel 2	Crankshaft Sel 2	VILEBREQUIN Sél 2				
BIELLA	CONROD	BIELLE				
CAMPANA FRIZIONE	CLUTCH HOUSING	CLOCHE EMBRAYAGE				
CINGHIA DI TRASMISSIONE Bando	TRANSMISSION BELT Bando	COURROIE DE TRANSMISSION Bando			9927660	9927660
CINGHIA DI TRASMISSIONE Mitsuboshi	TRANSMISSION BELT Mitsuboshi	COURROIE DE TRANSMISSION Mitsuboshi				
CINGHIA DI TRASMISSIONE Altro	TRANSMISSION BELT Other	COURROIE DE TRANSMISSION Autres				
COLLETTORE ASPIRAZIONE	INLET MANIFOLD	COLLECTEUR ASPIRATION				
COLLETTORE ASPIRAZIONE SX	INLET MANIFOLD LEFT	COLLECTEUR ASPIRATION GAUCHE				
COLLETTORE ASPIRAZIONE DX	INLET MANIFOLD RIGHT	COLLECTEUR ASPIRATION DROITE				
FILTRO OLIO	OIL FILTER	FILTRE À HUILE			F007522	F007522
FRIZIONE	CLUTCH	EMBRAYAGE				
GRUPPO TERMICO Standard	CYLINDER KIT Ø standard	CYLINDRE COMPLET Standard				
GRUPPO TERMICO Maggiorato	CYLINDER KIT BIG BORE	CYLINDRE COMPLET Majoré				
KIT CUSCINETTI PARAOLI DI BANCO Serie	BEARINGS AND OIL SEALS KIT	KIT PALIERS JOINTS D'HUILE DE VILEBREQUIN Jeu				
KIT REVISIONE POMPA ACQUA	WATER PUMP REPAIR KIT	KIT RÉVISION POMPE À EAU				
KIT TAGLIANDO	SERVICE KIT	KIT COUPON		TG00119	TG00104	TG00119 TG00104
MASSE CENTRIFUGHE PESO ORIGINALE	ROLLER WEIGHTS Standard weight	MASSELOTES CENTRIFUGES POIDS D'ORIGINE				
MEMBRANA CARBURATORE TIPO ORIGINALE	CARBURETOR DIAPHRAGM OEM	MEMBRANE CARBURATEUR TYPE ORIGINAL				
MEMBRANA CARBURATORE ADATTABILE	CARBURETOR DIAPHRAGM Adaptable	MEMBRANE CARBURATEUR ADAPTABLE				
MOLLE CONTRASTO VARIATORE	REAR VARIATOR SPRING	RESSORTS CONTRASTE VARIATEUR				
MOLLA A GAS PER SELLA	SEAT GAS SPRING	RESSORT À GAZ POUR SELLE			9980260	9980260
MOTORINO D'AVVIAMENTO	STARTER ENGINE	DÉMARREUR ÉLECTRIQUE				
POMPA BENZINA	FUEL PUMP	POMPE À ESSENCE				
REGOLATORE DI TENSIONE	RECTIFIER	RÉGULATEUR DE TENSION				
RUOTA LIBERA Completa	STARTER CLUTCH SET	ROUE LIBRE Complète				
RUOTA LIBERA RL + flangia	STARTER CLUTCH + FLANGE	ROUE LIBRE RL + flasque				
RUOTA LIBERA RL nuda	STARTER CLUTCH	ROUE LIBRE RL nue				
RUOTA LIBERA Ingranaggio	STARTER CLUTCH GEAR	ROUE LIBRE Engrenage				
RUOTA LIBERA Flangia	STARTER CLUTCH FLANGE	ROUE LIBRE Flasque				
SERIE DISCHI FRIZIONE	CLUTCH PLATES KIT	JEU DISQUES EMBRAYAGE				
STATORE	STATOR	STATOR				
VARIOTOP TPR	VARIOTOP TPR	VARIOTOP TPR				

SUZUKI	SUZUKI	SUZUKI	SUZUKI	SUZUKI	SUZUKI	SUZUKI	SUZUKI	SUZUKI	SUZUKI	SUZUKI	SUZUKI
AN BURGMAN L6	AN BURGMAN W/X/Y	AN BURGMAN X/K2	AN S-Y	AN T-Y	AN650Z BURGMAN	EPICURO	EPICURO	UE CT K1	UE CT K1	UH BURGMAN K2/K6	UH BURGMAN K2/K6
16-16	98-00	99-02	95-00	96-00	18-18	99-01	99-01	01-01	01-01	02-06	02-06
650cc 4T LC	250cc 4T LC	400cc 4T LC	125cc 4T AC	150cc 4T AC	650cc 4T LC	125cc 4T LC	150cc 4T LC	125cc 4T AC	150cc 4T AC	125cc 4T LC	150cc 4T LC
											IM07052
						9927500	9927500			9927500	9927500
	9935510	9935520	9935940								
	F007510	F007510	F007522	F007522		F007522	F007522	F007522	F007522	F007522	F007522
		KK01006				KK01006	KK01006			KK01006	KK01006
	AA00819	AA00819				AA00819	AA00819			AA00819	AA00819
TG00119					TG00119						
							9916690			9916690	
	MA00021	MA00021				MA00021	MA00021			MA00021	MA00021
	RL00018	RL00012				RL00017	RL00017			RL00017	RL00017
	9923790					9923460	9923460			9923460	9923460



SUZUKI	SUZUKI	SUZUKI	SUZUKI
UH BURGMAN K7/L0	UH BURGMAN K7/L0	UH BURGMAN L1	UH BURGMAN L1
07-10	07-10	11-11	11-12
125cc 4T LC	200cc 4T LC	125cc 4T LC	200cc 4T LC

IT	EN	FR				
ALBERO A CAMME	CAM SHAFT	ARBRE À CAMES				
ALBERO MOTORE Sel 1	Crankshaft Sel 1	VILEBREQUIN Sél 1				
ALBERO MOTORE Sel 2	Crankshaft Sel 2	VILEBREQUIN Sél 2				
BIELLA	CONROD	BIELLE				
CAMPANA FRIZIONE	CLUTCH HOUSING	CLOCHE EMBRAYAGE				
CINGHIA DI TRASMISSIONE Bando	TRANSMISSION BELT Bando	COURROIE DE TRANSMISSION Bando		9927510	9927520	9927510
CINGHIA DI TRASMISSIONE Mitsuboshi	TRANSMISSION BELT Mitsuboshi	COURROIE DE TRANSMISSION Mitsuboshi				
CINGHIA DI TRASMISSIONE Altro	TRANSMISSION BELT Other	COURROIE DE TRANSMISSION Autres				
COLLETTORE ASPIRAZIONE	INLET MANIFOLD	COLLECTEUR ASPIRATION				
COLLETTORE ASPIRAZIONE SX	INLET MANIFOLD LEFT	COLLECTEUR ASPIRATION GAUCHE				
COLLETTORE ASPIRAZIONE DX	INLET MANIFOLD RIGHT	COLLECTEUR ASPIRATION DROITE				
FILTRO OLIO	OIL FILTER	FILTRE À HUILE		F007522	F007522	F007522
FRIZIONE	CLUTCH	EMBRAYAGE				
GRUPPO TERMICO Standard	CYLINDER KIT Ø standard	CYLINDRE COMPLET Standard				
GRUPPO TERMICO Maggiorato	CYLINDER KIT BIG BORE	CYLINDRE COMPLET Majoré				
KIT CUSCINETTI PARAOLI DI BANCO Serie	BEARINGS AND OIL SEALS KIT	KIT PALIERS JOINTS D'HUILE DE VILEBREQUIN Jeu		KK01006	KK01006	
KIT REVISIONE POMPA ACQUA	WATER PUMP REPAIR KIT	KIT RÉVISION POMPE À EAU		AA00819	AA00819	AA00819
KIT TAGLIANDO	SERVICE KIT	KIT COUPON		TG00118		TG00118
MASSE CENTRIFUGHE PESO ORIGINALE	ROLLER WEIGHTS Standard weight	MASSELOTES CENTRIFUGES POIDS D'ORIGINE		9916690		9916690
MEMBRANA CARBURATORE TIPO ORIGINALE	CARBURETOR DIAPHRAGM OEM	MEMBRANE CARBURATEUR TYPE ORIGINAL				
MEMBRANA CARBURATORE ADATTABILE	CARBURETOR DIAPHRAGM Adaptable	MEMBRANE CARBURATEUR ADAPTABLE				
MOLLE CONTRASTO VARIATORE	REAR VARIATOR SPRING	RESSORTS CONTRASTE VARIATEUR				
MOLLA A GAS PER SELLA	SEAT GAS SPRING	RESSORT À GAZ POUR SELLE				
MOTORINO D'AVVIAMENTO	STARTER ENGINE	DÉMARREUR ÉLECTRIQUE				
POMPA BENZINA	FUEL PUMP	POMPE À ESSENCE				
REGOLATORE DI TENSIONE	RECTIFIER	RÉGULATEUR DE TENSION				
RUOTA LIBERA Completa	STARTER CLUTCH SET	ROUE LIBRE Complète				
RUOTA LIBERA RL + flangia	STARTER CLUTCH + FLANGE	ROUE LIBRE RL + flasque				
RUOTA LIBERA RL nuda	STARTER CLUTCH	ROUE LIBRE RL nue				
RUOTA LIBERA Ingranaggio	STARTER CLUTCH GEAR	ROUE LIBRE Engrenage				
RUOTA LIBERA Flangia	STARTER CLUTCH FLANGE	ROUE LIBRE Flasque				
SERIE DISCHI FRIZIONE	CLUTCH PLATES KIT	JEU DISQUES EMBRAYAGE				
STATORE	STATOR	STATOR				
VARIOTOP TPR	VARIOTOP TPR	VARIOTOP TPR		9923460		

SUZUKI	SUZUKI	SUZUKI	SUZUKI	SUZUKI	SUZUKI	SUZUKI	SUZUKI	SUZUKI	SUZUKI	SUZUKI	SUZUKI
UH BURGMAN L3	UH BURGMAN L3	UH BURGMAN L4	UH BURGMAN L4	UH BURGMAN L4	UH BURGMAN L6	UH BURGMAN L6	UH BURGMAN L7	UH BURGMAN L8	UH BURGMAN L9	UX SIXTEEN K8/L0	UX SIXTEEN K8/L0
13-13	13-13	14-14	14-14	14-14	16-16	16-16	17-17	18-18	19-19	08-10	08-10
125cc 4T LC	200cc 4T LC	125cc 4T LC	125cc 4T LC	200cc 4T LC	125cc 4T LC	125cc 4T LC	125cc 4T LC	125cc 4T LC	125cc 4T LC	125cc 4T LC	150cc 4T LC
9927510	9927520	9927510		9927520	9927510						
											9935530 9935540
										F007522	F007522
										KK01006	KK01006
TG00118			TG00118			TG00118	TG00118	TG00118	TG00118		
										9923460	9923460

MAXI SCOOTER

MAXI SCOOTER



SUZUKI	SUZUKI	SYM	SYM
UX SIXTEEN L1	UX SIXTEEN L1	CITYCOM	CITYCOM EFI
11-11	11-11	08-09	10-11
125cc 4T LC	150cc 4T LC	300cc 4T-4V LC	300cc 4T-4V LC

IT	EN	FR				
ALBERO A CAMME	CAM SHAFT	ARBRE À CAMES				
ALBERO MOTORE Sel 1	Crankshaft Sel 1	VILEBREQUIN Sél 1				
ALBERO MOTORE Sel 2	Crankshaft Sel 2	VILEBREQUIN Sél 2				
BIELLA	CONROD	BIELLE				
CAMPANA FRIZIONE	CLUTCH HOUSING	CLOCHE EMBRAYAGE				
CINGHIA DI TRASMISSIONE Bando	TRANSMISSION BELT Bando	COURROIE DE TRANSMISSION Bando				
CINGHIA DI TRASMISSIONE Mitsuboshi	TRANSMISSION BELT Mitsuboshi	COURROIE DE TRANSMISSION Mitsuboshi			9935530 9935540	9935550
CINGHIA DI TRASMISSIONE Altro	TRANSMISSION BELT Other	COURROIE DE TRANSMISSION Autres				
COLLETTORE ASPIRAZIONE	INLET MANIFOLD	COLLECTEUR ASPIRATION				
COLLETTORE ASPIRAZIONE SX	INLET MANIFOLD LEFT	COLLECTEUR ASPIRATION GAUCHE				
COLLETTORE ASPIRAZIONE DX	INLET MANIFOLD RIGHT	COLLECTEUR ASPIRATION DROITE				
FILTRO OLIO	OIL FILTER	FILTRE À HUILE		F007522	F007522	
FRIZIONE	CLUTCH	EMBRAYAGE				
GRUPPO TERMICO Standard	CYLINDER KIT Ø standard	CYLINDRE COMPLET Standard				
GRUPPO TERMICO Maggiorato	CYLINDER KIT BIG BORE	CYLINDRE COMPLET Majoré				
KIT CUSCINETTI PARAOLI DI BANCO Serie	BEARINGS AND OIL SEALS KIT	KIT PALIERS JOINTS D'HUILE DE VILEBREQUIN Jeu				
KIT REVISIONE POMPA ACQUA	WATER PUMP REPAIR KIT	KIT RÉVISION POMPE À EAU				
KIT TAGLIANDO	SERVICE KIT	KIT COUPON				
MASSE CENTRIFUGHE PESO ORIGINALE	ROLLER WEIGHTS Standard weight	MASSELOTTE CENTRIFUGES POIDS D'ORIGINE				
MEMBRANA CARBURATORE TIPO ORIGINALE	CARBURETOR DIAPHRAGM OEM	MEMBRANE CARBURATEUR TYPE ORIGINAL				
MEMBRANA CARBURATORE ADATTABILE	CARBURETOR DIAPHRAGM Adaptable	MEMBRANE CARBURATEUR ADAPTABLE				
MOLLE CONTRASTO VARIATORE	REAR VARIATOR SPRING	RESSORTS CONTRASTE VARIATEUR				
MOLLA A GAS PER SELLA	SEAT GAS SPRING	RESSORT À GAZ POUR SELLE				
MOTORINO D'AVVIAMENTO	STARTER ENGINE	DÉMARREUR ÉLECTRIQUE				MA00031
POMPA BENZINA	FUEL PUMP	POMPE À ESSENCE				
REGOLATORE DI TENSIONE	RECTIFIER	RÉGULATEUR DE TENSION				
RUOTA LIBERA Completa	STARTER CLUTCH SET	ROUE LIBRE Complète				
RUOTA LIBERA RL + flangia	STARTER CLUTCH + FLANGE	ROUE LIBRE RL + flasque				
RUOTA LIBERA RL nuda	STARTER CLUTCH	ROUE LIBRE RL nue				
RUOTA LIBERA Ingranaggio	STARTER CLUTCH GEAR	ROUE LIBRE Engrenage				
RUOTA LIBERA Flangia	STARTER CLUTCH FLANGE	ROUE LIBRE Flasque				
SERIE DISCHI FRIZIONE	CLUTCH PLATES KIT	JEU DISQUES EMBRAYAGE				
STATORE	STATOR	STATOR				
VARIOTOP TPR	VARIOTOP TPR	VARIOTOP TPR				



SYM	SYM	SYM	SYM
HD EU2	HD EU2	HD EU3	HD EU3 I
03-04	03-04	07-08	07-07
125cc 4T-4V LC	200cc 4T-4V LC	125cc 4T-4V LC	200cc 4T-4V LC

IT	EN	FR				
ALBERO A CAMME	CAM SHAFT	ARBRE À CAMES				
ALBERO MOTORE Sel 1	Crankshaft Sel 1	VILEBREQUIN Sél 1				
ALBERO MOTORE Sel 2	Crankshaft Sel 2	VILEBREQUIN Sél 2				
BIELLA	CONROD	BIELLE				
CAMPANA FRIZIONE	CLUTCH HOUSING	CLOCHE EMBRAYAGE				
CINGHIA DI TRASMISSIONE Bando	TRANSMISSION BELT Bando	COURROIE DE TRANSMISSION Bando			9925860	9925860
CINGHIA DI TRASMISSIONE Mitsuboshi	TRANSMISSION BELT Mitsuboshi	COURROIE DE TRANSMISSION Mitsuboshi				
CINGHIA DI TRASMISSIONE Altro	TRANSMISSION BELT Other	COURROIE DE TRANSMISSION Autres				
COLLETTORE ASPIRAZIONE	INLET MANIFOLD	COLLECTEUR ASPIRATION				
COLLETTORE ASPIRAZIONE SX	INLET MANIFOLD LEFT	COLLECTEUR ASPIRATION GAUCHE				
COLLETTORE ASPIRAZIONE DX	INLET MANIFOLD RIGHT	COLLECTEUR ASPIRATION DROITE				
FILTRO OLIO	OIL FILTER	FILTRE À HUILE				
FRIZIONE	CLUTCH	EMBAYAGE				
GRUPPO TERMICO Standard	CYLINDER KIT Ø standard	CYLINDRE COMPLET Standard				
GRUPPO TERMICO Maggiorato	CYLINDER KIT BIG BORE	CYLINDRE COMPLET Majoré				
KIT CUSCINETTI PARAOLI DI BANCO Serie	BEARINGS AND OIL SEALS KIT	KIT PALIERS JOINTS D'HUILE DE VILEBREQUIN Jeu				
KIT REVISIONE POMPA ACQUA	WATER PUMP REPAIR KIT	KIT RÉVISION POMPE À EAU				
KIT TAGLIANDO	SERVICE KIT	KIT COUPON				
MASSE CENTRIFUGHE PESO ORIGINALE	ROLLER WEIGHTS Standard weight	MASSELOTES CENTRIFUGES POIDS D'ORIGINE				
MEMBRANA CARBURATORE TIPO ORIGINALE	CARBURETOR DIAPHRAGM OEM	MEMBRANE CARBURATEUR TYPE ORIGINAL				
MEMBRANA CARBURATORE ADATTABILE	CARBURETOR DIAPHRAGM Adaptable	MEMBRANE CARBURATEUR ADAPTABLE				
MOLLE CONTRASTO VARIATORE	REAR VARIATOR SPRING	RESSORTS CONTRASTE VARIATEUR				
MOLLA A GAS PER SELLA	SEAT GAS SPRING	RESSORT À GAZ POUR SELLE				
MOTORINO D'AVVIAMENTO	STARTER ENGINE	DÉMARREUR ÉLECTRIQUE				MA00004
POMPA BENZINA	FUEL PUMP	POMPE À ESSENCE				
REGOLATORE DI TENSIONE	RECTIFIER	RÉGULATEUR DE TENSION				
RUOTA LIBERA Completa	STARTER CLUTCH SET	ROUE LIBRE Complète				
RUOTA LIBERA RL + flangia	STARTER CLUTCH + FLANGE	ROUE LIBRE RL + flasque				
RUOTA LIBERA RL nuda	STARTER CLUTCH	ROUE LIBRE RL nue				
RUOTA LIBERA Ingranaggio	STARTER CLUTCH GEAR	ROUE LIBRE Engrenage				
RUOTA LIBERA Flangia	STARTER CLUTCH FLANGE	ROUE LIBRE Flasque				
SERIE DISCHI FRIZIONE	CLUTCH PLATES KIT	JEU DISQUES EMBRAYAGE				
STATORE	STATOR	STATOR		ST00029	ST00029	ST00029
VARIOTOP TPR	VARIOTOP TPR	VARIOTOP TPR				

SYM	SYM	SYM	SYM	SYM	SYM	SYM	SYM	SYM	SYM	SYM	SYM
HD EVO	HD EVO EU2	HD EVO EU3	HD EVO EU3	HD EVO EU3 I	HD EVO I EU3	HD EVO I TAMBURO EU3	HD EVO TAMBURO EU3	HD2	HD2	HD2 I	JET 4
05-06	05-06	07-08	10-11	07-07	10-10	08-09	08-09	11-11	14-14	11-11	09-10
125cc 4T-4V LC	200cc 4T-4V LC	125cc 4T-4V LC	125cc 4T-4V LC	200cc 4T-4V LC	200cc 4T-4V LC	200cc 4T-4V LC	125cc 4T-4V LC	125cc 4T-4V LC	125cc 4T-4V LC	200cc 4T-4V LC	125cc 4T AC
											IM07069
	9925860			9925860	9925860	9925860				9925860	
MA00004		MA00004	MA00004				MA00004	MA00004			
ST00029	ST00029	ST00029	ST00029				ST00029	ST00029	ST00029		



SYM	SYM	SYM	SYM
JOYMAX	JOYMAX EU3 I	JOYMAX EVO	JOYMAX EVO I
05-07	07-08	09-09	10-10
250cc 4T-4V LC	250cc 4T-4V LC	300cc 4T-4V LC	300cc 4T-4V LC

IT	EN	FR				
ALBERO A CAMME	CAM SHAFT	ARBRE À CAMES				
ALBERO MOTORE Sel 1	Crankshaft Sel 1	VILEBREQUIN Sél 1				
ALBERO MOTORE Sel 2	Crankshaft Sel 2	VILEBREQUIN Sél 2				
BIELLA	CONROD	BIELLE				
CAMPANA FRIZIONE	CLUTCH HOUSING	CLOCHE EMBRAYAGE				
CINGHIA DI TRASMISSIONE Bando	TRANSMISSION BELT Bando	COURROIE DE TRANSMISSION Bando		9925850	9925850	
CINGHIA DI TRASMISSIONE Mitsuboshi	TRANSMISSION BELT Mitsuboshi	COURROIE DE TRANSMISSION Mitsuboshi		9935790	9935790	9935560
CINGHIA DI TRASMISSIONE Altro	TRANSMISSION BELT Other	COURROIE DE TRANSMISSION Autres				
COLLETTORE ASPIRAZIONE	INLET MANIFOLD	COLLECTEUR ASPIRATION				
COLLETTORE ASPIRAZIONE SX	INLET MANIFOLD LEFT	COLLECTEUR ASPIRATION GAUCHE				
COLLETTORE ASPIRAZIONE DX	INLET MANIFOLD RIGHT	COLLECTEUR ASPIRATION DROITE				
FILTRO OLIO	OIL FILTER	FILTRE À HUILE				
FRIZIONE	CLUTCH	EMBRAYAGE				
GRUPPO TERMICO Standard	CYLINDER KIT Ø standard	CYLINDRE COMPLET Standard				
GRUPPO TERMICO Maggiorato	CYLINDER KIT BIG BORE	CYLINDRE COMPLET Majoré				
KIT CUSCINETTI PARAOLI DI BANCO Serie	BEARINGS AND OIL SEALS KIT	KIT PALIERS JOINTS D'HUILE DE VILEBREQUIN Jeu				
KIT REVISIONE POMPA ACQUA	WATER PUMP REPAIR KIT	KIT RÉVISION POMPE À EAU				
KIT TAGLIANDO	SERVICE KIT	KIT COUPON				
MASSE CENTRIFUGHE PESO ORIGINALE	ROLLER WEIGHTS Standard weight	MASSELOTTE CENTRIFUGES POIDS D'ORIGINE				
MEMBRANA CARBURATORE TIPO ORIGINALE	CARBURETOR DIAPHRAGM OEM	MEMBRANE CARBURATEUR TYPE ORIGINAL				
MEMBRANA CARBURATORE ADATTABILE	CARBURETOR DIAPHRAGM Adaptable	MEMBRANE CARBURATEUR ADAPTABLE				
MOLLE CONTRASTO VARIATORE	REAR VARIATOR SPRING	RESSORTS CONTRASTE VARIATEUR				
MOLLA A GAS PER SELLA	SEAT GAS SPRING	RESSORT À GAZ POUR SELLE				
MOTORINO D'AVVIAMENTO	STARTER ENGINE	DÉMARREUR ÉLECTRIQUE		MA00031	MA00031	MA00031
POMPA BENZINA	FUEL PUMP	POMPE À ESSENCE				
REGOLATORE DI TENSIONE	RECTIFIER	RÉGULATEUR DE TENSION				
RUOTA LIBERA Completa	STARTER CLUTCH SET	ROUE LIBRE Complète				
RUOTA LIBERA RL + flangia	STARTER CLUTCH + FLANGE	ROUE LIBRE RL + flasque				
RUOTA LIBERA RL nuda	STARTER CLUTCH	ROUE LIBRE RL nue				
RUOTA LIBERA Ingranaggio	STARTER CLUTCH GEAR	ROUE LIBRE Engrenage				
RUOTA LIBERA Flangia	STARTER CLUTCH FLANGE	ROUE LIBRE Flasque				
SERIE DISCHI FRIZIONE	CLUTCH PLATES KIT	JEU DISQUES EMBRAYAGE				
STATORE	STATOR	STATOR				
VARIOTOP TPR	VARIOTOP TPR	VARIOTOP TPR				

SYM	SYM	SYM	SYM	SYM	SYM	SYM	SYM	SYM	SYM	SYM	SYM
JOYMAX I	JOYMAX I	JOYMAX I ABS	JOYMAX I ABS	JOYRIDE	JOYRIDE	JOYRIDE	JOYRIDE EU2	JOYRIDE EU2	JOYRIDE EU2	JOYRIDE EU2	JOYRIDE EU3
12-12	14-14	13-13	14-14	01-02	01-02	03-03	03-04	05-06	03-04	05-06	07-07
300cc 4T-4V LC	300cc 4T-4V LC	300cc 4T-4V LC	300cc 4T-4V LC	125cc 4T-4V LC	150cc 4T-4V LC	200cc 4T-4V LC	125cc 4T-4V LC	125cc 4T-4V LC	200cc 4T-4V LC	200cc 4T-4V LC	125cc 4T-4V LC
MA00031	MA00031	MA00031	MA00031	MA00004	MA00004			MA00004			MA00004
				ST00029	ST00029	ST00029	ST00029	ST00029	ST00029	ST00029	ST00029

MAXI SCOOTER



SYM	SYM	SYM	SYM
JOYRIDE EVO	JOYRIDE EVO	JOYRIDE EVO	JOYRIDE EVO
09-10	10-10	13-13	14-14
125cc 4T-4V LC	125cc 4T-4V LC	125cc 4T-4V LC	125cc 4T-4V LC

IT	EN	FR				
ALBERO A CAMME	CAM SHAFT	ARBRE À CAMES				
ALBERO MOTORE Sel 1	Crankshaft Sel 1	VILEBREQUIN Sél 1				
ALBERO MOTORE Sel 2	Crankshaft Sel 2	VILEBREQUIN Sél 2				
BIELLA	CONROD	BIELLE				
CAMPANA FRIZIONE	CLUTCH HOUSING	CLOCHE EMBRAYAGE				
CINGHIA DI TRASMISSIONE Bando	TRANSMISSION BELT Bando	COURROIE DE TRANSMISSION Bando				
CINGHIA DI TRASMISSIONE Mitsuboshi	TRANSMISSION BELT Mitsuboshi	COURROIE DE TRANSMISSION Mitsuboshi				
CINGHIA DI TRASMISSIONE Altro	TRANSMISSION BELT Other	COURROIE DE TRANSMISSION Autres				
COLLETTORE ASPIRAZIONE	INLET MANIFOLD	COLLECTEUR ASPIRATION				
COLLETTORE ASPIRAZIONE SX	INLET MANIFOLD LEFT	COLLECTEUR ASPIRATION GAUCHE				
COLLETTORE ASPIRAZIONE DX	INLET MANIFOLD RIGHT	COLLECTEUR ASPIRATION DROITE				
FILTRO OLIO	OIL FILTER	FILTRE À HUILE				
FRIZIONE	CLUTCH	EMBRAYAGE				
GRUPPO TERMICO Standard	CYLINDER KIT Ø standard	CYLINDRE COMPLET Standard				
GRUPPO TERMICO Maggiorato	CYLINDER KIT BIG BORE	CYLINDRE COMPLET Majoré				
KIT CUSCINETTI PARAOLI DI BANCO Serie	BEARINGS AND OIL SEALS KIT	KIT PALIERS JOINTS D'HUILE DE VILEBREQUIN Jeu				
KIT REVISIONE POMPA ACQUA	WATER PUMP REPAIR KIT	KIT RÉVISION POMPE À EAU				
KIT TAGLIANDO	SERVICE KIT	KIT COUPON				
MASSE CENTRIFUGHE PESO ORIGINALE	ROLLER WEIGHTS Standard weight	MASSELOTES CENTRIFUGES POIDS D'ORIGINE				
MEMBRANA CARBURATORE TIPO ORIGINALE	CARBURETOR DIAPHRAGM OEM	MEMBRANE CARBURATEUR TYPE ORIGINAL				
MEMBRANA CARBURATORE ADATTABILE	CARBURETOR DIAPHRAGM Adaptable	MEMBRANE CARBURATEUR ADAPTABLE				
MOLLE CONTRASTO VARIATORE	REAR VARIATOR SPRING	RESSORTS CONTRASTE VARIATEUR				
MOLLA A GAS PER SELLA	SEAT GAS SPRING	RESSORT À GAZ POUR SELLE				
MOTORINO D'AVVIAMENTO	STARTER ENGINE	DÉMARREUR ÉLECTRIQUE		MA00004	MA00004	
POMPA BENZINA	FUEL PUMP	POMPE À ESSENCE				
REGOLATORE DI TENSIONE	RECTIFIER	RÉGULATEUR DE TENSION				
RUOTA LIBERA Completa	STARTER CLUTCH SET	ROUE LIBRE Complète				
RUOTA LIBERA RL + flangia	STARTER CLUTCH + FLANGE	ROUE LIBRE RL + flasque				
RUOTA LIBERA RL nuda	STARTER CLUTCH	ROUE LIBRE RL nue				
RUOTA LIBERA Ingranaggio	STARTER CLUTCH GEAR	ROUE LIBRE Engrenage				
RUOTA LIBERA Flangia	STARTER CLUTCH FLANGE	ROUE LIBRE Flasque				
SERIE DISCHI FRIZIONE	CLUTCH PLATES KIT	JEU DISQUES EMBRAYAGE				
STATORE	STATOR	STATOR		ST00029	ST00029	ST00029
VARIOTOP TPR	VARIOTOP TPR	VARIOTOP TPR				

SYM	SYM	SYM	SYM	SYM	SYM	SYM	SYM	SYM	SYM	SYM	SYM
SHARK	SHARK	SUPER DUKE	SUPER DUKE	SYMPHONY	SYMPHONY	SYMPHONY S	SYMPHONY S	SYMPHONY S	SYMPHONY S	SYMPHONY S	SYMPHONY S
99-02	00-01	99-02	99-02	09-09	09-09	09-09	10-10	12-12	13-14	10-10	12-12
125cc 4T AC	150cc 4T AC	125cc 4T AC	150cc 4T AC	125cc 4T AC	150cc 4T AC	125cc 4T AC	125cc 4T AC	125cc 4T AC	125cc 4T AC	150cc 4T AC	150cc 4T AC
					IM07069	IM07069	IM07069				
					9931680	9931680	9931680	9931680	9931680	9931680	9931680
									MC12005	MC12005	MC12005
MA00026	MA00026	MA00007	MA00007	MA00026	MA00026	MA00026	MA00026			MA00026	
		RE00013	RE00013								

MAXI SCOOTER



SYM	SYM	SYM	SYM
SYMPHONY S	SYMPHONY SR	SYMPHONY SR	SYMPHONY SR
13-14	10-10	12-12	10-10
150cc 4T AC	125cc 4T AC	125cc 4T AC	150cc 4T AC

IT	EN	FR				
ALBERO A CAMME	CAM SHAFT	ARBRE À CAMES				
ALBERO MOTORE Sel 1	Crankshaft Sel 1	VILEBREQUIN Sél 1			IM07069	
ALBERO MOTORE Sel 2	Crankshaft Sel 2	VILEBREQUIN Sél 2				
BIELLA	CONROD	BIELLE				
CAMPANA FRIZIONE	CLUTCH HOUSING	CLOCHE EMBRAYAGE				
CINGHIA DI TRASMISSIONE Bando	TRANSMISSION BELT Bando	COURROIE DE TRANSMISSION Bando		9931680	9931680	9931680
CINGHIA DI TRASMISSIONE Mitsuboshi	TRANSMISSION BELT Mitsuboshi	COURROIE DE TRANSMISSION Mitsuboshi				
CINGHIA DI TRASMISSIONE Altro	TRANSMISSION BELT Other	COURROIE DE TRANSMISSION Autres				
COLLETTORE ASPIRAZIONE	INLET MANIFOLD	COLLECTEUR ASPIRATION				
COLLETTORE ASPIRAZIONE SX	INLET MANIFOLD LEFT	COLLECTEUR ASPIRATION GAUCHE				
COLLETTORE ASPIRAZIONE DX	INLET MANIFOLD RIGHT	COLLECTEUR ASPIRATION DROITE				
FILTRO OLIO	OIL FILTER	FILTRE À HUILE				
FRIZIONE	CLUTCH	EMBAYAGE				
GRUPPO TERMICO Standard	CYLINDER KIT Ø standard	CYLINDRE COMPLET Standard				
GRUPPO TERMICO Maggiorato	CYLINDER KIT BIG BORE	CYLINDRE COMPLET Majoré				
KIT CUSCINETTI PARAOLI DI BANCO Serie	BEARINGS AND OIL SEALS KIT	KIT PALIERS JOINTS D'HUILE DE VILEBREQUIN Jeu				
KIT REVISIONE POMPA ACQUA	WATER PUMP REPAIR KIT	KIT RÉVISION POMPE À EAU				
KIT TAGLIANDO	SERVICE KIT	KIT COUPON				
MASSE CENTRIFUGHE PESO ORIGINALE	ROLLER WEIGHTS Standard weight	MASSELOTES CENTRIFUGES POIDS D'ORIGINE				
MEMBRANA CARBURATORE TIPO ORIGINALE	CARBURETOR DIAPHRAGM OEM	MEMBRANE CARBURATEUR TYPE ORIGINAL		MC12005		MC12005
MEMBRANA CARBURATORE ADATTABILE	CARBURETOR DIAPHRAGM Adaptable	MEMBRANE CARBURATEUR ADAPTABLE				
MOLLE CONTRASTO VARIATORE	REAR VARIATOR SPRING	RESSORTS CONTRASTE VARIATEUR				
MOLLA A GAS PER SELLA	SEAT GAS SPRING	RESSORT À GAZ POUR SELLE				
MOTORINO D'AVVIAMENTO	STARTER ENGINE	DÉMARREUR ÉLECTRIQUE			MA00026	MA00026
POMPA BENZINA	FUEL PUMP	POMPE À ESSENCE				
REGOLATORE DI TENSIONE	RECTIFIER	RÉGULATEUR DE TENSION				
RUOTA LIBERA Completa	STARTER CLUTCH SET	ROUE LIBRE Complète				
RUOTA LIBERA RL + flangia	STARTER CLUTCH + FLANGE	ROUE LIBRE RL + flasque				
RUOTA LIBERA RL nuda	STARTER CLUTCH	ROUE LIBRE RL nue				
RUOTA LIBERA Ingranaggio	STARTER CLUTCH GEAR	ROUE LIBRE Engrenage				
RUOTA LIBERA Flangia	STARTER CLUTCH FLANGE	ROUE LIBRE Flasque				
SERIE DISCHI FRIZIONE	CLUTCH PLATES KIT	JEU DISQUES EMBRAYAGE				
STATORE	STATOR	STATOR				
VARIOTOP TPR	VARIOTOP TPR	VARIOTOP TPR				

SYM	SYM	SYM	WT MOTORS	WT MOTORS	YAMAHA	YAMAHA	YAMAHA	YAMAHA	YAMAHA	YAMAHA	YAMAHA
SYMPHONY SR	SYMPLY	SYMPLY II	ATENE	MIAMI	BW'S 4T	CYGNUS R (XC K)	CYGNUS R (XC)	CYGNUS R (XC)	CYGNUS X (NXC)	CYGNUS X IE EU3 (NXC)	CYGNUS125 (XC T)
12-12	07-08	09-10	08-10	11-17	10-10	97-98	99-99	00-03	04-06	07-11	95-98
150cc 4T AC	125cc 4T AC	125cc 4T AC	150cc 4T LC	250cc 4T LC	125cc 4T AC	125cc 4T AC	125cc 4T AC	125cc 4T AC	125cc 4T AC	125cc 4T AC	125cc 4T AC
			(1P58MJ-A)	(172MM)	YW						
9931680	9926420	9926420		9928540		9931550	9931550	9931550	9931560	9931560	9931550
			9935770		9935630				9935750	9935750	
			9923140								
						9916220	9916220	9916220	9915270	9915270	9916220
MC12005											
	MA00007					MA00017	MA00017		MA00017		MA00017
		RE00023									

MAXI SCOOTER



YAMAHA	YAMAHA	YAMAHA	YAMAHA
MAJESTY	MAJESTY	MAJESTY	MAJESTY
98-00	00-00	96-98	00-01
125cc 4T LC	150cc 4T LC	250cc 4T LC	250cc 4T LC
Minarelli YP	Minarelli YP	Yamaha YP	Yamaha YP

IT	EN	FR				
ALBERO A CAMME	CAM SHAFT	ARBRE À CAMES				
ALBERO MOTORE Sel 1	Crankshaft Sel 1	VILEBREQUIN Sél 1		IM07045		IM07054
ALBERO MOTORE Sel 2	Crankshaft Sel 2	VILEBREQUIN Sél 2				
BIELLA	CONROD	BIELLE				IM07037
CAMPANA FRIZIONE	CLUTCH HOUSING	CLOCHE EMBRAYAGE				
CINGHIA DI TRASMISSIONE Bando	TRANSMISSION BELT Bando	COURROIE DE TRANSMISSION Bando		9915380	9915380	9915800
CINGHIA DI TRASMISSIONE Mitsuboshi	TRANSMISSION BELT Mitsuboshi	COURROIE DE TRANSMISSION Mitsuboshi		9935700	9935700	9935710
CINGHIA DI TRASMISSIONE Altro	TRANSMISSION BELT Other	COURROIE DE TRANSMISSION Autres				
COLLETTORE ASPIRAZIONE	INLET MANIFOLD	COLLECTEUR ASPIRATION		CT00730	CT00730	
COLLETTORE ASPIRAZIONE SX	INLET MANIFOLD LEFT	COLLECTEUR ASPIRATION GAUCHE				
COLLETTORE ASPIRAZIONE DX	INLET MANIFOLD RIGHT	COLLECTEUR ASPIRATION DROITE				
FILTRO OLIO	OIL FILTER	FILTRE À HUILE				
FRIZIONE	CLUTCH	EMBAYAGE				
GRUPPO TERMICO Standard	CYLINDER KIT Ø standard	CYLINDRE COMPLET Standard				9926850
GRUPPO TERMICO Maggiorato	CYLINDER KIT BIG BORE	CYLINDRE COMPLET Majoré		9929380	9929380	
KIT CUSCINETTI PARAOLI DI BANCO Serie	BEARINGS AND OIL SEALS KIT	KIT PALIERS JOINTS D'HUILE DE VILEBREQUIN Jeu		KK01010	KK01010	KK01007
KIT REVISIONE POMPA ACQUA	WATER PUMP REPAIR KIT	KIT RÉVISION POMPE À EAU		AA00805	AA00805	AA00806
KIT TAGLIANDO	SERVICE KIT	KIT COUPON				
MASSE CENTRIFUGHE PESO ORIGINALE	ROLLER WEIGHTS Standard weight	MASSELOTES CENTRIFUGES POIDS D'ORIGINE		9915270		9918020
MEMBRANA CARBURATORE TIPO ORIGINALE	CARBURETOR DIAPHRAGM OEM	MEMBRANE CARBURATEUR TYPE ORIGINAL				MC12001
MEMBRANA CARBURATORE ADATTABILE	CARBURETOR DIAPHRAGM Adaptable	MEMBRANE CARBURATEUR ADAPTABLE		MC12100	MC12100	MC12101
MOLLE CONTRASTO VARIATORE	REAR VARIATOR SPRING	RESSORTS CONTRASTE VARIATEUR		9929170	9929170	9929870
MOLLA A GAS PER SELLA	SEAT GAS SPRING	RESSORT À GAZ POUR SELLE				
MOTORINO D'AVVIAMENTO	STARTER ENGINE	DÉMARREUR ÉLECTRIQUE		MA00017	MA00017	MA00010
POMPA BENZINA	FUEL PUMP	POMPE À ESSENCE				
REGOLATORE DI TENSIONE	RECTIFIER	RÉGULATEUR DE TENSION		RE00020	RE00020	
RUOTA LIBERA Completa	STARTER CLUTCH SET	ROUE LIBRE Complète				
RUOTA LIBERA RL + flangia	STARTER CLUTCH + FLANGE	ROUE LIBRE RL + flasque		RL00002	RL00002	RL00010
RUOTA LIBERA RL nuda	STARTER CLUTCH	ROUE LIBRE RL nue				
RUOTA LIBERA Ingranaggio	STARTER CLUTCH GEAR	ROUE LIBRE Engrenage				RL00011
RUOTA LIBERA Flangia	STARTER CLUTCH FLANGE	ROUE LIBRE Flasque				
SERIE DISCHI FRIZIONE	CLUTCH PLATES KIT	JEU DISQUES EMBRAYAGE				
STATORE	STATOR	STATOR		ST00002	ST00002	
VARIOTOP TPR	VARIOTOP TPR	VARIOTOP TPR		9923550	9923550	9931790

YAMAHA	YAMAHA	YAMAHA	YAMAHA	YAMAHA	YAMAHA	YAMAHA	YAMAHA	YAMAHA	YAMAHA	YAMAHA	YAMAHA
MAJESTY	MAJESTY	MAJESTY	MAJESTY	MAJESTY	MAJESTY (5NR1)	MAJESTY (5NR8)	MAJESTY (5NS1)	MAJESTY (5NS6)	MAJESTY ABS	MAJESTY ABS	MAJESTY ABS
02-03	04-05	06-06	07-08	09-11	01-01	02-02	01-01	02-02	03-03	07-07	08-08
250cc 4T LC	400cc 4T LC	400cc 4T LC	400cc 4T LC	400cc 4T LC	125cc 4T LC	125cc 4T LC	150cc 4T LC	150cc 4T LC	250cc 4T LC	400cc 4T LC	400cc 4T LC
Yamaha YP	5RU	5RU	5RU	34B	Minarelli YP	Minarelli YP	Minarelli YP	Minarelli YP	Yamaha YP	5RU	5RU
IM07054					IM07045	IM07045			IM07054		
IM07037									IM07037		
9915800	9927530	9927530			9915380	9915380	9915380	9915380	9915800		
9935710			9935580	9935610	9935700	9935700	9935700	9935700	9935710	9935580	9935580
					CT00730	CT00730	CT00730	CT00730			
	F007521	F007521	F007521	F007521						F007521	F007521
9926850									9926850		
					9929380	9929380	9929380	9929380			
KK01007					KK01010	KK01010	KK01010	KK01010	KK01007		
AA00806	AA00818	AA00818	AA00818		AA00805	AA00805	AA00805	AA00805	AA00806	AA00818	AA00818
9918020	9922150	9922150	9922150	9922230	9915270	9915270			9918020	9922150	9922150
MC12001									MC12001		
MC12101					MC12100	MC12100	MC12100	MC12100	MC12101		
9929870					9929170	9929170	9929170	9929170	9929870		
	9980210	9980210	9980210	9980210						9980210	9980210
MA00010	MA00010	MA00010	MA00010	MA00010	MA00017	MA00017	MA00017	MA00017	MA00010	MA00010	MA00010
RE00022	RE00022	RE00022	RE00022	RE00022	RE00020	RE00030	RE00020	RE00030	RE00022	RE00022	RE00022
RL00010	RL00019	RL00019	RL00019	RL00019	RL00002	RL00002	RL00002	RL00002	RL00010	RL00019	RL00019
RL00011	RL00020	RL00020	RL00020	RL00020					RL00011	RL00020	RL00020
	ST00022	ST00022	ST00022	ST00022	ST00002	ST00002	ST00002	ST00002		ST00022	ST00022
9931790	9923330	9923330	9923330	9930360	9923550	9923550	9923550	9923550	9931790	9923330	9923330



YAMAHA	YAMAHA	YAMAHA	YAMAHA
MAJESTY ABS	MAJESTY DX	MAJESTY DX	MAJESTY E
09-11	98-98	99-99	03-05
400cc 4T LC	250cc 4T LC	250cc 4T LC	125cc 4T LC
34B	Yamaha YP	Yamaha YP	Minarelli YP

IT	EN	FR				
ALBERO A CAMME	CAM SHAFT	ARBRE À CAMES				
ALBERO MOTORE Sel 1	Crankshaft Sel 1	VILEBREQUIN Sél 1			IM07054	IM07054
ALBERO MOTORE Sel 2	Crankshaft Sel 2	VILEBREQUIN Sél 2				
BIELLA	CONROD	BIELLE			IM07037	IM07037
CAMPANA FRIZIONE	CLUTCH HOUSING	CLOCHE EMBRAYAGE				
CINGHIA DI TRASMISSIONE Bando	TRANSMISSION BELT Bando	COURROIE DE TRANSMISSION Bando			9915800	9915800
CINGHIA DI TRASMISSIONE Mitsuboshi	TRANSMISSION BELT Mitsuboshi	COURROIE DE TRANSMISSION Mitsuboshi			9935610	9935710
CINGHIA DI TRASMISSIONE Altro	TRANSMISSION BELT Other	COURROIE DE TRANSMISSION Autres				
COLLETTORE ASPIRAZIONE	INLET MANIFOLD	COLLECTEUR ASPIRATION				CT00729
COLLETTORE ASPIRAZIONE SX	INLET MANIFOLD LEFT	COLLECTEUR ASPIRATION GAUCHE				
COLLETTORE ASPIRAZIONE DX	INLET MANIFOLD RIGHT	COLLECTEUR ASPIRATION DROITE				
FILTRO OLIO	OIL FILTER	FILTRE À HUILE			F007521	
FRIZIONE	CLUTCH	EMBAYAGE				
GRUPPO TERMICO Standard	CYLINDER KIT Ø standard	CYLINDRE COMPLET Standard			9926850	9926850
GRUPPO TERMICO Maggiorato	CYLINDER KIT BIG BORE	CYLINDRE COMPLET Majoré				9929380
KIT CUSCINETTI PARAOLI DI BANCO Serie	BEARINGS AND OIL SEALS KIT	KIT PALIERS JOINTS D'HUILE DE VILEBREQUIN Jeu			KK01007	KK01007
KIT REVISIONE POMPA ACQUA	WATER PUMP REPAIR KIT	KIT RÉVISION POMPE À EAU			AA00806	AA00806
KIT TAGLIANDO	SERVICE KIT	KIT COUPON				
MASSE CENTRIFUGHE PESO ORIGINALE	ROLLER WEIGHTS Standard weight	MASSELOTES CENTRIFUGES POIDS D'ORIGINE			9922230	9918020
MEMBRANA CARBURATORE TIPO ORIGINALE	CARBURETOR DIAPHRAGM OEM	MEMBRANE CARBURATEUR TYPE ORIGINAL				MC12001
MEMBRANA CARBURATORE ADATTABILE	CARBURETOR DIAPHRAGM Adaptable	MEMBRANE CARBURATEUR ADAPTABLE			MC12101	MC12101
MOLLE CONTRASTO VARIATORE	REAR VARIATOR SPRING	RESSORTS CONTRASTE VARIATEUR			9929870	9929870
MOLLA A GAS PER SELLA	SEAT GAS SPRING	RESSORT À GAZ POUR SELLE			9980210	
MOTORINO D'AVVIAMENTO	STARTER ENGINE	DÉMARREUR ÉLECTRIQUE			MA00010	MA00010
POMPA BENZINA	FUEL PUMP	POMPE À ESSENCE				
REGOLATORE DI TENSIONE	RECTIFIER	RÉGULATEUR DE TENSION			RE00022	RE00030
RUOTA LIBERA Completa	STARTER CLUTCH SET	ROUE LIBRE Complète				
RUOTA LIBERA RL + flangia	STARTER CLUTCH + FLANGE	ROUE LIBRE RL + flasque			RL00019	RL00010
RUOTA LIBERA RL nuda	STARTER CLUTCH	ROUE LIBRE RL nue				
RUOTA LIBERA Ingranaggio	STARTER CLUTCH GEAR	ROUE LIBRE Engrenage			RL00020	RL00011
RUOTA LIBERA Flangia	STARTER CLUTCH FLANGE	ROUE LIBRE Flasque				
SERIE DISCHI FRIZIONE	CLUTCH PLATES KIT	JEU DISQUES EMBRAYAGE				
STATORE	STATOR	STATOR			ST00022	ST00002
VARIOTOP TPR	VARIOTOP TPR	VARIOTOP TPR			9930360	9931790

YAMAHA	YAMAHA	YAMAHA	YAMAHA	YAMAHA	YAMAHA	YAMAHA	YAMAHA	YAMAHA	YAMAHA	YAMAHA	YAMAHA
MAJESTY E	MAJESTY E	MAJESTY E	MAJESTY E	MAJESTY E	MAXSTER	MAXSTER	T-MAX 4B5	T-MAX 4B5 ABS	T-MAX 59C	T-MAX 59C	T-MAX 59C
06-06	07-07	08-08	09-09	03-06	01-02	01-02	09-11	08-11	12-12	13-14	15-16
125cc 4T LC	125cc 4T LC	125cc 4T LC	125cc 4T LC	180cc 4T LC	125cc 4T LC	150cc 4T LC	500cc 4T LC	500cc 4T LC	530cc 4T LC	530cc 4T LC	530cc 4T LC
Minarelli YP	Minarelli YP	Minarelli YP	Minarelli YP	Minarelli YP	Minarelli YP	Minarelli YP	4B5	4B5	59C	59C	59C
IM07045	IM07045	IM07045	IM07045		IM07045						
9915380	9915380	9915380	9915380	9915380	9915380	9915380	9927550	9927550			
9935700	9935700	9935700	9935700	9935700	9935700	9935700			9935960	9935960	9935960
									9931570		9931570
CT00729	CT00729	CT00729	CT00729	CT00729	CT00730	CT00730					
							CT00744	CT00744			
							CT00745	CT00745			
							F007517	F007517	F007517	F007517	F007517
9929380	9929380	9929380	9929380		9929380	9929380					
KK01010	KK01010	KK01010	KK01010	KK01010	KK01010	KK01010					
AA00805	AA00805	AA00805	AA00805	AA00805	AA00805	AA00805	AA00820	AA00820	AA00831	AA00831	AA00831
							TG00107	TG00107	TG00108	TG00108	TG00108
					9915270		9922230	9922230	9922210	9922210	9922210
MC12001	MC12001	MC12001	MC12001	MC12001							
MC12101	MC12101	MC12101	MC12101	MC12101	MC12100	MC12100					
9929170	9929170	9929170	9929170		9929170	9929170	9929880	9929880	9929880	9929880	9929880
							9980200	9980200	9980200	9980200	9980200
MA00017	MA00017	MA00017	MA00017	MA00017	MA00017	MA00017	MA00033	MA00033	MA00033	MA00033	MA00033
RE00030	RE00030	RE00030	RE00030	RE00030			RE00022	RE00022	RE00033	RE00033	RE00033
											RL00043
RL00032	RL00032	RL00032	RL00032	RL00032	RL00002	RL00002	RL00015	RL00015	RL00015	RL00015	RL00015
							RL00016	RL00016	RL00016	RL00016	RL00016
							9928150	9928150	9930880	9930880	9930880
ST00002	ST00002	ST00002	ST00002	ST00002	ST00002	ST00002	ST00021	ST00021	ST00020	ST00020	ST00020
9923550	9923550	9923550	9923550	9923550	9923550	9923550	9927130	9927130	9927130	9927130	9927130



YAMAHA	YAMAHA	YAMAHA	YAMAHA
T-MAX 59C ABS	T-MAX 59C ABS	T-MAX 59C ABS	T-MAX 59C SP
12-12	13-14	15-16	15-15
530cc 4T LC	530cc 4T LC	530cc 4T LC	530cc 4T LC
59C	59C	59C	59C

IT	EN	FR				
ALBERO A CAMME	CAM SHAFT	ARBRE À CAMES				
ALBERO MOTORE Sel 1	Crankshaft Sel 1	VILEBREQUIN Sél 1				
ALBERO MOTORE Sel 2	Crankshaft Sel 2	VILEBREQUIN Sél 2				
BIELLA	CONROD	BIELLE				
CAMPANA FRIZIONE	CLUTCH HOUSING	CLOCHE EMBRAYAGE				
CINGHIA DI TRASMISSIONE Bando	TRANSMISSION BELT Bando	COURROIE DE TRANSMISSION Bando				
CINGHIA DI TRASMISSIONE Mitsuboshi	TRANSMISSION BELT Mitsuboshi	COURROIE DE TRANSMISSION Mitsuboshi		9935960	9935960	9935960
CINGHIA DI TRASMISSIONE Altro	TRANSMISSION BELT Other	COURROIE DE TRANSMISSION Autres		9931570	9931570	9931570
COLLETTORE ASPIRAZIONE	INLET MANIFOLD	COLLECTEUR ASPIRATION				
COLLETTORE ASPIRAZIONE SX	INLET MANIFOLD LEFT	COLLECTEUR ASPIRATION GAUCHE				
COLLETTORE ASPIRAZIONE DX	INLET MANIFOLD RIGHT	COLLECTEUR ASPIRATION DROITE				
FILTRO OLIO	OIL FILTER	FILTRE À HUILE		F007517	F007517	F007517
FRIZIONE	CLUTCH	EMBRAYAGE				
GRUPPO TERMICO Standard	CYLINDER KIT Ø standard	CYLINDRE COMPLET Standard				
GRUPPO TERMICO Maggiorato	CYLINDER KIT BIG BORE	CYLINDRE COMPLET Majoré				
KIT CUSCINETTI PARAOLI DI BANCO Serie	BEARINGS AND OIL SEALS KIT	KIT PALIERS JOINTS D'HUILE DE VILEBREQUIN Jeu				
KIT REVISIONE POMPA ACQUA	WATER PUMP REPAIR KIT	KIT RÉVISION POMPE À EAU		AA00831	AA00831	AA00831
KIT TAGLIANDO	SERVICE KIT	KIT COUPON		TG00108	TG00108	TG00108
MASSE CENTRIFUGHE PESO ORIGINALE	ROLLER WEIGHTS Standard weight	MASSELOTES CENTRIFUGES POIDS D'ORIGINE		9922210	9922210	9922210
MEMBRANA CARBURATORE TIPO ORIGINALE	CARBURETOR DIAPHRAGM OEM	MEMBRANE CARBURATEUR TYPE ORIGINAL				
MEMBRANA CARBURATORE ADATTABILE	CARBURETOR DIAPHRAGM Adaptable	MEMBRANE CARBURATEUR ADAPTABLE				
MOLLE CONTRASTO VARIATORE	REAR VARIATOR SPRING	RESSORTS CONTRASTE VARIATEUR		9929880	9929880	9929880
MOLLA A GAS PER SELLA	SEAT GAS SPRING	RESSORT À GAZ POUR SELLE		9980200	9980200	9980200
MOTORINO D'AVVIAMENTO	STARTER ENGINE	DÉMARREUR ÉLECTRIQUE		MA00033	MA00033	MA00033
POMPA BENZINA	FUEL PUMP	POMPE À ESSENCE				
REGOLATORE DI TENSIONE	RECTIFIER	RÉGULATEUR DE TENSION		RE00033	RE00033	RE00033
RUOTA LIBERA Completa	STARTER CLUTCH SET	ROUE LIBRE Complète			RL00043	RL00043
RUOTA LIBERA RL + flangia	STARTER CLUTCH + FLANGE	ROUE LIBRE RL + flasque		RL00015	RL00015	RL00015
RUOTA LIBERA RL nuda	STARTER CLUTCH	ROUE LIBRE RL nue				
RUOTA LIBERA Ingranaggio	STARTER CLUTCH GEAR	ROUE LIBRE Engrenage		RL00016	RL00016	RL00016
RUOTA LIBERA Flangia	STARTER CLUTCH FLANGE	ROUE LIBRE Flasque				
SERIE DISCHI FRIZIONE	CLUTCH PLATES KIT	JEU DISQUES EMBRAYAGE		9930880	9930880	9930880
STATORE	STATOR	STATOR		ST00020	ST00020	ST00020
VARIOTOP TPR	VARIOTOP TPR	VARIOTOP TPR		9927130	9927130	9927130

YAMAHA	YAMAHA	YAMAHA	YAMAHA	YAMAHA	YAMAHA	YAMAHA	YAMAHA	YAMAHA	YAMAHA	YAMAHA	YAMAHA
T-MAX 59C SP ABS	T-MAX 5GJ	T-MAX 5VU	T-MAX 5VU	T-MAX 5VU	T-MAX 5VU	T-MAX 5VU ABS	T-MAX 5VU ABS	T-MAX 5VU ABS	T-MAX 5VU BLACK MAX	T-MAX 5VU BLACK MAX - NIGHT MAX	T-MAX SV
15-16	01-03	04-05	06-06	07-07	08-08	05-05	06-06	07-07	06-06	07-07	11-11
530cc 4T LC	500cc 4T LC	500cc 4T LC	500cc 4T LC	500cc 4T LC	500cc 4T LC	500cc 4T LC	500cc 4T LC	500cc 4T LC	500cc 4T LC	500cc 4T LC	500cc 4T LC
59C	5GJ	5VU	5VU	5VU	5VU	5VU	5VU	5VU	5VU	5VU	4B5
	9927550	9927550	9927550	9927550	9927550	9927550	9927550	9927550	9927550	9927550	
9935960											
9931570											
		CT00744	CT00744	CT00744	CT00744	CT00744	CT00744	CT00744	CT00744	CT00744	
		CT00745	CT00745	CT00745	CT00745	CT00745	CT00745	CT00745	CT00745	CT00745	
F007517	F007517	F007517	F007517	F007517	F007517	F007517	F007517	F007517	F007517	F007517	
AA00831		AA00820	AA00820	AA00820	AA00820	AA00820	AA00820	AA00820	AA00820	AA00820	
TG00108	TG00107	TG00107	TG00107	TG00107	TG00107	TG00107	TG00107	TG00107	TG00107	TG00107	
9922210	9922250	9922230	9922230	9922230	9922230	9922230	9922230	9922230	9922230	9922230	
9929880	9929880	9929880	9929880	9929880	9929880	9929880	9929880	9929880	9929880	9929880	
9980200					9980200				9980200		9980200
MA00033					MA00033				MA00033		MA00033
RE00033		RE00033	RE00033	RE00033	RE00022	RE00033	RE00033	RE00033	RE00033	RE00033	RE00022
RL00043											
RL00015	RL00015	RL00015	RL00015	RL00015	RL00015	RL00015	RL00015	RL00015	RL00015	RL00015	
RL00016	RL00016	RL00016	RL00016	RL00016	RL00016	RL00016	RL00016	RL00016	RL00016	RL00016	
9930880	9928150	9928150	9928150	9928150	9928150	9928150	9928150	9928150	9928150	9928150	
ST00020		ST00019	ST00019	ST00019	ST00021	ST00019	ST00019	ST00019	ST00019	ST00019	ST00021
9927130	9927130	9927130	9927130	9927130	9927130	9927130	9927130	9927130	9927130	9927130	

MAXI SCOOTER



YAMAHA	YAMAHA	YAMAHA	YAMAHA
T-MAX SV ABS	T-MAX WHITE MAX	TEO'S	TEO'S
10-11	10-10	00-00	01-02
500cc 4T LC	500cc 4T LC	125cc 4T LC	150cc 4T LC
4B5	4B5	Minarelli YP	Minarelli YP

IT	EN	FR				
ALBERO A CAMME	CAM SHAFT	ARBRE À CAMES				
ALBERO MOTORE Sel 1	Crankshaft Sel 1	VILEBREQUIN Sél 1			IM07045	
ALBERO MOTORE Sel 2	Crankshaft Sel 2	VILEBREQUIN Sél 2				
BIELLA	CONROD	BIELLE				
CAMPANA FRIZIONE	CLUTCH HOUSING	CLOCHE EMBRAYAGE				
CINGHIA DI TRASMISSIONE Bando	TRANSMISSION BELT Bando	COURROIE DE TRANSMISSION Bando			9915380	9915380
CINGHIA DI TRASMISSIONE Mitsuboshi	TRANSMISSION BELT Mitsuboshi	COURROIE DE TRANSMISSION Mitsuboshi			9935700	9935700
CINGHIA DI TRASMISSIONE Altro	TRANSMISSION BELT Other	COURROIE DE TRANSMISSION Autres				
COLLETTORE ASPIRAZIONE	INLET MANIFOLD	COLLECTEUR ASPIRATION			CT00730	CT00730
COLLETTORE ASPIRAZIONE SX	INLET MANIFOLD LEFT	COLLECTEUR ASPIRATION GAUCHE				
COLLETTORE ASPIRAZIONE DX	INLET MANIFOLD RIGHT	COLLECTEUR ASPIRATION DROITE				
FILTRO OLIO	OIL FILTER	FILTRE À HUILE				
FRIZIONE	CLUTCH	EMBRAYAGE				
GRUPPO TERMICO Standard	CYLINDER KIT Ø standard	CYLINDRE COMPLET Standard				
GRUPPO TERMICO Maggiorato	CYLINDER KIT BIG BORE	CYLINDRE COMPLET Majoré			9929380	9929380
KIT CUSCINETTI PARAOLI DI BANCO Serie	BEARINGS AND OIL SEALS KIT	KIT PALIERS JOINTS D'HUILE DE VILEBREQUIN Jeu			KK01010	KK01010
KIT REVISIONE POMPA ACQUA	WATER PUMP REPAIR KIT	KIT RÉVISION POMPE À EAU			AA00805	AA00805
KIT TAGLIANDO	SERVICE KIT	KIT COUPON				
MASSE CENTRIFUGHE PESO ORIGINALE	ROLLER WEIGHTS Standard weight	MASSELOTES CENTRIFUGES POIDS D'ORIGINE			9915270	
MEMBRANA CARBURATORE TIPO ORIGINALE	CARBURETOR DIAPHRAGM OEM	MEMBRANE CARBURATEUR TYPE ORIGINAL				
MEMBRANA CARBURATORE ADATTABILE	CARBURETOR DIAPHRAGM Adaptable	MEMBRANE CARBURATEUR ADAPTABLE			MC12100	MC12100
MOLLE CONTRASTO VARIATORE	REAR VARIATOR SPRING	RESSORTS CONTRASTE VARIATEUR			9929170	9929170
MOLLA A GAS PER SELLA	SEAT GAS SPRING	RESSORT À GAZ POUR SELLE		9980200	9980200	
MOTORINO D'AVVIAMENTO	STARTER ENGINE	DÉMARREUR ÉLECTRIQUE		MA00033	MA00033	MA00017 MA00017
POMPA BENZINA	FUEL PUMP	POMPE À ESSENCE				
REGOLATORE DI TENSIONE	RECTIFIER	RÉGULATEUR DE TENSION		RE00022	RE00022	RE00020
RUOTA LIBERA Completa	STARTER CLUTCH SET	ROUE LIBRE Complète				
RUOTA LIBERA RL + flangia	STARTER CLUTCH + FLANGE	ROUE LIBRE RL + flasque			RL00002	RL00002
RUOTA LIBERA RL nuda	STARTER CLUTCH	ROUE LIBRE RL nue				
RUOTA LIBERA Ingranaggio	STARTER CLUTCH GEAR	ROUE LIBRE Engrenage				
RUOTA LIBERA Flangia	STARTER CLUTCH FLANGE	ROUE LIBRE Flasque				
SERIE DISCHI FRIZIONE	CLUTCH PLATES KIT	JEU DISQUES EMBRAYAGE				
STATORE	STATOR	STATOR		ST00021	ST00021	ST00002 ST00002
VARIOTOP TPR	VARIOTOP TPR	VARIOTOP TPR			9923550	9923550

YAMAHA	YAMAHA	YAMAHA	YAMAHA	YAMAHA	YAMAHA	YAMAHA	YAMAHA	YAMAHA	YAMAHA	YAMAHA	YAMAHA
VERSITY	VERSITY	VERSITY	X-CITY	X-CITY	X-CITY	X-CITY	X-CITY EU3	X-MAX	X-MAX	X-MAX	X-MAX
03-03	04-05	06-06	07-07	08-08	09-12	13-15	08-11	05-06	07-09	10-12	12-13
300cc 4T LC	300cc 4T LC	300cc 4T LC	250cc 4T LC	250cc 4T LC	250cc 4T LC	250cc 4T LC	125cc 4T-4V LC	250cc 4T LC	250cc 4T LC	250cc 4T LC	250cc 4T LC
Minarelli YP	Minarelli YP	Minarelli YP					Minarelli				
							9927230				
			IM07054	IM07054	IM07054	IM07054	IM07072	IM07054	IM07054	IM07054	IM07054
IM07037	IM07037	IM07037	IM07037	IM07037	IM07037	IM07037		IM07037	IM07037	IM07037	IM07037
9925600	9925600	9925600	9925600	9925600	9925600	9925600	9925280	9925600	9925600	9925600	9925600
							F007523				
			9926850	9926850	9926850	9926850	9932700	9926850	9926850	9926850	9926850
							9925180				
KK01007	KK01007	KK01007	KK01007	KK01007	KK01007	KK01007		KK01007	KK01007	KK01007	KK01007
AA00806	AA00806	AA00806	AA00806	AA00806	AA00806	AA00806	AA00823	AA00806	AA00806	AA00806	AA00806
			TG00109	TG00109	TG00109	TG00109	TG00110		TG00109	TG00109	TG00109
9918020	9918020	9918020	9918060	9918060	9918060	9918020		9918020	9918020	9918060	9918020
MC12001	MC12001	MC12001									
MC12101	MC12101	MC12101									
			9929870	9929870	9929870	9929870	9926760	9929870	9929870	9929870	9929870
MA00010	MA00010	MA00010	MA00010	MA00010	MA00010	MA00010	MA00028	MA00010	MA00010	MA00010	MA00010
RE00022	RE00022	RE00022	RE00023	RE00023	RE00023	RE00023	RE00023	RE00022	RE00023	RE00030	RE00030
RL00010	RL00010	RL00010	RL00010	RL00010	RL00010	RL00010	RL00034	RL00010	RL00010	RL00010	RL00010
RL00011	RL00011	RL00011	RL00011	RL00011	RL00011	RL00011	RL00035	RL00011	RL00011	RL00011	RL00011
9931790	9931790	9931790	9931790	9931790	9931790	9931790	9925020	9931790	9931790	9931790	9931790

MAXI SCOOTER

MAXI SCOOTER



YAMAHA	YAMAHA	YAMAHA	YAMAHA
X-MAX	X-MAX	X-MAX	X-MAX ABS
14-16	13-14	15-16	11-12
250cc 4T LC	400cc 4T-4V LC	400cc 4T-4V LC	250cc 4T LC
	1SD	1SD	

IT	EN	FR				
ALBERO A CAMME	CAM SHAFT	ARBRE À CAMES				
ALBERO MOTORE Sel 1	Crankshaft Sel 1	VILEBREQUIN Sél 1		IM07054		
ALBERO MOTORE Sel 2	Crankshaft Sel 2	VILEBREQUIN Sél 2				
BIELLA	CONROD	BIELLE		IM07037		
CAMPANA FRIZIONE	CLUTCH HOUSING	CLOCHE EMBRAYAGE				
CINGHIA DI TRASMISSIONE Bando	TRANSMISSION BELT Bando	COURROIE DE TRANSMISSION Bando		9925600		9925600
CINGHIA DI TRASMISSIONE Mitsuboshi	TRANSMISSION BELT Mitsuboshi	COURROIE DE TRANSMISSION Mitsuboshi			9935650	9935650
CINGHIA DI TRASMISSIONE Altro	TRANSMISSION BELT Other	COURROIE DE TRANSMISSION Autres				
COLLETTORE ASPIRAZIONE	INLET MANIFOLD	COLLECTEUR ASPIRATION				
COLLETTORE ASPIRAZIONE SX	INLET MANIFOLD LEFT	COLLECTEUR ASPIRATION GAUCHE				
COLLETTORE ASPIRAZIONE DX	INLET MANIFOLD RIGHT	COLLECTEUR ASPIRATION DROITE				
FILTRO OLIO	OIL FILTER	FILTRE À HUILE			F007521	F007521
FRIZIONE	CLUTCH	EMBRAYAGE				
GRUPPO TERMICO Standard	CYLINDER KIT Ø standard	CYLINDRE COMPLET Standard		9926850		
GRUPPO TERMICO Maggiorato	CYLINDER KIT BIG BORE	CYLINDRE COMPLET Majoré				
KIT CUSCINETTI PARAOLI DI BANCO Serie	BEARINGS AND OIL SEALS KIT	KIT PALIERS JOINTS D'HUILE DE VILEBREQUIN Jeu		KK01007		
KIT REVISIONE POMPA ACQUA	WATER PUMP REPAIR KIT	KIT RÉVISION POMPE À EAU		AA00806	AA00818	AA00818
KIT TAGLIANDO	SERVICE KIT	KIT COUPON		TG00109		TG00109
MASSE CENTRIFUGHE PESO ORIGINALE	ROLLER WEIGHTS Standard weight	MASSELOTES CENTRIFUGES POIDS D'ORIGINE		9918020	9922230	9922230
MEMBRANA CARBURATORE TIPO ORIGINALE	CARBURETOR DIAPHRAGM OEM	MEMBRANE CARBURATEUR TYPE ORIGINAL				
MEMBRANA CARBURATORE ADATTABILE	CARBURETOR DIAPHRAGM Adaptable	MEMBRANE CARBURATEUR ADAPTABLE				
MOLLE CONTRASTO VARIATORE	REAR VARIATOR SPRING	RESSORTS CONTRASTE VARIATEUR		9929870		
MOLLA A GAS PER SELLA	SEAT GAS SPRING	RESSORT À GAZ POUR SELLE		9980250	9980250	9980250
MOTORINO D'AVVIAMENTO	STARTER ENGINE	DÉMARREUR ÉLECTRIQUE		MA00010	MA00010	MA00010
POMPA BENZINA	FUEL PUMP	POMPE À ESSENCE				
REGOLATORE DI TENSIONE	RECTIFIER	RÉGULATEUR DE TENSION		RE00023		RE00030
RUOTA LIBERA Completa	STARTER CLUTCH SET	ROUE LIBRE Complète				
RUOTA LIBERA RL + flangia	STARTER CLUTCH + FLANGE	ROUE LIBRE RL + flasque		RL00010	RL00019	RL00019
RUOTA LIBERA RL nuda	STARTER CLUTCH	ROUE LIBRE RL nue				
RUOTA LIBERA Ingranaggio	STARTER CLUTCH GEAR	ROUE LIBRE Engrenage		RL00011	RL00020	RL00020
RUOTA LIBERA Flangia	STARTER CLUTCH FLANGE	ROUE LIBRE Flasque				
SERIE DISCHI FRIZIONE	CLUTCH PLATES KIT	JEU DISQUES EMBRAYAGE				
STATORE	STATOR	STATOR			ST00022	
VARIOTOP TPR	VARIOTOP TPR	VARIOTOP TPR		9931790	9930360	9930360

YAMAHA	YAMAHA	YAMAHA	YAMAHA	YAMAHA	YAMAHA	YAMAHA	YAMAHA	YAMAHA	YAMAHA	YAMAHA	YAMAHA
X-MAX ABS	X-MAX ABS	X-MAX ABS	X-MAX ABS	X-MAX BLACK	X-MAX IRONMAX ABS	X-MAX MOMODESIGN	X-MAX MOMODESIGN ABS	X-MAX R	X-MAX R	X-MAX R	X-MAX R
14-15	14-15	14-14	15-17	09-09	16-16	14-14	14-14	06-07	08-09	10-12	12-13
250cc 4T LC	250cc 4T LC	400cc 4T-4V LC	400cc 4T-4V LC	250cc 4T LC	400cc 4T-4V LC	400cc 4T-4V LC	400cc 4T-4V LC	125cc 4T-4V LC	125cc 4T-4V LC	125cc 4T-4V LC	125cc 4T-4V LC
		1SD	1SD		1SD	1SD	1SD	Minarelli	Minarelli	Minarelli	Minarelli
								9927230	9927230	9927230	9927230
IM07054	IM07054							IM07072	IM07072	IM07072	IM07072
IM07037	IM07037										
9925600	9925600			9925600				9925280	9925280	9925280	9925280
		9935650	9935650		9935650	9935650	9935650				
		F007521	F007521		F007521	F007521	F007521	F007523	F007523	F007523	F007523
9926850	9926850							9932700	9932700	9932700	9932700
								9925180	9925180	9925180	9925180
KK01007	KK01007										
AA00806	AA00806	AA00818	AA00818		AA00818	AA00818	AA00818	AA00823	AA00823	AA00823	AA00823
TG00109	TG00109			TG00109				TG00110	TG00110	TG00110	TG00110
9918020	9918020	9922230	9922230		9922230	9922230	9922230				
9929870	9929870							9926760	9926760	9926760	9926760
	9980250	9980250	9980250		9980250	9980250	9980250				
MA00010	MA00010	MA00010	MA00010		MA00010	MA00010	MA00010	MA00028	MA00028	MA00028	MA00028
RE00030	RE00023			RE00023				RE00023	RE00023	RE00030	RE00030
RL00010	RL00010	RL00019	RL00019		RL00019	RL00019	RL00019	RL00034	RL00034	RL00034	RL00034
RL00011	RL00011	RL00020	RL00020		RL00020	RL00020	RL00020	RL00035	RL00035	RL00035	RL00035
		ST00022	ST00022		ST00022	ST00022	ST00022				
9931790	9931790	9930360	9930360	9931790	9930360	9930360	9930360	9925020	9925020	9925020	9925020



YAMAHA	YAMAHA	YAMAHA	YAMAHA
X-MAX R	X-MAX R	X-MAX R	X-MAX R ABS
14-14	14-14	15-16	11-11
125cc 4T-4V LC	125cc 4T-4V LC	125cc 4T-4V LC	125cc 4T-4V LC
Minarelli	Minarelli	Minarelli	Minarelli

IT	EN	FR				
ALBERO A CAMME	CAM SHAFT	ARBRE À CAMES		9927230	9927230	9927230
ALBERO MOTORE Sel 1	Crankshaft Sel 1	VILEBREQUIN Sél 1		IM07072		IM07072
ALBERO MOTORE Sel 2	Crankshaft Sel 2	VILEBREQUIN Sél 2				
BIELLA	CONROD	BIELLE				
CAMPANA FRIZIONE	CLUTCH HOUSING	CLOCHE EMBRAYAGE				
CINGHIA DI TRASMISSIONE Bando	TRANSMISSION BELT Bando	COURROIE DE TRANSMISSION Bando		9925280	9925280	9925280
CINGHIA DI TRASMISSIONE Mitsuboshi	TRANSMISSION BELT Mitsuboshi	COURROIE DE TRANSMISSION Mitsuboshi				
CINGHIA DI TRASMISSIONE Altro	TRANSMISSION BELT Other	COURROIE DE TRANSMISSION Autres				
COLLETTORE ASPIRAZIONE	INLET MANIFOLD	COLLECTEUR ASPIRATION				
COLLETTORE ASPIRAZIONE SX	INLET MANIFOLD LEFT	COLLECTEUR ASPIRATION GAUCHE				
COLLETTORE ASPIRAZIONE DX	INLET MANIFOLD RIGHT	COLLECTEUR ASPIRATION DROITE				
FILTRO OLIO	OIL FILTER	FILTRE À HUILE		F007523	F007523	F007523
FRIZIONE	CLUTCH	EMBRAYAGE				
GRUPPO TERMICO Standard	CYLINDER KIT Ø standard	CYLINDRE COMPLET Standard		9932700	9932700	9932700
GRUPPO TERMICO Maggiorato	CYLINDER KIT BIG BORE	CYLINDRE COMPLET Majoré		9925180		9925180
KIT CUSCINETTI PARAOLI DI BANCO Serie	BEARINGS AND OIL SEALS KIT	KIT PALIERS JOINTS D'HUILE DE VILEBREQUIN Jeu				
KIT REVISIONE POMPA ACQUA	WATER PUMP REPAIR KIT	KIT RÉVISION POMPE À EAU		AA00823	AA00823	AA00823
KIT TAGLIANDO	SERVICE KIT	KIT COUPON			TG00110	TG00110
MASSE CENTRIFUGHE PESO ORIGINALE	ROLLER WEIGHTS Standard weight	MASSELOTES CENTRIFUGES POIDS D'ORIGINE				
MEMBRANA CARBURATORE TIPO ORIGINALE	CARBURETOR DIAPHRAGM OEM	MEMBRANE CARBURATEUR TYPE ORIGINAL				
MEMBRANA CARBURATORE ADATTABILE	CARBURETOR DIAPHRAGM Adaptable	MEMBRANE CARBURATEUR ADAPTABLE				
MOLLE CONTRASTO VARIATORE	REAR VARIATOR SPRING	RESSORTS CONTRASTE VARIATEUR		9926760	9926760	9926760
MOLLA A GAS PER SELLA	SEAT GAS SPRING	RESSORT À GAZ POUR SELLE		9980250		9980250
MOTORINO D'AVVIAMENTO	STARTER ENGINE	DÉMARREUR ÉLECTRIQUE		MA00028	MA00028	MA00028
POMPA BENZINA	FUEL PUMP	POMPE À ESSENCE				
REGOLATORE DI TENSIONE	RECTIFIER	RÉGULATEUR DE TENSION		RE00023	RE00023	RE00023
RUOTA LIBERA Completa	STARTER CLUTCH SET	ROUE LIBRE Complète				
RUOTA LIBERA RL + flangia	STARTER CLUTCH + FLANGE	ROUE LIBRE RL + flasque		RL00034	RL00034	RL00034
RUOTA LIBERA RL nuda	STARTER CLUTCH	ROUE LIBRE RL nue				
RUOTA LIBERA Ingranaggio	STARTER CLUTCH GEAR	ROUE LIBRE Engrenage		RL00035	RL00035	RL00035
RUOTA LIBERA Flangia	STARTER CLUTCH FLANGE	ROUE LIBRE Flasque				
SERIE DISCHI FRIZIONE	CLUTCH PLATES KIT	JEU DISQUES EMBRAYAGE				
STATORE	STATOR	STATOR				
VARIOTOP TPR	VARIOTOP TPR	VARIOTOP TPR		9925020	9925020	9925020

YAMAHA	YAMAHA	YAMAHA	YAMAHA	YAMAHA	YAMAHA	YAMAHA	YAMAHA	YAMAHA	YAMAHA	YAMAHA	YAMAHA
X-MAX RA	X-MAX RA ABS	X-MAX RA ABS	X-MAX RA ABS	X-MAX RA ABS	X-MAX RA ABS	X-MAX RA ABS	X-MAX RA ABS	X-MAX SPORT	XC125R MAJESTY S	XENTER	XENTER
18-18	13-13	14-15	16-16	16-16	16-16	16-16	16-16	11-12	14-14	12-17	12-16
400cc 4T-4V LC	125cc 4T-4V LC	125cc 4T-4V LC	125cc 4T-4V LC	125cc 4T-4V LC	125cc 4T-4V LC	125cc 4T-4V LC	125cc 4T-4V LC	250cc 4T LC	125cc 4T LC	125cc 4T LC	150cc 4T LC
1SD	Minarelli	Minarelli	Minarelli	Minarelli	Minarelli	Minarelli	Minarelli				
	9927230	9927230	9927230								
	IM07072	IM07072	IM07072								
	9925280	9925280	9925280					9925600			
9935650									9935760	9935760	9935760
									9931610	9931610	9931610
F007521	F007523	F007523	F007523								
	9932700	9932700	9932700								
	9925180	9925180	9925180								
AA00818	AA00823	AA00823	AA00823						AA00832	AA00832	AA00832
	TG00110	TG00110	TG00110	TG00110	TG00110	TG00110	TG00110	TG00109			
9922230											
	9926760	9926760	9926760								
		9980250	9980250								
MA00010	MA00028	MA00028	MA00028								
	RE00030	RE00023	RE00023						RE00030		
RL00019	RL00034	RL00034	RL00034						RL00038	RL00038	RL00038
RL00020	RL00035	RL00035	RL00035								
ST00022											
9930360	9925020	9925020	9925020					9931790			



YAMAHA	YAMAHA	YAMAHA	YAMAHA
XP530-A T-MAX SX	XP530-A T-MAX SX	XP530-A T-MAX SX	XP530D-A T-MAX DX
17-17	18-18	19-19	17-17
530cc 4T LC	530cc 4T LC	530cc 4T LC	530cc 4T LC
BX3	BX3	BX3	BC3





IT	EN	FR				
ALBERO A CAMME	CAM SHAFT	ARBRE À CAMES				
ALBERO MOTORE Sel 1	Crankshaft Sel 1	VILEBREQUIN Sél 1				
ALBERO MOTORE Sel 2	Crankshaft Sel 2	VILEBREQUIN Sél 2				
BIELLA	CONROD	BIELLE				
CAMPANA FRIZIONE	CLUTCH HOUSING	CLOCHE EMBRAYAGE				
CINGHIA DI TRASMISSIONE Bando	TRANSMISSION BELT Bando	COURROIE DE TRANSMISSION Bando				
CINGHIA DI TRASMISSIONE Mitsuboshi	TRANSMISSION BELT Mitsuboshi	COURROIE DE TRANSMISSION Mitsuboshi		9935960	9935960	9935960
CINGHIA DI TRASMISSIONE Altro	TRANSMISSION BELT Other	COURROIE DE TRANSMISSION Autres				
COLLETTORE ASPIRAZIONE	INLET MANIFOLD	COLLECTEUR ASPIRATION				
COLLETTORE ASPIRAZIONE SX	INLET MANIFOLD LEFT	COLLECTEUR ASPIRATION GAUCHE				
COLLETTORE ASPIRAZIONE DX	INLET MANIFOLD RIGHT	COLLECTEUR ASPIRATION DROITE				
FILTRO OLIO	OIL FILTER	FILTRE À HUILE				
FRIZIONE	CLUTCH	EMBRAYAGE				
GRUPPO TERMICO Standard	CYLINDER KIT Ø standard	CYLINDRE COMPLET Standard				
GRUPPO TERMICO Maggiorato	CYLINDER KIT BIG BORE	CYLINDRE COMPLET Majoré				
KIT CUSCINETTI PARAOLI DI BANCO Serie	BEARINGS AND OIL SEALS KIT	KIT PALIERS JOINTS D'HUILE DE VILEBREQUIN Jeu				
KIT REVISIONE POMPA ACQUA	WATER PUMP REPAIR KIT	KIT RÉVISION POMPE À EAU		AA00831	AA00831	AA00831
KIT TAGLIANDO	SERVICE KIT	KIT COUPON				
MASSE CENTRIFUGHE PESO ORIGINALE	ROLLER WEIGHTS Standard weight	MASSELOTES CENTRIFUGES POIDS D'ORIGINE		9922210	9922210	9922210
MEMBRANA CARBURATORE TIPO ORIGINALE	CARBURETOR DIAPHRAGM OEM	MEMBRANE CARBURATEUR TYPE ORIGINAL				
MEMBRANA CARBURATORE ADATTABILE	CARBURETOR DIAPHRAGM Adaptable	MEMBRANE CARBURATEUR ADAPTABLE				
MOLLE CONTRASTO VARIATORE	REAR VARIATOR SPRING	RESSORTS CONTRASTE VARIATEUR		9929880	9929880	9929880
MOLLA A GAS PER SELLA	SEAT GAS SPRING	RESSORT À GAZ POUR SELLE		9980200	9980200	9980200
MOTORINO D'AVVIAMENTO	STARTER ENGINE	DÉMARREUR ÉLECTRIQUE		MA00033	MA00033	MA00033
POMPA BENZINA	FUEL PUMP	POMPE À ESSENCE		PB00908	PB00908	PB00908
REGOLATORE DI TENSIONE	RECTIFIER	RÉGULATEUR DE TENSION		RE00033	RE00033	RE00033
RUOTA LIBERA Completa	STARTER CLUTCH SET	ROUE LIBRE Complète		RL00043	RL00043	RL00043
RUOTA LIBERA RL + flangia	STARTER CLUTCH + FLANGE	ROUE LIBRE RL + flasque				
RUOTA LIBERA RL nuda	STARTER CLUTCH	ROUE LIBRE RL nue				
RUOTA LIBERA Ingranaggio	STARTER CLUTCH GEAR	ROUE LIBRE Engrenage		RL00016	RL00016	RL00016
RUOTA LIBERA Flangia	STARTER CLUTCH FLANGE	ROUE LIBRE Flasque				
SERIE DISCHI FRIZIONE	CLUTCH PLATES KIT	JEU DISQUES EMBRAYAGE		9930880	9930880	9930880
STATORE	STATOR	STATOR		ST00020	ST00020	ST00020
VARIOTOP TPR	VARIOTOP TPR	VARIOTOP TPR		9937600	9937600	9937600

YAMAHA	YAMAHA	YAMAHA	YAMAHA	YAMAHA	YAMAHA
XP530D-A T-MAX DX	XP530D-A T-MAX DX	XP530E-A T-MAX	XP530E-A T-MAX	XP560D T-MAX	XP560D T-MAX
18-18	19-19	17-17	18-18	20-20	20-20
530cc 4T LC	530cc 4T LC	530cc 4T LC	530cc 4T LC	560cc 4T LC	560cc 4T LC
BC3	BC3	BV11	BV11	B7m	B7m
AA00831	AA00831	AA00831	AA00831	AA00831	AA00831
9922210	9922210	9922210	9922210		
9929880	9929880	9929880	9929880	9929880	9929880
9980200	9980200	9980200	9980200	9980200	9980200
MA00033	MA00033	MA00033	MA00033	MA00033	MA00033
PB00908	PB00908	PB00908	PB00908	PB00908	PB00908
RE00033	RE00033	RE00033	RE00033	RE00033	RE00033
RL00043	RL00043	RL00043	RL00043	RL00043	RL00043
RL00016	RL00016	RL00016	RL00016		
9930880	9930880	9930880	9930880	9930880	9930880
ST00020	ST00020	ST00020	ST00020	ST00020	ST00020
9937600	9937600	9937600	9937600	9937600	9937600



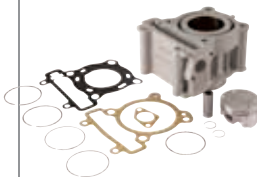
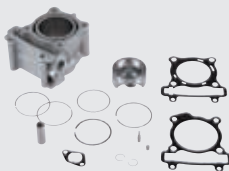

BETA	FANTIC	FANTIC	HM
RR	CABALLERO MOTARD	CABALLERO REGOLARITÀ	CITY
10-17	08-18	08-08	11-13
125cc 4T-4V LC	125cc 4T-4V LC	125cc 4T-4V LC	125cc 4T-4V LC
Minarelli - Yamaha MC 125	Minarelli - Yamaha MC 125	Minarelli - Yamaha MC 125	Minarelli - Yamaha MC 125





IT	EN	FR					
ALBERO A CAMME	CAM SHAFT	ARBRE À CAMES		9927230	9927230	9927230	9927230
GRUPPO TERMICO Ø STANDARD	CYLINDER KIT Ø STANDARD	CYLINDRE COMPLET Ø STANDARD		9932700	9932700	9932700	9932700
GRUPPO TERMICO MAGGIORATO	BIG BORE CYLINDER KIT	CYLINDRE COMPLET MAJORÉ		9927120	9927120	9927120	9927120
GRUPPO TERMICO CON CENTRALINA	CYLINDER KIT WITH ECU	CYLINDRE COMPLET DOTÉ DE BOÎTIER ÉLECTRONIQUE					
MOLLE FRIZIONE	CLUTCH SPRINGS	RESSORTS EMBRAYAGE		9927810	9927810	9927810	9927810
SCARICO	EXHAUST	ÉCHAPPEMENT					
FILTRO OLIO	OIL FILTER	FILTRE À HUILE		F007523	F007523	F007523	F007523

HM	HM	HM	HM	HM	HM	HM	HM	HM	HM	HM	HUSQVARNA
CITY	CRE F125X	CRE F125X BAJA	CRE F125X BAJA RR	CRE F125X SIX	CRM F125X	CRM F125X DERAPAGE	CRM F125X DERAPAGE COMPETITION	CRM F125X DERAPAGE RR	LOCUSTA	LOCUSTA	SM
11-13	08-09	10-12	10-12	10-11	08-09	10-12	10-11	10-12	11-13	11-13	10-10
200cc 4T-4V LC	125cc 4T-4V LC	125cc 4T-4V LC	125cc 4T-4V LC	125cc 4T-4V LC	125cc 4T-4V LC	125cc 4T-4V LC	125cc 4T-4V LC	125cc 4T-4V LC	125cc 4T-4V LC	200cc 4T-4V LC	125cc 4T-4V LC
Minarelli - Yamaha MC 200	Minarelli - Yamaha MC 125	Minarelli - Yamaha MC 125	Minarelli - Yamaha MC 125	Minarelli - Yamaha MC 125	Minarelli - Yamaha MC 125	Minarelli - Yamaha MC 125	Minarelli - Yamaha MC 125	Minarelli - Yamaha MC 125	Minarelli - Yamaha MC 125	Minarelli - Yamaha MC 200	Minarelli - Yamaha MC 125
9927230	9927230	9927230	9927230	9927230	9927230	9927230	9927230	9927230	9927230	9927230	9927230
	9932700	9932700	9932700	9932700	9932700	9932700	9932700	9932700	9932700	9932700	9932700
9927120	9927120	9927120	9927120	9927120	9927120	9927120	9927120	9927120	9927120	9927120	9927120
9927810	9927810	9927810	9927810	9927810	9927810	9927810	9927810	9927810	9927810	9927810	9927810
F007523	F007523	F007523		F007523	F007523	F007523	F007523	F007523	F007523	F007523	F007523

MOTO 125cc

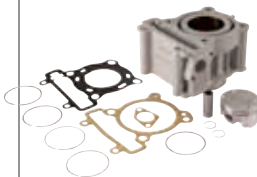
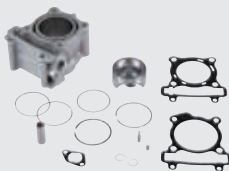

HUSQVARNA	MOTORHISPANIA	MOTORHISPANIA	MOTORHISPANIA
TE	KN1	MH7	RX-R
10-10	08-08	08-08	08-08
125cc 4T-4V LC	125cc 4T-4V LC	125cc 4T-4V LC	125cc 4T-4V LC
Minarelli - Yamaha MC 125	Minarelli - Yamaha MC 125	Minarelli - Yamaha MC 125	Minarelli - Yamaha MC 125





IT	EN	FR					
ALBERO A CAMME	CAM SHAFT	ARBRE À CAMES		9927230	9927230	9927230	9927230
GRUPPO TERMICO Ø STANDARD	CYLINDER KIT Ø STANDARD	CYLINDRE COMPLET Ø STANDARD		9932700	9932700	9932700	9932700
GRUPPO TERMICO MAGGIORATO	BIG BORE CYLINDER KIT	CYLINDRE COMPLET MAJORÉ		9927120	9927120	9927120	9927120
GRUPPO TERMICO CON CENTRALINA	CYLINDER KIT WITH ECU	CYLINDRE COMPLET DOTÉ DE BOÎTIER ÉLECTRONIQUE					
MOLLE FRIZIONE	CLUTCH SPRINGS	RESSORTS EMBRAYAGE		9927810	9927810	9927810	9927810
SCARICO	EXHAUST	ÉCHAPPEMENT					
FILTRO OLIO	OIL FILTER	FILTRE À HUILE		F007523	F007523	F007523	F007523

RIEJU	RIEJU	RIEJU	RIEJU	VENT	VENT	VENT	VENT	VENT	YAMAHA	YAMAHA	YAMAHA
MARATHON	MARATHON PRO	MARATHON PRO COMPETITION	RS3	BAJA	BAJA RR	DERAPAGE	DERAPAGE RR	TRAIL	MT	MT A	WR-R IE
09-09	09-09	11-11	11-11	18-19	18-19	18-19	18-19	18-19	15-15	15-15	09-11
125cc 4T-4V LC	125cc 4T-4V LC	125cc 4T-4V LC	125cc 4T-4V LC	125cc 4T-4V LC	125cc 4T-4V LC	125cc 4T-4V LC	125cc 4T-4V LC	125cc 4T-4V LC	125cc 4T 4V IE LC	125cc 4T 4V IE LC	125cc 4T 4V IE LC
Minarelli - Yamaha MC 125	Minarelli - Yamaha MC 125	Minarelli - Yamaha MC 125	Minarelli - Yamaha MC 125	Minarelli - Yamaha MC 125	Minarelli - Yamaha MC 125	Minarelli - Yamaha MC 125	Minarelli - Yamaha MC 125	Minarelli - Yamaha MC 125	Minarelli - Yamaha MC 125	Minarelli - Yamaha MC 125	Minarelli - Yamaha MC 125
9927230	9927230	9927230	9927230	9927230	9927230	9927230	9927230	9927230	9927230	9927230	9927230
9932700	9932700	9932700	9932700	9932700	9932700	9932700	9932700	9932700	9932700	9932700	9932700
9927120	9927120	9927120	9927120	9927120	9927120	9927120	9927120	9927120	9927120	9927120	9927120
											9927260
9927810	9927810	9927810	9927810	9927810	9927810	9927810	9927810	9927810	9927810	9927810	9927810
F007523	F007523	F007523	F007523	F007523	F007523	F007523	F007523	F007523	F007523	F007523	F007523

MOTO 125cc

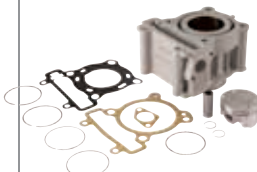
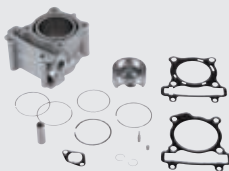

YAMAHA	YAMAHA	YAMAHA	YAMAHA
WR-X IE	WR-X IE	YZF-R A IE	YZF-R IE
09-11	13-14	15-15	08-11
125cc 4T 4V IE LC	125cc 4T 4V IE LC	125cc 4T 4V IE LC	125cc 4T 4V IE LC
Minarelli - Yamaha MC 125	Minarelli - Yamaha MC 125	Minarelli - Yamaha MC 125	Minarelli - Yamaha MC 125

IT	EN	FR					
ALBERO A CAMME	CAM SHAFT	ARBRE À CAMES		9927230	9927230	9927230	9927230
GRUPPO TERMICO Ø STANDARD	CYLINDER KIT Ø STANDARD	CYLINDRE COMPLET Ø STANDARD		9932700	9932700	9932700	9932700
GRUPPO TERMICO MAGGIORATO	BIG BORE CYLINDER KIT	CYLINDRE COMPLET MAJORÉ					
GRUPPO TERMICO CON CENTRALINA	CYLINDER KIT WITH ECU	CYLINDRE COMPLET DOTÉ DE BOÎTIER ÉLECTRONIQUE		9927260	9927260		9926900
MOLLE FRIZIONE	CLUTCH SPRINGS	RESSORTS EMBRAYAGE		9927810	9927810	9927810	9927810
SCARICO	EXHAUST	ÉCHAPPEMENT					9927350
FILTRO OLIO	OIL FILTER	FILTRE À HUILE		F007523	F007523	F007523	F007523

YAMAHA	YAMAHA	YAMAHA	YAMAHA
YZF-R IE	YZF-R IE	YZF-R IE	YZF-R IE
12-12	13-13	14-14	15-15
125cc 4T 4V IE LC	125cc 4T 4V IE LC	125cc 4T 4V IE LC	125cc 4T 4V IE LC
Minarelli - Yamaha MC 125	Minarelli - Yamaha MC 125	Minarelli - Yamaha MC 125	Minarelli - Yamaha MC 125
9927230	9927230	9927230	9927230
9932700	9932700	9932700	9932700
9926900	9926900		
9927810	9927810	9927810	9927810
9927350	9927350		
F007523	F007523	F007523	F007523



MOTO 125cc



ATV QUAD



DINLI	DINLI	DINLI	E-TON
HELIX DL603	HELIX DL603 90	T-REX	VIPER RXL
07-13	07-13	07-13	06-06
50cc 2T AC	50cc 2T AC	50cc 2T AC	50cc 2T AC

IT	EN	FR				
ALBERO MOTORE	Crankshaft	VILEBREQUIN				
CAMPANA + FRIZIONE	CLUTCH + CLUTCH HOUSING	CLOCHE + EMBRAYAGE		9925130	9925130	9925130
CINGHIA DI TRASMISSIONE TOP	TRANSMISSION BELT TOP	COURROIE DE TRANSMISSION TOP		9907900	9907900	9907900
CONVERTITORE DI COPPIA	TORQUE CONVERTER	CONVERTISSEUR DE COUPLE				
GRUPPO TERMICO Ø 40 standard	CYLINDER KIT Ø 40 standard	CYLINDRE COMPLET Ø 40 Standard		9931140		9931140
GRUPPO TERMICO Ø maggiorato	CYLINDER KIT BIG BORE	CYLINDRE COMPLET Ø majoré		9931340		9931340
RUOTA LIBERA ingranaggio	STARTER CLUTCH GEAR	ROUE LIBRE engrenage				
RUOTA LIBERA con flangia	STARTER CLUTCH + FLANGE	ROUE LIBRE avec flasque				
KIT CUSCINETTI E PARAOLI	BEARINGS AND OIL SEALS KIT	KIT PALIERS ET JOINTS D'HUILE				
KIT REVISIONE POMPA ACQUA	WATER PUMP REPAIR KIT	KIT RÉVISION POMPE À EAU				
MOTORINO AVVIAMENTO	STARTER ENGINE	DÉMARREUR ÉLECTRIQUE				
VALVOLA LAMELLARE	REED VALVE	CLAPET À LAMELLES		9908370	9908370	9908370
VARIOTOP TPR	VARIOTOP TPR	VARIOTOP TPR				

GILERA	KEEWAY	KEEWAY	KYMCO	KYMCO	KYMCO	KYMCO	KYMCO	KYMCO	KYMCO	KYMCO	KYMCO
OREGON	ATV EC2	ATV OFF ROAD	KXR	KXR	MAXXER	MAXXER	MXER	MXER EU2	MXU	MXU	MXU
06-10	06-06	07-07	04-04	03-04	05-05	05-06	02-03	04-04	06-07	05-05	05-06
250cc 4T LC	50cc 2T AC	50cc 2T AC	50cc 2T AC	250cc 4T LC	50cc 2T AC	300cc 4T LC	50cc 2T AC	50cc 2T AC	50cc 2T AC	250cc 4T LC	300cc 4T LC
	Motore Keeway	Motore Keeway									
	IM07065	IM07065									
	9925130	9925130									
	9913280	9913280									
	9923030	9923030									
	9925650	9925650									
	9924890	9924890									
				RL00009		RL00009				RL00009	RL00009
				RL00008		RL00008 RL00028				RL00008	RL00008 RL00028
			KK01013		KK01013		KK01013	KK01013	KK01013		
AA00828											
MA00016			MA00014		MA00014		MA00014	MA00014	MA00014		
	9908370	9908370									
	9924900	9924900									



IT	EN	FR			
ALBERO MOTORE	Crankshaft	VILEBREQUIN			
CAMPANA + FRIZIONE	CLUTCH + CLUTCH HOUSING	CLOCHE + EMBRAYAGE			9925130
CINGHIA DI TRASMISSIONE TOP	TRANSMISSION BELT TOP	COURROIE DE TRANSMISSION TOP			9907900
CONVERTITORE DI COPPIA	TORQUE CONVERTER	CONVERTISSEUR DE COUPLE			
GRUPPO TERMICO Ø 40 standard	CYLINDER KIT Ø 40 standard	CYLINDRE COMPLET Ø 40 Standard			9931140
GRUPPO TERMICO Ø maggiorato	CYLINDER KIT BIG BORE	CYLINDRE COMPLET Ø majoré			9931340
RUOTA LIBERA ingranaggio	STARTER CLUTCH GEAR	ROUE LIBRE engrenage		RL00031	
RUOTA LIBERA con flangia	STARTER CLUTCH + FLANGE	ROUE LIBRE avec flasque		RL00028	
KIT CUSCINETTI E PARAOLI	BEARINGS AND OIL SEALS KIT	KIT PALIERS ET JOINTS D'HUILE			KK01013
KIT REVISIONE POMPA ACQUA	WATER PUMP REPAIR KIT	KIT RÉVISION POMPE À EAU			
MOTORINO AVVIAMENTO	STARTER ENGINE	DÉMARREUR ÉLECTRIQUE			MA00014
VALVOLA LAMELLARE	REED VALVE	CLAPET À LAMELLES			9908370
VARIOTOP TPR	VARIOTOP TPR	VARIOTOP TPR			



9931340
Gruppo termico maggiorato



GILERA	LML	LML	LML
ICE	STAR DELUXE EU1	STAR DELUXE EU1	STAR DELUXE EU3
01-05	01-03	01-03	08-09
50cc 2T	125cc 2T AC	150cc 2T AC	125cc 2T AC
Motore Piaggio			

IT	EN	FR				
CILINDRETTI FRENO	BRAKE CALLIPERS	CYLINDRES FREIN				
FRIZIONE	CLUTCH	EMBAYAGE			FZ00307	FZ00307
GANASCE FRENO	BRAKE SHOE	MÂCHOIRES FREIN		CP00240		
GRUPPO TERMICO Ø Standard Spinotto 10	GRUPPO TERMICO Ø Standard pin 10	CYLINDRE COMPLET Ø Standard Axe de Piston Ø 10				
GRUPPO TERMICO Ø Standard Spinotto 12	CYLINDER KIT Ø Standard Pin 12	CYLINDRE COMPLET Ø Standard Axe de Piston Ø 12				
GRUPPO TERMICO Ø Maggiorato Spinotto 10	CYLINDER KIT BIG BORE pin 10	CYLINDRE COMPLET Ø majoré Axe de Piston Ø 10				
GRUPPO TERMICO Ø Maggiorato Spinotto 12	CYLINDER KIT BIG BORE pin 12	CYLINDRE COMPLET Ø majoré Axe de Piston Ø 12				
GRUPPO TERMICO Ø 47 3 Travasi	CYLINDER KIT Ø 47 3 Ports	CYLINDRE COMPLET Ø 47 3 Transvasements				
GRUPPO TERMICO Ø 47 6 Travasi	CYLINDER KIT Ø 47 6 Ports	CYLINDRE COMPLET Ø 47 6 Transvasements				
GRUPPO TERMICO Ø 47 10 Luci	CYLINDER KIT Ø 47 10 Ports	CYLINDRE COMPLET Ø 47 10 Ouvertures				
GRUPPO TERMICO Ø 50 3 Travasi	CYLINDER KIT Ø 50 3 Ports	CYLINDRE COMPLET Ø 50 3 Transvasements				
GRUPPO TERMICO Ø 55 6 Travasi	CYLINDER KIT Ø 55 6 Ports	CYLINDRE COMPLET Ø 55 6 Transvasements				
GRUPPO TERMICO Ø 57 con testa	CYLINDER KIT Ø 57 with cylinder head	CYLINDRE COMPLET Ø 57 avec culasse				
GRUPPO TERMICO Ø 60 con testa	CYLINDER KIT Ø 60 with cylinder head	CYLINDRE COMPLET Ø 60 avec culasse				
GRUPPO TERMICO Ø 63	CYLINDER KIT Ø 63	CYLINDRE COMPLET Ø 63			KT00017	KT00017
GRUPPO TERMICO Ø 69 Spinotto 18	CYLINDER KIT Ø 69 Pin 18	CYLINDRE COMPLET Ø 69 Axe de Piston Ø 18				
GRUPPO TERMICO Ø 69 Spinotto 16	CYLINDER KIT Ø 69 Pin 16	CYLINDRE COMPLET Ø 69 Axe de Piston Ø 16				
GRUPPO TERMICO Ø Maggiorato Alluminio	CYLINDER KIT BIG BORE Aluminium	CYLINDRE COMPLET Ø majoré aluminium			KT00136	KT00136
SERIE GUARNIZIONI MOTORE	ENGINE GASKET SET	JEU DE JOINTS MOTEUR				
SCARICO	EXHAUST	ÉCHAPPEMENT				

LML	PIAGGIO	PIAGGIO	PIAGGIO	PIAGGIO	PIAGGIO	PIAGGIO	PIAGGIO	PIAGGIO	PIAGGIO	PIAGGIO	PIAGGIO
STAR DELUXE EU3	APE	APE	APE CAR P2 (1ª SERIE)	APE EU4	APE FL - FL2	APE FL3 EUROPA	APE MIX 2T	APE MP	APE MPM 600	APE MPR 500	APE MPV 600
08-09	09-11	12-17	78-82	18-18	89-95	96-99	98-08	78-96	78-83	78-83	78-83
150cc 2T AC	50cc 2T AC	50cc 2T AC	220cc 2T AC	50cc 2T LC	50cc 2T AC	50cc 2T AC	50cc 2T AC	220cc 2T AC	220cc 2T AC	220cc 2T AC	220cc 2T AC

	CF12757	CF12757	CF12750		CF12757	CF12757	CF12757				
FZ00307	FZ00329	FZ00329		FZ00329	FZ00329	FZ00329	FZ00329				
	KT00010	KT00010			KT00010	KT00010	KT00010				
	KT00011	KT00011			KT00011	KT00011	KT00011				
	KT00013	KT00013			KT00013	KT00013	KT00013				
	KT00049	KT00049			KT00049	KT00049	KT00049				
	KT00012	KT00012			KT00012	KT00012	KT00012				
	KT00014	KT00014			KT00014	KT00014	KT00014				
KT00017											
			KT00019								
								KT00020	KT00020	KT00020	KT00020
KT00136											

DR Classic



PIAGGIO	PIAGGIO	PIAGGIO	PIAGGIO
APE P	APE P 501	APE P 601	APE P 601V
80-85	78-85	78-83	78-83
50cc 2T AC	220cc 2T AC	220cc 2T AC	220cc 2T AC

IT	EN	FR				
CILINDRETTI FRENO	BRAKE CALLIPERS	CYLINDRES FREIN			CF12750	CF12750
FRIZIONE	CLUTCH	EMBAYAGE		FZ00301 FZ00302 FZ00306		
GANASCE FRENO	BRAKE SHOE	MÂCHOIRES FREIN				
GRUPPO TERMICO Ø Standard Spinotto 10	GRUPPO TERMICO Ø Standard pin 10	CYLINDRE COMPLET Ø Standard Axe de Piston Ø 10				
GRUPPO TERMICO Ø Standard Spinotto 12	CYLINDER KIT Ø Standard Pin 12	CYLINDRE COMPLET Ø Standard Axe de Piston Ø 12		KT00010		
GRUPPO TERMICO Ø Maggiorato Spinotto 10	CYLINDER KIT BIG BORE pin 10	CYLINDRE COMPLET Ø majoré Axe de Piston Ø 10				
GRUPPO TERMICO Ø Maggiorato Spinotto 12	CYLINDER KIT BIG BORE pin 12	CYLINDRE COMPLET Ø majoré Axe de Piston Ø 12				
GRUPPO TERMICO Ø 47 3 Travasi	CYLINDER KIT Ø 47 3 Ports	CYLINDRE COMPLET Ø 47 3 Transvasements		KT00011		
GRUPPO TERMICO Ø 47 6 Travasi	CYLINDER KIT Ø 47 6 Ports	CYLINDRE COMPLET Ø 47 6 Transvasements		KT00013		
GRUPPO TERMICO Ø 47 10 Luci	CYLINDER KIT Ø 47 10 Ports	CYLINDRE COMPLET Ø 47 10 Ouvertures		KT00049		
GRUPPO TERMICO Ø 50 3 Travasi	CYLINDER KIT Ø 50 3 Ports	CYLINDRE COMPLET Ø 50 3 Transvasements		KT00012		
GRUPPO TERMICO Ø 55 6 Travasi	CYLINDER KIT Ø 55 6 Ports	CYLINDRE COMPLET Ø 55 6 Transvasements		KT00014		
GRUPPO TERMICO Ø 57 con testa	CYLINDER KIT Ø 57 with cylinder head	CYLINDRE COMPLET Ø 57 avec culasse				
GRUPPO TERMICO Ø 60 con testa	CYLINDER KIT Ø 60 with cylinder head	CYLINDRE COMPLET Ø 60 avec culasse				
GRUPPO TERMICO Ø 63	CYLINDER KIT Ø 63	CYLINDRE COMPLET Ø 63				
GRUPPO TERMICO Ø 69 Spinotto 18	CYLINDER KIT Ø 69 Pin 18	CYLINDRE COMPLET Ø 69 Axe de Piston Ø 18			KT00019	KT00019
GRUPPO TERMICO Ø 69 Spinotto 16	CYLINDER KIT Ø 69 Pin 16	CYLINDRE COMPLET Ø 69 Axe de Piston Ø 16				KT00019
GRUPPO TERMICO Ø Maggiorato Alluminio	CYLINDER KIT BIG BORE Aluminium	CYLINDRE COMPLET Ø majoré aluminium				
SERIE GUARNIZIONI MOTORE	ENGINE GASKET SET	JEU DE JOINTS MOTEUR				
SCARICO	EXHAUST	ÉCHAPPEMENT				

PIAGGIO	PIAGGIO	PIAGGIO	PIAGGIO	PIAGGIO	PIAGGIO	PIAGGIO	PIAGGIO	PIAGGIO	PIAGGIO	PIAGGIO	PIAGGIO
APE RST MIX	APE TM	APE TM P	APE TM P 602	APE TM P 703 - P 703 V, FL2	BOSS	BOXER	BRAVO 3	BRAVO ERRE 2	CIAO	CIAO EU1	CIAO EU2
99-03	09-16	85-89	82-83	84-05	88-89	70-83	87-90	75-81	80-88	99-01	02-04
50cc 2T AC	220cc 2T AC	50cc 2T AC	220cc 2T AC	220cc 2T AC	50cc 2T AC	50cc 2T AC	50cc 2T AC	50cc 2T AC	50cc 2T AC	50cc 2T AC	50cc 2T AC
CF12757	CF12754 CF12755		CF12754 CF12755	CF12754 CF12755							
FZ00329		FZ00301 FZ00302 FZ00306						FZ00320	FZ00320	FZ00320	FZ00320
					KT00005	KT00005	KT00005	KT00005	KT00005	KT00005	KT00005
KT00010		KT00010			KT00004	KT00004	KT00004	KT00004	KT00004	KT00004	KT00004
					KT00067	KT00067	KT00067	KT00067	KT00067	KT00067	KT00067
					KT00066	KT00066	KT00066	KT00066	KT00066	KT00066	KT00066
KT00011		KT00011									
KT00013		KT00013									
KT00049		KT00049									
KT00012		KT00012									
KT00014		KT00014									



PIAGGIO	PIAGGIO	PIAGGIO	PIAGGIO
CIAO MIX TEEN	CIAO TRE	COSA 2	COSA CL, CLX
96-01	71-99	91-97	88-91
50cc 2T AC	50cc 2T AC	125cc 2T AC	125cc 2T AC

IT	EN	FR				
CILINDRETTI FRENO	BRAKE CALLIPERS	CYLINDRES FREIN				
FRIZIONE	CLUTCH	EMBAYAGE		FZ00320		FZ00303 FZ00307
GANASCE FRENO	BRAKE SHOE	MÂCHOIRES FREIN				
GRUPPO TERMICO Ø Standard Spinotto 10	GRUPPO TERMICO Ø Standard pin 10	CYLINDRE COMPLET Ø Standard Axe de Piston Ø 10		KT00005	KT00005	
GRUPPO TERMICO Ø Standard Spinotto 12	CYLINDER KIT Ø Standard Pin 12	CYLINDRE COMPLET Ø Standard Axe de Piston Ø 12		KT00004	KT00004	
GRUPPO TERMICO Ø Maggiorato Spinotto 10	CYLINDER KIT BIG BORE pin 10	CYLINDRE COMPLET Ø majoré Axe de Piston Ø 10		KT00067	KT00067	
GRUPPO TERMICO Ø Maggiorato Spinotto 12	CYLINDER KIT BIG BORE pin 12	CYLINDRE COMPLET Ø majoré Axe de Piston Ø 12		KT00066	KT00066	
GRUPPO TERMICO Ø 47 3 Travasi	CYLINDER KIT Ø 47 3 Ports	CYLINDRE COMPLET Ø 47 3 Transvasements				
GRUPPO TERMICO Ø 47 6 Travasi	CYLINDER KIT Ø 47 6 Ports	CYLINDRE COMPLET Ø 47 6 Transvasements				
GRUPPO TERMICO Ø 47 10 Luci	CYLINDER KIT Ø 47 10 Ports	CYLINDRE COMPLET Ø 47 10 Ouvertures				
GRUPPO TERMICO Ø 50 3 Travasi	CYLINDER KIT Ø 50 3 Ports	CYLINDRE COMPLET Ø 50 3 Transvasements				
GRUPPO TERMICO Ø 55 6 Travasi	CYLINDER KIT Ø 55 6 Ports	CYLINDRE COMPLET Ø 55 6 Transvasements				
GRUPPO TERMICO Ø 57 con testa	CYLINDER KIT Ø 57 with cylinder head	CYLINDRE COMPLET Ø 57 avec culasse				
GRUPPO TERMICO Ø 60 con testa	CYLINDER KIT Ø 60 with cylinder head	CYLINDRE COMPLET Ø 60 avec culasse				
GRUPPO TERMICO Ø 63	CYLINDER KIT Ø 63	CYLINDRE COMPLET Ø 63				
GRUPPO TERMICO Ø 69 Spinotto 18	CYLINDER KIT Ø 69 Pin 18	CYLINDRE COMPLET Ø 69 Axe de Piston Ø 18				
GRUPPO TERMICO Ø 69 Spinotto 16	CYLINDER KIT Ø 69 Pin 16	CYLINDRE COMPLET Ø 69 Axe de Piston Ø 16				
GRUPPO TERMICO Ø Maggiorato Alluminio	CYLINDER KIT BIG BORE Aluminium	CYLINDRE COMPLET Ø majoré aluminium				
SERIE GUARNIZIONI MOTORE	ENGINE GASKET SET	JEU DE JOINTS MOTEUR				
SCARICO	EXHAUST	ÉCHAPPEMENT				

PIAGGIO	PIAGGIO	PIAGGIO	PIAGGIO	PIAGGIO	PIAGGIO	PIAGGIO	PIAGGIO	PIAGGIO	PIAGGIO	PIAGGIO	PIAGGIO
COSA CL, CLX	COSA CL, CLX	ECO	GRILLO	SI	SI FL2	SI MIX	VESPA ET3	VESPA FL	VESPA FL	VESPA FL2 AUTOMATICA	VESPA FL2 HP
88-91	88-91	79-89	89-93	79-88	91-97	96-99	76-83	90-90	89-90	90-91	91-97
150cc 2T AC	200cc 2T AC	50cc 2T AC	50cc 2T AC	50cc 2T AC	50cc 2T AC	50cc 2T AC	125cc 2T AC	50cc 2T AC	125cc 2T AC	50cc 2T AC	50cc 2T AC

FZ00303	FZ00305 FZ00318		FZ00320	FZ00320	FZ00320	FZ00320	FZ00301 FZ00302 FZ00306	FZ00329	FZ00329		FZ00329
								CP00212	CP00212	CP00212	CP00212
			KT00005	KT00005	KT00005	KT00005					
			KT00004	KT00004	KT00004	KT00004		KT00010			KT00010
		KT00067	KT00067	KT00067	KT00067	KT00067					
		KT00066	KT00066	KT00066	KT00066	KT00066					
								KT00011			KT00011
								KT00013			KT00013
								KT00049			KT00049
								KT00012			KT00012
								KT00014			KT00014
							KT00015				
								KT00135			
							GR00742	GR00741	GR00743		GR00741

DR Classic



PIAGGIO	PIAGGIO	PIAGGIO	PIAGGIO
VESPA N	VESPA PK	VESPA PK	VESPA PK AUTOMATICA
89-90	82-84	82-84	84-89
50cc 2T AC	50cc 2T AC	125cc 2T AC	50cc 2T AC

IT	EN	FR				
CILINDRETTI FRENO	BRAKE CALLIPERS	CYLINDRES FREIN				
FRIZIONE	CLUTCH	EMBAYAGE		FZ00301 FZ00302 FZ00306	FZ00301 FZ00302 FZ00306	FZ00301 FZ00302 FZ00306
GANASCE FRENO	BRAKE SHOE	MÂCHOIRES FREIN		CP00212	CP00212	CP00212
GRUPPO TERMICO Ø Standard Spinotto 10	GRUPPO TERMICO Ø Standard pin 10	CYLINDRE COMPLET Ø Standard Axe de Piston Ø 10				
GRUPPO TERMICO Ø Standard Spinotto 12	CYLINDER KIT Ø Standard Pin 12	CYLINDRE COMPLET Ø Standard Axe de Piston Ø 12		KT00010	KT00010	
GRUPPO TERMICO Ø Maggiorato Spinotto 10	CYLINDER KIT BIG BORE pin 10	CYLINDRE COMPLET Ø majoré Axe de Piston Ø 10				
GRUPPO TERMICO Ø Maggiorato Spinotto 12	CYLINDER KIT BIG BORE pin 12	CYLINDRE COMPLET Ø majoré Axe de Piston Ø 12				
GRUPPO TERMICO Ø 47 3 Travasi	CYLINDER KIT Ø 47 3 Ports	CYLINDRE COMPLET Ø 47 3 Transvasements		KT00011	KT00011	
GRUPPO TERMICO Ø 47 6 Travasi	CYLINDER KIT Ø 47 6 Ports	CYLINDRE COMPLET Ø 47 6 Transvasements		KT00013	KT00013	
GRUPPO TERMICO Ø 47 10 Luci	CYLINDER KIT Ø 47 10 Ports	CYLINDRE COMPLET Ø 47 10 Ouvertures		KT00049	KT00049	
GRUPPO TERMICO Ø 50 3 Travasi	CYLINDER KIT Ø 50 3 Ports	CYLINDRE COMPLET Ø 50 3 Transvasements		KT00012	KT00012	
GRUPPO TERMICO Ø 55 6 Travasi	CYLINDER KIT Ø 55 6 Ports	CYLINDRE COMPLET Ø 55 6 Transvasements		KT00014	KT00014	
GRUPPO TERMICO Ø 57 con testa	CYLINDER KIT Ø 57 with cylinder head	CYLINDRE COMPLET Ø 57 avec culasse				
GRUPPO TERMICO Ø 60 con testa	CYLINDER KIT Ø 60 with cylinder head	CYLINDRE COMPLET Ø 60 avec culasse				
GRUPPO TERMICO Ø 63	CYLINDER KIT Ø 63	CYLINDRE COMPLET Ø 63				
GRUPPO TERMICO Ø 69 Spinotto 18	CYLINDER KIT Ø 69 Pin 18	CYLINDRE COMPLET Ø 69 Axe de Piston Ø 18				
GRUPPO TERMICO Ø 69 Spinotto 16	CYLINDER KIT Ø 69 Pin 16	CYLINDRE COMPLET Ø 69 Axe de Piston Ø 16				
GRUPPO TERMICO Ø Maggiorato Alluminio	CYLINDER KIT BIG BORE Aluminium	CYLINDRE COMPLET Ø majoré aluminium				
SERIE GUARNIZIONI MOTORE	ENGINE GASKET SET	JEU DE JOINTS MOTEUR		GR00741	GR00741	GR00743
SCARICO	EXHAUST	ÉCHAPPEMENT				

PIAGGIO	PIAGGIO	PIAGGIO	PIAGGIO	PIAGGIO	PIAGGIO	PIAGGIO	PIAGGIO	PIAGGIO	PIAGGIO	PIAGGIO	PIAGGIO
VESPA PK XL	VESPA PK XL	VESPA PK XL PLURIMATIC	VESPA PK XL RUSH	VESPA PRIMAVERA	VESPA PX	VESPA PX	VESPA PX	VESPA PX	VESPA PX	VESPA PX 30 ANNI	VESPA PX E (DEU)
85-88	86-89	85-90	88-89	67-83	98-01	11-16	98-01	11-16	98-01	07-08	81-97
50cc 2T AC	125cc 2T AC	50cc 2T AC	50cc 2T AC	125cc 2T AC	125cc 2T AC	125cc 2T AC	150cc 2T AC	150cc 2T AC	200cc 2T AC	125cc 2T AC	80cc 2T AC
FZ00301 FZ00302 FZ00306	FZ00301 FZ00302 FZ00306		FZ00301 FZ00302 FZ00306	FZ00301 FZ00302 FZ00306	FZ00313	FZ00313	FZ00313			FZ00313	
	CP00212	CP00212	CP00212		CP00212	CP00212	CP00212		CP00212	CP00212	
KT00010			KT00010								
KT00011			KT00011								
KT00013			KT00013								
KT00049			KT00049								
KT00012			KT00012								
KT00014			KT00014								
				KT00015							
											KT00018
					KT00017	KT00017	KT00017			KT00017	
				KT00135	KT00136	KT00136	KT00136			KT00136	
GR00741	GR00743		GR00741	GR00742	GR00744	GR00744	GR00744	GR00744	GR00745	GR00744	

DR Classic



PIAGGIO	PIAGGIO	PIAGGIO	PIAGGIO
VESPA PX E ARCOBALENO	VESPA PX E ARCOBALENO	VESPA PX E ARCOBALENO	VESPA PX EU2
81-97	81-97	81-97	01-07
125cc 2T AC	150cc 2T AC	200cc 2T AC	125cc 2T AC

IT	EN	FR					
CILINDRETTI FRENO	BRAKE CALLIPERS	CYLINDRES FREIN					
FRIZIONE	CLUTCH	EMBAYAGE		FZ00303 FZ00307	FZ00303 FZ00307	FZ00305 FZ00318	FZ00313
GANASCE FRENO	BRAKE SHOE	MÂCHOIRES FREIN		CP00212	CP00212	CP00212	CP00212
GRUPPO TERMICO Ø Standard Spinotto 10	GRUPPO TERMICO Ø Standard pin 10	CYLINDRE COMPLET Ø Standard Axe de Piston Ø 10					
GRUPPO TERMICO Ø Standard Spinotto 12	CYLINDER KIT Ø Standard Pin 12	CYLINDRE COMPLET Ø Standard Axe de Piston Ø 12					
GRUPPO TERMICO Ø Maggiorato Spinotto 10	CYLINDER KIT BIG BORE pin 10	CYLINDRE COMPLET Ø majoré Axe de Piston Ø 10					
GRUPPO TERMICO Ø Maggiorato Spinotto 12	CYLINDER KIT BIG BORE pin 12	CYLINDRE COMPLET Ø majoré Axe de Piston Ø 12					
GRUPPO TERMICO Ø 47 3 Travasi	CYLINDER KIT Ø 47 3 Ports	CYLINDRE COMPLET Ø 47 3 Transvasements					
GRUPPO TERMICO Ø 47 6 Travasi	CYLINDER KIT Ø 47 6 Ports	CYLINDRE COMPLET Ø 47 6 Transvasements					
GRUPPO TERMICO Ø 47 10 Luci	CYLINDER KIT Ø 47 10 Ports	CYLINDRE COMPLET Ø 47 10 Ouvertures					
GRUPPO TERMICO Ø 50 3 Travasi	CYLINDER KIT Ø 50 3 Ports	CYLINDRE COMPLET Ø 50 3 Transvasements					
GRUPPO TERMICO Ø 55 6 Travasi	CYLINDER KIT Ø 55 6 Ports	CYLINDRE COMPLET Ø 55 6 Transvasements					
GRUPPO TERMICO Ø 57 con testa	CYLINDER KIT Ø 57 with cylinder head	CYLINDRE COMPLET Ø 57 avec culasse					
GRUPPO TERMICO Ø 60 con testa	CYLINDER KIT Ø 60 with cylinder head	CYLINDRE COMPLET Ø 60 avec culasse					
GRUPPO TERMICO Ø 63	CYLINDER KIT Ø 63	CYLINDRE COMPLET Ø 63		KT00017	KT00017		KT00017
GRUPPO TERMICO Ø 69 Spinotto 18	CYLINDER KIT Ø 69 Pin 18	CYLINDRE COMPLET Ø 69 Axe de Piston Ø 18					
GRUPPO TERMICO Ø 69 Spinotto 16	CYLINDER KIT Ø 69 Pin 16	CYLINDRE COMPLET Ø 69 Axe de Piston Ø 16					
GRUPPO TERMICO Ø Maggiorato Alluminio	CYLINDER KIT BIG BORE Aluminium	CYLINDRE COMPLET Ø majoré aluminium		KT00136	KT00136		KT00136
SERIE GUARNIZIONI MOTORE	ENGINE GASKET SET	JEU DE JOINTS MOTEUR		GR00744	GR00744	GR00745	GR00744
SCARICO	EXHAUST	ÉCHAPPEMENT					

PIAGGIO	PIAGGIO
VESPA PX T5	VESPA SPECIAL-L-R
85-89	67-82
125cc 2T AC	50cc 2T AC
FZ00307	FZ00301 FZ00302 FZ00306
CP00212	
	KT00010
	KT00011
	KT00013
	KT00049
	KT00012
	KT00014
	GR00740
	MT00001

NOVITÀ 2020

KT00136
Gruppo termico High Performance
per Vespa Px
Cilindro in alluminio Ø 63



DR Classic

IT	ALTERNATORE	BOBINA	CENTRALINA	MOTORINO AVVIAMENTO	REGOLATORE	STATORE
EN	ALTERNATOR	COIL	CDI	STARTER ENGINE	RECTIFIER	STATOR
FR	ALTERNATEUR	BOBINE	BOÎTIER ÉLECTRONIQUE	DÉMARREUR ÉLECTRIQUE	RÉGULATEUR	STATOR
						

APRILIA	MODEL	YEAR	CC	TYPE	REMARKS	ALTERNATOR	COIL	CDI	STARTER ENGINE	RECTIFIER	STATOR
	ATLANTIC	03-05	125cc	4T LC					19588N		
	ATLANTIC	03-05	125cc	4T LC					37033N		
	ATLANTIC	01-04	500cc	4T LC					16073N		
	ATLANTIC EU3	06-08	125cc	4T LC					19588N		
	ATLANTIC EU3	06-08	125cc	4T LC	Piaggio				37033N		
	ATLANTIC EU3	10-12	125cc	4T LC					19588N		
	ATLANTIC EU3	10-12	125cc	4T LC	Piaggio				37033N		
	ATLANTIC SPRINT	05-08	400cc	4T LC	Piaggio M348M				16073N		
	ATLANTIC SPRINT	05-08	500cc	4T LC	Piaggio M273M				16073N		
	CLASSIC	00-05	125cc	2T					19628N		
	HABANA-MOJITO CUSTOM	99-03	50cc	2T AC	Motore Aprilia				37036N		
	HABANA-MOJITO RETRO'	99-03	50cc	2T AC	Motore Aprilia				37036N		
	LEONARDO	99-01	250cc	4T LC	Minarelli YP					B1001N	
	LEONARDO	02-04	250cc	4T LC	Minarelli YP					B1001N	
	LEONARDO ST	01-01	250cc	4T LC	Minarelli YP					B1001N	
	MOJITO	03-07	125cc	4T AC					19588N		
	MOJITO	03-07	125cc	4T AC	Leader				37033N		
	MOJITO	08-08	125cc	4T AC					19588N		
	MOJITO	08-08	125cc	4T AC	Piaggio				37033N		
	MOJITO CUSTOM 2T MOTORE PIAGGIO	04-10	50cc	2T AC	Motore Piaggio				19595N		
	MOTO' 6.5	95-99	650cc	4T LC						B1001N	
	PEGASO	92-96	650cc	4T					18820N	B1001N	
	PEGASO 3	97-00	650cc	4T					18820N	B1001N	
	PEGASO I.E.	01-04	650cc	4T					18820N	B1001N	
	PEGASO STRADA-FACTORY-TRAIL	05-09	660cc	4T					18760N		
	RS	96-05	125cc	2T					19628N		
	RS REPLICIA	01-05	125cc	2T					19628N		
	SCARABEO	99-03	125cc	4T					19571N		
	SCARABEO	03-03	125cc	4T LC					19588N		
	SCARABEO	03-03	125cc	4T LC	Piaggio				37033N		

IT	ALTERNATORE	BOBINA	CENTRALINA	MOTORINO AVVIAMENTO	REGOLATORE	STATORE
EN	ALTERNATOR	COIL	CDI	STARTER ENGINE	RECTIFIER	STATOR
FR	ALTERNATEUR	BOBINE	BOÎTIER ÉLECTRONIQUE	DÉMARREUR ÉLECTRIQUE	RÉGULATEUR	STATOR
						

APRILIA	MODEL	YEAR	CC	TYPE	PIAGGIO	APRILIA	REGOLATORE	STATORE
	SCARABEO	04-06	125cc	4T LC			19588N	
	SCARABEO	04-06	125cc	4T LC	Piaggio		37033N	
	SCARABEO	99-03	150cc	4T			19571N	
	SCARABEO	03-06	500cc	4T LC	Piaggio		16073N	
	SCARABEO 2T EU2 MOTORE PIAGGIO	10-12	50cc	2T AC	Motore Piaggio		19595N	
	SCARABEO 2T NET	09-09	50cc	2T AC	Motore Piaggio		19595N	
	SCARABEO 2T NET	10-10	50cc	2T AC	Motore Piaggio		19595N	
	SCARABEO 4T	01-05	100cc	4T AC	Piaggio		16088N	
	SCARABEO 4T	10-12	100cc	4T AC	Piaggio		16088N	
	SCARABEO 4T	14-14	100cc	4T AC	Piaggio		16088N	
	SCARABEO 4T NET	09-09	100cc	4T AC	Piaggio		16088N	
	SCARABEO 4T NET EU3	10-10	100cc	4T AC	Piaggio		16088N	
	SCARABEO 4T RESTYLING	06-09	100cc	4T AC	Piaggio		16088N	
	SCARABEO DITECH	01-04	50cc	2T-IE AC	Motore Aprilia		37036N	
	SCARABEO EU3	06-07	125cc	4T LC			19588N	
	SCARABEO EU3	06-07	125cc	4T LC	Piaggio		37033N	
	SCARABEO LIGHT	06-08	400cc	4T LC	Piaggio		16073N	
	SCARABEO LIGHT	06-08	500cc	4T LC	Piaggio		16073N	
	SCARABEO STREET	05-06	50cc	2T AC	Motore Piaggio		19595N	
	SCARABEO STREET 2T RESTYLING	06-09	50cc	2T AC	Motore Piaggio		19595N	
	SPORT CITY	04-06	125cc	4T LC			19588N	
	SPORT CITY	04-06	125cc	4T LC	Piaggio M281M		37033N	
	SPORT CITY CUBE	08-10	125cc	4T LC			19588N	
	SPORT CITY CUBE	08-10	125cc	4T LC	Piaggio		37033N	
	SPORT CITY EU3	06-08	125cc	4T LC			19588N	
	SPORT CITY EU3	06-08	125cc	4T LC	Piaggio		37033N	
	SPORT CITY ONE 2T	08-11	50cc	2T AC	Motore Piaggio		19595N	
	SPORT CITY ONE 4T EU3	08-11	125cc	4T AC			19588N	
	SPORT CITY ONE 4T EU3	08-11	125cc	4T AC	Leader M38AM		37033N	
	SPORT CITY STREET	12-12	125cc	4T LC			19588N	

IT	ALTERNATORE	BOBINA	CENTRALINA	MOTORINO AVVIAMENTO	REGOLATORE	STATORE
EN	ALTERNATOR	COIL	CDI	STARTER ENGINE	RECTIFIER	STATOR
FR	ALTERNATEUR	BOBINE	BOÎTIER ÉLECTRONIQUE	DÉMARREUR ÉLECTRIQUE	RÉGULATEUR	STATOR
						

APRILIA	SPORT CITY STREET	12-12	125cc 4T LC	Piaggio				37033N		
	SR DITECH EU2	02-04	50cc 2T-IE LC	Motore Aprilia				37036N		
	SR H2O DITECH	00-04	50cc 2T-IE LC	Motore Aprilia				37036N		
	SR MOTARD	12-14	50cc 2T LC	Motore Piaggio				19595N		
	SR MOTARD	12-14	125cc 4T-2V AC					19588N		
	SR MOTARD	12-14	125cc 4T-2V AC	Piaggio				37033N		
	SR R FACTORY CARBURATORE	10-14	50cc 2T LC	Motore Piaggio				19595N		
	SR R FACTORY Motore Aprilia	05-05	50cc 2T-IE LC	Motore Aprilia				37036N		
	SR STREET CARBURATORE	03-12	50cc 2T LC	Motore Piaggio				19595N		
	TUONO	03-05	125cc 2T					19628N		
ARCTIC CAT	DVX 400	04-08	400cc 4T					18718N		
	DVX 400 TS	06-07	400cc 4T					18718N		
BENELLI	491 RR MORINI	03-04	50cc 2T LC	Motore Morini				37036N		
	491 ST MORINI	03-03	50cc 2T AC	Motore Morini				37036N		
	NAKED MORINI	03-04	50cc 2T AC	Motore Morini				37036N		
BMW	C1	00-03	125cc 4T					19571N		
	F	93-00	650cc 4T					18820N		
	F CS / SCARVER	00-06	650cc 4T					18820N		
	F CS ABS	03-05	650cc 4T					18820N		
	F ENDURO	98-01	650cc 4T					18820N		
	F FUNDURO	93-97	650cc 4T					18820N		
	F GS	99-07	650cc 4T					18820N		
	F GS	08-12	650cc 4T					18820N		
	F GS DAKAR	01-07	650cc 4T					18820N		
	F GS DAKOTA	00-07	650cc 4T					18820N		
	F SE	99-99	650cc 4T					18820N		
	F ST	97-99	650cc 4T					18820N		
	F700GS	11-14	700cc 4T					18820N		
	F800GS	08-14	800cc 4T					18820N		
	F800GS ADVENTURE	12-14	800cc 4T					18820N		

IT	ALTERNATORE	BOBINA	CENTRALINA	MOTORINO AVVIAMENTO	REGOLATORE	STATORE
EN	ALTERNATOR	COIL	CDI	STARTER ENGINE	RECTIFIER	STATOR
FR	ALTERNATEUR	BOBINE	BOÎTIER ÉLECTRONIQUE	DÉMARREUR ÉLECTRIQUE	RÉGULATEUR	STATOR
						

BMW	Model	Year	Capacity	Part No.	Part No.	Part No.	Part No.	Part No.	Part No.
	F800GT	11-14	800cc 4T				18820N		
	F800R	05-14	800cc 4T				18820N		
	F800S	06-08	800cc 4T				18820N		
	F800ST	06-08	800cc 4T				18820N		
	F800ST	09-12	800cc 4T				18820N		
	K 75	88-95	750cc 4T	12494N					
	K 75 C	85-90	750cc 4T	12494N					
	K 75 RT	90-95	750cc 4T	12494N					
	K 75 RT ABS	91-95	750cc 4T	12494N					
	K 75 S	86-95	750cc 4T	12494N					
	K 75 S ABS	91-95	750cc 4T	12494N					
	K GT	05-08	1200cc 4T				19646N		
	K GT	07-10	1300cc 4T				19646N		
	K GT	10-15	1600cc 4T				19646N		
	K GTL	10-15	1600cc 4T				19646N		
	K GTL EXCL	13-14	1600cc 4T				19646N		
	K R	04-08	1200cc 4T				19646N		
	K R	07-12	1300cc 4T				19646N		
	K R SPORT	05-08	1200cc 4T				19646N		
	K S	03-08	1200cc 4T				19646N		
	K S	07-15	1300cc 4T				19646N		
	K1100LT	92-97	1100cc 4T	12494N					
	K1100LT HIGH LINE	97-97	1100cc 4T	12494N					
	K1100LT SPECIAL EDITION	97-97	1100cc 4T	12494N					
	K1100RS	92-96	1100cc 4T	12494N					
	K1100RS SE	96-96	1100cc 4T	12494N					
	R 100	76-84	1000cc 4T				18915N		
	R 100 /7	76-78	1000cc 4T				18915N		
	R 100 /T, RT	78-84	1000cc 4T				18915N		
	R 100 CS	80-84	1000cc 4T				18915N		

IT	ALTERNATORE	BOBINA	CENTRALINA	MOTORINO AVVIAMENTO	REGOLATORE	STATORE
EN	ALTERNATOR	COIL	CDI	STARTER ENGINE	RECTIFIER	STATOR
FR	ALTERNATEUR	BOBINE	BOÎTIER ÉLECTRONIQUE	DÉMARREUR ÉLECTRIQUE	RÉGULATEUR	STATOR
						

BMW	Model	Year	Capacity	Part No.	Part No.	Part No.	Part No.	Part No.	Part No.
	R 100 GS	87-95	1000cc 4T				18915N		
	R 100 GS PARIS DAKAR	87-95	1000cc 4T				18915N		
	R 100 R	91-95	1000cc 4T				18915N		
	R 100 R CLASSIC - MYSTIC	94-96	1000cc 4T				18915N		
	R 100 RS	76-93	1000cc 4T				18915N		
	R 100 RT	78-95	1000cc 4T				18915N		
	R 100 S	76-80	1000cc 4T				18915N		
	R 45	78-85	450cc 4T				18915N		
	R 50 /5	69-73	500cc 4T				18915N		
	R 60 /6	73-76	600cc 4T				18915N		
	R 60 /7	76-80	600cc 4T				18915N		
	R 65	78-87	650cc 4T				18915N		
	R 65 LS	81-85	650cc 4T				18915N		
	R 75 /5	69-73	750cc 4T				18915N		
	R 75 /6	74-76	750cc 4T				18915N		
	R 75 /7	76-77	750cc 4T				18915N		
	R 80	84-95	800cc 4T				18915N		
	R 80 /7	77-80	800cc 4T				18915N		
	R 80 GS	80-96	800cc 4T				18915N		
	R 80 R	91-94	800cc 4T				18915N		
	R 80 RT	82-95	800cc 4T				18915N		
	R 80 ST	82-84	800cc 4T				18915N		
	R 90 /6	73-76	900cc 4T				18915N		
	R 90 S	73-76	900cc 4T				18915N		
	R1100GS	94-06	1100cc 4T	12494N					
	R1100GS ABS	95-99	1100cc 4T	12494N					
	R1100GS SE	99-99	1100cc 4T	12494N					
	R1100R	94-00	1100cc 4T	12494N					
	R1100R SE	99-99	1100cc 4T	12494N					
	R1100RL	01-01	1100cc 4T	12494N					

IT	ALTERNATORE	BOBINA	CENTRALINA	MOTORINO AVVIAMENTO	REGOLATORE	STATORE
EN	ALTERNATOR	COIL	CDI	STARTER ENGINE	RECTIFIER	STATOR
FR	ALTERNATEUR	BOBINE	BOÎTIER ÉLECTRONIQUE	DÉMARREUR ÉLECTRIQUE	RÉGULATEUR	STATOR
						

BMW	Model	Year	Engine	Part No.	Part No.	Part No.	Part No.	Part No.	Part No.
	R1100RS	92-01	1100cc 4T	12494N					
	R1100RS ABS	95-99	1100cc 4T	12494N					
	R1100RSL	94-96	1100cc 4T	12494N					
	R1100RT	94-01	1100cc 4T	12494N					
	R1100RT SE	00-00	1100cc 4T	12494N					
	R1100RTL	96-97	1100cc 4T	12494N					
	R1100S	98-05	1100cc 4T	12494N					
	R1150GS	99-04	1150cc 4T	12494N					
	R1150GS ADVENTURE	01-05	1150cc 4T	12494N					
	R1150R	01-06	1150cc 4T	12494N					
	R1150R ROADSTER	02-06	1150cc 4T	12494N					
	R1150RS	00-04	1150cc 4T	12494N					
	R1150RT	00-05	1150cc 4T	12494N					
	R1200C	98-03	1200cc 4T	12494N					
	R1200C AVANTGARDE	00-03	1200cc 4T	12494N					
	R1200C CLASSIC	96-03	1200cc 4T	12494N					
	R1200C EURO	98-02	1200cc 4T	12494N					
	R1200C INDEPENDENT	00-03	1200cc 4T	12494N					
	R1200C MONTANA	00-03	1200cc 4T	12494N					
	R1200C PHOENIX	00-02	1200cc 4T	12494N					
	R1200C STILETTO	01-01	1200cc 4T	12494N					
	R850C CLASSIC	98-00	850cc 4T	12494N					
	R850R	95-01	850cc 4T	12494N					
	R850R ABS	96-96	850cc 4T	12494N					
	R850R SPECIAL EDITION	97-97	850cc 4T	12494N					
	R850RT	02-06	850cc 4T	12494N					
BOBCAT	2200S	04-06	720cc 4T				19162N		
BOMBARDIER	DS650	00-07	650cc 4T				18820N		
	DS650 BAJA	01-04	650cc 4T				18820N		
	DS650 X	04-07	650cc 4T				18820N		

IT	ALTERNATORE	BOBINA	CENTRALINA	MOTORINO AVVIAMENTO	REGOLATORE	STATORE
EN	ALTERNATOR	COIL	CDI	STARTER ENGINE	RECTIFIER	STATOR
FR	ALTERNATEUR	BOBINE	BOÎTIER ÉLECTRONIQUE	DÉMARREUR ÉLECTRIQUE	RÉGULATEUR	STATOR
						

CAN-AM	DS650 X	07-07	650cc 4T				18820N		
	DERBI	ATLANTIS 4T	04-06	100cc 4T AC	Piaggio			16088N	
BOULEVARD		02-02	125cc 4T AC				19588N		
BOULEVARD		02-02	125cc 4T AC	Leader			37033N		
BOULEVARD		03-04	125cc 4T AC				19588N		
BOULEVARD		03-04	125cc 4T AC	Piaggio			37033N		
BOULEVARD		02-02	150cc 4T AC				19588N		
BOULEVARD		02-02	150cc 4T AC	Leader			37033N		
BOULEVARD		03-04	150cc 4T AC				19588N		
BOULEVARD		03-04	150cc 4T AC	Piaggio			37033N		
BOULEVARD 4T		10-11	100cc 4T AC	Piaggio			16088N		
BOULEVARD 4T E3		10-10	150cc 4T AC				19588N		
BOULEVARD 4T E3		10-10	150cc 4T AC	Piaggio			37033N		
BOULEVARD 4T EU3		08-12	125cc 4T AC				19588N		
BOULEVARD 4T EU3		08-12	125cc 4T AC	Piaggio			37033N		
BOULEVARD EU2		04-07	125cc 4T AC				19588N		
BOULEVARD EU2		04-07	125cc 4T AC	Piaggio			37033N		
BOULEVARD EU2		05-06	200cc 4T AC				19588N		
BOULEVARD EU2		05-06	200cc 4T AC	Piaggio M387M			37033N		
BOULEVARD EU3		04-07	150cc 4T AC				19588N		
BOULEVARD EU3		04-07	150cc 4T AC	Piaggio			37033N		
GP1 EU 2	06-06	125cc 4T LC				19588N			
GP1 EU 2	06-06	125cc 4T LC				37033N			
GP1 LOW SEAT EU3	07-08	125cc 4T LC				19588N			
GP1 LOW SEAT EU3	07-08	125cc 4T LC	Piaggio			37033N			
RAMBLA	08-09	125cc 4T LC				19588N			
RAMBLA	08-09	125cc 4T LC	Piaggio M287M			37033N			
RAMBLA EU3 2VER	08-08	125cc 4T LC				19588N			
RAMBLA EU3 2VER	08-08	125cc 4T LC	Piaggio			37033N			
SONAR 4T	09-11	125cc 4T AC				19588N			

IT	ALTERNATORE	BOBINA	CENTRALINA	MOTORINO AVVIAMENTO	REGOLATORE	STATORE
EN	ALTERNATOR	COIL	CDI	STARTER ENGINE	RECTIFIER	STATOR
FR	ALTERNATEUR	BOBINE	BOÎTIER ÉLECTRONIQUE	DÉMARREUR ÉLECTRIQUE	RÉGULATEUR	STATOR
						

DERBI	Model	Year	Engine	Motor	Part Number	Part Number	Part Number	Part Number	Part Number
DERBI	SONAR 4T	09-11	125cc 4T AC	Piaggio			37033N		
	SONAR 4T	09-09	150cc 4T AC				19588N		
	SONAR 4T	09-09	150cc 4T AC	Piaggio			37033N		
	VARIANT SPORT 4T EU3	12-12	125cc 4T AC				19588N		
	VARIANT SPORT 4T EU3	12-12	125cc 4T AC	Motore Piaggio			37033N		
DUCATI	1098	07-08	1098cc 4T				19876N		
	1098 S	07-08	1098cc 4T				19876N		
	1098 S TRICOLORE	07-07	1098cc 4T				19876N		
	748	00-03	748cc 4T				19876N		
	748 R	00-02	748cc 4T				19876N		
	748 R MONOPOSTO	01-02	748cc 4T				19876N		
	748 S	00-02	748cc 4T				19876N		
	749	03-06	748cc 4T				19876N		
	749 DARK	04-06	748cc 4T				19876N		
	749 R	04-06	748cc 4T				19876N		
	749 S	03-06	748cc 4T				19876N		
	916 SP	95-95	916cc 4T				19876N		
	916 SPS	97-98	916cc 4T				19876N		
	996	02-02	996cc 4T				19876N		
	996 BIPOSTO	01-01	996cc 4T				19876N		
	996 MONOPOSTO	01-01	996cc 4T				19876N		
	996 R	01-01	996cc 4T				19876N		
	996 S	01-03	996cc 4T				19876N		
	996 SPS	99-00	996cc 4T				19876N		
	998 MATRIX	04-04	998cc 4T				19876N		
998 R	02-02	998cc 4T				19876N			
998 S	02-02	998cc 4T				19876N			
998 S BAYLISS	02-02	998cc 4T				19876N			
998 S BOSTROM	02-02	998cc 4T				19876N			
999	03-06	999cc 4T				19876N			

IT	ALTERNATORE	BOBINA	CENTRALINA	MOTORINO AVVIAMENTO	REGOLATORE	STATORE
EN	ALTERNATOR	COIL	CDI	STARTER ENGINE	RECTIFIER	STATOR
FR	ALTERNATEUR	BOBINE	BOÎTIER ÉLECTRONIQUE	DÉMARREUR ÉLECTRIQUE	RÉGULATEUR	STATOR
						

DUCATI	Model	Year	Capacity	Part No.
	999 R	03-06	998cc 4T	19876N
	999 R FILA	03-04	998cc 4T	19876N
	999 R XEROX	06-06	998cc 4T	19876N
	999 S	03-06	998cc 4T	19876N
	MONSTER	01-05	400cc 4T	19876N
	MONSTER	00-01	600cc 4T	19876N
	MONSTER	02-06	620cc 4T	19876N
	MONSTER	04-04	620cc 4T	19876N
	MONSTER	07-08	695cc 4T	19876N
	MONSTER	08-09	696cc 4T	19876N
	MONSTER	99-02	750cc 4T	19876N
	MONSTER	00-02	750cc 4T	19876N
	MONSTER	03-04	800cc 4T	19876N
	MONSTER	04-04	800cc 4T	19876N
	MONSTER	97-02	900cc 4T	19876N
	MONSTER	00-02	900cc 4T	19876N
	MONSTER	03-05	1000cc 4T	19876N
	MONSTER	04-05	1000cc 4T	19876N
	MONSTER CAPIREX	04-04	620cc 4T	19876N
	MONSTER CROMO	01-01	900cc 4T	19876N
	MONSTER DARK	02-04	400cc 4T	19876N
	MONSTER DARK	01-01	600cc 4T	19876N
	MONSTER DARK	05-06	620cc 4T	19876N
	MONSTER DARK	01-02	750cc 4T	19876N
	MONSTER DARK	03-03	800cc 4T	19876N
	MONSTER DARK	01-02	900cc 4T	19876N
	MONSTER DARK	03-03	1000cc 4T	19876N
	MONSTER METALLIC	01-01	400cc 4T	19876N
	MONSTER METALLIC	01-01	600cc 4T	19876N
	MONSTER S	03-03	400cc 4T	19876N

IT	ALTERNATORE	BOBINA	CENTRALINA	MOTORINO AVVIAMENTO	REGOLATORE	STATORE
EN	ALTERNATOR	COIL	CDI	STARTER ENGINE	RECTIFIER	STATOR
FR	ALTERNATEUR	BOBINE	BOÎTIER ÉLECTRONIQUE	DÉMARREUR ÉLECTRIQUE	RÉGULATEUR	STATOR
						

DUCATI	Model	Year	Capacity	Part 1	Part 2	Part 3	Part 4	Part 5	Part 6
	MONSTER S	02-03	620cc 4T					19876N	
	MONSTER S	03-03	800cc 4T					19876N	
	MONSTER S	00-01	900cc 4T					19876N	
	MONSTER S	03-05	1000cc 4T					19876N	
	MONSTER S2R	05-06	800cc 4T					19876N	
	MONSTER S2R	07-07	800cc 4T					19876N	
	MONSTER S2R	06-08	1000cc 4T					19876N	
	MONSTER S2R DARK	05-06	800cc 4T					19876N	
	MONSTER S4	01-02	916cc 4T					19876N	
	MONSTER S4R	05-06	996cc 4T					19876N	
	MONSTER S4R	07-08	1000cc 4T					19876N	
	MONSTER S4RS	06-06	1000cc 4T					19876N	
	MONSTER S4RS	06-08	1000cc 4T					19876N	
	MONSTER S4RS TRICOLORE	08-08	1000cc 4T					19876N	
	MULTISTRADA	05-06	620cc 4T					19876N	
	MULTISTRADA	03-05	1000cc 4T					19876N	
	MULTISTRADA	07-08	1100cc 4T					19876N	
	MULTISTRADA DARK	05-06	620cc 4T					19876N	
	MULTISTRADA DS	05-06	1000cc 4T					19876N	
	MULTISTRADA S	07-09	1100cc 4T					19876N	
	MULTISTRADA S DS	05-06	1000cc 4T					19876N	
	SPORCLASSIC PAUL SMART	05-06	1000cc 4T					19876N	
	SPORT	01-02	750cc 4T					19876N	
	SPORT	03-03	800cc 4T					19876N	
	SPORT	02-02	900cc 4T					19876N	
	SPORT	06-06	1000cc 4T					19876N	
	SPORT BIPOSTO	07-08	1000cc 4T					19876N	
	SPORT MONOPOSTO	07-07	1000cc 4T					19876N	
	SPORT TOURING ST2	00-03	1000cc 4T					19876N	
	SPORT TOURING ST3	04-07	1000cc 4T					19876N	

IT	ALTERNATORE	BOBINA	CENTRALINA	MOTORINO AVVIAMENTO	REGOLATORE	STATORE
EN	ALTERNATOR	COIL	CDI	STARTER ENGINE	RECTIFIER	STATOR
FR	ALTERNATEUR	BOBINE	BOÎTIER ÉLECTRONIQUE	DÉMARREUR ÉLECTRIQUE	RÉGULATEUR	STATOR
						



BRAND	MODEL	YEAR	CC	TYPE	PIAGGIO	ITEM NO.	REG.	STAT.
DUCATI	SPORT TOURING ST3 S ABS	06-07	1000cc	4T			19876N	
	SPORT TOURING ST4	00-03	916cc	4T			19876N	
	SPORT TOURING ST4	04-04	916cc	4T			19876N	
	SPORT TOURING ST4S	01-05	996cc	4T			19876N	
	SPORT TOURING ST4S	04-04	996cc	4T			19876N	
	SPORT TOURING ST4S ABS	05-05	996cc	4T			19876N	
	SPORTCLASSIC GT	07-10	1000cc	4T			19876N	
	SPORTCLASSIC GT TOURING	09-09	1000cc	4T			19876N	
	SPORTCLASSIC MH900E	01-02	900cc	4T			19876N	
	SPORTCLASSIC SPORT S	07-08	1000cc	4T			19876N	
GILERA	SUPERSPORT S	03-03	620cc	4T			19876N	
	DNA	01-01	125cc	4T LC			19588N	
	DNA	01-01	125cc	4T LC	Piaggio		37033N	
	DNA	01-01	180cc	4T LC			19588N	
	DNA	01-01	180cc	4T LC	Piaggio		37033N	
	FUOCO 4T-4V IE E3 LT	13-14	500cc	4T LC	Piaggio		16073N	
	FUOCO IE EU3	07-13	500cc	4T LC	Piaggio		16073N	
	NEXUS	03-05	500cc	4T LC	Piaggio		16073N	
	NEXUS EU3	07-08	125cc	4T LC			19588N	
	NEXUS EU3	07-08	125cc	4T LC	Piaggio		37033N	
	NEXUS EU3	06-08	500cc	4T LC	Piaggio		16073N	
	NEXUS EU3	09-11	500cc	4T LC	Piaggio		16073N	
	NEXUS SP EU3	06-07	500cc	4T LC	Piaggio		16073N	
	RUNNER 4T ST EU3	08-16	125cc	4T LC			19588N	
	RUNNER 4T ST EU3	08-16	125cc	4T LC	Piaggio		37033N	
	RUNNER FXR	97-02	180cc	2T LC	Piaggio		16088N	
	RUNNER VX	00-01	125cc	4T LC			19588N	
	RUNNER VX	00-01	125cc	4T LC	Piaggio		37033N	
RUNNER VX	02-04	125cc	4T LC			19588N		
RUNNER VX	02-04	125cc	4T LC	Piaggio		37033N		

IT	ALTERNATORE	BOBINA	CENTRALINA	MOTORINO AVVIAMENTO	REGOLATORE	STATORE
EN	ALTERNATOR	COIL	CDI	STARTER ENGINE	RECTIFIER	STATOR
FR	ALTERNATEUR	BOBINE	BOÎTIER ÉLECTRONIQUE	DÉMARREUR ÉLECTRIQUE	RÉGULATEUR	STATOR
						

GILERA	Model	Year	Engine	Brand	Part Numbers					
					Alternator	Coil	CDI	Starter	Rectifier	Stator
GILERA	RUNNER VX	05-06	125cc 4T LC					19588N		
	RUNNER VX	05-06	125cc 4T LC	Piaggio				37033N		
GILERA	RUNNER VX 4T EU3	06-07	125cc 4T LC					19588N		
	RUNNER VX 4T EU3	06-07	125cc 4T LC	Piaggio				37033N		
GILERA	RUNNER VX RACE	06-06	125cc 4T LC					19588N		
	RUNNER VX RACE	06-06	125cc 4T LC	Piaggio				37033N		
GILERA	RUNNER VX SC	06-07	125cc 4T LC					19588N		
	RUNNER VX SC	06-07	125cc 4T LC	Piaggio				37033N		
GILERA	RUNNER VXR	00-01	180cc 4T LC					19588N		
	RUNNER VXR	00-01	180cc 4T LC	Piaggio				37033N		
GILERA	RUNNER VXR	02-04	200cc 4T LC					19588N		
	RUNNER VXR	02-04	200cc 4T LC	Piaggio				37033N		
GILERA	RUNNER VXR	05-06	200cc 4T LC					19588N		
	RUNNER VXR	05-06	200cc 4T LC	Piaggio				37033N		
GILERA	RUNNER VXR 4T ST EU3	08-11	200cc 4T LC					19588N		
	RUNNER VXR 4T ST EU3	08-11	200cc 4T LC	Piaggio				37033N		
GILERA	RUNNER VXR EU3	07-07	200cc 4T LC					19588N		
	RUNNER VXR EU3	07-07	200cc 4T LC	Piaggio				37033N		
GILERA	RUNNER VXR RACE 200	06-06	125cc 4T LC					19588N		
	RUNNER VXR RACE 200	06-06	125cc 4T LC	Piaggio				37033N		
GMI	GMI 101	04-08	50cc 4T AC					19597N		
	GMI 102	04-08	50cc 4T AC					19597N		
	GMI 102P	04-08	50cc 4T AC					19597N		
	GMI 103	04-08	50cc 4T AC					19597N		
	GMI 104	04-08	50cc 4T AC					19597N		
	GMI 106	04-08	50cc 4T AC					19597N		
	GMI 106I	04-08	50cc 4T AC					19597N		
	GMI 107	04-08	50cc 4T AC					19597N		
	GMI 107XP	04-08	50cc 4T AC					19597N		
	GMI 108	04-08	50cc 4T AC					19597N		

IT	ALTERNATORE	BOBINA	CENTRALINA	MOTORINO AVVIAMENTO	REGOLATORE	STATORE
EN	ALTERNATOR	COIL	CDI	STARTER ENGINE	RECTIFIER	STATOR
FR	ALTERNATEUR	BOBINE	BOÎTIER ÉLECTRONIQUE	DÉMARREUR ÉLECTRIQUE	RÉGULATEUR	STATOR
						

GMI	GMI 109	04-08	50cc 4T AC				19597N			
	GMI 110	04-08	50cc 4T AC				19597N			
	GMI 111	04-08	50cc 4T AC				19597N			
	GMI 301	04-08	50cc 4T AC				19597N			
	GMI 304	04-08	50cc 4T AC				19597N			
HARLEY DAVIDSON	FL	41-64	1200cc 4T				5780BN 5780CN			
	FL SERIES (PRE 1977)	65-69	1200cc 4T AC				15410BN			
	FL SERIES (PRE 1977)	65-76	1200cc 4T				5780BN 5780CN			
	FLD SWITCHBACK	12-14	1690cc 4T					H3108 H3108C		
	FLF	53-64	1200cc 4T				5780CN			
	FLF	54-64	1200cc 4T				5780BN			
	FLFB	65-69	1200cc 4T				15410BN			
	FLFB	65-69	1200cc 4T				5780BN 5780CN			
	FLH ELECTRA GLIDE	55-78	1200cc 4T				5780BN 5780CN			
	FLH ELECTRA GLIDE	70-75	1200cc 4T					H1070 H1070C		
	FLH ELECTRA GLIDE	76-80	1340cc 4T					H1075 H1075C		
	FLH ELECTRA GLIDE	79-83	1340cc 4T				5780BN 5780CN			
	FLH ELECTRA GLIDE	81-85	1340cc 4T					H1686		
	FLH ELECTRA GLIDE	84-85	1340cc 4T				18300BN 18300CN			
	FLHB	65-69	1200cc 4T				15410BN			
	FLHB	65-69	1200cc 4T				5780BN 5780CN			
	FLHC ELECTRA GLIDE CLASSIC	79-81	1340cc 4T				5780BN 5780CN			
	FLHC ELECTRA GLIDE CLASSIC	80-80	1340cc 4T				18300BN 18300CN			
	FLHC ELECTRA GLIDE CLASSIC	81-81	1340cc 4T					H1686		
	FLHF	55-72	1200cc 4T				5780BN 5780CN			
	FLHF	70-72	1200cc 4T					H1070 H1070C		
	FLHFB	65-69	1200cc 4T				5780BN 5780CN			
	FLHP ROAD KING	07-07	1690cc 4T					H0506		
	FLHP ROAD KING	11-14	1690cc 4T					H0505 H0505C		
	FLHR ROAD KING	94-98	1340cc 4T				18446CN 18446N	18199BN 18199N		

IT	ALTERNATORE	BOBINA	CENTRALINA	MOTORINO AVVIAMENTO	REGOLATORE	STATORE
EN	ALTERNATOR	COIL	CDI	STARTER ENGINE	RECTIFIER	STATOR
FR	ALTERNATEUR	BOBINE	BOÎTIER ÉLECTRONIQUE	DÉMARREUR ÉLECTRIQUE	RÉGULATEUR	STATOR
						

HARLEY DAVIDSON	Model	Year	Engine	Part 1	Part 2	Part 3	Part 4	Part 5	Part 6	
HARLEY DAVIDSON	FLHR ROAD KING	99-99	1450cc 4T				18446N			
	FLHR ROAD KING	99-06	1450cc 4T				18446CN 18199BN 18199N			
	FLHR ROAD KING	06-06	1450cc 4T					H0506		
	FLHR ROAD KING	07-07	1584cc 4T				18905BN 18905CN	H0506C		
	FLHR ROAD KING	07-08	1584cc 4T					H0506 H0506C		
	FLHR ROAD KING	09-11	1584cc 4T					H0505 H0505C		
	FLHR ROAD KING	12-13	1690cc 4T					H0505C		
	FLHRC ROAD KING CLASSIC	07-07	1584cc 4T				18905BN 18905CN			
	FLHRC ROAD KING CLASSIC	07-08	1584cc 4T					H0506 H0506C		
	FLHRC ROAD KING CLASSIC	09-10	1584cc 4T					H0505 H0505C		
	FLHRC ROAD KING CLASSIC	11-13	1690cc 4T					H0505 H0505C		
	FLHRCI ROAD KING CLASSIC	98-98	1340cc 4T				18199N 18446CN 18446N	18199BN 18199CN	H1988 H1988C	
	FLHRCI ROAD KING CLASSIC	99-01	1450cc 4T						H0597 H0597C	
	FLHRCI ROAD KING CLASSIC	99-06	1450cc 4T				18199N 18446CN 18446N	18199BN 18199CN		
	FLHRCI ROAD KING CLASSIC	02-02	1450cc 4T						H0502 H0502C	
	FLHRCI ROAD KING CLASSIC	06-08	1450cc 4T						H0506 H0506C	
	FLHRCI ROAD KING CLASSIC	07-07	1450cc 4T				18905BN 18905CN			
	FLHRCI ROAD KING CLASSIC	03-03	1690cc 4T				18199N			
	FLHRI ROAD KING	96-97	1340cc 4T						H1988 H1988C	
	FLHRI ROAD KING	96-06	1450cc 4T				18199N 18446CN 18446N	18199BN 18199CN		
	FLHRI ROAD KING	00-01	1450cc 4T						H0597 H0597C	
	FLHRI ROAD KING	02-03	1450cc 4T						H0502 H0502C	
	FLHRI ROAD KING	06-08	1450cc 4T						H0506 H0506C	
	FLHRI ROAD KING	07-07	1584cc 4T				18905BN 18905CN			
	FLHRS ROAD KING CUSTOM	04-06	1450cc 4T				18446CN 18446N	18199BN 18199N		
	FLHRS ROAD KING CUSTOM	06-07	1584cc 4T						H0506 H0506C	
	FLHRS ROAD KING CUSTOM	07-07	1584cc 4T				18905BN 18905CN			
	FLHRSE3 SCREAMIN EAGLE ROAD KING	07-07	1800cc 4T				18905BN 18905CN			
	FLHRSE4 SCREAMIN EAGLE ROAD KING	08-08	1584cc 4T				18905BN 18905CN		H0506 H0506C	
	FLHRSE4 SCREAMIN EAGLE ROAD KING	08-08	1800cc 4T				18905BN 18905CN			

IT	ALTERNATORE	BOBINA	CENTRALINA	MOTORINO AVVIAMENTO	REGOLATORE	STATORE
EN	ALTERNATOR	COIL	CDI	STARTER ENGINE	RECTIFIER	STATOR
FR	ALTERNATEUR	BOBINE	BOÎTIER ÉLECTRONIQUE	DÉMARREUR ÉLECTRIQUE	RÉGULATEUR	STATOR
						

HARLEY DAVIDSON	Model	Year	Engine	Part No.	Part No.	Part No.	Part No.	Part No.	Part No.
	FLHRSES CVO ROAD KING	13-13	1800cc 4T					18905BN	
	FLHRSEI SCREAMIN EAGLE ROAD KING	02-02	1550cc 4T					18199N 18446CN 18446N 18199N 18446CN 18446N	18199BN 18199CN
	FLHRSI ROAD KING CUSTOM	04-06	1450cc 4T					18199N 18446CN 18446N	18199BN 18199CN
	FLHRSI ROAD KING CUSTOM	06-06	1450cc 4T						H0506 H0506C
	FLHS ELECTRA GLIDE SPORT	80-81	1340cc 4T					5780BN 5780CN	
	FLHS ELECTRA GLIDE SPORT	81-88	1340cc 4T						H1686
	FLHS ELECTRA GLIDE SPORT	84-88	1340cc 4T					18300BN 18300CN	
	FLHS ELECTRA GLIDE SPORT	89-90	1340cc 4T					17629BN 17629CN	
	FLHS ELECTRA GLIDE SPORT	89-93	1340cc 4T						H1988 H1988C
	FLHS ELECTRA GLIDE SPORT	91-93	1340cc 4T					17629CN-HT 17629N	17629BN 17629CN
	FLHT ELECTRA GLIDE STANDARD	86-87	1340cc 4T					18300BN 18300CN	
	FLHT ELECTRA GLIDE STANDARD	95-98	1340cc 4T					18199N 18446CN 18446N 18199N 18446CN 18446N	18199BN 18199CN
	FLHT ELECTRA GLIDE STANDARD	99-06	1450cc 4T					18199N 18446CN 18446N	18199BN 18199CN
	FLHT ELECTRA GLIDE STANDARD	06-08	1584cc 4T						H0506 H0506C
	FLHT ELECTRA GLIDE STANDARD	07-07	1584cc 4T					18905BN 18905CN	
	FLHT ELECTRA GLIDE STANDARD	09-09	1584cc 4T						H0505 H0505C
	FLHTC ELECTRA GLIDE CLASSIC	83-88	1340cc 4T					18300BN 18300CN	
	FLHTC ELECTRA GLIDE CLASSIC	89-90	1340cc 4T					17629BN 17629CN	
	FLHTC ELECTRA GLIDE CLASSIC	91-93	1340cc 4T					17629CN-HT 17629N	17629BN 17629CN
	FLHTC ELECTRA GLIDE CLASSIC	94-98	1340cc 4T					18446CN 18446N	18199BN 18199N
	FLHTC ELECTRA GLIDE CLASSIC	99-05	1450cc 4T					18446CN 18446N	18199BN 18199N
	FLHTC ELECTRA GLIDE CLASSIC	07-07	1584cc 4T					18905BN 18905CN	
	FLHTC ELECTRA GLIDE CLASSIC	07-08	1584cc 4T						H0506 H0506C
	FLHTC ELECTRA GLIDE CLASSIC	09-11	1584cc 4T						H0505 H0505C
	FLHTC ELECTRA GLIDE CLASSIC	12-13	1690cc 4T						H0505 H0505C
	FLHTCI ELECTRA GLIDE CLASSIC	83-88	1340cc 4T					18300BN 18300CN	H1686
	FLHTCI ELECTRA GLIDE CLASSIC	89-90	1340cc 4T					17629BN 17629CN	
	FLHTCI ELECTRA GLIDE CLASSIC	89-96	1340cc 4T						H1988 H1988C
	FLHTCI ELECTRA GLIDE CLASSIC	91-93	1340cc 4T					17629CN-HT 17629N	17629BN 17629CN
	FLHTCI ELECTRA GLIDE CLASSIC	94-98	1340cc 4T					18199N 18446CN 18446N	18199BN 18199CN

IT	ALTERNATORE	BOBINA	CENTRALINA	MOTORINO AVVIAMENTO	REGOLATORE	STATORE
EN	ALTERNATOR	COIL	CDI	STARTER ENGINE	RECTIFIER	STATOR
FR	ALTERNATEUR	BOBINE	BOÎTIER ÉLECTRONIQUE	DÉMARREUR ÉLECTRIQUE	RÉGULATEUR	STATOR
						

HARLEY DAVIDSON	Model	Year	Capacity	Part 1	Part 2	Part 3	Part 4	Part 5	Part 6
HARLEY DAVIDSON	FLHTCI ELECTRA GLIDE CLASSIC	96-06	1450cc 4T				18199BN 18446CN 18446N		
	FLHTCI ELECTRA GLIDE CLASSIC	97-01	1450cc 4T					H0597 H0597C	
	FLHTCI ELECTRA GLIDE CLASSIC	99-06	1450cc 4T				18199CN 18199N		
	FLHTCI ELECTRA GLIDE CLASSIC	06-08	1450cc 4T					H0506 H0506C	
	FLHTCI ELECTRA GLIDE CLASSIC	07-07	1584cc 4T				18905BN 18905CN		
	FLHTCU ELECTRA GLIDE ULTRA CLASSIC	89-90	1340cc 4T				17629BN 17629CN		
	FLHTCU ELECTRA GLIDE ULTRA CLASSIC	91-93	1340cc 4T				17629CN-HT 17629N	17629BN 17629CN	
	FLHTCU ELECTRA GLIDE ULTRA CLASSIC	94-97	1340cc 4T				18446CN 18446N	18199BN 18199N	
	FLHTCU ELECTRA GLIDE ULTRA CLASSIC	07-08	1584cc 4T					H0506 H0506C	
	FLHTCU ELECTRA GLIDE ULTRA CLASSIC	09-11	1584cc 4T					H0505 H0505C	
	FLHTCU ELECTRA GLIDE ULTRA CLASSIC	12-13	1690cc 4T					H0505 H0505C	
	FLHTCUI ELECTRA GLIDE ULTRA CLASSIC	89-90	1340cc 4T				17629BN 17629CN		
	FLHTCUI ELECTRA GLIDE ULTRA CLASSIC	89-96	1340cc 4T					H1988 H1988C	
	FLHTCUI ELECTRA GLIDE ULTRA CLASSIC	91-93	1340cc 4T				17629CN-HT 17629N	17629BN 17629CN	
	FLHTCUI ELECTRA GLIDE ULTRA CLASSIC	94-94	1340cc 4T				18446CN		
	FLHTCUI ELECTRA GLIDE ULTRA CLASSIC	94-98	1340cc 4T				18446N		
	FLHTCUI ELECTRA GLIDE ULTRA CLASSIC	95-98	1450cc 4T				18446CN		
	FLHTCUI ELECTRA GLIDE ULTRA CLASSIC	95-06	1450cc 4T				18199BN 18199CN 18199N		
	FLHTCUI ELECTRA GLIDE ULTRA CLASSIC	97-01	1450cc 4T					H0597 H0597C	
	FLHTCUI ELECTRA GLIDE ULTRA CLASSIC	99-06	1450cc 4T				18446CN 18446N		
FLHTCUI ELECTRA GLIDE ULTRA CLASSIC	06-06	1450cc 4T					H0506		
FLHTCUI ELECTRA GLIDE ULTRA CLASSIC	06-08	1584cc 4T					H0506C		
FLHTCUI ELECTRA GLIDE ULTRA CLASSIC	07-08	1584cc 4T					H0506		
FLHTCUI ELECTRA GLIDE ULTRA CLASSIC	07-07	1800cc 4T				18905BN 18905CN			
FLHTCUI ELECTRA GLIDE ULTRA CLASSIC	08-08	1800cc 4T				18905BN 18905CN			
FLHTCUI ELECTRA GLIDE ULTRA CLASSIC	09-09	1584cc 4T				18905BN 18905CN			
FLHTCUI ELECTRA GLIDE ULTRA CLASSIC	10-10	1584cc 4T				18905BN 18905CN			
FLHTCUI ELECTRA GLIDE ULTRA CLASSIC	11-11	1800cc 4T				18905BN 18905CN			
FLHTCUI ELECTRA GLIDE ULTRA CLASSIC	12-12	1800cc 4T				18905BN 18905CN			
FLHTCUI ELECTRA GLIDE ULTRA CLASSIC	13-13	1800cc 4T				18905BN 18905CN			

IT	ALTERNATORE	BOBINA	CENTRALINA	MOTORINO AVVIAMENTO	REGOLATORE	STATORE
EN	ALTERNATOR	COIL	CDI	STARTER ENGINE	RECTIFIER	STATOR
FR	ALTERNATEUR	BOBINE	BOÎTIER ÉLECTRONIQUE	DÉMARREUR ÉLECTRIQUE	RÉGULATEUR	STATOR
						

HARLEY DAVIDSON	Model	Year	Engine	Part	Part Number	Part Number	Part Number	Part Number	Part Number
	FLHTCUTG TRI GLIDE ULTRA	14-14	1690cc 4T						H0505 H0505C
	FLHTCUTG TRI GLIDE ULTRA CLASSIC	09-10	1584cc 4T						H0505 H0505C
	FLHTCUTG TRI GLIDE ULTRA CLASSIC	11-13	1690cc 4T						H0505 H0505C
	FLHTI ELECTRA GLIDE STANDARD	86-87	1340cc 4T				18300BN 18300CN		H1686
	FLHTI ELECTRA GLIDE STANDARD	95-96	1340cc 4T				18199N 18446CN 18446N	18199BN 18199CN	
	FLHTI ELECTRA GLIDE STANDARD	95-98	1450cc 4T						H1988 H1988C
	FLHTI ELECTRA GLIDE STANDARD	97-01	1450cc 4T						H0597 H0597C
	FLHTI ELECTRA GLIDE STANDARD	97-06	1450cc 4T				18199N 18446CN 18446N	18199BN 18199CN	
	FLHTI ELECTRA GLIDE STANDARD	07-07	1584cc 4T				18905BN 18905CN		
	FLHTI ELECTRA GLIDE STANDARD	07-08	1584cc 4T						H0506 H0506C
	FLHTK ELECTRA GLIDE ULTRA LIMITED	10-13	1690cc 4T						H0505 H0505C
	FLHTP POLICE	85-88	1340cc 4T				18300BN 18300CN		
	FLHTP POLICE	89-89	1340cc 4T				17629BN 17629CN		
	FLHTP POLICE	07-07	1584cc 4T						H0506 H0506C
	FLHTP POLICE	12-14	1690cc 4T						H0505 H0505C
	FLHX ELECTRA GLIDE SPECIAL	84-85	1340cc 4T				18300BN 18300CN		H1686
	FLHX STREET GLIDE	06-06	1450cc 4T				18446CN 18446N	18199BN 18199N	H0506
	FLHX STREET GLIDE	06-08	1584cc 4T						H0506C
	FLHX STREET GLIDE	07-07	1584cc 4T				18905BN 18905CN		
	FLHX STREET GLIDE	07-08	1584cc 4T						H0506
	FLHX STREET GLIDE	09-13	1584cc 4T						H0505 H0505C
	FLHX STREET GLIDE	12-13	1690cc 4T						H0505 H0505C
	FLHXI STREET GLIDE	06-06	1450cc 4T				18199BN 18199CN 18199N		H0506 H0506C
	FLHXSE CVO STREET GLIDE	10-10	1800cc 4T				18905BN 18905CN		
	FLHXSE2 CVO STREET GLIDE	11-12	1800cc 4T				18905BN 18905CN		
	FLHXSE3 CVO STREET GLIDE	12-12	1800cc 4T				18905BN 18905CN		
	FLHXXX STREET GLIDE TRIKE	10-11	1690cc 4T						H0505 H0505C
	FLST HERITAGE SOFTAIL	86-90	1340cc 4T				18300BN 18300CN		
	FLST HERITAGE SOFTAIL	06-06	1450cc 4T				18199BN 18199CN 18199N		
	FLSTB SOFTAIL FAT BOY SPECIAL	10-10	1584cc 4T						H4008 H4008C

IT	ALTERNATORE	BOBINA	CENTRALINA	MOTORINO AVVIAMENTO	REGOLATORE	STATORE
EN	ALTERNATOR	COIL	CDI	STARTER ENGINE	RECTIFIER	STATOR
FR	ALTERNATEUR	BOBINE	BOÎTIER ÉLECTRONIQUE	DÉMARREUR ÉLECTRIQUE	RÉGULATEUR	STATOR



HARLEY DAVIDSON	Model	Year	Engine	Part 1	Part 2	Part 3	Part 4	Part 5	Part 6
HARLEY DAVIDSON	FLSTC HERITAGE SOFTAIL CLASSIC	88-88	1340cc 4T				18300BN 18300CN		
	FLSTC HERITAGE SOFTAIL CLASSIC	89-90	1340cc 4T				17629BN 17629CN		
	FLSTC HERITAGE SOFTAIL CLASSIC	91-93	1340cc 4T				17629CN-HT 17629N	17629BN 17629CN	
	FLSTC HERITAGE SOFTAIL CLASSIC	94-98	1340cc 4T				18199N 18446CN 18446N	18199BN 18199CN	
	FLSTC HERITAGE SOFTAIL CLASSIC	99-06	1450cc 4T				18199N 18446CN 18446N	18199BN 18199CN	
	FLSTC HERITAGE SOFTAIL CLASSIC	07-07	1584cc 4T				18905BN 18905CN	H4007 H4007C	
	FLSTC HERITAGE SOFTAIL CLASSIC	08-10	1584cc 4T					H4008 H4008C	
	FLSTCI HERITAGE SOFTAIL CLASSIC	88-90	1340cc 4T				17629BN 17629CN		
	FLSTCI HERITAGE SOFTAIL CLASSIC	89-98	1340cc 4T					H1988 H1988C	
	FLSTCI HERITAGE SOFTAIL CLASSIC	91-93	1340cc 4T				17629BN 17629CN 17629N		
	FLSTCI HERITAGE SOFTAIL CLASSIC	92-93	1340cc 4T				17629CN-HT		
	FLSTCI HERITAGE SOFTAIL CLASSIC	94-98	1340cc 4T				18199N 18446CN 18446N	18199BN 18199CN	
	FLSTCI HERITAGE SOFTAIL CLASSIC	99-06	1450cc 4T				18199N 18446CN 18446N	18199BN 18199CN	
	FLSTCI HERITAGE SOFTAIL CLASSIC	00-00	1450cc 4T					H1200 H1200C	
	FLSTCI HERITAGE SOFTAIL CLASSIC	01-06	1450cc 4T					H1001 H1001C	
	FLSTCI HERITAGE SOFTAIL CLASSIC	07-07	1584cc 4T				18905BN 18905CN	H4007 H4007C	
	FLSTCI HERITAGE SOFTAIL CLASSIC	08-09	1584cc 4T					H4008 H4008C	
	FLSTF FAT BOY	90-90	1340cc 4T				17629BN 17629CN		
	FLSTF FAT BOY	91-93	1340cc 4T				17629CN-HT 17629N	17629BN 17629CN	
	FLSTF FAT BOY	94-98	1340cc 4T				18199N 18446CN 18446N	18199BN 18199CN	
FLSTF FAT BOY	99-06	1450cc 4T				18199N 18446CN 18446N	18199BN 18199CN		
FLSTF FAT BOY	07-07	1584cc 4T				18905BN	H4007 H4007C		
FLSTF FAT BOY	07-11	1584cc 4T				18905CN			
FLSTF FAT BOY	08-10	1584cc 4T					H4008 H4008C		
FLSTF FAT BOY	08-11	1584cc 4T				18905BN			
FLSTF FAT BOY	12-13	1690cc 4T				18905BN 18905CN			
FLSTFI FAT BOY	90-90	1340cc 4T				17629BN 17629CN			
FLSTFI FAT BOY	91-93	1340cc 4T				17629CN-HT 17629N	17629BN 17629CN		
FLSTFI FAT BOY	94-98	1340cc 4T				18199N 18446CN 18446N	18199BN 18199CN		
FLSTFI FAT BOY	99-06	1450cc 4T				18446CN 18446N	18199BN 18199N		

IT	ALTERNATORE	BOBINA	CENTRALINA	MOTORINO AVVIAMENTO	REGOLATORE	STATORE
EN	ALTERNATOR	COIL	CDI	STARTER ENGINE	RECTIFIER	STATOR
FR	ALTERNATEUR	BOBINE	BOÎTIER ÉLECTRONIQUE	DÉMARREUR ÉLECTRIQUE	RÉGULATEUR	STATOR
						



HARLEY DAVIDSON	Model	Year	Engine	Part 1	Part 2	Part 3	Part 4	Part 5	Part 6
HARLEY DAVIDSON	FLSTFI FAT BOY	00-00	1450cc 4T						H1200 H1200C
	FLSTFI FAT BOY	01-06	1450cc 4T				18199CN		
	FLSTFI FAT BOY	07-07	1584cc 4T						H4007 H4007C
	FLSTFI FAT BOY	08-09	1584cc 4T						H4008 H4008C
	FLSTFSE SCREAMIN EAGLE FAT BOY	05-05	1690cc 4T						H1001 H1001C
	FLSTFSE2 SCREAMIN EAGLE FAT BOY	06-06	1690cc 4T						H1001 H1001C
	FLSTI HERITAGE SOFTAIL	86-88	1340cc 4T				18300BN 18300CN		
	FLSTI HERITAGE SOFTAIL	89-90	1340cc 4T				17629BN 17629CN		H1988 H1988C
	FLSTI HERITAGE SOFTAIL	06-06	1450cc 4T				18199N 18446CN 18446N	18199BN 18199CN	H1001 H1001C
	FLSTN HERITAGE SOFTAIL NOSTALGIA	93-93	1340cc 4T				17629CN-HT 17629N	17629BN 17629CN	
	FLSTN HERITAGE SOFTAIL SPECIAL	94-96	1340cc 4T				18199N 18446CN 18446N	18199BN 18199CN	
	FLSTN SOFTAIL DELUXE	05-06	1450cc 4T				18199N 18446CN 18446N	18199BN 18199CN	
	FLSTN SOFTAIL DELUXE	07-07	1584cc 4T						H4007 H4007C
	FLSTN SOFTAIL DELUXE	07-11	1584cc 4T				18905BN 18905CN		
	FLSTN SOFTAIL DELUXE	08-10	1584cc 4T						H4008 H4008C
	FLSTN SOFTAIL DELUXE	12-13	1690cc 4T				18905BN 18905CN		
	FLSTNI SOFTAIL DELUXE	93-93	1340cc 4T				17629CN-HT 17629N	17629BN 17629CN	
	FLSTNI SOFTAIL DELUXE	93-96	1340cc 4T				18199N 18446CN 18446N	18199BN 18199CN	H1988 H1988C
	FLSTNI SOFTAIL DELUXE	05-06	1450cc 4T				18199N 18446CN 18446N	18199BN 18199CN	H1001 H1001C
	FLSTNI SOFTAIL DELUXE	07-07	1584cc 4T						H4007 H4007C
	FLSTNI SOFTAIL DELUXE	08-09	1584cc 4T						H4008 H4008C
	FLSTS HERITAGE SPRINGER	97-98	1340cc 4T				18199N 18446CN 18446N	18199BN 18199CN	
	FLSTS HERITAGE SPRINGER	99-03	1450cc 4T				18199N 18446CN 18446N	18199BN 18199CN	
	FLSTSB CROSS BONES	08-10	1584cc 4T						H4008 H4008C
	FLSTSC SOFTAIL SPRINGER CLASSIC	05-06	1450cc 4T				18446CN 18446N	18199BN 18199N	
	FLSTSC SOFTAIL SPRINGER CLASSIC	07-07	1584cc 4T				18905BN 18905CN		H4007 H4007C
	FLSTSCI SOFTAIL SPRINGER CLASSIC	05-06	1450cc 4T				18199N 18446CN 18446N	18199BN 18199CN	H1001 H1001C
	FLSTSCI SOFTAIL SPRINGER CLASSIC	07-07	1584cc 4T						H4007 H4007C
FLSTSE CVO SOFTAIL CONVERTIBLE	10-10	1584cc 4T				18905BN 18905CN			
FLSTSE2 CVO SOFTAIL CONVERTIBLE	11-12	1800cc 4T				18905BN 18905CN			

IT	ALTERNATORE	BOBINA	CENTRALINA	MOTORINO AVVIAMENTO	REGOLATORE	STATORE
EN	ALTERNATOR	COIL	CDI	STARTER ENGINE	RECTIFIER	STATOR
FR	ALTERNATEUR	BOBINE	BOÎTIER ÉLECTRONIQUE	DÉMARREUR ÉLECTRIQUE	RÉGULATEUR	STATOR
						

HARLEY DAVIDSON	Model	Year	Engine	Part	Part	Part	Part	Part	Part
HARLEY DAVIDSON	FLSTSE3 CVO SOFTAIL CONVERTIBLE	12-12	1800cc 4T					18905BN 18905CN	
	FLSTSI HERITAGE SPRINGER	97-98	1340cc 4T					18199N 18446CN 18446N 18199N 18446CN 18446N	18199BN 18199CN 18199BN 18199CN
	FLSTSI HERITAGE SPRINGER	99-03	1450cc 4T						
	FLSTSI HERITAGE SPRINGER	00-00	1450cc 4T						H1200 H1200C
	FLT TOUR GLIDE	80-80	1340cc 4T						H1075 H1075C
	FLT TOUR GLIDE	80-83	1340cc 4T					5780BN 5780CN	
	FLT TOUR GLIDE	83-83	1340cc 4T					18300BN 18300CN 5780CN	
	FLTC TOUR GLIDE CLASSIC	81-81	1340cc 4T					5780BN 5780CN	
	FLTC TOUR GLIDE CLASSIC	82-88	1340cc 4T					18300BN 18300CN	
	FLTC TOUR GLIDE CLASSIC	89-90	1340cc 4T					17629BN 17629CN	
	FLTC TOUR GLIDE CLASSIC	91-91	1340cc 4T					17629CN-HT 17629N	17629BN 17629CN
	FLTC/I TOUR GLIDE CLASSIC	81-81	1340cc 4T					5780BN 5780CN	
	FLTC/I TOUR GLIDE CLASSIC	82-88	1340cc 4T					18300BN 18300CN	
	FLTC/I TOUR GLIDE CLASSIC	89-90	1340cc 4T					17629BN 17629CN	H1988 H1988C
	FLTC/I TOUR GLIDE CLASSIC	91-91	1340cc 4T					17629CN-HT 17629N	17629BN 17629CN
	FLTCU TOUR GLIDE ULTRA CLASSIC	89-90	1340cc 4T					17629BN 17629CN	
	FLTCU TOUR GLIDE ULTRA CLASSIC	91-93	1340cc 4T					17629CN-HT 17629N	17629BN 17629CN
	FLTCU TOUR GLIDE ULTRA CLASSIC	94-95	1340cc 4T					18199N 18446CN 18446N	18199BN 18199CN
	FLTCUI TOUR GLIDE ULTRA CLASSIC	89-90	1340cc 4T					17629BN 17629CN	H1988 H1988C
	FLTCUI TOUR GLIDE ULTRA CLASSIC	91-93	1340cc 4T					17629CN-HT 17629N	17629BN 17629CN
	FLTCUI TOUR GLIDE ULTRA CLASSIC	94-95	1340cc 4T					18199N 18446CN 18446N 18199N 18446CN 18446N	18199BN 18199CN 18199BN 18199CN
	FLTCUI TOUR GLIDE ULTRA CLASSIC	96-96	1340cc 4T					18199N 18446CN 18446N	18199BN 18199CN
	FLTR ROAD GLIDE	99-99	1340cc 4T					18199BN 18199CN 18199N	
	FLTR ROAD GLIDE	99-01	1450cc 4T						H0597 H0597C
	FLTR ROAD GLIDE	00-02	1450cc 4T					18199N 18446CN 18446N	18199BN 18199CN
	FLTR ROAD GLIDE	02-02	1450cc 4T						H0502 H0502C
	FLTR ROAD GLIDE	07-07	1584cc 4T					18905BN 18905CN	
	FLTR ROAD GLIDE	07-08	1584cc 4T						H0506 H0506C
FLTR ROAD GLIDE	09-09	1584cc 4T						H0505 H0505C	
FLTR ROAD GLIDE	98-99	1638cc 4T					18199N 18446CN 18446N	18199BN 18199CN	

IT	ALTERNATORE	BOBINA	CENTRALINA	MOTORINO AVVIAMENTO	REGOLATORE	STATORE
EN	ALTERNATOR	COIL	CDI	STARTER ENGINE	RECTIFIER	STATOR
FR	ALTERNATEUR	BOBINE	BOÎTIER ÉLECTRONIQUE	DÉMARREUR ÉLECTRIQUE	RÉGULATEUR	STATOR
						

HARLEY DAVIDSON	Model	Year	Engine	Part 1	Part 2	Part 3	Part 4	Part 5	Part 6
HARLEY DAVIDSON	FLTRI ROAD GLIDE	98-98	1340cc 4T				18199N 18446CN 18446N	18199BN 18199CN	H1988 H1988C
	FLTRI ROAD GLIDE	99-01	1450cc 4T						H0597 H0597C
	FLTRI ROAD GLIDE	99-06	1450cc 4T				18199N 18446CN 18446N	18199BN 18199CN	
	FLTRI ROAD GLIDE	02-03	1450cc 4T						H0502 H0502C
	FLTRI ROAD GLIDE	06-06	1450cc 4T						H0506
	FLTRI ROAD GLIDE	06-08	1584cc 4T						H0506C
	FLTRI ROAD GLIDE	07-08	1584cc 4T						H0506
	FLTRSE3 CVO ROAD GLIDE	09-09	1584cc 4T					18905BN 18905CN	
	FLTRSE1 SCREAMIN EAGLE ROAD GLIDE	00-00	1550cc 4T				18199N 18446CN 18446N	18199BN 18199CN	
	FLTRSE12 SCREAMIN EAGLE ROAD GLIDE 2	01-01	1550cc 4T				18199N 18446CN 18446N	18199BN 18199CN	
	FLTRU ROAD GLIDE ULTRA	11-13	1690cc 4T						H0505 H0505C
	FLTRUSE CVO ROAD GLIDE ULTRA	11-11	1800cc 4T					18905BN 18905CN	
	FLTRX ROAD GLIDE CUSTOM	10-13	1584cc 4T						H0505 H0505C
	FLTRX ROAD GLIDE CUSTOM	12-13	1690cc 4T						H0505 H0505C
	FX SUPER GLIDE	71-75	1200cc 4T						H1070 H1070C
	FX SUPER GLIDE	71-78	1200cc 4T					18300BN 18300CN	
	FXB STURGIS	80-82	1340cc 4T					18300BN 18300CN	
	FXCW ROCKER	08-09	1584cc 4T						H4008 H4008C
	FXCWC ROCKER C	08-10	1584cc 4T						H4008 H4008C
	FXD DYNA SUPER GLIDE	95-98	1340cc 4T				18199N 18446CN 18446N	18199BN 18199CN	
FXD DYNA SUPER GLIDE	99-05	1450cc 4T				18199N 18446CN 18446N	18199BN 18199CN		
FXD DYNA SUPER GLIDE	05-05	1450cc 4T						H3104 H3104C	
FXD DYNA SUPER GLIDE	07-07	1584cc 4T					18905BN 18905CN	H3106 H3106C	
FXD DYNA SUPER GLIDE	08-10	1584cc 4T						H3108 H3108C	
FXD35 SUPER GOLDEN ANNIVERSARY	06-06	1450cc 4T				18446CN 18446N	18199BN 18199N		
FXD35 SUPER GOLDEN ANNIVERSARY	06-06	1450cc 4T						H3106 H3106C	
FXDB STREET BOB	07-07	1584cc 4T						H3106 H3106C	
FXDB STREET BOB	08-13	1584cc 4T						H3108C	
FXDB STREET BOB	09-14	1690cc 4T						H3108	
FXDB STREET BOB	14-14	1690cc 4T						H3108 H3108C	

IT	ALTERNATORE	BOBINA	CENTRALINA	MOTORINO AVVIAMENTO	REGOLATORE	STATORE
EN	ALTERNATOR	COIL	CDI	STARTER ENGINE	RECTIFIER	STATOR
FR	ALTERNATEUR	BOBINE	BOÎTIER ÉLECTRONIQUE	DÉMARREUR ÉLECTRIQUE	RÉGULATEUR	STATOR
						

HARLEY DAVIDSON	Model	Year	Capacity	Part 1	Part 2	Part 3	Part 4	Part 5	Part 6	
HARLEY DAVIDSON	FXDB-D DYNA GLIDE DAYTONA	92-92	1340cc 4T				17629CN-HT 17629N	17629BN 17629CN		
	FXDB-S DYNA GLIDE STURGIS	91-91	1340cc 4T				17629CN-HT 17629N	17629BN 17629CN		
	FXDBA STREET BOB	06-06	1584cc 4T						H3106 H3106C	
	FXDBA STREET BOB	13-13	1584cc 4T						H3108 H3108C	
	FXDBI STREET BOB	06-06	1450cc 4T				18199N 18446CN 18446N	18199BN 18199CN	H3106 H3106C	
	FXDBP STREET BOB	13-14	1584cc 4T						H3108 H3108C	
	FXDC SUPER GLIDE CUSTOM	92-92	1340cc 4T				17629CN-HT 17629N	17629BN 17629CN		
	FXDC SUPER GLIDE CUSTOM	05-05	1450cc 4T				18199N 18446CN 18446N	18199BN 18199CN	H3104 H3104C	
	FXDC SUPER GLIDE CUSTOM	07-07	1584cc 4T						H3106 H3106C	
	FXDC SUPER GLIDE CUSTOM	08-13	1584cc 4T						H3108 H3108C	
	FXDC SUPER GLIDE CUSTOM	14-14	1690cc 4T						H3108 H3108C	
	FXDCI SUPER GLIDE CUSTOM	05-05	1450cc 4T						H3104 H3104C	
	FXDCI SUPER GLIDE CUSTOM	06-06	1450cc 4T				18199N 18446CN 18446N	18199BN 18199CN	H3106 H3106C	
	FXDF FAT BOB	08-13	1584cc 4T						H3108 H3108C	
	FXDF FAT BOB	12-14	1690cc 4T						H3108 H3108C	
	FXDF FAT BOB	10-10	1800cc 4T						H3108 H3108C	
	FXDFSE CVO DYNA FAT BOB	09-09	1800cc 4T					18905BN 18905CN	H3108 H3108C	
	FXDFSE2 CVO DYNA FAT BOB	10-10	1584cc 4T					18905BN 18905CN		
	FXDG DISC GLIDE	83-83	1340cc 4T					18300BN 18300CN	H1686	
	FXDI DYNA SUPER GLIDE	95-98	1340cc 4T				18199N 18446CN 18446N	18199BN 18199CN	H1988 H1988C	
FXDI DYNA SUPER GLIDE	99-03	1450cc 4T						H1899 H1899C		
FXDI DYNA SUPER GLIDE	99-06	1450cc 4T				18199N 18446CN 18446N	18199BN 18199CN			
FXDI DYNA SUPER GLIDE	04-05	1450cc 4T						H3104 H3104C		
FXDI DYNA SUPER GLIDE	06-07	1450cc 4T						H3106 H3106C		
FXDI DYNA SUPER GLIDE	08-09	1584cc 4T						H3108 H3108C		
FXDI35 DYNA 35TH ANNIVERSARY SUPER GLIDE	06-06	1450cc 4T						H3106 H3106C		
FXDL DYNA LOW RIDER	93-93	1340cc 4T				17629CN-HT 17629N	17629BN 17629CN			
FXDL DYNA LOW RIDER	94-98	1340cc 4T				18199N 18446CN 18446N	18199BN 18199CN			
FXDL DYNA LOW RIDER	99-05	1450cc 4T				18199N 18446CN 18446N	18199BN 18199CN			
FXDL DYNA LOW RIDER	05-05	1450cc 4T						H3104 H3104C		

IT	ALTERNATORE	BOBINA	CENTRALINA	MOTORINO AVVIAMENTO	REGOLATORE	STATORE
EN	ALTERNATOR	COIL	CDI	STARTER ENGINE	RECTIFIER	STATOR
FR	ALTERNATEUR	BOBINE	BOÎTIER ÉLECTRONIQUE	DÉMARREUR ÉLECTRIQUE	RÉGULATEUR	STATOR
						

HARLEY DAVIDSON	Model	Year	Engine	Part 1	Part 2	Part 3	Part 4	Part 5	Part 6
HARLEY DAVIDSON	FXDL DYNA LOW RIDER	06-07	1584cc 4T						H3106 H3106C
	FXDL DYNA LOW RIDER	07-07	1584cc 4T					18905BN 18905CN	
	FXDL DYNA LOW RIDER	08-11	1584cc 4T						H3108 H3108C
	FXDLI DYNA LOW RIDER	93-93	1340cc 4T				17629CN-HT 17629N	17629BN 17629CN	H1988 H1988C
	FXDLI DYNA LOW RIDER	94-98	1340cc 4T				18199N 18446CN 18446N	18199BN 18199CN	H1988 H1988C
	FXDLI DYNA LOW RIDER	99-03	1450cc 4T						H1899 H1899C
	FXDLI DYNA LOW RIDER	99-06	1450cc 4T				18199N 18446CN 18446N	18199BN 18199CN	
	FXDLI DYNA LOW RIDER	04-05	1450cc 4T						H3104 H3104C
	FXDLI DYNA LOW RIDER	06-07	1584cc 4T						H3106 H3106C
	FXDLI DYNA LOW RIDER	08-09	1584cc 4T						H3108 H3108C
	FXDS-CONV DYNA CONVERTIBLE	94-98	1340cc 4T				18199N 18446CN 18446N	18199BN 18199CN	
	FXDS-CONV DYNA CONVERTIBLE	99-00	1450cc 4T				18199N 18446CN 18446N	18199BN 18199CN	H1899 H1899C
	FXDSE SCREAMIN EAGLE DYNA	07-07	1800cc 4T					18905BN 18905CN	H3106 H3106C
	FXDSE2 SCREAMIN EAGLE DYNA	08-08	1800cc 4T					18905BN 18905CN	H3108 H3108C
	FXDWG DYNA WIDE GLIDE	93-93	1340cc 4T				17629CN-HT 17629N	17629BN 17629CN	
	FXDWG DYNA WIDE GLIDE	94-98	1340cc 4T				18199N 18446CN 18446N	18199BN 18199CN	
	FXDWG DYNA WIDE GLIDE	99-05	1450cc 4T				18199N 18446CN 18446N	18199BN 18199CN	
	FXDWG DYNA WIDE GLIDE	05-05	1450cc 4T						H3104 H3104C
	FXDWG DYNA WIDE GLIDE	07-07	1584cc 4T					18905BN 18905CN	H3106 H3106C
	FXDWG DYNA WIDE GLIDE	08-11	1584cc 4T						H3108 H3108C
	FXDWG DYNA WIDE GLIDE	12-14	1690cc 4T						H3108 H3108C
	FXDWG2	01-01	1450cc 4T				18199N 18446CN 18446N	18199BN 18199CN	
	FXDWG3	02-02	1450cc 4T				18199N 18446CN 18446N	18199BN 18199CN	
	FXDWGI DYNA WIDE GLIDE	93-93	1340cc 4T				17629CN-HT 17629N	17629BN 17629CN	H1988 H1988C
	FXDWGI DYNA WIDE GLIDE	94-98	1340cc 4T				18199N 18446CN 18446N	18199BN 18199CN	H1988 H1988C
	FXDWGI DYNA WIDE GLIDE	99-03	1450cc 4T					18199CN	H1899 H1899C
	FXDWGI DYNA WIDE GLIDE	99-06	1450cc 4T				18446CN 18446N	18199BN 18199N	
	FXDWGI DYNA WIDE GLIDE	04-05	1450cc 4T						H3104 H3104C
	FXDWGI DYNA WIDE GLIDE	06-07	1584cc 4T						H3106 H3106C
	FXDWGI DYNA WIDE GLIDE	08-08	1584cc 4T						H3108 H3108C

IT	ALTERNATORE	BOBINA	CENTRALINA	MOTORINO AVVIAMENTO	REGOLATORE	STATORE
EN	ALTERNATOR	COIL	CDI	STARTER ENGINE	RECTIFIER	STATOR
FR	ALTERNATEUR	BOBINE	BOÎTIER ÉLECTRONIQUE	DÉMARREUR ÉLECTRIQUE	RÉGULATEUR	STATOR
						





HARLEY DAVIDSON	Model	Year	Capacity	Part Number		Part Name
				Left	Right	
FXDX DYNA SUPER GLIDE SPORT	99-03	1450cc 4T				H1899 H1899C
	99-05	1450cc 4T			18199N 18446CN 18446N	18199BN 18199CN
FXDX DYNA SUPER GLIDE SPORT	04-05	1450cc 4T				H3104 H3104C
FXDX DYNA SUPER GLIDE SPORT	04-05	1450cc 4T			18199N 18446CN 18446N	18199BN 18199CN
FXDXT DYNA SUPER GLIDE T-SPORT	01-03	1450cc 4T			18199N 18446CN 18446N	18199BN 18199CN
FXE SUPER GLIDE	74-75	1200cc 4T				H1070 H1070C
FXE SUPER GLIDE	74-80	1200cc 4T				18300BN 18300CN
FXE SUPER GLIDE	79-84	1340cc 4T				18300BN 18300CN
FXEF FAT BOB	79-81	1340cc 4T				18300BN
FXEF FAT BOB	79-85	1340cc 4T				18300CN
FXEF FAT BOB	85-85	1340cc 4T				18300BN
FXLR LOW RIDER CUSTOM	87-88	1340cc 4T				18300BN 18300CN
FXLR LOW RIDER CUSTOM	89-90	1340cc 4T				17629BN 17629CN
FXLR LOW RIDER CUSTOM	91-93	1340cc 4T			17629CN-HT 17629N	17629BN 17629CN
FXLR LOW RIDER CUSTOM	94-94	1340cc 4T			18199N 18446CN 18446N	18199BN 18199CN
FXR SUPER GLIDE II	82-83	1340cc 4T				5780BN 5780CN
FXR SUPER GLIDE II	83-88	1340cc 4T				18300BN 18300CN
FXR SUPER GLIDE II	89-90	1340cc 4T				17629BN 17629CN
FXR SUPER GLIDE II	91-93	1340cc 4T			17629CN-HT 17629N	17629BN 17629CN
FXR SUPER GLIDE II	94-94	1340cc 4T			18199N 18446CN 18446N	18199BN 18199CN
FXR2	99-99	1340cc 4T			18199N 18446CN 18446N	18199BN 18199CN
FXR3	99-99	1340cc 4T			18199N 18446CN 18446N	18199BN 18199CN
FXR4	00-00	1450cc 4T			18199N 18446CN 18446N	18199BN 18199CN
FXRC LOW RIDER CHROME	85-87	1340cc 4T				18300BN 18300CN
FXRD SPORT GLIDE GRAND TOURING	86-86	1340cc 4T				18300BN 18300CN
FXRDG DISC GLIDE	84-84	1340cc 4T				18300BN 18300CN
FXRP POLICE	85-88	1340cc 4T				18300BN 18300CN
FXRP POLICE	89-89	1340cc 4T				17629BN 17629CN
FXRS LOW GLIDE	82-83	1340cc 4T				5780BN 5780CN
FXRS LOW GLIDE	84-88	1340cc 4T				18300BN 18300CN

IT	ALTERNATORE	BOBINA	CENTRALINA	MOTORINO AVVIAMENTO	REGOLATORE	STATORE
EN	ALTERNATOR	COIL	CDI	STARTER ENGINE	RECTIFIER	STATOR
FR	ALTERNATEUR	BOBINE	BOÎTIER ÉLECTRONIQUE	DÉMARREUR ÉLECTRIQUE	RÉGULATEUR	STATOR
						



HARLEY DAVIDSON	Model	Year	Engine	Part 1	Part 2	Part 3	Part 4	Part 5	Part 6	
	FXRS LOW GLIDE	89-90	1340cc 4T					17629BN 17629CN	H1988 H1988C	
	FXRS LOW GLIDE	91-92	1340cc 4T					17629CN-HT 17629N	17629BN 17629CN	H1988 H1988C
	FXRS LOW RIDER LIBERTY	86-86	1340cc 4T					18300BN 18300CN		
	FXRS-CONV LOW RIDER SPORT CONVERTIBLE	90-90	1340cc 4T					17629BN 17629CN	H1988 H1988C	
	FXRS-CONV LOW RIDER SPORT CONVERTIBLE	91-93	1340cc 4T					17629CN-HT 17629N	17629BN 17629CN	H1988 H1988C
	FXRS-SP LOW RIDER SPORT	86-88	1340cc 4T						H1686	
	FXRS-SP LOW RIDER SPORT	86-90	1340cc 4T					17629BN 17629CN		
	FXRS-SP LOW RIDER SPORT	89-93	1340cc 4T						H1988 H1988C	
	FXRS-SP LOW RIDER SPORT	91-93	1340cc 4T					17629CN-HT 17629N	17629BN 17629CN	
	FXRT SPORT GLIDE	83-88	1340cc 4T					18300BN 18300CN	H1686	
	FXRT SPORT GLIDE	89-90	1340cc 4T					17629BN 17629CN	H1988 H1988C	
	FXRT SPORT GLIDE	91-92	1340cc 4T					17629CN-HT 17629N	17629BN 17629CN	H1988 H1988C
	FXS LOW RIDER	77-78	1200cc 4T					18300CN		
	FXS LOW RIDER	77-82	1340cc 4T					18300BN		
	FXS LOW RIDER	79-82	1340cc 4T					18300CN		
	FXSB LOW RIDER - BELT	83-85	1340cc 4T					18300BN 18300CN		
	FXSBSE CVO BREAKOUT	13-13	1800cc 4T					18905BN		
	FXST SOFTAIL STANDARD	84-88	1340cc 4T					18300BN 18300CN		
	FXST SOFTAIL STANDARD	89-90	1340cc 4T					17629BN 17629CN		
	FXST SOFTAIL STANDARD	99-99	1340cc 4T					18199N 18446CN 18446N	18199BN 18199CN	
	FXST SOFTAIL STANDARD	00-06	1450cc 4T					18199N 18446CN 18446N	18199BN 18199CN	
	FXST SOFTAIL STANDARD	07-07	1584cc 4T					18905BN 18905CN	H4007 H4007C	
	FXST SOFTAIL STANDARD	08-08	1584cc 4T						H4008 H4008C	
	FXSTB NIGHT TRAIN	99-99	1340cc 4T					18199N 18446CN 18446N	18199BN 18199CN	
	FXSTB NIGHT TRAIN	00-06	1450cc 4T					18199N 18446CN 18446N	18199BN 18199CN	
	FXSTB NIGHT TRAIN	07-07	1584cc 4T					18905BN 18905CN	H4007 H4007C	
	FXSTBI NIGHT TRAIN	99-99	1340cc 4T					18199N 18446CN 18446N	18199BN 18199CN	H1988 H1988C
	FXSTBI NIGHT TRAIN	00-00	1450cc 4T						H1200 H1200C	
	FXSTBI NIGHT TRAIN	00-06	1450cc 4T					18199N 18446CN 18446N	18199BN 18199CN	
	FXSTBI NIGHT TRAIN	07-07	1584cc 4T						H4007 H4007C	

IT	ALTERNATORE	BOBINA	CENTRALINA	MOTORINO AVVIAMENTO	REGOLATORE	STATORE
EN	ALTERNATOR	COIL	CDI	STARTER ENGINE	RECTIFIER	STATOR
FR	ALTERNATEUR	BOBINE	BOÎTIER ÉLECTRONIQUE	DÉMARREUR ÉLECTRIQUE	RÉGULATEUR	STATOR
						

HARLEY DAVIDSON	Model	Year	CC	Part 1	Part 2	Part 3	Part 4	Part 5	Part 6
HARLEY DAVIDSON	FXSTBI NIGHT TRAIN	08-09	1584cc 4T						H4008 H4008C
	FXSTC SOFTAIL CUSTOM	86-88	1340cc 4T				18300BN 18300CN		
	FXSTC SOFTAIL CUSTOM	89-90	1340cc 4T				17629BN 17629CN	H1988 H1988C	
	FXSTC SOFTAIL CUSTOM	91-93	1340cc 4T				17629CN-HT 17629N 17629CN	H1988 H1988C	
	FXSTC SOFTAIL CUSTOM	94-99	1340cc 4T				18199N 18446CN 18446N	18199BN 18199CN	H1988 H1988C
	FXSTC SOFTAIL CUSTOM	07-07	1584cc 4T				18905BN 18905CN		H4007 H4007C
	FXSTC SOFTAIL CUSTOM	08-10	1584cc 4T						H4008 H4008C
	FXSTD SOFTAIL DEUCE	00-06	1450cc 4T				18199N 18446CN 18446N	18199BN 18199CN	
	FXSTD SOFTAIL DEUCE	07-07	1584cc 4T				18905BN 18905CN		H4007 H4007C
	FXSTDI SOFTAIL DEUCE	00-00	1450cc 4T						H1200 H1200C
	FXSTDI SOFTAIL DEUCE	00-06	1450cc 4T				18199N 18446CN 18446N	18199BN 18199CN	
	FXSTDI SOFTAIL DEUCE	01-06	1450cc 4T						H1001 H1001C
	FXSTDI SOFTAIL DEUCE	07-07	1584cc 4T						H4007 H4007C
	FXSTDSE SCREAMIN EAGLE SOFTAIL DEUCE	03-03	1550cc 4T				18199N 18446CN 18446N	18199BN 18199CN	
	FXSTDSE2 SCREAMIN EAGLE SOFTAIL DEUCE 2	04-04	1550cc 4T				18199N 18446CN 18446N	18199BN 18199CN	
	FXSTI SOFTAIL STANDARD	84-88	1340cc 4T				18300BN 18300CN		
	FXSTI SOFTAIL STANDARD	89-90	1340cc 4T				17629BN 17629CN		
	FXSTI SOFTAIL STANDARD	89-91	1340cc 4T						H1988 H1988C
	FXSTI SOFTAIL STANDARD	99-99	1340cc 4T				18199BN 18199CN 18199N		
	FXSTI SOFTAIL STANDARD	00-00	1450cc 4T						H1200 H1200C
	FXSTI SOFTAIL STANDARD	00-06	1450cc 4T				18199N 18446CN 18446N	18199BN 18199CN	
	FXSTI SOFTAIL STANDARD	01-06	1450cc 4T						H1001 H1001C
	FXSTI SOFTAIL STANDARD	07-07	1584cc 4T						H4007 H4007C
	FXSTS SPRINGER SOFTAIL	88-88	1340cc 4T				18300BN 18300CN		
	FXSTS SPRINGER SOFTAIL	89-90	1340cc 4T				17629BN 17629CN		
	FXSTS SPRINGER SOFTAIL	91-93	1340cc 4T				17629CN-HT 17629N 17629CN	17629BN 17629CN	
	FXSTS SPRINGER SOFTAIL	94-99	1340cc 4T				18199N 18446CN 18446N	18199BN 18199CN	
	FXSTS SPRINGER SOFTAIL	00-06	1450cc 4T				18199N 18446CN 18446N	18199BN 18199CN	
FXSTSB BAD BOY	95-97	1340cc 4T				18199N 18446CN 18446N	18199BN 18199CN	H1988 H1988C	
FXSTSI SPRINGER SOFTAIL	88-88	1340cc 4T				18300BN 18300CN			

IT	ALTERNATORE	BOBINA	CENTRALINA	MOTORINO AVVIAMENTO	REGOLATORE	STATORE
EN	ALTERNATOR	COIL	CDI	STARTER ENGINE	RECTIFIER	STATOR
FR	ALTERNATEUR	BOBINE	BOÎTIER ÉLECTRONIQUE	DÉMARREUR ÉLECTRIQUE	RÉGULATEUR	STATOR
						

HARLEY DAVIDSON	Model	Year	Engine	Part 1	Part 2	Part 3	Part 4	Part 5	Part 6
	FXSTSI SPRINGER SOFTAIL	89-90	1340cc 4T				17629BN 17629CN	H1988 H1988C	
	FXSTSI SPRINGER SOFTAIL	91-93	1340cc 4T				17629CN-HT 17629N	17629BN 17629CN	H1988 H1988C
	FXSTSI SPRINGER SOFTAIL	94-99	1340cc 4T				18199N 18446CN 18446N	18199BN 18199CN	H1988 H1988C
	FXSTSI SPRINGER SOFTAIL	00-00	1450cc 4T						H1200 H1200C
	FXSTSI SPRINGER SOFTAIL	00-06	1450cc 4T				18199N 18446CN 18446N	18199BN 18199CN	
	FXSTSI SPRINGER SOFTAIL	01-06	1450cc 4T						H1001 H1001C
	FXSTSSE SCREAMIN EAGLE SOFTAIL SPRINGER	07-07	1800cc 4T				18905BN 18905CN		H4007 H4007C
	FXSTSSE2 SCREAMIN EAGLE SOFTAIL SPRINGER	08-08	1800cc 4T				18905BN 18905CN		H4008 H4008C
	FXSTSSE3 CVO SOFTAIL SPRINGER	09-09	1584cc 4T				18905BN 18905CN		H4008 H4008C
	FXWG WIDE GLIDE	80-86	1340cc 4T				18300BN 18300CN		
	VRSCA V-ROD	02-06	1130cc 4T				18478N 18478NC		
	VRSCAW V-ROD	07-07	1130cc 4T				18478N 18478NC		
	VRSCAW V-ROD	08-10	1250cc 4T				18478N 18478NC	H4408 H4408C	
	VRSCB V-ROD	04-05	1130cc 4T				18478N 18478NC		
	VRSCD NIGHT ROD	06-07	1130cc 4T				18478N 18478NC		
	VRSCD NIGHT ROD	08-08	1250cc 4T				18478N 18478NC	H4408 H4408C	
	VRSCDX ANN V-ROD ANNIVERSARY EDITION	12-12	1250cc 4T				18478N 18478NC	H4408 H4408C	
	VRSCDX NIGHT ROD SPECIAL	07-07	1130cc 4T				18478N 18478NC		
	VRSCDX NIGHT ROD SPECIAL	08-13	1250cc 4T				18478N 18478NC	H4408 H4408C	
	VRSCDX NIGHT ROD SPECIAL	14-14	1250cc 4T				18478N 18478NC	H4408 H4408C	
	VRSCF V-ROD MUSCLE	09-13	1250cc 4T				18478N 18478NC	H4408 H4408C	
	VRSCF V-ROD MUSCLE	14-14	1250cc 4T				18478N 18478NC	H4408 H4408C	
	VRSCR STREET ROD	06-07	1130cc 4T				18478N 18478NC		
	VRSCSE SCREAMIN EAGLE V-ROD	05-05	1250cc 4T				18478N 18478NC		
	VRSCSE2 SCREAMIN EAGLE V-ROD 2	06-06	1250cc 4T				18478N 18478NC		
	VRSCX V-ROD	07-07	1250cc 4T				18478N 18478NC		
	VRXSE SCREAMIN EAGLE DESTROYER	06-06	1300cc 4T				18478N 18478NC		
	XL SPORTSTER	93-03	883cc 4T				18477NC		
	XL SPORTSTER	93-95	1200cc 4T				18477NC		
	XL SPORTSTER ANNIV.	93-93	1200cc 4T				18477NC		

IT	ALTERNATORE	BOBINA	CENTRALINA	MOTORINO AVVIAMENTO	REGOLATORE	STATORE
EN	ALTERNATOR	COIL	CDI	STARTER ENGINE	RECTIFIER	STATOR
FR	ALTERNATEUR	BOBINE	BOÎTIER ÉLECTRONIQUE	DÉMARREUR ÉLECTRIQUE	RÉGULATEUR	STATOR
						

HARLEY DAVIDSON	Model	Year	Engine	Part 1	Part 2	Part 3	Part 4	Part 5	Part 6
	XL SPORTSTER DELUXE	93-95	883cc 4T				18477NC		
	XL SPORTSTER HUGGER	93-03	883cc 4T				18477NC		
	XL 1200C SPORTSTER 1200 CUSTOM	96-03	1200cc 4T					H2394 H2394C	
	XL 1200C SPORTSTER 1200 CUSTOM	96-14	1200cc 4T				18477N		
	XL 1200C SPORTSTER 1200 CUSTOM	04-06	1200cc 4T					H2304 H2304C	
	XL 1200C SPORTSTER 1200 CUSTOM	07-08	1200cc 4T					H4607 H4607C	
	XL 1200C SPORTSTER 1200 CUSTOM	09-13	1200cc 4T					H1108 H1108C	
	XL 1200C SPORTSTER 1200 CUSTOM	14-14	1200cc 4T				18477NC		
	XL1200CA 1200 CUSTOM LIMITED A	13-13	1200cc 4T					H1108 H1108C	
	XL1200CB 1200 CUSTOM LIMITED B	13-13	1200cc 4T					H1108 H1108C	
	XL 1200CP 1200 CUSTOM	11-13	1200cc 4T					H1108 H1108C	
	XL 1200L SPORTSTER 1200 LOW	06-06	1200cc 4T					H2304 H2304C	
	XL 1200L SPORTSTER 1200 LOW	06-11	1200cc 4T				18477NC		
	XL 1200L SPORTSTER 1200 LOW	07-08	1200cc 4T					H4607 H4607C	
	XL 1200L SPORTSTER 1200 LOW	09-10	1200cc 4T					H1108 H1108C	
	XL 1200N SPORTSTER 1200 NIGHTSTER	07-08	1200cc 4T					H4607 H4607C	
	XL 1200N SPORTSTER 1200 NIGHTSTER	07-12	1200cc 4T				18477NC		
	XL 1200N SPORTSTER 1200 NIGHTSTER	09-12	1200cc 4T					H1108 H1108C	
	XL 1200R SPORTSTER 1200 ROADSTER	04-06	1200cc 4T					H2304 H2304C	
	XL 1200R SPORTSTER 1200 ROADSTER	04-08	1200cc 4T				18477NC		
	XL 1200R SPORTSTER 1200 ROADSTER	07-08	1200cc 4T					H4607 H4607C	
	XL 1200R SPORTSTER 1200 ROADSTER	09-09	1200cc 4T					H1108 H1108C	
	XL 1200S SPORTSTER 1200 SPORT	96-03	1200cc 4T				18477NC	H2394 H2394C	
	XL 1200V SEVENTY-TWO	12-13	1200cc 4T					H1108 H1108C	
	XL 1200V SEVENTY-TWO	12-14	1200cc 4T				18477N		
	XL 1200V SEVENTY-TWO	14-14	1200cc 4T				18477NC		
	XL 1200X FORTY-EIGHT	10-14	1200cc 4T				18477N		
	XL 1200X FORTY-EIGHT	11-13	1200cc 4T					H1108 H1108C	
	XL 1200X FORTY-EIGHT	14-14	1200cc 4T				18477NC		
	XL 50 50TH ANNIVERSARY SPORTSTER	07-07	1200cc 4T				18477NC	H4607 H4607C	

IT	ALTERNATORE	BOBINA	CENTRALINA	MOTORINO AVVIAMENTO	REGOLATORE	STATORE
EN	ALTERNATOR	COIL	CDI	STARTER ENGINE	RECTIFIER	STATOR
FR	ALTERNATEUR	BOBINE	BOÎTIER ÉLECTRONIQUE	DÉMARREUR ÉLECTRIQUE	RÉGULATEUR	STATOR
						

HARLEY DAVIDSON	Model	Year	Engine	Part	Part Number	Part Number
HARLEY DAVIDSON	XL883 SPORTSTER	04-06	883cc 4T			H2304 H2304C
	XL883 SPORTSTER	04-08	883cc 4T		18477NC	
	XL883 SPORTSTER	07-08	883cc 4T			H4607 H4607C
	XL883 SPORTSTER	09-09	883cc 4T			H1108 H1108C
	XL883C SPORTSTER 883 CUSTOM	98-98	883cc 4T		18477NC	
	XL883C SPORTSTER 883 CUSTOM	98-03	883cc 4T			H2394 H2394C
	XL883C SPORTSTER 883 CUSTOM	98-10	883cc 4T		18477NC	
	XL883C SPORTSTER 883 CUSTOM	04-06	883cc 4T			H2304 H2304C
	XL883C SPORTSTER 883 CUSTOM	07-08	883cc 4T			H4607 H4607C
	XL883C SPORTSTER 883 CUSTOM	09-10	883cc 4T			H1108 H1108C
	XL883L SPORTSTER 883 LOW	05-06	883cc 4T			H2304 H2304C
	XL883L SPORTSTER 883 LOW	05-11	883cc 4T		18477NC	
	XL883L SPORTSTER 883 LOW	07-08	883cc 4T			H4607 H4607C
	XL883L SPORTSTER 883 LOW	09-10	883cc 4T			H1108 H1108C
	XL883L SUPERLOW	11-13	883cc 4T			H1108 H1108C
	XL883L SUPERLOW	11-14	883cc 4T		18477N 18477NC	
	XL883N IRON 883	09-13	883cc 4T			H1108 H1108C
	XL883N IRON 883	09-14	883cc 4T		18477N	
	XL883N IRON 883	14-14	883cc 4T		18477NC	
	XL883R SPORTSTER 883 ROADSTER	02-03	883cc 4T			H2394 H2394C
	XL883R SPORTSTER 883 ROADSTER	02-13	883cc 4T		18477NC	
	XL883R SPORTSTER 883 ROADSTER	05-06	883cc 4T			H2304 H2304C
	XL883R SPORTSTER 883 ROADSTER	07-08	883cc 4T			H4607 H4607C
	XL883R SPORTSTER 883 ROADSTER	08-09	883cc 4T		18477NC	
	XL883R SPORTSTER 883 ROADSTER	09-13	883cc 4T			H1108 H1108C
	XLC	58-58	900cc 4T		15410BN	
XLC	58-58	900cc 4T		5780BN 5780CN		
XLC SPORTSTER CUSTOM	00-07	883cc 4T		18477NC		
XLC SPORTSTER CUSTOM	00-07	1200cc 4T		18477NC		
XLCH	58-71	900cc 4T		15410BN		

IT	ALTERNATORE	BOBINA	CENTRALINA	MOTORINO AVVIAMENTO	REGOLATORE	STATORE
EN	ALTERNATOR	COIL	CDI	STARTER ENGINE	RECTIFIER	STATOR
FR	ALTERNATEUR	BOBINE	BOÎTIER ÉLECTRONIQUE	DÉMARREUR ÉLECTRIQUE	RÉGULATEUR	STATOR
						

HARLEY DAVIDSON	Model	Year	Engine	Part 1	Part 2	Part 3	Part 4	Part 5	Part 6
HARLEY DAVIDSON	XLCH	58-71	900cc 4T				5780BN 5780CN		
	XLCH	72-75	1200cc 4T					H1070 H1070C	
	XLCH	72-78	1200cc 4T				15410BN		
	XLCH	72-78	1200cc 4T				5780BN 5780CN		
	XLCH	74-76	1200cc 4T				18300BN 18300CN		
	XLCH	79-79	1340cc 4T				15410BN		
	XLCH	79-79	1340cc 4T				5780BN 5780CN		
	XLCH SPORTSTER	75-78	1000cc 4T				5780BN 5780CN		
	XLCR CAFE RACER	77-78	1000cc 4T				15410BN		
	XLCR CAFE RACER	77-78	1000cc 4T				5780BN 5780CN		
	XLH SPORTSTER	86-90	883cc 4T				18477N 18477NC		
	XLH SPORTSTER	91-92	883cc 4T				18477NC		
	XLH SPORTSTER	75-85	1000cc 4T				5780BN 5780CN		
	XLH SPORTSTER	79-84	1000cc 4T				15410BN		
	XLH SPORTSTER	81-85	1000cc 4T				18477N 18477NC		
	XLH SPORTSTER	82-84	1000cc 4T				15410BN		
	XLH SPORTSTER	86-87	1100cc 4T				18477N 18477NC		
	XLH SPORTSTER	87-90	1200cc 4T				18477N 18477NC		
	XLH SPORTSTER	91-92	1200cc 4T				18477NC		
	XLH SPORTSTER ANNIV.	78-78	1000cc 4T				5780BN 5780CN		
XLH SPORTSTER LIBERTY	86-86	1100cc 4T				18477N 18477NC			
XLH TOURING	77-77	1000cc 4T				5780BN 5780CN			
XLH1000	72-75	1000cc 4T					H1070 H1070C		
XLH1000	72-80	1000cc 4T				5780BN 5780CN			
XLH1000	72-81	1000cc 4T				15410BN			
XLH1000	81-85	1000cc 4T				18477N 18477NC			
XLH1000	84-85	1000cc 4T					H2384		
XLH1100	86-86	1100cc 4T					H2384		
XLH1100	86-87	1100cc 4T				18477N 18477NC	H2386 H2386C		
XLH1200	88-90	1200cc 4T				18477N 18477NC	H2386 H2386C		

IT	ALTERNATORE	BOBINA	CENTRALINA	MOTORINO AVVIAMENTO	REGOLATORE	STATORE
EN	ALTERNATOR	COIL	CDI	STARTER ENGINE	RECTIFIER	STATOR
FR	ALTERNATEUR	BOBINE	BOÎTIER ÉLECTRONIQUE	DÉMARREUR ÉLECTRIQUE	RÉGULATEUR	STATOR
						

HARLEY DAVIDSON	Model	Year	Engine	Part	Part Number	Part Number
HARLEY DAVIDSON	XLH1200	91-91	1200cc 4T			H2391 H2391C
	XLH1200	91-03	1200cc 4T		18477NC	
	XLH1200	92-93	1200cc 4T			H2392 H2392C
	XLH1200	94-03	1200cc 4T			H2394 H2394C
	XLH883	86-86	883cc 4T			H2384
	XLH883	86-90	883cc 4T			H2386 H2386C
	XLH883	86-95	883cc 4T		18477N 18477NC	
	XLH883	91-91	883cc 4T			H2391 H2391C
	XLH883	91-03	883cc 4T		18477NC	
	XLH883	92-93	883cc 4T			H2392 H2392C
	XLH883	94-03	883cc 4T			H2394 H2394C
	XLH883DLX SPORTSTER 883 DELUXE	86-86	883cc 4T			H2384
	XLH883DLX SPORTSTER 883 DELUXE	86-90	883cc 4T		18477N 18477NC	H2386 H2386C
	XLH883DLX SPORTSTER 883 DELUXE	91-91	883cc 4T			H2391 H2391C
	XLH883DLX SPORTSTER 883 DELUXE	91-95	883cc 4T		18477NC	
	XLH883DLX SPORTSTER 883 DELUXE	92-93	883cc 4T			H2392 H2392C
	XLH883DLX SPORTSTER 883 DELUXE	94-95	883cc 4T			H2394 H2394C
	XLH883HUG SPORTSTER 883 HUGGER	87-90	883cc 4T		18477N 18477NC	H2386 H2386C
	XLH883HUG SPORTSTER 883 HUGGER	91-91	883cc 4T			H2391 H2391C
	XLH883HUG SPORTSTER 883 HUGGER	91-03	883cc 4T		18477NC	
XLH883HUG SPORTSTER 883 HUGGER	92-93	883cc 4T			H2392 H2392C	
XLH883HUG SPORTSTER 883 HUGGER	94-03	883cc 4T			H2394 H2394C	
XLH900	58-70	900cc 4T			5780BN 5780CN	
XLH900	71-71	1200cc 4T			5780BN 5780CN	H1070 H1070C
XLHA SPORTSTER ANN.V.	82-82	1000cc 4T			15410BN	
XLHA SPORTSTER ANN.V.	82-82	1000cc 4T			15410BN	
XLHA SPORTSTER ANN.V.	82-82	1000cc 4T			5780BN 5780CN	
XLL SPORTSTER LOW	05-07	883cc 4T			18477NC	
XLL SPORTSTER LOW	06-07	1200cc 4T			18477NC	
XLN NIGHTSTER	07-07	1200cc 4T			18477NC	

IT	ALTERNATORE	BOBINA	CENTRALINA	MOTORINO AVVIAMENTO	REGOLATORE	STATORE
EN	ALTERNATOR	COIL	CDI	STARTER ENGINE	RECTIFIER	STATOR
FR	ALTERNATEUR	BOBINE	BOÎTIER ÉLECTRONIQUE	DÉMARREUR ÉLECTRIQUE	RÉGULATEUR	STATOR
						

HARLEY DAVIDSON	Model		Engine		Part	
	Model	Year	Capacity	Part	Part	Part
HARLEY DAVIDSON	XLR	59-60	900cc 4T		5780BN 5780CN	
	XLR SPORTSTER ROADSTER	02-07	883cc 4T		18477NC	
	XLR SPORTSTER ROADSTER	05-07	1200cc 4T		18477NC	
	XLR1200X	11-13	1200cc 4T			H1108 H1108C
	XLRTT	58-64	900cc 4T		5780BN 5780CN	
	XLS ROADSTER	79-84	1000cc 4T		15410BN	
	XLS ROADSTER	79-85	1000cc 4T		5780BN 5780CN	
	XLS ROADSTER	81-85	1000cc 4T		18477N 18477NC	
	XLS ROADSTER	82-84	1000cc 4T		15410BN	
	XLS ROADSTER	78-78	1200cc 4T		5780BN 5780CN	
	XLS SPORTSTER SPORT	00-03	1200cc 4T		18477NC	
	XLSA ROADSTER ANNIV.	82-82	1000cc 4T		15410BN	
	XLSA ROADSTER ANNIV.	82-82	1000cc 4T		5780BN 5780CN	
	XLSA ROADSTER ANNIV.	82-82	1000cc 4T		18477N 18477NC	
	XLT	77-78	1200cc 4T		5780BN 5780CN	
	XLX 1000	83-85	1000cc 4T		18477N 18477NC	
	XLX 1000	84-85	1000cc 4T			H2384
	XLX-61	83-84	1000cc 4T		15410BN	
	XLX-61	83-85	1000cc 4T		5780CN 18477NC	18477N 5780BN
	XR	69-75	750cc 4T		5780BN 5780CN	
XR1000	83-84	1000cc 4T		18477NC		
XR1000	83-85	1000cc 4T		15410BN		
XR1000	83-85	1000cc 4T		18477N 5780BN 5780CN		
XR1000	84-85	1000cc 4T			H2384	
XR1000	85-85	1000cc 4T		18477NC		
XR1200	09-10	1000cc 4T		18477NC	H1108 H1108C	
XR1200X	10-10	1200cc 4T			H1108 H1108C	
XR1200X	10-13	1200cc 4T		18477NC		
HONDA	@ [NES]	00-06	125cc 4T LC	Honda	37046N	
	@ [NES]	00-06	150cc 4T LC	Honda	37046N	

IT	ALTERNATORE	BOBINA	CENTRALINA	MOTORINO AVVIAMENTO	REGOLATORE	STATORE
EN	ALTERNATOR	COIL	CDI	STARTER ENGINE	RECTIFIER	STATOR
FR	ALTERNATEUR	BOBINE	BOÎTIER ÉLECTRONIQUE	DÉMARREUR ÉLECTRIQUE	RÉGULATEUR	STATOR
						

HONDA	Model	Year	Capacity	Notes	Part Number	Image
	CB NIGHTEAWK	91-08	250cc 4T		18611N	
	CBR RR	06-07	1000cc 4T			27-7017
	CBR250R	11-13	250cc 4T		16071N	
	CBR300R	15-16	300cc 4T		16071N	
	CMX250C REBEL	96-15	250cc 4T		18611N	
	CRF F	03-09	230cc 4T		18850N	
	CRF X	04-09	250cc 4T		18851N	
	CRF X	12-13	250cc 4T		18851N	
	CRF X	15-15	250cc 4T		18851N	
	CRF X	05-09	450cc 4T		18852N	
	CRF X	11-15	450cc 4T		18852N	
	DYLAN [SES]	02-04	125cc 4T LC	Honda	37046N	
	DYLAN [SES]	02-04	150cc 4T LC	Honda	37046N	
	GL1100 GOLD WING	80-83	1100cc 4T		18600N	
	GL1100A GOLD WING ASPENCADE	82-83	1100cc 4T		18600N	
	GL1100I GOLD WING INTERSTATE	80-83	1100cc 4T		18600N	
	NSA DN-01	09-09	700cc 4T		19643N	
	NT V DEAUVILLE	10-11	700cc 4T		19643N	
	NT VA DEAUVILLE ABS	10-11	700cc 4T		19643N	
	NX650	88-89	650cc 4T		18671N	
	PANTHEON IE [FES]	03-05	125cc 4T-2V LC	Honda	37046N	
	PANTHEON IE [FES]	03-05	150cc 4T-2V LC	Honda	37046N	
	PC800 PACIFIC COAST	89-98	800cc 4T		18656N	
	PS I [PES]	06-10	125cc 4T LC	Honda	37046N	
	PS I [PES]	06-10	150cc 4T LC	Honda	37046N	
	SA50 ELITE LX	88-90	50cc 2T AC		19595N	
	SA50 ELITE SR	88-93	50cc 2T AC		19595N	
	SH	00-08	100cc 4T		37044N	
	SH	01-04	125cc 4T-2V LC	Honda	37046N	
	SH	01-04	150cc 4T-2V LC	Honda	37046N	

IT	ALTERNATORE	BOBINA	CENTRALINA	MOTORINO AVVIAMENTO	REGOLATORE	STATORE
EN	ALTERNATOR	COIL	CDI	STARTER ENGINE	RECTIFIER	STATOR
FR	ALTERNATEUR	BOBINE	BOÎTIER ÉLECTRONIQUE	DÉMARREUR ÉLECTRIQUE	RÉGULATEUR	STATOR
						

HONDA	Model	Year	Engine	Part	Code
	SH	07-13	300cc 4T		16072N
	SH IE SCOOPIY	05-12	125cc 4T-2V LC	Honda	37046N
	SH IE SCOOPIY	05-12	150cc 4T LC	Honda	37046N
	SHADOW	10-13	50cc 4T		37044N
	SHADOW	10-13	90cc 4T		37044N
	SILVER WING ABS	03-13	600cc 4T		18859N
	SILVER WING [FES]	07-12	125cc 4T-2V LC	Honda	37046N
	SILVER WING [FES]	07-12	150cc 4T-2V LC	(KF06E)	37046N
	SILVER WING [FJS]	02-10	600cc 4T		18859N
	ST	91-03	1100cc 4T		18657N
	ST ABS	92-03	1100cc 4T		18657N
	VF700C MAGNA	84-86	700cc 4T		18660N
	VF700C MAGNA	87-87	700cc 4T		18660N
	VF700F INTERCEPTOR	84-85	700cc 4T		18661N
	VF700S SABRE	84-85	700cc 4T		18660N
	VF750C MAGNA	88-88	750cc 4T		18660N
	VF750C V45 MAGNA	82-83	750cc 4T		18660N
	VF750F V45 INTERCEPTOR	83-84	750cc 4T		18661N
	VF750S V45 SABRE	82-83	750cc 4T		18660N
	VT C SHADOW AERO	08-15	750cc 4T		19643N
	VT C2 SHADOW SPIRIT	07-15	750cc 4T		19643N
	VT C2 SHADOW SPIRIT ABS	13-14	750cc 4T		19643N
	VT C2B SHADOW PHAMTON	12-15	750cc 4T		19643N
	VT CA SHADOW AERO ABS	12-14	750cc 4T		19643N
	VT RS SHADOW	13-13	750cc 4T		19643N
	VT1100C SHADOW	95-96	1100cc 4T		18656N
	VT1100C SHADOW SPIRIT	97-07	1100cc 4T		18656N
	VT1100C2 SHADOW SABRE	04-07	1100cc 4T		18656N
	XR650L	93-09	650cc 4T		18671N
	XR650L	12-15	650cc 4T		18671N

IT	ALTERNATORE	BOBINA	CENTRALINA	MOTORINO AVVIAMENTO	REGOLATORE	STATORE
EN	ALTERNATOR	COIL	CDI	STARTER ENGINE	RECTIFIER	STATOR
FR	ALTERNATEUR	BOBINE	BOÎTIER ÉLECTRONIQUE	DÉMARREUR ÉLECTRIQUE	RÉGULATEUR	STATOR
						

HUSQVARNA	HUV-4421-DXP	06-10	720cc 4T					19162N	
	KAWASAKI								
	EN450A 454 LTD	85-90	450cc 4T					18704N	
	EX500	87-93	500cc 4T					18704N	
	EX500 NINJA 500	94-96	500cc 4T					18704N	
	EX500 NINJA 500R	97-09	500cc 4T					18704N	
	KFX400	03-06	400cc 4T					18718N	
	KL250 SUPER SHERPA	00-10	250cc 4T					18715N	
	KL650B TENGAI	90-91	650cc 4T					18690N	
	KLF220 BAYOU	88-02	220cc 4T					18716N	
	KLF250 BAYOU	03-11	250cc 4T					18716N	
	KLF400 BAYOU 4X4	93-99	400cc 4T					18702N	
	KLR650	87-10	650cc 4T					18690N	
	KLR650	11-15	650cc 4T					18690N	
	KLX250S	06-07	250cc 4T					18715N	
	KLX400R	03-03	400cc 4T					18718N	
	KLX400SR	03-03	400cc 4T					18718N	
	KVF400 PRAIRIE 2X4	98-99	400cc 4T					18702N	
	KVF400 PRAIRIE 2X4	00-02	400cc 4T					18702N	
	KVF400 PRAIRIE 4X4	97-02	400cc 4T					18702N	
	NINJA ZX-6R	03-06	636cc 4T					18833N	
	NINJA ZX-6RR	03-06	600cc 4T					18833N	
	VN A VULCAN	04-09	2000cc 4T					18837N	
	VN CLASSIC	06-10	900cc 4T			CPS28			
	VN CLASSIC	06-10	900cc 4T			CPS28			
	VN CLASSIC	11-12	900cc 4T			CPS28			
	VN CLASSIC	13-14	900cc 4T			CPS28			
	VN CLASSIC	09-09	1700cc 4T			CPS28			
	VN CUSTOM	07-11	900cc 4T			CPS28			
	VN D VULCAN	05-06	2000cc 4T					18837N	
	VN E VULCAN	06-09	2000cc 4T					18837N	

IT	ALTERNATORE	BOBINA	CENTRALINA	MOTORINO AVVIAMENTO	REGOLATORE	STATORE
EN	ALTERNATOR	COIL	CDI	STARTER ENGINE	RECTIFIER	STATOR
FR	ALTERNATEUR	BOBINE	BOÎTIER ÉLECTRONIQUE	DÉMARREUR ÉLECTRIQUE	RÉGULATEUR	STATOR
						

KAWASAKI	VN F VULCAN	06-10	2000cc 4T				18837N	
	VN VULCAN CLASSIC	15-16	900cc 4T		CPS28			
	VN VULCAN CUSTOM	12-15	900cc 4T		CPS28			
	VN VULCAN CUSTOM	16-16	900cc 4T		CPS28			
	VN1500A VULCAN 1500	96-99	1500cc 4T				18692N	
	VN1500A VULCAN 88	87-95	1500cc 4T				18692N	
	VN1500B VULCAN 88 SE	87-90	1500cc 4T				18692N	
	VN1500C VULCAN L	96-97	1500cc 4T				18692N	
	VN1500E VULCAN 1500 CLASSIC	96-08	1500cc 4T				18692N	
	VN1500G VULCAN 1500 NOMAD	99-01	1500cc 4T				18692N	
	VN1500J/R VULCAN 1500 DRIFTER	99-05	1500cc 4T				18692N	
	VN1500L VULCAN NOMAD FI	00-04	1500cc 4T				18692N	
	VN1500N VULCAN 1500 CLASSIC FI	00-02	1500cc 4T				18692N	
	VN1500P VULCAN 1500 MEAN STREAK	02-03	1500cc 4T				18692N	
	VN1600A VULCAN 1600 CLASSIC	03-08	1600cc 4T				18692N	
	VN1600B VULCAN 1600 MEAN STREAK	04-08	1600cc 4T				18692N	
	VN1600D VULCAN 1600 NOMAD	05-08	1600cc 4T				18692N	
	ZG1200 VOYAGER XII	86-86	1200cc 4T		12481N			
	ZG1200 VOYAGER XII	87-91	1200cc 4T		12481N			
	ZG1200 VOYAGER XII	92-03	1200cc 4T		12481N			
ZR ZEPHIR A1-A4	92-95	1100cc 4T		12481N				
ZX-10R NINJA	04-06	1000cc 4T				18836N		
ZX-9R	98-03	900cc 4T				18788N		
KTM	ADVENTURE	98-08	640cc 4T				19633N	
	COMP LIMITED	97-97	620cc 4T				19633N	
	DUKE	96-97	620cc 4T				19633N	
	DUKE	98-98	640cc 4T				19633N	
	DUKE II	99-06	640cc 4T				19633N	
	EGS	94-97	620cc 4T				19633N	
	EGS-E	97-97	620cc 4T				19633N	

IT	ALTERNATORE	BOBINA	CENTRALINA	MOTORINO AVVIAMENTO	REGOLATORE	STATORE
EN	ALTERNATOR	COIL	CDI	STARTER ENGINE	RECTIFIER	STATOR
FR	ALTERNATEUR	BOBINE	BOÎTIER ÉLECTRONIQUE	DÉMARREUR ÉLECTRIQUE	RÉGULATEUR	STATOR
						

KTM									
	Model	Year	Capacity	Part No.	Part No.	Part No.	Part No.	Part No.	Part No.
	ENDURO	99-02	640cc 4T				19633N		
	EXC	00-06	400cc 4T				19620N		
	EXC	03-05	450cc 4T				19620N		
	EXC	12-14	500cc 4T				11835N		
	EXC	00-02	520cc 4T				19620N		
	EXC	03-06	525cc 4T				19620N		
	EXC	94-97	620cc 4T				19633N		
	EXC R	08-11	450cc 4T				19620N		
	EXC SIX DAYS	12-12	500cc 4T				11835N		
	EXC-F	12-14	350cc 4T				11834N		
	EXC-G	06-07	525cc 4T				19620N		
	FREERIDE	12-12	350cc 4T				11834N		
	LC4	98-01	400cc 4T				19633N		
	LC4 EXC	94-97	620cc 4T				19633N		
	LC4 SX	97-98	620cc 4T				19633N		
	LSE	97-98	400cc 4T				19633N		
	MXC	01-02	400cc 4T				19620N		
	MXC	03-05	450cc 4T				19620N		
	MXC	00-02	520cc 4T				19620N		
	MXC	03-05	525cc 4T				19620N		
	RALLY	00-06	660cc 4T				19633N		
	RXC	96-98	400cc 4T				19633N		
	RXC	95-98	620cc 4T				19633N		
	SC	94-01	620cc 4T				19633N		
	SMC	04-06	625cc 4T				19633N		
	SMC	02-06	660cc 4T				19633N		
	SMR	05-06	450cc 4T				19620N		
	SMR	04-06	525cc 4T				19620N		
	SMS	04-04	450cc 4T				19620N		
	SMS	04-04	660cc 4T				19633N		

IT	ALTERNATORE	BOBINA	CENTRALINA	MOTORINO AVVIAMENTO	REGOLATORE	STATORE
EN	ALTERNATOR	COIL	CDI	STARTER ENGINE	RECTIFIER	STATOR
FR	ALTERNATEUR	BOBINE	BOÎTIER ÉLECTRONIQUE	DÉMARREUR ÉLECTRIQUE	RÉGULATEUR	STATOR
						

KTM									
	Model	Year	Capacity	Part No.	Part No.	Part No.	Part No.	Part No.	Part No.
	SUPER MOTO	98-01	620cc 4T				19633N		
	SUPERMOTO	99-05	640cc 4T				19633N		
	SX	00-02	400cc 4T				19620N		
	SX	00-02	520cc 4T				19620N		
	SX	03-06	525cc 4T				19620N		
	SX	96-99	620cc 4T				19633N		
	SX-F	12-14	250cc 4T				11834N		
	SX-F	11-14	350cc 4T				11834N		
	SX-F	03-06	450cc 4T				19620N		
	SX-F	13-13	450cc 4T				11835N		
	SX-F	14-14	450cc 4T				11834N		
	SX-F FACTORY EDITION	13-13	450cc 4T				11835N		
	SXC	00-06	540cc 4T				19620N		
	SXC	97-97	620cc 4T				19633N		
	SXC	03-04	625cc 4T				19633N		
	SXS	03-06	450cc 4T				19620N		
	TXC	98-98	400cc 4T				19633N		
	TXC	98-98	620cc 4T				19633N		
	XC	09-14	250cc 4T				19091N		
	XC	08-14	300cc 4T				19091N		
	XC	08-10	450cc 4T				19620N		
	XC	08-10	525cc 4T				19620N		
	XC-F	12-14	350cc 4T				11834N		
	XC-F	06-06	450cc 4T				19620N		
	XC-F	13-14	450cc 4T				11835N		
	XC-G	06-07	525cc 4T				19620N		
	XC-W	08-14	250cc 4T				19091N		
	XC-W	08-14	300cc 4T				19091N		
	XC-W	07-10	400cc 4T				19620N		
	XC-W	06-11	450cc 4T				19620N		

IT	ALTERNATORE	BOBINA	CENTRALINA	MOTORINO AVVIAMENTO	REGOLATORE	STATORE
EN	ALTERNATOR	COIL	CDI	STARTER ENGINE	RECTIFIER	STATOR
FR	ALTERNATEUR	BOBINE	BOÎTIER ÉLECTRONIQUE	DÉMARREUR ÉLECTRIQUE	RÉGULATEUR	STATOR
						

KTM	XC-W	12-14	450cc 4T			11835N	
	XC-W	12-14	500cc 4T			11835N	
	XC-W	07-07	525cc 4T			19620N	
KYMCO	XCF-W	12-14	350cc 4T			11834N	
	B&W	02-02	50cc 2T LC	Motore Kymco		19597N	
	B&W	02-02	50cc 2T LC	Motore Kymco		37010N	
	B&W	00-00	250cc 4T LC			37009N	
	B&W EU2	03-03	50cc 2T LC	Motore Kymco		19597N	
	B&W EU2	03-03	50cc 2T LC	Motore Kymco		37010N	
	B&W EU2	03-03	250cc 4T LC			37009N	
	CX	93-93	50cc 2T AC	Motore Kymco		19595N	
	CX SUPER	94-97	50cc 2T AC	Motore Kymco		19595N	
	DINK LC	98-02	50cc 2T LC	Motore Kymco		19597N	
	DINK LC	98-02	50cc 2T LC	Motore Kymco		37010N	
	DINK CLASSIC EU2	03-03	50cc 2T AC	Motore Kymco		19597N	
	DINK CLASSIC EU2	03-03	50cc 2T AC	Motore Kymco		37010N	
	DINK EU3	06-07	125cc 4T LC			37045N	
	DINK EU3	06-07	125cc 4T LC				KW1009N
	DINK IE EU3	06-07	200cc 4T LC				KW1009N
	DJ WORLD	94-00	50cc 2T AC	Motore Kymco		19595N	
	DJ X	91-92	50cc 2T AC	Motore Kymco		19595N	
	DJ Y	93-93	50cc 2T AC	Motore Kymco		19595N	
	DOWNTOWN ABS	10-10	300cc 4T LC				KW1009N
	DOWNTOWN I	09-16	125cc 4T LC				KW1009N
	DOWNTOWN I	10-10	200cc 4T LC				KW1009N
	DOWNTOWN I	09-09	300cc 4T LC				KW1009N
	DOWNTOWN I	11-11	300cc 4T LC				KW1009N
	DOWNTOWN I ABS	11-16	300cc 4T LC				KW1009N
	G-DINK	12-12	125cc 4T LC			37045N	
G-DINK	12-12	300cc 4T-2V LC			37009N		

IT	ALTERNATORE	BOBINA	CENTRALINA	MOTORINO AVVIAMENTO	REGOLATORE	STATORE
EN	ALTERNATOR	COIL	CDI	STARTER ENGINE	RECTIFIER	STATOR
FR	ALTERNATEUR	BOBINE	BOÎTIER ÉLECTRONIQUE	DÉMARREUR ÉLECTRIQUE	RÉGULATEUR	STATOR
						

KYMC0	Model	Year	Engine	Motor	Part No.	Part No.	Part No.	Part No.	Part No.
	G-DINK I ABS E4	17-17	300cc 4T-2V LC				37009N		
	GRAND DINK	01-02	125cc 4T LC				37045N		
	GRAND DINK	01-02	150cc 4T LC				37045N		
	GRAND DINK	01-02	250cc 4T LC				37009N		
	GRAND DINK EU2	03-04	125cc 4T LC				37045N		
	GRAND DINK EU2	03-04	150cc 4T LC				37045N		
	GRAND DINK EU2	03-04	250cc 4T LC				37009N		
	HEROISM	95-97	50cc 2T AC	Motore Kymco			19597N		
	HEROISM	95-97	50cc 2T AC	Motore Kymco			37010N		
	K 12	95-00	50cc 2T AC	Motore Kymco			19595N		
	KB	95-00	50cc 2T AC	Motore Kymco			19595N		
	KXR	04-04	50cc 2T AC				19597N		
	KXR	04-04	50cc 2T AC				37010N		
	MAXXER	05-05	50cc 2T AC				19597N		
	MAXXER	05-05	50cc 2T AC				37010N		
	MXER	02-03	50cc 2T AC				19597N		
	MXER	02-03	50cc 2T AC				37010N		
	MXER EU2	04-04	50cc 2T AC				19597N		
	MXER EU2	04-04	50cc 2T AC				37010N		
	MXU	06-07	50cc 2T AC				19597N		
	MXU	06-07	50cc 2T AC				37010N		
	MXU	05-06	500cc 4T				19228N		
	MXU IRS	10-10	500cc 4T				19228N		
	MXU SR	06-06	50cc 2T AC				19597N		
	MXU SR	06-06	50cc 2T AC				37010N		
	PEOPLE	99-03	50cc 2T AC	Motore Kymco			19597N		
	PEOPLE	99-03	50cc 2T AC	Motore Kymco			37010N		
	PEOPLE	04-04	50cc 2T AC	Motore Kymco			19597N		
	PEOPLE	04-04	50cc 2T AC	Motore Kymco			37010N		
	PEOPLE EURO 2	03-03	50cc 2T AC	Motore Kymco			19597N		

IT	ALTERNATORE	BOBINA	CENTRALINA	MOTORINO AVVIAMENTO	REGOLATORE	STATORE
EN	ALTERNATOR	COIL	CDI	STARTER ENGINE	RECTIFIER	STATOR
FR	ALTERNATEUR	BOBINE	BOÎTIER ÉLECTRONIQUE	DÉMARREUR ÉLECTRIQUE	RÉGULATEUR	STATOR
						

KYMCO					IT	EN	FR
	PEOPLE EURO 2	03-03	50cc 2T AC	Motore Kymco			
PEOPLE EURO 2	08-08	50cc 2T AC	Motore Kymco				
PEOPLE EURO 2	08-08	50cc 2T AC	Motore Kymco				
PEOPLE EURO 2	11-11	50cc 2T AC	Motore Kymco				
PEOPLE EURO 2	11-11	50cc 2T AC	Motore Kymco				
PEOPLE GTI	10-10	125cc 4T LC					
PEOPLE GTI	14-14	125cc 4T LC					
PEOPLE GTI	10-10	200cc 4T LC					
PEOPLE GTI	14-14	200cc 4T LC					
PEOPLE GTI	10-10	300cc 4T LC					
PEOPLE GTI	11-11	300cc 4T LC					
PEOPLE GTI	14-14	300cc 4T LC					
PEOPLE GTI ABS	12-12	300cc 4T LC					
PEOPLE GTI ABS	14-14	300cc 4T LC					
PEOPLE GTI ABS E4	16-16	300cc 4T LC					
PEOPLE LC	03-04	250cc 4T LC					
PEOPLE S	05-08	50cc 2T AC	Motore Kymco				
PEOPLE S	05-08	50cc 2T AC	Motore Kymco				
PEOPLE S	06-06	250cc 4T LC					
PEOPLE S I	07-07	250cc 4T LC					
PEOPLE S I	07-07	250cc 4T LC					
PEOPLE S I	08-08	300cc 4T LC	(BB60)				
PEOPLE S I	08-08	300cc 4T LC	(BB60)				
SNIPER	93-93	50cc 2T AC	Motore Kymco				
SNIPER	93-93	50cc 2T AC	Motore Kymco				
SNIPER DD	94-96	50cc 2T AC	Motore Kymco				
SNIPER DD	94-96	50cc 2T AC	Motore Kymco				
SUPER 9	00-00	50cc 2T LC	Motore Kymco				
SUPER 9	00-00	50cc 2T LC	Motore Kymco				
SUPER 9 EU2	03-03	50cc 2T LC	Motore Kymco				

IT	ALTERNATORE	BOBINA	CENTRALINA	MOTORINO AVVIAMENTO	REGOLATORE	STATORE
EN	ALTERNATOR	COIL	CDI	STARTER ENGINE	RECTIFIER	STATOR
FR	ALTERNATEUR	BOBINE	BOÎTIER ÉLECTRONIQUE	DÉMARREUR ÉLECTRIQUE	RÉGULATEUR	STATOR
						

KYMC0	Model	Year	Engine	Motor	Part Number	Accessories
	SUPER 9 EU2	03-03	50cc 2T LC	Motore Kymco	37010N	
	SUPER 9 EU2	04-04	50cc 2T LC	Motore Kymco	19597N	
	SUPER 9 EU2	04-04	50cc 2T LC	Motore Kymco	37010N	
	TOP BOY	97-00	50cc 2T AC	Motore Kymco	19597N	
	TOP BOY	97-00	50cc 2T AC	Motore Kymco	37010N	
	UXV	08-08	500cc 4T		19228N	
	UXV I	10-10	500cc 4T		19228N	
	VENOX	02-03	250cc 4T LC			KW1009N
	VENOX EURO2	04-04	250cc 4T LC			KW1009N
	VENOX EURO3	07-07	250cc 4T LC			KW1009N
	VITALITY 2T	04-04	50cc 2T AC	Motore Kymco	19597N	
	VITALITY 2T	04-04	50cc 2T AC	Motore Kymco	37010N	
	X CITING	05-05	500cc 4T		19228N	
	X CITING	05-05	500cc 4T LC			KW1009N
	X CITING I	06-07	250cc 4T LC		37009N	
	X CITING I	06-07	250cc 4T LC			KW1009N
	X CITING I	08-08	300cc 4T LC		37009N	
	X CITING I	08-08	300cc 4T LC			KW1009N
	X CITING I	06-07	500cc 4T		19228N	
	X CITING I	08-08	500cc 4T		19228N	
	X CITING I R	08-08	300cc 4T LC		37009N	
	X CITING I R	08-08	300cc 4T LC			KW1009N
	X CITING I R	09-09	300cc 4T LC		37009N	
	X CITING I R	09-09	300cc 4T LC			KW1009N
	X CITING I R	07-08	500cc 4T		19228N	
	X CITING R	09-09	500cc 4T		19228N	
	YUP	02-02	50cc 2T AC	Motore Kymco	19597N	
	YUP	02-02	50cc 2T AC	Motore Kymco	37010N	
	YUP	03-03	250cc 4T LC	(SH50D)	37009N	
	YUP EU2	03-03	50cc 2T AC	Motore Kymco	19597N	

IT	ALTERNATORE	BOBINA	CENTRALINA	MOTORINO AVVIAMENTO	REGOLATORE	STATORE
EN	ALTERNATOR	COIL	CDI	STARTER ENGINE	RECTIFIER	STATOR
FR	ALTERNATEUR	BOBINE	BOÎTIER ÉLECTRONIQUE	DÉMARREUR ÉLECTRIQUE	RÉGULATEUR	STATOR
						

KYMCO	YUP EU2	03-03	50cc 2T AC	Motore Kymco				37010N	
	PEUGEOT	ELISTAR	03-05	50cc 2T				16091N	
	JET FORCE	03-06	50cc 2T				16091N		
	LOOXOR TDSI	02-06	50cc 2T				16091N		
PIAGGIO	APE	09-11	50cc 2T AC				37034N		
	APE	12-17	50cc 2T AC				37034N		
	APE EU4	18-18	50cc 2T LC				37034N		
	APE FL - FL2	89-95	50cc 2T AC				37034N		
	APE FL3 EUROPA	96-99	50cc 2T AC				37034N		
	APE MIX 2T	98-08	50cc 2T AC				37034N		
	APE RST MIX	99-03	50cc 2T AC				37034N		
	APE TM P	85-89	50cc 2T AC				37034N		
	BEVERLY	01-03	125cc 4T LC				19588N		
	BEVERLY	01-03	125cc 4T LC				37033N		
	BEVERLY	02-04	500cc 4T LC				16073N		
	BEVERLY	05-06	500cc 4T LC	Piaggio			16073N		
	BEVERLY EU3	06-07	400cc 4T LC	Piaggio M345M			16073N		
	BEVERLY CRUISER	07-12	500cc 4T LC	Piaggio Master			16073N		
	BEVERLY EU3	07-08	125cc 4T LC				19588N		
	BEVERLY EU3	07-08	125cc 4T LC				37033N		
	BEVERLY EURO 3 MIC	07-07	125cc 4T LC				19588N		
	BEVERLY EURO 3 MIC	07-07	125cc 4T LC				37033N		
	BEVERLY EURO 3 SPORT	07-08	125cc 4T LC				19588N		
	BEVERLY EURO 3 SPORT	07-08	125cc 4T LC				37033N		
	BEVERLY IE EU3	06-08	500cc 4T LC	Piaggio M343M			16073N		
	BEVERLY RST	04-05	125cc 4T LC				19588N		
	BEVERLY RST	04-05	125cc 4T LC	M28400			37033N		
	BEVERLY RST	05-07	125cc 4T LC				19588N		
	BEVERLY RST	05-07	125cc 4T LC				37033N		
	BEVERLY TOURER EU3	07-10	125cc 4T LC				19588N		

IT	ALTERNATORE	BOBINA	CENTRALINA	MOTORINO AVVIAMENTO	REGOLATORE	STATORE
EN	ALTERNATOR	COIL	CDI	STARTER ENGINE	RECTIFIER	STATOR
FR	ALTERNATEUR	BOBINE	BOÎTIER ÉLECTRONIQUE	DÉMARREUR ÉLECTRIQUE	RÉGULATEUR	STATOR
						

PIAGGIO	Model	Year	Engine	Accessories	Part Number	Part Number	Part Number	Part Number	Part Number
	BEVERLY TOURER EU3	07-10	125cc 4T LC					37033N	
	BEVERLY TOURER EU3	08-10	400cc 4T LC	Piaggio M349M				16073N	
	CARNABY	07-10	125cc 4T LC					19588N	
	CARNABY	07-10	125cc 4T LC	Leader M28FM				37033N	
	CARNABY	07-08	200cc 4T LC					19588N	
	CARNABY	07-08	200cc 4T LC	Leader M601M				37033N	
	FLY	06-07	100cc 4T AC					16088N	
	FLY	08-14	100cc 4T AC					16088N	
	FLY	05-07	125cc 4T AC					19588N	
	FLY	05-07	125cc 4T AC	Leader M422M				37033N	
	FLY	05-07	150cc 4T AC					19588N	
	FLY	05-07	150cc 4T AC	Leader M422M				37033N	
	FLY EU3	07-07	125cc 4T AC					19588N	
	FLY EU3	07-07	125cc 4T AC					37033N	
	FLY EU3	08-11	125cc 4T AC					19588N	
	FLY EU3	08-11	125cc 4T AC					37033N	
	FLY EU3	08-11	150cc 4T AC					19588N	
	FLY EU3	08-11	150cc 4T AC					37033N	
	FREE	02-03	100cc 4T AC					16088N	
	HEXAGON GTX	00-00	125cc 4T LC					19588N	
	HEXAGON GTX	00-00	125cc 4T LC					37033N	
	HEXAGON GTX	00-00	180cc 4T LC					19588N	
	HEXAGON GTX	00-00	180cc 4T LC					37033N	
	HEXAGON LXT180	98-99	180cc 2T LC					16088N	
	LIBERTY	01-02	125cc 4T AC					19588N	
	LIBERTY	01-02	125cc 4T AC	Leader				37033N	
	LIBERTY	06-06	200cc 4T AC					19588N	
	LIBERTY	06-06	200cc 4T AC					37033N	
	LIBERTY 4T	06-07	125cc 4T AC					19588N	
	LIBERTY 4T	06-07	125cc 4T AC					37033N	

IT	ALTERNATORE	BOBINA	CENTRALINA	MOTORINO AVVIAMENTO	REGOLATORE	STATORE
EN	ALTERNATOR	COIL	CDI	STARTER ENGINE	RECTIFIER	STATOR
FR	ALTERNATEUR	BOBINE	BOÎTIER ÉLECTRONIQUE	DÉMARREUR ÉLECTRIQUE	RÉGULATEUR	STATOR
						

PIAGGIO	Model	Year	Engine	Accessories	Part Number	Part Number	Part Number	Part Number	Part Number
	LIBERTY 4T 2V EURO3	09-12	125cc 4T AC					19588N	
	LIBERTY 4T 2V EURO3	09-12	125cc 4T AC					37033N	
	LIBERTY 4T EU3	06-08	125cc 4T AC					19588N	
	LIBERTY 4T EU3	06-08	125cc 4T AC					37033N	
	LIBERTY 4T EU3	08-08	150cc 4T AC					19588N	
	LIBERTY 4T EU3	08-08	150cc 4T AC					37033N	
	LIBERTY 4T EU3	06-08	200cc 4T AC					19588N	
	LIBERTY 4T EU3	06-08	200cc 4T AC					37033N	
	LIBERTY 4T EU3 DELIVERY - TNT	08-15	125cc 4T AC					19588N	
	LIBERTY 4T EU3 DELIVERY - TNT	08-15	125cc 4T AC					37033N	
	LIBERTY 4T SPORT EU3	06-08	125cc 4T AC					19588N	
	LIBERTY 4T SPORT EU3	06-08	125cc 4T AC					37033N	
	LIBERTY 4T SPORT EU3	08-08	150cc 4T AC					19588N	
	LIBERTY 4T SPORT EU3	08-08	150cc 4T AC					37033N	
	LIBERTY 4T SPORT EU3	06-07	200cc 4T AC					19588N	
	LIBERTY 4T SPORT EU3	06-07	200cc 4T AC	Leader				37033N	
	LIBERTY MOC 4T	09-13	150cc 4T AC					19588N	
	LIBERTY MOC 4T	09-13	150cc 4T AC					37033N	
	LIBERTY RST	04-05	125cc 4T AC					19588N	
	LIBERTY RST	04-05	125cc 4T AC					37033N	
	LIBERTY RST	04-04	200cc 4T AC					19588N	
	LIBERTY RST	04-04	200cc 4T AC					37033N	
	LIBERTY SPORT	06-06	125cc 4T AC					19588N	
	LIBERTY SPORT	06-06	125cc 4T AC					37033N	
	LIBERTY SPORT	06-06	200cc 4T AC					19588N	
	LIBERTY SPORT	06-06	200cc 4T AC					37033N	
	MP3	06-08	125cc 4T LC					19588N	
	MP3	06-08	125cc 4T LC	Piaggio M631M				37033N	
	MP3	07-08	400cc 4T LC	Piaggio M474M				16073N	
	MP3 IE LT TOURING	11-11	400cc 4T LC					16073N	

IT	ALTERNATORE	BOBINA	CENTRALINA	MOTORINO AVVIAMENTO	REGOLATORE	STATORE
EN	ALTERNATOR	COIL	CDI	STARTER ENGINE	RECTIFIER	STATOR
FR	ALTERNATEUR	BOBINE	BOÎTIER ÉLECTRONIQUE	DÉMARREUR ÉLECTRIQUE	RÉGULATEUR	STATOR
						

PIAGGIO	Model	Year	Engine	Notes	Part No.		
	MP3 IE LT/SPORT	08-10	400cc 4T LC		16073N		
	MP3 LT BUSINESS ABS	14-16	500cc 4T LC		16073N		
	MP3 LT E4 SPORT/BUSINESS	16-17	500cc 4T LC		16073N		
	MP3 LT SPORT/BUSINESS	11-13	500cc 4T LC		16073N		
	MP3 MIC	08-10	400cc 4T LC		16073N		
	MP3 RL SPORT-BUSINESS	11-12	500cc 4T LC		16073N		
	MP3 RL TOURING	11-11	400cc 4T LC		16073N		
	MP3 SPORT ABS	14-16	500cc 4T LC		16073N		
	SKYPPER 4T	00-02	125cc 4T AC		19588N		
	SKYPPER 4T	00-02	125cc 4T AC		37033N		
	SKYPPER 4T	00-02	150cc 4T AC		19588N		
	SKYPPER 4T	00-02	150cc 4T AC		37033N		
	SUPER HEXAGON GTX 12	01-02	125cc 4T LC		19588N		
	SUPER HEXAGON GTX 12	01-02	125cc 4T LC		37033N		
	SUPER HEXAGON GTX 12	01-02	180cc 4T LC		19588N		
	SUPER HEXAGON GTX 12	01-02	180cc 4T LC		37033N		
	TYPHOON 4T 2V E3	10-11	125cc 4T AC		19588N		
	TYPHOON 4T 2V E3	10-11	125cc 4T AC		37033N		
	VESPA ET4	99-02	125cc 4T AC		19588N		
	VESPA ET4	99-02	125cc 4T AC	Leader	37033N		
	VESPA ET4	99-02	150cc 4T AC		19588N		
	VESPA ET4	99-02	150cc 4T AC	Leader	37033N		
	VESPA FL	90-90	50cc 2T AC		37034N		
	VESPA FL	89-90	125cc 2T AC		37034N		
	VESPA FL2 AUTOMATICA	90-91	50cc 2T AC		37034N		
	VESPA FL2 HP	91-97	50cc 2T AC		37034N		
	VESPA GRANTURISMO	03-05	125cc 4T LC		19588N		
	VESPA GRANTURISMO	03-05	125cc 4T LC	Piaggio M311M	37033N		
	VESPA GRANTURISMO	06-07	125cc 4T LC		19588N		
	VESPA GRANTURISMO	06-07	125cc 4T LC		37033N		

IT	ALTERNATORE	BOBINA	CENTRALINA	MOTORINO AVVIAMENTO	REGOLATORE	STATORE
EN	ALTERNATOR	COIL	CDI	STARTER ENGINE	RECTIFIER	STATOR
FR	ALTERNATEUR	BOBINE	BOÎTIER ÉLECTRONIQUE	DÉMARREUR ÉLECTRIQUE	RÉGULATEUR	STATOR
						

PIAGGIO	Model	Year	Engine	Accessories	Part Number	Part Number	Part Number	Part Number	Part Number
	VESPA GRANTURISMO	03-05	200cc 4T LC					19588N	
	VESPA GRANTURISMO	03-05	200cc 4T LC					37033N	
	VESPA GRANTURISMO	06-07	200cc 4T LC					19588N	
	VESPA GRANTURISMO	06-07	200cc 4T LC					37033N	
	VESPA GRANTURISMO EU3	06-07	125cc 4T LC					19588N	
	VESPA GRANTURISMO EU3	06-07	125cc 4T LC	Piaggio M314M				37033N	
	VESPA GTS EU3	07-12	125cc 4T LC					19588N	
	VESPA GTS EU3	07-12	125cc 4T LC	Piaggio M315M				37033N	
	VESPA GTV	06-08	125cc 4T LC					19588N	
	VESPA GTV	06-08	125cc 4T LC					37033N	
	VESPA GTV 4T NAVY EU3	08-08	125cc 4T LC					19588N	
	VESPA GTV 4T NAVY EU3	08-08	125cc 4T LC					37033N	
	VESPA LX	05-06	125cc 4T AC					19588N	
	VESPA LX	05-06	125cc 4T AC					37033N	
	VESPA LX	05-06	150cc 4T AC					19588N	
	VESPA LX	05-06	150cc 4T AC					37033N	
	VESPA LX 4T EU3 TOURING	10-11	125cc 4T AC					19588N	
	VESPA LX 4T EU3 TOURING	10-11	125cc 4T AC					37033N	
	VESPA LX 4T FL	09-09	125cc 4T AC					19588N	
	VESPA LX 4T FL	09-09	125cc 4T AC					37033N	
	VESPA LX 4T FL	09-09	150cc 4T AC					19588N	
	VESPA LX 4T FL	09-09	150cc 4T AC					37033N	
	VESPA LX EU3	06-08	125cc 4T AC					19588N	
	VESPA LX EU3	06-08	125cc 4T AC					37033N	
	VESPA LX EU3	06-08	150cc 4T AC					19588N	
	VESPA LX EU3	06-08	150cc 4T AC					37033N	
	VESPA LX EU3 IE	09-11	125cc 4T AC					19588N	
	VESPA LX EU3 IE	09-11	125cc 4T AC					37033N	
	VESPA LX EU3 IE	09-11	150cc 4T AC					19588N	
	VESPA LX EU3 IE	09-11	150cc 4T AC					37033N	

IT	ALTERNATORE	BOBINA	CENTRALINA	MOTORINO AVVIAMENTO	REGOLATORE	STATORE
EN	ALTERNATOR	COIL	CDI	STARTER ENGINE	RECTIFIER	STATOR
FR	ALTERNATEUR	BOBINE	BOÎTIER ÉLECTRONIQUE	DÉMARREUR ÉLECTRIQUE	RÉGULATEUR	STATOR
						

PIAGGIO	Model	Year	Engine	Part	Code	Part	Code
	VESPA LX TOURING	10-12	150cc 4T AC		19588N		
	VESPA LX TOURING	10-12	150cc 4T AC		37033N		
	VESPA LXV 4T EU3	06-09	125cc 4T LC		19588N		
	VESPA LXV 4T EU3	06-09	125cc 4T LC		37033N		
	VESPA LXV IE 4T	10-13	125cc 4T LC		19588N		
	VESPA LXV IE 4T	10-13	125cc 4T LC		37033N		
	VESPA LXV NAVY EU3	07-08	125cc 4T LC		19588N		
	VESPA LXV NAVY EU3	07-08	125cc 4T LC		37033N		
	VESPA N	89-90	50cc 2T AC		37034N		
	VESPA PK	82-84	50cc 2T AC		37034N		
	VESPA PK AUTOMATICA	84-89	50cc 2T AC		37034N		
	VESPA PK XL	85-88	50cc 2T AC		37034N		
	VESPA PK XL PLURIMATIC	85-90	50cc 2T AC		37034N		
	VESPA PK XL RUSH	88-89	50cc 2T AC		37034N		
	VESPA S 4T	08-09	150cc 4T AC		19588N		
	VESPA S 4T	08-09	150cc 4T AC	Piaggio M445M	37033N		
	VESPA S 4T EU3	07-08	125cc 4T AC		19588N		
	VESPA S 4T EU3	07-08	125cc 4T AC	Piaggio M444M	37033N		
	VESPA S 4T IE & COLLEGE	09-11	125cc 4T AC		19588N		
	VESPA S 4T IE & COLLEGE	09-11	125cc 4T AC		37033N		
	VESPA S 4T IE & COLLEGE	09-12	150cc 4T AC		19588N		
	VESPA S 4T IE & COLLEGE	09-12	150cc 4T AC		37033N		
	X-EVO	07-16	125cc 4T LC		19588N		
	X-EVO	07-16	125cc 4T LC		37033N		
	X-EVO	07-11	400cc 4T LC	Piaggio M521M	16073N		
	X10 4T-4V IE EU3	12-14	500cc 4T LC		16073N		
	X7 EU3	08-08	125cc 4T LC		19588N		
	X7 EU3	08-08	125cc 4T LC	Leader	37033N		
	X8	04-04	125cc 4T LC		19588N		
	X8	04-04	125cc 4T LC	Leader	37033N		

IT	ALTERNATORE	BOBINA	CENTRALINA	MOTORINO AVVIAMENTO	REGOLATORE	STATORE
EN	ALTERNATOR	COIL	CDI	STARTER ENGINE	RECTIFIER	STATOR
FR	ALTERNATEUR	BOBINE	BOÎTIER ÉLECTRONIQUE	DÉMARREUR ÉLECTRIQUE	RÉGULATEUR	STATOR
						

PIAGGIO	Model	Year	Engine	Part	Code	Code	Code	Code	Code
X8	05-06	125cc 4T LC						19588N	
X8	05-06	125cc 4T LC						37033N	
X8	05-07	200cc 4T LC						19588N	
X8	05-07	200cc 4T LC						37033N	
X8 EU3	06-08	400cc 4T LC	Piaggio M521M					16073N	
X8 PREMIUM EU2	06-06	125cc 4T LC						19588N	
X8 PREMIUM EU2	06-06	125cc 4T LC						37033N	
X8 PREMIUM EU3	06-07	125cc 4T LC						19588N	
X8 PREMIUM EU3	06-07	125cc 4T LC						37033N	
X8 STREET EU2	06-07	125cc 4T AC						19588N	
X8 STREET EU2	06-07	125cc 4T AC						37033N	
X8 STREET EU2	06-08	150cc 4T AC						19588N	
X8 STREET EU2	06-08	150cc 4T AC						37033N	
X9	01-02	125cc 4T LC						19588N	
X9	01-02	125cc 4T LC						37033N	
X9	02-03	200cc 4T LC						19588N	
X9	02-03	200cc 4T LC						37033N	
X9	01-02	500cc 4T LC						16073N	
X9 AMALFI	00-03	180cc 4T LC						19588N	
X9 AMALFI	00-03	180cc 4T LC						37033N	
X9 EVOLUTION	03-03	125cc 4T LC						19588N	
X9 EVOLUTION	03-03	125cc 4T LC						37033N	
X9 EVOLUTION	05-06	125cc 4T LC						19588N	
X9 EVOLUTION	05-06	125cc 4T LC						37033N	
X9 EVOLUTION	03-03	200cc 4T LC						19588N	
X9 EVOLUTION	03-03	200cc 4T LC						37033N	
X9 EVOLUTION	03-05	500cc 4T LC	Piaggio					16073N	
X9 EVOLUTION	06-07	500cc 4T LC	Piaggio					16073N	
X9 EVOLUTION ABS	06-07	500cc 4T LC	Piaggio					16073N	
X9 EVOLUTION EU3	07-07	125cc 4T LC						19588N	

IT	ALTERNATORE	BOBINA	CENTRALINA	MOTORINO AVVIAMENTO	REGOLATORE	STATORE
EN	ALTERNATOR	COIL	CDI	STARTER ENGINE	RECTIFIER	STATOR
FR	ALTERNATEUR	BOBINE	BOÎTIER ÉLECTRONIQUE	DÉMARREUR ÉLECTRIQUE	RÉGULATEUR	STATOR



PIAGGIO	X9 EVOLUTION EU3	07-07	125cc 4T LC				37033N		
	ZIP	00-02	125cc 4T AC				19588N		
	ZIP	00-02	125cc 4T AC	Leader			37033N		
	ZIP 4T	06-10	100cc 4T AC				16088N		
POLARIS	OUTLAW IRS	07-11	525cc 4T				19620N		
	OUTLAW MXR	08-10	450cc 4T				19620N		
	OUTLAW S	08-10	525cc 4T				19620N		
SUZUKI	AH ADDRESS	92-95	50cc 2T AC	Motore Suzuki			37036N		
	AJ ZZ	95-97	50cc 2T AC	Motore Suzuki			37036N		
	AN BURGMAN K7/LO	07-10	400cc 4T				18886N		
	AN BURGMAN L1	11-11	400cc 4T				18886N		
	AN BURGMAN L2	12-12	400cc 4T				18886N		
	AN BURGMAN L3	13-13	400cc 4T				18886N		
	AP	94-97	50cc 2T AC	Motore Suzuki			37036N		
	C50 BOULEVARD	05-13	800cc 4T				18787N		
	C50 BOULEVARD B.O.S.S.	14-14	800cc 4T				18787N		
	C50 BOULEVARD SE	09-13	800cc 4T				18787N		
	C50B BOULEVARD	05-08	800cc 4T				18787N		
	C50C BOULEVARD	06-08	800cc 4T				18787N		
	C50T BOULEVARD	05-13	800cc 4T				18787N		
	C50T BOULEVARD CLASSIC	12-12	800cc 4T				18787N		
	DR-Z400	00-04	400cc 4T				18718N		
	DR-Z400E	00-07	400cc 4T				18718N		
	DR-Z400S	00-15	400cc 4T				18718N		
	DR-Z400SM	05-15	400cc 4T				18718N		
	DR125 SE R-S	94-95	125cc 4T AC			CPS32			
	DR250SE	90-95	250cc 4T				18747N		
	DR350S	90-93	350cc 4T				18747N		
	DR350SE	94-95	350cc 4T				18747N		
	DR350SE	96-99	350cc 4T				18747N		

IT	ALTERNATORE	BOBINA	CENTRALINA	MOTORINO AVVIAMENTO	REGOLATORE	STATORE
EN	ALTERNATOR	COIL	CDI	STARTER ENGINE	RECTIFIER	STATOR
FR	ALTERNATEUR	BOBINE	BOÎTIER ÉLECTRONIQUE	DÉMARREUR ÉLECTRIQUE	RÉGULATEUR	STATOR
						

SUZUKI	Model	Year	Engine	Part	Part Number	Part Number
	GN125(E)	82-96	125cc 4T AC			
	GS	89-02	500cc 4T			18788N
	GS-F K4-K9, L0	04-09	500cc 4T			18788N
	GSF BANDIT	91-93	400cc 4T			18743N
	GSF BANDIT S	96-96	600cc 4T			18743N
	GSF BANDIT S	96-03	600cc 4T			18743N
	GSF1200S BANDIT	97-06	1200cc 4T			18733N
	GSF1250 BANDIT K7-L0	07-10	1250cc 4T			16087N
	GSF1250 BANDIT L0	10-10	1250cc 4T			16087N
	GSF1250 BANDIT L1	11-11	1250cc 4T			16087N
	GSF1250FA L0	10-10	1250cc 4T			16087N
	GSF1250FA L1	11-11	1250cc 4T			16087N
	GSF1250S BANDIT L1	11-11	1250cc 4T			16087N
	GSX F	98-03	600cc 4T			18743N
	GSX F	98-06	600cc 4T			18743N
	GSX F	89-97	750cc 4T			18788N
	GSX F	98-06	750cc 4T			18743N
	GSX-G	91-93	1100cc 4T			18733N
	GSX-R	92-93	600cc 4T			18784N
	GSX-R	97-00	600cc 4T			18791N
	GSX-R	01-03	600cc 4T			27-7015
	GSX-R	11-17	600cc 4T			27-7033
	GSX-R	88-92	750cc 4T			18788N
	GSX-R	93-93	750cc 4T			18784N
	GSX-R	94-95	750cc 4T			18784N
	GSX-R	96-99	750cc 4T			18792N
	GSX-R	00-03	750cc 4T			27-7015
	GSX-R	11-17	750cc 4T			27-7033
	GSX-R	89-92	1100cc 4T			18733N
	GSX-R	93-98	1100cc 4T			18784N

IT	ALTERNATORE	BOBINA	CENTRALINA	MOTORINO AVVIAMENTO	REGOLATORE	STATORE
EN	ALTERNATOR	COIL	CDI	STARTER ENGINE	RECTIFIER	STATOR
FR	ALTERNATEUR	BOBINE	BOÎTIER ÉLECTRONIQUE	DÉMARREUR ÉLECTRIQUE	RÉGULATEUR	STATOR
						

SUZUKI	Model	Year	Capacity	Motor	Part Number				
	GSX-R HAYABUSA	99-03	1300cc 4T		18798N				
	GSX-R HAYABUSA	99-07	1300cc 4T		18814N				
	GSX-R HAYABUSA LIMITED EDITION	06-06	1300cc 4T		18814N				
	KATANA V-Y	97-00	50cc 2T LC	Motore Suzuki	37036N				
	LT-Z400 QUADSPORT Z	03-09	400cc 4T		18718N				
	M50 BOULEVARD	05-05	800cc 4T		18787N				
	M50 BOULEVARD	06-09	800cc 4T		18787N				
	M50 BOULEVARD	13-13	800cc 4T		18787N				
	M50 BOULEVARD LIMITED	07-07	800cc 4T		18787N				
	M50 BOULEVARD SE	09-09	800cc 4T		18787N				
	M50B BOULEVARD	05-06	800cc 4T		18787N				
	M95 BOULEVARD	05-05	1600cc 4T		18692N				
	RF	93-96	600cc 4T		18784N				
	RF	94-96	900cc 4T		18784N				
	S50 BOULEVARD	05-09	800cc 4T		18787N				
	STREET MAGIC	98-98	50cc 2T AC	Motore Suzuki	37036N				
	VL800	13-15	800cc 4T		18787N				
	VL800 INTRUDER VOLUSIA	01-05	800cc 4T		18787N				
	VS750GL INTRUDER	85-91	750cc 4T		18787N				
	VS800GL INTRUDER	92-08	800cc 4T		18787N				
	VX800	90-94	800cc 4T		18787N				
	VZ1600 MARAUDER	04-04	1600cc 4T		18692N				
	VZ800 INTRUDER	13-13	800cc 4T		18787N				
	VZ800 MARAUDER	05-08	800cc 4T		18787N				
	ZILLION UX	99-99	50cc 2T LC	Motore Suzuki	37036N				
SYM	GTS JOYMAX	06-07	125cc 4T LC		37042N				
	HD EU3	07-08	125cc 4T-4V LC		37042N				
	HD EVO	05-06	125cc 4T-4V LC		37042N				
	HD EVO EU3	07-08	125cc 4T-4V LC		37042N				
	HD EVO EU3	10-11	125cc 4T-4V LC		37042N				

IT	ALTERNATORE	BOBINA	CENTRALINA	MOTORINO AVVIAMENTO	REGOLATORE	STATORE
EN	ALTERNATOR	COIL	CDI	STARTER ENGINE	RECTIFIER	STATOR
FR	ALTERNATEUR	BOBINE	BOÎTIER ÉLECTRONIQUE	DÉMARREUR ÉLECTRIQUE	RÉGULATEUR	STATOR
						

SYM	Model	Year	Engine	Part	Code	Part	Code
SYM	HD EVO TAMBURO EU3	08-09	125cc 4T-4V LC		37042N		
	HD2	11-11	125cc 4T-4V LC		37042N		
	HD2	14-14	125cc 4T-4V LC		37042N		
	JET	99-01	50cc 2T AC		37010N		
	JOYRIDE	01-02	125cc 4T-4V LC		37042N		
	JOYRIDE	01-02	125cc 4T-4V LC		37042N		
	JOYRIDE EU2	05-06	125cc 4T-4V LC		37042N		
	JOYRIDE EU3	07-07	125cc 4T-4V LC		37042N		
	JOYRIDE EVO	09-10	125cc 4T-4V LC		37042N		
	JOYRIDE EVO	10-10	125cc 4T-4V LC		37042N		
	JOYRIDE EVO	13-13	125cc 4T-4V LC		37042N		
	JOYRIDE EVO	14-14	125cc 4T-4V LC		37042N		
	JUNGLE	99-00	50cc 2T AC		37010N		
	MASK	00-01	50cc 2T AC		37010N		
	MASK EU2	03-04	50cc 2T AC		37010N		
RED DEVIL	99-99	50cc 2T AC		37010N			
SUPER FANCY	98-00	50cc 2T AC		37010N			
SYMPLY II	09-10	125cc 4T AC			YM1034N		
YAMAHA	BT BULLDOG	02-04	1100cc 4T AC			YM1034N	
	BT BULLDOG	05-06	1100cc 4T AC			YM1034N	
	BW'S 4T	10-10	125cc 4T AC	YW	16090N		
	FJ	84-85	1100cc 4T		18734N		
	FJ	86-90	1200cc 4T		18734N		
	FJ	91-93	1200cc 4T		18734N		
	FZ6	04-05	600cc 4T		18763N		
	FZ6	06-06	600cc 4T		18763N		
	FZ6	07-07	600cc 4T		18763N		
	FZ6 FAZER	04-05	600cc 4T		18763N		
FZ6 FAZER	06-06	600cc 4T		18763N			
FZ6 FAZER	07-07	600cc 4T		18763N			

IT	ALTERNATORE	BOBINA	CENTRALINA	MOTORINO AVVIAMENTO	REGOLATORE	STATORE
EN	ALTERNATOR	COIL	CDI	STARTER ENGINE	RECTIFIER	STATOR
FR	ALTERNATEUR	BOBINE	BOÎTIER ÉLECTRONIQUE	DÉMARREUR ÉLECTRIQUE	RÉGULATEUR	STATOR
						

YAMAHA	Model	Year	Capacity	LC	Part No.	Part No.	Part No.	Part No.	Part No.	Part No.
FZ6 FAZER ABS	06-06	600cc 4T						18763N		
FZ6 FAZER ABS	07-07	600cc 4T						18763N		
FZ6 FAZER S2	07-07	600cc 4T						18763N		
FZ6 FAZER S2	08-08	600cc 4T						18763N		
FZ6 FAZER S2 ABS	08-08	600cc 4T						18763N		
FZ6 NS	05-05	600cc 4T						18763N		
FZ6 NS	06-06	600cc 4T						18763N		
FZ6 S2	07-07	600cc 4T						18763N		
FZ6 S2	08-08	600cc 4T						18763N		
FZS FAZER	01-03	1000cc 4T						18764N		
FZS FAZER	04-05	1000cc 4T						18764N		
MAJESTY	05-10	400cc 4T						18843N		
MAJESTY	12-12	400cc 4T						18843N		
MORPHOUS	06-08	250cc 4T						18843N		
SZR	95-97	660cc 4T						18760N		
T-MAX 4B5	09-11	500cc 4T LC	4B5					37039N		
T-MAX 4B5	09-11	500cc 4T LC	4B5					37039N		
T-MAX 4B5 ABS	08-11	500cc 4T LC	4B5					37039N		
T-MAX 4B5 ABS	08-11	500cc 4T LC	4B5					37039N		
T-MAX 59C	12-12	530cc 4T LC	59C					37039N		
T-MAX 59C	12-12	530cc 4T LC	59C					37039N		
T-MAX 59C	13-14	530cc 4T LC	59C					37039N		
T-MAX 59C	13-14	530cc 4T LC	59C					37039N		
T-MAX 59C	15-16	530cc 4T LC	59C					37039N		
T-MAX 59C	15-16	530cc 4T LC	59C					37039N		
T-MAX 59C ABS	12-12	530cc 4T LC	59C					37039N		
T-MAX 59C ABS	12-12	530cc 4T LC	59C					37039N		
T-MAX 59C ABS	13-14	530cc 4T LC	59C					37039N		
T-MAX 59C ABS	13-14	530cc 4T LC	59C					37039N		
T-MAX 59C ABS	15-16	530cc 4T LC	59C					37039N		

IT	ALTERNATORE	BOBINA	CENTRALINA	MOTORINO AVVIAMENTO	REGOLATORE	STATORE
EN	ALTERNATOR	COIL	CDI	STARTER ENGINE	RECTIFIER	STATOR
FR	ALTERNATEUR	BOBINE	BOÎTIER ÉLECTRONIQUE	DÉMARREUR ÉLECTRIQUE	RÉGULATEUR	STATOR
						

YAMAHA	Model	Year	Engine	Part No.	IT	EN	FR	Part No.	IT	EN	FR
	T-MAX 59C ABS	15-16	530cc 4T LC	59C				37039N			
	T-MAX 59C SP	15-15	530cc 4T LC	59C				37039N			
	T-MAX 59C SP	15-15	530cc 4T LC	59C				37039N			
	T-MAX 59C SP ABS	15-16	530cc 4T LC	59C				37039N			
	T-MAX 59C SP ABS	15-16	530cc 4T LC	59C				37039N			
	T-MAX 5VU	08-08	500cc 4T LC	5VU				37039N			
	T-MAX 5VU	08-08	500cc 4T LC	5VU				37039N			
	T-MAX 5VU BLACK MAX	06-06	500cc 4T LC	5VU				37039N			
	T-MAX 5VU BLACK MAX	06-06	500cc 4T LC	5VU				37039N			
	T-MAX SV	11-11	500cc 4T LC	4B5				37039N			
	T-MAX SV	11-11	500cc 4T LC	4B5				37039N			
	T-MAX SV ABS	10-11	500cc 4T LC	4B5				37039N			
	T-MAX SV ABS	10-11	500cc 4T LC	4B5				37039N			
	T-MAX WHITE MAX	10-10	500cc 4T LC	4B5				37039N			
	T-MAX WHITE MAX	10-10	500cc 4T LC	4B5				37039N			
	TRICKER	05-05	250cc 4T					19639N			
	TT	86-87	225cc 4T					18845N			
	TT E	94-95	600cc 4T					18760N			
	TT E	96-01	600cc 4T					18760N			
	TT R	99-99	225cc 4T					18747N			
	TT R	99-04	225cc 4T					18845N			
	TT R	99-06	250cc 4T					18762N			
	TT RE	04-04	600cc 4T					18760N			
	TTR125E	03-07	125cc 4T					16079N			
	TTR125LE	03-07	125cc 4T					16079N			
	V-MAX	86-01	1200cc 4T					18750N			
	V-MAX	01-07	1200cc 4T					18825N			
	WR450F	03-06	450cc 4T					18844N			
	WR450F	07-07	450cc 4T LC					16075N			
	WR450F	08-08	450cc 4T LC					16075N			

IT	ALTERNATORE	BOBINA	CENTRALINA	MOTORINO AVVIAMENTO	REGOLATORE	STATORE
EN	ALTERNATOR	COIL	CDI	STARTER ENGINE	RECTIFIER	STATOR
FR	ALTERNATEUR	BOBINE	BOÎTIER ÉLECTRONIQUE	DÉMARREUR ÉLECTRIQUE	RÉGULATEUR	STATOR
						

YAMAHA	Model	Year	Engine	Supplier	Part No.	Part No.	Part No.	Part No.	Part No.	Part No.
	WR450F	09-09	450cc 4T LC					16075N		
	WR450F	10-11	450cc 4T LC					16075N		
	WR450F	12-12	450cc 4T LC					16075N		
	WR450F	13-13	450cc 4T LC					16075N		
	WR450F	14-14	450cc 4T LC					16075N		
	X-CITY	07-07	250cc 4T LC						YM1034N	
	X-CITY	08-08	250cc 4T LC						YM1034N	
	X-CITY	09-12	250cc 4T LC						YM1034N	
	X-CITY	13-15	250cc 4T LC						YM1034N	
	X-CITY EU3	08-11	125cc 4T-4V LC	Minarelli					YM1034N	
	X-MAX	07-09	250cc 4T LC						YM1034N	
	X-MAX	14-16	250cc 4T LC						YM1034N	
	X-MAX ABS	14-15	250cc 4T LC						YM1034N	
	X-MAX BLACK	09-09	250cc 4T LC						YM1034N	
	X-MAX R	06-07	125cc 4T-4V LC	Minarelli					YM1034N	
	X-MAX R	08-09	125cc 4T-4V LC	Minarelli					YM1034N	
	X-MAX R	14-14	125cc 4T-4V LC	Minarelli					YM1034N	
	X-MAX R	14-14	125cc 4T-4V LC	Minarelli					YM1034N	
	X-MAX R	15-16	125cc 4T-4V LC	Minarelli					YM1034N	
	X-MAX RA ABS	14-15	125cc 4T-4V LC	Minarelli					YM1034N	
	X-MAX RA ABS	16-16	125cc 4T-4V LC	Minarelli					YM1034N	
	XP530-A T-MAX SX	17-17	530cc 4T LC	BX3				37039N		
	XP530-A T-MAX SX	17-17	530cc 4T LC	BX3				37039N		
	XP530-A T-MAX SX	18-18	530cc 4T LC	BX3				37039N		
	XP530-A T-MAX SX	18-18	530cc 4T LC	BX3				37039N		
	XP530-A T-MAX SX	19-19	530cc 4T LC	BX3				37039N		
	XP530-A T-MAX SX	19-19	530cc 4T LC	BX3				37039N		
	XP530D-A T-MAX DX	17-17	530cc 4T LC	BC3				37039N		
	XP530D-A T-MAX DX	17-17	530cc 4T LC	BC3				37039N		
	XP530D-A T-MAX DX	18-18	530cc 4T LC	BC3				37039N		

IT	ALTERNATORE	BOBINA	CENTRALINA	MOTORINO AVVIAMENTO	REGOLATORE	STATORE
EN	ALTERNATOR	COIL	CDI	STARTER ENGINE	RECTIFIER	STATOR
FR	ALTERNATEUR	BOBINE	BOÎTIER ÉLECTRONIQUE	DÉMARREUR ÉLECTRIQUE	RÉGULATEUR	STATOR
						

YAMAHA	Model	Year	Engine	Part No.	IT	EN	FR	Part No.	IT	EN	FR
	XP530D-A T-MAX DX	18-18	530cc 4T LC	BC3				37039N			
	XP530D-A T-MAX DX	19-19	530cc 4T LC	BC3				37039N			
	XP530D-A T-MAX DX	19-19	530cc 4T LC	BC3				37039N			
	XP530E-A T-MAX	17-17	530cc 4T LC	BV11				37039N			
	XP530E-A T-MAX	17-17	530cc 4T LC	BV11				37039N			
	XP530E-A T-MAX	18-18	530cc 4T LC	BV11				37039N			
	XP530E-A T-MAX	18-18	530cc 4T LC	BV11				37039N			
	XT	92-97	225cc 4T					18747N			
	XT	98-99	225cc 4T					18747N			
	XT	00-02	225cc 4T					18845N			
	XT	08-15	250cc 4T					19639N			
	XT E	90-90	600cc 4T					18760N			
	XT E	91-91	600cc 4T					18760N			
	XT E	92-92	600cc 4T					18760N			
	XT E	93-93	600cc 4T					18760N			
	XT E	94-94	600cc 4T					18760N			
	XT E	95-02	600cc 4T					18760N			
	XT Z TENERE	88-88	600cc 4T					18760N			
	XT Z TENERE	89-89	600cc 4T					18760N			
	XT Z TENERE	90-90	600cc 4T					18760N			
	XT Z TENERE	91-91	660cc 4T					18760N			
	XT Z TENERE	92-92	660cc 4T					18760N			
	XT Z TENERE	93-93	660cc 4T					18760N			
	XT Z TENERE	94-96	660cc 4T					18760N			
	XT Z TENERE	08-09	660cc 4T					18760N			
	XT Z TENERE	10-12	660cc 4T					18760N			
	XT Z TENERE	13-15	660cc 4T					18760N			
	XT ZA TENERE	11-11	660cc 4T					18760N			
	XT ZA TENERE	15-15	660cc 4T					18760N			
	XT-R	04-05	660cc 4T					18760N			

IT	ALTERNATORE	BOBINA	CENTRALINA	MOTORINO AVVIAMENTO	REGOLATORE	STATORE
EN	ALTERNATOR	COIL	CDI	STARTER ENGINE	RECTIFIER	STATOR
FR	ALTERNATEUR	BOBINE	BOÎTIER ÉLECTRONIQUE	DÉMARREUR ÉLECTRIQUE	RÉGULATEUR	STATOR
						

YAMAHA	Model	Year	Capacity	Part No.	Part No.	Part No.	Part No.	Part No.	Part No.
	XT-R	07-07	660cc 4T				18760N		
	XT-R	07-07	660cc 4T				18760N		
	XT-R	08-11	660cc 4T				18760N		
	XT-R	14-14	660cc 4T				18760N		
	XT-X	04-05	660cc 4T				18760N		
	XT-X	07-07	660cc 4T				18760N		
	XT-X	07-07	660cc 4T				18760N		
	XT-X	08-11	660cc 4T				18760N		
	XT-X	14-14	660cc 4T				18760N		
	XV A WILD STAR	99-02	1600cc 4T AC					YM1034N	
	XV ROUTE 66	88-90	250cc 4T				18768N		
	XV V STAR 250	08-15	250cc 4T				18768N		
	XV VIRAGO	95-07	250cc 4T				18768N		
	XV VIRAGO	84-87	700cc 4T				18727N		
	XV VIRAGO	86-87	700cc 4T				18737N		
	XV VIRAGO	81-97	750cc 4T				18727N		
	XV VIRAGO	90-97	750cc 4T				18737N		
	XV VIRAGO	82-82	920cc 4T				18727N		
	XV VIRAGO	84-85	1000cc 4T				18737N		
	XV VIRAGO	86-89	1100cc 4T				18737N		
	XV VIRAGO	90-98	1100cc 4T				18737N		
	XV VIRAGO	99-99	1100cc 4T				18748N		
	XV1600A ROAD STAR	99-03	1600cc 4T				18746N		
	XV1600A ROAD STAR	03-03	1600cc 4T				18767N		
	XV1600AS ROAD STAR MIDNIGHT	00-00	1600cc 4T				18746N		
	XV1600AS ROAD STAR MIDNIGHT	01-03	1600cc 4T				18767N		
	XV1600AT ROAD STAR SILVERADO	99-03	1600cc 4T				18746N		
	XV1700A ROAD STAR	04-07	1700cc 4T				18767N		
	XV1700AM ROAD STAR MIDNIGHT	04-07	1700cc 4T				18767N		
	XV1700AT ROAD STAR SILVERADO	04-05	1700cc 4T				18767N		

IT	ALTERNATORE	BOBINA	CENTRALINA	MOTORINO AVVIAMENTO	REGOLATORE	STATORE
EN	ALTERNATOR	COIL	CDI	STARTER ENGINE	RECTIFIER	STATOR
FR	ALTERNATEUR	BOBINE	BOÎTIER ÉLECTRONIQUE	DÉMARREUR ÉLECTRIQUE	RÉGULATEUR	STATOR
						



YAMAHA	Model	Year	Capacity	Part No.	Part No.	Part No.	Part No.	Part No.	Part No.
	XV1700AT ROAD STAR SILVERADO	06-07	1700cc 4T				18746N		
	XV1700ATM ROAD STAR MIDNIGHT SILVERADO	04-07	1700cc 4T				18767N		
	XV920M MID-VIRAGO	83-83	920cc 4T				18727N		
	XV920R SECA	81-81	920cc 4T				18727N		
	XVS A DRAG STAR CLASSIC	98-01	650cc 4T AC					YM1034N	
	XVS A DRAG STAR CLASSIC	00-02	1100cc 4T AC					YM1034N	
	XVS DRAG STAR	04-04	125cc 4T AC					YM1034N	
	XVS DRAG STAR	01-03	250cc 4T AC					YM1034N	
	XVS DRAG STAR	97-99	650cc 4T AC					YM1034N	
	XVS DRAG STAR	00-02	650cc 4T AC					YM1034N	
	XVS DRAG STAR	99-00	1100cc 4T AC					YM1034N	
	XVS DRAG STAR	01-02	1100cc 4T AC					YM1034N	
	XVS1100 V STAR 1100 CUSTOM	99-02	1100cc 4T				18748N		
	XVS1100 V STAR 1100 CUSTOM	03-09	1100cc 4T				18748N		
	XVS1100A V STAR 1100 CLASSIC	00-03	1100cc 4T				18748N		
	XVS1100A V STAR 1100 CLASSIC	03-09	1100cc 4T				18748N		
	XVS1100AT V STAR 1100 SILVERADO	02-02	1100cc 4T				18748N		
	XVS1100AT V STAR 1100 SILVERADO	03-09	1100cc 4T				18748N		
	XVZ1300A ROYAL STAR	96-98	1300cc 4T				18769N		
	XVZ1300AL ROYAL STAR BOULEVARD	99-01	1300cc 4T				18769N		
	XVZ1300AT ROYAL STAR TOUR CLASSIC	96-00	1300cc 4T				18769N		
	XVZ1300CT ROYAL STAR TOUR DELUXE	97-10	1300cc 4T				18769N		
	XVZ1300CTM ROYAL STAR MIDNIGHT TOUR DELUXE	06-07	1300cc 4T				18769N		
	XVZ1300CTS ROYAL STAR TOUR DELUXE S	08-09	1300cc 4T				18769N		
	XVZ1300TF ROYAL STAR VENTURE	99-09	1300cc 4T				18769N		
	XVZ1300TFM ROYAL STAR MIDNIGHT VENTURE	02-07	1300cc 4T				18769N		
	XVZ1300TFS ROYAL STAR VENTURE S	09-13	1300cc 4T				18769N		
	YBR	05-12	125cc 4T				19587N		
	YFM 25R	09-09	250cc 4T				19639N		
	YFM 25R	10-13	250cc 4T				19639N		

IT	ALTERNATORE	BOBINA	CENTRALINA	MOTORINO AVVIAMENTO	REGOLATORE	STATORE
EN	ALTERNATOR	COIL	CDI	STARTER ENGINE	RECTIFIER	STATOR
FR	ALTERNATEUR	BOBINE	BOÎTIER ÉLECTRONIQUE	DÉMARREUR ÉLECTRIQUE	RÉGULATEUR	STATOR
						

YAMAHA	Model	Year	Capacity	Code	Part 1	Part 2	Part 3	Part 4	Part 5	Part 6
	YFM 25RX	08-08	250cc 4T					19639N		
	YFM 25RX SP	08-08	250cc 4T					19639N		
	YFM 660FA GRIZZLY 4WD	05-06	660cc 4T						YM1034N	
	YFM 660FR GRIZZLY 4WD	03-03	660cc 4T						YM1034N	
	YFM 660FW GRIZZLY 4WD	02-02	660cc 4T						YM1034N	
	YFM 70RY	09-09	700cc 4T						YM1034N	
	YFM 70RY SE	09-09	700cc 4T						YM1034N	
	YFM 7RZ	10-12	700cc 4T						YM1034N	
	YFM FS GRIZZLY 4WD	04-04	660cc 4T						YM1034N	
	YFM FS GRIZZLY 4WD	05-05	660cc 4T						YM1034N	
	YFM R RAPTOR	02-05	660cc 4T					18760N		
	YFM RW	07-07	700cc 4T						YM1034N	
	YFM700 R	08-08	700cc 4T						YM1034N	
	YFM700 R	13-14	700cc 4T						YM1034N	
	YFZ R	09-12	450cc 4T					19200N		
	YFZ R	13-13	450cc 4T					19200N		
	YFZ R	14-14	450cc 4T					19200N		
	YFZ S	04-04	450cc 4T					18761N		
	YFZ SV	08-08	450cc 4T					18761N		
	YFZ450R	19-19	450cc 4T					19200N	YM1034N	
	YJ RA VINO CLASSIC	02-05	50cc 4T					18749N		
	YJ VINO	01-04	50cc 4T					18749N		
	YW ZUMA	09-10	125cc 4T	YW				16090N		
	YW ZUMA	11-15	125cc 4T	YW				16090N		
	YXR RHINO	05-06	660cc 4T						YM1034N	
	YXR RHINO	07-07	660cc 4T						YM1034N	
	YZF R	09-12	450cc 4T					18761N	YM1034N	
	YZF R	13-13	450cc 4T					18761N	YM1034N	
	YZF R	14-14	450cc 4T					18761N	YM1034N	
	YZF R1	98-99	1000cc 4T					18764N		

ELECTRIC PARTS

MOTORPARTS

IT	ALTERNATORE	BOBINA	CENTRALINA	MOTORINO AVVIAMENTO	REGOLATORE	STATORE
EN	ALTERNATOR	COIL	CDI	STARTER ENGINE	RECTIFIER	STATOR
FR	ALTERNATEUR	BOBINE	BOÎTIER ÉLECTRONIQUE	DÉMARREUR ÉLECTRIQUE	RÉGULATEUR	STATOR
						

YAMAHA	YZF R46	05-05	600cc 4T				18763N		
	YZF R6	99-00	600cc 4T				18763N		
	YZF R6	01-02	600cc 4T				18763N		
	YZF R6	03-04	600cc 4T				18763N		
	YZF R6	05-05	600cc 4T				18763N		
	YZF-R6	99-02	600cc 4T						27-7016

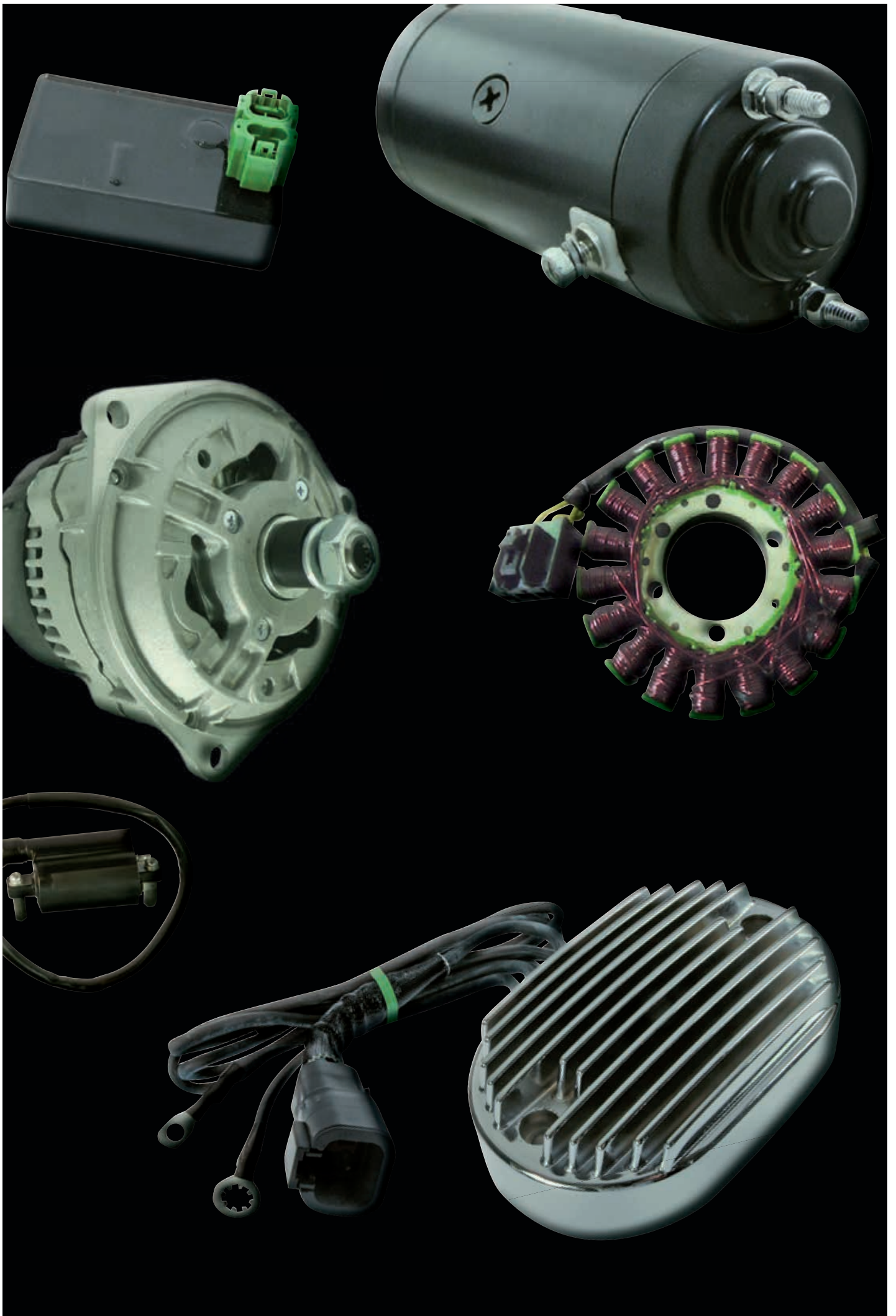

**MICROCAR****MOTORPARTS**

AIXAM	AIXAM	AIXAM	AIXAM
300	300	400	400
96-04	99-05	96-04	99-05
276cc	276cc	400cc	400cc

IT	EN	FR				
AMMORTIZZATORI ANTERIORI	FRONT SHOCK ABSORBERS	AMORTISSEURS AVANT		SAM0001		SAM0001
AMMORTIZZATORI POSTERIORI	REAR SHOCK ABSORBERS	AMORTISSEURS ARRIERE				SAM0002
GIUNTI	JOINTS	JOINTS			HJM1015K	HJM1015K
SEMIASSI	HALF SHAFTS	DEMI-ESSIEUX		DSM03265		DSM03166 DSM03264 DSM03265
DISCHI FRENO ANTERIORI	FRONT BRAKE DISCS	DISQUES DE FREIN AVANT				
DISCHI FRENO POSTERIORI VENTILATI	REAR VENTED BRAKE DISCS	DISQUES DE FREIN ARRIERE VENTILES				
DISCHI FRENO POSTERIORI	REAR BRAKE DISCS	DISQUES DE FREINS ARRIERE				
PASTIGLIE FRENO ANTERIORI	FRONT BRAKE PADS	PLAQUETTES DE FREIN AVANT				
PASTIGLIE FRENO POSTERIORI	REAR BRAKE PADS	PLAQUETTES DE FREIN ARRIERE				
PINZE FRENO ANTERIORI	FRONT BRAKE CALLIPERS	ETRIERS DE FREINS AVANT				
PINZE FRENO POSTERIORI	REAR BRAKE CALLIPERS	ETRIERS DE FREINS ARRIERE				

AIXAM	AIXAM	AIXAM	AIXAM	AIXAM	AIXAM	AIXAM	AIXAM	AIXAM	AIXAM	AIXAM	AIXAM
500	500,4	500,4	A721	A721	A741	A741	A751	CITY	CITY	CITY ABS	CITY ABS
99-05	97-05	99-05	05-08	05-08	05-08	05-08	05-08	10-12	12-19	10-12	12-19
400cc	400cc	400cc	400cc	400cc	400cc	400cc	500cc	400cc	500cc	400cc	500cc

	SAM0001			SAM0001		SAM0001					
HJM1015K		HJM1015K	HJM1015K		HJM1015K		HJM1015K	HJM1019K	HJM1019K	HJM1018K	HJM1018K
DSM03265		DSM03166	DSM03165		DSM03165		DSM03165	DSM03298	DSM03161	DSM03151	DSM03162 DSM03163



MICROCAR

MOTORPARTS

AIXAM	AIXAM	AIXAM	AIXAM
CITY ELETTRICA	COUPÈ	CROSSLINE	CROSSLINE
10-12	12-19	10-19	10-19
cc	500cc	400cc	500cc

IT	EN	FR				
AMMORTIZZATORI ANTERIORI	FRONT SHOCK ABSORBERS	AMORTISSEURS AVANT		SAM0024		
AMMORTIZZATORI POSTERIORI	REAR SHOCK ABSORBERS	AMORTISSEURS ARRIERE		SAM0025		
GIUNTI	JOINTS	JOINTS			HJM1019K	HJM1019K
SEMIASSI	HALF SHAFTS	DEMI-ESSIEUX		DSM03161	DSM03298	DSM03298
DISCHI FRENO ANTERIORI	FRONT BRAKE DISCS	DISQUES DE FREIN AVANT				
DISCHI FRENO POSTERIORI VENTILATI	REAR VENTED BRAKE DISCS	DISQUES DE FREIN ARRIERE VENTILES				
DISCHI FRENO POSTERIORI	REAR BRAKE DISCS	DISQUES DE FREINS ARRIERE				
PASTIGLIE FRENO ANTERIORI	FRONT BRAKE PADS	PLAQUETTES DE FREIN AVANT				
PASTIGLIE FRENO POSTERIORI	REAR BRAKE PADS	PLAQUETTES DE FREIN ARRIERE				
PINZE FRENO ANTERIORI	FRONT BRAKE CALLIPERS	ETRIERS DE FREINS AVANT				
PINZE FRENO POSTERIORI	REAR BRAKE CALLIPERS	ETRIERS DE FREINS ARRIERE				

AIXAM	AIXAM	AIXAM	AIXAM	AIXAM	AIXAM	AIXAM	BELLIER	BELLIER	BELLIER	BELLIER	BELLIER
CROSSLINE ABS	CROSSLINE ABS	D-TRUCK	EVOLUTION 400	GTO	GTO ABS	MULTI TRUCK	B8	B8	B8	B8	B8
10-19	10-19	12-19	02-19	10-19	10-19	12-19	15-16	16-17	17-19	15-16	16-17
400cc	500cc	478cc	400cc	400cc	400cc	478cc	440cc	440cc	440cc	523cc	523cc

		SAM0027				SAM0029					
		SAM0028				SAM0030					
HJM1018K	HJM1018K		HJM1015K	HJM1019K	HJM1018K		HJM1014K	HJM1014K	HJM1014K	HJM1014K	HJM1014K
DSM03297	DSM03297		DSM03166	DSM03298	DSM03297		DSM03295	DSM03002 DSM03003	DSM03280	DSM03295	DSM03002 DSM03003



MICROCAR

MOTORPARTS

BELLIER	BELLIER	BELLIER	CASALINI
B8	DOCKER	JADE	KERRY
17-19	16-19	16-19	15-19
523cc	480cc	523cc	538cc

IT	EN	FR				
AMMORTIZZATORI ANTERIORI	FRONT SHOCK ABSORBERS	AMORTISSEURS AVANT				
AMMORTIZZATORI POSTERIORI	REAR SHOCK ABSORBERS	AMORTISSEURS ARRIERE				
GIUNTI	JOINTS	JOINTS		HJM1014K	HJM1014K	HJM1014K
SEMIASSI	HALF SHAFTS	DEMI-ESSIEUX		DSM03280	DSM03279	DSM03176 DSM03075
DISCHI FRENO ANTERIORI	FRONT BRAKE DISCS	DISQUES DE FREIN AVANT				
DISCHI FRENO POSTERIORI VENTILATI	REAR VENTED BRAKE DISCS	DISQUES DE FREIN ARRIERE VENTILES				
DISCHI FRENO POSTERIORI	REAR BRAKE DISCS	DISQUES DE FREINS ARRIERE				
PASTIGLIE FRENO ANTERIORI	FRONT BRAKE PADS	PLAQUETTES DE FREIN AVANT				
PASTIGLIE FRENO POSTERIORI	REAR BRAKE PADS	PLAQUETTES DE FREIN ARRIERE				
PINZE FRENO ANTERIORI	FRONT BRAKE CALLIPERS	ETRIERS DE FREINS AVANT				
PINZE FRENO POSTERIORI	REAR BRAKE CALLIPERS	ETRIERS DE FREINS ARRIERE				

CASALINI	CASALINI	CASALINI	CASALINI	CASALINI	CASALINI	CASALINI	CHATENET	CHATENET	CHATENET	CHATENET	CHATENET
KERRY	M12 PICKUP	M14	M14	M14 ABS	M20	YDEA	BAROODER	BAROODER	CH26	CH26	CH26 EVO
15-19	15-19	08-12	12-14	14-19	17-19	00-00	08-19	08-19	10-19	10-19	16-19
635cc	635cc	538cc	538cc	635cc	480cc	500cc	505cc	505cc	505cc	505cc	505cc
							SAM0008		SAM0004		SAM0020
							SAM0009		SAM0035		SAM0038
HJM1014K	HJM1014K	HJM1014K	HJM1014K	HJM1017K	HJM1014K		HJM1014K				HJM1014K HJM1020K
DSM03235 DSM03236	DSM03235 DSM03236	DSM03184 DSM03185	DSM03153 DSM03154 DSM03156	DSM03268 DSM03269	DSM03275 DSM03276		DSM03184 DSM03180				DSM03271 DSM03134
										BDM0005	BDM0005
										BDM0006 BDM0007	BDM0006 BDM0007
										BPM0003	BPM0003
										BPM0004	BPM0004
										BCM6009 BCM6010	BCM6009 BCM6010
										BCM6011 BCM6012	BCM6011 BCM6012



MICROCAR

MOTORPARTS

CHATENET	CHATENET	CHATENET	CHATENET
CH26 I	CH26 MEDIA	CJF 214	MEDIA
10-10	10-10	95-01	98-01
505cc	505cc	505cc	505cc

IT	EN	FR				
AMMORTIZZATORI ANTERIORI	FRONT SHOCK ABSORBERS	AMORTISSEURS AVANT				
AMMORTIZZATORI POSTERIORI	REAR SHOCK ABSORBERS	AMORTISSEURS ARRIERE		SAM0040	SAM0039	
GIUNTI	JOINTS	JOINTS				HJM1014K HJM1014K
SEMIASSI	HALF SHAFTS	DEMI-ESSIEUX				DSM03235 DSM03235
DISCHI FRENO ANTERIORI	FRONT BRAKE DISCS	DISQUES DE FREIN AVANT				
DISCHI FRENO POSTERIORI VENTILATI	REAR VENTED BRAKE DISCS	DISQUES DE FREIN ARRIERE VENTILES				
DISCHI FRENO POSTERIORI	REAR BRAKE DISCS	DISQUES DE FREINS ARRIERE				
PASTIGLIE FRENO ANTERIORI	FRONT BRAKE PADS	PLAQUETTES DE FREIN AVANT				
PASTIGLIE FRENO POSTERIORI	REAR BRAKE PADS	PLAQUETTES DE FREIN ARRIERE				
PINZE FRENO ANTERIORI	FRONT BRAKE CALLIPERS	ETRIERS DE FREINS AVANT				
PINZE FRENO POSTERIORI	REAR BRAKE CALLIPERS	ETRIERS DE FREINS ARRIERE				

CHATENET	CHATENET	GREKAV	ITALCAR	ITALCAR	ITALCAR	JDM	JDM	JDM	JDM	JDM	JDM
MEDIA	STELLA	EKE	DOMINO	T2	T3	ABACA	ABACA	ABACA	ABACA MOUNTAIN	ALBIZIA	ALBIZIA
98-01	00-04	00-10	06-07	06-07	06-07	05-19	05-19	05-19	07-10	02-07	02-07
505cc	505cc	505cc	cc	505cc	505cc	505cc	505cc	523cc	523cc	505cc	523cc

SAM0005		SAM0011	SAM0019	SAM0019	SAM0019		SAM0007		SAM0006		
	HJM1014K					HJM1014K		HJM1014K		HJM1014K	HJM1014K
	DSM03235					DSM03235 DSM03048		DSM03235 DSM03048		DSM03235 DSM03048	DSM03235 DSM03048



MICROCAR

MOTORPARTS

JDM	JDM	JDM	JDM
ALOES	ROXSY	ROXSY	SIMPA
08-19	08-19	08-19	02-19
523cc	440cc	523cc	440cc

IT	EN	FR				
AMMORTIZZATORI ANTERIORI	FRONT SHOCK ABSORBERS	AMORTISSEURS AVANT				
AMMORTIZZATORI POSTERIORI	REAR SHOCK ABSORBERS	AMORTISSEURS ARRIERE				
GIUNTI	JOINTS	JOINTS		HJM1014K	HJM1014K	HJM1014K
SEMIASSI	HALF SHAFTS	DEMI-ESSIEUX		DSM03184	DSM03184	DSM03184 DSM03026 DSM03027
DISCHI FRENO ANTERIORI	FRONT BRAKE DISCS	DISQUES DE FREIN AVANT			BDM0005	BDM0005
DISCHI FRENO POSTERIORI VENTILATI	REAR VENTED BRAKE DISCS	DISQUES DE FREIN ARRIERE VENTILES				
DISCHI FRENO POSTERIORI	REAR BRAKE DISCS	DISQUES DE FREINS ARRIERE			BDM0006 BDM0007	BDM0006 BDM0007
PASTIGLIE FRENO ANTERIORI	FRONT BRAKE PADS	PLAQUETTES DE FREIN AVANT			BPM0003	BPM0003
PASTIGLIE FRENO POSTERIORI	REAR BRAKE PADS	PLAQUETTES DE FREIN ARRIERE			BPM0004	BPM0004
PINZE FRENO ANTERIORI	FRONT BRAKE CALLIPERS	ETRIERS DE FREINS AVANT			BCM6009 BCM6010	BCM6009 BCM6010
PINZE FRENO POSTERIORI	REAR BRAKE CALLIPERS	ETRIERS DE FREINS ARRIERE			BCM6011 BCM6012	BCM6011 BCM6012

JDM	JDM	JDM	LIGIER	LIGIER	LIGIER	LIGIER	LIGIER	LIGIER	LIGIER	LIGIER	LIGIER
TITANE	TITANE 1/2/3	XHEOS	IX0	JS 20	JS 36	JS 40	JS 48 (P70)	JS 48 ELETTRICA	JS 50 C	JS 50 F1	JS 50 F1
99-02	99-02	08-19	11-19	10-10	14-19	11-19	09-19	11-19	00-05	09-10	09-10
523cc	523cc	442cc	505cc	505cc	505cc	505cc	505cc	cc	505cc	505cc	505cc

SAM0010				SAM0032					SAM0021		SAM0015
											SAM0016
	HJM1014K	HJM1014K	HJM1015K		HJM1015K	HJM1015K	HJM1015K	HJM1015K		HJM1015K	
	DSM03176	DSM03184	DSM03165 DSM03166		DSM03263	DSM03220 DSM03234	DSM03150	DSM03233 DSM03219		DSM03129 DSM03130	
		BDM0005	BDM0001		BDM0001	BDM0001					
			BDM0002 BDM0003		BDM0002 BDM0003	BDM0002 BDM0003					
		BDM0006 BDM0007	BDM0004		BDM0004	BDM0004					
		BPM0003	BPM0001		BPM0001	BPM0001					
		BPM0004	BPM0002		BPM0002	BPM0002					
		BCM6009 BCM6010	BCM6001 BCM6002		BCM6001 BCM6002	BCM6001 BCM6002					
		BCM6011 BCM6012	BCM6003 BCM6004		BCM6003 BCM6004	BCM6003 BCM6004					

**MICROCAR****MOTORPARTS**

LIGIER	LIGIER	LIGIER	LIGIER
JS 50 F1	JS 50 F1	JS 50 F1	JS 50 F2/F3
10-12	10-12	10-12	12-19
505cc	505cc	505cc	505cc

IT	EN	FR				
AMMORTIZZATORI ANTERIORI	FRONT SHOCK ABSORBERS	AMORTISSEURS AVANT			SAM0015	SAM0015
AMMORTIZZATORI POSTERIORI	REAR SHOCK ABSORBERS	AMORTISSEURS ARRIERE			SAM0016	SAM0016
GIUNTI	JOINTS	JOINTS		HJM1015K		HJM1015K
SEMIASSI	HALF SHAFTS	DEMI-ESSIEUX		DSM03272		DSM03157 DSM03158
DISCHI FRENO ANTERIORI	FRONT BRAKE DISCS	DISQUES DE FREIN AVANT				
DISCHI FRENO POSTERIORI VENTILATI	REAR VENTED BRAKE DISCS	DISQUES DE FREIN ARRIERE VENTILES				
DISCHI FRENO POSTERIORI	REAR BRAKE DISCS	DISQUES DE FREINS ARRIERE				
PASTIGLIE FRENO ANTERIORI	FRONT BRAKE PADS	PLAQUETTES DE FREIN AVANT				
PASTIGLIE FRENO POSTERIORI	REAR BRAKE PADS	PLAQUETTES DE FREIN ARRIERE				
PINZE FRENO ANTERIORI	FRONT BRAKE CALLIPERS	ETRIERS DE FREINS AVANT				
PINZE FRENO POSTERIORI	REAR BRAKE CALLIPERS	ETRIERS DE FREINS ARRIERE				

LIGIER	LIGIER	LIGIER	LIGIER	LIGIER	LIGIER	LIGIER	LIGIER	LIGIER	LIGIER	LIGIER	LIGIER
JS 50 F4	JS RC	JS58 ELETTRICA	NOVA	OPTIMAX	PRIMA	X-T00	X-T00	X-T00	X-T00	X-T00 MAX	X-T00 MAX
19-19	08-19	15-19	99-04	00-19	00-19	02-05	02-05	05-07	07-19	02-05	02-05
505cc	505cc	cc	505cc	505cc	505cc	505cc	505cc	505cc	505cc	505cc	505cc

			SAM0003					SAM0003			SAM0026
			SAM0012								SAM0014
HJM1015K	HJM1014K	HJM1015K		HJM1014K	HJM1014K	HJM1014K		HJM1014K	HJM1014K	HJM1014K	
DSM03296	DSM03184	DSM03292 DSM03293		DSM03180	DSM03180	DSM03176		DSM03066	DSM03091 DSM03092	DSM03176	
	BDM0001			BDM0001							
	BDM0002 BDM0003			BDM0002 BDM0003							
	BDM0004			BDM0004							
	BPM0001			BPM0001							
	BPM0002			BPM0002							
	BCM6001 BCM6002			BCM6001 BCM6002							
	BCM6003 BCM6004			BCM6003 BCM6004							



MICROCAR

MOTORPARTS

LIGIER	LIGIER	MICROCAR	MICROCAR
X-T00 R	X-T00 R	CARGO	DUÈ
00-19	00-19	07-19	14-14
505cc	505cc	505cc	505cc

IT	EN	FR				
AMMORTIZZATORI ANTERIORI	FRONT SHOCK ABSORBERS	AMORTISSEURS AVANT			SAM0013	SAM0022
AMMORTIZZATORI POSTERIORI	REAR SHOCK ABSORBERS	AMORTISSEURS ARRIERE			SAM0014	SAM0023
GIUNTI	JOINTS	JOINTS		HJM1014K		HJM1014K
SEMIASSI	HALF SHAFTS	DEMI-ESSIEUX		DSM03180		DSM03180
DISCHI FRENO ANTERIORI	FRONT BRAKE DISCS	DISQUES DE FREIN AVANT				BDM0001
DISCHI FRENO POSTERIORI VENTILATI	REAR VENTED BRAKE DISCS	DISQUES DE FREIN ARRIERE VENTILES				BDM0002 BDM0003
DISCHI FRENO POSTERIORI	REAR BRAKE DISCS	DISQUES DE FREINS ARRIERE				BDM0004
PASTIGLIE FRENO ANTERIORI	FRONT BRAKE PADS	PLAQUETTES DE FREIN AVANT				BPM0001
PASTIGLIE FRENO POSTERIORI	REAR BRAKE PADS	PLAQUETTES DE FREIN ARRIERE				BPM0002
PINZE FRENO ANTERIORI	FRONT BRAKE CALLIPERS	ETRIERS DE FREINS AVANT				BCM6001 BCM6002
PINZE FRENO POSTERIORI	REAR BRAKE CALLIPERS	ETRIERS DE FREINS ARRIERE				BCM6003 BCM6004







MICROCAR	MICROCAR	MICROCAR	MICROCAR	MICROCAR	MICROCAR	MICROCAR	MICROCAR	MICROCAR	MICROCAR	MICROCAR	MICROCAR
DUÈ FIRST	F8	M8	M8	MC1	MC1	MC2	MGO 1	MGO 1	MGO 2	MGO 2	MGO 3
11-19	11-19	16-19	16-19	03-07	03-07	03-07	08-13	13-15	08-13	13-15	15-19
505cc	505cc	480cc	500cc	505cc	523cc	505cc	505cc	505cc	505cc	505cc	505cc
				HJM1015K	HJM1015K	HJM1015K	HJM1014K	HJM1005K	HJM1014K	HJM1005K	HJM1014K HJM1005K
				DSM03165 DSM03166	DSM03165 DSM03166	DSM03165 DSM03166	DSM03184	DSM03097	DSM03184	DSM03097	DSM03180 DSM03086
BDM0001	BDM0001	BDM0001	BDM0001						BDM0001		
BDM0002 BDM0003	BDM0002 BDM0003	BDM0002 BDM0003	BDM0002 BDM0003						BDM0002 BDM0003		
BDM0004	BDM0004	BDM0004	BDM0004						BDM0004		
BPM0001	BPM0001	BPM0001	BPM0001						BPM0001		
BPM0002	BPM0002	BPM0002	BPM0002						BPM0002		
BCM6001 BCM6002	BCM6001 BCM6002	BCM6001 BCM6002	BCM6001 BCM6002						BCM6001 BCM6002		
BCM6003 BCM6004	BCM6003 BCM6004	BCM6003 BCM6004	BCM6003 BCM6004						BCM6003 BCM6004		



MICROCAR

MOTORPARTS

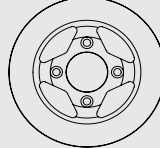
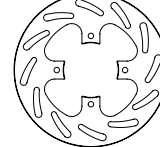
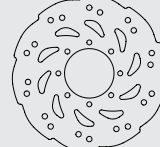
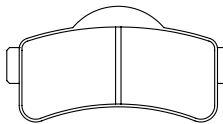
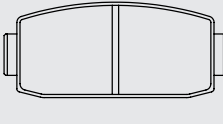
MICROCAR	MICROCAR	MICROCAR
MG0 4	MG0 4	VIRGO II
16-19	16-19	02-04
498cc	505cc	505cc

IT	EN	FR			
AMMORTIZZATORI ANTERIORI	FRONT SHOCK ABSORBERS	AMORTISSEURS AVANT			SAM0017
AMMORTIZZATORI POSTERIORI	REAR SHOCK ABSORBERS	AMORTISSEURS ARRIERE			SAM0018
GIUNTI	JOINTS	JOINTS		HJM1014K	HJM1014K
SEMIASSI	HALF SHAFTS	DEMI-ESSIEUX		DSM03180	DSM03180
DISCHI FRENO ANTERIORI	FRONT BRAKE DISCS	DISQUES DE FREIN AVANT			
DISCHI FRENO POSTERIORI VENTILATI	REAR VENTED BRAKE DISCS	DISQUES DE FREIN ARRIERE VENTILES			
DISCHI FRENO POSTERIORI	REAR BRAKE DISCS	DISQUES DE FREINS ARRIERE			
PASTIGLIE FRENO ANTERIORI	FRONT BRAKE PADS	PLAQUETTES DE FREIN AVANT			
PASTIGLIE FRENO POSTERIORI	REAR BRAKE PADS	PLAQUETTES DE FREIN ARRIERE			
PINZE FRENO ANTERIORI	FRONT BRAKE CALLIPERS	ETRIERS DE FREINS AVANT			
PINZE FRENO POSTERIORI	REAR BRAKE CALLIPERS	ETRIERS DE FREINS ARRIERE			

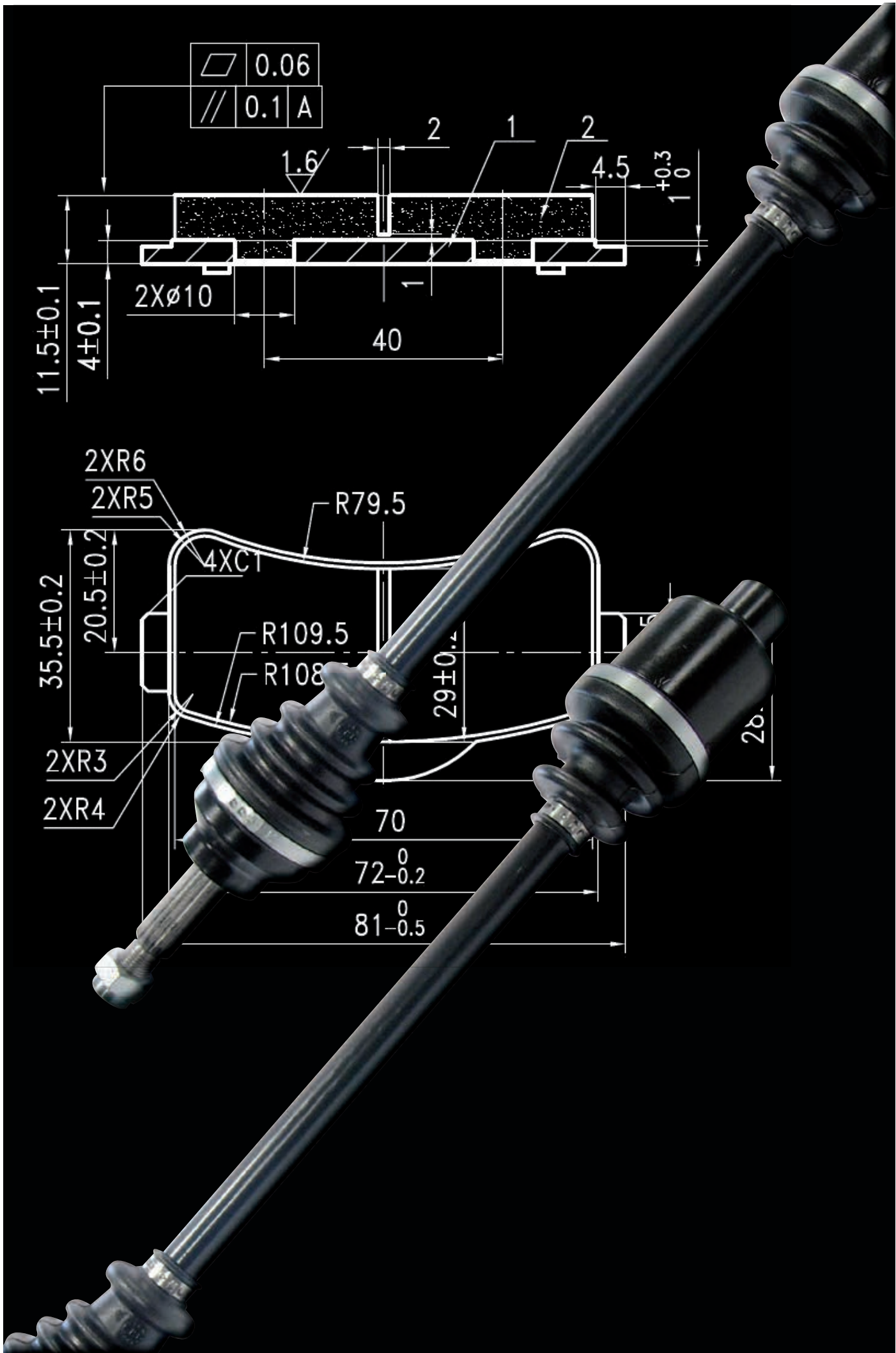



TPR
FACTORY

cod. 99CRPT0700 per Piaggio 70cc - cod. 99CRPT1000 per Piaggio 100cc

CARATTERISTICHE TECNICHE

- Costruito in Lega 6082 Anticorodal (Lega Al-Si-Mg-Mn)
- Carter pompa dimensionati per l'installazione di alberi motore con corsa fino a 47mm con interasse biella 95/96mm, senza alcun intervento aggiuntivo.
- Alloggiamento esclusivo per l'accensione a rotore interno PVL.
- L'utilizzo della pompa di raffreddamento elettrica, per eliminare l'assorbimento di potenza della tradizionale pompa meccanica.
- Sedi dei cuscinetti allargate e maggiorate con caratteristiche particolari
- Sezioni passaggio liquido di raffreddamento maggiorate

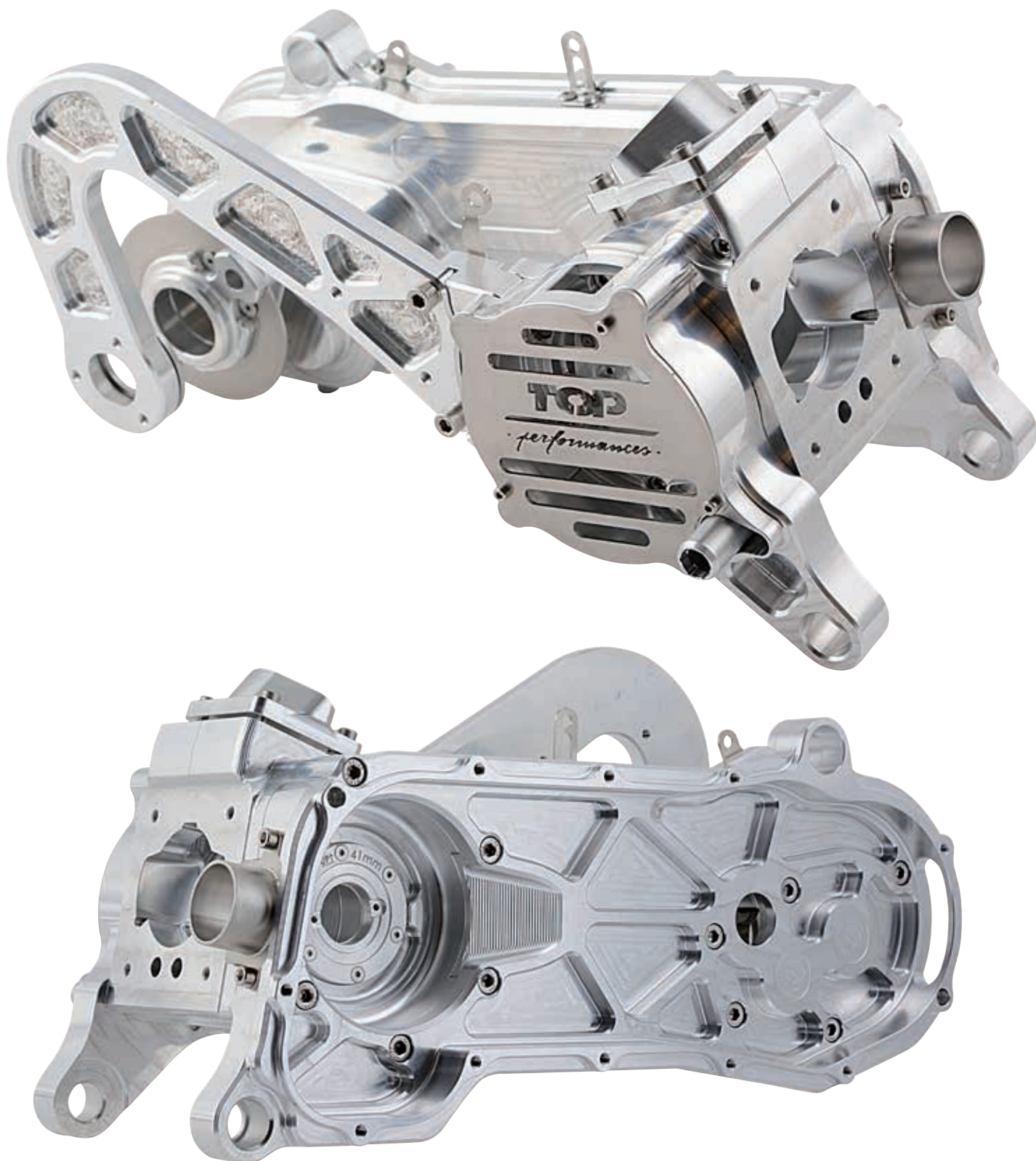

VERSIONI E COMPATIBILITÀ

Particolare attenzione è stata dedicata ad una compatibilità assoluta.

Con questo carter, possiamo intercambiare:

- Semicamere (70cc / 100cc / prototipi)
- Monobraccio (lungo / corto)
- Sistema frenate (disco / tamburo)
- Modello (Piaggio / Minarelli)

Versioni disponibili:

- Piaggio 70cc cod. 99CRPT0700
- Piaggio 100cc cod. 99CRPT1000

****POSSIBILITÀ DI SODDISFARE QUALUNQUE APPLICAZIONE CON UN'UNICA SEMICAMERA**

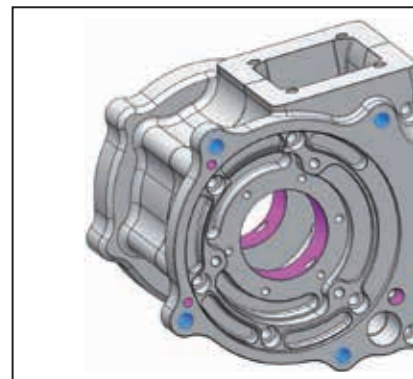

PASSO ALLUNGATO

Il passo è stato allungato traslando la posizione dell'asse ruota di 10mm verso il retrotreno e 10mm verso l'asfalto.

Questa soluzione migliora la ciclistica e permette di utilizzare l'ammortizzatore posteriore con 10mm in meno di lunghezza, riducendo l'inclinazione dell'alimentazione e del carter.

****MANTIENE INVARIATA LA LUNGHEZZA TRASMISSIONE ED I RAPPORTI (possibilità di montare qualunque marchio)**

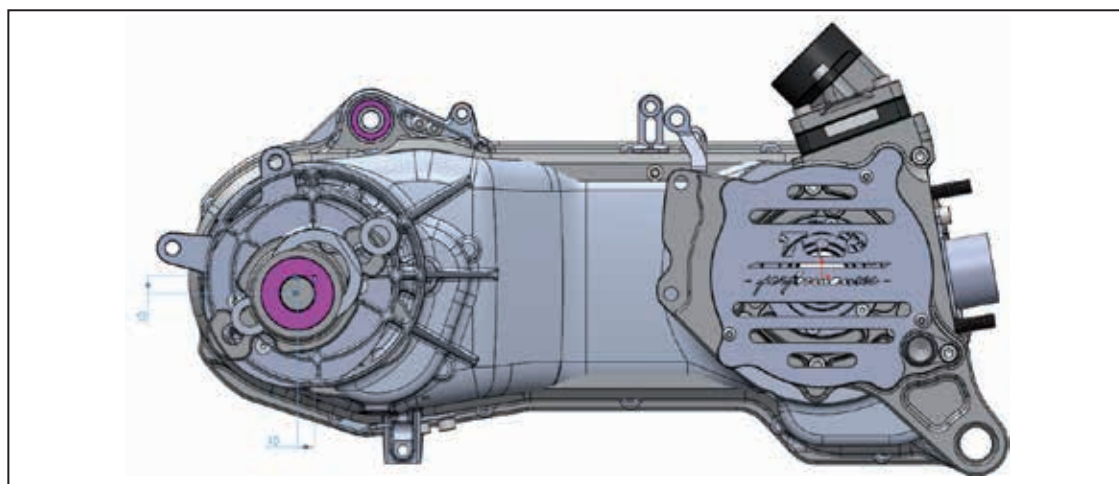

CAMBIO ROVESCiato AD INTERASSE ALLUNGATO

La scatola rapporti è stata radicalmente innovata, introducendo l'incremento del passo.

È stata rovesciata con apertura verso l'esterno

Ciò permette di eliminare il coperchio rapporti, migliorando la precisione delle coassialità, inoltre un o-ring garantisce una tenuta ottimale dell'olio.

****MANTIENE INVARIATA LA LUNGHEZZA TRASMISSIONE ED I RAPPORTI (possibilità di montare qualunque marchio)**

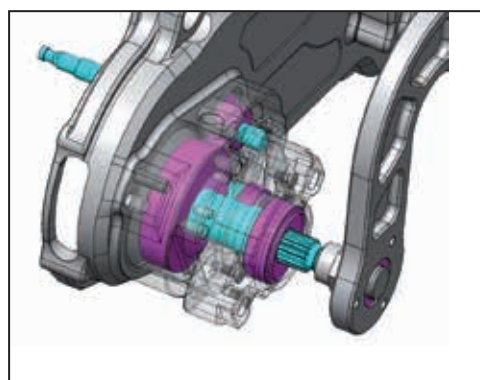

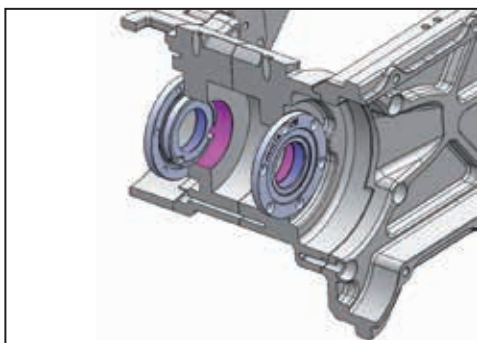

PARAOLI FLANGIATI

L'alloggiamento dei paraoli ora prevede due boccole flangiate, ciò permette di eseguire le barenature di entrambi i cuscinetti in una sola operazione, insieme al piano di appoggio del cilindro ottenendo una concentricità ed una tolleranza diametrica assoluta di entrambe le sedi. Diminuendo lo sforzo dell'albero sui cuscinetti ed aumentando la potenza e l'erogazione.

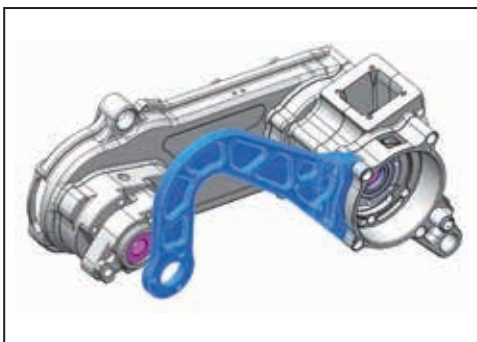

TORSEN INTEGRATO SCOMPONIBILE

Completamente rivisto, ora il torsen prevede l'attacco su un diametro nettamente più compatto, senza agire sui fori dello scarico (come invece avviene per tutti i concorrenti). Ciò permette di avere un collegamento molto più solido e sono previste anche due spine calibrate per un allineamento perfetto. Inoltre la sezione da oltre 14mm, risulta molto più robusta rispetto alle altre proposte.



ALIMENTAZIONE MAGGIORATA

L'alimentazione si presenta radicalmente riprogettata. Oltre a poter alloggiare valvole e carburatori maggiorati, permette anche una migliore disposizione del carburatore rispetto alla ruota. Inoltre grazie ad un doppio schema di foratura è possibile montare sia valvole maggiorate che valvole già in uso, con interasse 60x40 (es. AM6)

****CON FORATURE COMMERCIALI (possibilità di montare qualunque marchio)**

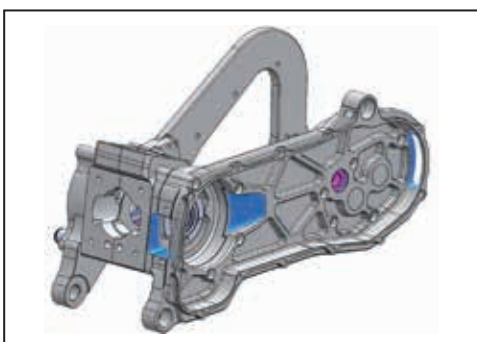

VENTILAZIONE OTTIMIZZATA

La ventilazione della zona trasmissione è stata nettamente ottimizzata. Molti problemi sono causati dalle temperature elevate; ora presenta due generosi passaggi (in ingresso ed in uscita) ed anche una zona centrale di estrazione per il variatore. Possibilità di installare portate forzate sulla presa d'aria in ingresso.

****MANTIENE LA POSSIBILITÀ DI ALLOGGIARE QUALUNQUE TRASMISSIONE (possibilità di montare qualunque marchio)**

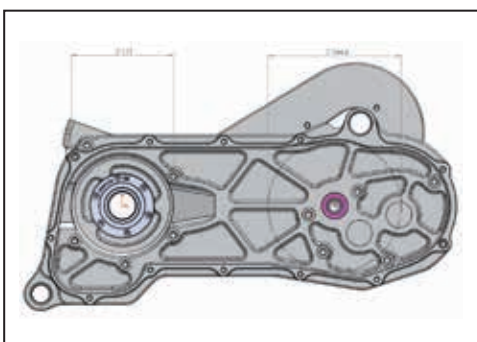

SEDE TRASMISSIONE MAGGIORATA

Di serie la sede della trasmissione è sottodimensionata per la piena escursione dei componenti, portando frequentemente la cinghia a strisciamenti e rotture. Ora sono previsti diametri di ingombro per variatori fino a 111mm e per i correttori fino a 145mm. A parità di utilizzo, la maggior volumetria genera inoltre anche una migliore dissipazione del calore

****MANTIENE LA POSSIBILITÀ DI ALLOGGIARE QUALUNQUE TRASMISSIONE**

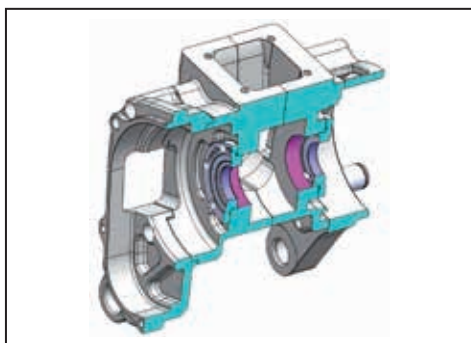

SEZIONE RESISTENTE ZONA ALBERO

Ad oggi nessun carter motore può vantare una tale resistenza nella zona albero motore. Tale sezione garantisce una planarità ed una qualità degli accoppiamenti più duratura. Tutte le lavorazioni vengono gestite su un centro di lavoro 5Assi pallettizzato leader nel settore Automotive e certificati su macchine di misura.

****MIGLIORE VALORE NEL SETTORE**

****MANTIENE LA POSSIBILITÀ DI ALLOGGIARE QUALUNQUE ALBERO E TRASMISSIONE**

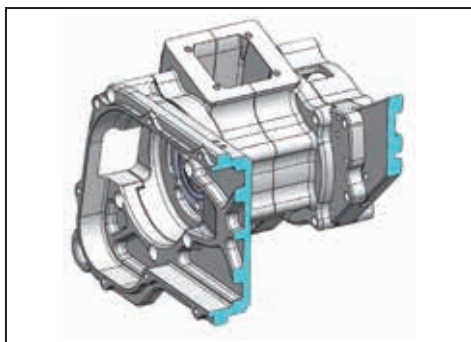

SEZIONE RESISTENTE ZONA TRASMISSIONE

Ad oggi nessun carter motore può vantare una tale resistenza nella zona trasmissione. Utilizzando il metodo degli elementi finiti FEM (Finite Element Method) è stata bilanciata e compensata la struttura del monobraccio, annullando di fatto qualsiasi momento torcente dato dal carico a sbalzo dell'asse ruota.

Grazie alla spinatura di centraggio di tutti i componenti, migliora l'allineamento rispetto alle altre soluzioni.

****MANTIENE LA POSSIBILITÀ DI ALLOGGIARE QUALUNQUE TIPO DI TRASMISSIONE**

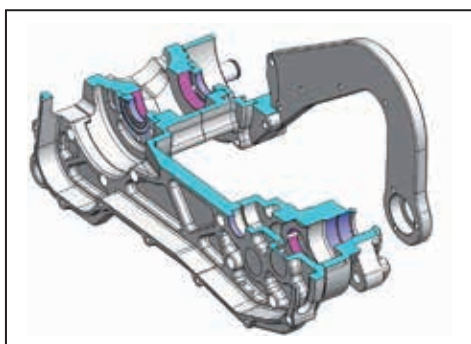

SEZIONE RESISTENTE ZONA ASSE RUOTA

Tramite simulazioni al FEM è stata incrementata la struttura nella scatola rapporti. Oltre all'aumento delle sollecitazioni abbiamo considerato l'adozione totale della cuscinetteria per migliorare l'alloggio dei rapporti, diminuendo i disallineamenti dei rapporti che generano calore e diminuiscono la potenza alla ruota.

****MANTIENE LA POSSIBILITÀ DI ALLOGGIARE QUALUNQUE TIPO DI RAPPORTI ED ASSI RUOTA**

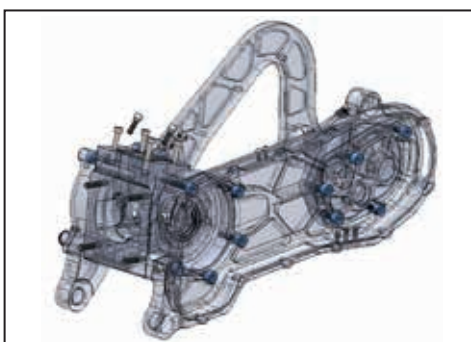

VITERIA MAGGIORATA

Motori sempre più performanti necessitano di estrema sicurezza negli accoppiamenti. Ad oggi l'impiego di Viteria M6 su alluminio risulta sottodimensionato e critico nei carter disponibili sul mercato.

Siamo riusciti a riprogettare tutto il carter con viteria M8 per tutti gli accoppiamenti (con sezione resistente +70% rispetto ad un M6).

Ciò aumenta la stabilità ed il grado di sicurezza dell'utilizzatore

****UNICO CARTER AD ADOTTARE FILETTATURE M8 PER TORSEN-MONOBRACCIO-RAPPORTI**

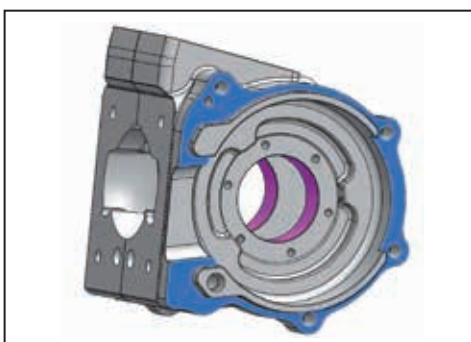

ACCOPIAMENTO MONOBRACCIO

Un approfondito studio per ottimizzare l'accoppiamento tra Semicamera e Monobraccio garantisce un impiego stabile e duraturo.

Oltre al centraggio e la fase, è stata posta particolare attenzione anche alla distribuzione omogenea del carico delle viti, posizionandole in zone equidistanti tra di loro e dal centro, completamente in acciaio altoresistenziale ad elevata inossidabilità, con testa cilindrica e filettatura metrica M8

****MANTIENE LA POSSIBILITÀ DI ALLOGGIARE QUALUNQUE ALBERO E TRASMISSIONE**





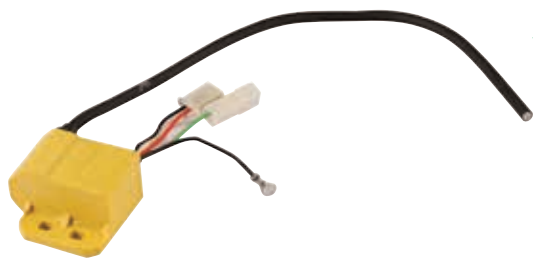

◀ **cod. 9910090**
Centralina ad anticipo fisso 6 poli Ducati

APPLICABILITÀ

BETA ARK 50 2T 96-08, ARK LC 50 2T 96-08, CHRONO 50 2T 95-96, QUADRA 50 2T 95-95, QUADRA 50 2T 99-01, TEMPO 50 2T 93-02, TEMPO 50 2T 95-95
KTM K50 50 2T 96-01
MACAL STING 50 2T 95-96, THUNDER 50 2T 95-96

MALAGUTI CENTRO SL 50 2T 94-98, CIAK 50 2T 99-01, CIAK EURO2 50 2T 01-03, F10 50 2T 92-00, F10 EURO 2 50 2T 02-06, F12 PHANTOM 50 2T 94-98, F12 PHANTOM LC 50 2T 94-98, F12 RESTYLING EURO 1 50 2T 99-02, F15 FIRE FOX 50 2T 96-98, YESTERDAY 50 2T 97-00

MOTRON STING 50 2T 95-96, SYNCRO 50 2T 98-00, THUNDER 50 2T 95-98



◀ **cod. 9910150**
Centralina ad anticipo fisso 6 poli per motori Minarelli AM

APPLICABILITÀ

APRILIA CLASSIC 50 2T 92-99, EUROPA 50 2T 91-92, MX 50 2T 04-04, MX MOTARD 50 2T 95-03, PEGASO 50 2T 92-94, RS 50 2T 91-05, RX 50 2T 03-04, RX 3-5 MARCE 50 2T 91-94, RX ENDURO 50 2T 95-03, RX RACING 50 2T 03-06, TUONO 50 2T 03-04
CH HUSQVARN SM 50 2T 00-10, WR 50 2T 00-10, WSM 50 2T 00-10
HM CRE SIX, BAIA, DERAPAGE 50 2T 95-05
MALAGUTI CNK DRAGON 50 2T 05-07, FIFTY EVOLUTION 50 2T 90-93, XSM 50 2T 03-03, XTM 50 2T 03-03
MBK X LIMIT 50 2T 03-04, X POWER 50 2T 03-04
MOTOR HISPANIA FURIA 50 2T 97-00, FURIA MAX 50 2T 10-12, RX 50 2T 09-12, RX R 50 2T 09-12

PEUGEOT SUPERMOTARD 50 2T 90-02, XP6 TRAIL S/AVV. ELETTRICO 50 2T 90-02, XR6 RACING CAT. C/AVV.ELETT. 50 2T 90-02

RIEJU MRT 50 2T 09-12, MRT PRO 50 2T 09-12, MRT PRO SM 50 2T 09-12, MRT SM 50 2T 09-12, MRX 50 2T 01-04, MRX PRO 50 2T 01-04, RR 50 2T 05-06, RS1 50 2T 98-01, RS2 MATRIX 50 2T 05-06, RS2 MATRIX PRO 50 2T 05-06, RS2 NAKED 50 2T 04-05, SMX E.S./K.S. 50 2T 01-01, SMX PRO E.S./K.S. 50 2T 03-03, SPIKE 50 2T 98-01

SHERCO HRD ENDURO 50 2T 09-13, HRD MOTARD 50 2T 09-13

YAMAHA DT R 50 2T 03-06, DT RSM 50 2T 03-05, DT X 50 2T 06-06

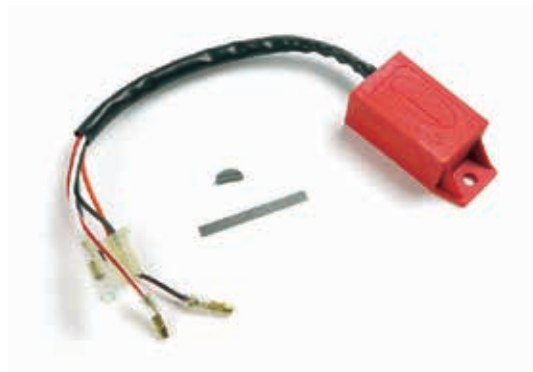

◀ **cod. 9909230**
Centralina ad anticipo variabile per motore orizzontale (Japan)

APPLICABILITÀ

APRILIA AREA 51 50 2T 98-00, GULLIVER 50 2T 95-98, GULLIVER LC 50 2T 96-98, RALLY 50 2T 95-03, RALLY LIQUID COOLED 50 2T 96-99, SCARABEO 50 2T 93-05, SONIC 50 2T 98-07, SONIC GP 50 2T 98-08, SR (ORIZZONTALE) 50 2T 94-96, SR LIQUID COOLED 50 2T 94-96, SR RACING 50 2T 97-99, SR STEALTH 50 2T 97-00, SR WWW 50 2T 97-01
BENELLI 491 GT 50 2T 98-99, 491 NAKED 50 2T 02-02, 491 RACING 50 2T 98-99, 491 RR 50 2T 99-01, 491 SP 50 2T 99-99, 491 SPORT 50 2T 98-99, 491 ST 50 2T 99-01, K2 50 2T 98-01, K2 LIQUID COOLED 50 2T 98-01, PEPE 50 2T 99-01, PEPE LX 50 2T 03-04
BETA CHRONO 50 2T 95-97, QUADRA 50 2T 99-01, TEMPO 50 2T 93-02
ITALJET DRAGSTER 50 2T 98-02

MBK BOOSTER 50 2T 90-04, BOOSTER 50 2T 90-94, BOOSTER NG 50 2T 95-03, BOOSTER ROCKET 50 2T 97-98, BOOSTER SPIRIT 50 2T 96-00, BOOSTER TRACK 50 2T 96-98, EVOLIS 50 2T 92-95, FIZZ 50 2T 94-95, FLIPPER 50 2T 98-04, NITRO 50 2T 97-04, OVETTO 50 2T 97-04, STUNT 50 2T 00-02

YAMAHA EROX 50 2T 97-02, AEROX 50 2T 04-16, AEROX NAKED 50 2T 13-16, AEROX R 50 2T 99-00, AEROX R 50 2T 99-99, AXIS 50 2T 95-96, BREEZE 50 2T 94-95, BW'S 50 2T 97-04, BW'S BUMP 50 2T 97-98, BW'S NAKED 50 2T 03-03, BW'S NEXT GENERATION 50 2T 97-00, BW'S NEXT GENERATION 50 2T 99-02, BW'S ORIGINAL 50 2T 99-00, BW'S ORIGINAL 50 2T 99-02, JOG 50 2T 92-01, JOG ER 50 2T 00-02, JOG Z 50 2T 95-95, NEO'S 50 2T 97-02, RS SPY 50 2T 95-98, SLIDER 50 2T 00-02, WHY 50 2T 98-05, ZEST 50 2T 95-92, ZUMA 50 2T 97-01

RICAMBI

9909180	Chiavetta disassata per anticipo variabile
----------------	--



◀ **cod. 9910100**
Centralina ad anticipo fisso per motori scooter 50 cc Minarelli/Yamaha

APPLICABILITÀ

APRILIA AREA 51 50 2T 98-00, GULLIVER 50 2T 95-98, GULLIVER LC 50 2T 96-98, RALLY 50 2T 95-03, RALLY LIQUID COOLED 50 2T 96-99, SCARABEO 50 2T 93-05, SONIC 50 2T 98-07, SONIC GP 50 2T 98-08, SR (ORIZZONTALE) 50 2T 94-96, SR LIQUID COOLED 50 2T 94-96, SR RACING 50 2T 97-99, SR STEALTH 50 2T 97-00, SR WWW 50 2T 97-01
BENELLI 491 GT 50 2T 98-99, 491 NAKED 50 2T 02-02, 491 RACING 50 2T 98-99, 491 RR 50 2T 99-01, 491 SP 50 2T 99-99, 491 SPORT 50 2T 98-99, 491 ST 50 2T 99-01, K2 50 2T 98-01, K2 LIQUID COOLED 50 2T 98-01, PEPE 50 2T 99-01, PEPE LX 50 2T 03-04
BETA CHRONO 50 2T 95-97, EIKON 50 2T 99-03, QUADRA 50 2T 99-01, TEMPO 50 2T 93-02
ITALJET DRAGSTER 50 2T 98-02

MBK BOOSTER 50 2T 90-04, BOOSTER 50 2T 90-94, BOOSTER NG 50 2T 95-03, BOOSTER ROCKET 50 2T 97-98, BOOSTER SPIRIT 50 2T 96-00, BOOSTER TRACK 50 2T 96-98, EVOLIS 50 2T 92-95, FIZZ 50 2T 94-95, FLIPPER 50 2T 98-04, NITRO 50 2T 97-04, OVETTO 50 2T 97-04, STUNT 50 2T 00-02

YAMAHA AEROX 50 2T 97-02, AEROX 50 2T 04-16, AEROX NAKED 50 2T 13-16, AEROX R 50 2T 99-00, AEROX R 50 2T 99-99, AXIS 50 2T 95-96, BREEZE 50 2T 94-95, BW'S 50 2T 97-04, BW'S BUMP 50 2T 97-98, BW'S NAKED 50 2T 03-03, BW'S NEXT GENERATION 50 2T 97-00, BW'S NEXT GENERATION 50 2T 99-02, BW'S ORIGINAL 50 2T 99-00, BW'S ORIGINAL 50 2T 99-02, JOG 50 2T 92-01, JOG ER 50 2T 00-02, JOG Z 50 2T 95-95, NEO'S 50 2T 97-02, RS SPY 50 2T 95-98, SLIDER 50 2T 00-02, WHY 50 2T 98-05, ZEST 50 2T 95-92, ZUMA 50 2T 97-01



◀ cod. **9921210**
Centralina digitale ad anticipo variabile per scooter 50 cc

APPLICABILITÀ

MALAGUTI CIAK EURO 2,2,3 50 2T 03-03, F10 EURO 2,2,3 50 2T 03-04, F12 PHANTOM EURO 2,2,3 50 2T 03-04, F12 PHANTOM LC EURO 2,2,3 50 2T 03-04, F15 FIRE FOX EURO 2,2,3 50 2T 03-04



◀ cod. **9921690**
Centralina digitale ad anticipo variabile per motori Minarelli AM6 con volano Ducati 6 poli

APPLICABILITÀ

APRILIA CLASSIC 50 2T 92-99, EUROPA 50 2T 91-92, MX 50 2T 04-04, MX MOTARD 50 2T 95-03, PEGASO 50 2T 92-94, RS 50 2T 91-05, RX 50 2T 03-04, RX 3-5 MARCE 50 2T 91-94, RX ENDURO 50 2T 95-03, RX RACING 50 2T 03-06, TUONO 50 2T 03-04

CH HUSQVARNA SM 50 2T 00-10, WR 50 2T 00-10, WSM 50 2T 00-10

FANTIC CABALLERO MOTARD 50 2T 06-10, CABALLERO REGOLARITÀ 50 2T 06-10

HM CRE SIX, BAIÀ, DERAPAGE 50 2T 95-05

MALAGUTI CNK DRAGON 50 2T 05-07, FIFTY EVOLUTION 50 2T 90-93, XSM 50 2T 03-03, XTM 50 2T 03-03

MBK X LIMIT 50 2T 03-04, X POWER 50 2T 03-04

MOTOR HISPANIA FURIA 50 2T 97-00, FURIA MAX 50 2T 10-12, RX 50 2T 09-12, RX R 50 2T 09-12

PEUGEOT SUPERMOTARD 50 2T 90-02, XP6 TRAIL S/AVV. ELETTRICO 50 2T 90-02, XR6 RACING CAT. C/AVV.ELETT. 50 2T 90-02

RIEJU MRX 50 2T 01-04, MRX PRO 50 2T 01-04, RR 50 2T 05-06, RS1 50 2T 98-01, RS2 MATRIX 50 2T 05-06, RS2 MATRIX PRO 50 2T 05-06, RS2 NAKED 50 2T 04-05, SMX E.S./K.S. 50 2T 01-01, SMX PRO E.S./K.S. 50 2T 03-03, SPIKE 50 2T 98-01

SHERCO HRD ENDURO 50 2T 09-13, HRD MOTARD 50 2T 09-13

YAMAHA DT R 50 2T 03-06, DT RSM 50 2T 03-05, DT X 50 2T 06-06



◀ cod. **9924870**
Centralina con bobina ad anticipo fisso

APPLICABILITÀ

GILERA DNA 50 2T 00-02, DNA GP EXPERIENCE 50 2T 03-04, EASY MOVING 50 2T 95-96, ICE 50 2T 01-05, RUNNER 50 2T 97-00, RUNNER POGGIALI 50 2T 02-02, RUNNER SP 50 2T 02-04, STALKER 50 2T 97-04, STORM 50 2T 94-95, TYPHOON 50 2T 94-97, TYPHOON X 50 2T 98-99, TYPHOON XR 50 2T 00-00

ITALJET JET SET 50 2T 02-02, TORPEDO NEW 50 2T 00-01

PIAGGIO FREE 50 2T 92-94, FREE DELIVERY 50 2T 00-01, FREE FL 50 2T 95-02, LIBERTY 50 2T 97-05, NRG EXTREME LC 50 2T 99-00, NRG MC3 50 2T 01-04, NRG RST MC2 50 2T 96-98, NTT 50 2T 95-96, QUARTZ 50 2T 92-96, SFERA 50 2T 91-93, SFERA MAQUILLAGE 2 50 2T 94-94, SFERA RST 50 2T 95-97, VESPA ET2 50 2T 97-05, ZIP 50 2T 92-93, ZIP 50 2T 95-96, ZIP BIMODALE 50 2T 94-97, ZIP FAST RIDER 50 2T 93-94, ZIP FAST RIDER RST 50 2T 96-97, ZIP RST 50 2T 96-99, ZIP SP 50 2T 96-00



◀ cod. **9924880**
Centralina con bobina ad anticipo variabile

APPLICABILITÀ

GILERA DNA 50 2T 00-02, DNA GP EXPERIENCE 50 2T 03-04, EASY MOVING 50 2T 95-96, ICE 50 2T 01-05, RUNNER 50 2T 97-00, RUNNER POGGIALI 50 2T 02-02, RUNNER SP 50 2T 02-04, STALKER 50 2T 97-04, STORM 50 2T 94-95, TYPHOON 50 2T 94-97, TYPHOON X 50 2T 98-99, TYPHOON XR 50 2T 00-00

ITALJET JET SET 50 2T 02-02, TORPEDO NEW 50 2T 00-01

PIAGGIO FREE 50 2T 92-94, FREE DELIVERY 50 2T 00-01, FREE FL 50 2T 95-02, LIBERTY 50 2T 97-05, NRG EXTREME LC 50 2T 99-00, NRG MC3 50 2T 01-04, NRG RST MC2 50 2T 96-98, NTT 50 2T 95-96, QUARTZ 50 2T 92-96, SFERA 50 2T 91-93, SFERA MAQUILLAGE 2 50 2T 94-94, SFERA RST 50 2T 95-97, VESPA ET2 50 2T 97-05, ZIP 50 2T 92-93, ZIP 50 2T 95-96, ZIP BIMODALE 50 2T 94-97, ZIP FAST RIDER 50 2T 93-94, ZIP FAST RIDER RST 50 2T 96-97, ZIP RST 50 2T 96-99, ZIP SP 50 2T 96-00

RICAMBI

9909940	Chiavetta disassata
---------	---------------------



◀ **cod. 9921790**
Centralina digitale ad anticipo variabile per motori scooter 50 cc Minarelli/Yamaha

APPLICABILITÀ

MBK BOOSTER EURO 2 50 2T 04-04, BOOSTER NG 50 2T 03-03, BOOSTER SPIRIT 50 2T 03-03, BOOSTER SPIRIT EURO2 50 2T 03-03, FLIPPER EURO 2 50 2T 03-03, MACH G 50 2T 02-04, MACH G LC 50 2T 02-04, NITRO EURO 2 50 2T 03-03, OVETTO EURO 2 50 2T 02-02

YAMAHA AEROX 50 2T 04-16, AEROX EURO 2 50 2T 03-03, AEROX NAKED 50 2T 13-16, BW'S 50 2T 04-16, BW'S EASY 50 2T 13-13, BW'S NAKED 50 2T 04-04, BW'S NAKED 50 2T 09-16, BW'S NEXT GENERATION 50 2T 03-06, JOG R EURO2 50 2T 02-02, JOG R EURO2 50 2T 06-15, JOG R LC 50 2T 02-15, NEO'S 50 2T 04-16, NEO'S EASY 50 2T 13-13, NEO'S EURO 2 50 2T 02-02, WHY EURO 2 50 2T 03-05



◀ **cod. 9925780**
Centralina digitale ad anticipo variabile F12 EU2 dal'06

APPLICABILITÀ

MALAGUTI CIAK MASTER EURO 2 50 2T 06-06, F10 RESTYLING EURO 2 50 2T 06-06, F12 R PHANTOM LC 50 2T 07-10, F12 RESTYLING EURO 2 50 2T 06-06, F12 RESTYLING LC EURO 2 50 2T 06-06, F15 FIRE FOX AIR COOLED 50 2T 05-06, F15 FIRE FOX EURO 2 50 2T 04-06



◀ **cod. 9926150**
Centralina digitale ad anticipo variabile per Piaggio 50 4T

APPLICABILITÀ

PIAGGIO FLY 4T 50 4T 05-07, FLY 4T & 25-30 KM/H 50 4T 08-11, FLY 4T MOTORE CHN 50 4T 06-07, LIBERTY 4T 50 4T 00-02, LIBERTY 4T 50 4T 05-08, LIBERTY 4T DELIVERY - SINGLE 50 4T 10-14, LIBERTY 4T DELIVERY TNT 50 4T 09-09, LIBERTY 4T PTT - DOUBLE - NEXIVE 50 4T 09-17, LIBERTY 4T RST 50 4T 04-04, LIBERTY 4T SPORT 50 4T 06-08, LIBERTY MOC 4T & ELLE 50 4T 09-16, VESPA ET4 50 4T 00-05, VESPA LX 4T 50 4T 05-09, ZIP 4T 50 4T 00-13

NOVITÀ



◀ **cod. 9934440**
Centralina digitale "TPR" per AM6 EU4

APPLICABILITÀ

BETA RR 2T 50 EU4 50 2T 18-20, RR 50 RACING EU4 50 2T 18-20
FANTIC ENDURO COMPETITION EU4 50 2T 18-20, ENDURO PERFORMANCE EU4 50 2T 18-20, MOTARD COMPETITION EU4 50 2T 18-20, MOTARD PERFORMANCE EU4 50 2T 18-20
RIEJU MRT 50 EU4 50 2T 18-20, MRT PRO EU4 50 2T 18-20, MRT PRO REPLICA EU4 50 2T 18-20, MRT PRO REPLICA SM EU4 50 2T 18-20, MRT PRO SM EU4 50 2T 18-20, MRT SM EU4 50 2T 18-20, MRT TROPHY EU4 50 2T 18-20, RS3 EU4 50 2T 18-20, RS3 NKD EU4 50 2T 18-20

SHERCO FACTORY SE-R EU4 50 2T 18-20, FACTORY SE-RS EU4 50 2T 18-20, FACTORY SILVER SM-R EU4 50 2T 18-20, FACTORY SILVER SM-RS EU4 50 2T 18-20, FACTORY SM-R EU4 50 2T 18-20, FACTORY SM-RS EU4 50 2T 18-20

VENT BAJA 50 2T 18-20, BAJA RR 50 2T 18-20, DERAPAGE 50 2T 18-20, DERAPAGE RR 50 2T 18-20

RICAMBI

9934460	MAP SWITCH
---------	------------



◀ **cod. 9922900**
Cappuccio candela con resistore

ALBERI A CAMME



◀ **cod. 9927230**
Kit albero a camme per motori Minarelli/Yamaha 125 4v

APPLICABILITÀ

BETA	RR 125 4T-4V 10-17	MOTOR	KN1 125 4T-4V 08-08, MH7 125 4T-4V 08-08, RX-R 125 4T-4V 08-08
FANTIC	CABALLERO MOTARD 125 4T-4V 08-18, CABALLERO REGOLARITÀ 125 4T-4V 08-08	HISPANIA	
HM	CITY 125 4T-4V 11-13, CRE F125X 125 4T-4V 08-09, CRE F125X BAJA 125 4T-4V 10-12, CRE F125X BAJA RR 125 4T-4V 10-12, CRE F125X SIX 125 4T-4V 10-11, CRM F125X 125 4T-4V 08-09, CRM F125X DERAPAGE 125 4T-4V 10-11, CRM F125X DERAPAGE RR 125 4T-4V 10-12, LOCUSTA 125 4T-4V 11-13, CITY 200 4T-4V 11-13, LOCUSTA 200 4T-4V 11-13	RIEJU	MARATHON 125 4T-4V 09-09, MARATHON PRO 125 4T-4V 09-09, MARATHON PRO COMPETITION 125 4T-4V 11-11, RS3 125 4T-4V 11-11
HUSQVARNA	SM 125 4T-4V 10-10, TE 125 4T-4V 10-10	VENT	BAJA 125 4T-4V 18-19, BAJA RR 125 4T-4V 18-19, DERAPAGE 125 4T-4V 18-19, DERAPAGE RR 125 4T-4V 18-19, TRAIL 125 4T-4V 18-19
MBK	CITYLINER EU 125 4T-4V 08-10, SKYCRUISER 125 4T-4V 07-07	YAMAHA	MT 125 4T 4V IE 15-15, MT A 125 4T 4V IE 15-15, WR-R IE 125 4T 4V IE 09-11, WR-X IE 125 4T 4V IE 09-11, WR-X IE 125 4T 4V IE 13-14, X-CITY EU3 125 4T-4V 08-11, X-MAX R 125 4T-4V 06-16, X-MAX R ABS 125 4T-4V 11-11, X-MAX RA ABS 125 4T-4V 13-16, YZF-R A IE 125 4T 4V IE 15-15, YZF-R IE 125 4T 4V IE 08-15

◀ **cod. 9928160**
Albero a camme Yamaha YZF 125 R con kit 183 cc

APPLICABILITÀ

Yamaha YZF-R IE 125 4T 4V IE 08-13

RICAMBI

9928130	REGOLATORE PRESSIONE 3.5 BAR
----------------	------------------------------

CAMBIO COMPLETO



◀ **cod. 9935000**
Cambio completo AM6

RACING

APPLICABILITÀ

APRILIA	CLASSIC 50 2T 92-99, MX 50 2T 04-04, MX MOTARD 50 2T 95-03, RS 50 2T 93-05, RX 50 2T 03-04, RX ENDURO 50 2T 95-03, TUONO 50 2T 03-04	MOTOR	FURIA 50 2T 97-00, FURIA MAX 50 2T 10-12, RX 50 2T 09-12, RX R 50 2T 09-12
BETA	RR 2T 50 EU4 50 2T 18-20, RR 50 RACING EU4 50 2T 18-20, RR ALU 50 2T 08-12, RR ENDURO 50 2T 06-17, RR MOTARD 50 2T 06-17	HISPANIA	
CH HUSQUARNA	SM 50 2T 00-10, WR 50 2T 00-10, WSM 50 2T 00-10	PEUGEOT	SUPERMOTARD 50 2T 90-02, XP6 TRAIL S/AVV. ELETTRICO 50 2T 90-02, XR6 RACING CAT. C/AVV.ELETT. 50 2T 90-02
CMC	ENDURO 50 2T 11-11, MOTARD 50 2T 11-11	RIEJU	MRT 50 2T 09-12, MRT 50 EU4 50 2T 18-20, MRT PRO 50 2T 09-12, MRT PRO EU4 50 2T 18-20, MRT PRO REPLICA EU4 50 2T 18-20, MRT PRO SM 50 2T 09-12, MRT PRO SM EU4 50 2T 18-20, MRT SM 50 2T 09-12, MRT SM EU4 50 2T 18-20, MRT TROPHY EU4 50 2T 18-20, MRX 50 2T 01-04, MRX PRO 50 2T 01-04, RR 50 2T 05-06, RS1 50 2T 98-01, RS2 MATRIX 50 2T 05-06, RS2 MATRIX PRO 50 2T 05-06, RS2 NAKED 50 2T 04-05, RS3 EU4 50 2T 18-20, RS3 NKD EU4 50 2T 18-20, SMX E.S./K.S. 50 2T 01-01, SMX PRO E.S./K.S. 50 2T 03-03, SPIKE 50 2T 98-01
FANTIC	CABALLERO MOTARD 50 2T 06-10, CABALLERO REGOLARITÀ 50 2T 06-10, ENDURO COMPETITION EU4 50 2T 18-20, ENDURO PERFORMANCE EU4 50 2T 18-20, MOTARD COMPETITION EU4 50 2T 18-20, MOTARD PERFORMANCE EU4 50 2T 18-20	SHERCO	FACTORY SE-R EU4 50 2T 18-20, FACTORY SE-RS EU4 50 2T 18-20, FACTORY SILVER SM-R EU4 50 2T 18-20, FACTORY SILVER SM-RS EU4 50 2T 18-20, FACTORY SM-R EU4 50 2T 18-20, FACTORY SM-RS EU4 50 2T 18-20, HRD ENDURO 50 2T 09-13, HRD MOTARD 50 2T 09-13
HM	BAJA, DERAPAGE BASIC 50 2T 10-11, CMC 50 2T 10-11, CRE BAJA RR, DERAPAGE RR 50 2T 07-11, CRE BAJA, DERAPAGE 50 2T 07-11, CRE SIX COMPETITION 50 2T 10-11, CRE SIX, BAJA, DERAPAGE 50 2T 95-06, CRE SIX, DERAPAGE COMPETITION 50 2T 07-09, DERAPAGE COMPETITION 50 2T 10-11	VENT	BAJA 50 2T 18-20, BAJA RR 50 2T 18-20, DERAPAGE 50 2T 18-20, DERAPAGE RR 50 2T 18-20
MALAGUTI	CNK DRAGON 50 2T 05-07, XSM 50 2T 03-03, XTM 50 2T 03-03	YAMAHA	DT R 50 2T 03-11, DT RSM 50 2T 03-05, DT X 50 2T 06-11, TZR 50 2T 03-08, TZR 50 2T 10-10, TZR RR 50 2T 05-05
MBK	X LIMIT 50 2T 03-04, X POWER 50 2T 03-04		
MINARELLI	MOTORE AM 6 1° SERIE 50 2T 96-11, MOTORE AM 6 2° SERIE 50 2T 12-18		

DESMODROMICO CAMBIO

◀ **cod. 9920020**
Desmodromico cambio in "ERGA 55" per motori Minarelli AM6

RACING



APPLICABILITÀ

APRILIA	CLASSIC 50 2T 92-99, MX 50 2T 04-04, RS 50 2T 93-05, RX 50 2T 03-04, TUONO 50 2T 03-04	MOTOR	FURIA 50 2T 97-00, FURIA MAX 50 2T 10-12, RX 50 2T 09-12, RX R 50 2T 09-12
BETA	RR 2T 50 EU4 50 2T 18-20, RR 50 RACING EU4 50 2T 18-20, RR ALU 50 2T 08-12, RR ENDURO 50 2T 06-17, RR MOTARD 50 2T 06-17	HISPANIA	
CH HUSQUARNA	SM 50 2T 00-10, WR 50 2T 00-10, WSM 50 2T 00-10	PEUGEOT	SUPERMOTARD 50 2T 90-02, XP6 TRAIL S/AVV. ELETTRICO 50 2T 90-02, XR6 RACING CAT. C/AVV.ELETT. 50 2T 90-02
CMC	ENDURO 50 2T 11-11, MOTARD 50 2T 11-11	RIEJU	MRT 50 2T 09-12, MRT 50 EU4 50 2T 18-20, MRT PRO 50 2T 09-12, MRT PRO EU4 50 2T 18-20, MRT PRO REPLICA EU4 50 2T 18-20, MRT PRO SM 50 2T 09-12, MRT PRO SM EU4 50 2T 18-20, MRT SM 50 2T 09-12, MRT SM EU4 50 2T 18-20, MRT TROPHY EU4 50 2T 18-20, MRX 50 2T 01-04, MRX PRO 50 2T 01-04, RR 50 2T 05-06, RS1 50 2T 98-01, RS2 MATRIX 50 2T 05-06, RS2 MATRIX PRO 50 2T 05-06, RS2 NAKED 50 2T 04-05, RS3 EU4 50 2T 18-20, RS3 NKD EU4 50 2T 18-20, SMX E.S./K.S. 50 2T 01-01, SMX PRO E.S./K.S. 50 2T 03-03, SPIKE 50 2T 98-01
FANTIC	CABALLERO MOTARD 50 2T 06-10, CABALLERO REGOLARITÀ 50 2T 06-10, ENDURO COMPETITION EU4 50 2T 18-20, ENDURO PERFORMANCE EU4 50 2T 18-20, MOTARD COMPETITION EU4 50 2T 18-20, MOTARD PERFORMANCE EU4 50 2T 18-20	SHERCO	FACTORY SE-R EU4 50 2T 18-20, FACTORY SE-RS EU4 50 2T 18-20, FACTORY SILVER SM-R EU4 50 2T 18-20, FACTORY SILVER SM-RS EU4 50 2T 18-20, FACTORY SM-R EU4 50 2T 18-20, FACTORY SM-RS EU4 50 2T 18-20, HRD ENDURO 50 2T 09-13, HRD MOTARD 50 2T 09-13
HM	BAJA, DERAPAGE BASIC 50 2T 10-11, CMC 50 2T 10-11, CRE BAJA RR, DERAPAGE RR 50 2T 07-11, CRE BAJA, DERAPAGE 50 2T 07-11, CRE SIX COMPETITION 50 2T 10-11, CRE SIX, BAJA, DERAPAGE 50 2T 95-06, CRE SIX, DERAPAGE COMPETITION 50 2T 07-09, DERAPAGE COMPETITION 50 2T 10-11	VENT	BAJA 50 2T 18-20, BAJA RR 50 2T 18-20, DERAPAGE 50 2T 18-20, DERAPAGE RR 50 2T 18-20
MALAGUTI	CNK DRAGON 50 2T 05-07, XSM 50 2T 03-03, XTM 50 2T 03-03	YAMAHA	DT R 50 2T 03-11, DT RSM 50 2T 03-05, DT X 50 2T 06-11, TZR 50 2T 03-08, TZR 50 2T 10-11, TZR RR 50 2T 05-05
MBK	X LIMIT 50 2T 03-04, X POWER 50 2T 03-04		
MINARELLI	MOTORE AM 6 1° SERIE 50 2T 96-11, MOTORE AM 6 2° SERIE 50 2T 12-18		

ATTENZIONE: QUESTI PRODOTTI SONO DESTINATI ESCLUSIVAMENTE AD USO AGONISTICO. NE È QUINDI VIETATO L'UTILIZZO SU STRADA PUBBLICA.



◀ **cod. 9921280**
Albero motore competizione corsa 40,2 mm con ralle
Per motore scooter 50 cc Minarelli/Yamaha tipo orizzontale A.C. e L.C.

RICAMBI

9914540	Gabbia a rulli	9921410	Biella completa
---------	----------------	---------	-----------------



◀ **cod. 9921720** **RACING**
Albero motore corsa 39 mm a piattelli pieni per motori Minarelli AM6

APPLICABILITÀ

APRILIA	CLASSIC 50 2T 92-99, EUROPA 50 2T 91-92, MX 50 2T 04-04, MX MOTARD 50 2T 95-03, PEGASO 50 2T 92-94, RS 50 2T 91-05, RX 50 2T 03-04, RX 3-5 MARCE 50 2T 91-94, RX ENDURO 50 2T 95-03, RX RACING 50 2T 03-06, TUONO 50 2T 03-04	MINARELLI	MOTORE AM 3-4-5 50 2T 91-95, MOTORE AM 6 1° SERIE 50 2T 96-11, MOTORE AM 6 2° SERIE 50 2T 12-18
BETA	RR 2T 50 EU4 50 2T 18-20, RR 50 RACING EU4 50 2T 18-20, RR ALU 50 2T 08-12, RR ENDURO 50 2T 06-17, RR MOTARD 50 2T 06-17	MOTOR HISPANIA	FURIA 50 2T 97-00, FURIA MAX 50 2T 10-12, RX 50 2T 09-12, RX R 50 2T 09-12
CH HUSQUARNA	SM 50 2T 00-10, WR 50 2T 00-10, WSM 50 2T 00-10	PEUGEOT	SUPERMOTARD 50 2T 90-02, XP6 TRAIL S/AVV. ELETTRICO 50 2T 90-02, XR6 RACING CAT. C/AVV.ELETT. 50 2T 90-02
CMC	ENDURO 50 2T 11-11, MOTARD 50 2T 11-11	RIEJU	MRT 50 2T 09-12, MRT 50 EU4 50 2T 18-20, MRT PRO 50 2T 09-12, MRT PRO EU4 50 2T 18-20, MRT PRO REPLICA EU4 50 2T 18-20, MRT PRO REPLICA SM EU4 50 2T 18-20, MRT PRO SM 50 2T 09-12, MRT PRO SM EU4 50 2T 18-20, MRT SM 50 2T 09-12, MRT SM EU4 50 2T 18-20, MRT TROPHY EU4 50 2T 18-20, MRX 50 2T 01-04, MRX PRO 50 2T 01-04, RR 50 2T 05-06, RS1 50 2T 98-01, RS2 MATRIX 50 2T 05-06, RS2 MATRIX PRO 50 2T 05-06, RS2 NAKED 50 2T 04-05, RS3 EU4 50 2T 18-20, RS3 NKD EU4 50 2T 18-20, SMX E.S./K.S. 50 2T 01-01, SMX PRO E.S./K.S. 50 2T 03-03, SPIKE 50 2T 98-01
FANTIC	CABALLERO MOTARD 50 2T 06-10, CABALLERO REGOLARITÀ 50 2T 06-10, ENDURO COMPETITION EU4 50 2T 18-20, ENDURO PERFORMANCE EU4 50 2T 18-20, MOTARD COMPETITION EU4 50 2T 18-20, MOTARD PERFORMANCE EU4 50 2T 18-20	SHERCO	FACTORY SE-R EU4 50 2T 18-20, FACTORY SE-RS EU4 50 2T 18-20, FACTORY SILVER SM-R EU4 50 2T 18-20, FACTORY SILVER SM-RS EU4 50 2T 18-20, FACTORY SM-R EU4 50 2T 18-20, FACTORY SM-RS EU4 50 2T 18-20, HRD ENDURO 50 2T 09-13, HRD MOTARD 50 2T 09-13
HM	BAJA, DERAPAGE BASIC 50 2T 10-11, CMC 50 2T 10-11, CRE BAJA RR, DERAPAGE RR 50 2T 07-11, CRE BAJA, DERAPAGE 50 2T 07-11, CRE SIX COMPETITION 50 2T 10-11, CRE SIX, BAIA, DERAPAGE 50 2T 95-06, CRE SIX, DERAPAGE COMPETITION 50 2T 07-09, DERAPAGE COMPETITION 50 2T 10-11	VENT	BAJA 50 2T 18-20, BAJA RR 50 2T 18-20, DERAPAGE 50 2T 18-20, DERAPAGE RR 50 2T 18-20
MALAGUTI	CNK DRAGON 50 2T 05-07, FIFTY EVOLUTION 50 2T 90-93, XSM 50 2T 03-03, XTM 50 2T 03-03	YAMAHA	DT R 50 2T 03-11, DT RSM 50 2T 03-05, DT X 50 2T 06-11, TZR 50 2T 03-08, TZR 50 2T 10-11, TZR RR 50 2T 05-05
MBK	X LIMIT 50 2T 03-04, X POWER 50 2T 03-04		

RICAMBI

9924750	Kit cuscinetti paraoli banco	IM07036	Biella
9921330	Gabbia a rulli		



◀ **cod. 9925910** **RACING**
Albero motore completo "TPR" corsa 39,2 spinotto Ø 10 per motore scooter 50 cc Minarelli/Yamaha tipo orizzontale con cuscinetti

RICAMBI

9914540	Gabbia a rulli	9925920	Biella spinotto Ø 10
KK01002	Kit cuscinetti e paraoli		



◀ **cod. 9926180** **RACING**
Albero motore completo "TPR" corsa 39,3 spinotto Ø 12
Per motore scooter 50 cc Piaggio/Gilera con cuscinetti

RICAMBI

9907820	Gabbia a rulli	9926190	Biella spinotto Ø 12
KK01009	Kit cuscinetti e paraoli		



cod. **9927900** **RACING**

Albero motore completo "TPR" corsa 39,2 spinotto Ø 10 per motore scooter 50 cc Minarelli/Yamaha tipo verticale con cuscinetti

RICAMBI

9914540	Gabbia a rulli
KK01002	Kit cuscinetti paraoli

9925920	Biella spinotto Ø 10
---------	----------------------



cod. **9928320** **RACING**

Albero motore completo "TPR" corsa 39,2 spinotto Ø 12 per motore scooter 50 cc Minarelli/Yamaha tipo orizzontale con cuscinetti

RICAMBI

9907820	Gabbia a rulli
KK01002	Kit cuscinetti paraoli

9929490	Biella spinotto Ø 12
---------	----------------------

NOVITÀ



cod. **9930150** **RACING**

Albero motore "TPR" corsa std per Derbi (d50b0) + cuscinetti e paraoli

APPLICABILITÀ

APRILIA RS 50 2T 06-10, RS4 50 2T 11-13, RS4 REPLICA 50 2T 14-16, RX 50 2T 06-10, RX 50 2T 14-16, SX 50 2T 06-16, SX LIMITED EDITION 50 2T 14-16

DERBI GPR 2T 50 2T 13-13, GPR 2T EU2 50 2T 09-10, GPR NUDE & GPR NUDE TUNING 50 2T 06-08, GPR NUDE SPORT 50 2T 06-06, GPR R EU2 - GPR REPLICA EU2 50 2T 08-08, GPR RACING EU2 50 2T 06-06, GPR REPLICA & GPR R EU2 50 2T 06-06, GPR REPLICA 2T MALOSSI 50 2T 07-07, GPR REPLICA PESEK EU2 50 2T 07-07, SENDA HYP DRD EVO EU2 50 2T 08-09, SENDA HYP DRD EVO LIMITED EDITION EU2 50 2T 08-08, SENDA R DRD PRO EU2 50 2T 05-11, SENDA R DRD RACING EU2 50 2T 05-08, SENDA R DRD X-TREME 2T EU2 50 2T 14-15, SENDA R DRD X-TREME 2T EURO2 50 2T 10-12, SENDA R X-RACE 2T EU2 50 2T 10-10, SENDA R X-RACE EU2 50 2T 06-09, SENDA R X-TREME 2T EU2 50 2T 10-10, SENDA R X-TREME EU2 50 2T 05-08, SENDA SM DRD PRO EU2 50 2T 05-11, SENDA SM DRD PRO EU2 2VER 50 2T 05-08, SENDA SM DRD RACING EU2 50 2T 05-08, SENDA SM DRD RACING EU2 50 2T 10-13, SENDA SM DRD RACING LTD EU2 50 2T 07-07, SENDA SM DRD X-TREME 2T EU2 50 2T 14-15, SENDA SM DRD X-TREME 2T EU2 LIMITED ED 50 2T 14-15, SENDA SM X-RACE 2T EU2 50 2T 10-10, SENDA SM X-RACE EU2 50 2T 06-09, SENDA SM X-RACE EU2 2VER 50 2T 07-09, SENDA SM X-TREME 2T EU2 50 2T 10-10, SENDA SM X-TREME EU2 50 2T 05-08

GILERA RCR 50 2T 06-07, RCR 50 2T 11-12, RCR (CHE-SYC) 50 2T 13-15, SMT 50 2T 06-17, SMT RACING 50 2T 11-12

VALENTI RACING RME 50 2T 15-17, SM 50 2T 15-17

RICAMBI

AA00766	Gabbia su spinotto d.12X15x15 AM6-Derbi
KK01008	Kit cuscin/paraoli banco Derbi plurimarc



cod. **9924940**

RACING

Campane frizione "TPR" Ø 107 per motore scooter 50 cc Minarelli/Yamaha orizzontale

APPLICABILITÀ

APRILIA AREA 51 50 2T 98-00, GULLIVER 50 2T 95-98, GULLIVER LC 50 2T 96-98, RALLY 50 2T 95-03, RALLY LIQUID COOLED 50 2T 96-99, SCARABEO 50 2T 93-05, SONIC 50 2T 98-07, SONIC GP 50 2T 98-08, SR (ORIZZONTALE) 50 2T 94-96, SR LIQUID COOLED 50 2T 94-96, SR RACING 50 2T 97-99, SR STEALTH 50 2T 97-00, SR WWW 50 2T 97-01

ATALA CAROSELLO 50 2T 99-01

BENELLI 491 GT 50 2T 98-99, 491 NAKED 50 2T 02-02, 491 RACING 50 2T 98-99, 491 RR 50 2T 99-01, 491 SP 50 2T 99-99, 491 SPORT 50 2T 98-99, 491 ST 50 2T 99-01, K2 50 2T 98-01, K2 LIQUID COOLED 50 2T 98-01, PEPE 50 2T 99-01, PEPE LX 50 2T 03-04

BETA ARK 50 2T 96-08, ARK LC 50 2T 96-08, CHRONO 50 2T 95-96, EIKON 50 2T 99-03, QUADRA 50 2T 95-95, QUADRA 50 2T 99-01, TEMPO 50 2T 93-02, TEMPO 50 2T 95-95

ITALJET DRAGSTER 50 2T 98-02

KTM K50 50 2T 96-01

MACAL THUNDER 50 2T 95-96

MALAGUTI CENTRO SL 50 2T 94-98, CIAK 50 2T 99-01, CIAK EURO 2 2,3 50 2T 03-03, CIAK EURO2 50 2T 01-03, CIAK MASTER EURO 2 50 2T 06-06, F10 50 2T 92-00, F10 EURO 2 50 2T 02-06, F10 EURO 2 2,3 50 2T 03-04, F10 RESTYLING EURO 2 50 2T 06-06, F12 PHANTOM 50 2T 94-98, F12 PHANTOM EURO 2 2,3 50 2T 03-04, F12 PHANTOM LC 50 2T 94-98, F12 R PHANTOM LC 50 2T 07-10, F12 RESTYLING EURO 2 50 2T 06-06, F15 FIRE FOX 50 2T 96-98, F15 FIRE FOX AIR COOLED 50 2T 05-06, F15 FIRE FOX EURO 2 50 2T 02-06, F15 FIRE FOX EURO 2 2,3 50 2T 03-04, YESTERDAY 50 2T 97-00

MBK EVOLIS 50 2T 92-95, FIZZ 50 2T 94-95, FLIPPER 50 2T 98-04, FLIPPER EURO 2 50 2T 03-03, FORTE 50 2T 94-96, MACH G 50 2T 02-04, MACH G LC 50 2T 02-04, NITRO 50 2T 97-04, NITRO EURO 2 50 2T 03-03, OVETTO 50 2T 97-04, OVETTO EURO 2 50 2T 02-02

MOTRON SYNCRO 50 2T 98-00, THUNDER 50 2T 95-98

RIEJU FIRST 50 2T 95-98, WINDY 50 2T 95-98

YAMAHA AEROX 50 2T 97-02, AEROX 50 2T 04-16, AEROX EURO 2 50 2T 03-03, AEROX NAKED 50 2T 13-16, AEROX R 50 2T 99-00, AEROX R 50 2T 99-99, AXIS 50 2T 95-96, BREEZE 50 2T 94-95, JOG 50 2T 92-01, JOG R 50 2T 02-02, JOG R EURO2 50 2T 02-02, JOG R EURO2 50 2T 06-15, JOG R LC 50 2T 02-15, NEO'S 50 2T 97-02, NEO'S 50 2T 04-16, NEO'S EASY 50 2T 13-13, NEO'S EURO 2 50 2T 02-02, WHY 50 2T 98-05, WHY EURO 2 50 2T 03-05



cod. **9924950**

RACING

Campane frizione "TPR" Ø 107 scooter 50 cc Piaggio

APPLICABILITÀ

APRILIA MOJITO CUSTOM 2T MOTORE PIAGGIO 50 2T 04-10, SCARABEO 2T EU2 MOTORE PIAGGIO 50 2T 10-12, SCARABEO 2T NET 50 2T 09-10, SCARABEO 4T 50 4T 02-06, SCARABEO 4T 4V 50 4T-4V 10-12, SCARABEO 4T 4V NET 50 4T-4V 09-10, SCARABEO 4T RESTYLING EU3 50 4T 06-09, SCARABEO QUATTRO 50 4T-4V 09-09, SCARABEO STREET 50 2T 05-06, SCARABEO STREET 2T RESTYLING 50 2T 06-09, SPORT CITY ONE 2T 50 2T 08-11, SPORT CITY ONE 4T 50 4T 08-10, SR MOTARD 50 2T 12-14, SR 50 2T 04-09, SR R FACTORY CARBURATORE 50 2T 10-14, SR R FACTORY IE 50 2T 10-14, SR STREET CARBURATORE 50 2T 03-12

DERBI ATLANTIS 2T 50 2T 10-10, ATLANTIS 2T EU2 50 2T 07-09, ATLANTIS O2 50 2T 02-02, ATLANTIS O2 BULLET 50 2T 03-05, ATLANTIS O2 CITY 50 2T 04-06, ATLANTIS O2 RED BULLET 50 2T 03-03, ATLANTIS O2 TWO CHIC 50 2T 05-05, BOULEVARD 2T 50 2T 09-14, GP1 50 2T 01-03, GP1 EU 2 50 2T 05-05, GP1 OPEN EU2 50 2T 06-09, GP1 RACE EU2 50 2T 05-07, SONAR 2T 50 2T 09-09

GILERA DNA 50 2T 00-02, DNA 50 2T 05-07, DNA GP EXPERIENCE 50 2T 03-04, EASY MOVING 50 2T 95-96, ICE 50 2T 01-05, RUNNER 50 2T 97-00, RUNNER POGGIALI 50 2T 02-02, RUNNER PURE JET 50 2T-IE 02-07, RUNNER PURE JET 50 2T-IE 10-11, RUNNER PURE JET ST 50 2T-IE 08-08, RUNNER SP 50 2T 02-07, RUNNER SP 50 2T 10-12, RUNNER SP SPECIAL EDITION 50 2T 07-07, RUNNER SP ST & SIMONCELLI 50 2T 08-09, STALKER 50 2T 97-11, STALKER NAKED 50 2T 08-08, STALKER SPECIAL EDITION 50 2T 07-08, STORM 50 2T 94-95, STORM EURO 2 50 2T 07-07, TYPHOON 50 2T 94-97, TYPHOON X 50 2T 98-99, TYPHOON XR 50 2T 00-00

ITALJET JET SET 50 2T 02-02, TORPEDO NEW 50 2T 00-01

PIAGGIO DIESIS 50 2T 01-01, FLY 2T 50 2T 05-07, FLY 2T 50 2T 10-11, FREE 50 2T 92-94, FREE DELIVERY 50 2T 00-01, FREE FL 50 2T 95-02, LIBERTY 50 2T 97-05, LIBERTY 2T 50 2T 06-08, LIBERTY 2T PTT EU2 50 2T 04-05, LIBERTY 2T RST 50 2T 04-04, LIBERTY 2T SPORT 50 2T 06-08, LIBERTY 4T 3V IE 50 4T-3V 15-17, LIBERTY 4T 3V IE E4 50 4T-3V 17-18, LIBERTY MOC 2T & ELLE 50 2T 09-13, NRG 50 2T 94-96, NRG EXTREME LC 50 2T 99-00, NRG MC3 50 2T 01-04, NRG POWER DD 50 2T 05-17, NRG POWER DD SERIE SPECIALE 50 2T 07-12, NRG POWER DT 50 2T 06-15, NRG POWER DT SERIE SPECIALE 50 2T 07-08, NRG POWER PUREJET 50 2T-IE 04-11, NRG PUREJET 50 2T-IE 02-04, NRG PUREJET 50 2T-IE 10-10, NRG RST MC2 50 2T 96-98, NTT 50 2T 95-96, QUARTZ 50 2T 92-96, SFERA 50 2T 91-93, SFERA MAQUILLAGE 2 50 2T 94-94, SFERA RST 50 2T 95-97, TYPHOON 50 2T 01-11, TYPHOON 2T E2 50 2T 10-12, TYPHOON 2T E3 CH 50 2T 11-11, VESPA ET2 50 2T 97-05, VESPA ET2 INIEZIONE 50 2T 97-00, VESPA LX 2T 50 2T 05-13, VESPA LX 2T TOURING & 30KM 50 2T 10-13, VESPA LXV 2T 50 2T 06-09, VESPA LXV 2T NAVY 50 2T 08-08, VESPA S 2T & COLLEGE 50 2T 07-12, ZIP 50 2T 92-93, ZIP 50 2T 95-96, ZIP 2T 50 2T 08-13, ZIP BIMODALE 50 2T 94-97, ZIP FAST RIDER 50 2T 93-94, ZIP FAST RIDER RST 50 2T 96-97, ZIP LC 50 2T 00-04, ZIP RST 50 2T 96-99, ZIP SP 50 2T 96-04, ZIP SP EURO 2 50 2T 06-13

CARICA BATTERIE



◀ cod. **9934160**
Professional Battery Charger



◀ cod. **9980060**
Carica batterie 12V per scooter

CARICATORI USB



◀ cod. **9980070**
Caricatore USB Presa Singola (2A - Cavo 0,5 m)



◀ cod. **9980080**
Caricatore USB Presa Doppia (5A - Cavo 3 m)

CONTAGIRI



◀ cod. **9931400**
Contagiri digitale con contaore

KIT DI PROGRAMMAZIONE



◀ cod. **9927340**
Kit programmazione centralina TFI
Per programmare le centraline iniezione. Consente la sostituzione delle mappe di iniezione all'interno delle centraline.

APPLICABILITÀ

MBK CITYLINER EU3 125 4T-4V 08-10, SKYCRUISER 125 4T-4V 07-07

YAMAHA WR-R IE 125 4T 4V IE 09-11, WR-X IE 125 4T 4V IE 09-11, WR-X IE 125 4T 4V IE 13-14, X-CITY EU3 125 4T-4V 08-11, X-MAX R 125 4T-4V 06-16, X-MAX R ABS 125 4T-4V 11-11, X-MAX RA ABS 125 4T-4V 13-16, YZF-R IE 125 4T 4V IE 08-13



◀ cod. **9929180**

RACING

Cuscinetti ad alte prestazioni con sfere maggiorate e anelli carbonitrurati ad elevata scorrevolezza
Serie 2 cuscinetti | Misure: 17 x 47 x 14 | Sigla: 6303ETN9HN1C3H | Adattabile a motori Minarelli AM345/6

◀ cod. **9929190**

RACING

Cuscinetti ad alte prestazioni con sfere maggiorate e anelli carbonitrurati ad elevata scorrevolezza
Serie 2 cuscinetti | Misure: 20 x 47 x 14 | Sigla: 6204ETN9HN1C3H | Adattabile a motori scooter 50 cc Minarelli/Yamaha

◀ cod. **9929300**

RACING

Cuscinetti ad alte prestazioni con sfere maggiorate e anelli carbonitrurati ad elevata scorrevolezza
Serie 2 cuscinetti | Misure: 17 x 47 x 14 - 20 x 47 x 14 | Adattabile ad alberi motore "TPR" cod. 9920410 - 9921720



◀ cod. **9929200**

RACING

Cuscinetti ad alte prestazioni con sfere maggiorate e anelli carbonitrurati ad elevata scorrevolezza
Serie 2 cuscinetti | Misure: 20 x 52 x 12 | Sigla: BB1BB1447205AHN1
Adattabile a motori scooter 50 cc. Piaggio/Gilera/Derbi

SCOOTER 50 cc



◀ cod. **9907770**



Cinghia di trasmissione per motori scooter 50 cc Minarelli/Yamaha

RIFERIMENTO ORIGINALE

Aprilia	AP8206109
Benelli	R16140011A0

Yamaha	5RNE76411000
--------	--------------

APPLICABILITÀ: SCOOTER 50 CC

APRILIA AMICO 50 2T 94-94, AMICO 50 2T 96-98, AMICO GL/GLE 50 2T 93-95, AMICO LX/SPORT/CAT 50 2T 92-93, AREA 51 50 2T 98-00, GULLIVER 50 2T 95-98, GULLIVER LC 50 2T 96-98, RALLY 50 2T 95-03, RALLY LIQUID COOLED 50 2T 96-99, SCARABEO 50 2T 93-05, SR (ORIZZONTALE) 50 2T 94-96, SR (VERTICALE) 50 2T 93-93, SR LIQUID COOLED 50 2T 94-96, SR RACING 50 2T 97-99, SR STEALTH 50 2T 97-00, SR WWW 50 2T 97-01

ATALA CAROSELLO 50 2T 99-01

BENELLI 491 GT 50 2T 98-99, 491 NAKED 50 2T 02-02, 491 RACING 50 2T 98-99, 491 RR 50 2T 99-01, 491 SP 50 2T 99-99, 491 SPORT 50 2T 98-99, 491 ST 50 2T 99-01, K2 50 2T 98-01, K2 LIQUID COOLED 50 2T 98-01, PEPE 50 2T 99-01, PEPE LX 50 2T 03-04

BETA ARK 50 2T 96-08, ARK LC 50 2T 96-08, CHRONO 50 2T 95-96, EIKON 50 2T 99-03, QUADRA 50 2T 95-95, QUADRA 50 2T 99-01, TEMPO 50 2T 93-02, TEMPO 50 2T 95-95

ITALJET DRAGSTER 50 2T 98-02, PISTA 2.50 2T 97-98, SCOOP 2.50 2T 96-98, YANKEE 50 2T 93-97

KTM K50 50 2T 96-01

MACAL THUNDER 50 2T 95-96

MALAGUTI CENTRO SL 50 2T 94-98, CIAK 50 2T 99-01, CIAK EURO 2.2.3 50 2T 03-03, CIAK EURO2 50 2T 01-03, CIAK MASTER EURO 2.50 2T 06-06, F12 PHANTOM 50 2T 94-98, F12 PHANTOM EURO 2.50 2T 02-02, F12 PHANTOM EURO 2.2.3 50 2T 03-04, F12 PHANTOM LC 50 2T 94-98, F12 PHANTOM LC EURO 2.2.3 50 2T 03-04, F12 R PHANTOM LC 50 2T 07-10, F12 RESTYLING EURO 1.50 2T 99-02, F12 RESTYLING EURO 2.50 2T 06-06, F12 RESTYLING LC EURO 2.50 2T 06-06, F15 FIRE FOX 50 2T 96-98, F15 FIRE FOX AIR COOLED 50 2T 05-06, F15 FIRE FOX EURO 2.50 2T 02-06, F15 FIRE FOX EURO 2.2.3 50 2T 03-04

MBK BOOSTER 50 2T 90-04, BOOSTER 50 2T 90-94, BOOSTER EURO 2.50 2T 04-04, BOOSTER NG 50 2T 95-03, BOOSTER ROCKET 50 2T 97-98, BOOSTER SPIRIT 50 2T 96-00, BOOSTER SPIRIT 50 2T 03-03, BOOSTER SPIRIT EURO2 50 2T 03-03, BOOSTER TRACK 50 2T 96-98, FLIPPER 50 2T 98-04, FLIPPER EURO 2.50 2T 03-03, MACH G 50 2T 02-04, MACH G LC 50 2T 02-04, NITRO 50 2T 97-04, NITRO EURO 2.50 2T 03-03, OVETTO 50 2T 97-04, OVETTO EURO 2.50 2T 02-02, STUNT 50 2T 00-02

MOTRON SYNCRO 50 2T 98-00, THUNDER 50 2T 95-98

RIEJU FIRST 50 2T 95-98, WINDY 50 2T 95-98

YAMAHA AEROX 50 2T 97-02, AEROX 50 2T 04-16, AEROX EURO 2.50 2T 03-03, AEROX NAKED 50 2T 13-16, AEROX R 50 2T 99-00, AEROX R 50 2T 99-99, BW'S 50 2T 97-16, BW'S BUMP 50 2T 97-98, BW'S EASY 50 2T 13-13, BW'S NAKED 50 2T 03-04, BW'S NAKED 50 2T 09-16, BW'S NEXT GENERATION 50 2T 97-00, BW'S NEXT GENERATION 50 2T 99-06, BW'S ORIGINAL 50 2T 99-00, BW'S ORIGINAL 50 2T 99-02, BW'S ORIGINAL EURO 2.50 2T 03-03, JOG R 50 2T 02-02, JOG R EURO2 50 2T 02-02, JOG R EURO2 50 2T 06-15, JOG R LC 50 2T 02-15, NEO'S 50 2T 97-02, NEO'S 50 2T 04-16, NEO'S EASY 50 2T 13-13, NEO'S EURO 2.50 2T 02-02, RS SPY 50 2T 95-98, SLIDER 50 2T 00-02, WHY 50 2T 98-05, WHY EURO 2.50 2T 03-05, ZUMA 50 2T 97-01

◀ cod. **9907900**



Cinghia di trasmissione per motori scooter 50 cc Minarelli/Yamaha tipo orizzontale corto

RIFERIMENTO ORIGINALE

Aprilia	AP8206818
---------	-----------

Yamaha	3WF176410000
--------	--------------

APPLICABILITÀ: SCOOTER 50 cc - ATV QUAD

APRILIA SONIC 50 2T 98-07, SONIC GP 50 2T 98-08

DINLI HELIX DL603 50 2T 07-13, HELIX DL603 90 50 2T 07-13, T-REX 50 2T 07-13

E-TON VIPER RXL 50 2T 06-06

LAVERDA QUASAR 50 2T 02-04

MALAGUTI F10 50 2T 92-00, F10 EURO 2.50 2T 02-06, F10 EURO 2.2.3 50 2T 03-04, F10 RESTYLING EURO 2.50 2T 06-06, YESTERDAY 50 2T 97-00

MBK EVOLIS 50 2T 92-95, FIZZ 50 2T 94-95, FORTE 50 2T 94-96

YAMAHA AXIS 50 2T 95-96, BREEZE 50 2T 94-95, CRZ 50 2T 91-95, JOG 50 2T 92-01, ZEST 50 2T 95-92

◀ cod. **9910790**



Cinghia di trasmissione per motori scooter 50 cc Peugeot

RIFERIMENTO ORIGINALE

Peugeot	729171
---------	--------

APPLICABILITÀ

PEUGEOT BUXY 50 2T 90-02, BUXY RS 50 2T 90-02, ELYSEO 50 2T 90-02, JET FORCE 50 2T 90-02, LUDIX 50 2T 90-02, SPEEDAKE 50 2T 90-02, SPEEDFIGHT 50 2T 97-04, SPEEDFIGHT LC 50 2T 97-04, SQUAB 50 2T 90-02, TREKKER 50 2T 90-02, VIVACITY 50 2T 90-02, X-FIGHT 50 2T 00-02

SCOOTER 50 cc



◀ cod. **9913280**
Cinghia di trasmissione per motori scooter 50 cc Piaggio

RIFERIMENTO ORIGINALE

Benelli	R030424102000
Garelli	GA06570
Garelli	GA02165
Gilera	430728

Keeway	24107B01F000
Malaguti	59015000
Piaggio	430728

APPLICABILITÀ: SCOOTER 50 cc - ATV QUAD

BENELLI PEPE 50 2T 10-10, PEPE LX 50 2T 07-09, PEPE OLD 50 2T 07-09, PEPE OLD 50 2T 11-11, QUATTRONONEX 50 2T 08-11 CPI: ARAGON 50 2T 03-03, HUSSAR 50 2T 03-03, OLIVER 50 2T 03-03, POP CORN 50 2T 03-03

EXPLORER CRACKER 50 2T 03-03

GARELLI TIESSE 2T 50 2T 08-08, VIP 50 4T 06-06

GILERA STORM 50 2T 94-95, TYPHOON 50 2T 94-97, TYPHOON X 50 2T 98-99

HUPPER MONTECARLO 30 50 2T 09-09

KEEWAY ATV EC2 50 2T 06-06, ATV OFF ROAD 50 2T 07-07, F-ACT 50 2T 07-08, FLASH 50 2T 07-08, FOCUS 50 2T 06-06, GOCCIA 50 2T 09-09, HURRICANE 50 2T 06-08, MATRIX 50 2T 06-08, PIXEL EURO 2 50 2T 09-12, RY8 50 2T 08-08

MALAGUTI F10 AC WAP 50 2T 08-08, F12 R PHANTOM AC 50 2T 07-08

PIAGGIO FREE 50 2T 92-94, FREE FL 50 2T 95-02, NRG 50 2T 94-96, NRG RST MC2 50 2T 96-98, NTT 50 2T 95-96

◀ cod. **9913350**
Cinghia di trasmissione per motori scooter 50 cc Piaggio

RIFERIMENTO ORIGINALE

Piaggio	431190
---------	--------

APPLICABILITÀ

GILERA EASY MOVING 50 2T 95-96

PIAGGIO QUARTZ 50 2T 92-96, SFERA RST 50 2T 95-97, ZIP 50 2T 95-96, ZIP BIMODALE 50 2T 94-97, ZIP FAST RIDER 50 2T 93-94, ZIP FAST RIDER RST 50 2T 96-97, ZIP RST 50 2T 96-99, ZIP SP 50 2T 96-00

◀ cod. **9913360**
Cinghia di trasmissione per motori scooter 50 cc Piaggio

RIFERIMENTO ORIGINALE

Piaggio	286175
---------	--------

APPLICABILITÀ

PIAGGIO SFERA 50 2T 91-93, ZIP 50 2T 92-93

◀ cod. **9920440**
Cinghia di trasmissione per motori scooter 50 cc Aprilia Ditech

RIFERIMENTO ORIGINALE

Aprilia	AP2MCA000014
---------	--------------

APPLICABILITÀ

APRILIA HABANA-MOJITO CUSTOM 50 2T 99-03, HABANA-MOJITO RETRO* 50 2T 99-03, SCARABEO DITECH 50 2T-IE 01-04, SR DITECH EU2 50 2T-IE 02-04, SR H2O DITECH 50 2T-IE 00-04, SR R FACTORY MOTORE APRILIA 50 2T-IE 05-05

Suzuki KATANA K1-K4 50 2T 01-04, KATANA V-Y 50 2T 97-00, ZIL-LION UX 50 2T 99-99

Sym SYMPHONY EURO 2 50 4T 09-09

SCOOTER 50 cc



◀ cod. **9922030** 
Cinghia di trasmissione per motori scooter 50 cc Piaggio

RIFERIMENTO ORIGINALE

Piaggio	436864
---------	--------

APPLICABILITÀ

APRILIA	MOJITO CUSTOM 2T MOTORE PIAGGIO 50 2T 04-10, SR MOTARD 50 2T 12-14, SR R 50 2T 04-09, SR R FACTORY CARBURATORE 50 2T 10-14, SR R FACTORY IE 50 2T 10-14, SR STREET CARBURATORE 50 2T 03-12	GILERA	ICE 50 2T 01-05, RUNNER 50 2T 97-00, RUNNER PURE JET 50 2T-IE 02-04, RUNNER SP 50 2T 02-06, STALKER 50 2T 97-11, STALKER NAKED 50 2T 08-08, STALKER SPECIAL EDITION 50 2T 07-08, STORM EURO 2 50 2T 07-07, TYPHOON XR 50 2T 00-00
DERBI	ATLANTIS 2T 50 2T 10-10, ATLANTIS 2T EU2 50 2T 07-09, ATLANTIS 02 50 2T 02-02, ATLANTIS 02 BULLET 50 2T 03-05, ATLANTIS 02 CITY 50 2T 04-06, ATLANTIS 02 RED BULLET 50 2T 03-03, ATLANTIS 02 TWO CHIC 50 2T 05-05, GP1 50 2T 01-03, GP1 EU 2 50 2T 05-05, GP1 OPEN EU2 50 2T 06-09, GP1 RACE EU2 50 2T 05-07	ITALJET PIAGGIO	JET SET 50 2T 02-02, TORPEDO NEW 50 2T 00-01 DIESIS 50 2T 01-01, FREE DELIVERY 50 2T 00-01, NRG MC3 50 2T 01-04, NRG POWER DD 50 2T 05-17, NRG POWER DD SERIE SPECIALE 50 2T 07-12, NRG POWER DT 50 2T 06-15, NRG POWER DT SERIE SPECIALE 50 2T 07-08, NRG PUREJET 50 2T-IE 02-04, TYPHOON 50 2T 01-11

◀ cod. **9922040** 
Cinghia di trasmissione per motori scooter 50 cc Piaggio

RIFERIMENTO ORIGINALE

Piaggio	82645R
---------	--------

APPLICABILITÀ

PIAGGIO	VESPA ET2 INIEZIONE 50 2T 97-00, VESPA ET4 50 4T 00-05, VESPA LX 2T 50 2T 05-13, VESPA LX 2T TOURING & 30KM 50 2T 10-13, VESPA LX 4T 50 4T 05-09, VESPA LX 4T 4V 50 4T-4V 09-13, VESPA LX 4T 4V TOURING 50 4T-4V 10-13, VESPA LXV 2T 50 2T 06-09, VESPA LXV 2T NAVY 50 2T 08-08, VESPA S 2T & COLLEGE 50 2T 07-12, VESPA S 4T 4V & COLLEGE 50 4T-4V 08-12, ZIP 2T 50 2T 08-13, ZIP 4T 50 4T 00-13, ZIP LC 50 2T 00-04, ZIP SP 50 2T 01-04, ZIP SP EURO 2 50 2T 06-13, ZIP 4T 100 4T 06-10
----------------	---

◀ cod. **9931580** 
Cinghia di trasmissione per motori scooter 50 cc Honda Vision

RIFERIMENTO ORIGINALE

Honda	23100GGP901
-------	-------------

APPLICABILITÀ

HONDA	VISION 50 2T 88-95
--------------	--------------------

◀ cod. **9931590** 
Cinghia di trasmissione per motori scooter 50 cc Kymco

RIFERIMENTO ORIGINALE

Kymco	00107541
-------	----------

APPLICABILITÀ

KYMCO	AGILITY 4T CARRY 50 4T 11-11, AGILITY 4T R12 50 4T 07-08, AGILITY PLUS 4T 50 4T 14-14, AGILITY R12 50 4T 05-05, AGILITY R12 ECS 50 4T 16-16, AGILITY R16 50 4T 08-09, AGILITY R16 50 4T 12-12, AGILITY R16 2T 50 2T 10-10, AGILITY R16 2T 50 2T 12-12, AGILITY RS 50 4T 09-09, AGILITY RS NAKED 50 2T 10-10, B&W 50 2T 02-02, B&W EU2 50 2T 03-03, DINK AC 50 2T 98-02, DINK LC 50 2T 98-02, DINK 50 4T 50 4T 07-07, DINK CLASSIC EU2 50 2T 03-03, LIKE 50 4T 09-09, PEOPLE 50 2T 99-04, PEOPLE EURO 2 50 2T 03-03, PEOPLE EURO 2 50 2T 08-08, PEOPLE EURO 2 50 2T 11-11, PEOPLE S 50 2T 05-08, PEOPLE S 4T 50 4T 06-08, SUPER 8 50 2T 09-09, SUPER 8 4T 50 4T 07-07, SUPER 8 4T 50 4T 09-09, SUPER 9 50 2T 00-00, SUPER 9 EU2 50 2T 03-03, TOP BOY 50 2T 97-00, VITALITY 2T 50 2T 04-04, VITALITY 4T 50 4T 04-04, YUP 50 2T 02-02, YUP EU2 50 2T 03-03
--------------	---

CINGHIA DI TRASMISSIONE POMPA ACQUA / MISCELATORE

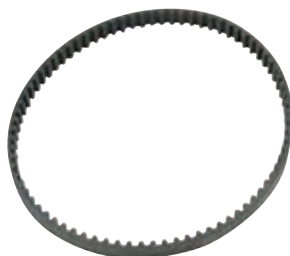

◀ cod. **9933440**
Cinghia Pompa Acqua/Miscelatore Scooter Piaggio 50 cc



cod. 9923030
Convertitore di coppia per motori scooter 50 cc Minarelli/Yamaha

APPLICABILITÀ

- APRILIA** AMICO 50 2T 94-94, AMICO 50 2T 96-98, AMICO GL/GLE 50 2T 93-95, AMICO LX/SPORT/CAT 50 2T 92-93, AREA 51 50 2T 98-00, GULLIVER 50 2T 95-98, GULLIVER LC 50 2T 96-98, RALLY 50 2T 95-03, RALLY LIQUID COOLED 50 2T 96-99, SCARABEO 50 2T 93-05, SONIC 50 2T 98-07, SONIC GP 50 2T 98-08, SR (ORIZZONTALE) 50 2T 94-96, SR (VERTICALE) 50 2T 93-93, SR LIQUID COOLED 50 2T 94-96, SR RACING 50 2T 97-99, SR STEALTH 50 2T 97-00, SR WWW 50 2T 97-01
- ATALA** CAROSELLO 50 2T 99-01
- BENELLI** 491 GT 50 2T 98-99, 491 NAKED 50 2T 02-02, 491 RACING 50 2T 98-99, 491 RR 50 2T 99-01, 491 SP 50 2T 99-99, 491 SPORT 50 2T 98-99, 491 ST 50 2T 99-01, K2 50 2T 98-01, K2 LIQUID COOLED 50 2T 98-01, PEPE 50 2T 99-01, PEPE 50 2T 10-10, PEPE LX 50 2T 03-04, PEPE LX 50 2T 07-09, PEPE OLD 50 2T 07-09, PEPE OLD 50 2T 11-11, QUATTRONEX 50 2T 08-11
- BETA** ARK 50 2T 96-08, ARK LC 50 2T 96-08, CHRONO 50 2T 95-96, EIKON 50 2T 99-03, QUADRA 50 2T 95-95, QUADRA 50 2T 99-01, TEMPO 50 2T 93-02, TEMPO 50 2T 95-95
- CPI** ARAGON 50 2T 03-03, HUSSAR 50 2T 03-03, OLIVER 50 2T 03-03, POP CORN 50 2T 03-03
- EXPLORER** CRACKER 50 2T 03-03
- ITALJET** DRAGSTER 50 2T 98-02
- KTM** K50 50 2T 96-01
- KEEWAY** ATV EC2 50 2T 06-06, ATV OFF ROAD 50 2T 07-07, F-ACT 50 2T 07-08, FLASH 50 2T 07-08, FOCUS 50 2T 06-06, GOCCIA 50 2T 09-09, HURRICANE 50 2T 06-08, MATRIX 50 2T 06-08, PIXEL EURO 2 50 2T 09-12, RY8 50 2T 08-08
- MACAL** THUNDER 50 2T 95-96

- MALAGUTI** CENTRO SL 50 2T 94-98, CIAK 50 2T 99-01, CIAK EURO 2 2,3 50 2T 03-03, CIAK EURO2 50 2T 01-03, CIAK MASTER EURO 2 50 2T 06-06, F10 50 2T 92-00, F10 AC WAP 50 2T 08-08, F10 EURO 2 50 2T 02-06, F10 EURO 2 2,3 50 2T 03-04, F10 RESTYLING EURO 2 50 2T 06-06, F12 PHANTOM 50 2T 94-98, F12 PHANTOM EURO 2 50 2T 02-02, F12 PHANTOM EURO 2 2,3 50 2T 03-04, F12 PHANTOM LC 50 2T 94-98, F12 PHANTOM LC EURO 2 2,3 50 2T 03-04, F12 R PHANTOM AC 50 2T 07-08, F12 R PHANTOM LC 50 2T 07-10, F12 RESTYLING EURO 1 50 2T 99-02, F12 RESTYLING EURO 2 50 2T 06-06, F12 RESTYLING LC EURO 2 50 2T 06-06, F15 FIRE FOX 50 2T 96-98, F15 FIRE FOX AIR COOLED 50 2T 05-06, F15 FIRE FOX EURO 2 50 2T 02-06, F15 FIRE FOX EURO 2 2,3 50 2T 03-04, YESTERDAY 50 2T 97-00
- MBK** BOOSTER 50 2T 90-04, BOOSTER 50 2T 90-94, BOOSTER EURO 2 50 2T 04-04, BOOSTER NG 50 2T 95-03, BOOSTER ROCKET 50 2T 97-98, BOOSTER SPIRIT 50 2T 96-00, BOOSTER SPIRIT 50 2T 03-03, BOOSTER SPIRIT EURO2 50 2T 03-03, BOOSTER TRACK 50 2T 96-98, EVOLIS 50 2T 92-95, FIZZ 50 2T 94-95, FLIPPER 50 2T 98-04, FLIPPER EURO 2 50 2T 03-03, FORTE 50 2T 94-96, MACH G 50 2T 02-04, MACH G LC 50 2T 02-04, NITRO 50 2T 97-04, NITRO EURO 2 50 2T 03-03, OVETTO 50 2T 97-04, OVETTO EURO 2 50 2T 02-02, STUNT 50 2T 00-02
- MOTRON** SYNCRO 50 2T 98-00, THUNDER 50 2T 95-98
- RIEJU** FIRST 50 2T 95-98, WINDY 50 2T 95-98
- YAMAHA** AEROX 50 2T 97-02, AEROX 50 2T 04-16, AEROX EURO 2 50 2T 03-03, AEROX NAKED 50 2T 13-16, AEROX R 50 2T 99-00, AEROX R 50 2T 99-99, AXIS 50 2T 95-96, BREEZE 50 2T 94-95, BW'S 50 2T 97-16, BW'S BUMP 50 2T 97-98, BW'S EASY 50 2T 13-13, BW'S NAKED 50 2T 03-04, BW'S NAKED 50 2T 09-16, BW'S NEXT GENERATION 50 2T 97-00, BW'S NEXT GENERATION 50 2T 99-06, BW'S ORIGINAL 50 2T 99-00, BW'S ORIGINAL 50 2T 99-02, BW'S ORIGINAL EURO 2 50 2T 03-03, JOG 50 2T 92-01, JOG R 50 2T 02-02, JOG R EURO2 50 2T 02-02, JOG R EURO2 50 2T 06-15, JOG R LC 50 2T 02-15, NEO'S 50 2T 97-02, NEO'S 50 2T 04-16, NEO'S EASY 50 2T 13-13, NEO'S EURO 2 50 2T 02-02, RS SPY 50 2T 95-98, SLIDER 50 2T 00-02, WHY 50 2T 98-05, WHY EURO 2 50 2T 03-05, ZEST 50 2T 95-92, ZUMA 50 2T 97-01

RICAMBI

9913790	Molla (carico 26 kg)
---------	----------------------



cod. 9923150
Convertitore di coppia per motori scooter 50 cc Piaggio

APPLICABILITÀ

- APRILIA** MOJITO CUSTOM 2T MOTORE PIAGGIO 50 2T 04-10, SCARABEO 2T EU2 MOTORE PIAGGIO 50 2T 10-12, SCARABEO 2T NET 50 2T 09-10, SCARABEO 4T 50 4T 02-06, SCARABEO 4T 4V 50 4T-4V 10-12, SCARABEO 4T 4V NET 50 4T-4V 09-10, SCARABEO 4T RESTYLING EU3 50 4T 06-09, SCARABEO QUATTRO 50 4T-4V 09-09, SCARABEO STREET 50 2T 05-06, SCARABEO STREET 2T RESTYLING 50 2T 06-09, SPORT CITY ONE 2T 50 2T 08-11, SPORT CITY ONE 4T 50 4T 08-10, SR MOTARD 50 2T 12-14, SR R 50 2T 04-09, SR R FACTORY CARBURATORE 50 2T 10-14, SR R FACTORY IE 50 2T 10-14, SR STREET CARBURATORE 50 2T 03-12
- DERBI** ATLANTIS 2T 50 2T 10-10, ATLANTIS 2T EU2 50 2T 07-09, ATLANTIS O2 50 2T 02-02, ATLANTIS O2 BULLET 50 2T 03-05, ATLANTIS O2 CITY 50 2T 04-06, ATLANTIS O2 RED BULLET 50 2T 03-03, ATLANTIS O2 TWO CHIC 50 2T 05-05, BOULEVARD 2T 50 2T 09-14, GP1 50 2T 01-03, GP1 EU 2 50 2T 05-05, GP1 OPEN EU2 50 2T 06-09, GP1 RACE EU2 50 2T 05-07, SONAR 2T 50 2T 09-09
- GILERA** EASY MOVING 50 2T 95-96, ICE 50 2T 01-05, RUNNER 50 2T 97-00, RUNNER PURE JET 50 2T-IE 02-07, RUNNER PURE JET 50 2T-IE 10-11, RUNNER SP 50 2T 02-06, STALKER 50 2T 97-11, STALKER NAKED 50 2T 08-08, STALKER SPECIAL EDITION 50 2T 07-08, STORM 50 2T 94-95, STORM EURO 2 50 2T 07-07, TYPHOON 50 2T 94-97, TYPHOON X 50 2T 98-99, TYPHOON XR 50 2T 00-00
- ITALJET** JET SET 50 2T 02-02, TORPEDO NEW 50 2T 00-01

- PIAGGIO** DIESIS 50 2T 01-01, FLY 2T 50 2T 05-07, FLY 2T 50 2T 10-11, FLY 4T 50 4T 05-07, FLY 4T & 25-30 KM/H 50 4T 08-11, FLY 4T MOTORE CHN 50 4T 06-07, FREE 50 2T 92-94, FREE DELIVERY 50 2T 00-01, FREE FL 50 2T 95-02, LIBERTY 50 2T 97-05, LIBERTY 2T 50 2T 06-08, LIBERTY 2T PTT EU2 50 2T 04-05, LIBERTY 2T RST 50 2T 04-04, LIBERTY 2T SPORT 50 2T 06-08, LIBERTY 4T 50 4T 00-02, LIBERTY 4T 50 4T 05-08, LIBERTY 4T DELIVERY - SINGLE 50 4T 10-14, LIBERTY 4T DELIVERY TNT 50 4T 09-09, LIBERTY 4T PTT - DOUBLE - NEXIVE 50 4T 09-17, LIBERTY 4T RST 50 4T 04-04, LIBERTY 4T SPORT 50 4T 06-08, LIBERTY MOC 2T & ELLE 50 2T 09-13, LIBERTY MOC 4T & ELLE 50 4T 09-16, NRG 50 2T 94-96, NRG EXTREME LC 50 2T 99-00, NRG MC3 50 2T 01-04, NRG POWER DD 50 2T 05-17, NRG POWER DD SERIE SPECIALE 50 2T 07-12, NRG POWER DT 50 2T 06-15, NRG POWER DT SERIE SPECIALE 50 2T 07-08, NRG POWER PUREJET 50 2T-IE 04-11, NRG PUREJET 50 2T-IE 02-04, NRG PUREJET 50 2T-IE 10-10, NRG RST MC2 50 2T 96-98, NTT 50 2T 95-96, QUARTZ 50 2T 92-96, SFERA 50 2T 91-93, SFERA MAQUILLAGE 2 50 2T 94-94, SFERA RST 50 2T 95-97, TYPHOON 50 2T 01-11, TYPHOON 2T E2 50 2T 10-12, TYPHOON 2T E3 CH 50 2T 11-11, VESPA ET2 50 2T 97-05, VESPA ET2 INIEZIONE 50 2T 97-00, VESPA ET4 50 4T 00-05, VESPA LX 2T 50 2T 05-13, VESPA LX 2T TOURING & 30KM 50 2T 10-13, VESPA LX 4T 50 4T 05-09, VESPA LX 4T 4V 50 4T-4V 09-13, VESPA LX 4T 4V TOURING 50 4T-4V 10-13, VESPA LXV 2T 50 2T 06-09, VESPA LXV 2T NAVY 50 2T 08-08, VESPA S 2T & COLLEGE 50 2T 07-12, VESPA S 4T 4V & COLLEGE 50 4T-4V 08-12, ZIP 50 2T 92-93, ZIP 50 2T 95-96, ZIP 2T 50 2T 08-13, ZIP 4T 50 4T 00-13, ZIP BIMODALE 50 2T 94-97, ZIP FAST RIDER 50 2T 93-94, ZIP FAST RIDER RST 50 2T 96-97, ZIP LC 50 2T 00-04, ZIP RST 50 2T 96-99, ZIP SP 50 2T 96-04, ZIP SP EURO 2 50 2T 06-13

RICAMBI

9912590	Molla (carico 37 kg)
---------	----------------------



cod. 9930200 **RACING**

Coperchio trasmissione con raffreddamento forzato
Per motori serie Minarelli/Yamaha 50 cc tipo orizzontale lungo

APPLICABILITÀ

APRILIA	AREA 51 50 2T 98-00, GULLIVER 50 2T 95-98, GULLIVER LC 50 2T 96-98, RALLY 50 2T 95-03, RALLY LIQUID COOLED 50 2T 96-99, SCARABEO 50 2T 93-05, SR (ORIZZONTALE) 50 2T 94-96, SR LIQUID COOLED 50 2T 94-96, SR RACING 50 2T 97-99, SR STEALTH 50 2T 97-00, SR WWW 50 2T 97-01	MALAGUTI	CENTRO SL 50 2T 94-98, CIAK 50 2T 99-01, CIAK EURO 2 2,3 50 2T 03-03, CIAK EURO2 50 2T 01-03, CIAK MASTER EURO 2 50 2T 06-06, F12 PHANTOM 50 2T 94-98, F12 PHANTOM EURO 2 2,3 50 2T 03-04, F12 PHANTOM LC 50 2T 94-98, F12 R PHANTOM LC 50 2T 07-10, F12 RESTYLING EURO 2 50 2T 06-06, F15 FIRE FOX 50 2T 96-98, F15 FIRE FOX AIR COOLED 50 2T 05-06, F15 FIRE FOX EURO 2 50 2T 02-06, F15 FIRE FOX EURO 2 2,3 50 2T 03-04
ATALA	CAROSELLO 50 2T 99-01	MBK	FLIPPER 50 2T 98-04, FLIPPER EURO 2 50 2T 03-03, MACH G 50 2T 02-04, MACH G LC 50 2T 02-04, NITRO 50 2T 97-04, NITRO EURO 2 50 2T 03-03, OVETTO 50 2T 97-04, OVETTO EURO 2 50 2T 02-02
BENELLI	491 GT 50 2T 98-99, 491 NAKED 50 2T 02-02, 491 RACING 50 2T 98-99, 491 RR 50 2T 99-01, 491 SP 50 2T 99-99, 491 SPORT 50 2T 98-99, 491 ST 50 2T 99-01, K2 50 2T 98-01, K2 LIQUID COOLED 50 2T 98-01, PEPE 50 2T 99-01, PEPE LX 50 2T 03-04	MOTRON	SYNCR0 50 2T 98-00, THUNDER 50 2T 95-98
BETA	ARK 50 2T 96-08, ARK LC 50 2T 96-08, CHRONO 50 2T 95-96, EIKON 50 2T 99-03, QUADRA 50 2T 95-95, QUADRA 50 2T 99-01, TEMPO 50 2T 93-02, TEMPO 50 2T 95-95	RIEJU	FIRST 50 2T 95-98, WINDY 50 2T 95-98
ITALJET	DRAGSTER 50 2T 98-02	YAMAHA	AEROX 50 2T 97-02, AEROX 50 2T 04-16, AEROX EURO 2 50 2T 03-03, AEROX NAKED 50 2T 13-16, AEROX R 50 2T 99-00, AEROX R 50 2T 99-99, JOG R 50 2T 02-02, JOG R EURO2 50 2T 02-02, JOG R EURO2 50 2T 06-15, JOG R LC 50 2T 02-15, NEO'S 50 2T 97-02, NEO'S 50 2T 04-16, NEO'S EASY 50 2T 13-13, NEO'S EURO 2 50 2T 02-02, WHY 50 2T 98-05, WHY EURO 2 50 2T 03-05
KTM	K50 50 2T 96-01		
MACAL	THUNDER 50 2T 95-96		

RICAMBI

9915420	Scodellino dentato
---------	--------------------



cod. 9930300 **RACING**

Coperchio scatola ingranaggi Nardó
Per tutti i motori di derivazione Minarelli/Yamaha 50 cc di tipo orizzontale lungo e verticale

APPLICABILITÀ

APRILIA	AMICO 50 2T 94-94, AMICO 50 2T 96-98, AMICO GL/GLE 50 2T 93-95, AMICO LX/SPORT/CAT 50 2T 92-93, AREA 51 50 2T 98-00, GULLIVER 50 2T 95-98, GULLIVER LC 50 2T 96-98, RALLY 50 2T 95-03, RALLY LIQUID COOLED 50 2T 96-99, SCARABEO 50 2T 93-05, SR (ORIZZONTALE) 50 2T 94-96, SR (VERTICALE) 50 2T 93-93, SR LIQUID COOLED 50 2T 94-96, SR RACING 50 2T 97-99, SR STEALTH 50 2T 97-00, SR WWW 50 2T 97-01	MBK	BOOSTER 50 2T 90-04, BOOSTER 50 2T 90-94, BOOSTER EURO 2 50 2T 04-04, BOOSTER NG 50 2T 95-03, BOOSTER ROCKET 50 2T 97-98, BOOSTER SPIRIT 50 2T 96-00, BOOSTER SPIRIT 50 2T 03-03, BOOSTER SPIRIT EURO2 50 2T 03-03, BOOSTER TRACK 50 2T 96-98, FLIPPER 50 2T 98-04, FLIPPER EURO 2 50 2T 03-03, MACH G 50 2T 02-04, MACH G LC 50 2T 02-04, NITRO 50 2T 97-04, NITRO EURO 2 50 2T 03-03, OVETTO 50 2T 97-04, OVETTO EURO 2 50 2T 02-02, STUNT 50 2T 00-02
ATALA	CAROSELLO 50 2T 99-01	MOTRON	SYNCR0 50 2T 98-00, THUNDER 50 2T 95-98
BENELLI	491 GT 50 2T 98-99, 491 NAKED 50 2T 02-02, 491 RACING 50 2T 98-99, 491 RR 50 2T 99-01, 491 SP 50 2T 99-99, 491 SPORT 50 2T 98-99, 491 ST 50 2T 99-01, K2 50 2T 98-01, K2 LIQUID COOLED 50 2T 98-01, PEPE 50 2T 99-01, PEPE LX 50 2T 03-04	RIEJU	FIRST 50 2T 95-98, WINDY 50 2T 95-98
BETA	ARK 50 2T 96-08, ARK LC 50 2T 96-08, CHRONO 50 2T 95-96, EIKON 50 2T 99-03, QUADRA 50 2T 95-95, QUADRA 50 2T 99-01, TEMPO 50 2T 93-02, TEMPO 50 2T 95-95	YAMAHA	AEROX 50 2T 97-02, AEROX 50 2T 04-16, AEROX EURO 2 50 2T 03-03, AEROX NAKED 50 2T 13-16, AEROX R 50 2T 99-00, AEROX R 50 2T 99-99, BW'S 50 2T 97-16, BW'S BUMP 50 2T 97-98, BW'S EASY 50 2T 13-13, BW'S NAKED 50 2T 03-04, BW'S NAKED 50 2T 09-16, BW'S NEXT GENERATION 50 2T 97-00, BW'S NEXT GENERATION 50 2T 99-06, BW'S ORIGINAL 50 2T 99-00, BW'S ORIGINAL 50 2T 99-02, BW'S ORIGINAL EURO 2 50 2T 03-03, JOG R 50 2T 02-02, JOG R EURO2 50 2T 02-02, JOG R EURO2 50 2T 06-15, JOG R LC 50 2T 02-15, NEO'S 50 2T 97-02, NEO'S 50 2T 04-16, NEO'S EASY 50 2T 13-13, NEO'S EURO 2 50 2T 02-02, RS SPY 50 2T 95-98, SLIDER 50 2T 00-02, WHY 50 2T 98-05, WHY EURO 2 50 2T 03-05, ZUMA 50 2T 97-01
ITALJET	DRAGSTER 50 2T 98-02		
KTM	K50 50 2T 96-01		
MACAL	THUNDER 50 2T 95-96		
MALAGUTI	CENTRO SL 50 2T 94-98, CIAK 50 2T 99-01, CIAK EURO 2 2,3 50 2T 03-03, CIAK EURO2 50 2T 01-03, CIAK MASTER EURO 2 50 2T 06-06, F12 PHANTOM 50 2T 94-98, F12 PHANTOM EURO 2 50 2T 02-02, F12 PHANTOM EURO 2 2,3 50 2T 03-04, F12 PHANTOM LC 50 2T 94-98, F12 PHANTOM LC EURO 2 2,3 50 2T 03-04, F12 R PHANTOM LC 50 2T 07-10, F12 RESTYLING EURO 1 50 2T 99-02, F12 RESTYLING EURO 2 50 2T 06-06, F12 RESTYLING LC EURO 2 50 2T 06-06, F15 FIRE FOX 50 2T 96-98, F15 FIRE FOX AIR COOLED 50 2T 05-06, F15 FIRE FOX EURO 2 50 2T 02-06, F15 FIRE FOX EURO 2 2,3 50 2T 03-04		



cod. **9910020**

Frizione alleggerita per tutti i motori scooter 50 cc. Minarelli, Yamaha, Piaggio, Gilera, Derbi, Peugeot, Honda, con campana Ø interno 107 mm

APPLICABILITÀ

- | | | |
|---|--|--|
| <p>APRILIA AMICO 50 2T 94-94, AMICO 50 2T 96-98, AMICO GL/GLE 50 2T 93-95, AMICO LX/SPORT/CAT 50 2T 92-93, AREA 51 50 2T 98-00, GULLIVER 50 2T 95-98, GULLIVER LC 50 2T 96-98, MOJITO CUSTOM 2T MOTORE PIAGGIO 50 2T 04-10, RALLY 50 2T 95-03, RALLY LIQUID COOLED 50 2T 96-99, SCARABEO 50 2T 93-05, SCARABEO 2T EU2 MOTORE PIAGGIO 50 2T 10-12, SCARABEO 2T NET 50 2T 09-10, SCARABEO 4T 50 4T 02-06, SCARABEO 4T 4V 50 4T-4V 10-12, SCARABEO 4T 4V NET 50 4T-4V 09-10, SCARABEO 4T RESTYLING EU3 50 4T 06-09, SCARABEO QUATTRO 50 4T-4V 09-09, SCARABEO STREET 50 2T 05-06, SCARABEO STREET 2T RESTYLING 50 2T 06-09, SONIC 50 2T 98-07, SONIC GP 50 2T 98-08, SPORT CITY ONE 2T 50 2T 08-11, SPORT CITY ONE 4T 50 4T 08-10, SR (ORIZZONTALE) 50 2T 94-96, SR (VERTICALE) 50 2T 93-93, SR LIQUID COOLED 50 2T 94-96, SR MOTARD 50 2T 12-14, SR R 50 2T 04-09, SR R FACTORY CARBURATORE 50 2T 10-14, SR R FACTORY IE 50 2T 10-14, SR RACING 50 2T 97-99, SR STEALTH 50 2T 97-00, SR STREET CARBURATORE 50 2T 03-12, SR WWW 50 2T 97-01</p> <p>ATALA CAROSELLO 50 2T 99-01</p> <p>BENELLI 491 GT 50 2T 98-99, 491 NAKED 50 2T 02-02, 491 RACING 50 2T 98-99, 491 RR 50 2T 99-01, 491 SP 50 2T 99-99, 491 SPORT 50 2T 98-99, 491 ST 50 2T 99-01, K2 50 2T 98-01, K2 LIQUID COOLED 50 2T 98-01, PEPE 50 2T 99-01, PEPE LX 50 2T 03-04</p> <p>BETA ARK 50 2T 96-08, ARK LC 50 2T 96-08, CHRONO 50 2T 95-96, EIKON 50 2T 99-03, QUADRA 50 2T 95-95, QUADRA 50 2T 99-01, TEMPO 50 2T 93-02, TEMPO 50 2T 95-95</p> <p>BSV DIO GP 50 2T 94-96, DIO SP 50 2T 94-96, DIO ZX 50 2T 94-96</p> <p>DERBI ATLANTIS 2T 50 2T 10-10, ATLANTIS 2T EU2 50 2T 07-09, ATLANTIS O2 50 2T 02-02, ATLANTIS O2 BULLET 50 2T 03-05, ATLANTIS O2 CITY 50 2T 04-06, ATLANTIS O2 RED BULLET 50 2T 03-03, ATLANTIS O2 TWO CHIC 50 2T 05-05, BOULEVARD 2T 50 2T 09-14, GP1 50 2T 01-03, GP1 EU 2 50 2T 05-05, GP1 OPEN EU2 50 2T 06-09, GP1 RACE EU2 50 2T 05-07, SONAR 2T 50 2T 09-09</p> | <p>GILERA DNA 50 2T 00-02, DNA 50 2T 05-07, DNA GP EXPERIENCE 50 2T 03-04, EASY MOVING 50 2T 95-96, ICE 50 2T 01-05, RUNNER 50 2T 97-00, RUNNER POGGIALI 50 2T 02-02, RUNNER SP 50 2T 02-07, RUNNER SP 50 2T 10-12, RUNNER SP SPECIAL EDITION 50 2T 07-07, RUNNER SP ST & SIMONCELLI 50 2T 08-09, STALKER 50 2T 97-11, STALKER NAKED 50 2T 08-08, STALKER SPECIAL EDITION 50 2T 07-08, STORM 50 2T 94-95, STORM EURO 2 50 2T 07-07, TYPHOON 50 2T 94-97, TYPHOON X 50 2T 98-99</p> <p>HSC SC 01 50 2T 94-96, SC 01 L 50 2T 94-96</p> <p>HONDA BALL 50 2T 93-99, DIO ZX 50 2T 94-96, SFX / SXR 50 2T 95-01, SGX SKY 50 2T 97-04, SH NEW 50 2T 96-01</p> <p>ITALJET BAZOOKA 50 2T 91-94, DRAGSTER 50 2T 98-02, JET SET 50 2T 02-02, PISTA 50 2T 92-97, PISTA 2 50 2T 97-98, SCOOP 50 2T 91-95, SCOOP 2 50 2T 96-98, TORPEDO NEW 50 2T 00-01, YANKEE 50 2T 93-97</p> <p>KTM K50 50 2T 96-01</p> <p>KYMCO AGILITY R12 50 4T 05-05</p> <p>MACAL THUNDER 50 2T 95-96</p> <p>MALAGUTI CENTRO SL 50 2T 94-98, CIAK 50 2T 99-01, CIAK EURO 2,2,3 50 2T 03-03, CIAK EURO2 50 2T 01-03, F10 50 2T 92-00, F10 EURO 2 50 2T 02-06, F10 EURO 2,2,3 50 2T 03-04, F12 PHANTOM 50 2T 94-98, F12 PHANTOM EURO 2 50 2T 02-02, F12 PHANTOM EURO 2,2,3 50 2T 03-04, F12 PHANTOM LC 50 2T 94-98, F12 PHANTOM LC EURO 2,2,3 50 2T 03-04, F12 RESTYLING EURO 1 50 2T 99-02, F12 RESTYLING EURO 2 50 2T 06-06, F15 FIRE FOX 50 2T 96-98, F15 FIRE FOX EURO 2 50 2T 02-03, F15 FIRE FOX EURO 2,2,3 50 2T 03-04, YESTERDAY 50 2T 97-00</p> <p>MBK BOOSTER 50 2T 90-04, BOOSTER 50 2T 90-94, BOOSTER EURO 2 50 2T 04-04, BOOSTER NG 50 2T 95-03, BOOSTER ROCKET 50 2T 97-98, BOOSTER SPIRIT 50 2T 96-00, BOOSTER SPIRIT 50 2T 03-03, BOOSTER SPIRIT EURO2 50 2T 03-03, BOOSTER TRACK 50 2T 96-98, FLIPPER 50 2T 98-04, FLIPPER EURO 2 50 2T 03-03, MACH G 50 2T 02-04, MACH G LC 50 2T 02-04, NITRO 50 2T 97-04, NITRO EURO 2 50 2T 03-03, OVETTO 50 2T 97-04, OVETTO EURO 2 50 2T 02-02, SORRISO 50 2T 95-96, STUNT 50 2T 00-02, TARGET 50 2T 91-95</p> <p>MOTRON SYNCRO 50 2T 98-00, THUNDER 50 2T 95-98</p> | <p>PEUGEOT BUXY 50 2T 90-02, BUXY RS 50 2T 90-02, ELYSEO 50 2T 90-02, JET FORCE 50 2T 90-02, LOOKOR 50 2T 90-02, METAL X 50 2T 90-02, SPEEDAKE 50 2T 90-02, SPEEDFIGHT 50 2T 97-04, SPEEDFIGHT LC 50 2T 97-04, SQUAB 50 2T 90-02, SV GEO 50 2T 90-02, TREKKER 50 2T 90-02, VIVACITY 50 2T 90-02, X-FIGHT 50 2T 00-02, ZENITH 50 2T 90-02</p> <p>PIAGGIO DIESES 50 2T 01-01, FLY 2T 50 2T 05-07, FLY 2T 50 2T 10-11, FLY 4T 50 4T 05-07, FLY 4T & 25-30 KM/H 50 4T 08-11, FLY 4T MOTORE CHN 50 4T 06-07, FREE 50 2T 92-94, FREE DELIVERY 50 2T 00-01, LIBERTY 50 2T 97-05, LIBERTY 2T 50 2T 06-08, LIBERTY 2T PTT EU2 50 2T 04-05, LIBERTY 2T RST 50 2T 04-04, LIBERTY 2T SPORT 50 2T 06-08, LIBERTY 4T 50 4T 00-02, LIBERTY 4T 50 4T 05-08, LIBERTY 4T 3V IE 50 4T-3V 15-17, LIBERTY 4T 3V IE E4 50 4T-3V 17-18, LIBERTY 4T DELIVERY - SINGLE 50 4T 10-14, LIBERTY 4T DELIVERY TINT 50 4T 09-09, LIBERTY 4T IGET CORPORATE E4 50 4T-3V 18-18, LIBERTY 4T PTT - DOUBLE - NEXIVE 50 4T 09-17, LIBERTY 4T RST 50 4T 04-04, LIBERTY 4T SPORT 50 4T 06-08, LIBERTY IGET 4T 3V IE E4 EMEA 50 4T-3V 17-18, LIBERTY MOC 2T & ELLE 50 2T 09-13, LIBERTY MOC 4T & ELLE 50 4T 09-16, NRG 50 2T 94-96, NRG POWER DT 50 2T 06-15, NRG POWER DT SERIE SPECIALE 50 2T 07-08, NRG RST MC2 50 2T 96-98, NTT 50 2T 95-96, QUARTZ 50 2T 92-96, SFERA 50 2T 91-93, SFERA MAQUILLAGE 2 50 2T 94-94, SFERA RST 50 2T 95-97, TYPHOON 2T E2 50 2T 10-12, TYPHOON 2T E3 CH 50 2T 11-11, VESPA ET2 50 2T 97-05, VESPA ET4 50 4T 00-05, VESPA PRIMAVERA 4T 3V NOABS E4 50 4T-3V 17-18, VESPA SPRINT 4T 3V E4 50 4T-3V 17-18, ZIP 50 2T 92-93, ZIP 50 2T 95-96, ZIP 4T 50 4T 00-13, ZIP BIMODALE 50 2T 94-97, ZIP FAST RIDER 50 2T 93-94, ZIP FAST RIDER RST 50 2T 96-97, ZIP RST 50 2T 96-99, ZIP SP 50 2T 96-00, WINDY 50 2T 95-98</p> <p>RIEJU YAMAHA AEROX 50 2T 97-02, AEROX 50 2T 04-16, AEROX EURO 2 50 2T 03-03, AEROX NAKED 50 2T 13-16, AEROX R 50 2T 99-00, AEROX R 50 2T 99-99, BW'S 50 2T 97-16, BW'S BUMP 50 2T 97-98, BW'S EASY 50 2T 13-13, BW'S NAKED 50 2T 03-04, BW'S NAKED 50 2T 09-16, BW'S NEXT GENERATION 50 2T 97-00, BW'S NEXT GENERATION 50 2T 99-06, BW'S ORIGINAL 50 2T 99-00, BW'S ORIGINAL 50 2T 99-02, BW'S ORIGINAL EURO 2 50 2T 03-03, CRZ 50 2T 91-95, CT 50 2T 90-95, JOG R 50 2T 02-02, JOG R EURO2 50 2T 02-02, JOG R EURO2 50 2T 06-15, JOG R LC 50 2T 02-15, NEO'S 50 2T 97-02, NEO'S 50 2T 04-16, NEO'S EASY 50 2T 13-13, NEO'S EURO 2 50 2T 02-02, RS SPY 50 2T 95-98, SLIDER 50 2T 00-02, WHY 50 2T 98-05, WHY EURO 2 50 2T 03-05, ZUMA 50 2T 97-01</p> |
|---|--|--|



cod. **9911060**

Frizione alleggerita per tutti i motori scooter 50 cc Minarelli/Yamaha, con campana Ø interno 105 mm

APPLICABILITÀ

- | | | |
|--|---|--|
| <p>APRILIA AMICO 50 2T 94-94, AMICO 50 2T 96-98, AMICO GL/GLE 50 2T 93-95, AMICO LX/SPORT/CAT 50 2T 92-93, AREA 51 50 2T 98-00, GULLIVER 50 2T 95-98, GULLIVER LC 50 2T 96-98, RALLY 50 2T 95-03, RALLY LIQUID COOLED 50 2T 96-99, SCARABEO 50 2T 93-05, SONIC 50 2T 98-07, SONIC GP 50 2T 98-08, SR (ORIZZONTALE) 50 2T 94-96, SR (VERTICALE) 50 2T 93-93, SR LIQUID COOLED 50 2T 94-96, SR RACING 50 2T 97-99, SR STEALTH 50 2T 97-00, SR WWW 50 2T 97-01</p> <p>ATALA CAROSELLO 50 2T 99-01</p> <p>BENELLI 491 GT 50 2T 98-99, 491 NAKED 50 2T 02-02, 491 RACING 50 2T 98-99, 491 RR 50 2T 99-01, 491 SP 50 2T 99-99, 491 SPORT 50 2T 98-99, 491 ST 50 2T 99-01, K2 50 2T 98-01, K2 LIQUID COOLED 50 2T 98-01, PEPE 50 2T 99-01, PEPE LX 50 2T 03-04</p> <p>BETA ARK 50 2T 96-08, ARK LC 50 2T 96-08, CHRONO 50 2T 95-96, EIKON 50 2T 99-03, QUADRA 50 2T 95-95, QUADRA 50 2T 99-01, TEMPO 50 2T 93-02, TEMPO 50 2T 95-95</p> <p>ITALJET BAZOOKA 50 2T 91-94, DRAGSTER 50 2T 98-02, PISTA 50 2T 92-97, PISTA 2 50 2T 97-98, SCOOP 50 2T 91-95, SCOOP 2 50 2T 96-98, YANKEE 50 2T 93-97</p> | <p>KTM K50 50 2T 96-01</p> <p>MACAL THUNDER 50 2T 95-96</p> <p>MALAGUTI CENTRO SL 50 2T 94-98, CIAK 50 2T 99-01, CIAK EURO 2,2,3 50 2T 03-03, CIAK EURO2 50 2T 01-03, F10 50 2T 92-00, F10 EURO 2 50 2T 02-06, F10 EURO 2,2,3 50 2T 03-04, F12 PHANTOM 50 2T 94-98, F12 PHANTOM EURO 2,2,3 50 2T 03-04, F12 PHANTOM LC 50 2T 94-98, F12 PHANTOM LC EURO 2 50 2T 06-06, F15 FIRE FOX 50 2T 96-98, F15 FIRE FOX EURO 2 50 2T 02-03, F15 FIRE FOX EURO 2,2,3 50 2T 03-04, YESTERDAY 50 2T 97-00</p> <p>MBK BOOSTER 50 2T 90-04, BOOSTER 50 2T 90-94, BOOSTER EURO 2 50 2T 04-04, BOOSTER NG 50 2T 95-03, BOOSTER ROCKET 50 2T 97-98, BOOSTER SPIRIT 50 2T 96-00, BOOSTER SPIRIT 50 2T 03-03, BOOSTER SPIRIT EURO2 50 2T 03-03, BOOSTER TRACK 50 2T 96-98, FLIPPER 50 2T 98-04, FLIPPER EURO 2 50 2T 03-03, MACH G 50 2T 02-04, MACH G LC 50 2T 02-04, NITRO 50 2T 97-04, NITRO EURO 2 50 2T 03-03, OVETTO 50 2T 97-04, OVETTO EURO 2 50 2T 02-02, SORRISO 50 2T 95-96, STUNT 50 2T 00-02, TARGET 50 2T 91-95</p> | <p>MOTRON SYNCRO 50 2T 98-00, THUNDER 50 2T 95-98</p> <p>RIEJU YAMAHA AEROX 50 2T 97-02, AEROX 50 2T 04-16, AEROX EURO 2 50 2T 03-03, AEROX NAKED 50 2T 13-16, AEROX R 50 2T 99-00, AEROX R 50 2T 99-99, BW'S 50 2T 97-16, BW'S BUMP 50 2T 97-98, BW'S EASY 50 2T 13-13, BW'S NAKED 50 2T 03-04, BW'S NAKED 50 2T 09-16, BW'S NEXT GENERATION 50 2T 97-00, BW'S NEXT GENERATION 50 2T 99-06, BW'S ORIGINAL 50 2T 99-00, BW'S ORIGINAL 50 2T 99-02, BW'S ORIGINAL EURO 2 50 2T 03-03, CRZ 50 2T 91-95, CT 50 2T 90-95, JOG R 50 2T 02-02, JOG R EURO2 50 2T 02-02, JOG R EURO2 50 2T 06-15, JOG R LC 50 2T 02-15, NEO'S 50 2T 97-02, NEO'S 50 2T 04-16, NEO'S EASY 50 2T 13-13, NEO'S EURO 2 50 2T 02-02, RS SPY 50 2T 95-98, SLIDER 50 2T 00-02, WHY 50 2T 98-05, WHY EURO 2 50 2T 03-05, ZUMA 50 2T 97-01</p> |
|--|---|--|



cod. 9918550 **RACING**

Frizione a denti dritti Z=18/68 per motori Minarelli AM

NB: Montando questa coppia frizione è indispensabile eliminare il miscelatore automatico ed il contagiri meccanico.

RICAMBI

9918510	Ingranaggio pompa acqua condotto Z=30
9920580	Serie molle frizione am rinforz.100 Kg.

APPLICABILITÀ

APRILIA	CLASSIC 50 2T 92-99, EUROPA 50 2T 91-92, MX 50 2T 04-04, MX MOTARD 50 2T 95-03, PEGASO 50 2T 92-94, RS 50 2T 91-05, RX 50 2T 03-04, RX 3-5 MARCE 50 2T 91-94, RX ENDURO 50 2T 95-03, RX RACING 50 2T 03-06, TUONO 50 2T 03-04	MINARELLI	MOTORE AM 3-4-5 50 2T 91-95, MOTORE AM 6 1° SERIE 50 2T 96-11, MOTORE AM 6 2° SERIE 50 2T 12-18
BETA	RR 2T 50 EU4 50 2T 18-20, RR 50 RACING EU4 50 2T 18-20, RR ALU 50 2T 08-12, RR ENDURO 50 2T 06-17, RR MOTARD 50 2T 06-17	MOTOR HISPANIA	FURIA 50 2T 97-00, FURIA MAX 50 2T 10-12, RX 50 2T 09-12, RX R 50 2T 09-12
CH HUSQVARNA	SM 50 2T 00-10, WR 50 2T 00-10, WSM 50 2T 00-10	PEUGEOT	SUPERMOTARD 50 2T 90-02, XP6 TRAIL S/AVV. ELETTRICO 50 2T 90-02, XR6 RACING CAT. C/AVV.ELETT. 50 2T 90-02
CMC	ENDURO 50 2T 11-11, MOTARD 50 2T 11-11	RIEJU	MRT 50 2T 09-12, MRT 50 EU4 50 2T 18-20, MRT PRO 50 2T 09-12, MRT PRO EU4 50 2T 18-20, MRT PRO REPLICA EU4 50 2T 18-20, MRT PRO REPLICA SM EU4 50 2T 18-20, MRT PRO SM 50 2T 09-12, MRT PRO SM EU4 50 2T 18-20, MRT SM 50 2T 09-12, MRT SM EU4 50 2T 18-20, MRT TROPHY EU4 50 2T 18-20, MRX 50 2T 01-04, MRX PRO 50 2T 01-04, RR 50 2T 05-06, RS1 50 2T 98-01, RS2 MATRIX 50 2T 05-06, RS2 MATRIX PRO 50 2T 05-06, RS2 NAKED 50 2T 04-05, RS3 EU4 50 2T 18-20, RS3 NKD EU4 50 2T 18-20, SMX E.S./K.S. 50 2T 01-01, SMX PRO E.S./K.S. 50 2T 03-03, SPIKE 50 2T 98-01
FANTIC	CABALLERO MOTARD 50 2T 06-10, CABALLERO REGOLARITÀ 50 2T 06-10, ENDURO COMPETITION EU4 50 2T 18-20, ENDURO PERFORMANCE EU4 50 2T 18-20, MOTARD COMPETITION EU4 50 2T 18-20, MOTARD PERFORMANCE EU4 50 2T 18-20	SHERCO	FACTORY SE-R EU4 50 2T 18-20, FACTORY SE-RS EU4 50 2T 18-20, FACTORY SILVER SM-R EU4 50 2T 18-20, FACTORY SILVER SM-RS EU4 50 2T 18-20, FACTORY SM-R EU4 50 2T 18-20, FACTORY SM-RS EU4 50 2T 18-20, HRD ENDURO 50 2T 09-13, HRD MOTARD 50 2T 09-13
HM	BAJA, DERAPAGE BASIC 50 2T 10-11, CMC 50 2T 10-11, CRE BAJA RR, DERAPAGE RR 50 2T 07-11, CRE BAJA, DERAPAGE 50 2T 07-11, CRE SIX COMPETITION 50 2T 10-11, CRE SIX, BAJA, DERAPAGE 50 2T 95-06, CRE SIX, DERAPAGE COMPETITION 50 2T 07-09, DERAPAGE COMPETITION 50 2T 10-11	VENT	BAJA 50 2T 18-20, BAJA RR 50 2T 18-20, DERAPAGE 50 2T 18-20, DERAPAGE RR 50 2T 18-20
MALAGUTI	CNK DRAGON 50 2T 05-07, FIFTY EVOLUTION 50 2T 90-93, XSM 50 2T 03-03, XTM 50 2T 03-03	YAMAHA	DT R 50 2T 03-11, DT RSM 50 2T 03-05, DT X 50 2T 06-11, TZR 50 2T 03-08, TZR 50 2T 10-11, TZR RR 50 2T 05-05
MBK	X LIMIT 50 2T 03-04, X POWER 50 2T 03-04		

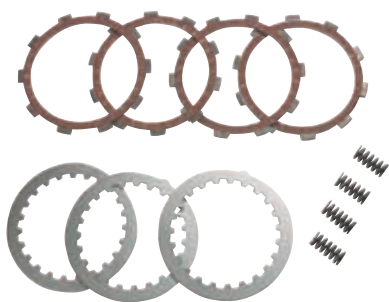

cod. 9920250

Serie dischi frizione AM 345/6

RICAMBI

9920580	Serie molle frizione AM rinforzate 100 kg
---------	---

APPLICABILITÀ

APRILIA	CLASSIC 50 2T 92-99, EUROPA 50 2T 91-92, MX 50 2T 04-04, MX MOTARD 50 2T 95-03, PEGASO 50 2T 92-94, RS 50 2T 91-05, RX 50 2T 03-04, RX 3-5 MARCE 50 2T 91-94, RX ENDURO 50 2T 95-03, RX RACING 50 2T 03-06, TUONO 50 2T 03-04	MOTOR HISPANIA	FURIA 50 2T 97-00, FURIA MAX 50 2T 10-12, RX 50 2T 09-12, RX R 50 2T 09-12
BETA	RR 2T 50 EU4 50 2T 18-20, RR 50 RACING EU4 50 2T 18-20, RR ALU 50 2T 08-12, RR ENDURO 50 2T 06-17, RR MOTARD 50 2T 06-17	PEUGEOT	SUPERMOTARD 50 2T 90-02, XP6 TRAIL S/AVV. ELETTRICO 50 2T 90-02, XR6 RACING CAT. C/AVV.ELETT. 50 2T 90-02
CH HUSQVARNA	SM 50 2T 00-10, WR 50 2T 00-10, WSM 50 2T 00-10	RIEJU	MRT 50 2T 09-12, MRT 50 EU4 50 2T 18-20, MRT PRO 50 2T 09-12, MRT PRO EU4 50 2T 18-20, MRT PRO REPLICA EU4 50 2T 18-20, MRT PRO REPLICA SM EU4 50 2T 18-20, MRT PRO SM 50 2T 09-12, MRT PRO SM EU4 50 2T 18-20, MRT SM 50 2T 09-12, MRT SM EU4 50 2T 18-20, MRT TROPHY EU4 50 2T 18-20, MRX 50 2T 01-04, MRX PRO 50 2T 01-04, RR 50 2T 05-06, RS1 50 2T 98-01, RS2 MATRIX 50 2T 05-06, RS2 MATRIX PRO 50 2T 05-06, RS2 NAKED 50 2T 04-05, RS3 EU4 50 2T 18-20, RS3 NKD EU4 50 2T 18-20, SMX E.S./K.S. 50 2T 01-01, SMX PRO E.S./K.S. 50 2T 03-03, SPIKE 50 2T 98-01
CMC	ENDURO 50 2T 11-11, MOTARD 50 2T 11-11	SHERCO	FACTORY SE-R EU4 50 2T 18-20, FACTORY SE-RS EU4 50 2T 18-20, FACTORY SILVER SM-R EU4 50 2T 18-20, FACTORY SILVER SM-RS EU4 50 2T 18-20, FACTORY SM-R EU4 50 2T 18-20, FACTORY SM-RS EU4 50 2T 18-20, HRD ENDURO 50 2T 09-13, HRD MOTARD 50 2T 09-13
FANTIC	CABALLERO MOTARD 50 2T 06-10, CABALLERO REGOLARITÀ 50 2T 06-10, ENDURO COMPETITION EU4 50 2T 18-20, ENDURO PERFORMANCE EU4 50 2T 18-20, MOTARD COMPETITION EU4 50 2T 18-20, MOTARD PERFORMANCE EU4 50 2T 18-20	VENT	BAJA 50 2T 18-20, BAJA RR 50 2T 18-20, DERAPAGE 50 2T 18-20, DERAPAGE RR 50 2T 18-20
HM	BAJA, DERAPAGE BASIC 50 2T 10-11, CMC 50 2T 10-11, CRE BAJA RR, DERAPAGE RR 50 2T 07-11, CRE BAJA, DERAPAGE 50 2T 07-11, CRE SIX COMPETITION 50 2T 10-11, CRE SIX, BAJA, DERAPAGE 50 2T 95-06, CRE SIX, DERAPAGE COMPETITION 50 2T 07-09, DERAPAGE COMPETITION 50 2T 10-11	YAMAHA	DT R 50 2T 03-11, DT RSM 50 2T 03-05, DT X 50 2T 06-11, TZR 50 2T 03-08, TZR 50 2T 10-11, TZR RR 50 2T 05-05
MALAGUTI	CNK DRAGON 50 2T 05-07, FIFTY EVOLUTION 50 2T 90-93, XSM 50 2T 03-03, XTM 50 2T 03-03		
MBK	X LIMIT 50 2T 03-04, X POWER 50 2T 03-04		
MINARELLI	MOTORE AM 3-4-5 50 2T 91-95, MOTORE AM 6 1° SERIE 50 2T 96-11, MOTORE AM 6 2° SERIE 50 2T 12-18		



cod. 9921180 **RACING**
Serie dischi frizione AM cellulosa/kevlar per motori Minarelli AM

RICAMBI

9920580	Serie molle frizione AM rinforzate 100 KG
---------	---

APPLICABILITÀ

- APRILIA** CLASSIC 50 2T 92-99, EUROPA 50 2T 91-92, MX 50 2T 04-04, MX MOTARD 50 2T 95-03, PEGASO 50 2T 92-94, RS 50 2T 91-05, RX 50 2T 03-04, RX 3-5 MARCE 50 2T 91-94, RX ENDURO 50 2T 95-03, RX RACING 50 2T 03-06, TUONO 50 2T 03-04
- BETA** RR 2T 50 EU4 50 2T 18-20, RR 50 RACING EU4 50 2T 18-20, RR ALU 50 2T 08-12, RR ENDURO 50 2T 06-17, RR MOTARD 50 2T 06-17
- CH HUSQVARNA** SM 50 2T 00-10, WR 50 2T 00-10, WSM 50 2T 00-10
- CMC** ENDURO 50 2T 11-11, MOTARD 50 2T 11-11
- FANTIC** CABALLERO MOTARD 50 2T 06-10, CABALLERO REGOLARITÀ 50 2T 06-10, ENDURO COMPETITION EU4 50 2T 18-20, ENDURO PERFORMANCE EU4 50 2T 18-20, MOTARD COMPETITION EU4 50 2T 18-20, MOTARD PERFORMANCE EU4 50 2T 18-20

- HM** BAJA, DERAPAGE BASIC 50 2T 10-11, CMC 50 2T 10-11, CRE BAJA RR, DERAPAGE RR 50 2T 07-11, CRE BAJA, DERAPAGE 50 2T 07-11, CRE SIX COMPETITION 50 2T 10-11, CRE SIX, BAJA, DERAPAGE 50 2T 95-06, CRE SIX, DERAPAGE COMPETITION 50 2T 07-09, DERAPAGE COMPETITION 50 2T 10-11
- MALAGUTI** CNK DRAGON 50 2T 05-07, FIFTY EVOLUTION 50 2T 90-93, XSM 50 2T 03-03, XTM 50 2T 03-03
- MBK** XLIMIT 50 2T 03-04, X POWER 50 2T 03-04
- MINARELLI** MOTORE AM 3-4-5 50 2T 91-95, MOTORE AM 6 1° SERIE 50 2T 96-11, MOTORE AM 6 2° SERIE 50 2T 12-18
- MOTOR HISPANIA** FURIA 50 2T 97-00, FURIA MAX 50 2T 10-12, RX 50 2T 09-12, RX R 50 2T 09-12
- PEUGEOT** SUPERMOTARD 50 2T 90-02, XP6 TRAIL S/AVV. ELETTRICO 50 2T 90-02, XR6 RACING CAT. C/AVV.ELETT. 50 2T 90-02

- RIEJU** MRT 50 2T 09-12, MRT 50 EU4 50 2T 18-20, MRT PRO 50 2T 09-12, MRT PRO EU4 50 2T 18-20, MRT PRO REPLICA EU4 50 2T 18-20, MRT PRO REPLICA SM EU4 50 2T 18-20, MRT PRO SM 50 2T 09-12, MRT PRO SM EU4 50 2T 18-20, MRT SM 50 2T 09-12, MRT SM EU4 50 2T 18-20, MRT TROPHY EU4 50 2T 18-20, MRX 50 2T 01-04, MRX PRO 50 2T 01-04, RR 50 2T 05-06, RS1 50 2T 98-01, RS2 MATRIX 50 2T 05-06, RS2 MATRIX PRO 50 2T 05-06, RS2 NAKED 50 2T 04-05, RS3 EU4 50 2T 18-20, RS3 NKD EU4 50 2T 18-20, SMX E.S./K.S. 50 2T 01-01, SMX PRO E.S./K.S. 50 2T 03-03, SPIKE 50 2T 98-01
- SHERCO** FACTORY SE-R EU4 50 2T 18-20, FACTORY SE-RS EU4 50 2T 18-20, FACTORY SILVER SM-R EU4 50 2T 18-20, FACTORY SILVER SM-RS EU4 50 2T 18-20, FACTORY SM-R EU4 50 2T 18-20, FACTORY SM-RS EU4 50 2T 18-20, HRD ENDURO 50 2T 09-13, HRD MOTARD 50 2T 09-13
- VENT** BAJA 50 2T 18-20, BAJA RR 50 2T 18-20, DERAPAGE 50 2T 18-20, DERAPAGE RR 50 2T 18-20
- YAMAHA** DT R 50 2T 03-11, DT RSM 50 2T 03-05, DT X 50 2T 06-11, TZR 50 2T 03-08, TZR 50 2T 10-11, TZR RR 50 2T 05-05



cod. 9923190 **RACING**
Serie dischi frizione cellulosa/kevlar Derbi

RICAMBI

9923180	Serie molle frizione rinforzate per Derbi
---------	---

APPLICABILITÀ

- APRILIA** RS 50 2T 06-10, RS4 50 2T 11-13, RS4 REPLICA 50 2T 14-16, RX 50 2T 06-16, SX 50 2T 06-16, SX LIMITED EDITION 50 2T 14-16
- DERBI** BULTACO LOBITO 50 2T 98-01, GPR 2T 50 2T 13-13, GPR 2T EU2 50 2T 09-10, GPR NUDE 50 2T 04-05, GPR NUDE & GPR NUDE TUNING 50 2T 06-08, GPR NUDE SPORT 50 2T 06-06, GPR R 50 2T 97-00, GPR R EU2 - GPR REPLICA EU2 50 2T 08-08, GPR RACING 50 2T 04-05, GPR RACING EU2 50 2T 06-06, GPR REPLICA 50 2T 99-01, GPR REPLICA & GPR R EU2 50 2T 06-06, GPR REPLICA 2T MALOSSI 50 2T 07-07, GPR REPLICA PESEK EU2 50 2T 07-07, GPR REPLICA RACING 50 2T 02-03, GPR REPLICA RACING EU2 50 2T 05-05, SENDA BLACK EDITION 50 2T 03-03, SENDA HYP DRD EVO EU2 50 2T 08-09, SENDA HYP DRD EVO LIMITED EDITION EU2 50 2T 08-08, SENDA R 50 2T 99-01, SENDA R DRD BLACK DEVIL 2A EDIZIONE 50 2T 03-03,

- SENDA R DRD EU1 EU1R 50 2T 02-02, SENDA R DRD PRO EU2 50 2T 05-11, SENDA R DRD RACING 50 2T 04-05, SENDA R DRD RACING EU2 50 2T 05-08, SENDA R DRD RACING LTD 50 2T 05-05, SENDA R DRD X-TREME-10, SENDA SM X-TREME EU2 50 2T 04-08, SENDA SM X-TREME EU2 2A EDIZIONE 50 2T 05-05 2T EU2 50 2T 14-15, SENDA R DRD X-TREME 2T EURO2 50 2T 10-12, SENDA R RACER 50 2T 03-03, SENDA R X-RACE 50 2T 04-05, SENDA R X-RACE 2T EU2 50 2T 10-10, SENDA R X-RACE EU2 50 2T 06-09, SENDA R X-TREME 50 2T 03-03, SENDA R X-TREME 50 2T 05-05, SENDA R X-TREME 2T EU2 50 2T 10-10, SENDA R X-TREME EU2 50 2T 04-08, SENDA SM 50 2T 00-01, SENDA SM DRD EDITION BLACK 50 2T 05-05, SENDA SM DRD EU1 EU1R 50 2T 02-03, SENDA SM DRD PRO EU2 50 2T 05-11, SENDA SM DRD PRO EU2 2VER 50 2T 05-08, SENDA SM DRD RACING 50 2T 04-05, SENDA SM DRD

- RACING EU2 50 2T 05-08, SENDA SM DRD RACING EU2 50 2T 10-13, SENDA SM DRD RACING LTD 50 2T 05-05, SENDA SM DRD RACING LTD EU2 50 2T 07-07, SENDA SM DRD X-TREME 2T EU2 50 2T 14-15, SENDA SM DRD X-TREME 2T EU2 LIMITED ED 50 2T 14-15, SENDA SM X-RACE 50 2T 04-05, SENDA SM X-RACE 2T EU2 50 2T 10-10, SENDA SM X-RACE EU2 50 2T 06-09, SENDA SM X-RACE EU2 2VER 50 2T 07-09, SENDA SM X-TREME 50 2T 02-03, SENDA SM X-TREME 2T EU2 50 2T 10
- GILERA** GSM 50 2T 01-01, RCR 50 2T 03-03, RCR 50 2T 06-07, RCR 50 2T 11-12, RCR (CHE-SYC) 50 2T 13-15, SMT 50 2T 03-03, SMT 50 2T 06-17, SMT RACING 50 2T 11-12
- VALENTI RACING** RME 50 2T 15-17, SM 50 2T 15-17



cod. 9925130
Frizione con campana Ø interno 107 mm

APPLICABILITÀ

- APRILIA** AMICO 50 2T 94-94, AMICO 50 2T 96-98, AMICO GL/GLE 50 2T 93-95, AMICO LX/SPORT/CAT 50 2T 92-93, AREA 51 50 2T 98-00, GULLIVER 50 2T 95-98, GULLIVER LC 50 2T 96-98, RALLY 50 2T 95-03, RALLY LIQUID COOLED 50 2T 96-99, SCARABEO 50 2T 93-05, SONIC 50 2T 98-07, SONIC GP 50 2T 98-08, SR (ORIZZONTALE) 50 2T 94-96, SR (VERTICALE) 50 2T 93-93, SR LIQUID COOLED 50 2T 94-96, SR RACING 50 2T 97-99, SR STEALTH 50 2T 97-00, SR WWW 50 2T 97-01
- ATALA** CAROSELLO 50 2T 99-01
- BENELLI** 491 GT 50 2T 98-99, 491 NAKED 50 2T 02-02, 491 RACING 50 2T 98-99, 491 RR 50 2T 99-01, 491 SP 50 2T 99-99, 491 SPORT 50 2T 98-99, 491 ST 50 2T 99-01, K2 50 2T 98-01, K2 LIQUID COOLED 50 2T 98-01, PEPE 50 2T 99-01, PEPE 50 2T 10-10, PEPE LX 50 2T 03-04, PEPE LX 50 2T 07-09, PEPE OLD 50 2T 07-09, PEPE OLD 50 2T 11-11, QUATTRONONEX 50 2T 08-11
- BETA** ARK 50 2T 96-08, ARK LC 50 2T 96-08, CHRONO 50 2T 95-96, EIKON 50 2T 99-03, QUADRA 50 2T 95-95, QUADRA 50 2T 99-01, TEMPO 50 2T 93-02, TEMPO 50 2T 95-95
- CPI** ARAGON 50 2T 03-03, HUSSAR 50 2T 03-03, OLIVER 50 2T 03-03, POP CORN 50 2T 03-03
- DINLI** HELIX DL603 50 2T 07-13, HELIX DL603 90 50 2T 07-13, T-REX 50 2T 07-13

- E-TON** VIPER RXL 50 2T 06-06
- ITALJET** DRAGSTER 50 2T 98-02
- KEEWAY** ATV EC2 50 2T 06-06, ATV OFF ROAD 50 2T 07-07, F-ACT 50 2T 07-08, FLASH 50 2T 07-08, FOCUS 50 2T 06-06, GOCCIA 50 2T 09-09, HURRICANE 50 2T 06-08, MATRIX 50 2T 06-08, PIXEL EURO 2 50 2T 09-12, RY8 50 2T 08-08
- KTM** K50 50 2T 96-01
- LAVARDA** QUASAR 50 2T 02-04
- MAL** THUNDER 50 2T 95-96
- MALAGUTI** CENTRO SL 50 2T 94-98, CIAK 50 2T 99-01, CIAK EURO 2 2,3 50 2T 03-03, CIAK EURO2 50 2T 01-03, CIAK MASTER EURO 2 50 2T 06-06, F10 50 2T 92-00, F10 ACWAP 50 2T 08-08, F10 EURO 2 50 2T 02-06, F10 EURO 2 2,3 50 2T 03-04, F10 RESTYLING EURO 2 50 2T 06-06, F12 PHANTOM 50 2T 94-98, F12 PHANTOM EURO 2 50 2T 02-02, F12 PHANTOM EURO 2 2,3 50 2T 03-04, F12 PHANTOM LC 50 2T 94-98, F12 PHANTOM LC EURO 2 2,3 50 2T 03-04, F12 R PHANTOM AC 50 2T 07-08, F12 R PHANTOM LC 50 2T 07-10, F12 RESTYLING EURO 1 50 2T 99-02, F12 RESTYLING EURO 2 50 2T 06-06, F12 RESTYLING LC EURO 2 50 2T 06-06, F15 FIRE FOX 50 2T 96-98, F15 FIRE FOX AIR COOLED 50 2T 05-06, F15 FIRE FOX EURO 2 50 2T 02-06, F15 FIRE FOX EURO 2 2,3 50 2T 03-04, YESTERDAY 50 2T 97-00

- MBK** BOOSTER 50 2T 90-04, BOOSTER 50 2T 90-94, BOOSTER EURO 2 50 2T 04-04, BOOSTER NG 50 2T 95-03, BOOSTER ROCKET 50 2T 97-98, BOOSTER SPIRIT 50 2T 96-00, BOOSTER SPIRIT 50 2T 03-03, BOOSTER SPIRIT EURO2 50 2T 03-03, BOOSTER TRACK 50 2T 96-98, BOOSTER X IE 50 4T-3V 08-08, EVOLIS 50 2T 92-95, FIZZ 50 2T 94-95, FLIPPER 50 2T 98-04, FLIPPER EURO 2 50 2T 03-03, FORTE 50 2T 94-96, MACH G 50 2T 02-04, MACH G LC 50 2T 02-04, NITRO 50 2T 97-04, NITRO EURO 2 50 2T 03-03, OVETTO 50 2T 97-04, OVETTO 4T 50 4T-3V 09-11, OVETTO EURO 2 50 2T 02-02, SORRISO 50 2T 95-96, STUNT 50 2T 00-02, TARGET 50 2T 91-95
- MOTRON** SYNCRO 50 2T 98-00, THUNDER 50 2T 95-98
- RIEJU** FIRST 50 2T 95-98, WINDY 50 2T 95-98
- YAMAHA** AEROX 50 2T 97-02, AEROX 50 2T 04-16, AEROX EURO 2 50 2T 03-03, AEROX NAKED 50 2T 13-16, AEROX R 50 2T 99-00, AXIS 50 2T 95-96, BREEZE 50 2T 94-95, BW'S 50 2T 97-16, BW'S BUMP 50 2T 97-98, BW'S EASY 50 2T 13-13, BW'S NAKED 50 2T 03-04, BW'S NAKED 50 2T 09-16, BW'S NEXT GENERATION 50 2T 97-06, BW'S ORIGINAL 50 2T 99-01, BW'S ORIGINAL EURO 2 50 2T 03-03, CRZ 50 2T 91-95, CT 50 2T 90-95, GIGGLE 50 4T-3V 08-08, JOG 50 2T 92-01, JOG R 50 2T 00-02, JOG R 50 2T 02-02, JOG R EURO2 50 2T 02-02, JOG R EURO2 50 2T 06-15, JOG R LC 50 2T 02-15, JOG Z 50 2T 95-95, NEO'S 50 2T 97-02, NEO'S 50 2T 04-16, NEO'S 4 50 4T-3V 09-15, NEO'S EASY 50 2T 13-13, NEO'S EURO 2 50 2T 02-02, RS SPY 50 2T 95-98, SLIDER 50 2T 00-02, WHY 50 2T 98-05, WHY EURO 2 50 2T 03-05, ZEST 50 2T 95-92, ZUMA 50 2T 97-01



cod. **9926630**

Frizione con campana Ø interno 107 mm, adattabile a tutti i motori scooter 50 cc. Gilera, Piaggio, Derbi.

APPLICABILITÀ

APRILIA MOJITO CUSTOM 2T MOTORE PIAGGIO 50 2T 04-10, SCARABEO 2T EU2 MOTORE PIAGGIO 50 2T 10-12, SCARABEO 2T NET 50 2T 09-10, SCARABEO 4T 50 4T 02-06, SCARABEO 4T 4V 50 4T-4V 10-12, SCARABEO 4T 4V NET 50 4T-4V 09-10, SCARABEO 4T RESTYLING EU3 50 4T 06-09, SCARABEO QUATTRO 50 4T-4V 09-09, SCARABEO STREET 50 2T 05-06, SCARABEO STREET 2T RESTYLING 50 2T 06-09, SPORT CITY ONE 2T 50 2T 08-11, SPORT CITY ONE 4T 50 4T 08-10, SR MOTARD 50 2T 12-14, SR R 50 2T 04-09, SR R FACTORY CARBURATORE 50 2T 10-14, SR R FACTORY IE 50 2T 10-14, SR STREET CARBURATORE 50 2T 03-12

BSV DIO GP 50 2T 94-96, DIO SP 50 2T 94-96, DIO ZX 50 2T 94-96

DERBI ATLANTIS 2T 50 2T 10-10, ATLANTIS 2T EU2 50 2T 07-09, ATLANTIS 02 50 2T 02-02, ATLANTIS 02 BULLET 50 2T 03-05, ATLANTIS 02 CITY 50 2T 04-06, ATLANTIS 02 RED BULLET 50 2T 03-03, ATLANTIS 02 TWO CHIC 50 2T 05-05, BOULEVARD 2T 50 2T 09-14, GP1 50 2T 01-03, GP1 EU 2 50 2T 05-05, GP1 OPEN EU2 50 2T 06-09, GP1 RACE EU2 50 2T 05-07, SONAR 2T 50 2T 09-09

GILERA DNA 50 2T 00-02, DNA 50 2T 05-07, DNA GP EXPERIENCE 50 2T 03-04, EASY MOVING 50 2T 95-96, ICE 50 2T 01-05, RUNNER 50 2T 97-00, RUNNER POGGIALI 50 2T 02-02, RUNNER PURE JET 50 2T-IE 02-07, RUNNER PURE JET 50 2T-IE 10-11, RUNNER PURE JET ST 50 2T-IE 08-08, RUNNER SP 50 2T 02-07, RUNNER SP 50 2T 10-12, RUNNER SP SPECIAL EDITION 50 2T 07-07, RUNNER SP ST & SIMONCELLI 50 2T 08-09, STALKER 50 2T 97-11, STALKER NAKED 50 2T 08-08, STALKER SPECIAL EDITION 50 2T 07-08, STORM 50 2T 94-95, STORM EURO 2 50 2T 07-07, TYPHOON 50 2T 94-97, TYPHOON X 50 2T 98-99, TYPHOON XR 50 2T 00-00

HONDA DIO SR 50 2T 92-00, DIO ZX 50 2T 94-96, SFX / SXR 50 2T 95-01, SGX SKY 50 2T 97-04

HSC SC 01 50 2T 94-96, SC 01 L 50 2T 94-96

ITALJET JET SET 50 2T 02-02, TORPEDO NEW 50 2T 00-01

PIAGGIO DIESIS 50 2T 01-01, FLY 2T 50 2T 05-07, FLY 2T 50 2T 10-11, FREE 50 2T 92-94, FREE DELIVERY 50 2T 00-01, FREE FL 50 2T 95-02, LIBERTY 50 2T 97-05, LIBERTY 2T 50 2T 06-08, LIBERTY 2T PTT EU2 50 2T 04-05, LIBERTY 2T RST 50 2T 04-04, LIBERTY 2T SPORT 50 2T 06-08, LIBERTY 4T 3V IE 50 4T-3V 15-17, LIBERTY 4T 3V IE E4 50 4T-3V 17-18, LIBERTY MOC 2T & ELLE 50 2T 09-13, NRG 50 2T 94-96, NRG EXTREME LC 50 2T 99-00, NRG MC3 50 2T 01-04, NRG POWER DD 50 2T 05-17, NRG POWER DD SERIE SPECIALE 50 2T 07-12, NRG POWER DT 50 2T 06-15, NRG POWER DT SERIE SPECIALE 50 2T 07-08, NRG POWER PUREJET 50 2T-IE 04-11, NRG PUREJET 50 2T-IE 02-04, NRG PUREJET 50 2T-IE 10-10, NRG RST MC2 50 2T 96-98, NTT 50 2T 95-96, QUARTZ 50 2T 92-96, SFERA 50 2T 91-93, SFERA MAQUILLAGE 2 50 2T 94-94, SFERA RST 50 2T 95-97, TYPHOON 50 2T 01-11, TYPHOON 2T E2 50 2T 10-12, TYPHOON 2T E3 CH 50 2T 11-11, VESPA ET2 50 2T 97-05, VESPA ET2 INIEZIONE 50 2T 97-00, VESPA LX 2T 50 2T 05-13, VESPA LX 2T TOURING & 30KM 50 2T 10-13, VESPA LXV 2T 50 2T 06-09, VESPA LXV 2T NAVY 50 2T 08-08, VESPA S 2T & COLLEGE 50 2T 07-12, ZIP 50 2T 92-93, ZIP 50 2T 95-96, ZIP 2T 50 2T 08-13, ZIP BIMODALE 50 2T 94-97, ZIP FAST RIDER 50 2T 93-94, ZIP FAST RIDER RST 50 2T 96-97, ZIP LC 50 2T 00-04, ZIP RST 50 2T 96-99, ZIP SP 50 2T 96-04, ZIP SP EURO 2 50 2T 06-13

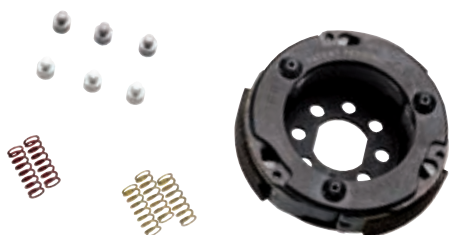

cod. **9927450**

RACING

Frizione completa regolabile "TPR" (GP) Ø 107 mm, scooter 50 cc Minarelli/Yamaha N. BREVETTO 1413380



APPLICABILITÀ

APRILIA AMICO 50 2T 94-94, AMICO 50 2T 96-98, AMICO GL/GLE 50 2T 93-95, AMICO LX/SPORT/CAT 50 2T 92-93, AREA 51 50 2T 98-00, GULLIVER 50 2T 95-98, GULLIVER LC 50 2T 96-98, RALLY 50 2T 95-03, RALLY LIQUID COOLED 50 2T 96-99, SCARABEO 50 2T 93-05, SONIC 50 2T 98-07, SONIC GP 50 2T 98-08, SR (ORIZZONTALE) 50 2T 94-96, SR (VERTICALE) 50 2T 93-93, SR LIQUID COOLED 50 2T 94-96, SR RACING 50 2T 97-99, SR STEALTH 50 2T 97-00, SR WWW 50 2T 97-01

ATALA CAROSELLO 50 2T 99-01

BENELLI 491 GT 50 2T 98-99, 491 NAKED 50 2T 02-02, 491 RACING 50 2T 98-99, 491 RR 50 2T 99-01, 491 SP 50 2T 99-99, 491 SPORT 50 2T 98-99, 491 ST 50 2T 99-01, K2 50 2T 98-01, K2 LIQUID COOLED 50 2T 98-01, PEPE 50 2T 99-01, PEPE LX 50 2T 03-04

BETA ARK 50 2T 96-08, ARK LC 50 2T 96-08, CHRONO 50 2T 95-96, EIKON 50 2T 99-03, QUADRA 50 2T 95-95, TEMPO 50 2T 93-02, TEMPO 50 2T 95-95

ITALJET BAZOOKA 50 2T 91-94, DRAGSTER 50 2T 98-02, PISTA 50 2T 92-97, PISTA 2 50 2T 97-98, SCOOP 50 2T 91-95, SCOOP 2 50 2T 96-98, YANKEE 50 2T 93-97

KTM K50 50 2T 96-01

MACAL THUNDER 50 2T 95-96

MALAGUTI CENTRO SL 50 2T 94-98, CIAK 50 2T 99-01, CIAK EURO 2, 2,3 50 2T 03-03, CIAK EURO2 50 2T 01-03, F10 50 2T 92-00, F10 EURO 2 50 2T 02-06, F10 EURO 2,3 50 2T 03-04, F12 PHANTOM 50 2T 94-98, F12 PHANTOM EURO 2 50 2T 02-02, F12 PHANTOM EURO 2,3 50 2T 03-04, F12 PHANTOM LC 50 2T 94-98, F12 PHANTOM LC EURO 2,3 50 2T 03-04, F12 RESTYLING EURO 1 50 2T 99-02, F12 RESTYLING EURO 2 50 2T 06-06, F15 FIRE FOX 50 2T 96-98, F15 FIRE FOX EURO 2 50 2T 02-03, F15 FIRE FOX EURO 2,3 50 2T 03-04, YESTERDAY 50 2T 97-00

MBK BOOSTER 50 2T 90-04, BOOSTER 50 2T 90-94, BOOSTER EURO 2 50 2T 04-04, BOOSTER NG 50 2T 95-03, BOOSTER ROCKET 50 2T 97-98, BOOSTER SPIRIT 50 2T 96-00, BOOSTER SPIRIT 50 2T 03-03, BOOSTER SPIRIT EURO2 50 2T 03-03, BOOSTER TRACK 50 2T 96-98, FLIPPER EURO 2 50 2T 03-03, MACH G 50 2T 02-04, MACH G LC 50 2T 02-04, NITRO 50 2T 97-04, NITRO EURO 2 50 2T 03-03, OVETTO 50 2T 97-04, OVETTO EURO 2 50 2T 02-02, SORRISO 50 2T 95-96, STUNT 50 2T 00-02, TARGET 50 2T 91-95

MOTRON SYNCRO 50 2T 98-00, THUNDER 50 2T 95-98

RIEJU FIRST 50 2T 95-98, WINDY 50 2T 95-98

YAMAHA AEROX 50 2T 97-02, AEROX 50 2T 04-16, AEROX EURO 2 50 2T 03-03, AEROX NAKED 50 2T 13-16, AEROX R 50 2T 99-00, BW'S 50 2T 97-16, BW'S BUMP 50 2T 97-98, BW'S EASY 50 2T 13-13, BW'S NAKED 50 2T 03-04, BW'S NAKED 50 2T 09-16, BW'S NEXT GENERATION 50 2T 97-06, BW'S ORIGINAL 50 2T 99-01, BW'S ORIGINAL EURO 2 50 2T 03-03, CRZ 50 2T 91-95, CT 50 2T 90-95, JOG R 50 2T 02-02, JOG R EURO2 50 2T 02-02, JOG R EURO2 50 2T 06-15, JOG R LC 50 2T 02-15, NEO'S 50 2T 97-02, NEO'S 50 2T 04-16, NEO'S EASY 50 2T 13-13, NEO'S EURO 2 50 2T 02-02, RS SPY 50 2T 95-98, SLIDER 50 2T 00-02, WHY 50 2T 98-05, WHY EURO 2 50 2T 03-05, ZUMA 50 2T 97-01



cod. **9927810**

Serie molle frizione rinforzate WR 125 (carico 31,5 kg)

APPLICABILITÀ

BETA RR 125 4T-4V 10-17

FANTIC CABALLERO MOTARD 125 4T-4V 08-18, CABALLERO REGO-LARITÀ 125 4T-4V 08-08

HM CITY 125 4T-4V 11-13, CRE F125X 125 4T-4V 08-09, CRE F125X BAJA 125 4T-4V 10-12, CRE F125X BAJA RR 125 4T-4V 10-12, CRE F125X SIX 125 4T-4V 10-11, CRM F125X 125 4T-4V 08-09, CRM F125X DERAPAGE 125 4T-4V 10-12, CRM F125X DERAPAGE COMPETITION 125 4T-4V 10-11, CRM F125X DERAPAGE RR 125 4T-4V 10-12, LOCUSTA 125 4T-4V 11-13, CITY 200 4T-4V 11-13, LOCUSTA 200 4T-4V 11-13

HUSQVARNA SM 125 4T-4V 10-10, TE 125 4T-4V 10-10

MOTORHISPANIA KN1 125 4T-4V 08-08, MH7 125 4T-4V 08-08, RX-R 125 4T-4V 08-08

RIEJU MARATHON 125 4T-4V 09-09, MARATHON PRO 125 4T-4V 11-11, RS3 125 4T-4V 11-11

VENT BAJA 125 4T-4V 18-19, BAJA RR 125 4T-4V 18-19, DERAPAGE 125 4T-4V 18-19, DERAPAGE RR 125 4T-4V 18-19, TRAIL 125 4T-4V 18-19

YAMAHA MT 125 4T 4V IE 15-15, MT A 125 4T 4V IE 15-15, WR-R IE 125 4T 4V IE 09-11, WR-X IE 125 4T 4V IE 09-11, WR-X IE 125 4T 4V IE 13-14, YZF-R A IE 125 4T 4V IE 15-15, YZF-R IE 125 4T 4V IE 08-15

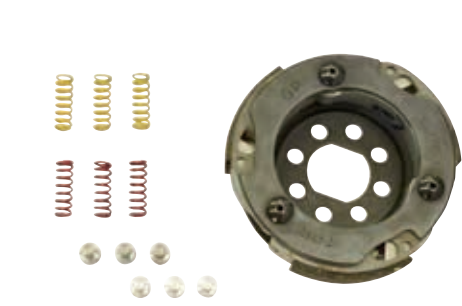

cod. 9928150 **RACING**

Serie dischi frizione con molle Racing Yamaha T-Max

APPLICABILITÀ

YAMAHA T-MAX 4BS 500 4T 09-11, T-MAX 4BS ABS 500 4T 08-11, T-MAX 5GJ 500 4T 01-03, T-MAX 5VU 500 4T 04-08, T-MAX 5VU ABS 500 4T 05-07, T-MAX 5VU BLACK MAX 500 4T 06-06, T-MAX 5VU BLACK MAX - NIGHT MAX 500 4T 07-07

RICAMBI

9927930 Serie molle frizione carico differenziato Yamaha T-Max



cod. 9928340 **RACING**

Frizione completa regolabile "TPR" (GP) Ø 107 mm, scooter 50 cc Piaggio N. BREVETTO 1413380

APPLICABILITÀ

APRILIA MOJITO CUSTOM 2T MOTORE PIAGGIO 50 2T 04-10, SCARABEO 2T EU2 MOTORE PIAGGIO 50 2T 10-12, SCARABEO 2T NET 50 2T 09-10, SCARABEO 4T 50 4T 02-06, SCARABEO 4T 4V 50 4T 4V 10-12, SCARABEO 4T 4V NET 50 4T 4V 09-10, SCARABEO 4T RESTYLING EU3 50 4T 06-09, SCARABEO QUATTRO 50 4T 4V 09-09, SCARABEO STREET 50 2T 05-06, SCARABEO STREET 2T RESTYLING 50 2T 06-09, SPORT CITY ONE 2T 50 2T 08-11, SPORT CITY ONE 4T 50 4T 08-10, SR MOTARD 50 2T 12-14, SR R 50 2T 04-09, SR R FACTORY CARBURATORE 50 2T 10-14, SR R FACTORY IE 50 2T 10-14, SR R FACTORY IE 50 2T-IE 10-12, SR STREET CARBURATORE 50 2T 03-12

DERBI ATLANTIS 2T 50 2T 10-10, ATLANTIS 2T EU2 50 2T 07-09, ATLANTIS 4T 50 4T 04-06, ATLANTIS 4T EU2 50 4T 07-07, ATLANTIS 02 50 2T 02-02, ATLANTIS 02 BULLET 50 2T 03-05, ATLANTIS 02 CITY 50 2T 04-06, ATLANTIS 02 RED BULLET 50 2T 03-03, ATLANTIS 02 TWO CHIC 50 2T 05-05, BOULEVARD 2T 50 2T 09-14, BOULEVARD 4T EU2 25KM/H 50 4T 09-09, GP1 50 2T 01-03, GP1 EU 2 50 2T 05-05, GP1 OPEN EU2 50 2T 06-09, GP1 RACE EU2 50 2T 05-07, SONAR 2T 50 2T 09-09

GILERA DNA 50 2T 00-02, DNA 50 2T 05-07, DNA GP EXPERIENCE 50 2T 03-04, EASY MOVING 50 2T 95-96, ICE 50 2T 01-05, RUNNER 50 2T 97-00, RUNNER POGGIALI 50 2T 02-02, RUNNER PURE JET 50 2T-IE 02-07, RUNNER PURE JET 50 2T-IE 10-11, RUNNER PURE JET ST 50 2T-IE 08-08, RUNNER SP 50 2T 02-07, RUNNER SP 50 2T 10-12, RUNNER SP SPECIAL EDITION 50 2T 07-07, RUNNER SP ST &

ITALJET SIMONCELLI 50 2T 08-09, STALKER 50 2T 97-11, STALKER NAKED 50 2T 08-08, STALKER SPECIAL EDITION 50 2T 07-08, STORM 50 2T 94-95, STORM EURO 2 50 2T 07-07, TYPHOON 50 2T 94-97, TYPHOON X 50 2T 98-99, TYPHOON XR 50 2T 00-00, JET SET 50 2T 02-02, TORPEDO 50 4T 97-00, TORPEDO NEW 50 2T 00-01

MALAGUTI CENTRO EURO 2 50 4T 08-08, CENTRO SL 4T 50 4T 10-10, CIAK MASTER 4T 50 4T 05-06, CIAK MASTER EURO 2 50 4T 05-06

PIAGGIO DIESIS 50 2T 01-01, FLY 2T 50 2T 05-07, FLY 2T 50 2T 10-11, FLY 4T 50 4T 05-07, FLY 4T & 25-30 KM/H 50 4T 08-11, FLY 4T 4V 50 4T 4V 12-13, FLY 4T MOTORE CHN 50 4T 06-07, FREE 50 2T 92-94, FREE DELIVERY 50 2T 00-01, FREE FL 50 2T 95-02, LIBERTY 50 2T 97-05, LIBERTY 2T 50 2T 06-08, LIBERTY 2T PTT EU2 50 2T 04-05, LIBERTY 2T RST 50 2T 04-04, LIBERTY 2T SPORT 50 2T 06-08, LIBERTY 4T 50 4T 00-02, LIBERTY 4T 50 4T 05-08, LIBERTY 4T 3V IE 50 4T 3V 15-17, LIBERTY 4T 3V IE E4 50 4T 3V 17-18, LIBERTY 4T DELIVERY - SINGLE 50 4T 10-14, LIBERTY 4T DELIVERY TNT 50 4T 09-09, LIBERTY 4T PTT - DOUBLE - NEXIVE 50 4T 09-17, LIBERTY 4T RST 50 4T 04-04, LIBERTY 4T SPORT 50 4T 06-08, LIBERTY MOC 2T & ELLE 50 2T 09-13, LIBERTY MOC 4T & ELLE 50 4T 09-16, NRG 50 2T 94-96, NRG EXTREME LC 50 2T 99-00, NRG MC3 50 2T 01-04, NRG POWER DD 50 2T 05-17, NRG POWER DD SERIE SPECIALE 50 2T 07-12, NRG POWER DT 50 2T 06-15, NRG POWER DT SERIE SPECIALE

50 2T 07-08, NRG POWER PUREJET 50 2T-IE 04-11, NRG PUREJET 50 2T-IE 02-04, NRG PUREJET 50 2T-IE 10-10, NRG RST MC2 50 2T 96-98, NTT 50 2T 95-96, QUARTZ 50 2T 92-96, SFERA 50 2T 91-93, SFERA MAQUILLAGE 2 50 2T 94-94, SFERA RST 50 2T 95-97, TYPHOON 50 2T 11-11, TYPHOON 2T E2 50 2T 10-12, TYPHOON 2T E3 CH 50 2T 11-11, VESPA ET2 50 2T 97-05, VESPA ET2 INIEZIONE 50 2T 97-00, VESPA ET4 50 4T 00-05, VESPA LX 2T 50 2T 05-13, VESPA LX 2T TOURING & 30KM 50 2T 10-13, VESPA LX 4T 50 4T 05-09, VESPA LX 4T 4V 50 4T 4V 09-13, VESPA LX 4T 4V TOURING 50 4T 4V 10-13, VESPA LXV 2T 50 2T 06-09, VESPA LXV 2T NAVY 50 2T 08-08, VESPA S 2T & COLLEGE 50 2T 07-12, VESPA S 4T 4V & COLLEGE 50 4T 4V 08-12, ZIP 50 2T 92-93, ZIP 50 2T 95-96, ZIP 2T 50 2T 08-13, ZIP 4T 50 4T 00-13, ZIP BIMODALE 50 2T 94-97, ZIP FAST RIDER 50 2T 93-94, ZIP FAST RIDER RST 50 2T 96-97, ZIP LC 50 2T 00-04, ZIP RST 50 2T 96-99, ZIP SP 50 2T 96-04, ZIP SP EURO 2 50 2T 06-13

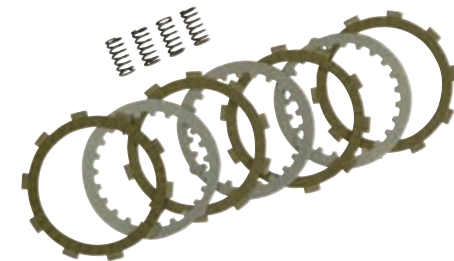

cod. 9930850 **RACING**

Serie dischi frizione "TPR" per AM 345/6

A RICAMBIO PER

9931900 Kit frizione completo Tamburo+dischi "TPR" per am 345/6

RICAMBI

9920580 Serie molle frizione AM rinforzate 100 kg

APPLICABILITÀ

APRILIA CLASSIC 50 2T 92-99, EUROPA 50 2T 91-92, MX 50 2T 04-04, MX MOTARD 50 2T 95-03, PEGASO 50 2T 92-94, RS 50 2T 91-05, RX 50 2T 03-04, RX 3-5 MARCE 50 2T 91-94, RX ENDURO 50 2T 95-03, RX RACING 50 2T 03-06, TUONO 50 2T 03-04

BETA RR 2T 50 EU4 50 2T 18-20, RR 50 RACING EU4 50 2T 18-20, RR ALU 50 2T 08-12, RR ENDURO 50 2T 06-17, RR MOTARD 50 2T 06-17

CH HUSQUARNA SM 50 2T 00-10, WR 50 2T 00-10, WSM 50 2T 00-10

CMC ENDURO 50 2T 11-11, MOTARD 50 2T 11-11

FANTIC CABALLERO MOTARD 50 2T 06-10, CABALLERO REGOLARITÀ 50 2T 06-10, ENDURO COMPETITION EU4 50 2T 18-20, ENDURO PERFORMANCE EU4 50 2T 18-20, MOTARD COMPETITION EU4 50 2T 18-20, MOTARD PERFORMANCE EU4 50 2T 18-20

HM BAJA, DERAPAGE BASIC 50 2T 10-11, CMC 50 2T 10-11, CRE BAJA RR, DERAPAGE RR 50 2T 07-11, CRE BAJA, DERAPAGE 50 2T 07-11, CRE SIX COMPETITION 50 2T 10-11, CRE SIX, BAJA, DERAPAGE 50 2T 95-06, CRE SIX, DERAPAGE COMPETITION 50 2T 07-09, DERAPAGE COMPETITION 50 2T 10-11

MALAGUTI CNK DRAGON 50 2T 05-07, FIFTY EVOLUTION 50 2T 90-93, XSM 50 2T 03-03, XTM 50 2T 03-03

MBK X LIMIT 50 2T 03-04, X POWER 50 2T 03-04

MINARELLI MOTORE AM 3-4-5 50 2T 91-95, MOTORE AM 6 1° SERIE 50 2T 96-11, MOTORE AM 6 2° SERIE 50 2T 12-18

MOTORHISPANIA FURIA 50 2T 97-00, FURIA MAX 50 2T 10-12, RX 50 2T 09-12, RX R 50 2T 09-12

PEUGEOT SUPERMOTARD 50 2T 90-02, XP6 TRAIL S/AVV. ELETTRICO 50 2T 90-02, XR6 RACING CAT. C/AVV.ELETT. 50 2T 90-02

RIEJU MRT 50 2T 09-12, MRT 50 EU4 50 2T 18-20, MRT PRO 50 2T 09-12, MRT PRO EU4 50 2T 18-20, MRT PRO REPLICA EU4 50 2T 18-20, MRT PRO SM EU4 50 2T 18-20, MRT PRO SM 50 2T 09-12, MRT PRO REPLICA SM EU4 50 2T 18-20, MRT PRO SM 50 2T 09-12, MRT SM EU4 50 2T 18-20, MRT TROPHY EU4 50 2T 18-20, MRX 50 2T 01-04, MRX PRO 50 2T 01-04, RR 50 2T 05-06, RS1 50 2T 98-01, RS2 MATRIX 50 2T 05-06, RS2 MATRIX PRO 50 2T 05-06, RS2 NAKED 50 2T 04-05, RS3 EU4 50 2T 18-20, RS3 NKD EU4 50 2T 18-20, SMX E.S./K.S. 50 2T 01-01, SMX PRO E.S./K.S. 50 2T 03-03, SPIKE 50 2T 98-01

SHERCO FACTORY SE-R EU4 50 2T 18-20, FACTORY SE-RS EU4 50 2T 18-20, FACTORY SILVER SM-R EU4 50 2T 18-20, FACTORY SILVER SM-RS EU4 50 2T 18-20, FACTORY SM-R EU4 50 2T 18-20, FACTORY SM-RS EU4 50 2T 18-20, HRD ENDURO 50 2T 09-13, HRD MOTARD 50 2T 09-13

VENT BAJA 50 2T 18-20, BAJA RR 50 2T 18-20, DERAPAGE 50 2T 18-20, DERAPAGE RR 50 2T 18-20

YAMAHA DT R 50 2T 03-11, DT RSM 50 2T 03-05, DT X 50 2T 06-11, TZR 50 2T 03-08, TZR 50 2T 10-11, TZR RR 50 2T 05-05



cod. **9930880**

RACING

Serie dischi frizione con molle Racing Yamaha T-Max 530/560

APPLICABILITÀ

YAMAHA T-MAX 59C 530 4T 12-16, T-MAX 59C ABS 530 4T 12-16, T-MAX 59C SP 530 4T 15-15, T-MAX 59C SP ABS 530 4T 15-16, XP530-A T-MAX SX 530 4T 17-19, XP530D-A T-MAX DX 530 4T 17-19, XP530E-A T-MAX 530 4T 17-18

RICAMBI

9930890	Serie molle frizione
---------	----------------------

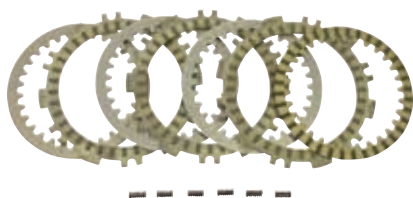

cod. **9931020**

Serie dischi frizione con molle Piaggio 350 cc

APPLICABILITÀ

PIAGGIO BEVERLY 4T 4V IE EU3 350 4T 11-14, BEVERLY 4T ST IE ABS 350 4T 16-16, X10 4T 4V IE EURO3 350 4T 12-15

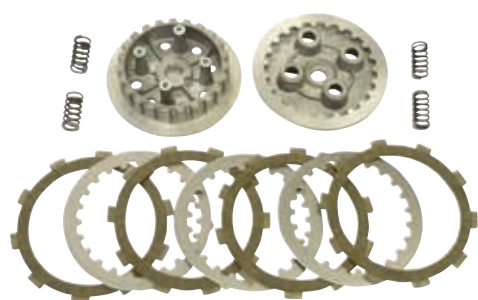

cod. **9931900**

RACING

Kit frizione completa tamburo e dischi "TPR" per AM 345/6

APPLICABILITÀ

APRILIA	CLASSIC 50 2T 92-99, EUROPA 50 2T 91-92, MX 50 2T 04-04, MX MOTARD 50 2T 95-03, PEGASO 50 2T 92-94, RS 50 2T 91-05, RX 50 2T 03-04, RX 3-5 MARCE 50 2T 91-94, RX ENDURO 50 2T 95-03, RX RACING 50 2T 03-06, TUONO 50 2T 03-04	MINARELLI	MOTORE AM 3-4-5 50 2T 91-95, MOTORE AM 6 1° SERIE 50 2T 96-11, MOTORE AM 6 2° SERIE 50 2T 12-18
BETA	RR 2T 50 EU4 50 2T 18-20, RR 50 RACING EU4 50 2T 18-20, RR ALU 50 2T 08-12, RR ENDURO 50 2T 06-17, RR MOTARD 50 2T 06-17	MOTORHISPANIA	FURIA 50 2T 97-00, FURIA MAX 50 2T 10-12, RX 50 2T 09-12, RX R 50 2T 09-12
CH HUSQUARNA CMC	SM 50 2T 00-10, WR 50 2T 00-10, WSM 50 2T 00-10	PEUGEOT	SUPERMOTARD 50 2T 90-02, XP6 TRAIL S/AVV. ELETTRICO 50 2T 90-02, XR6 RACING CAT. C/AVV.ELETT. 50 2T 90-02
FANTIC	CABALLERO MOTARD 50 2T 06-10, CABALLERO REGOLARITÀ 50 2T 06-10, ENDURO COMPETITION EU4 50 2T 18-20, ENDURO PERFORMANCE EU4 50 2T 18-20, MOTARD COMPETITION EU4 50 2T 18-20, MOTARD PERFORMANCE EU4 50 2T 18-20	RIEJU	MRT 50 2T 09-12, MRT 50 EU4 50 2T 18-20, MRT PRO 50 2T 09-12, MRT PRO EU4 50 2T 18-20, MRT PRO REPLICA EU4 50 2T 18-20, MRT PRO REPLICA SM EU4 50 2T 18-20, MRT PRO SM 50 2T 09-12, MRT PRO SM EU4 50 2T 18-20, MRT SM 50 2T 09-12, MRT SM EU4 50 2T 18-20, MRT TROPHY EU4 50 2T 18-20, MRX 50 2T 01-04, MRX PRO 50 2T 01-04, RR 50 2T 05-06, RS1 50 2T 98-01, RS2 MATRIX 50 2T 05-06, RS2 MATRIX PRO 50 2T 05-06, RS2 NAKED 50 2T 04-05, RS3 EU4 50 2T 18-20, RS3 NKD EU4 50 2T 18-20, SMX E.S./K.S. 50 2T 01-01, SMX PRO E.S./K.S. 50 2T 03-03, SPIKE 50 2T 98-01
HM	BAJA, DERAPAGE BASIC 50 2T 10-11, CMC 50 2T 10-11, CRE BAJA RR, DERAPAGE RR 50 2T 07-11, CRE BAJA, DERAPAGE 50 2T 07-11, CRE SIX COMPETITION 50 2T 10-11, CRE SIX, BAJA, DERAPAGE 50 2T 95-06, CRE SIX, DERAPAGE COMPETITION 50 2T 07-09, DERAPAGE COMPETITION 50 2T 10-11	SHERCO	FACTORY SE-R EU4 50 2T 18-20, FACTORY SE-RS EU4 50 2T 18-20, FACTORY SILVER SM-R EU4 50 2T 18-20, FACTORY SILVER SM-RS EU4 50 2T 18-20, FACTORY SM-R EU4 50 2T 18-20, FACTORY SM-RS EU4 50 2T 18-20, HRD ENDURO 50 2T 09-13, HRD MOTARD 50 2T 09-13
MALAGUTI	CNK DRAGON 50 2T 05-07, FIFTY EVOLUTION 50 2T 90-93, XSM 50 2T 03-03, XTM 50 2T 03-03	VENT	BAJA 50 2T 18-20, BAJA RR 50 2T 18-20, DERAPAGE 50 2T 18-20, DERAPAGE RR 50 2T 18-20
MBK	X LIMIT 50 2T 03-04, X POWER 50 2T 03-04	YAMAHA	DT R 50 2T 03-11, DT RSM 50 2T 03-05, DT X 50 2T 06-11, TZR 50 2T 03-08, TZR 50 2T 10-11, TZR RR 50 2T 05-05

RICAMBI

9920580	Serie Molle Frizione Am Rinforz. 100 Kg.
---------	--

9930850	Serie Dischi Friz."TPR" Per Am345/6
---------	-------------------------------------



- ◀ **cod. 9917400**
Gruppo termico Ø 39,88 Motore Derbi Senda (EBS050) – Bultaco Lobito
Cilindro in ghisa Minacrom | Cilindrata 49,94 cc cm 3- Corsa mm. 40 | Completo di testa

RICAMBI

9918130	Pistone completo Ø 40
9918131	Pistone completo Ø 40,28
9918140	Serie segmenti Ø 40
9918141	Serie segmenti Ø 40,28

9922020	Serie guarnizioni
9918160	Testa



- ◀ **cod. 9927100**
Gruppo termico Ø 39,885 Derbi Senda (d50b0) motore Piaggio
Cilindro in ghisa Minacrom con 7 travasi | Cilindrata 49,93 cc - Corsa mm 40 - Rapp. Comp. 1:13,8 | Completo di testa

RICAMBI

9927000	Pistone completo Ø 39,88
9927001	Pistone completo Ø 40,28
9930230	Serie segmenti Ø39,88
9930231	Serie segmenti Ø 40,28
9930240	Serie guarnizioni

9930220	Testa
9928090	Raccordo testa
9929480	Serie prigionieri M7 x 115
9930270	Tappo cilindrico

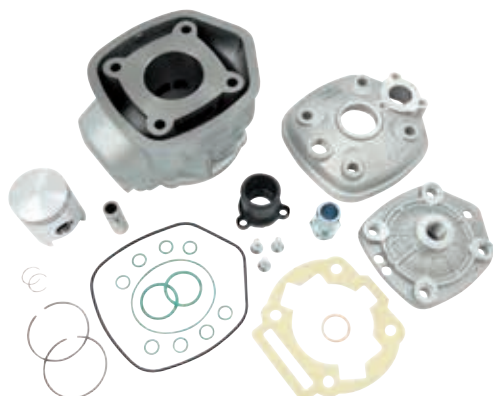

- ◀ **cod. 9927980**
Gruppo Termico Ø 39,88 Motore Derbi Senda (EBS050)

RICAMBI

9927000	Pistone completo Ø 39,885
9930230	Serie segmenti Ø 39,885
9930231	Serie segmenti Ø 40,28
9930260	Serie guarnizioni Ø 39,885

9930250	Testa completa Ø 39,885
9928050	Raccordo testa Ø 39,885
9929960	Raccordo cilindro Ø 39,885



- ◀ **cod. 9914500**
Gruppo termico Ø 40 adattabile a motori Gilera/Piaggio air cooled
Cilindro in ghisa Minacrom con 5 travasi | Cilindrata 49,3 cc - Corsa mm 39,3 - Rapp. Comp. 1:12 | Completo di testa

RICAMBI

9913470	Pistone completo Ø 40
9913471	Pistone completo Ø 40,5
9913472	Pistone completo Ø 41
9910380	Serie segmenti Ø 40

9910381	Serie segmenti Ø 40,5
9914710	Guarnizione base
9910750	Testa troncoconica



- ◀ **cod. 9916580**
Gruppo termico Ø 40 adattabile a motori Gilera/Piaggio liquid cooled con raccordo testa
Cilindro in ghisa Minacrom con 5 travasi | Cilindrata 49,3 cc - Corsa mm 39,3 - Rapp. Comp. 1:13,5 | Completo di testa

RICAMBI

9913470	Pistone completo Ø 40
9913471	Pistone completo Ø 40,5
9913472	Pistone completo Ø 41
9910380	Serie segmenti Ø 40

9910381	Serie segmenti Ø 40,5
9914270	Serie guarnizioni
9916570	Testa troncoconica

ATTENZIONE: QUESTI PRODOTTI SONO DESTINATI ESCLUSIVAMENTE AD USO AGONISTICO. NE È QUINDI VIETATO L'UTILIZZO SU STRADA PUBBLICA.



◀ cod. **9924770**

Gruppo termico Ø 40 adattabile a motori Peugeot air cooled "EU2"
Cilindro in ghisa Minacrom con 7 travasi | Cilindrata 49,1 cc - Corsa mm 39,1 - Rapp. Comp. 1:12 | Completo di testa

RICAMBI

9913370	Pistone completo Ø 40
9913371	Pistone completo Ø 40,5
9910380	Serie segmenti Ø 40

9910381	Serie segmenti Ø 40,5
9914720	Guarnizione base
9910760	Testa



◀ cod. **9925650**

Gruppo termico Ø 40 per Keeway Focus
Cilindro in ghisa Minacrom con 6 travasi | Cilindrata 49,24 cc - Corsa mm 39,2 - Rapp. Comp. 1:12,2 | Completo di testa

RICAMBI

9927210	Pistone completo Ø 40
9927211	Pistone completo Ø 40,5
9910380	Serie segmenti Ø 40

9910381	Serie segmenti Ø 40,5
9927220	Serie guarnizioni
9915880	Testa



◀ cod. **9925830**

Gruppo termico Ø 40 per Peugeot Ludix 50 cc
Cilindro in ghisa Minacrom con 6 travasi | Cilindrata 49,98 cc - Corsa mm 39,8 - Rapp. Comp. 1:12,9 | Completo di testa

RICAMBI

9913370	Pistone completo Ø 40
9913371	Pistone completo Ø 40,5
9910380	Serie segmenti Ø 40

9910381	Serie segmenti Ø 40,5
9927880	Serie guarnizioni
9927470	Testa



◀ cod. **9931110**

Gruppo termico Black Trophy Ø 40 Liquid Cooled per motori scooter 50 cc Minarelli/Yamaha
Cilindro in ghisa Minacrom con 7 travasi | Cilindrata 49,2 cc - Corsa mm 39,2 - Rapp. Compr. 1:13 | Completo di testa

RICAMBI

9931130	Pistone completo MoS2 Ø 40
9910431	Pistone completo Ø 40,5
9910380	Serie segmenti Ø 40

9910381	Serie segmenti Ø 40,5
9915910	Serie guarnizioni
9915890	Testa



◀ cod. **9931140**

Gruppo termico Black Trophy Ø 40 Air Cooled per motori scooter 50 cc Minarelli/Yamaha orizzontale
Cilindro in ghisa Minacrom con 7 travasi | Cilindrata 49,2 cc - Corsa mm 39,2 - Rapp. Comp. 1:13 | Completo di testa

RICAMBI

9931130	Pistone completo MoS2 Ø 40
9910431	Pistone completo Ø 40,5
9910380	Serie segmenti Ø 40

9910381	Serie segmenti Ø 40,5
9915900	Serie guarnizioni
9915880	Testa

ATTENZIONE: QUESTI PRODOTTI SONO DESTINATI ESCLUSIVAMENTE AD USO AGONISTICO. NE È QUINDI VIETATO L'UTILIZZO SU STRADA PUBBLICA.



◀ **cod. 9931170**

Gruppo termico Black Trophy Ø 40 Air Cooled per motori scooter 50 cc Minarelli/Yamaha verticale
Cilindro in ghisa Minacrom con 7 travasi | Cilindrata 49,2 cc - Corsa mm 39,2 - Rapp. Comp. 1:12 | Completo di testa

RICAMBI

9931130	Pistone completo MoS2 Ø 40
9910431	Pistone completo Ø 40,5
9910380	Serie segmenti Ø 40

9910381	Serie segmenti Ø 40,5
9916530	Serie guarnizioni
9916520	Testa



◀ **cod. 9934200**

Gruppo termico Ø 40 spinotto Ø 12 motori scooter 50 cc Minarelli/Yamaha

APPLICABILITÀ

Malaguti F10 AC ECO 50 2T 09-10, F12 R PHANTOM AC 50 2T 09-10

RICAMBI

9927210	Pistone completo
9910380	Serie segmenti
9927220	Serie guarnizioni
9915880	Testa



◀ **cod. 9916770**

Gruppo termico Ø 40,3 adattabile a motori Minarelli AM6 EU1 AM345/AM6
Cilindro in ghisa Minacrom 5 travasi | Cilindrata 49,7 cc - Corsa mm. 39 - Rapp. Comp. 1:12 | Completo di testa

RICAMBI

9915610	Pistone completo Ø 40,3
9915611	Pistone completo Ø 40,6
9915612	Pistone completo Ø 40,8
9915620	Serie segmenti Ø 40,3

9915621	Serie segmenti Ø 40,6
9915622	Serie segmenti Ø 40,8
9915630	Serie guarnizioni
9916800	Testa

NOVITÀ



◀ **cod. 9934500**

Gruppo Termico in alluminio Ø 40,3 "TPR" per AM6

APPLICABILITÀ

APRILIA	CLASSIC 50 2T 92-99, EUROPA 50 2T 91-92, MX 50 2T 04-04, MX MOTARD 50 2T 95-03, PEGASO 50 2T 92-94, RS 50 2T 91-05, RX 50 2T 03-04, RX 3-5 MARCE 50 2T 91-94, RX ENDURO 50 2T 95-03, RX RACING 50 2T 03-06, TUONO 50 2T 03-04
BETA	RR 2T 50 EU4 50 2T 18-20, RR 50 RACING EU4 50 2T 18-20, RR ALU 50 2T 08-12, RR ENDURO 50 2T 06-17, RR MOTARD 50 2T 06-17
CH SQUARNA	HU-SM 50 2T 00-10, WR 50 2T 00-10, WSM 50 2T 00-10
CMC	ENDURO 50 2T 11-11, MOTARD 50 2T 11-11
FANTIC	CABALLERO MOTARD 50 2T 06-10, CABALLERO REGOLARITA 50 2T 06-10, ENDURO COMPETITION EU4 50 2T 18-20, ENDURO PERFORMANCE EU4 50 2T 18-20, MOTARD COMPETITION EU4 50 2T 18-20, MOTARD PERFORMANCE EU4 50 2T 18-20
HM	BAJA, DERAPAGE BASIC 50 2T 10-11, CMC 50 2T 10-11, CRE BAJA RR, DERAPAGE RR 50 2T 07-11, CRE BAJA, DERAPAGE 50 2T 07-11, CRE SIX COMPETITION 50 2T 10-11, CRE SIX, BAIA, DERAPAGE 50 2T 95-06, CRE SIX, DERAPAGE COMPETITION 50 2T 07-09, DERAPAGE COMPETITION 50 2T 10-11
MALAGUTI	CNK DRAGON 50 2T 05-07, FIFTY EVOLUTION 50 2T 90-93, XSM 50 2T 03-03, XTM 50 2T 03-03
MBK	X LIMIT 50 2T 03-04, X POWER 50 2T 03-04

MINARELLI	MOTORE AM 3-4-5 50 2T 91-95, MOTORE AM 6 1° SERIE 50 2T 96-11, MOTORE AM 6 2° SERIE 50 2T 12-18
MOTORHISPANIA	FURIA 50 2T 97-00, FURIA MAX 50 2T 10-12, RX 50 2T 09-12, RX R 50 2T 09-12
PEUGEOT	SUPERMOTARD 50 2T 90-02, XP6 TRAIL S/AVV. ELETTRICO 50 2T 90-02, XR6 RACING CAT. C/AVV.ELETT. 50 2T 90-02
RIEJU	MRT 50 2T 09-12, MRT 50 EU4 50 2T 18-20, MRT PRO 50 2T 09-12, MRT PRO EU4 50 2T 18-20, MRT PRO REPLICA EU4 50 2T 18-20, MRT PRO REPLICA SM EU4 50 2T 18-20, MRT PRO SM 50 2T 09-12, MRT PRO SM EU4 50 2T 18-20, MRT TROPHY EU4 50 2T 18-20, MRX 50 2T 01-04, MRX PRO 50 2T 01-04, RR 50 2T 05-06, RS1 50 2T 98-01, RS2 MATRIX 50 2T 05-06, RS2 MATRIX PRO 50 2T 05-06, RS2 NAKED 50 2T 04-05, RS3 EU4 50 2T 18-20, RS3 NKD EU4 50 2T 18-20, SMX E.S./K.S. 50 2T 01-01, SMX PRO E.S./K.S. 50 2T 03-03, SPIKE 50 2T 98-01
SHERCO	FACTORY SE-R EU4 50 2T 18-20, FACTORY SE-RS EU4 50 2T 18-20, FACTORY SILVER SM-R EU4 50 2T 18-20, FACTORY SILVER SM-RS EU4 50 2T 18-20, FACTORY SM-R EU4 50 2T 18-20, FACTORY SM-RS EU4 50 2T 18-20, HRD ENDURO 50 2T 09-13, HRD MOTARD 50 2T 09-13
VENT	BAJA 50 2T 18-20, BAJA RR 50 2T 18-20, DERAPAGE 50 2T 18-20, DERAPAGE RR 50 2T 18-20
YAMAHA	DT R 50 2T 03-11, DT RSM 50 2T 03-05, DT X 50 2T 06-11, TZR 50 2T 03-08, TZR 50 2T 10-11, TZR RR 50 2T 05-05

ATTENZIONE: QUESTI PRODOTTI SONO DESTINATI ESCLUSIVAMENTE AD USO AGONISTICO. NE È QUINDI VIETATO L'UTILIZZO SU STRADA PUBBLICA.



◀ cod. **9926330**

Gruppo termico Ø 44 per Yamaha Giggie 50 cc 4T
Cilindro in alluminio | Cilindrata 64,28 cc - Corsa mm 43,6 - Rapp. Comp. 1:12

RICAMBI

992634A	Pistone completo Ø 44
992634B	Pistone completo Ø 44
992634C	Pistone completo Ø 44
9926360	Serie segmenti Ø 44

9926350	Serie guarnizioni
9926290	Spinotto + anellini
9928060	Centralina TFI programmata
9928070	Cablaggio TFI



◀ cod. **9934300**

Gruppo termico Ø 47 spinotto Ø 12 motori scooter 50 cc Minarelli/Yamaha

APPLICABILITÀ

Malaguti F10 AC ECO 50 2T 09-10, F12 R PHANTOM AC 50 2T 09-10

RICAMBI

9925250	Pistone completo
9906052	Serie segmenti
9925260	Serie guarnizioni
9906470	Testa



◀ cod. **9908660**

Gruppo termico Ø 47 per motori Peugeot Air Cooled
Cilindro in ghisa Minacrom con 5 travasi | Cilindrata 67,8 cc - Corsa mm 39,1 - Rapp. Comp. 1:11,5 | Completo di testa
Pistone con riporto di stagno

RICAMBI

9915030	Pistone completo Ø 47
9915031	Pistone completo Ø 47,5
9910410	Serie segmenti Ø 47

9910310	Serie guarnizioni
9910400	Testa



◀ cod. **9917390**

Gruppo termico Ø 47 per motore Derbi Senda - Bultaco Lobito
Cilindro in ghisa Minacrom 6 travasi | Cilindrata 69,4 cc - Corsa mm. 40 | Completo di testa

RICAMBI

9918220	Pistone completo Ø 47
9918221	Pistone completo Ø 47,4
9918230	Serie segmenti Ø 47

9918231	Serie segmenti Ø 47,4
9924710	Serie guarnizioni
9918250	Testa



◀ cod. **9919540**

Gruppo termico Ø 47 per motori Peugeot Speedfight liquid cooled
Cilindro in ghisa Minacrom | Cilindrata 69,98 cc - Corsa mm. 39,2 - Rapp. Comp. 1:13 | Completo di testa

RICAMBI

9915030	Pistone completo Ø 47
9915031	Pistone completo Ø 47,4
9910410	Serie segmenti Ø 47

9910412	Serie segmenti Ø 47,4
9920210	Serie guarnizioni
9919590	Testa



◀ cod. **9924890**

Gruppo termico Ø 47 Keeway - CPI
Cilindro in ghisa Minacrom con 6 travasi | Cilindrata 67,97 cc - Corsa mm 39,2 - Rapp. Comp. 1:12,5 | Completo di testa

RICAMBI

9925250	Pistone completo Ø 47
9925251	Pistone completo Ø 47,4
9906052	Serie segmenti Ø 47

9906054	Serie segmenti Ø 47,4
9925260	Serie guarnizioni
9906470	Testa



◀ cod. **9925800**

Gruppo termico Ø 47 per Peugeot Ludix 50 cc
Cilindro in ghisa Minacrom con 6 travasi | Cilindrata 69,01 cc - Corsa mm 39,8 - Rapp. Comp. 1:12,7 | Completo di testa

RICAMBI

9915030	Pistone completo Ø 47
9915031	Pistone completo Ø 47,4
9910410	Serie segmenti Ø 47

9910412	Serie segmenti Ø 47,4
9927890	Serie guarnizioni
9910400	Testa



◀ cod. **9931310**

Gruppo termico Black Trophy Ø 47 Liquid Cooled per motori scooter 50 cc Minarelli/Yamaha
Cilindro in ghisa Minacrom con 8 travasi | Cilindrata 68 cc - Corsa mm 39,2 - Rapp. Comp.: 1:13 | Completo di testa

RICAMBI

9931330	Pistone completo MoS2 Ø 47
9906044	Pistone completo Ø 47,4
9906052	Serie segmenti Ø 47
9906054	Serie segmenti Ø 47,4

9910060	Serie guarnizioni
9909540	Testa
9910050	Accessori Testa

ATTENZIONE: QUESTI PRODOTTI SONO DESTINATI ESCLUSIVAMENTE AD USO AGONISTICO. NE È QUINDI VIETATO L'UTILIZZO SU STRADA PUBBLICA.



cod. **9931340**

Gruppo termico Black Trophy Ø 47 Air Cooled per motori scooter 50 cc Minarelli/Yamaha orizzontale

Cilindro in ghisa Minacrom con 5 travasi | Cilindrata 68 cc – Corsa mm 39,2 – Rapp. Comp. 1:12,5 | Completo di testa

RICAMBI

9931330	Pistone completo MoS2 Ø 47
9906044	Pistone completo Ø 47,4
9906052	Serie segmenti Ø 47

9906054	Serie segmenti Ø 47,4
9907060	Serie guarnizioni
9906470	Testa



cod. **9931370**

Gruppo termico Black Trophy Ø 47 Air Cooled per motori scooter 50 cc Minarelli/Yamaha verticale

Cilindro in ghisa Minacrom con 5 travasi | Cilindrata 68 cc – Corsa mm 39,2 – Rapp. Comp. 1:12,3 | Completo di testa

RICAMBI

9931330	Pistone completo MoS2 Ø 47
9906044	Pistone completo Ø 47,4
9906052	Serie segmenti Ø 47

9906054	Serie segmenti Ø 47,4
9906760	Serie guarnizioni
9907490	Testa



cod. **9931250**

Gruppo termico Black Trophy Ø 48 Air Cooled per motori Piaggio 50 cc

Cilindro in ghisa Minacrom con 6 travasi | Cilindrata 71 cc – Corsa mm 39,3 – Rapp. Comp. 1:12,3 | Completo di testa

RICAMBI

9931230	Pistone completo MoS2 Ø 48
9933411	Pistone completo Ø 48,5
9931240	Serie segmenti Ø 48

9931241	Serie segmenti Ø 48,5
9908180	Serie guarnizioni
9913110	Testa



cod. **9931270**

Gruppo termico Black Trophy Ø 48 Liquid Cooled per motori Piaggio 50 cc con raccordo

Cilindro in ghisa Minacrom con 6 travasi | Cilindrata 71 cc – Corsa mm 39,3 – Rapp. Comp.: 1:12 | Completo di testa

RICAMBI

9931230	Pistone completo MoS2 Ø 48
9933411	Pistone completo Ø 48,5
9931240	Serie segmenti Ø 48
9931241	Serie segmenti Ø 48,5

9914270	Serie guarnizioni
9912640	Testa
9915950	Raccordo per testa



◀ cod. **9919250**

Gruppo termico Ø 49 per motori Minarelli AM6 EU1 AM345/6

Cilindro in ghisa Minacrom 5 travasi | Cilindrata 73,5 cc - Corsa mm. 39 - Rapp. Comp. 1:12,5 | Completo di testa

RICAMBI

9906830	Pistone completo Ø 49
9906831	Pistone completo Ø 49,5
9906840	Serie segmenti Ø 49
9906841	Serie segmenti Ø 49,5

9907070	Serie guarnizioni
9906670	Testa
9906600	Spinotto



◀ cod. **9925150**

Gruppo termico Ø 49 per Piaggio 50 cc 4T

Cilindro in ghisa Minacrom | Cilindrata 78,78 cc - Corsa mm 41,8 - Rapp. Comp. 1:12

RICAMBI

9925490	Pistone completo Ø 49
9925491	Pistone completo Ø 49,5
9925550	Serie segmenti Ø 49

9925551	Serie segmenti Ø 49,5
9925570	Serie guarnizioni



◀ cod. **9928300**

Gruppo termico Ø 49 per Piaggio 4T 4V

Cilindro in ghisa Minacrom | Cilindrata 78,78 cc - Corsa mm 41,8 - Rapp. Comp. 1:12

RICAMBI

9925490	Pistone completo Ø 49
9925491	Pistone completo Ø 49,5
9925550	Serie segmenti Ø 49

9925551	Serie segmenti Ø 49,5
9928280	Serie guarnizioni



◀ cod. **9925140**

Gruppo termico Ø 50 per Kymco 50 cc 4T

Cilindro in ghisa Minacrom | Cilindrata 81,25 cc - Corsa mm 41,4 - Rapp. Comp. 1:12

RICAMBI

9925500	Pistone completo Ø 50
9925501	Pistone completo Ø 50,5
9925560	Serie segmenti Ø 50

9925561	Serie segmenti Ø 50,5
9925580	Serie guarnizioni

ATTENZIONE: QUESTI PRODOTTI SONO DESTINATI ESCLUSIVAMENTE AD USO AGONISTICO. NE È QUINDI VIETATO L'UTILIZZO SU STRADA PUBBLICA.



cod. 9927020

Gruppo termico Ø 50 per Derbi Senda (d50b0) motore Piaggio

Cilindro in ghisa Minacrom con 7 travasi | Cilindrata 78 cc - Corsa mm 40 - Rapp. Comp. 1:14 | Completo di testa

RICAMBI

9927010	Pistone completo Ø 50
9927011	Pistone completo Ø 50,4
9924150	Segmento Ø 50
9924151	Segmento Ø 50,4
9930240	Serie guarnizioni

9930280	Testa
9928090	Raccordo testa
9929480	Serie prigionieri M7 x 115
9930270	Tappo cilindrico
9924250	Spinotto + anellini

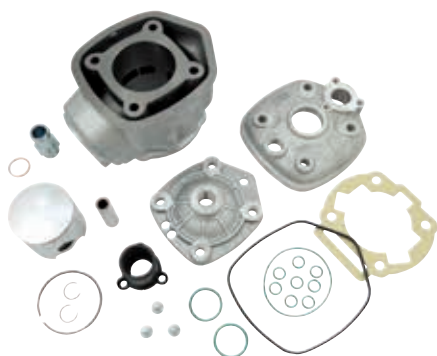

cod. 9928030

Gruppo Termico Ø 50 Motore Derbi Senda (Ebs050)

APPLICABILITÀ

DERBI GPR NUDE 50 2T 04-05, GPR R 50 2T 97-00, GPR RACING 50 2T 04-05, GPR REPLICA 50 2T 99-01, GPR REPLICA RACING 50 2T 02-03, GPR REPLICA RACING EU2 50 2T 05-05, SENDA BLACK EDITION 50 2T 03-03, SENDA R 50 2T 99-01, SENDA R DRD BLACK DEVIL 2A EDIZIONE 50 2T 03-03, SENDA R DRD EU1 EU1R 50 2T 02-02, SENDA R DRD RACING 50 2T 04-05, SENDA R DRD RACING LTD 50 2T 05-05, SENDA R RACER 50 2T 03-03, SENDA R X-RACE 50 2T 04-05, SENDA R X-TREME 50 2T 03-03, SENDA R X-TREME 50 2T 05-05, SENDA R X-TREME EU2 50 2T 04-04, SENDA SM 50 2T 00-01, SENDA SM DRD EDITION BLACK 50 2T 05-05, SENDA SM DRD EU1 EU1R 50 2T 02-03, SENDA SM DRD RACING 50 2T 04-05, SENDA SM DRD RACING LTD 50 2T 05-05, SENDA SM X-RACE 50 2T 04-05, SENDA SM X-TREME 50 2T 02-03, SENDA SM X-TREME EU2 50 2T 04-04, SENDA SM X-TREME EU2 2A EDIZIONE 50 2T 05-05

GILERA GSM 50 2T 01-01, RCR 50 2T 03-03, SMT 50 2T 03-03

RICAMBI

9927011	Pistone completo Ø 50,4
9927010	Pistone completo Ø 50
9924151	Segmento Ø 50,4
9924150	Segmento Ø 50
9930260	Serie guarnizioni Ø 39,885

9930320	Testa Ø 50
9928050	Raccordo testa Ø 39,885
9929960	Raccordo cilindro Ø 39,885
9924250	Spinotto + anellini



cod. 9911090

Kit di trasformazione raffreddamento da aria ad acqua per motori Minarelli/Yamaha tipo orizzontale

Parte termica standard e pompa per il raffreddamento forzato, completa di dispositivi per la sua applicazione

RICAMBI

9931330	Pistone completo Ø 47
9931331	Pistone completo Ø 47,4
9906052	Serie segmenti Ø 47
9906054	Serie segmenti Ø 47,4
9910060	Serie guarnizioni

9905910	Spinotto
9909540	Testa
9911080	Coperchio volano completo
9931310	Gruppo termico Ø 47 Black Trophy
9910050	Accessori per testa



◀ cod. **9925180**

Kit gruppo termico Ø 63 con centralina per Yamaha X-MAX 125 cc 4T
Cilindro in alluminio | Cilindrata 182,67 cc - Corsa mm 58,6 - Rapp. Comp. 1:11,5 | Completo di testa

RICAMBI

992539A	Pistone completo Ø 63
992539B	Pistone completo Ø 63
992539C	Pistone completo Ø 63
9925400	Serie segmenti Ø 63
9925590	Serie guarnizioni

9926720	Cablaggio per centralina TFI
9926710	Centralina TFI completa
9926730	Emulatore sonda Lambda
9926870	Gruppo termico Ø 63



◀ cod. **9926900**

Kit gruppo termico Ø 63 con centralina per Yamaha YZF R 125 cc 4t
Cilindro in alluminio | Cilindrata 182,67 cc - Corsa mm. 58,6 - Rapp. Comp. 1:11,5

RICAMBI

992539A	Pistone completo Ø 63
992539B	Pistone completo Ø 63
992539C	Pistone completo Ø 63
9925400	Serie segmenti Ø 63

9925590	Serie guarnizioni
9926870	Gruppo termico Ø 63
9926720	Cablaggio per centralina TFI
9926890	Centralina TFI completa



◀ cod. **9927120**

Gruppo termico Ø 63 per Fantic Caballero 125 cc 4t
Cilindro in alluminio | Cilindrata 182,67 cc - Corsa mm. 58,6 - Rapp. Comp. 1:11,5

RICAMBI

992539A	Pistone completo Ø 63
992539B	Pistone completo Ø 63
992539C	Pistone completo Ø 63

9925400	Serie segmenti Ø 63
9925590	Serie guarnizioni
9927670	Serie getti



◀ cod. **9927260**

Kit gruppo termico Ø 63 con centralina per Yamaha WR R 125 cc 4t
Cilindro in alluminio | Cilindrata 182,67 cc - Corsa mm. 58,6 - Rapp. Comp. 1:11,5

RICAMBI

992539A	Pistone completo Ø 63
992539B	Pistone completo Ø 63
992539C	Pistone completo Ø 63
9925400	Serie segmenti Ø 63

9925590	Serie guarnizioni
9926870	Gruppo termico Ø 63
9926720	Cablaggio per centralina TFI
9927250	Centralina TFI completa

ATTENZIONE: QUESTI PRODOTTI SONO DESTINATI ESCLUSIVAMENTE AD USO AGONISTICO. NE È QUINDI VIETATO L'UTILIZZO SU STRADA PUBBLICA.

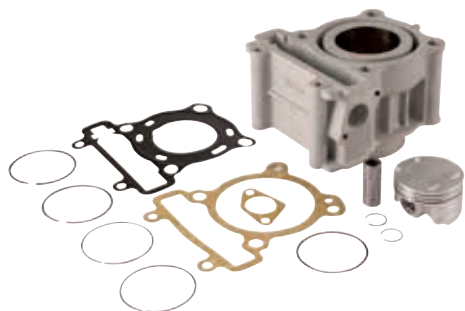

◀ cod. **9932700**
 Gruppo termico Ø 52 per motori Minarelli/Yamaha X-Max 125 cc 4T 4v
 Cilindro in alluminio | Cilindrata 124,6 cc - Corsa 58,6 - Rapp. Comp. 11,2:1

RICAMBI

9932750	Pistone completo Ø 52
9932760	Serie segmenti Ø 52

9932770	Serie guarnizioni
---------	-------------------



◀ cod. **9929650**
 Gruppo termico Ø 52,4 per Honda SH 125cc
 Cilindro in alluminio | Cilindrata 124,6 cc - Corsa mm 57,8 - Rapp. Comp. 1:11,5

RICAMBI

9929680	Pistone completo Ø 52,4
9929720	Serie segmenti Ø 52,4

9929750	Serie guarnizioni
---------	-------------------



◀ cod. **9929450**
 Gruppo termico Ø 58 per Honda SH 125cc
 Cilindro in alluminio | Cilindrata 152,7 cc - Corsa mm 57,8 - Rapp. Comp. 1:13,5

RICAMBI

9929520	Pistone completo Ø 58
9929560	Serie segmenti Ø 58

9929630	Serie guarnizioni
---------	-------------------



◀ cod. **9929950**
 Gruppo termico Ø 58 per Honda SH 150 cc
 Cilindro in alluminio | Cilindrata 152,7 cc - Corsa mm 57,8 - Rapp. Comp. 1:13,5

RICAMBI

9929520	Pistone completo Ø 58
9929560	Serie segmenti Ø 58

9929630	Serie guarnizioni
---------	-------------------



◀ cod. **9929380**
 Gruppo termico Ø 62,2 per Yamaha Majesty 125/150 cc
 Cilindro in ghisa | Cilindrata 166 cc - Corsa mm 58,4 - Rapp. Comp. 1:11,7

RICAMBI

9929390	Pistone completo Ø 62,2
9929391	Pistone completo Ø 62,7
9929410	Serie segmenti Ø 62,2

9929411	Serie segmenti Ø 62,7
9929400	Serie guarnizioni

ATTENZIONE: QUESTI PRODOTTI SONO DESTINATI ESCLUSIVAMENTE AD USO AGONISTICO. NE È QUINDI VIETATO L'UTILIZZO SU STRADA PUBBLICA.



◀ cod. **9926850**
Gruppo termico Ø 69 per Yamaha Majesty 250 cc
Cilindro in ghisa | Cilindrata 249,66 cc - Corsa mm. 66,8 - Rapp. Comp. 1:10,1

RICAMBI

9930470	Pistone completo Ø 69
9930380	Serie segmenti Ø 69

9930430	Serie guarnizioni
---------	-------------------



◀ cod. **9936650**
Gruppo termico Ø 52,4 Honda Pcx / Sh 125 Abs dal '13

APPLICABILITÀ

HONDA FORZA 125 4T-2V 13-17, PCX 125 4T-2V 13-17, SH I ABS 125 4T-2V 13-17

RICAMBI

9936520	Pistone completo Ø 52,4
9936560	Serie segmenti Ø 52,4
9936630	Serie guarnizioni



◀ cod. **9936950**
Gruppo termico Ø 58 Honda Pcx / Sh 150 Abs dal '13

APPLICABILITÀ

HONDA PCX 150 4T-2V 13-17, SH I ABS 150 4T-2V 13-17

RICAMBI

9937020	Pistone completo Ø 58
9937060	Serie segmenti Ø 58
9937130	Serie guarnizioni



◀ cod. **9937450**
Gruppo termico Ø 58 HONDA PCX / SH 125 ABS dal 2013

APPLICABILITÀ

HONDA FORZA 125 4T-2V 13-17, PCX 125 4T-2V 13-17, SH I ABS 125 4T-2V 13-17

RICAMBI

9937480	Pistone completo Ø 58
9937060	Serie segmenti Ø 58
9937130	Serie guarnizioni



cod. **9911210** **RACING**

Kit Racing di trasformazione raffreddamento da aria ad acqua per motori Minarelli/Yamaha 50 cc orizzontale
Parte termica racing e pompa per il raffreddamento forzato, con tutti i dispositivi per la sua applicazione

RICAMBI

9910550	Pistone completo Ø 47
9908801	Pistone completo Ø 47,4
9908770	Segmento Ø 47
9908771	Segmento Ø 47,4
9910060	Serie guarnizioni

9910120	Testa
9910050	Accessori per testa
9905910	Spinotto
9912800	Gruppo termico Ø 47 "Due plus"
9911080	Coperchio volano completo



cod. **9912800** **RACING**

Gruppo termico Ø 47 Racing "Due Plus" per motori Minarelli/Yamaha 50 cc Liquid Cooled
Cilindro in ghisa Minacrom con 8 travasi | Cilindrata 67,9 cc - Corsa mm. 39,2 - Rapp. Comp. 1:14 | Completo di testa

RICAMBI

9910550	Pistone completo Ø 47
9908801	Pistone completo Ø 47,4
9908770	Segmento Ø 47
9908771	Segmento Ø 47,4

9910060	Serie guarnizioni
9910120	Testa
9910050	Accessori per testa
9905910	Spinotto



cod. **9921160** **RACING**

Gruppo termico Ø 47 Racing "Due Plus" con testa scomposta per motori Minarelli/Yamaha 50 cc Liquid Cooled
Cilindro in ghisa Minacrom con 8 travasi | Cilindrata 68,3 cc - Corsa mm. 39,2 - Rapp. Comp. 1:14 | Completo di testa

RICAMBI

9910550	Pistone completo Ø 47
9908801	Pistone completo Ø 47,4
9908770	Segmento Ø 47
9908771	Segmento Ø 47,4
9921310	Serie guarnizioni

9920500	Testa scomponibile
9910050	Accessori per testa
9905910	Spinotto
9914540	Gabbia a rulli

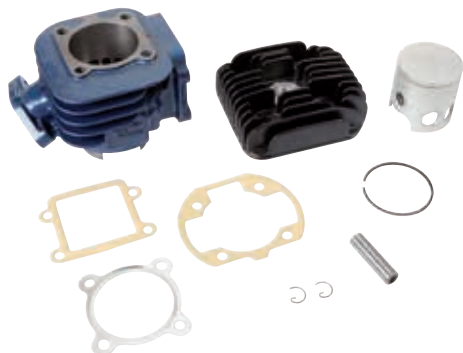

cod. **9930000** **RACING**

Gruppo termico Ø 47 Racing "Gold line" per motori Minarelli/Yamaha tipo verticale
Cilindro in ghisa Minacrom 7 travasi | Cilindrata 67,9 cc - Corsa mm. 39,2 - Rapp. Comp. 1:13,7 | Completo di testa

RICAMBI

9908800	Pistone completo Ø 47
9908801	Pistone completo Ø 47,4
9908770	Segmento Ø 47
9908771	Segmento Ø 47,4

9906760	Serie guarnizioni
9930020	Testa Black
9905910	Spinotto

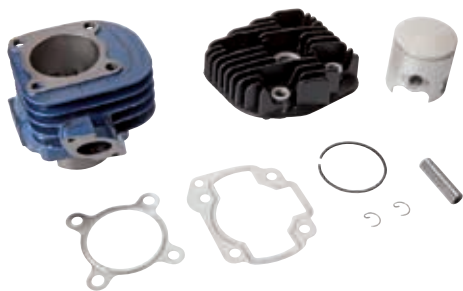

cod. **9930030** **RACING**

Gruppo termico "Gold Line" Ø 47 Racing per motori Minarelli/Yamaha
tipo orizzontale air cooled

Cilindro in ghisa Minacrom 8 travasi | Cilindrata 67,9 cc - Corsa mm. 39,2 - Rapp. Comp. 1:13,6 | Completo di testa

RICAMBI

9908800	Pistone completo Ø 47
9908801	Pistone completo Ø 47,4
9908770	Segmento Ø 47
9908771	Segmento Ø 47,4

9907060	Serie guarnizioni
9930050	Testa Black
9905910	Spinotto

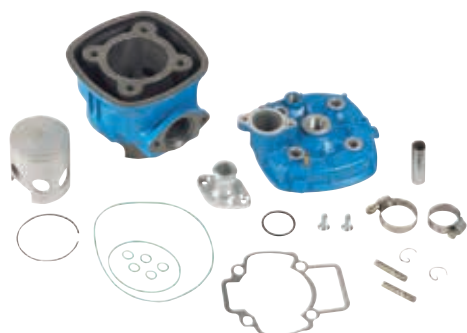

cod. **9920590** **RACING**

Gruppo termico Ø 47,6 racing "Due Plus" per motori Gilera/Piaggio 50 cc liquid cooled

Cilindro in ghisa Minacrom con 6 travasi | Cilindrata 69,9 cc - Corsa mm. 39,3 - Rapp. Comp. 1:14 | Completo di testa

RICAMBI

9920650	Pistone completo Ø 47,6
9920651	Pistone completo Ø 48
9913700	Segmento Ø 47,6
9913701	Segmento Ø 48

9920660	Serie guarnizioni
9920620	Testa
9915950	Raccordo per testa



cod. **9921550** **RACING**

Gruppo termico Ø 47,6 "TPR" in alluminio per motori Gilera/Piaggio 50 cc air cooled

Cilindro in alluminio | Cilindrata 69,9 cc - Corsa mm. 39,3 - Rapp. Comp. 1:14,7 | Completo di testa

RICAMBI

992153A	Pistone completo Ø 47,6
992153B	Pistone completo Ø 47,6
992153C	Pistone completo Ø 47,6
9921540	Segmento Ø 47,6

9921650	Serie guarnizioni
9913680	Testa
9907820	Gabbia a rulli
9921520	Spinotto Ø 12



cod. **9921630** **RACING**

Gruppo termico Ø 47,6 "TPR" in alluminio per motori scooter 50 cc Minarelli/Yamaha
tipo orizzontale air cooled

Cilindro in alluminio | Cilindrata 69,9 cc - Corsa mm. 39,2 - Rapp. Comp. 1:14,5 | Completo di testa

RICAMBI

992161A	Pistone completo Ø 47,6
992161B	Pistone completo Ø 47,6
992161C	Pistone completo Ø 47,6
9921540	Segmento Ø 47,6

9907060	Serie guarnizioni
9910540	Testa
9914540	Gabbia a rulli
9921600	Spinotto Ø 10

ATTENZIONE: QUESTI PRODOTTI SONO DESTINATI ESCLUSIVAMENTE AD USO AGONISTICO. NE È QUINDI VIETATO L'UTILIZZO SU STRADA PUBBLICA.



cod. 9921640 **RACING**

Gruppo termico Ø 47,6 "TPR" in alluminio per motori scooter 50 cc Minarelli/Yamaha tipo verticale air cooled
Cilindro in alluminio | Cilindrata 69,9 cc - Corsa mm. 39,2 - Rapp. Comp. 1:14,5 | Completo di testa

RICAMBI

992161A	Pistone completo Ø 47,6
992161B	Pistone completo Ø 47,6
992161C	Pistone completo Ø 47,6
9921540	Segmento Ø 47,6

9906760	Serie guarnizioni
9908790	Testa
9914540	Gabbia a rulli
9921600	Spinotto Ø 10

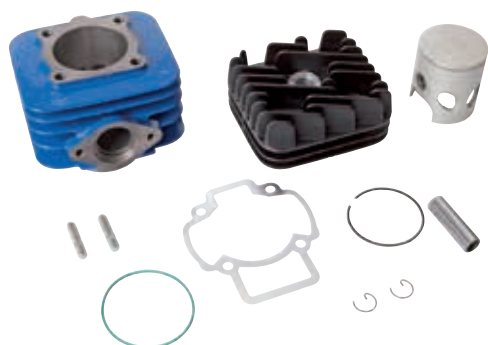

cod. 9930060 **RACING**

Gruppo termico Ø 47,6 Racing "Gold line" per motori Gilera/Piaggio 50 cc air cooled
Cilindro in ghisa Minacrom 6 travasi di cui 4 contrapposti (2 posizionati posteriormente per ottimizzare il riempimento)
| Cilindrata 69,9 cc - Corsa mm. 39,3 - Rapp. Comp. 1:13,5 | Completo di testa

RICAMBI

9920650	Pistone completo Ø 47,6
9920651	Pistone completo Ø 48
9913700	Segmento Ø 47,6

9913701	Segmento Ø 48
9914290	Serie guarnizioni
9930080	Testa Black



cod. 9919240 **RACING**

Gruppo termico Ø 49,5 Racing per motori Minarelli 50 cc AM6 EU1 AM345/6
Cilindro in ghisa Minacrom 5 travasi | Cilindrata 75 cc - Corsa mm. 39 - Rapp. Comp. 1:13 | Completo di testa

RICAMBI

9915780	Pistone completo Ø 49,5
9915781	Pistone completo Ø 49,7
9915710	Segmento Ø 49,5
9915711	Segmento Ø 49,7

9907070	Serie guarnizioni
9915870	Testa
9906600	Spinotto



cod. 9921150 **RACING**

Gruppo termico Ø 49,5 Racing "Due plus" con testa scomposta per motori Minarelli 50 cc AM
Cilindro in ghisa Minacrom 5 travasi | Cilindrata 75 cc - Corsa mm 39 - Rapp. Comp. 1:14,5 | Completo di testa

RICAMBI

9915780	Pistone completo Ø 49,5
9915781	Pistone completo Ø 49,7
9915710	Segmento Ø 49,5
9915711	Segmento Ø 49,7

9921320	Serie guarnizioni
9920530	Testa scomponibile
9921330	Gabbia a rulli
9906600	Spinotto



cod. **9921450** **RACING**

Gruppo termico Ø 49,5 **Maxi Kit** Racing per motori Minarelli AM 50 cc
Cilindro in ghisa Minacrom | Cilindrata 85 cc - Corsa mm. 44 - Rapp. Comp. 1:14,7 | Completo di testa

RICAMBI

9921760	Gruppo termico Ø 49,5
9915780	Pistone completo Ø 49,5
9915781	Pistone completo Ø 49,7
9915710	Segmento Ø 49,5
9915711	Segmento Ø 49,7
9921320	Serie guarnizioni

9921460	Testa scomponibile
9906600	Spinotto
9920410	Albero motore
9921330	Gabbia a rulli
9921770	Chiavetta
9924750	Kit cuscinetti paraoli banco

NB: il codice 9921760 deve essere tassativamente montato con il codice 9920410.



cod. **9924130** **RACING**

Gruppo termico Ø 50 "TPR" in alluminio per motori Minarelli AM 50 cc
Cilindro in alluminio | Cilindrata 76,5 cc - Corsa mm 39 - Rapp. Comp. 1:14 | Completo di testa

RICAMBI

992414A	Pistone completo Ø 50
992414B	Pistone completo Ø 50
992414C	Pistone completo Ø 50
9924150	Segmento Ø 50
9924160	Serie guarnizioni

9920530	Testa scomponibile
9921330	Gabbia a rulli
9924250	Spinotto e anellini
9924110	Boccola riduzione scarico Ø 28/32mm
9924120	Boccola scarico Ø 32 mm



cod. **9924240** **RACING**

Gruppo termico Ø 50 **Maxi Kit** "TPR" per motori Minarelli AM 50 cc
Cilindro in alluminio | Cilindrata 86 cc - Corsa mm 44 - Rapp. Comp. 1:14,2 | Completo di testa

RICAMBI

9924230	Gruppo termico Ø 50
992414A	Pistone completo Ø 50
992414B	Pistone completo Ø 50
992414C	Pistone completo Ø 50
9924150	Segmento Ø 50
9924160	Serie guarnizioni
9921460	Testa scomponibile

9924110	Boccola Ø 28/32 mm
9924120	Boccola Ø 32 mm scarico
9924250	Spinotto e anellini
9920410	Albero motore
9921770	Chiavetta scarico
9921330	Gabbia a rulli
9924750	Kit cuscinetti paraoli banco

NB: il codice 9924230 deve essere tassativamente montato con il codice 9920410.



cod. **9926560** **RACING**

Gruppo termico Ø 50 **Maxi Kit** "TPR" per motori scooter 50 cc Minarelli/Yamaha liquid cooled corsa 44
Cilindro in alluminio | Cilindrata 86 cc - Corsa mm. 44 - Rapp. Comp. 1:15 | Completo di testa

RICAMBI

9929310	Gruppo termico Ø 50
992414A	Pistone completo Ø 50
992414B	Pistone completo Ø 50
992414C	Pistone completo Ø 50
9924150	Segmento Ø 50
9929330	Serie guarnizioni
9929320	Testa

9924250	Spinotto e anellini
9929480	Serie prigionieri
KK01002	Kit cuscinetti paraoli banco
9925980	Albero motore
9925930	Biella
9921330	Gabbia a rulli

ATTENZIONE: QUESTI PRODOTTI SONO DESTINATI ESCLUSIVAMENTE AD USO AGONISTICO. NE È QUINDI VIETATO L'UTILIZZO SU STRADA PUBBLICA.



cod. **9926580** **RACING**

Gruppo termico Ø 50 **Maxi Kit "TPR"** per motori scooter 50 cc Minarelli/Yamaha liquid cooled corsa 39,2
Cilindro in alluminio | Cilindrata 77 cc - Corsa mm. 39,2 - Rapp. Comp. 1:14,5 | Completo di testa

RICAMBI

9929340	Gruppo termico Ø 50
992414A	Pistone completo Ø 50
992414B	Pistone completo Ø 50
992414C	Pistone completo Ø 50
9924150	Segmento Ø 50
9929330	Serie guarnizioni

9929350	Testa
9924250	Spinotto e anellini
KK01002	Kit cuscinetti e paraoli banco
9926170	Albero motore
9925930	Biella
9921330	Gabbia a rulli



cod. **9928390** **RACING**

Gruppo termico Ø 50 **Maxi Kit "TPR"** per motori scooter 50 cc Piaggio/Gilera/Derbi liquid cooled corsa 39,3
Cilindro in alluminio | Cilindrata 77 cc - Corsa mm. 39,3 - Rapp. Comp. 1:14,5 | Completo di testa

RICAMBI

9929800	Gruppo termico Ø 50
992414A	Pistone completo Ø 50
992414B	Pistone completo Ø 50
992414C	Pistone completo Ø 50
9924150	Segmento Ø 50
9929820	Serie guarnizioni

9929810	Testa
9924250	Spinotto e anellini
KK01009	Kit cuscinetti e paraoli banco
9926220	Albero motore
9929470	Biella
9921330	Gabbia a rulli



cod. **9928440** **RACING**

Gruppo termico Ø 50 **Maxi Kit "TPR"** per motori scooter 50 cc Piaggio/Gilera/Derbi liquid cooled corsa 44
Cilindro in alluminio | Cilindrata 86 cc - Corsa mm. 44 - Rapp. Comp. 1:15 | Completo di testa

RICAMBI

9929840	Gruppo termico Ø 50
992414A	Pistone completo Ø 50
992414B	Pistone completo Ø 50
992414C	Pistone completo Ø 50
9924150	Segmento Ø 50
9929820	Serie guarnizioni

9929850	Testa
9924250	Spinotto e anellini
KK01009	Kit cuscinetti e paraoli banco
9926210	Albero motore
9929470	Biella
9921330	Gabbia a rulli



cod. **9928480** **RACING**

Gruppo Termico Ø 47,6 Spinotto 10 "**TPR 2**" motori scooter 50 cc Minarelli/Yamaha Liquid Cooled

RICAMBI

9914540	Gabbia a rulli
9920500	Testa Scomponibile
9921540	Segmento Ø 47,6
992847A	Pistone Completo Ø 47,6

992847B	Pistone Completo Ø 47,6
992847C	Pistone Completo Ø 47,6
9931280	Serie Guarnizioni

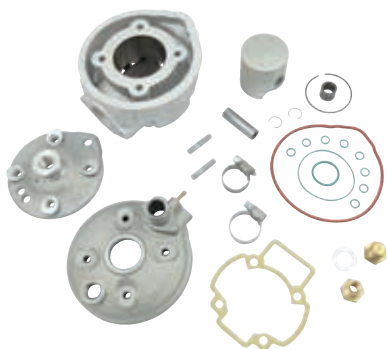

◀ cod. **9928520** **RACING**
Gruppo Termico Ø 47,6 "TPR 2" motori scooter 50 cc Piaggio Liquid Cooled

RICAMBI

9907820	Gabbia a rulli
9921360	Testa Scomponibile
9921540	Segmento Ø 47,6
992851A	Pistone Completo Ø 47,6

992851B	Pistone Completo Ø 47,6
992851C	Pistone Completo Ø 47,6
9931390	Serie Guarnizioni



◀ cod. **9928550** **RACING**
Gruppo Termico Ø 47,6 Spinotto 12 "TPR 2" motori scooter 50 cc Minarelli/Yamaha Liquid Cooled

RICAMBI

9920500	Testa Scomponibile
9921330	Gabbia A Rulli
9921540	Segmento Ø 47,6
992851A	Pistone Completo Ø 47,6

992851B	Pistone Completo Ø 47,6
992851C	Pistone Completo Ø 47,6
9931280	Serie Guarnizioni

NOVITÀ



◀ cod. **9934270** **RACING**
Maxi Kit Racing 86 cc Derbi Senda Ø 50 (D50b0)

APPLICABILITÀ

APRILIA RS 50 2T 06-10, RS4 50 2T 11-13, RS4 REPLICIA 50 2T 14-16, RX 50 2T 06-10, RX 50 2T 14-16, SX 50 2T 06-16, SX LIMITED EDITION 50 2T 14-16

DERBI GPR 2T 50 2T 13-13, GPR 2T EU2 50 2T 09-10, GPR NUDE & GPR NUDE TUNING 50 2T 06-08, GPR NUDE SPORT 50 2T 06-06, GPR R EU2 - GPR REPLICIA EU2 50 2T 08-08, GPR RACING EU2 50 2T 06-06, GPR REPLICIA & GPR R EU2 50 2T 06-06, GPR REPLICIA 2T MALOSSI 50 2T 07-07, GPR REPLICIA PESEK EU2 50 2T 07-07, SENDA HYP DRD EVO EU2 50 2T 08-09, SENDA HYP DRD EVO LIMITED EDITION EU2 50 2T 08-08, SENDA R DRD PRO EU2 50 2T 05-11, SENDA R DRD RACING EU2 50 2T 05-08, SENDA R DRD X-TREME 2T EU2 50 2T 14-15, SENDA R DRD X-TREME 2T EURO2 50 2T 10-12, SENDA R X-RACE 2T EU2 50 2T 10-10, SENDA R X-RACE EU2 50 2T 06-09, SENDA R X-TREME 2T EU2 50 2T 10-10, SENDA R X-TREME EU2 50 2T 05-08, SENDA SM DRD PRO EU2 50 2T 05-11, SENDA SM DRD PRO EU2 2VER 50 2T 05-08, SENDA SM DRD RACING EU2 50 2T 05-08, SENDA SM DRD RACING EU2 50 2T 10-13, SENDA SM DRD RACING LTD EU2 50 2T 07-07, SENDA SM DRD X-TREME 2T EU2 50 2T 14-15, SENDA SM DRD X-TREME 2T EU2 LIMITED ED 50 2T 14-15, SENDA SM X-RACE 2T EU2 50 2T 10-10, SENDA SM X-RACE EU2 50 2T 06-09, SENDA SM X-RACE EU2 2VER 50 2T 07-09, SENDA SM X-TREME 2T EU2 50 2T 10-10, SENDA SM X-TREME EU2 50 2T 05-08

GILERA RCR 50 2T 06-07, RCR 50 2T 11-12, RCR (CHE-SYC) 50 2T 13-15, SMT 50 2T 06-17, SMT RACING 50 2T 11-12

VALENTI RACING RME 50 2T 15-17, SM 50 2T 15-17

RICAMBI

9924150	SEGMENTO D.50 PER GR.TERM.D.50 "TPR"
9924151	SEGMENTO D.50,4 PER GR.TERM.D.50 "TPR"
9924250	SPINOTTO+ANELLINI PER PIST.D.50 "TPR" AM6
9927010	PISTONE COMPL. D.50 PER DERBI SENDA
9927011	PISTONE COMPL. D.50,4 PER DERBI SENDA
9928090	RACCORDO TESTA GT D.39,885 DERBI SENDA (D50B0)
9930210	ALBERO MOTORE CORSA 44MM PER DERBI (D50B0)

9930240	SERIE GUARNIZIONI GT DERBI SENDA (D50B0)
9930270	TAPPO CILINDRICO M16x1,5 C/RONDELLA IN RAME X GT DERBI (D50B0)
9934260	GRUPPO TERM. D.50 PER MAXI KIT 86 cc DERBI (D50B0)
9934280	TESTA D.50 PIAGGIO/DERBI (D50B0) PER CORSA 44MM
AA00766	GABBIA SU SPINOTTO D.12X15X15 AM6-DERBI
KK01008	KIT CUSCIN/PARAOLI BANCO DERBI PLURIMARC

ATTENZIONE: QUESTI PRODOTTI SONO DESTINATI ESCLUSIVAMENTE AD USO AGONISTICO. NE È QUINDI VIETATO L'UTILIZZO SU STRADA PUBBLICA.

CARBURATORE MIKUNI TM 24



◀ cod. **9908730** **RACING**
Carburatore Mikuni TM 24

RICAMBI

9909090	Serie getti per carburatore Mikuni TM 24
9909830	Kit spilli conici per Mikuni TM 24

A RICAMBIO PER

9930830	Kit aspirazione completo "TPR" per scooter 50 cc Minarelli/Yamaha orizzontale collettore 360° - carburatore Mikuni TM 24
9930870	Kit aspirazione completo "TPR" per scooter 50 cc Piaggio - collettore 360° - carburatore Mikuni TM 24

9930910	Kit aspirazione completo "TPR" per AM/Derbi 50 cc - collettore 360° - carburatore Mikuni TM 24
---------	--

FILTRI ARIA **RACING**



◀ cod. **9908680**
Filtro aria per carburatori con diametro attacco filtro 42 mm

◀ cod. **9910200**
Filtro aria per carburatori con diametro attacco filtro 39 mm

◀ cod. **9910300**
Filtro aria per carburatori con diametro attacco filtro 42 mm, completo di manicotto a 90°

◀ cod. **9911680**
Filtro aria per carburatori con diametro attacco filtro 35 mm

ATTENZIONE: QUESTI PRODOTTI SONO DESTINATI ESCLUSIVAMENTE AD USO AGONISTICO. NE È QUINDI VIETATO L'UTILIZZO SU STRADA PUBBLICA.

KIT ASPIRAZIONE - KIT COLLETTORI - CARBURATORE MIKUNI TM 24



◀ cod. **9930820** **RACING**
 Kit collettore "TPR" 360° scooter 50 cc Minarelli/Yamaha orizzontale
 per carburatore Mikuni TM 24

RICAMBI

9929270	Flangia	9929280	Collettore
---------	---------	---------	------------

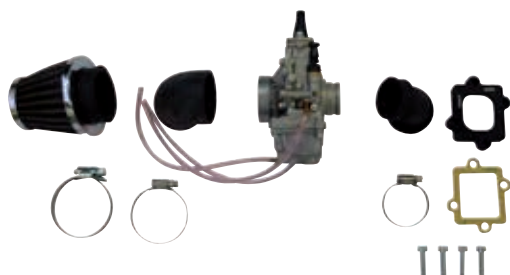

◀ cod. **9930830** **RACING**
 Kit aspirazione completo "TPR" per scooter 50 cc Minarelli/Yamaha orizzontale
 collettore 360° - carburatore Mikuni TM 24

RICAMBI

9908680	Filtro aria	9929270	Flangia
9908730	Carburatore Mikuni TM 24	9929280	Collettore



◀ cod. **9930860** **RACING**
 Kit collettore "TPR" 360° scooter 50 cc Piaggio per carburatore Mikuni TM 24

RICAMBI

9929210	Flangia	9929220	Collettore
---------	---------	---------	------------

ATTENZIONE: QUESTI PRODOTTI SONO DESTINATI ESCLUSIVAMENTE AD USO AGONISTICO. NE È QUINDI VIETATO L'UTILIZZO SU STRADA PUBBLICA.

KIT ASPIRAZIONE - KIT COLLETTORI - CARBURATORE MIKUNI TM 24

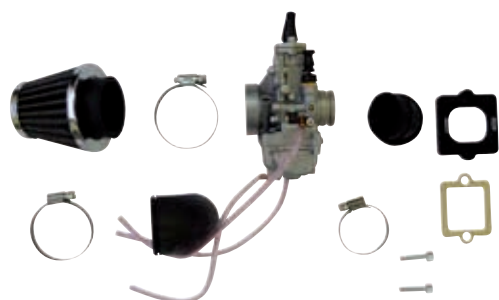

cod. **9930870** **RACING**
 Kit aspirazione completo "TPR" per scooter 50 cc Piaggio
 collettore 360° - carburatore Mikuni TM 24

RICAMBI

9908680	Filtro aria
9908730	Carburatore Mikuni TM 24

9929210	Flangia
9929220	Collettore



cod. **9930900** **RACING**
 Kit collettore "TPR" 360° per AM/Derbi 50 cc per carburatore Mikuni TM 24

RICAMBI

9929240	Flangia
---------	---------

9929250	Collettore
---------	------------

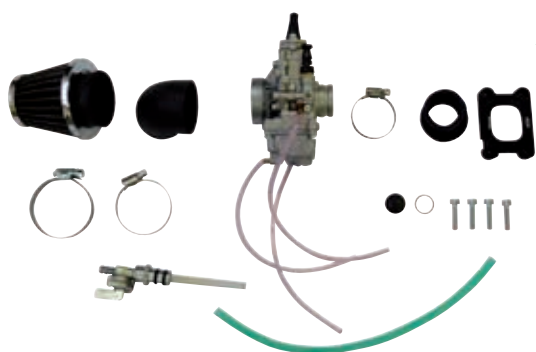

cod. **9930910** **RACING**
 Kit aspirazione completo "TPR" per AM/Derbi 50 cc
 collettore 360° - carburatore Mikuni TM 24

RICAMBI

9908680	Filtro aria
9908730	Carburatore Mikuni TM 24

9929240	Flangia
9929250	Collettore

CARBURATORE OKO 28



◀ cod. **9932000**
Carburatore OKO 28

RACING

A RICAMBIO PER

9931710	Kit aspirazione completo "TPR" per scooter 50 cc Minarelli/Yamaha orizzontale collettore 360° - carburatore OKO 28
9931730	Kit aspirazione completo "TPR" per scooter 50 cc Piaggio collettore 360° - carburatore OKO 28
9931750	Kit aspirazione completo "TPR" per AM/Derbi 50 cc collettore 360° - carburatore OKO 28
9932800	Kit aspirazione completo "TPR" per Vespa Px 125/150 cc - Collettore 360° Oko 28

GETTI

DESCRIZIONE	CODICE	DESCRIZIONE	CODICE
GETTO MINIMO OKO #30	9940300	GETTO MASSIMO OKO #132	9941320
GETTO MINIMO OKO #32	9940320	GETTO MASSIMO OKO #135	9941350
GETTO MINIMO OKO #34	9940340	GETTO MASSIMO OKO #138	9941380
GETTO MINIMO OKO #36	9940360	GETTO MASSIMO OKO #140	9941400
GETTO MINIMO OKO #38	9940380	GETTO MASSIMO OKO #142	9941420
GETTO MINIMO OKO #40	9940400	GETTO MASSIMO OKO #145	9941450
GETTO MINIMO OKO #42	9940420	GETTO MASSIMO OKO #148	9941480
GETTO MINIMO OKO #44	9940440	GETTO MASSIMO OKO #150	9941500
GETTO MINIMO OKO #46	9940460	GETTO MASSIMO OKO #152	9941520
GETTO MINIMO OKO #48	9940480	GETTO MASSIMO OKO #155	9941550
GETTO MINIMO OKO #50	9940500	GETTO MASSIMO OKO #158	9941580
GETTO MINIMO OKO #52	9940520	GETTO MASSIMO OKO #160	9941600
GETTO MINIMO OKO #54	9940540	GETTO MASSIMO OKO #162	9941620
GETTO MINIMO OKO #56	9940560	GETTO MASSIMO OKO #165	9941650
GETTO MINIMO OKO #58	9940580	GETTO MASSIMO OKO #168	9941680
GETTO MINIMO OKO #60	9940600	GETTO MASSIMO OKO #170	9941700
GETTO MASSIMO OKO #100	9941000	GETTO MASSIMO OKO #172	9941720
GETTO MASSIMO OKO #102	9941020	GETTO MASSIMO OKO #175	9941750
GETTO MASSIMO OKO #105	9941050	GETTO MASSIMO OKO #178	9941780
GETTO MASSIMO OKO #108	9941080	GETTO MASSIMO OKO #180	9941800
GETTO MASSIMO OKO #110	9941100	GETTO MASSIMO OKO #182	9941820
GETTO MASSIMO OKO #112	9941120	GETTO MASSIMO OKO #185	9941850
GETTO MASSIMO OKO #115	9941150	GETTO MASSIMO OKO #188	9941880
GETTO MASSIMO OKO #118	9941180	GETTO MASSIMO OKO #190	9941900
GETTO MASSIMO OKO #120	9941200	GETTO MASSIMO OKO #192	9941920
GETTO MASSIMO OKO #122	9941220	GETTO MASSIMO OKO #195	9941950
GETTO MASSIMO OKO #125	9941250	GETTO MASSIMO OKO #198	9941980
GETTO MASSIMO OKO #128	9941280	GETTO MASSIMO OKO #200	9942000
GETTO MASSIMO OKO #130	9941300		

ATTENZIONE: QUESTI PRODOTTI SONO DESTINATI ESCLUSIVAMENTE AD USO AGONISTICO. NE È QUINDI VIETATO L'UTILIZZO SU STRADA PUBBLICA.

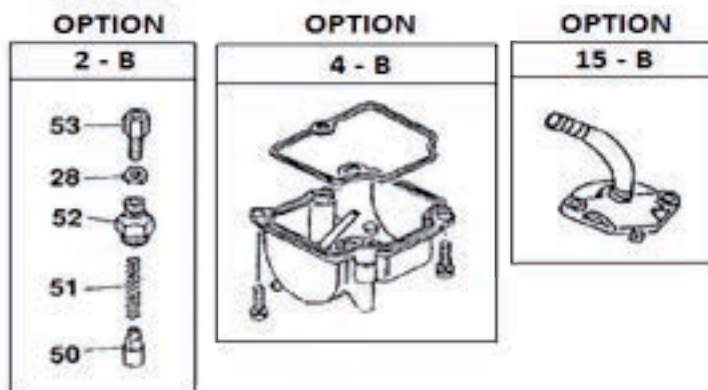
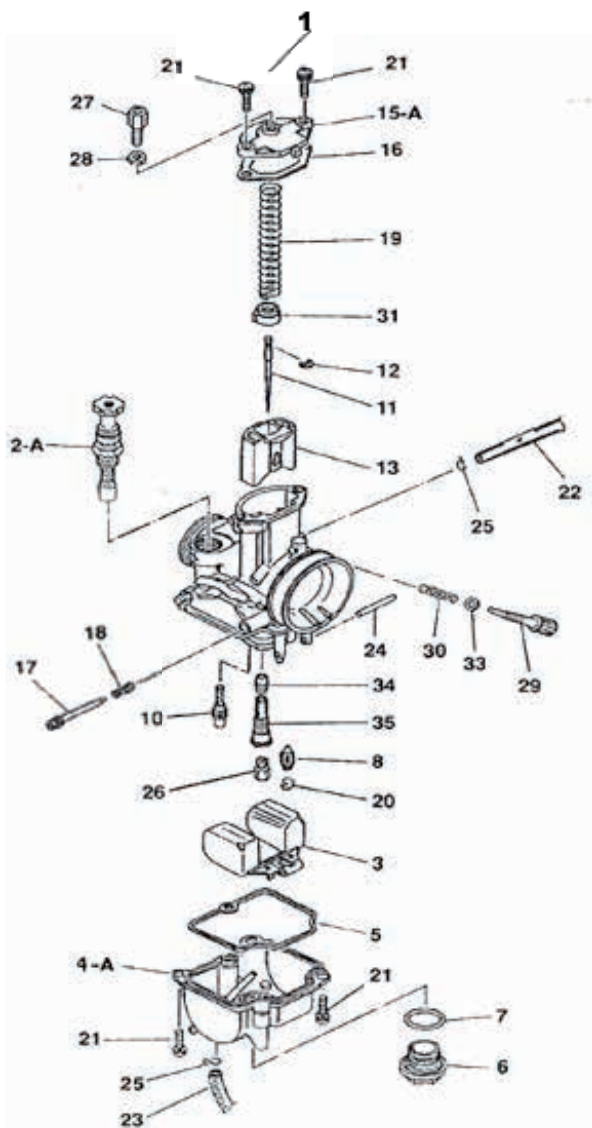

RICAMBI

N°	DESCRIZIONE	CODICE
1	Carburatore OKO 28	9932000
2A	Comando Starter	9932010
2B	Comando Starter a Filo	9932020
3	Galleggiante	9932030
4A	Vaschetta Carburatore	9932040
4B	Vaschetta Carburatore Trasparente	9932050
5	Guarnizione Vaschetta	9932060
6	Tappo Vaschetta	9932070
7	O-Ring Tappo Vaschetta	9932080
8	Spillo Benzina	9932090
10	Getto Minimo #48	9940480
11	Spillo Conico [JJH]	9932110
12	Seeger Spillo Conico	9932120
13	Valvola Gas	9932130
15A	Coperchio Valvola	9932140
15B	Coperchio Valvola con Registro Curvo	9932150
16	Guarnizione Coperchio Valvola	9932160
17	Vite Aria	9932170
18	Molla Vite Aria	9932180
19	Molla Valvola Gas	9932190
20	Seeger Spillo Benzina	9932200
21	Vite fissaggio Vaschetta/Coperchio	9932210
22	Tubetto Sfiato	9932220
23	Tubetto Troppo Pieno	9932230
24	Perno Galleggiante	9932240
25	Seeger Tubetti	9932250
26	Getto Massimo #130	9941300
27	Registro Cavo Gas	9932270
28	Dado Registro Cavo Gas	9932280
29	Vite Registro Valvola Gas	9932290
30	Molla Vite Registro Valvola Gas	9932300
31	Guida Molla Valvola Gas	9932310
33	Rondella Vite Registro Valvola Gas	9932320
34	Ugello Polverizzatore	9932330
35	Polverizzatore	9932340
50	Valvola Starter a Filo	9932350
51	Molla Valvola Starter a Filo	9932360
52	Coperchio Starter a Filo	9932370
53	Registro Starter a Filo	9932380

KIT ASPIRAZIONE - KIT COLLETTORI - CARBURATORE OKO 28



cod. **9931710** **RACING**

Kit aspirazione completo "TPR" per scooter 50 cc Minarelli/Yamaha orizzontale collettore 360° - carburatore OKO 28

RICAMBI

9929270	Flangia
9929290	Collettore

9931770	Filtro aria
9932000	Carburatore OKO 28



cod. **9931700** **RACING**

Kit collettore "TPR" 360° scooter 50 cc Minarelli/Yamaha orizzontale per carburatore OKO 28

RICAMBI

9929270	Flangia
---------	---------

9929290	Collettore
---------	------------



cod. **9931730** **RACING**

Kit aspirazione completo "TPR" per scooter 50 cc Piaggio collettore 360° - carburatore OKO 28

RICAMBI

9929210	Flangia
9929230	Collettore

9931770	Filtro aria
9932000	Carburatore OKO 28



cod. **9931720** **RACING**

Kit collettore "TPR" 360° scooter 50 cc Piaggio per carburatore OKO 28

RICAMBI

9929210	Flangia
---------	---------

9929230	Collettore
---------	------------

ATTENZIONE: QUESTI PRODOTTI SONO DESTINATI ESCLUSIVAMENTE AD USO AGONISTICO. NE È QUINDI VIETATO L'UTILIZZO SU STRADA PUBBLICA.



cod. **9931750** **RACING**

Kit aspirazione completo "TPR" per AM/Derbi 50 cc
collettore 360° - carburatore OKO 28

RICAMBI

9929240	Flangia
9929260	Collettore

9931770	Filtro aria
9932000	Carburatore OKO 28



cod. **9931740** **RACING**

Kit collettore "TPR" 360° AM/Derbi 50 cc per carburatore OKO 28

RICAMBI

9929240	Flangia
---------	---------

9929260	Collettore
---------	------------



cod. **9931770** **RACING**

Filtro aria spugna imbocco Ø 49 mm

A RICAMBIO PER

9931710	Kit aspirazione completo "TPR" per scooter 50 cc Minarelli/Yamaha orizzontale collettore 360° - carburatore OKO 28
9931730	Kit aspirazione completo "TPR" per scooter 50 cc Piaggio collettore 360° - carburatore OKO 28
9931750	Kit aspirazione completo "TPR" per AM/Derbi 50 cc collettore 360° - carburatore OKO 28



cod. **9932800** **RACING**

Kit aspirazione completo per vespa PX 125/150 cc "TPR" collettore 360° - carburatore OKO 28

RICAMBI

9931770	Filtro Aria
9932000	Carburatore Oki 28
9932890	Kit Collettore
9933240	Kit Flangia Inferiore



◀ Serie 6 masse variatore Ø 15x12

APPLICABILITÀ

APRILIA - ATALA - BENELLI - BETA - ITALJET - KTM - MACAL - MALAGUTI - MBK - MOTRON - RIEJU - YAMAHA
 APPLICABILI A TUTTI I VARIATORI TOP PERFORMANCES

Codice	Colore	Peso
9912900	ROSSO	4
9912920	VERDE	4,5
9912910	GIALLO	5

Codice	Colore	Peso
9906140	GRIGIO	5,5
9912940	NERO	6
9915570	NERO	7,5

Codice	Colore	Peso
9927160	NERA	3,8
9912930	AZZURRO	6,5
9925610	ROSSO	6,9



◀ Serie 6 masse variatore Ø 15x12 in alluminio

APPLICABILITÀ

APRILIA - ATALA - BENELLI - BETA - ITALJET - KTM - MACAL - MALAGUTI - MBK - MOTRON - RIEJU - YAMAHA
 APPLICABILI A TUTTI I VARIATORI TOP PERFORMANCES

Codice	Colore	Peso
9912870	FUME	2,5
9912840	ORO	2,8

Codice	Colore	Peso
9912880	BLU	3
9912850	ROSSO	3,3

Codice	Colore	Peso
9912890	VIOLA	3,5
9912860	VERDE	3,8



◀ Serie 6 masse variatore Ø 16x13 per variatori originali

APPLICABILITÀ

BSV - GILERA - HONDA - HSC - PEUGEOT - PIAGGIO

Codice	Colore	Peso
9920030	NERO	4,2
9920040	NERO	4,6
9920050	NERO	5
9914390	ARANCIONE	5,5
9914380	ROSSO	6

Codice	Colore	Peso
9914400	BIANCO	6,5
9914370	VERDE	7
9914410	BLU	7,5
9914360	GIALLO	8
9915400	NERO	8,5

Codice	Colore	Peso
9920060	NERO	8,8
9920070	NERO	9,2
9920080	NERO	9,5
9920090	NERO	9,7
9920100	NERO	10,2



◀ Serie 6 masse variatore Ø 16x13 in alluminio

APPLICABILITÀ

BSV - GILERA - HONDA - HSC - PEUGEOT - PIAGGIO

Codice	Colore	Peso
9911960	ORO	3
9911990	GRIGIO	3,3

Codice	Colore	Peso
9911980	BLU	3,8
9911970	VIOLA	4,2

Codice	Colore	Peso
9911950	VERDE	4,6
9911940	ROSSO	5



◀ Serie 6 masse variatore Ø 17x12,5

APPLICABILITÀ

SUZUKI - MORINI - ITALJET - MALAGUTI - APRILIA SR

Codice	Colore	Peso
9919870	NERO	4
9919880	NERO	4,5
9919890	NERO	5
9919900	NERO	5,5

Codice	Colore	Peso
9915190	NERO	5,9
9919910	NERO	6
9919920	NERO	6,5
9915200	NERO	6,8

Codice	Colore	Peso
9919930	NERO	7
9920540	NERO	7,5
9915210	NERO	11,3



◀ Serie 6 masse variatore Ø 18x13,8

APPLICABILITÀ

KYMCO PEOPLE

Codice	Colore	Peso	Codice	Colore	Peso
9917640	NEUTRA	13	9917660	NEUTRA	12

◀ Serie 6 masse variatore Ø 19x13,8

APPLICABILITÀ

PIAGGIO LIBERTY 125 CC

Codice	Colore	Peso	Codice	Colore	Peso	Codice	Colore	Peso
9922810	ROSSO	10	9922830	VERDE	11	9922850	BIANCO	12

◀ Serie 6 masse variatore Ø 19x15,5

APPLICABILITÀ

DERBI - GILERA - PIAGGIO

Codice	Colore	Peso	Codice	Colore	Peso	Codice	Colore	Peso
9919940	NERO	4,8	9919970	NERO	6	9922890	NERO	7,5
9919950	NERO	5,2	9919980	NERO	6,5	9920000	NERO	8
9919960	NERO	5,6	9919990	NERO	7	9920010	NERO	9

◀ Serie 6 masse variatore Ø 19x17

APPLICABILITÀ

GILERA - PIAGGIO

Codice	Colore	Peso	Codice	Colore	Peso	Codice	Colore	Peso
9922710	ROSSO	5,4	9922790	GIALLO	7,7	9916400	VERDE	10
9922730	VERDE	6,1	9916340	BIANCO	8,5	9916420	NERO	11
9922750	BIANCO	6,6	9916360	ROSSO	9	9915290	GRIGIO	13
9922770	BLU	7,3	9916380	GIALLO	9,5			

◀ Serie 6 masse variatore Ø 20x12

APPLICABILITÀ

MINARELLI / YAMAHA 125-150 CC

Codice	Colore	Peso	Codice	Colore	Peso	Codice	Colore	Peso
9916120	VERDE	8	9915270	GRIGIO	9	9916200	MARRONE	10,5
9916140	NERO	8,5	9916160	AZZURRO	9,5	9916220	BLU	11



◀ Serie 8 masse variatore Ø 20x12

APPLICABILITÀ

MINARELLI / YAMAHA 250 CC

Codice	Colore	Peso	Codice	Colore	Peso	Codice	Colore	Peso
9918280	VERDE	8	9918310	VIOLA	10	9918040	ROSSO	13
9918290	NERO	8,5	9918320	MARRONE	10,5	9918020	GIALLO	14
9918270	GRIGIO	9	9918330	BLU	11			
9918300	AZZURRO	9,5	9918060	BIANCO	12			



◀ Serie 6 masse variatore Ø 20x15

APPLICABILITÀ

KYMCO 125/150 - HONDA SH 125/150

Codice	Colore	Peso
9924280	ROSSO	9
9916650	GIALLO	10
9916670	VERDE	11

Codice	Colore	Peso
9924320	MARRONE	12
9916690	NERO	13
9915820	ROSSO	13,5

Codice	Colore	Peso
9915150	GRIGIO	14,5
9916710	BLU	15,5
9934170	NERO	17,5

◀ Serie 6 masse variatore Ø 20x17

APPLICABILITÀ

APRILIA - PEUGEOT E VARIATORI TOP PERFORMANCES "TPR" COD. 9923460 - 9923550 - 9923600 - 9923650

Codice	Colore	Peso
9922490	ROSSO	6,8
9922510	VERDE	7,5
9916240	GIALLO	8
9916260	VERDE	8,5
9923590	BLU	9
9915310	GRIGIO	9,5

Codice	Colore	Peso
9923510	GIALLO	10
9922530	BIANCO	10,5
9916320	VIOLA	11
9924450	PORPORA	12
9922550	BLU	12,5
9922570	GIALLO	13

Codice	Colore	Peso
9922590	ROSA	13,5
9923620	ROSSO	14
9922630	NERO	14,5
9922650	AZZURRO	15
9922670	NEUTRO	15,5
9922690	ARANCIONE	16

◀ Serie 6 masse variatore Ø 20,6x17,1

APPLICABILITÀ

APRILIA - GILERA - PIAGGIO

Codice	Colore	Peso
9932790	NERO	10,7



◀ Serie 6 masse variatore Ø 21x17,1

APPLICABILITÀ

APRILIA - GILERA - PIAGGIO

Codice	Colore	Peso
9931870	NERO	10,5

Codice	Colore	Peso
9931880	NERO	13,8



◀ Serie 6 masse variatore Ø 23x18

APPLICABILITÀ

HONDA - KYMCO E VARIATORI TOP PERFORMANCES "TPR" COD. 9923670 - 9923750 - 9923790

Codice	Colore	Peso
9931410	NERO	10
9931420	NERO	11
9916020	BIANCO	13
9916040	ROSSO	14

Codice	Colore	Peso
9923810	NEUTRO	15
9924470	ROSSO	16
9931890	NERO	17,5
9916060	GIALLO	18

Codice	Colore	Peso
9932390	NERO	19
9916080	VERDE	20
9916100	NERO	22
9915990	ORO	27

◀ Serie 6 masse variatore Ø 23,8x18

APPLICABILITÀ

SUZUKI

Codice	Colore	Peso
9918390	VERDE	27

Codice	Colore	Peso
9918370	NERO	29

Codice	Colore	Peso
9918350	NEUTRO	31



◀ Serie 8 masse variatore Ø 25x15

APPLICABILITÀ

YAMAHA

Codice	Colore	Peso
9924590	PORPORA	10
9924610	NERO	11
9924630	NEUTRO	12
9924650	ARANCIONE	13

Codice	Colore	Peso
9922130	ROSSO	14
9922150	VERDE	15
9922170	BIANCO	16
9922190	BLU	17

Codice	Colore	Peso
9922210	GIALLO	18
9922230	MARRONE	19
9922250	ROSA	20

◀ Serie 8 masse variatore Ø 25x17

APPLICABILITÀ

PIAGGIO

Codice	Colore	Peso
9924490	ROSSO	14
9924510	VERDE	15

Codice	Colore	Peso
9924530	BIANCO	16
9924550	MARRONE	17

Codice	Colore	Peso
9924570	BLU	20,5



◀ Serie 6 masse variatore Ø 25x22,10

APPLICABILITÀ

PIAGGIO

Codice	Colore	Peso
9922270	ROSSO	20
9922290	VERDE	22

Codice	Colore	Peso
9922310	BIANCO	25
9922330	BLU	28,5

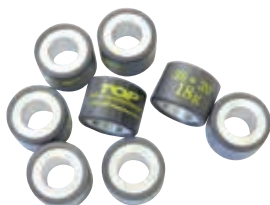

◀ Serie 8 masse variatore Ø 25x17

APPLICABILITÀ

APRILIA - GILERA - PIAGGIO

Codice	Colore	Peso
9935990	NERO	21,4

◀ Serie 8 masse variatore Ø 26x12,90

APPLICABILITÀ

SUZUKI

Codice	Colore	Peso
9922370	VERDE	17
9922390	BIANCO	18

Codice	Colore	Peso
9922410	BLU	19
9918410	NEUTRO	21

Codice	Colore	Peso
9922350	ROSSO	16
9922330	BLU	28,5

◀ Serie 8 masse variatore Ø 28x20

APPLICABILITÀ

HONDA

SW-T 400 [FJS] 400 4T 09-13, Silver Wing 400 [FJS] 400 4T 06-08, SW-T 600 [FJS] 600 4T 11-13, Silver Wing 600 [FJS] 600 4T 01-10

Codice	Colore	Peso
9931810	NERO	18
9931820	NERO	20
9931830	NERO	22

Codice	Colore	Peso
9931840	NERO	25
9931860	NERO	28

NOVITÀ



cod. 9908010

Serie 3 molle contrasto variatore per motori 50 cc Minarelli/Yamaha

cod. 9914440

Molla contrasto variatore colore verde (carico 25 Kg)

cod. 9914430

Molla contrasto variatore colore viola (carico 27 Kg)

cod. 9914420

Molla contrasto variatore colore rosa (carico 29 Kg)

APPLICABILITÀ

APRILIA	AMICO 50 2T 94-94, AMICO 50 2T 96-98, AMICO GL/GLE 50 2T 93-95, AMICO LX/SPORT/CAT 50 2T 92-93, AREA 51 50 2T 98-00, GULLIVER 50 2T 95-98, GULLIVER LC 50 2T 96-98, RALLY 50 2T 95-03, RALLY LIQUID COOLED 50 2T 96-99, SCARABEO 50 2T 93-05, SONIC 50 2T 98-07, SONIC GP 50 2T 98-08, SR (ORIZZONTALE) 50 2T 94-96, SR (VERTICALE) 50 2T 93-93, SR LIQUID COOLED 50 2T 94-96, SR RACING 50 2T 97-99, SR STEALTH 50 2T 97-00, SR WWW 50 2T 97-01
ATALA	CAROSSELLO 50 2T 99-01
BENELLI	491 GT 50 2T 98-99, 491 NAKED 50 2T 02-02, 491 RACING 50 2T 98-99, 491 RR 50 2T 99-01, 491 SP 50 2T 99-99, 491 SPORT 50 2T 98-99, 491 ST 50 2T 99-01, K2 50 2T 98-01, K2 LIQUID COOLED 50 2T 98-01, PEPE 50 2T 99-01, PEPE 50 2T 10-10, PEPE LX 50 2T 03-04, PEPE LX 50 2T 07-09, PEPE OLD 50 2T 07-09, PEPE OLD 50 2T 11-11, QUATTRONEVE 50 2T 08-11
BETA	ARK 50 2T 96-08, ARK LC 50 2T 96-08, CHRONO 50 2T 95-96, EIKON 50 2T 99-03, QUADRA 50 2T 95-95, QUADRA 50 2T 99-01, TEMPO 50 2T 93-02, TEMPO 50 2T 95-95
CPI	ARAGON 50 2T 03-03, HUSSAR 50 2T 03-03, OLIVER 50 2T 03-03, POP CORN 50 2T 03-03
EXPLORER	CRACKER 50 2T 03-03
GARELLI	GPS 50 2T 09-11

ITALJET	DRAGSTER 50 2T 98-02
KEEWAY	F-ACT 50 2T 07-08, FLASH 50 2T 07-08, FOCUS 50 2T 06-06, GOC-CIA 50 2T 09-09, HURRICANE 50 2T 06-08, MATRIX 50 2T 06-08, PIXEL EURO 2 50 2T 09-12, RV8 50 2T 08-08
KTM	K50 50 2T 96-01
MACAL	STING 50 2T 95-96, THUNDER 50 2T 95-96
MALAGUTI	CENTRO SL 50 2T 94-98, CIAK 50 2T 99-01, CIAK EURO 2 2,3 50 2T 03-03, CIAK EURO2 50 2T 01-03, CIAK MASTER EURO 2 50 2T 06-06, F10 50 2T 92-00, F10 AC WAP 50 2T 08-08, F10 EURO 2 50 2T 02-06, F10 EURO 2,2,3 50 2T 03-04, F10 RESTYLING EURO 2 50 2T 06-06, F12 PHANTOM 50 2T 94-98, F12 PHANTOM EURO 2 50 2T 02-02, F12 PHANTOM EURO 2,2,3 50 2T 03-04, F12 PHANTOM LC 50 2T 94-98, F12 PHANTOM LC EURO 2,2,3 50 2T 03-04, F12 R PHANTOM AC 50 2T 07-08, F12 R PHANTOM LC 50 2T 07-10, F12 RESTYLING EURO 1 50 2T 99-02, F12 RESTYLING EURO 2 50 2T 06-06, F12 RESTYLING LC EURO 2 50 2T 06-06, F15 FIRE FOX 50 2T 96-98, F15 FIRE FOX AIR COOLED 50 2T 05-06, F15 FIRE FOX EURO 2 50 2T 02-06, F15 FIRE FOX EURO 2,2,3 50 2T 03-04, YESTERDAY 50 2T 97-00

MBK	BOOSTER 50 2T 90-04, BOOSTER 50 2T 90-94, BOOSTER EURO 2 50 2T 04-04, BOOSTER NG 50 2T 95-03, BOOSTER ROCKET 50 2T 97-98, BOOSTER SPIRIT 50 2T 96-00, BOOSTER SPIRIT 50 2T 03-03, BOOSTER SPIRIT EURO2 50 2T 03-03, BOOSTER TRACK 50 2T 96-98, BOOSTER X IE 50 4T-3V 08-08, EVOLIS 50 2T 92-95, FIZZ 50 2T 94-95, FLIPPER 50 2T 98-04, FLIPPER EURO 2 50 2T 03-03, FORTE 50 2T 94-96, MACH G 50 2T 02-04, MACH G LC 50 2T 02-04, NITRO 50 2T 97-04, NITRO EURO 2 50 2T 03-03, OVETTO 50 2T 97-04, OVETTO 4T 50 4T-3V 09-11, OVETTO EURO 2 50 2T 02-02, STUNT 50 2T 00-02
MOTRON	STING 50 2T 95-96, SYNCRO 50 2T 98-00, THUNDER 50 2T 95-98
PGO	BIG MAX 50 2T 95-97
RIEJU	FIRST 50 2T 95-98, WINDY 50 2T 95-98
YAMAHA	AEROX 50 2T 97-02, AEROX 50 2T 04-16, AEROX EURO 2 50 2T 03-03, AEROX NAKED 50 2T 13-16, AEROX R 50 2T 99-00, AXIS 50 2T 95-96, BREEZE 50 2T 94-95, BW'S 50 2T 97-16, BW'S BUMP 50 2T 97-98, BW'S EASY 50 2T 13-13, BW'S NAKED 50 2T 03-04, BW'S NAKED 50 2T 09-16, BW'S NEXT GENERATION 50 2T 97-06, BW'S ORIGINAL 50 2T 99-01, BW'S ORIGINAL EURO 2 50 2T 03-03, GIGGLE 50 4T-3V 08-08, JOG R 50 2T 02-02, JOG R EURO2 50 2T 02-02, JOG R EURO2 50 2T 06-15, JOG R LC 50 2T 02-15, NEO'S 50 2T 97-02, NEO'S 50 2T 04-16, NEO'S 4 50 4T-3V 09-15, NEO'S EASY 50 2T 13-13, NEO'S EURO 2 50 2T 02-02, RS SPY 50 2T 95-98, SLIDER 50 2T 00-02, WHY 50 2T 98-05, WHY EURO 2 50 2T 03-05, ZEST 50 2T 95-92, ZUMA 50 2T 97-01



cod. 9908470

Serie 3 molle contrasto variatore per motori 50 cc Gilera/Piaggio

cod. 9914800

Molla contrasto variatore colore verde (carico 35 Kg)

cod. 9914810

Molla contrasto variatore colore viola (carico 37,5 Kg)

cod. 9914820

Molla contrasto variatore colore rosa (carico 39,5 Kg)

APPLICABILITÀ

APRILIA	MOJITO CUSTOM 2T MOTORE PIAGGIO 50 2T 04-10, SCARABEO 2T EU2 MOTORE PIAGGIO 50 2T 10-12, SCARABEO 2T NET 50 2T 09-10, SCARABEO 4T 50 4T 02-06, SCARABEO 4T 4V 50 4T-4V 10-12, SCARABEO 4T 4V NET 50 4T-4V 09-10, SCARABEO 4T RESTYLING EU3 50 4T 06-09, SCARABEO QUATTRO 50 4T-4V 09-09, SCARABEO STREET 50 2T 05-06, SCARABEO STREET 2T RESTYLING 50 2T 06-09, SPORT CITY ONE 2T 50 2T 08-11, SPORT CITY ONE 4T 50 4T 08-10, SR MOTARD 50 2T 12-14, SR R 50 2T 04-09, SR R FACTORY CARBURATORE 50 2T 10-14, SR R FACTORY IE 50 2T 10-14, SR STREET CARBURATORE 50 2T 03-12
DERBI	ATLANTIS 2T 50 2T 10-10, ATLANTIS 2T EU2 50 2T 07-09, ATLANTIS 4T 50 4T 04-06, ATLANTIS 4T EU2 50 4T 07-07, ATLANTIS O2 50 2T 02-02, ATLANTIS O2 BULLET 50 2T 03-05, ATLANTIS O2 CITY 50 2T 04-06, ATLANTIS O2 RED BULLET 50 2T 03-03, ATLANTIS O2 TWO CHIC 50 2T 05-05, BOULEVARD 2T 50 2T 09-14, BOULEVARD 4T EU2 25KM/H 50 4T 09-09, GP1 50 2T 01-03, GP1 EU 2 50 2T 05-05, GP1 OPEN EU2 50 2T 06-09, GP1 RACE EU2 50 2T 05-07, SONAR 2T 50 2T 09-09

GILERA	DNA 50 2T 00-02, DNA 50 2T 05-07, DNA GP EXPERIENCE 50 2T 03-04, EASY MOVING 50 2T 95-96, ICE 50 2T 01-05, RUNNER 50 2T 92-00, RUNNER POGGIALI 50 2T 02-02, RUNNER PURE JET 50 2T-IE 02-07, RUNNER PURE JET 50 2T-IE 10-11, RUNNER PURE JET ST 50 2T-IE 08-08, RUNNER SP 50 2T 02-07, RUNNER SP 50 2T 10-12, RUNNER SP SPECIAL EDITION 50 2T 07-07, RUNNER SP ST & SIMONCELLI 50 2T 08-09, STALKER 50 2T 97-11, STALKER NAKED 50 2T 08-08, STALKER SPECIAL EDITION 50 2T 07-08, STORM 50 2T 94-95, STORM EURO 2 50 2T 07-07, TYPHOON 50 2T 94-97, TYPHOON X 50 2T 98-99, TYPHOON XR 50 2T 00-00
ITALJET	JET SET 50 2T 02-02, TORPEDO 50 4T 97-00, TORPEDO NEW 50 2T 00-01
MALAGUTI	CENTRO EURO 2 50 4T 08-08, CENTRO SL 4T 50 4T 10-10, CIAK MASTER 4T 50 4T 05-06, CIAK MASTER EURO 2 50 4T 05-06
PIAGGIO	DIESIS 50 2T 01-01, FLY 2T 50 2T 05-07, FLY 2T 50 2T 10-11, FLY 4T 50 4T 05-07, FLY 4T & 25-30 KM/H 50 4T 08-11, FLY 4T MOTORE CHN 50 4T 06-07, FREE 50 2T 92-94, FREE DELIVERY 50 2T 00-01, FREE FL 50 2T 95-02, LIBERTY 50 2T 97-05, LIBERTY 2T 50 2T 06-08, LIBERTY 2T PTT EU2 50 2T 04-05, LIBERTY 2T RST 50 2T 04-04, LIBERTY 2T SPORT 50 2T 06-08, LIBERTY 4T 50 4T 00-02, LIBERTY 4T 50 4T 05-08, LIBERTY 4T 3V IE 50 4T-3V 15-17, LIBERTY 4T 3V IE E4 50 4T-3V 17-18, LIBERTY 4T DELIVERY - SINGLE 50 4T 10-14, LIBERTY 4T DELIVERY TNT 50 4T 09-09, LIBERTY 4T PTT - DOUBLE - NEXIVE 50 4T 09-17, LIBERTY 4T RST 50 4T 04-04,

LIBERTY 4T SPORT 50 4T 06-08, LIBERTY MOC 2T & ELLE 50 2T 09-13, LIBERTY MOC 4T & ELLE 50 4T 09-16, NRG 50 2T 94-96, NRG EXTREME LC 50 2T 99-00, NRG MC3 50 2T 01-04, NRG POWER DD 50 2T 05-17, NRG POWER DD SERIE SPECIALE 50 2T 07-12, NRG POWER DT 50 2T 06-15, NRG POWER DT SERIE SPECIALE 50 2T 07-08, NRG POWER PUREJET 50 2T-IE 04-11, NRG PUREJET 50 2T-IE 02-04, NRG PUREJET 50 2T-IE 10-10, NRG RST MC2 50 2T 96-98, NTT 50 2T 95-96, QUARTZ 50 2T 92-96, SFERA 50 2T 91-93, SFERA MAQUILLAGE 2 50 2T 94-94, SFERA RST 50 2T 95-97, TYPHOON 50 2T 01-11, TYPHOON 2T E2 50 2T 10-12, TYPHOON 2T E3 CH 50 2T 11-11, VESPA ET2 50 2T 97-05, VESPA ET2 INIEZIONE 50 2T 97-00, VESPA ET4 50 4T 00-05, VESPA LX 2T 50 2T 05-13, VESPA LX 2T TOURING & 30KM 50 2T 10-13, VESPA LX 4T 50 4T 05-09, VESPA LX 4T 4V 50 4T-4V 09-13, VESPA LX 4T 4V TOURING 50 4T-4V 10-13, VESPA LXV 2T 50 2T 06-09, VESPA LXV 2T NAVY 50 2T 08-08, VESPA S 2T & COLLEGE 50 2T 07-12, VESPA S 4T 4V & COLLEGE 50 4T-4V 08-12, ZIP 50 2T 92-93, ZIP 50 2T 95-96, ZIP 2T 50 2T 08-13, ZIP 4T 50 4T 00-13, ZIP BIMODALE 50 2T 94-97, ZIP FAST RIDER 50 2T 93-94, ZIP FAST RIDER RST 50 2T 96-97, ZIP LC 50 2T 00-04, ZIP RST 50 2T 96-99, ZIP SP 50 2T 96-04, ZIP SP EURO 2 50 2T 06-13

MOLLE CONTRASTO VARIATORE



cod. **9925630**

RACING

Serie 3 molle contrasto variatore per motori 50 cc Gilera/Piaggio Racing

cod. **9914450**

Molla contrasto variatore colore giallo (carico 37 Kg)

cod. **9914460**

Molla contrasto variatore colore verde (carico 41 Kg)

cod. **9924970**

Molla contrasto variatore colore rosso (carico 46 Kg)

APPLICABILITÀ

APRILIA MOJITO CUSTOM 2T MOTORE PIAGGIO 50 2T 04-10, SCARABEO 2T EU2 MOTORE PIAGGIO 50 2T 10-12, SCARABEO 2T NET 50 2T 09-10, SCARABEO 4T 50 4T 02-06, SCARABEO 4T 4V 50 4T 4V 10-12, SCARABEO 4T 4V NET 50 4T 4V 09-10, SCARABEO 4T RESTYLING EU3 50 4T 06-09, SCARABEO QUATTRO 50 4T 4V 09-09, SCARABEO STREET 50 2T 05-06, SCARABEO STREET 2T RESTYLING 50 2T 06-09, SPORT CITY ONE 2T 50 2T 08-11, SPORT CITY ONE 4T 50 4T 08-10, SR MOTARD 50 2T 12-14, SR R 50 2T 04-09, SR R FACTORY CARBURATORE 50 2T 10-14, SR R FACTORY IE 50 2T 10-14, SR STREET CARBURATORE 50 2T 03-12

DERBI ATLANTIS 2T 50 2T 10-10, ATLANTIS 2T EU2 50 2T 07-09, ATLANTIS 4T 50 4T 04-06, ATLANTIS 4T EU2 50 4T 07-07, ATLANTIS 02 50 2T 02-02, ATLANTIS 02 BULLET 50 2T 03-05, ATLANTIS 02 CITY 50 2T 04-06, ATLANTIS 02 RED BULLET 50 2T 03-03, ATLANTIS 02 TWO CHIC 50 2T 05-05, BOULEVARD 2T 50 2T 09-14, BOULEVARD 4T EU2 25KM/H 50 4T 09-09, GP1 50 2T 01-03, GP1 EU 2 50 2T 05-05, GP1 OPEN EU2 50 2T 06-09, GP1 RACE EU2 50 2T 05-07, SONAR 2T 50 2T 09-09

GILERA DNA 50 2T 00-02, DNA 50 2T 05-07, DNA GP EXPERIENCE 50 2T 03-04, EASY MOVING 50 2T 95-96, ICE 50 2T 01-05, RUNNER 50 2T 97-00, RUNNER POGGIALI 50 2T 02-02, RUNNER PURE JET 50 2T-IE 02-07, RUNNER PURE JET 50 2T-IE 10-11, RUNNER PURE JET ST 50 2T-IE 08-08, RUNNER SP 50 2T 02-07, RUNNER SP 50 2T 10-12, RUNNER SP SPECIAL EDITION 50 2T 07-07, RUNNER SP ST & SIMONCELLI 50 2T 08-09, STALKER 50 2T 97-11, STALKER NAKED 50 2T 08-08, STALKER SPECIAL EDITION 50 2T 07-08, STORM 50 2T 94-95, STORM EURO 2 50 2T 07-07, TYPHOON 50 2T 94-97, TYPHOON X 50 2T 98-99, TYPHOON XR 50 2T 00-00

ITALJET JET SET 50 2T 02-02, TORPEDO 50 4T 97-00, TORPEDO NEW 50 2T 00-01

MALAGUTI CENTRO EURO 2 50 4T 08-08, CENTRO SL 4T 50 4T 10-10, CIAK MASTER 4T 50 4T 05-06, CIAK MASTER EURO 2 50 4T 05-06

PIAGGIO DIESIS 50 2T 01-01, FLY 2T 50 2T 05-07, FLY 2T 50 2T 10-11, FLY 4T 50 4T 05-07, FLY 4T & 25-30 KM/H 50 4T 08-11, FLY 4T MOTORE CHN 50 4T 06-07, FREE 50 2T 92-94, FREE DELIVERY 50 2T 00-01, FREE FL 50 2T 95-02, LIBERTY 50 2T 97-05, LIBERTY 2T 50 2T 06-08, LIBERTY 2T PTT EU2 50 2T 04-05, LIBERTY 2T RST 50 2T 04-04, LIBERTY 2T SPORT 50 2T 06-08, LIBERTY 4T 50 4T 00-02, LIBERTY 4T 50 4T 05-08, LIBERTY 4T 3V IE 50 4T 3V 15-17, LIBERTY 4T 3V IE E4 50 4T 3V 17-18, LIBERTY 4T DELIVERY - SINGLE 50 4T 10-14, LIBERTY 4T DELIVERY TNT 50 4T 09-09, LIBERTY 4T PTT - DOUBLE - NEXIVE 50 4T 09-17, LIBERTY 4T RST 50 4T 04-04, LIBERTY 4T SPORT 50 4T 06-08, LIBERTY MOC 2T & ELLE 50 2T 09-13, LIBERTY MOC 4T & ELLE 50 4T 09-16, NRG 50 2T 94-96, NRG EXTREME LC 50 2T 99-00, NRG MC3 50 2T 01-04, NRG POWER DD 50 2T 05-17, NRG POWER DD SERIE SPECIALE 50 2T 07-12, NRG POWER DT 50 2T 06-15, NRG POWER DT SERIE SPECIALE 50 2T

07-08, NRG POWER PUREJET 50 2T-IE 04-11, NRG PUREJET 50 2T-IE 02-04, NRG PUREJET 50 2T-IE 10-10, NRG RST MC2 50 2T 96-98, NTT 50 2T 95-96, QUARTZ 50 2T 92-96, SFERA 50 2T 91-93, SFERA MAQUILLAGE 2 50 2T 94-94, SFERA RST 50 2T 95-97, TYPHOON 50 2T 01-11, TYPHOON 2T E2 50 2T 10-12, TYPHOON 2T E3 CH 50 2T 11-11, VESPA ET2 50 2T 97-05, VESPA ET2 INIEZIONE 50 2T 97-00, VESPA ET4 50 4T 00-05, VESPA LX 2T 50 2T 05-13, VESPA LX 2T TOURING & 30KM 50 2T 10-13, VESPA LX 4T 50 4T 05-09, VESPA LX 4T 4V 50 4T 4V 09-13, VESPA LX 4T 4V TOURING 50 4T 4V 10-13, VESPA LXV 2T 50 2T 06-09, VESPA LXV 2T NAVY 50 2T 08-08, VESPA S 2T & COLLEGE 50 2T 07-12, VESPA S 4T 4V & COLLEGE 50 4T 4V 08-12, ZIP 50 2T 92-93, ZIP 50 2T 95-96, ZIP 2T 50 2T 08-13, ZIP 4T 50 4T 00-13, ZIP BIMODALE 50 2T 94-97, ZIP FAST RIDER 50 2T 93-94, ZIP FAST RIDER RST 50 2T 96-97, ZIP LC 50 2T 00-04, ZIP RST 50 2T 96-99, ZIP SP 50 2T 96-04, ZIP SP EURO 2 50 2T 06-13

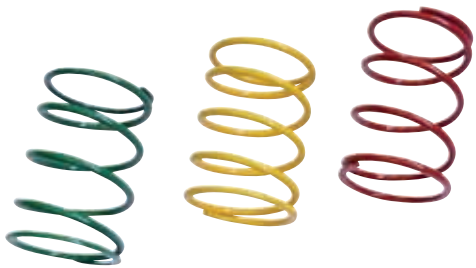

cod. **9925620**

RACING

Serie 3 molle contrasto variatore per motori 50 cc Minarelli/Yamaha Racing

cod. **9914470**

Molla contrasto variatore colore giallo (carico 26 kg)

cod. **9914480**

Molla contrasto variatore colore verde (carico 29 kg)

cod. **9924840**

Molla contrasto variatore colore rosso (carico 32 kg)

APPLICABILITÀ

APRILIA AMICO 50 2T 94-94, AMICO 50 2T 96-98, AMICO GL/GLE 50 2T 93-95, AMICO LX/SPORT/CAT 50 2T 92-93, AREA 51 50 2T 98-00, GULLIVER 50 2T 95-98, GULLIVER LC 50 2T 96-98, RALLY 50 2T 95-03, RALLY LIQUID COOLED 50 2T 96-99, SCARABEO 50 2T 93-05, SONIC 50 2T 98-07, SONIC GP 50 2T 98-08, SR (ORIZZONTALE) 50 2T 94-96, SR (VERTICALE) 50 2T 93-93, SR LIQUID COOLED 50 2T 94-96, SR RACING 50 2T 97-99, SR STEALTH 50 2T 97-00, SR WWW 50 2T 97-01

ATALA CAROSELLO 50 2T 99-01

BENELLI 491 GT 50 2T 98-99, 491 NAKED 50 2T 02-02, 491 RACING 50 2T 98-99, 491 RR 50 2T 99-01, 491 SP 50 2T 99-99, 491 SPORT 50 2T 98-99, 491 ST 50 2T 99-01, K2 50 2T 98-01, K2 LIQUID COOLED 50 2T 98-01, PEPE 50 2T 99-01, PEPE 50 2T 10-10, PEPE LX 50 2T 03-04, PEPE LX 50 2T 07-09, PEPE OLD 50 2T 07-09, PEPE OLD 50 2T 11-11, QUATRONONEX 50 2T 08-11

BETA ARK 50 2T 96-08, ARK LC 50 2T 96-08, CHRONO 50 2T 95-96, EIKON 50 2T 99-03, QUADRA 50 2T 95-95, QUADRA 50 2T 99-01, TEMPO 50 2T 93-02, TEMPO 50 2T 95-95

CPI ARAGON 50 2T 03-03, HUSSAR 50 2T 03-03, OLIVER 50 2T 03-03, POP CORN 50 2T 03-03

EXPLORER CRACKER 50 2T 03-03

GARELLI GPS 50 2T 09-11

ITALJET DRAGSTER 50 2T 98-02

KEEWAY F-ACT 50 2T 07-08, FLASH 50 2T 07-08, FOCUS 50 2T 06-06, GOC-CIA 50 2T 09-09, HURRICANE 50 2T 06-08, MATRIX 50 2T 06-08, PIXEL EURO 2 50 2T 09-12, RY8 50 2T 08-08

KTM K50 50 2T 96-01

MACAL STING 50 2T 95-96, THUNDER 50 2T 95-96

MALAGUTI CENTRO SL 50 2T 94-98, CIAK 50 2T 99-01, CIAK EURO 2 2,3 50 2T 03-03, CIAK EURO2 50 2T 01-03, CIAK MASTER EURO 2 50 2T 06-06, F10 50 2T 92-00, F10 ACWAP 50 2T 08-08, F10 EURO 2 50 2T 02-06, F10 EURO 2 2,3 50 2T 03-04, F10 RESTYLING EURO 2 50 2T 06-06, F12 PHANTOM 50 2T 94-98, F12 PHANTOM EURO 2 50 2T 02-02, F12 PHANTOM EURO 2,3 50 2T 03-04, F12 PHANTOM LC 50 2T 94-98, F12 PHANTOM LC EURO 2 2,3 50 2T 03-04, F12 R PHANTOM AC 50 2T 07-08, F12 R PHANTOM LC 50 2T 07-10, F12 RESTYLING EURO 1 50 2T 99-02, F12 RESTYLING EURO 2 50 2T 06-06, F12 RESTYLING LC EURO 2 50 2T 06-06, F15 FIRE FOX 50 2T 96-98, F15 FIRE FOX AIR COOLED 50 2T 05-06, F15 FIRE FOX EURO 2 50 2T 02-06, F15 FIRE FOX EURO 2 2,3 50 2T 03-04, YESTERDAY 50 2T 97-00

MBK BOOSTER 50 2T 90-04, BOOSTER 50 2T 90-94, BOOSTER EURO 2 50 2T 04-04, BOOSTER NG 50 2T 95-03, BOOSTER ROCKET 50 2T 97-98, BOOSTER SPIRIT 50 2T 96-00, BOOSTER SPIRIT 50 2T 03-03, BOOSTER SPIRIT EURO2 50 2T 03-03, BOOSTER TRACK 50 2T 96-98, BOOSTER XIE 50 4T 3V 08-08, EVOLIS 50 2T 92-95, FIZZ 50 2T 94-95, FLIPPER 50 2T 98-04, FLIPPER EURO 2 50 2T 03-03, FORTE 50 2T 94-96, MACH G 50 2T 02-04, MACH G LC 50 2T 02-04, NITRO 50 2T 97-04, NITRO EURO 2 50 2T 03-03, OVETTO 50 2T 97-04, OVETTO 40 50 4T 3V 09-11, OVETTO EURO 2 50 2T 02-02, STUNT 50 2T 00-02

MOTRON STING 50 2T 95-96, SYNCRO 50 2T 98-00, THUNDER 50 2T 95-98

PGO BIG MAX 50 2T 95-97

RIEJU FIRST 50 2T 95-98, WINDY 50 2T 95-98

YAMAHA AEROX 50 2T 97-02, AEROX 50 2T 04-16, AEROX EURO 2 50 2T 03-03, AEROX NAKED 50 2T 13-16, AEROX R 50 2T 99-00, AXIS 50 2T 95-96, BREEZE 50 2T 94-95, BW'S 50 2T 97-16, BW'S BUMP 50 2T 97-98, BW'S EASY 50 2T 13-13, BW'S NAKED 50 2T 03-04, BW'S NAKED 50 2T 09-16, BW'S NEXT GENERATION 50 2T 97-06, BW'S ORIGINAL 50 2T 99-01, BW'S ORIGINAL EURO 2 50 2T 03-03, GIGGLE 50 4T 3V 08-08, JOG R 50 2T 02-02, JOG R EURO2 50 2T 02-02, JOG R EURO2 50 2T 06-15, JOG R LC 50 2T 02-15, NEO'S 50 2T 97-02, NEO'S 50 2T 04-16, NEO'S 4 50 4T 3V 09-15, NEO'S EASY 50 2T 13-13, NEO'S EURO 2 50 2T 02-02, RS SPY 50 2T 95-98, SLIDER 50 2T 00-02, WHY 50 2T 98-05, WHY EURO 2 50 2T 03-05, ZEST 50 2T 95-92, ZUMA 50 2T 97-01



◀ cod. **9914750**
Molla contrasto variatore colore verde per motori 50 cc Suzuki (carico 35,5 kg)

APPLICABILITÀ

ATALA	HACKER 50 2T 95-00, HACKER LC 50 2T 95-00, VAMOS 50 2T 93-95	MALAGUTI	CROSSER CR1 50 2T 95-98
BENELLI	491 RR MORINI 50 2T 03-04, 491 ST MORINI 50 2T 03-03, NAKED MORINI 50 2T 03-04	SUZUKI	AH ADDRESS 50 2T 92-95, AJ ZZ 50 2T 95-97, AP 50 2T 94-97, ESTILETE UF 50 2T 00-00, KATANA K1-K4 50 2T 01-04, KATANA V-Y 50 2T 97-00, STREET MAGIC 50 2T 98-98, ZILLION UX 50 2T 99-99
ITALJET	FORMULA 50 2T 94-97, FORMULA LC 50 2T 94-97, VELOCIFERO 50 2T 98-02		



◀ cod. **9914760**
Molla contrasto variatore colore rosa per motori 50 cc Suzuki (carico 40 kg)

APPLICABILITÀ

ATALA	HACKER 50 2T 95-00, HACKER LC 50 2T 95-00, VAMOS 50 2T 93-95	MALAGUTI	CROSSER CR1 50 2T 95-98
BENELLI	491 RR MORINI 50 2T 03-04, 491 ST MORINI 50 2T 03-03, NAKED MORINI 50 2T 03-04	SUZUKI	AH ADDRESS 50 2T 92-95, AJ ZZ 50 2T 95-97, AP 50 2T 94-97, ESTILETE UF 50 2T 00-00, KATANA K1-K4 50 2T 01-04, KATANA V-Y 50 2T 97-00, STREET MAGIC 50 2T 98-98, ZILLION UX 50 2T 99-99
ITALJET	FORMULA 50 2T 94-97, FORMULA LC 50 2T 94-97, VELOCIFERO 50 2T 98-02		



◀ cod. **9926760**
Molla contrasto variatore colore giallo per Yamaha X-Max 125 cc (carico 44 kg)

APPLICABILITÀ

MBK	CITYLINER EU3 125 4T-4V 08-10, SKYCRUISER 125 4T-4V 07-07
YAMAHA	X-CITY EU3 125 4T-4V 08-11, X-MAX R 125 4T-4V 06-16, X-MAX R ABS 125 4T-4V 11-11, X-MAX RA ABS 125 4T-4V 13-16

◀ cod. **9926770**
Molla contrasto variatore colore bianco per Honda SH 125/150 cc (carico 44,5 kg)

APPLICABILITÀ

HONDA	@ [NES] 125 4T 00-06, DYLAN [SES] 125 4T 02-04, PANTHEON IE [FES] 125 4T-2V 03-05, PS I [PES] 125 4T 06-10, SH 125 4T-2V 01-04, SH IE SCOOPY 125 4T-2V 05-12, SILVER WING [FES] 125 4T-2V 07-12, @ [NES] 150 4T 00-06, DYLAN [SES] 150 4T 02-04, PANTHEON IE [FES] 150 4T-2V 03-05, PS I [PES] 150 4T 06-10, SH 150 4T-2V 01-04, SH IE SCOOPY 150 4T 05-12, SILVER WING [FES] 150 4T-2V 07-12
KEEWAY	OUTLOOK 125 4T 07-08, OUTLOOK 150 4T 07-08

◀ cod. **9926780**
Molla contrasto variatore colore bianco per Piaggio 500 cc (carico 78 kg)

APPLICABILITÀ

APRILIA	ATLANTIC ARRECIFE 400 4T 05-08, ATLANTIC SPRINT 400 4T 05-08, SCARABEO LIGHT 400 4T 06-08, ATLANTIC 500 4T 01-04, ATLANTIC ARRECIFE 500 4T 05-08, ATLANTIC SPRINT 500 4T 05-08, SCARABEO 500 4T 03-06, SCARABEO LIGHT 500 4T 06-08	PIAGGIO	BEVERLY EU3 400 4T 06-07, BEVERLY TOURER EU3 400 4T 08-10, MP3 400 4T 07-08, MP3 IE LT TOURING 400 4T 11-11, MP3 IE LT/SPORT 400 4T 08-10, MP3 MIC 400 4T 08-10, MP3 RL TOURING 400 4T 11-11, X-EVO 400 4T 07-11, X8 EU3 400 4T 06-08, BEVERLY 500 4T 02-06, BEVERLY CRUISER 500 4T 07-12, BEVERLY IE EU3 500 4T 06-08, MP3 LT SPORT/BUSINESS 500 4T 11-13, MP3 RL SPORT-BUSINESS 500 4T 11-12, X9 500 4T 01-02, X9 EVOLUTION 500 4T 03-07, X9 EVOLUTION ABS 500 4T 06-07
GILERA	NEXUS 500 4T 03-05		
MALAGUTI	SPIDER MAX GT 500 4T 04-05, SPIDER MAX GT EU3 500 4T 06-06, SPIDER MAX RS 500 4T 08-08		
PEUGEOT	GEOPOLIS IE EU3 400 4T-4V 90-02, SATELIS EU3 400 4T 07-12, GEOPOLIS IE EU3 500 4T-4V 90-02, SATELIS EU3 500 4T 90-02		

◀ cod. **9926790**

Molla contrasto variatore colore bianco per Suzuki Burgman 400 cc (carico 67 kg)

APPLICABILITÀ

SUZUKI AN Burgman 400 K3/K6 400 4T 03-06, AN Burgman 400 K7/LO 400 4T 07-10

◀ cod. **9926800**

Molla contrasto variatore colore bianco per Honda Foresight 250 cc (carico 59 kg)

APPLICABILITÀ

HONDA Foresight 250 [FES] D.D. 250 4T 00-05, Forza 250 [NSS] 250 4T-2V 02-07, Forza X 250 [NSS] 250 4T-2V 05-07, Jazz 250 ES Reflex [NSS] 250 4T-2V 01-04, Jazz 250 Reflex [NSS] 250 4T-2V 01-01

◀ cod. **9929170**

Molla contrasto variatore colore bianco per Yamaha Majesty 125/150 cc (carico 39 kg)

APPLICABILITÀ

BENELLI	VELVET 125 4T 99-01, VELVET 150 4T 99-01	MBK	DOODO 125 4T 00-00, SKYLINER 125 4T 98-02, SKYLINER E 125 4T 03-03, THUNDER 125 4T 01-02, DOODO 150 4T 01-02, SKYLINER 150 4T 00-02, THUNDER 150 4T 01-02
ITALJET	JUPITER 125 4T 01-02, MILLENNIUM 125 4T 00-02, JUPITER 150 4T 01-02, MILLENNIUM 150 4T 00-02	YAMAHA	MAJESTY 125 4T 98-00, MAJESTY (5NR1) 125 4T 01-01, MAJESTY (5NR8) 125 4T 02-02, MAJESTY E 125 4T 03-09, MAXSTER 125 4T 01-02, TEO'S 125 4T 00-00, MAJESTY 150 4T 00-00, MAJESTY (SNS1) 150 4T 01-01, MAJESTY (SNS6) 150 4T 02-02, MAXSTER 150 4T 01-02, TEO'S 150 4T 01-02
MALAGUTI	MADISON 125 4T 99-01, MADISON R RESTYLING 125 4T 02-02, MADISON R RESTYLING EU2 125 4T 03-04, PHANTOM MAX 125 4T 03-03, MADISON T 150 4T 99-01		



◀ cod. **9929870**

Molla contrasto variatore colore giallo per Yamaha X-Max 250 cc (carico 56 kg)

APPLICABILITÀ

APRILIA	LEONARDO 250 4T 99-04, LEONARDO ST 250 4T 01-01	MBK	SKYLINER 250 4T 00-03, SKYLINER ABS 250 4T 03-03
BENELLI	VELVET 250 4T 99-03	YAMAHA	MAJESTY 250 4T 96-03, MAJESTY ABS 250 4T 03-03, MAJESTY DX 250 4T 98-99, X-CITY 250 4T 07-15, X-MAX 250 4T 05-16, X-MAX ABS 250 4T 14-15
ITALJET	JUPITER 250 4T 00-02		
MALAGUTI	MADISON S 250 4T 99-01, PASSWORD 250 4T 05-06, PASSWORD EU3 250 4T 07-08		

◀ cod. **9929880**

Molla contrasto variatore colore giallo per Yamaha T-Max 500 cc (carico 93,5 kg)

APPLICABILITÀ

YAMAHA T-MAX 4BS 500 4T 09-11, T-MAX 4BS ABS 500 4T 08-11, T-MAX 5GJ 500 4T 01-03, T-MAX 5VU 500 4T 04-08, T-MAX 5VU ABS 500 4T 05-07, T-MAX 5VU BLACK MAX 500 4T 06-06, T-MAX 5VU BLACK MAX - NIGHT MAX 500 4T 07-07, T-MAX 59C 530 4T 12-16, T-MAX 59C ABS 530 4T 12-16, T-MAX 59C SP 530 4T 15-15, T-MAX 59C SP ABS 530 4T 15-16, XP530-A T-MAX SX 530 4T 17-19, XP530D-A T-MAX DX 530 4T 17-19, XP530E-A T-MAX 530 4T 17-18

◀ cod. **9929890**

Molla contrasto variatore colore giallo per Honda SH 300 cc (carico 68 kg)

APPLICABILITÀ

HONDA SH IE SCOOPY 300 4T-4V 07-19



◀ **cod. 9908240**
Set 3 serie molle per frizione a 2 ceppi con campana Ø interno 105 mm, carico differenziato

Codice	Colore	Carico kg
9908100	VERDE	8
9908220	VIOLA	10,5
9908230	ROSA	12,8

APPLICABILITÀ

- APRILIA** AMICO 50 2T 94-94, AMICO 50 2T 96-98, AMICO GL/GLE 50 2T 93-95, AMICO LX/SPORT/CAT 50 2T 92-93, AREA 51 50 2T 98-00, GULLIVER 50 2T 95-98, GULLIVER LC 50 2T 96-98, RALLY 50 2T 95-03, RALLY LIQUID COOLED 50 2T 96-99, SCARABEO 50 2T 93-05, SONIC 50 2T 98-07, SONIC GP 50 2T 98-08, SR (ORIZZONTALE) 50 2T 94-96, SR (VERTICALE) 50 2T 93-93, SR LIQUID COOLED 50 2T 94-96, SR RACING 50 2T 97-99, SR STEALTH 50 2T 97-00, SR WWW 50 2T 97-01
- ATATA** CAROSSELLO 50 2T 99-01
- BENELLI** 491 GT 50 2T 98-99, 491 NAKED 50 2T 02-02, 491 RACING 50 2T 98-99, 491 RR 50 2T 99-01, 491 SP 50 2T 99-99, 491 SPORT 50 2T 98-99, 491 ST 50 2T 99-01, K2 50 2T 98-01, K2 LIQUID COOLED 50 2T 98-01, PEPE 50 2T 99-01, PEPE 50 2T 10-10, PEPE LX 50 2T 03-04
- BETA** ARK 50 2T 96-08, ARK LC 50 2T 96-08, CHRONO 50 2T 95-96, EIKON 50 2T 99-03, QUADRA 50 2T 95-95, QUADRA 50 2T 99-01, TEMPO 50 2T 93-02, TEMPO 50 2T 95-95
- ITALJET** BAZOOKA 50 2T 91-94, DRAGSTER 50 2T 98-02, PISTA 50 2T 92-97, PISTA 2 50 2T 97-98, SCOOP 50 2T 91-95, SCOOP 2 50 2T 96-98, YANKEE 50 2T 93-97

- KTM** K50 50 2T 96-01
- MACAL** THUNDER 50 2T 95-96
- MALAGUTI** CENTRO SL 50 2T 94-98, CIAK 50 2T 99-01, CIAK EURO 2,2,3 50 2T 03-03, CIAK EURO2 50 2T 01-03, F10 50 2T 92-00, F10 EURO 2 50 2T 02-06, F10 EURO 2,2,3 50 2T 03-04, F12 PHANTOM 50 2T 94-98, F12 PHANTOM EURO 2,2,3 50 2T 03-04, F12 PHANTOM LC 50 2T 94-98, F12 PHANTOM LC EURO 2,2,3 50 2T 03-04, F12 RESTYLING EURO 2 50 2T 06-06, F15 FIRE FOX 50 2T 96-98, F15 FIRE FOX EURO 2 50 2T 02-03, F15 FIRE FOX EURO 2,2,3 50 2T 03-04, YESTERDAY 50 2T 97-00
- MBK** BOOSTER 50 2T 90-04, BOOSTER 50 2T 90-94, BOOSTER EURO 2 50 2T 04-04, BOOSTER NG 50 2T 95-03, BOOSTER ROCKET 50 2T 97-98, BOOSTER SPIRIT 50 2T 96-00, BOOSTER SPIRIT 50 2T 03-03, BOOSTER SPIRIT EURO2 50 2T 03-03, BOOSTER TRACK 50 2T 96-98, FLIPPER 50 2T 98-04, FLIPPER EURO 2 50 2T 03-03, MACH G 50 2T 02-04, MACH G LC 50 2T 02-04, NITRO 50 2T 97-04, NITRO EURO 2 50 2T 03-03, OVETTO 50 2T 97-04, OVETTO EURO 2 50 2T 02-02, SORRISO 50 2T 95-96, STUNT 50 2T 00-02, TARGET 50 2T 91-95

- MOTRON** SYNCRO 50 2T 98-00, THUNDER 50 2T 95-98
- RIEJU** FIRST 50 2T 95-98, WINDY 50 2T 95-98
- YAMAHA** AEROX 50 2T 97-02, AEROX 50 2T 04-16, AEROX EURO 2 50 2T 03-03, AEROX NAKED 50 2T 13-16, AEROX R 50 2T 99-00, BW'S 50 2T 97-16, BW'S BUMP 50 2T 97-98, BW'S EASY 50 2T 13-13, BW'S NAKED 50 2T 03-04, BW'S NAKED 50 2T 09-16, BW'S NEXT GENERATION 50 2T 97-06, BW'S ORIGINAL 50 2T 99-01, BW'S ORIGINAL EURO 2 50 2T 03-03, CRZ 50 2T 91-95, CT 50 2T 90-95, JOG R 50 2T 02-02, JOG R EURO2 50 2T 02-02, JOG R EURO2 50 2T 06-15, JOG R LC 50 2T 02-15, NEO'S 50 2T 97-02, NEO'S 50 2T 04-16, NEO'S EASY 50 2T 13-13, NEO'S EURO 2 50 2T 02-02, RS SPY 50 2T 95-98, SLIDER 50 2T 00-02, WHY 50 2T 98-05, WHY EURO 2 50 2T 03-05, ZUMA 50 2T 97-01



◀ **cod. 9911250**
Set 3 serie molle per frizione a 3 ceppi con campana Ø interno 105 mm e 107 mm
(cod. 9911060 cod. 9910020)

Codice	Colore	Carico kg
9908440	GIALLO	6,3
9911250	VERDE	9
9908450	VIOLA	13

APPLICABILITÀ

- APRILIA** AMICO 50 2T 94-94, AMICO 50 2T 96-98, AMICO GL/GLE 50 2T 93-95, AMICO LX/SPORT/CAT 50 2T 92-93, AREA 51 50 2T 98-00, GULLIVER 50 2T 95-98, GULLIVER LC 50 2T 96-98, MOJITO CUSTOM 2T MOTORE PIAGGIO 50 2T 04-10, RALLY 50 2T 95-03, RALLY LIQUID COOLED 50 2T 96-99, SCARABEO 50 2T 93-05, SCARABEO 2T EU2 MOTORE PIAGGIO 50 2T 10-12, SCARABEO 2T NET 50 2T 09-10, SCARABEO 4T 50 4T 02-06, SCARABEO 4T 4V 50 4T 4V 10-12, SCARABEO 4T 4V NET 50 4T 4V 09-10, SCARABEO 4T RESTYLING EU3 50 4T 06-09, SCARABEO QUATTRO 50 4T 4V 09-09, SCARABEO STREET 50 2T 05-06, SCARABEO STREET 2T RESTYLING 50 2T 06-09, SONIC 50 2T 98-07, SONIC GP 50 2T 98-08, SPORT CITY ONE 2T 50 2T 08-11, SPORT CITY ONE 4T 50 4T 08-10, SR (ORIZZONTALE) 50 2T 94-96, SR (VERTICALE) 50 2T 93-93, SR LIQUID COOLED 50 2T 94-96, SR MOTARD 50 2T 12-14, SR R 50 2T 04-09, SR R FACTORY CARBURATORE 50 2T 10-14, SR R FACTORY IE 50 2T 10-14, SR RACING 50 2T 97-99, SR STEALTH 50 2T 97-00, SR STREET CARBURATORE 50 2T 03-12, SR WWW 50 2T 97-01
- ATATA** CAROSSELLO 50 2T 99-01
- BENELLI** 491 GT 50 2T 98-99, 491 NAKED 50 2T 02-02, 491 RACING 50 2T 98-99, 491 RR 50 2T 99-01, 491 SP 50 2T 99-99, 491 SPORT 50 2T 98-99, 491 ST 50 2T 99-01, K2 50 2T 98-01, K2 LIQUID COOLED 50 2T 98-01, PEPE 50 2T 99-01, PEPE 50 2T 10-10, PEPE LX 50 2T 03-04
- BETA** ARK 50 2T 96-08, ARK LC 50 2T 96-08, CHRONO 50 2T 95-96, EIKON 50 2T 99-03, QUADRA 50 2T 95-95, QUADRA 50 2T 99-01, TEMPO 50 2T 93-02, TEMPO 50 2T 95-95
- BSV** DIO GP 50 2T 94-96, DIO SP 50 2T 94-96, DIO ZX 50 2T 94-96
- DERBI** ATLANTIS 2 50 2T 10-10, ATLANTIS 2T EU2 50 2T 07-09, ATLANTIS 02 50 2T 02-02, ATLANTIS 02 BULLET 50 2T 03-05, ATLANTIS 02 CITY 50 2T 04-06, ATLANTIS 02 RED BULLET 50 2T 03-03, ATLANTIS 02 TWO CHIC 50 2T 05-05, BOULEVARD 2 50 2T 09-14, GP1 50 2T 01-03, GP1 EU 2 50 2T 05-05, GP1 OPEN EU2 50 2T 06-09, GP1 RACE EU2 50 2T 05-07, SONAR 2 50 2T 09-09

- GILERA** DNA 50 2T 00-02, DNA 50 2T 05-07, DNA GP EXPERIENCE 50 2T 03-04, EASY MOVING 50 2T 95-96, ICE 50 2T 01-05, RUNNER 50 2T 97-00, RUNNER POGGIALI 50 2T 02-02, RUNNER SP 50 2T 02-07, RUNNER SP 50 2T 10-12, RUNNER SP SPECIAL EDITION 50 2T 07-07, RUNNER SP ST & SIMONCELLI 50 2T 08-09, STALKER 50 2T 97-11, STALKER NAKED 50 2T 08-08, STALKER SPECIAL EDITION 50 2T 07-08, STORM 50 2T 94-95, STORM EURO 2 50 2T 07-07, TYPHOON 50 2T 94-97, TYPHOON X 50 2T 98-99
- HONDA** BALI 50 2T 93-99, DIO ZX 50 2T 94-96, SFX / SXR 50 2T 95-01, SGX SKY 50 2T 97-04, SH NEW 50 2T 96-01
- HSC** SC 01 50 2T 94-96, SC 01 L 50 2T 94-96
- ITALJET** BAZOOKA 50 2T 91-94, DRAGSTER 50 2T 98-02, JET SET 50 2T 02-02, PISTA 50 2T 92-97, PISTA 2 50 2T 97-98, SCOOP 50 2T 91-95, SCOOP 2 50 2T 96-98, TORPEDO NEW 50 2T 00-01, YANKEE 50 2T 93-97
- KTM** K50 50 2T 96-01
- KYMCO** AGILITY R12 50 4T 05-05
- MACAL** THUNDER 50 2T 95-96
- MALAGUTI** CENTRO SL 50 2T 94-98, CIAK 50 2T 99-01, CIAK EURO 2,2,3 50 2T 03-03, CIAK EURO2 50 2T 01-03, F10 50 2T 92-00, F10 EURO 2 50 2T 02-06, F10 EURO 2,2,3 50 2T 03-04, F12 PHANTOM 50 2T 94-98, F12 PHANTOM EURO 2 50 2T 02-02, F12 PHANTOM LC EURO 2,2,3 50 2T 03-04, F12 RESTYLING EURO 1 50 2T 99-02, F12 RESTYLING EURO 2 50 2T 06-06, F15 FIRE FOX 50 2T 96-98, F15 FIRE FOX EURO 2 50 2T 02-03, F15 FIRE FOX EURO 2,2,3 50 2T 03-04, YESTERDAY 50 2T 97-00
- MBK** BOOSTER 50 2T 90-04, BOOSTER 50 2T 90-94, BOOSTER EURO 2 50 2T 04-04, BOOSTER NG 50 2T 95-03, BOOSTER ROCKET 50 2T 97-98, BOOSTER SPIRIT 50 2T 96-00, BOOSTER SPIRIT 50 2T 03-03, BOOSTER SPIRIT EURO2 50 2T 03-03, BOOSTER TRACK 50 2T 96-98, FLIPPER 50 2T 98-04, FLIPPER EURO 2 50 2T 03-03, MACH G 50 2T 02-04, MACH G LC 50 2T 02-04, NITRO 50 2T 97-04, NITRO EURO 2 50 2T 03-03, OVETTO 50 2T 97-04, OVETTO EURO 2 50 2T 02-02, SORRISO 50 2T 95-96, STUNT 50 2T 00-02, TARGET 50 2T 91-95
- MOTRON** SYNCRO 50 2T 98-00, THUNDER 50 2T 95-98

- PEUGEOT** BUXY 50 2T 90-02, BUXY RS 50 2T 90-02, ELYSEO 50 2T 90-02, JET FORCE 50 2T 90-02, LOOXOR 50 2T 90-02, METAL X 50 2T 90-02, SPEEDAKE 50 2T 90-02, SPEEDFIGHT 50 2T 97-04, SPEEDFIGHT LC 50 2T 97-04, SQUAB 50 2T 90-02, SV GEO 50 2T 90-02, TREFKOR 50 2T 90-02, VIVACITY 50 2T 90-02, X-FIGHT 50 2T 00-02, X-FIGHT LC 50 2T 00-02, ZENITH 50 2T 90-02
- PIAGGIO** DIESIS 50 2T 01-01, FLY 2T 50 2T 05-07, FLY 2T 50 2T 10-11, FLY 4T 50 4T 05-07, FLY 4T & 25-30 KM/H 50 4T 08-11, FLY 4T MOTORE CHN 50 4T 06-07, FREE 50 2T 92-94, FREE DELIVERY 50 2T 00-01, LIBERTY 50 2T 97-05, LIBERTY 2T 50 2T 06-08, LIBERTY 2T PTT EU2 50 2T 04-05, LIBERTY 2T RST 50 2T 04-04, LIBERTY 2T SPORT 50 2T 06-08, LIBERTY 4T 50 4T 00-02, LIBERTY 4T 50 4T 05-08, LIBERTY 4T 3V IE 50 4T-3V 15-17, LIBERTY 4T 3V IE E4 50 4T-3V 17-18, LIBERTY 4T DELIVERY - SINGLE 50 4T 10-14, LIBERTY 4T DELIVERY TNT 50 4T 09-09, LIBERTY 4T PTT - DOUBLE - NEXIVE 50 4T 09-17, LIBERTY 4T RST 50 4T 04-04, LIBERTY 4T SPORT 50 4T 06-08, LIBERTY MOC 2T & ELLE 50 2T 09-13, LIBERTY MOC 4T & ELLE 50 4T 09-16, NRG 50 2T 94-96, NRG POWER DT 50 2T 06-15, NRG POWER DT SERIE SPECIALE 50 2T 07-08, NRG RST MC2 50 2T 96-98, NTT 50 2T 95-96, QUARTZ 50 2T 92-96, SFERA 50 2T 91-93, SFERA MAQUILLAGE 2 50 2T 94-94, SFERA RST 50 2T 95-97, TYPHOON 2T E2 50 2T 10-12, TYPHOON 2T E3 CH 50 2T 11-11, VESPA ET2 50 2T 97-05, VESPA ET4 50 4T 00-05, ZIP 50 2T 92-93, ZIP 50 2T 95-96, ZIP 4T 50 4T 00-13, ZIP BIMODALE 50 2T 94-97, ZIP FAST RIDER 50 2T 93-94, ZIP FAST RIDER RST 50 2T 96-97, ZIP RST 50 2T 96-99, ZIP SP 50 2T 96-00
- RIEJU** FIRST 50 2T 95-98, WINDY 50 2T 95-98
- YAMAHA** AEROX 50 2T 97-02, AEROX 50 2T 04-16, AEROX EURO 2 50 2T 03-03, AEROX NAKED 50 2T 13-16, AEROX R 50 2T 99-00, BW'S 50 2T 97-16, BW'S BUMP 50 2T 97-98, BW'S EASY 50 2T 13-13, BW'S NAKED 50 2T 03-04, BW'S NAKED 50 2T 09-16, BW'S NEXT GENERATION 50 2T 97-06, BW'S ORIGINAL 50 2T 99-01, BW'S ORIGINAL EURO 2 50 2T 03-03, CRZ 50 2T 91-95, CT 50 2T 90-95, JOG R 50 2T 02-02, JOG R EURO2 50 2T 02-02, JOG R EURO2 50 2T 06-15, JOG R LC 50 2T 02-15, NEO'S 50 2T 97-02, NEO'S 50 2T 04-16, NEO'S EASY 50 2T 13-13, NEO'S EURO 2 50 2T 02-02, RS SPY 50 2T 95-98, SLIDER 50 2T 00-02, WHY 50 2T 98-05, WHY EURO 2 50 2T 03-05, ZUMA 50 2T 97-01



◀ cod. **9912740**

Set 3 serie molle per frizione originale a 3 ceppi con campana Ø interno 107 mm

Codice	Colore	Carico kg
9912690	VERDE	8
9912700	VIOLA	10
9912710	ROSA	12

APPLICABILITÀ

APRILIA AREA 51 50 2T 98-00, GULLIVER 50 2T 95-98, GULLIVER LC 50 2T 96-98, RALLY 50 2T 95-03, RALLY LIQUID COOLED 50 2T 96-99, SCARABEO 50 2T 93-05, SONIC 50 2T 98-07, SONIC GP 50 2T 98-08, SR LIQUID COOLED 50 2T 94-96, SR RACING 50 2T 97-99, SR STEALTH 50 2T 97-00

BENELLI 491 GT 50 2T 98-99, 491 NAKED 50 2T 02-02, 491 RACING 50 2T 98-99, 491 RR 50 2T 99-01, 491 SP 50 2T 99-99, 491 SPORT 50 2T 98-99, 491 ST 50 2T 99-01, K2 50 2T 98-01, K2 LIQUID COOLED 50 2T 98-01, PEPE 50 2T 99-01, PEPE 50 2T 10-10, PEPE LX 50 2T 03-04

BETA ARK 50 2T 96-08, ARK LC 50 2T 96-08, CHRONO 50 2T 95-96, EIKON 50 2T 99-03, QUADRA 50 2T 95-95, QUADRA 50 2T 99-01, TEMPO 50 2T 93-02, TEMPO 50 2T 95-95

GARELLI GPS 50 2T 09-11

ITALJET DRAGSTER 50 2T 98-02

KYMCO AGILITY 4T R10 50 4T 06-08, AGILITY 4T R12 50 4T 07-08, AGILITY R12 50 4T 05-05, AGILITY R16 50 4T 08-09, AGILITY R16 50 4T 12-12, AGILITY R16 2T 50 2T 10-10, AGILITY R16 2T 50 2T 12-12, AGILITY RS 50 4T 09-09, AGILITY RS NAKED 50 2T 10-10, B&W 50 2T 02-02, B&W EU2 50 2T 03-03, CX 50 2T 93-93, CX SUPER 50 2T 94-97, DINK 50 4T 50 4T 07-07, DINK CLASSIC EU2 50 2T 03-03, DJ WORLD 50 2T 94-00, DJ X 50 2T 91-92, DJ Y 50 2T 93-93, FEVER ZX 50 2T 99-00, FEVER ZX EU2 50 2T 03-04, FILLY 50 4T 98-00, FILLY LX 50 4T 01-02, HEROISM 50 2T 95-97, K 12 50 2T 95-00, KB 50 2T 95-00, PEOPLE 50 2T 99-04, PEOPLE EURO 2 50 2T 03-03, PEOPLE EURO 2 50 2T 08-08, PEOPLE S 50 2T 05-08, PEOPLE S 4T 50 4T 06-08, SENTO 50 4T 08-08, SNIPER 50 2T 93-93, SNIPER DD 50 2T 94-96, SUPER 9 50 2T 00-00, SUPER 9 EU2 50 2T 03-04, VITALITY 2T 50 2T 04-04, VITALITY 4T 50 4T 04-04, YUP 50 2T 02-02, YUP EU2 50 2T 03-03

MALAGUTI CIAK 50 2T 99-01, CIAK EURO 2 2,3 50 2T 03-03, CIAK EURO2 50 2T 01-03, CIAK MASTER EURO 2 50 2T 06-06, F10 EURO 2 50 2T 02-06, F10 EURO 2 2,3 50 2T 03-04, F10 RESTYLING EURO 2 50 2T 06-06, F12 PHANTOM 50 2T 94-98, F12 PHANTOM EURO 2 50 2T 02-02, F12 PHANTOM EURO 2 2,3 50 2T 03-04, F12 PHANTOM LC EURO 2 2,3 50 2T 03-04, F12 R PHANTOM LC 50 2T 07-10, F12 RESTYLING EURO 1 50 2T 99-02, F12 RESTYLING EURO 2 50 2T 06-06, F12 RESTYLING LC EURO 2 50 2T 06-06, F15 FIRE FOX 50 2T 96-98, F15 FIRE FOX AIR COOLED 50 2T 05-06, F15 FIRE FOX EURO 2 50 2T 02-06, F15 FIRE FOX EURO 2 2,3 50 2T 03-04, YESTERDAY 50 2T 97-00

MBK BOOSTER 50 2T 90-04, BOOSTER 50 2T 90-94, BOOSTER EURO 2 50 2T 04-04, BOOSTER NG 50 2T 95-03, BOOSTER SPIRIT 50 2T 96-00, BOOSTER SPIRIT 50 2T 03-03, BOOSTER SPIRIT EURO2 50 2T 03-03, BOOSTER X IE 50 4T-3V 08-08, FLIPPER 50 2T 98-04, FLIPPER EURO 2 50 2T 03-03, MACH G 50 2T 02-04, MACH G LC 50 2T 02-04, NITRO 50 2T 97-04, NITRO EURO 2 50 2T 03-03, OVETTO 50 2T 97-04, OVETTO 4T 50 4T-3V 09-11, OVETTO EURO 2 50 2T 02-02, STUNT 50 2T 00-02

YAMAHA AEROX 50 2T 97-02, AEROX 50 2T 04-16, AEROX EURO 2 50 2T 03-03, AEROX NAKED 50 2T 13-16, AEROX R 50 2T 99-00, BW'S 50 2T 97-16, BW'S BUMP 50 2T 97-98, BW'S EASY 50 2T 13-13, BW'S NAKED 50 2T 03-04, BW'S NAKED 50 2T 09-16, BW'S NEXT GENERATION 50 2T 97-06, BW'S ORIGINAL 50 2T 99-01, BW'S ORIGINAL EURO 2 50 2T 03-03, GIGGLE 50 4T-3V 08-08, JOG R 50 2T 02-02, JOG R EURO2 50 2T 02-02, JOG R EURO2 50 2T 06-15, JOG R LC 50 2T 02-15, NEO'S 50 2T 97-02, NEO'S 50 2T 04-16, NEO'S 4 50 4T-3V 09-15, NEO'S EASY 50 2T 13-13, NEO'S EURO 2 50 2T 02-02, SLIDER 50 2T 00-02, WHY 50 2T 98-05, WHY EURO 2 50 2T 03-05, ZEST 50 2T 95-92, ZUMA 50 2T 97-01



◀ Pignoni catena per motori Minarelli AM6

		Z12	Z14
1/2" x 3/16" x 7,75	per catena 415	9918470	9917930
1/2" x 1/4" x 7,75	per catena 420	9918490	9917980
1/2" x 5/16" x 8,51	per catena 428		



◀ cod. 9919080

RACING

Ingranaggio 6 velocità Ø18 su albero primario Z=26 per motori Minarelli AM6 1° SERIE

APPLICABILITÀ

APRILIA	CLASSIC 50 2T 92-99, MX 50 2T 04-04, MX MOTARD 50 2T 95-03, RS 50 2T 93-05, RX 50 2T 03-04, RX ENDURO 50 2T 95-03, TUONO 50 2T 03-04	MOTORHISPANIA	FURIA 50 2T 97-00, FURIA MAX 50 2T 10-12, RX 50 2T 09-12, RX R 50 2T 09-12
BETA	RR 2T 50 EU4 50 2T 18-20, RR 50 RACING EU4 50 2T 18-20, RR ALU 50 2T 08-12, RR ENDURO 50 2T 06-17, RR MOTARD 50 2T 06-17	PEUGEOT	SUPERMOTARD 50 2T 90-02, XP6 TRAIL S/AVV. ELETTRICO 50 2T 90-02, XR6 RACING CAT. C/AVV.ELETT. 50 2T 90-02
CH HUSQUARNA	SM 50 2T 00-10, WR 50 2T 00-10, WSM 50 2T 00-10	RIEJU	MRT 50 2T 09-12, MRT 50 EU4 50 2T 18-20, MRT PRO 50 2T 09-12, MRT PRO EU4 50 2T 18-20, MRT PRO REPLICA EU4 50 2T 18-20, MRT PRO SM 50 2T 09-12, MRT PRO SM EU4 50 2T 18-20, MRT SM 50 2T 09-12, MRT SM EU4 50 2T 18-20, MRT TROPHY EU4 50 2T 18-20, MRX 50 2T 01-04, MRX PRO 50 2T 01-04, RR 50 2T 05-06, RS1 50 2T 98-01, RS2 MATRIX 50 2T 05-06, RS2 MATRIX PRO 50 2T 05-06, RS2 NAKED 50 2T 04-05, RS3 EU4 50 2T 18-20, RS3 NKD EU4 50 2T 18-20, SMX E.S./K.S. 50 2T 01-01, SMX PRO E.S./K.S. 50 2T 03-03, SPIKE 50 2T 98-01
CMC	ENDURO 50 2T 11-11, MOTARD 50 2T 11-11	SHERCO	FACTORY SE-R EU4 50 2T 18-20, FACTORY SE-RS EU4 50 2T 18-20, FACTORY SILVER SM-R EU4 50 2T 18-20, FACTORY SILVER SM-RS EU4 50 2T 18-20, FACTORY SM-R EU4 50 2T 18-20, FACTORY SM-RS EU4 50 2T 18-20, HRD ENDURO 50 2T 09-13, HRD MOTARD 50 2T 09-13
FANTIC	CABALLERO MOTARD 50 2T 06-10, CABALLERO REGOLARITÀ 50 2T 06-10, ENDURO COMPETITION EU4 50 2T 18-20, ENDURO PERFORMANCE EU4 50 2T 18-20, MOTARD COMPETITION EU4 50 2T 18-20, MOTARD PERFORMANCE EU4 50 2T 18-20	YAMAHA	DT R 50 2T 03-11, DT RSM 50 2T 03-05, DT X 50 2T 06-11, TZR 50 2T 03-08, TZR 50 2T 10-10, TZR RR 50 2T 05-05
HM	BAJA, DERAPAGE BASIC 50 2T 10-11, CMC 50 2T 10-11, CRE BAJA RR, DERAPAGE RR 50 2T 07-11, CRE BAJA, DERAPAGE 50 2T 07-11, CRE SIX COMPETITION 50 2T 10-11, CRE SIX, BAJA, DERAPAGE 50 2T 95-06, CRE SIX, DERAPAGE COMPETITION 50 2T 07-09, DERAPAGE COMPETITION 50 2T 10-11		
MALAGUTI	CNK DRAGON 50 2T 05-07, XSM 50 2T 03-03, XTM 50 2T 03-03		
MBK	X LIMIT 50 2T 03-04, X POWER 50 2T 03-04		
MINARELLI	MOTORE AM 6 1° SERIE 50 2T 96-11		



◀ cod. 9931910

Ingranaggio 6° velocità Ø20 su albero primario Z=26 per motori Minarelli AM6 2° serie

APPLICABILITÀ

APRILIA	CLASSIC 50 2T 92-99, MX 50 2T 04-04, MX MOTARD 50 2T 95-03, RS 50 2T 93-05, RX 50 2T 03-04, RX ENDURO 50 2T 95-03, TUONO 50 2T 03-04	MOTORHISPANIA	FURIA 50 2T 97-00, FURIA MAX 50 2T 10-12, RX 50 2T 09-12, RX R 50 2T 09-12
BETA	RR 2T 50 EU4 50 2T 18-20, RR 50 RACING EU4 50 2T 18-20, RR ALU 50 2T 08-12, RR ENDURO 50 2T 06-17, RR MOTARD 50 2T 06-17	PEUGEOT	SUPERMOTARD 50 2T 90-02, XP6 TRAIL S/AVV. ELETTRICO 50 2T 90-02, XR6 RACING CAT. C/AVV.ELETT. 50 2T 90-02
CH HUSQUARNA	SM 50 2T 00-10, WR 50 2T 00-10, WSM 50 2T 00-10	RIEJU	MRT 50 2T 09-12, MRT 50 EU4 50 2T 18-20, MRT PRO 50 2T 09-12, MRT PRO EU4 50 2T 18-20, MRT PRO REPLICA EU4 50 2T 18-20, MRT PRO SM 50 2T 09-12, MRT PRO SM EU4 50 2T 18-20, MRT SM 50 2T 09-12, MRT SM EU4 50 2T 18-20, MRT TROPHY EU4 50 2T 18-20, MRX 50 2T 01-04, MRX PRO 50 2T 01-04, RR 50 2T 05-06, RS1 50 2T 98-01, RS2 MATRIX 50 2T 05-06, RS2 MATRIX PRO 50 2T 05-06, RS2 NAKED 50 2T 04-05, RS3 EU4 50 2T 18-20, RS3 NKD EU4 50 2T 18-20, SMX E.S./K.S. 50 2T 01-01, SMX PRO E.S./K.S. 50 2T 03-03, SPIKE 50 2T 98-01
CMC	ENDURO 50 2T 11-11, MOTARD 50 2T 11-11	SHERCO	FACTORY SE-R EU4 50 2T 18-20, FACTORY SE-RS EU4 50 2T 18-20, FACTORY SILVER SM-R EU4 50 2T 18-20, FACTORY SILVER SM-RS EU4 50 2T 18-20, FACTORY SM-R EU4 50 2T 18-20, FACTORY SM-RS EU4 50 2T 18-20, HRD ENDURO 50 2T 09-13, HRD MOTARD 50 2T 09-13
FANTIC	CABALLERO MOTARD 50 2T 06-10, CABALLERO REGOLARITÀ 50 2T 06-10, ENDURO COMPETITION EU4 50 2T 18-20, ENDURO PERFORMANCE EU4 50 2T 18-20, MOTARD COMPETITION EU4 50 2T 18-20, MOTARD PERFORMANCE EU4 50 2T 18-20	VENT	BAJA 50 2T 18-20, BAJA RR 50 2T 18-20, DERAPAGE 50 2T 18-20, DERAPAGE RR 50 2T 18-20
HM	BAJA, DERAPAGE BASIC 50 2T 10-11, CMC 50 2T 10-11, CRE BAJA RR, DERAPAGE RR 50 2T 07-11, CRE BAJA, DERAPAGE 50 2T 07-11, CRE SIX COMPETITION 50 2T 10-11, CRE SIX, BAJA, DERAPAGE 50 2T 95-06, CRE SIX, DERAPAGE COMPETITION 50 2T 07-09, DERAPAGE COMPETITION 50 2T 10-11	YAMAHA	DT R 50 2T 03-11, DT RSM 50 2T 03-05, DT X 50 2T 06-11, TZR 50 2T 03-08, TZR 50 2T 10-10, TZR RR 50 2T 05-05
MALAGUTI	CNK DRAGON 50 2T 05-07, XSM 50 2T 03-03, XTM 50 2T 03-03		
MBK	X LIMIT 50 2T 03-04, X POWER 50 2T 03-04		
MINARELLI	MOTORE AM 6 2° SERIE 50 2T 12-18		



◀ **cod. 9913300**
Rapporti primari allungati
Z= 15/50 Rapporto 1:3,33

APPLICABILITÀ

APRILIA AMICO 50 2T 94-94, AMICO 50 2T 96-98, AMICO GL/GLE 50 2T 93-95, AMICO LX/SPORT/CAT 50 2T 92-93, AREA 51 50 2T 98-00, GULLIVER 50 2T 95-98, GULLIVER LC 50 2T 96-98, RALLY 50 2T 95-03, RALLY LIQUID COOLED 50 2T 96-99, SCARABEO 50 2T 93-05, SR (ORIZZONTALE) 50 2T 94-96, SR (VERTICALE) 50 2T 93-93, SR LIQUID COOLED 50 2T 94-96, SR RACING 50 2T 97-99, SR STEALTH 50 2T 97-00, SR WWW 50 2T 97-01

ATALA CAROSELLO 50 2T 99-01

BENELLI 491 GT 50 2T 98-99, 491 NAKED 50 2T 02-02, 491 RACING 50 2T 98-99, 491 RR 50 2T 99-01, 491 SP 50 2T 99-99, 491 SPORT 50 2T 98-99, 491 ST 50 2T 99-01, K2 50 2T 98-01, K2 LIQUID COOLED 50 2T 98-01, PEPE 50 2T 99-01, PEPE LX 50 2T 03-04

BETA ARK 50 2T 96-08, ARK LC 50 2T 96-08, CHRONO 50 2T 95-96, EIKON 50 2T 99-03, QUADRA 50 2T 95-95, QUADRA 50 2T 99-01, TEMPO 50 2T 93-02, TEMPO 50 2T 95-95

ITALJET DRAGSTER 50 2T 98-02

KTM K50 50 2T 96-01

MACAL THUNDER 50 2T 95-96

MALAGUTI CENTRO SL 50 2T 94-98, CIAK 50 2T 99-01, CIAK EURO 2 2,3 50 2T 03-03, CIAK EURO2 50 2T 01-03, CIAK MASTER EURO 2 50 2T 06-06, F12 PHANTOM 50 2T 94-98, F12 PHANTOM EURO 2 2,3 50 2T 03-04, F12 PHANTOM LC 50 2T 94-98, F12 R PHANTOM LC 50 2T 07-10, F12 RESTYLING EURO 2 50 2T 06-06, F15 FIRE FOX 50 2T 96-98, F15 FIRE FOX AIR COOLED 50 2T 05-06, F15 FIRE FOX EURO 2 50 2T 02-06, F15 FIRE FOX EURO 2 2,3 50 2T 03-04

MBK BOOSTER 50 2T 90-04, BOOSTER 50 2T 90-94, BOOSTER EURO 2 50 2T 04-04, BOOSTER NG 50 2T 95-03, BOOSTER ROCKET 50 2T 97-98, BOOSTER SPIRIT 50 2T 96-00, BOOSTER SPIRIT 50 2T 03-03, BOOSTER SPIRIT EURO2 50 2T 03-03, BOOSTER TRACK 50 2T 96-98, FLIPPER 50 2T 98-04, FLIPPER EURO 2 50 2T 03-03, MACH G 50 2T 02-04, MACH G LC 50 2T 02-04, NITRO 50 2T 97-04, NITRO EURO 2 50 2T 03-03, OVETTO 50 2T 97-04, OVETTO EURO 2 50 2T 02-02, STUNT 50 2T 00-02

MOTRON SYNCRO 50 2T 98-00, THUNDER 50 2T 95-98

RIEJU FIRST 50 2T 95-98, WINDY 50 2T 95-98

YAMAHA AEROX 50 2T 97-02, AEROX 50 2T 04-16, AEROX EURO 2 50 2T 03-03, AEROX NAKED 50 2T 13-16, AEROX R 50 2T 99-00, BW'S 50 2T 97-16, BW'S BUMP 50 2T 97-98, BW'S EASY 50 2T 13-13, BW'S NAKED 50 2T 03-04, BW'S NAKED 50 2T 09-16, BW'S NEXT GENERATION 50 2T 97-06, BW'S ORIGINAL 50 2T 99-01, BW'S ORIGINAL EURO 2 50 2T 03-03, JOG R 50 2T 02-02, JOG R EURO2 50 2T 02-02, JOG R EURO2 50 2T 06-15, JOG R LC 50 2T 02-15, NEO'S 50 2T 97-02, NEO'S 50 2T 04-16, NEO'S EASY 50 2T 13-13, NEO'S EURO 2 50 2T 02-02, RS SPY 50 2T 95-98, SLIDER 50 2T 00-02, WHY 50 2T 98-05, WHY EURO 2 50 2T 03-05, ZUMA 50 2T 97-01



◀ **cod. 9909520**
Rapporti secondari allungati
Z= 15/41 Rapporto 1:2,73

APPLICABILITÀ

APRILIA AREA 51 50 2T 98-00, GULLIVER LC 50 2T 96-98, RALLY LIQUID COOLED 50 2T 96-99, SR (ORIZZONTALE) 50 2T 94-96, SR LIQUID COOLED 50 2T 94-96, SR RACING 50 2T 97-99, SR STEALTH 50 2T 97-00

BENELLI 491 GT 50 2T 98-99, 491 RACING 50 2T 98-99, 491 RR 50 2T 99-01, 491 SP 50 2T 99-99, 491 SPORT 50 2T 98-99, 491 ST 50 2T 99-01, PEPE 50 2T 99-01, PEPE LX 50 2T 03-04

BETA ARK LC 50 2T 96-08, EIKON 50 2T 99-03

ITALJET DRAGSTER 50 2T 98-02

MALAGUTI F12 PHANTOM 50 2T 94-98, F12 PHANTOM EURO 2 2,3 50 2T 03-04, F12 PHANTOM LC 50 2T 94-98, F12 R PHANTOM LC 50 2T 07-10, F12 RESTYLING EURO 2 50 2T 06-06, F15 FIRE FOX 50 2T 96-98, F15 FIRE FOX AIR COOLED 50 2T 05-06, F15 FIRE FOX EURO 2 50 2T 02-06, F15 FIRE FOX EURO 2 2,3 50 2T 03-04

MBK BOOSTER NG 50 2T 95-03, MACH G LC 50 2T 02-04, NITRO 50 2T 97-04, NITRO EURO 2 50 2T 03-03, STUNT 50 2T 00-02

YAMAHA AEROX 50 2T 97-02, AEROX 50 2T 04-16, AEROX EURO 2 50 2T 03-03, AEROX NAKED 50 2T 13-16, AEROX R 50 2T 99-00, BW'S NEXT GENERATION 50 2T 97-03, JOG R LC 50 2T 02-15, RS SPY 50 2T 95-98, SLIDER 50 2T 00-02, WHY 50 2T 98-05, WHY EURO 2 50 2T 03-05

APPLICABILITÀ

APRILIA AREA 51 50 2T 98-00, GULLIVER 50 2T 95-98, GULLIVER LC 50 2T 96-98, RALLY 50 2T 95-03, RALLY LIQUID COOLED 50 2T 96-99, SR (ORIZZONTALE) 50 2T 94-96, SR (VERTICALE) 50 2T 93-93, SR LIQUID COOLED 50 2T 94-96, SR RACING 50 2T 97-99, SR STEALTH 50 2T 97-00, SR WWW 50 2T 97-01

ATALA CAROSELLO 50 2T 99-01

BENELLI 491 GT 50 2T 98-99, 491 NAKED 50 2T 02-02, 491 RACING 50 2T 98-99, 491 RR 50 2T 99-01, 491 SP 50 2T 99-99, 491 SPORT 50 2T 98-99, 491 ST 50 2T 99-01, K2 50 2T 98-01, K2 LIQUID COOLED 50 2T 98-01, PEPE 50 2T 99-01, PEPE LX 50 2T 03-04

BETA ARK 50 2T 96-08, ARK LC 50 2T 96-08, CHRONO 50 2T 95-96, EIKON 50 2T 99-03, QUADRA 50 2T 95-95, QUADRA 50 2T 99-01, TEMPO 50 2T 93-02, TEMPO 50 2T 95-95

ITALJET DRAGSTER 50 2T 98-02

KTM K50 50 2T 96-01

MACAL THUNDER 50 2T 95-96

MALAGUTI CENTRO SL 50 2T 94-98, F12 PHANTOM 50 2T 94-98, F12 PHANTOM EURO 2 50 2T 02-02, F12 PHANTOM EURO 2 2,3 50 2T 03-04, F12 PHANTOM LC 50 2T 94-98, F12 R PHANTOM LC 50 2T 07-10, F12 RESTYLING EURO 1 50 2T 99-02, F12 RESTYLING EURO 2 50 2T 06-06, F12 RESTYLING LC EURO 2 50 2T 06-06, F15 FIRE FOX 50 2T 96-98, F15 FIRE FOX AIR COOLED 50 2T 05-06, F15 FIRE FOX EURO 2 50 2T 02-06, F15 FIRE FOX EURO 2 2,3 50 2T 03-04

MBK BOOSTER 50 2T 90-04, BOOSTER 50 2T 90-94, BOOSTER EURO 2 50 2T 04-04, BOOSTER NG 50 2T 95-03, BOOSTER ROCKET 50 2T 97-98, BOOSTER SPIRIT 50 2T 96-00, BOOSTER SPIRIT 50 2T 03-03, BOOSTER SPIRIT EURO2 50 2T 03-03, BOOSTER TRACK 50 2T 96-98, MACH G 50 2T 02-04, MACH G LC 50 2T 02-04, NITRO 50 2T 97-04, NITRO EURO 2 50 2T 03-03, OVETTO 50 2T 97-04, OVETTO EURO 2 50 2T 02-02, STUNT 50 2T 00-02

MOTRON SYNCRO 50 2T 98-00, THUNDER 50 2T 95-98

RIEJU FIRST 50 2T 95-98, WINDY 50 2T 95-98

YAMAHA AEROX 50 2T 97-02, AEROX 50 2T 04-16, AEROX EURO 2 50 2T 03-03, AEROX NAKED 50 2T 13-16, AEROX R 50 2T 99-00, BW'S 50 2T 97-16, BW'S BUMP 50 2T 97-98, BW'S EASY 50 2T 13-13, BW'S NAKED 50 2T 03-04, BW'S NAKED 50 2T 09-16, BW'S NEXT GENERATION 50 2T 97-06, BW'S ORIGINAL 50 2T 99-01, BW'S ORIGINAL EURO 2 50 2T 03-03, JOG R 50 2T 02-02, JOG R EURO2 50 2T 02-02, JOG R EURO2 50 2T 06-15, JOG R LC 50 2T 02-15, NEO'S 50 2T 97-02, NEO'S 50 2T 04-16, NEO'S EASY 50 2T 13-13, NEO'S EURO 2 50 2T 02-02, RS SPY 50 2T 95-98, SLIDER 50 2T 00-02, ZUMA 50 2T 97-01

REGOLATORE DI PRESSIONE



◀ **cod. 9928130**
Regolatore di pressione 3.5 bar

APPLICABILITÀ

MBK BOOSTER X IE 50 4T-3V 08-08

YAMAHA GIGGLE 50 4T-3V 08-08, YZF-R IE 125 4T 4V IE 08-13, T-MAX 4B5 500 4T 09-11, T-MAX 4B5 ABS 500 4T 08-11, T-MAX 5VU 500 4T 06-06, T-MAX 5VU 500 4T 08-08, T-MAX 59C 530 4T 12-16, T-MAX 59C ABS 530 4T 12-16, T-MAX 59C SP 530 4T 15-15, T-MAX 59C SP ABS 530 4T 15-16

SCARICHI COMPLETI



cod. **9927350** **RACING**
Scarico completo Yamaha YZF 125 R

APPLICABILITÀ
YAMAHA YZF-R IE 125 4T 4V IE 08-13



cod. **9924340** **RACING**
Scarico ad espans. per HM CRE SIX 50 '06

APPLICABILITÀ
HM BAJA, DERAPAGE BASIC 50 2T 10-11, CMC 50 2T 10-11, CRE BAJA RR, DERAPAGE RR 50 2T 07-11, CRE BAJA, DERAPAGE 50 2T 07-11, CRE SIX COMPETITION 50 2T 10-11, CRE SIX, BAJA, DERAPAGE 50 2T 95-06, CRE SIX, DERAPAGE COMPETITION 50 2T 07-09, DERAPAGE COMPETITION 50 2T 10-11
VENT BAJA 50 2T 18-20, BAJA RR 50 2T 18-20, DERAPAGE 50 2T 18-20, DERAPAGE RR 50 2T 18-20

RICAMBI

9924350	Silenziatore
---------	--------------

SCARICHI GP



cod. **9930140** **RACING**
Scarico "TPR" GP Minarelli/Yamaha
Da abbinare ai Maxi Kit Scooter 50 cc. Minarelli/Yamaha LC | cod.9926560 e 9926580

APPLICABILITÀ
APRILIA AREA 51 50 2T 98-00, GULLIVER LC 50 2T 96-98, RALLY LIQUID COOLED 50 2T 96-99, SONIC GP 50 2T 98-08, SR LIQUID COOLED 50 2T 94-96, SR RACING 50 2T 97-99, SR STEALTH 50 2T 97-00
BENELLI 491 RACING 50 2T 98-99, 491 RR 50 2T 99-01, 491 SP 50 2T 99-99, 491 SPORT 50 2T 98-99, K2 LIQUID COOLED 50 2T 98-01
BETA ARK LC 50 2T 96-08, EIKON 50 2T 99-03
ITALJET DRAGSTER 50 2T 98-02
MALAGUTI F12 PHANTOM LC 50 2T 94-98, F12 R PHANTOM LC 50 2T 07-10, F15 FIRE FOX 50 2T 96-98, F15 FIRE FOX EURO 2 50 2T 02-06, F15 FIRE FOX EURO 2,3 50 2T 03-04
MBK MACH G LC 50 2T 02-04, NITRO 50 2T 97-04, NITRO EURO 2 50 2T 03-03
YAMAHA AEROX 50 2T 97-02, AEROX 50 2T 04-16, AEROX EURO 2 50 2T 03-03, AEROX NAKED 50 2T 13-16, AEROX R 50 2T 99-00, JOG R LC 50 2T 02-15

RICAMBI

9930550	Kit staffa fissaggio
9930590	Kit collettore

9930670	Silenziatore
9930680	Serie guarnizioni



cod. **9930160** **RACING**
Scarico "TPR" GP Piaggio
Da abbinare ai Maxi Kit Scooter 50 cc. Piaggio | cod. 9928390 e 9928340

APPLICABILITÀ
APRILIA SR MOTARD 50 2T 12-14, SR R 50 2T 04-09, SR R FACTORY CARBURATORE 50 2T 10-14, SR R FACTORY IE 50 2T 10-14
DERBI GP1 50 2T 01-03, GP1 EU 2 50 2T 05-05, GP1 OPEN EU2 50 2T 06-09, GP1 RACE EU2 50 2T 05-07
GILERA DNA 50 2T 00-02, DNA 50 2T 05-07, DNA GP EXPERIENCE 50 2T 03-04, RUNNER 50 2T 97-00, RUNNER POGGIALI 50 2T 02-02, RUNNER SP 50 2T 02-07, RUNNER SP 50 2T 10-12, RUNNER SP SPECIAL EDITION 50 2T 07-07, RUNNER SP ST & SIMONCELLI 50 2T 08-09
PIAGGIO NRG 50 2T 94-96, NRG EXTREME LC 50 2T 99-00, NRG MC3 50 2T 01-04, NRG POWER DD 50 2T 05-17, NRG POWER DD SERIE SPECIALE 50 2T 07-12, NRG RST MC2 50 2T 96-98, NTT 50 2T 95-96, QUARTZ 50 2T 92-96, ZIP 2T 50 2T 08-13, ZIP LC 50 2T 00-04, ZIP SP 50 2T 96-04, ZIP SP EURO 2 50 2T 06-13

RICAMBI

9930670	Silenziatore
9930680	Serie guarnizioni

9930730	Kit staffa fissaggio
9930750	Kit collettore



cod. **9931440** **RACING**
 Scarico Nardò 2 omologato per motore orizzontale

APPLICABILITÀ

Attenzione: lo scarico è omologato esclusivamente per i modelli evidenziati in grassetto

APRILIA AREA 51 50 2T 98-00, GULLIVER 50 2T 95-98, GULLIVER LC 50 2T 96-98, RALLY 50 2T 95-03, RALLY LIQUID COOLED 50 2T 96-99, SCARABEO 50 2T 93-98, SONIC 50 2T 98-07, SONIC GP 50 2T 98-08, SR (ORIZZONTALE) 50 2T 94-96, SR LIQUID COOLED 50 2T 94-96, SR RACING 50 2T 97-99, SR STEALTH 50 2T 97-00, SR WWW 50 2T 97-01

BENELLI 491 GT 50 2T 98-99, 491 RACING 50 2T 98-99, K2 50 2T 98-01, K2 LIQUID COOLED 50 2T 98-01, PEPE 50 2T 99-01

BETA ARK 50 2T 96-08, ARK LC 50 2T 96-08, CHRONO 50 2T 95-96, EIKON 50 2T 99-03, QUADRA 50 2T 95-95, QUADRA 50 2T 99-01, TEMPO 50 2T 93-02, TEMPO 50 2T 95-95

ITALJET DRAGSTER 50 2T 98-02

MALAGUTI CENTRO SL 50 2T 94-98, CIAK 50 2T 99-01, CIAK EURO 2,2,3 50 2T 03-03, CIAK EURO2 50 2T 01-03, CIAK MASTER EURO 2 50 2T 06-06, F10 50 2T 92-00, F10 EURO 2 50 2T 02-06, F10 EURO 2,2,3 50 2T 03-04, F10 RESTYLING EURO 2 50 2T 06-06, F12 PHANTOM 50 2T 94-98, F12 PHANTOM EURO 2,2,3 50 2T 03-04, F12 PHANTOM LC 50 2T 94-98, F12 R PHANTOM LC 50 2T 07-10, F12 RESTYLING EURO 2 50 2T 06-06, F15 FIRE FOX 50 2T 96-98, F15 FIRE FOX AIR COOLED 50 2T 05-06, F15 FIRE FOX EURO 2 50 2T 02-06, F15 FIRE FOX EURO 2,2,3 50 2T 03-04, YESTERDAY 50 2T 97-00

MBK EVOLIS 50 2T 92-95, FIZZ 50 2T 94-95, FLIPPER 50 2T 98-04, FLIPPER EURO 2 50 2T 03-03, FORTE 50 2T 94-96, MACH G 50 2T 02-04, MACH G LC 50 2T 02-04, NITRO 50 2T 97-04, NITRO EURO 2 50 2T 03-03, OVETTO 50 2T 97-04, OVETTO EURO 2 50 2T 02-02

YAMAHA AEROX 50 2T 97-02, AEROX 50 2T 04-16, AEROX EURO 2 50 2T 03-03, AEROX NAKED 50 2T 13-16, AEROX R 50 2T 99-00, AXIS 50 2T 95-96, BREEZE 50 2T 94-95, JOG 50 2T 92-01, JOG ER 50 2T 00-02, JOG R 50 2T 02-02, JOG R EURO2 50 2T 02-02, JOG R EURO2 50 2T 06-15, JOG R LC 50 2T 02-15, JOG Z 50 2T 95-95, NEO'S 50 2T 97-02, NEO'S 50 2T 04-16, NEO'S EASY 50 2T 13-13, NEO'S EURO 2 50 2T 02-02, WHY 50 2T 98-05, WHY EURO 2 50 2T 03-05, ZEST 50 2T 95-92

RICAMBI

9931530 Silenziatore

9931470 Kit staffa

cod. **9931450** **RACING**
 Scarico Nardò 2 omologato per motore verticale

Attenzione: lo scarico è omologato esclusivamente per i modelli evidenziati in grassetto

APPLICABILITÀ

APRILIA AMICO 50 2T 94-94, AMICO 50 2T 96-98, AMICO GL/GLE 50 2T 93-95, AMICO LX/SPORT/CAT 50 2T 92-93, SR (VERTICALE) 50 2T 93-93

ITALJET BAZOOKA 50 2T 91-94, PISTA 50 2T 92-97, PISTA 2 50 2T 97-98, SCOOP 50 2T 91-95, SCOOP 2 50 2T 96-98, YANKEE 50 2T 93-97

YAMAHA BW'S 50 2T 97-04, BW'S BUMP 50 2T 97-98, BW'S NAKED 50 2T 03-03, BW'S NEXT GENERATION 50 2T 97-02, BW'S ORIGINAL 50 2T 99-01, RS SPY 50 2T 95-98, SLIDER 50 2T 00-02, ZUMA 50 2T 97-01

MBK BOOSTER 50 2T 90-04, BOOSTER 50 2T 90-94, BOOSTER NG 50 2T 95-03, BOOSTER ROCKET 50 2T 97-98, BOOSTER SPIRIT 50 2T 96-00, BOOSTER TRACK 50 2T 96-98, STUNT 50 2T 00-02

RICAMBI

9931530 Silenziatore

9931490 Kit staffa

cod. **9931460** **RACING**
 Scarico Nardò 2 omologato per motore Piaggio 50 cc

Attenzione: lo scarico è omologato esclusivamente per i modelli evidenziati in grassetto

APPLICABILITÀ

APRILIA SCARABEO 2T EU2 MOTORE PIAGGIO 50 2T 10-12, SCARABEO 2T NET 50 2T 09-10, SCARABEO STREET 50 2T 05-06, SCARABEO STREET 2T RESTYLING 50 2T 06-09, SR MOTARD 50 2T 12-14, SR R 50 2T 04-09, SR R FACTORY CARBURATORE 50 2T 10-14, SR R FACTORY IE 50 2T 10-14

DERBI ATLANTIS 2T 50 2T 10-10, ATLANTIS 2T EU2 50 2T 07-09, ATLANTIS 02 50 2T 02-02, ATLANTIS 02 BULLET 50 2T 03-05, ATLANTIS 02 CITY 50 2T 04-06, ATLANTIS 02 RED BULLET 50 2T 03-03, ATLANTIS 02 TWO CHIC 50 2T 05-05, BOULEVARD 2T 50 2T 09-14, GP1 50 2T 01-03, GP1 EU 2 50 2T 05-05, GP1 OPEN EU2 50 2T 06-09, GP1 RACE EU2 50 2T 05-07, SONAR 2T 50 2T 09-09

GILERA DNA 50 2T 00-02, DNA 50 2T 05-07, DNA GP EXPERIENCE 50 2T 03-04, EASY MOVING 50 2T 95-96, ICE 50 2T 01-05, RUNNER 50 2T 97-00, RUNNER POGGIALI 50 2T 02-02, RUNNER PURE JET 50 2T-IE 02-07, RUNNER PURE JET 50 2T-IE 10-11, RUNNER PURE JET ST 50 2T-IE 08-08, RUNNER SP 50 2T 02-07, RUNNER SP 50 2T 10-12, RUNNER SP SPECIAL EDITION 50 2T 07-07, RUNNER SP ST & SIMONCELLI 50 2T 08-09, STALKER 50 2T 97-11, STALKER NAKED 50 2T 08-08, STALKER SPECIAL EDITION 50 2T 07-08, STORM 50 2T 94-95, STORM EURO 2 50 2T 07-07, TYPHOON 50 2T 94-97, TYPHOON X 50 2T 98-99, TYPHOON XR 50 2T 00-00

PIAGGIO DIE SIS 50 2T 01-01, FLY 2T 50 2T 05-07, FLY 2T 50 2T 10-11, FREE 50 2T 92-94, FREE DELIVERY 50 2T 00-01, FREE FL 50 2T 95-02, LIBERTY 50 2T 97-05, LIBERTY 2T 50 2T 06-08, LIBERTY 2T PTT EU2 50 2T 04-05, LIBERTY 2T RST 50 2T 04-04, LIBERTY 2T SPORT 50 2T 06-08, LIBERTY MOC 2T & ELLE 50 2T 09-13, NRG 50 2T 94-96, NRG EXTREME LC 50 2T 99-00, NRG MC3 50 2T 01-04, NRG POWER DD 50 2T 05-17, NRG POWER DD SERIE SPECIALE 50 2T 07-12, NRG POWER DT 50 2T 06-15, NRG POWER DT SERIE SPECIALE 50 2T 07-08, NRG POWER PUREJET 50 2T-IE 04-11, NRG PUREJET 50 2T-IE 02-04, NRG PUREJET 50 2T-IE 10-10, NRG RST MC2 50 2T 96-98, NTT 50 2T 95-96, QUARTZ 50 2T 92-96, SFERA 50 2T 91-93, SFERA MAQUILLAGE 2 50 2T 94-94, SFERA RST 50 2T 95-97, TYPHOON 50 2T 01-11, TYPHOON 2T E2 50 2T 10-12, TYPHOON 2T E3 CH 50 2T 11-11, VESPA ET2 50 2T 97-05, VESPA ET2 INIEZIONE 50 2T 97-00, VESPA LX 2T 50 2T 05-13, VESPA LX 2T TOURING & 30KM 50 2T 10-13, VESPA LXV 2T 50 2T 06-09, VESPA LXV 2T NAVY 50 2T 08-08, VESPA S 2T & COLLEGE 50 2T 07-12, ZIP 50 2T 92-93, ZIP 50 2T 95-96, ZIP 2T 50 2T 08-13, ZIP BIMODALE 50 2T 94-97, ZIP FAST RIDER 50 2T 93-94, ZIP FAST RIDER RST 50 2T 96-97, ZIP LC 50 2T 00-04, ZIP RST 50 2T 96-99, ZIP SP 50 2T 96-04, ZIP SP EURO 2 50 2T 06-13

ITALJET JET SET 50 2T 02-02, TORPEDO NEW 50 2T 00-01

RICAMBI

9931530 Silenziatore

9931510 Kit staffa



cod. **9934190**
 Collettore per scarico Nardò 2 per motori Minarelli/Yamaha orizzontale interasse 51 mm

cod. **9934210**
 Collettore per scarico Nardò 2 per motore Piaggio interasse 51 mm

ATTENZIONE: QUESTI PRODOTTI SONO DESTINATI ESCLUSIVAMENTE AD USO AGONISTICO. NE È QUINDI VIETATO L'UTILIZZO SU STRADA PUBBLICA.



cod. 9906500

Valvola lamellare con petali in fibra di carbonio (spessore 0,30 mm) per motori Minarelli AM

APPLICABILITÀ

APRILIA	CLASSIC 50 2T 92-99, EUROPA 50 2T 90-92, MX 50 2T 04-04, MX MOTARD 50 2T 95-03, PEGASO 50 2T 92-94, RS 50 2T 91-05, RX 50 2T 89-04, RX 3-5 MARCE 50 2T 91-94, RX ENDURO 50 2T 95-03, RX RACING 50 2T 03-06, TUONO 50 2T 03-04
BETA	RR 2T 50 EU4 50 2T 18-20, RR 50 RACING EU4 50 2T 18-20, RR ALU 50 2T 08-12, RR ENDURO 50 2T 06-17, RR MOTARD 50 2T 06-17
CH HUSQVARNA	SM 50 2T 00-10, WR 50 2T 00-10, WSM 50 2T 00-10
CMC	ENDURO 50 2T 11-11, MOTARD 50 2T 11-11
FANTIC	CABALLERO MOTARD 50 2T 06-10, CABALLERO REGOLARITÀ 50 2T 06-10, ENDURO COMPETITION EU4 50 2T 18-20, ENDURO PERFORMANCE EU4 50 2T 18-20, MOTARD COMPETITION EU4 50 2T 18-20, MOTARD PERFORMANCE EU4 50 2T 18-20
HM	BAJA, DERAPAGE BASIC 50 2T 10-11, CMC 50 2T 10-11, CRE BAJA RR, DERAPAGE RR 50 2T 07-11, CRE BAJA, DERAPAGE 50 2T 07-11, CRE SIX COMPETITION 50 2T 10-11, CRE SIX, BAIA, DERAPAGE 50 2T 95-06, CRE SIX, DERAPAGE COMPETITION 50 2T 07-09, DERAPAGE COMPETITION 50 2T 10-11
MALAGUTI	CNK DRAGON 50 2T 05-07, FIFTY EVOLUTION 50 2T 90-93, XSM 50 2T 03-03, XTM 50 2T 03-03
MBK	X LIMIT 50 2T 03-04, X POWER 50 2T 03-04
MINARELLI	MOTORE AM 3-4-5 50 2T 91-95, MOTORE AM 6 1° SERIE 50 2T 96-11, MOTORE AM 6 2° SERIE 50 2T 12-18

MOTORHISPANIA
PEUGEOT

RIEJU

SHERCO

VENT

YAMAHA

FURIA 50 2T 97-00, FURIA MAX 50 2T 10-12, RX 50 2T 09-12, RX R 50 2T 09-12
SUPERMOTARD 50 2T 90-02, XP6 TRAIL S/AVV. ELETTRICO 50 2T 90-02, XR6 RACING CAT. C/AVV.ELETT. 50 2T 90-02
MRT 50 2T 09-12, MRT 50 EU4 50 2T 18-20, MRT PRO 50 2T 09-12, MRT PRO EU4 50 2T 18-20, MRT PRO REPLICA EU4 50 2T 18-20, MRT PRO REPLICA SM EU4 50 2T 18-20, MRT PRO SM 50 2T 09-12, MRT PRO SM EU4 50 2T 18-20, MRT SM 50 2T 09-12, MRT SM EU4 50 2T 18-20, MRT TROPHY EU4 50 2T 18-20, MRX 50 2T 01-04, MRX PRO 50 2T 01-04, RR 50 2T 05-06, RS1 50 2T 98-01, RS2 MATRIX 50 2T 05-06, RS2 MATRIX PRO 50 2T 05-06, RS2 NAKED 50 2T 04-05, RS3 EU4 50 2T 18-20, RS3 NKD EU4 50 2T 18-20, SMX E.S./K.S. 50 2T 01-01, SMX PRO E.S./K.S. 50 2T 03-03, SPIKE 50 2T 98-01
FACTORY SE-R EU4 50 2T 18-20, FACTORY SE-RS EU4 50 2T 18-20, FACTORY SILVER SM-R EU4 50 2T 18-20, FACTORY SILVER SM-RS EU4 50 2T 18-20, FACTORY SM-R EU4 50 2T 18-20, FACTORY SM-RS EU4 50 2T 18-20, HRD ENDURO 50 2T 09-13, HRD MOTARD 50 2T 09-13
BAJA 50 2T 18-20, BAJA RR 50 2T 18-20, DERAPAGE 50 2T 18-20, DERAPAGE RR 50 2T 18-20
DT R 50 2T 03-11, DT RSM 50 2T 03-05, DT X 50 2T 06-11, TZR 50 2T 03-08, TZR 50 2T 10-11, TZR RR 50 2T 05-05

RICAMBI

9906510	Coppia petali in carbonio 0,30 mm
---------	-----------------------------------

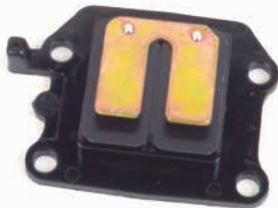

cod. 9906520

Valvola lamellare con petali in fibra di carbonio (spessore 0,30 mm) per motori scooter 50 cc Minarelli/Yamaha tipo verticale

APPLICABILITÀ

APRILIA	AMICO 50 2T 94-94, AMICO 50 2T 96-98, AMICO GL/GLE 50 2T 93-95, AMICO LX/SPORT/CAT 50 2T 92-93, SR (VERTICALE) 50 2T 93-93
MBK	BOOSTER 50 2T 90-04, BOOSTER 50 2T 90-94, BOOSTER EURO 2 50 2T 04-04, BOOSTER NG 50 2T 95-03, BOOSTER ROCKET 50 2T 97-98, BOOSTER SPIRIT 50 2T 96-00, BOOSTER SPIRIT 50 2T 03-03, BOOSTER SPIRIT EURO2 50 2T 03-03, BOOSTER TRACK 50 2T 96-98, STUNT 50 2T 00-02

YAMAHA

BW'S 50 2T 97-16, BW'S BUMP 50 2T 97-98, BW'S EASY 50 2T 13-13, BW'S NAKED 50 2T 03-04, BW'S NAKED 50 2T 09-16, BW'S NEXT GENERATION 50 2T 97-06, BW'S ORIGINAL 50 2T 99-01, BW'S ORIGINAL EURO 2 50 2T 03-03, RS SPY 50 2T 95-98, SLIDER 50 2T 00-02, ZUMA 50 2T 97-01

RICAMBI

9910480	Petalo in carbonio 0,30 mm
---------	----------------------------

9908870	Petalo in carbonio 0,40 mm
---------	----------------------------



cod. 9908370

Valvola lamellare con petali in fibra di carbonio (spessore 0,30 mm) per motori scooter 50 cc Minarelli/Yamaha tipo orizzontale

APPLICABILITÀ

APRILIA	AREA 51 50 2T 98-00, GULLIVER 50 2T 95-98, GULLIVER LC 50 2T 96-98, RALLY 50 2T 95-03, RALLY LIQUID COOLED 50 2T 96-99, SCARABEO 50 2T 93-05, SONIC 50 2T 98-07, SONIC GP 50 2T 98-08, SR (ORIZZONTALE) 50 2T 94-96, SR LIQUID COOLED 50 2T 94-96, SR RACING 50 2T 97-99, SR STEALTH 50 2T 97-00, SR WWW 50 2T 97-01
ATALA	CAROSSELLO 50 2T 99-01
BENELLI	491 GT 50 2T 98-99, 491 NAKED 50 2T 02-02, 491 RACING 50 2T 98-99, 491 RR 50 2T 99-01, 491 SP 50 2T 99-99, 491 SPORT 50 2T 98-99, 491 ST 50 2T 99-01, K2 50 2T 98-01, K2 LIQUID COOLED 50 2T 98-01, PEPE 50 2T 99-01, PEPE LX 50 2T 03-04
BETA	ARK 50 2T 96-08, ARK LC 50 2T 96-08, CHRONO 50 2T 95-96, EIKON 50 2T 99-03, QUADRA 50 2T 95-95, QUADRA 50 2T 99-01, TEMPO 50 2T 93-02, TEMPO 50 2T 95-95
DINLI	HELIX DL603 50 2T 07-13, HELIX DL603 90 50 2T 07-13, T-REX 50 2T 07-13
E-TON	VIPER RXL 50 2T 06-06
ITALJET	DRAGSTER 50 2T 98-02
KEEWAY	ATV EC2 50 2T 06-06, ATV OFF ROAD 50 2T 07-07
KTM	K50 50 2T 96-01
LAVERDA	QUASAR 50 2T 02-04
MACAL	THUNDER 50 2T 95-96

MALAGUTI

CENTRO SL 50 2T 94-98, CIAK 50 2T 99-01, CIAK EURO 2 2.3 50 2T 03-03, CIAK EURO2 50 2T 01-03, CIAK MASTER EURO 2 50 2T 06-06, F10 50 2T 92-00, F10 EURO 2 50 2T 02-06, F10 EURO 2.2.3 50 2T 03-04, F10 RESTYLING EURO 2 50 2T 06-06, F12 PHANTOM 50 2T 94-98, F12 PHANTOM EURO 2 50 2T 02-02, F12 PHANTOM EURO 2 2.3 50 2T 03-04, F12 PHANTOM LC 50 2T 94-98, F12 PHANTOM LC EURO 2.2.3 50 2T 03-04, F12 R PHANTOM LC 50 2T 07-10, F12 RESTYLING EURO 1 50 2T 99-02, F12 RESTYLING EURO 2 50 2T 06-06, F12 RESTYLING LC EURO 2 50 2T 06-06, F15 FIRE FOX 50 2T 96-98, F15 FIRE FOX AIR COOLED 50 2T 05-06, F15 FIRE FOX EURO 2 50 2T 02-06, F15 FIRE FOX EURO 2.2.3 50 2T 03-04, YESTERDAY 50 2T 97-00
--

MBK

EVOLIS 50 2T 92-95, FIZZ 50 2T 94-95, FLIPPER 50 2T 98-04, FLIPPER EURO 2 50 2T 03-03, FORTE 50 2T 94-96, MACH G 50 2T 02-04, MACH G LC 50 2T 02-04, NITRO 50 2T 97-04, NITRO EURO 2 50 2T 03-03, OVETTO 50 2T 97-04, OVETTO EURO 2 50 2T 02-02

MOTRON

SYNCR0 50 2T 98-00, THUNDER 50 2T 95-98

RIEJU

FIRST 50 2T 95-98, WINDY 50 2T 95-98

YAMAHA

AEROX 50 2T 97-02, AEROX 50 2T 04-16, AEROX EURO 2 50 2T 03-03, AEROX NAKED 50 2T 13-16, AEROX R 50 2T 99-00, AXIS 50 2T 95-96, BREEZE 50 2T 94-95, JOG 50 2T 92-01, JOG ER 50 2T 00-02, JOG R 50 2T 02-02, JOG R EURO2 50 2T 02-02, JOG R EURO2 50 2T 06-15, JOG R LC 50 2T 02-15, JOG Z 50 2T 95-95, NEO'S 50 2T 97-02, NEO'S 50 2T 04-16, NEO'S EASY 50 2T 13-13, NEO'S EURO 2 50 2T 02-02, WHY 50 2T 98-05, WHY EURO 2 50 2T 03-05, ZEST 50 2T 95-92, ZUMA 50 2T 02-10
--

RICAMBI

9910500	Coppia petali in carbonio 0,30 mm
---------	-----------------------------------

9908880	Coppia petali in carbonio 0,25 mm
---------	-----------------------------------



cod. 9910930

Valvola lamellare con petali in fibra di carbonio (spessore 0,35 mm) per motore scooter 50 cc Gilera/Piaggio

APPLICABILITÀ

APRILIA MOJITO CUSTOM 2T MOTORE PIAGGIO 50 2T 04-10, SCARABEO 2T EU2 MOTORE PIAGGIO 50 2T 10-12, SCARABEO 2T NET 50 2T 09-10, SCARABEO STREET 50 2T 05-06, SCARABEO STREET 2T RESTYLING 50 2T 06-09, SPORT CITY ONE 2T 50 2T 08-11, SR MOTARD 50 2T 12-14, SR R 50 2T 04-09, SR R FACTORY CARBURATORE 50 2T 10-14, SR R FACTORY IE 50 2T 10-14, SR STREET CARBURATORE 50 2T 03-12

DERBI ATLANTIS 2T 50 2T 10-10, ATLANTIS 2T EU2 50 2T 07-09, ATLANTIS O2 50 2T 02-02, ATLANTIS O2 BULLET 50 2T 03-05, ATLANTIS O2 CITY 50 2T 04-06, ATLANTIS O2 RED BULLET 50 2T 03-03, ATLANTIS O2 TWO CHIC 50 2T 05-05, BOULEVARD 2T 50 2T 09-14, GP1 50 2T 01-03, GP1 EU 2 50 2T 05-05, GP1 OPEN EU2 50 2T 06-09, GP1 RACE EU2 50 2T 05-07, SONAR 2T 50 2T 09-09

GILERA DNA 50 2T 00-02, DNA 50 2T 05-07, DNA GP EXPERIENCE 50 2T 03-04, EASY MOVING 50 2T 95-96, ICE 50 2T 01-05, RUNNER 50 2T 97-00, RUNNER POGGIALI 50 2T 02-02, RUNNER PURE JET 50 2T-IE 02-07, RUNNER PURE JET 50 2T-IE 10-11, RUNNER PURE JET ST 50 2T-IE 08-08, RUNNER SP 50 2T 02-07, RUNNER SP 50 2T 10-12, RUNNER SP SPECIAL EDITION 50 2T 07-07, RUNNER SP ST & SIMONCELLI 50 2T 08-09, STALKER 50 2T 97-11, STALKER NAKED 50 2T 08-08, STALKER SPECIAL EDITION 50 2T 07-08, STORM 50 2T 94-95, STORM EURO 2 50 2T 07-07, TYPHOON 50 2T 94-97, TYPHOON X 50 2T 98-99, TYPHOON XR 50 2T 00-00

ITALJET PIAGGIO

JET SET 50 2T 02-02, TORPEDO NEW 50 2T 00-01

DIESIS 50 2T 01-01, FLY 2T 50 2T 05-07, FLY 2T 50 2T 10-11, FREE 50 2T 92-94, FREE DELIVERY 50 2T 00-01, FREE FL 50 2T 95-02, LIBERTY 50 2T 97-05, LIBERTY 2T 50 2T 06-08, LIBERTY 2T PTT EU2 50 2T 04-05, LIBERTY 2T RST 50 2T 04-04, LIBERTY 2T SPORT 50 2T 06-08, LIBERTY MOC 2T & ELLE 50 2T 09-13, NRG 50 2T 94-96, NRG EXTREME LC 50 2T 99-00, NRG MC3 50 2T 01-04, NRG POWER DD 50 2T 05-17, NRG POWER DD SERIE SPECIALE 50 2T 07-12, NRG POWER DT 50 2T 06-15, NRG POWER DT SERIE SPECIALE 50 2T 07-08, NRG POWER PUREJET 50 2T-IE 04-11, NRG PUREJET 50 2T-IE 02-04, NRG PUREJET 50 2T-IE 10-10, NRG RST MC2 50 2T 96-98, NTT 50 2T 95-96, QUARTZ 50 2T 92-96, SFERA 50 2T 91-93, SFERA MAQUILLAGE 2 50 2T 94-94, SFERA RST 50 2T 95-97, TYPHOON 50 2T 01-11, TYPHOON 2T E2 50 2T 10-12, TYPHOON 2T E3 CH 50 2T 11-11, VESPA ET2 50 2T 97-05, VESPA ET2 INIEZIONE 50 2T 97-00, VESPA LX 2T 50 2T 05-13, VESPA LX 2T TOURING & 30KM 50 2T 10-13, VESPA LXV 2T 50 2T 06-09, VESPA LXV 2T NAVY 50 2T 08-08, VESPA 50 2T & COLLEGE 50 2T 07-12, ZIP 50 2T 92-93, ZIP 50 2T 95-96, ZIP 2T 50 2T 08-13, ZIP BIMODALE 50 2T 94-97, ZIP FAST RIDER 50 2T 93-94, ZIP FAST RIDER RST 50 2T 96-97, ZIP LC 50 2T 00-04, ZIP RST 50 2T 96-99, ZIP SP 50 2T 96-04, ZIP SP EURO 2 50 2T 06-13

RICAMBI

9911290	Coppia petali in carbonio 0,30 mm
---------	-----------------------------------

9911300	Coppia petali in carbonio 0,35 mm
---------	-----------------------------------

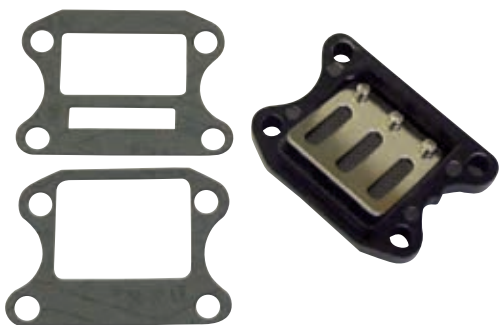

cod. 9912550

Valvola lamellare con petali in fibra di carbonio (spessore 0,30 mm) per motore scooter 50 cc Peugeot

APPLICABILITÀ

BSV DIO GP 50 2T 94-96, DIO SP 50 2T 94-96, DIO ZX 50 2T 94-96

HONDA BALI 50 2T 93-99, DIO SR 50 2T 92-00, DIO ZX 50 2T 94-96, LEAD 50 2T 89-90, MET IN 50 2T 90-92, SFX / SXR 50 2T 95-01, SGX SKY 50 2T 97-04, SH 50 2T 84-89, SH NEW 50 2T 96-01, SHADOW 50 2T 98-01, VISION 50 2T 88-95, X8R 50 2T 98-01, X8R X 50 2T 98-01

HSC SC 01 50 2T 94-96, SC 01 L 50 2T 94-96

KYMCO

CX 50 2T 93-93, CX SUPER 50 2T 94-97, DJ WORLD 50 2T 94-00, DJ Y 50 2T 93-93, FEVER ZX 50 2T 99-00, FEVER ZX EU2 50 2T 03-04, K 12 50 2T 95-00, KB 50 2T 95-00

PEUGEOT

BUXY 50 2T 90-02, BUXY RS 50 2T 90-02, ELYSEO 50 2T 90-02, LOOXOR 50 2T 90-02, METAL X 50 2T 90-02, METROPOLIS 50 2T 90-02, RAPIDO 50 2T 90-02, SPEEDAKE 50 2T 90-02, SPEEDFIGHT 50 2T 97-04, SPEEDFIGHT LC 50 2T 97-04, SQUAB 50 2T 90-02, ST 50 2T 90-02, SV GEO 50 2T 90-02, TREKKER 50 2T 90-02, VIVACITY 50 2T 90-02, X-FIGHT 50 2T 00-02, X-FIGHT LC 50 2T 00-02, ZENITH 50 2T 90-02

SYM

DD 50 2T 02-02

RICAMBI

9912970	Petalo in carbonio 0,30 mm
---------	----------------------------

9912980	Petalo in carbonio 0,35 mm
---------	----------------------------

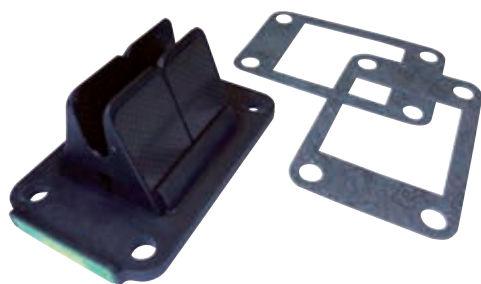

cod. 9931600

RACING

Valvola lamellare "TPR" black ad 8 petali in carbonio (spessore 0,30 mm) per motori Minarelli AM 50 cc

APPLICABILITÀ

APRILIA CLASSIC 50 2T 92-99, EUROPA 50 2T 90-92, MX 50 2T 04-04, MX MOTARD 50 2T 95-03, PEGASO 50 2T 92-94, RS 50 2T 91-05, RX 50 2T 89-04, RX 3-5 MARCE 50 2T 91-94, RX ENDURO 50 2T 95-03, RX RACING 50 2T 03-06, TUONO 50 2T 03-04

BETA RR 2T 50 EU4 50 2T 18-20, RR 50 RACING EU4 50 2T 18-20, RR ALU 50 2T 08-12, RR ENDURO 50 2T 06-17, RR MOTARD 50 2T 06-17

CH HUSQUARNA SM 50 2T 00-10, WR 50 2T 00-10, WSM 50 2T 00-10

CMC ENDURO 50 2T 11-11, MOTARD 50 2T 11-11

FANTIC CABALLERO MOTARD 50 2T 06-10, CABALLERO REGOLARITÀ 50 2T 06-10, ENDURO COMPETITION EU4 50 2T 18-20, ENDURO PERFORMANCE EU4 50 2T 18-20, MOTARD COMPETITION EU4 50 2T 18-20, MOTARD PERFORMANCE EU4 50 2T 18-20

HM BAJA, DERAPAGE BASIC 50 2T 10-11, CMC 50 2T 10-11, CRE BAJA RR, DERAPAGE RR 50 2T 07-11, CRE BAJA, DERAPAGE 50 2T 07-11, CRE SIX COMPETITION 50 2T 10-11, CRE SIX, BAIA, DERAPAGE 50 2T 95-06, CRE SIX, DERAPAGE COMPETITION 50 2T 07-09, DERAPAGE COMPETITION 50 2T 10-11

MALAGUTI CNK DRAGON 50 2T 05-07, FIFTY EVOLUTION 50 2T 90-93, XSM 50 2T 03-03, XTM 50 2T 03-03

MBK X LIMIT 50 2T 03-04, X POWER 50 2T 03-04

MINARELLI MOTORE AM 3-4-5 50 2T 91-95, MOTORE AM 6 1° SERIE 50 2T 96-11, MOTORE AM 6 2° SERIE 50 2T 12-18

MOTORHISPANIA

FURIA 50 2T 97-00, FURIA MAX 50 2T 10-12, RX 50 2T 09-12, RX R 50 2T 09-12

PEUGEOT

SUPERMOTARD 50 2T 90-02, XP6 TRAIL S/AVV. ELETTRICO 50 2T 90-02, XR6 RACING CAT. C/AVV.ELETT. 50 2T 90-02

RIEJU

MRT 50 2T 09-12, MRT 50 EU4 50 2T 18-20, MRT PRO 50 2T 09-12, MRT PRO EU4 50 2T 18-20, MRT PRO REPLICCA EU4 50 2T 18-20, MRT PRO REPLICCA SM EU4 50 2T 18-20, MRT PRO SM 50 2T 09-12, MRT PRO SM EU4 50 2T 18-20, MRT SM 50 2T 09-12, MRT SM EU4 50 2T 18-20, MRT TROPHY EU4 50 2T 18-20, MRX 50 2T 01-04, MRX PRO 50 2T 01-04, RR 50 2T 05-06, RS1 50 2T 98-01, RS2 MATRIX 50 2T 05-06, RS2 MATRIX PRO 50 2T 05-06, RS2 NAKED 50 2T 04-05, RS3 EU4 50 2T 18-20, RS3 NKD EU4 50 2T 18-20, SMX E.S./K.S. 50 2T 01-01, SMX PRO E.S./K.S. 50 2T 03-03, SPIKE 50 2T 98-01

SHERCO

FACTORY SE-R EU4 50 2T 18-20, FACTORY SE-RS EU4 50 2T 18-20, FACTORY SILVER SM-R EU4 50 2T 18-20, FACTORY SILVER SM-RS EU4 50 2T 18-20, FACTORY SM-R EU4 50 2T 18-20, FACTORY SM-RS EU4 50 2T 18-20, HRD ENDURO 50 2T 09-13, HRD MOTARD 50 2T 09-13

VENT

BAJA 50 2T 18-20, BAJA RR 50 2T 18-20, DERAPAGE 50 2T 18-20, DERAPAGE RR 50 2T 18-20

YAMAHA

DT R 50 2T 03-11, DT RSM 50 2T 03-05, DT X 50 2T 06-11, TZR 50 2T 03-08, TZR 50 2T 10-11, TZR RR 50 2T 05-05

RICAMBI

9933770	Petalo in carbonio 0,30 mm
---------	----------------------------

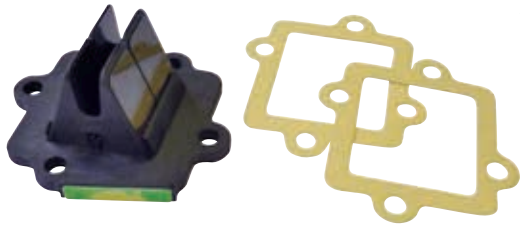

cod. **9931620** **RACING**

Valvola lamellare "TPR" black ad 8 petali in carbonio (spessore 0,30 mm) per motori scooter 50 cc Minarelli/Yamaha orizzontale

APPLICABILITÀ

APRILIA	AREA 51 50 2T 98-00, GULLIVER 50 2T 95-98, GULLIVER LC 50 2T 96-98, RALLY 50 2T 95-03, RALLY LIQUID COOLED 50 2T 96-99, SCARABEO 50 2T 93-05, SONIC 50 2T 98-07, SONIC GP 50 2T 98-08, SR (ORIZZONTALE) 50 2T 94-96, SR LIQUID COOLED 50 2T 94-96, SR RACING 50 2T 97-99, SR STEALTH 50 2T 97-00, SR WWW 50 2T 97-01
ATALA	CAROSSELLO 50 2T 99-01
BENELLI	491 GT 50 2T 98-99, 491 NAKED 50 2T 02-02, 491 RACING 50 2T 98-99, 491 RR 50 2T 99-01, 491 SP 50 2T 99-99, 491 SPORT 50 2T 98-99, 491 ST 50 2T 99-01, K2 50 2T 98-01, K2 LIQUID COOLED 50 2T 98-01, PEPE 50 2T 99-01, PEPE 50 2T 10-10, PEPE LX 50 2T 03-04, PEPE LX 50 2T 07-09, PEPE OLD 50 2T 07-09, PEPE OLD 50 2T 11-11, QUATTRONEX 50 2T 08-11
BETA	ARK 50 2T 96-08, ARK LC 50 2T 96-08, CHRONO 50 2T 95-96, EIKON 50 2T 99-03, QUADRA 50 2T 95-95, QUADRA 50 2T 99-01, TEMPO 50 2T 93-02, TEMPO 50 2T 95-95
CPI	ARAGON 50 2T 03-03, HUSSAR 50 2T 03-03, OLIVER 50 2T 03-03, POP CORN 50 2T 03-03
EXPLORER	CRACKER 50 2T 03-03
ITALJET	DRAGSTER 50 2T 98-02
KEEWAY	F-ACT 50 2T 07-08, FLASH 50 2T 07-08, FOCUS 50 2T 06-06, GOCCIA 50 2T 09-09, HURRICANE 50 2T 06-08, MATRIX 50 2T 06-08, PIXEL EURO 2 50 2T 09-12, RY8 50 2T 08-08
KTM	K50 50 2T 96-01

MACAL	THUNDER 50 2T 95-96
MALAGUTI	CENTRO SL 50 2T 94-98, CIAK 50 2T 99-01, CIAK EURO 2 2,3 50 2T 03-03, CIAK EURO2 50 2T 01-03, CIAK MASTER EURO 2 50 2T 06-06, F10 50 2T 92-00, F10 ACWAP 50 2T 08-08, F10 EURO 2 50 2T 02-06, F10 EURO 2,2,3 50 2T 03-04, F10 RESTYLING EURO 2 50 2T 06-06, F12 PHANTOM 50 2T 94-98, F12 PHANTOM EURO 2 50 2T 02-02, F12 PHANTOM EURO 2 2,3 50 2T 03-04, F12 PHANTOM LC 50 2T 94-98, F12 PHANTOM LC EURO 2 2,3 50 2T 03-04, F12 R PHANTOM AC 50 2T 07-08, F12 R PHANTOM LC 50 2T 07-10, F12 RESTYLING EURO 1 50 2T 99-02, F12 RESTYLING EURO 2 50 2T 06-06, F12 RESTYLING LC EURO 2 50 2T 06-06, F15 FIRE FOX 50 2T 96-98, F15 FIRE FOX AIR COOLED 50 2T 05-06, F15 FIRE FOX EURO 2 50 2T 02-06, F15 FIRE FOX EURO 2 2,3 50 2T 03-04, YESTERDAY 50 2T 97-00
MBK	EVOLIS 50 2T 92-95, FIZZ 50 2T 94-95, FLIPPER 50 2T 98-04, FLIPPER EURO 2 50 2T 03-03, FORTE 50 2T 94-96, MACH G 50 2T 02-04, MACH G LC 50 2T 02-04, NITRO 50 2T 97-04, NITRO EURO 2 50 2T 03-03, OVETTO 50 2T 97-04, OVETTO EURO 2 50 2T 02-02
MOTRON	SYNCRO 50 2T 98-00, THUNDER 50 2T 95-98
RIEJU	FIRST 50 2T 95-98, WINDY 50 2T 95-98
YAMAHA	AEROX 50 2T 97-02, AEROX 50 2T 04-16, AEROX EURO 2 50 2T 03-03, AEROX NAKED 50 2T 13-16, AEROX R 50 2T 99-00, AXIS 50 2T 95-96, BREEZE 50 2T 94-95, JOG 50 2T 92-01, JOG R 50 2T 02-02, JOG R EURO2 50 2T 02-02, JOG R EURO2 50 2T 06-15, JOG R LC 50 2T 02-15, NEO'S 50 2T 97-02, NEO'S 50 2T 04-16, NEO'S EASY 50 2T 13-13, NEO'S EURO 2 50 2T 02-02, WHY 50 2T 98-05, WHY EURO 2 50 2T 03-05, ZEST 50 2T 95-92

RICAMBI

9933790	Petalo in carbonio 0,30 mm
---------	----------------------------

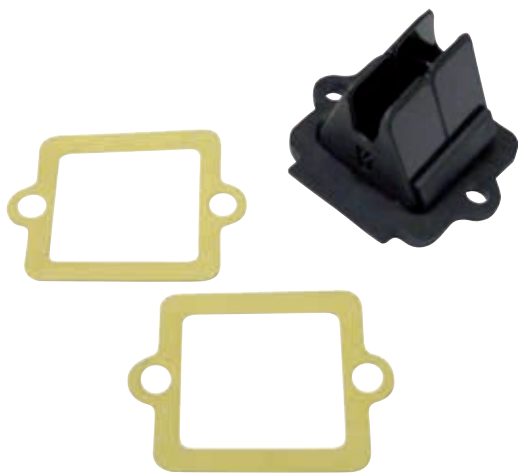

cod. **9931640** **RACING**

Valvola lamellare "TPR" black ad 8 petali in carbonio (spessore 0,30 mm) per motori scooter 50 cc Piaggio/Gilera

APPLICABILITÀ

APRILIA	MOJITO CUSTOM 2T MOTORE PIAGGIO 50 2T 04-10, SCARABEO 2T EU2 MOTORE PIAGGIO 50 2T 10-12, SCARABEO 2T NET 50 2T 09-10, SCARABEO STREET 50 2T 05-06, SCARABEO STREET 2T RESTYLING 50 2T 06-09, SPORT CITY ONE 2T 50 2T 08-11, SR MOTARD 50 2T 12-14, SR R 50 2T 04-09, SR R FACTORY CARBURATORE 50 2T 10-14, SR R FACTORY IE 50 2T 10-14, SR STREET CARBURATORE 50 2T 03-12
DERBI	ATLANTIS 2T 50 2T 10-10, ATLANTIS 2T EU2 50 2T 07-09, ATLANTIS O2 50 2T 02-02, ATLANTIS O2 BULLET 50 2T 03-05, ATLANTIS O2 CITY 50 2T 04-06, ATLANTIS O2 RED BULLET 50 2T 03-03, ATLANTIS O2 TWO CHIC 50 2T 05-05, BOULEVARD 2T 50 2T 09-14, GP1 50 2T 01-03, GP1 EU 2 50 2T 05-05, GP1 OPEN EU2 50 2T 06-09, GP1 RACE EU2 50 2T 05-07, SONAR 2T 50 2T 09-09
GILERA	DNA 50 2T 00-02, DNA 50 2T 05-07, DNA GP EXPERIENCE 50 2T 03-04, EASY MOVING 50 2T 95-96, ICE 50 2T 01-05, RUNNER 50 2T 97-00, RUNNER POGGIALI 50 2T 02-02, RUNNER PURE JET 50 2T-IE 02-07, RUNNER PURE JET 50 2T-IE 10-11, RUNNER PURE JET ST 50 2T-IE 08-08, RUNNER SP 50 2T 02-07, RUNNER SP 50 2T 10-12, RUNNER SP SPECIAL EDITION 50 2T 07-07, RUNNER SP ST & SIMONCELLI 50 2T 08-09, STALKER 50 2T 97-11, STALKER NAKED 50 2T 08-08, STALKER SPECIAL EDITION 50 2T 07-08, STORM 50 2T 94-95, STORM EURO 2 50 2T 07-07, TYPHOON 50 2T 94-97, TYPHOON X 50 2T 98-99, TYPHOON XR 50 2T 00-00

ITALJET	JET SET 50 2T 02-02, TORPEDO NEW 50 2T 00-01
PIAGGIO	DIESIS 50 2T 01-01, FLY 2T 50 2T 05-07, FLY 2T 50 2T 10-11, FREE 50 2T 92-94, FREE DELIVERY 50 2T 00-01, FREE FL 50 2T 95-02, LIBERTY 50 2T 97-05, LIBERTY 2T 50 2T 06-08, LIBERTY 2T PTT EU2 50 2T 04-05, LIBERTY 2T RST 50 2T 04-04, LIBERTY 2T SPORT 50 2T 06-08, LIBERTY MOC 2T & ELLE 50 2T 09-13, NRG 50 2T 94-96, NRG EXTREME LC 50 2T 99-00, NRG MC3 50 2T 01-04, NRG POWER DD 50 2T 05-17, NRG POWER DD SERIE SPECIALE 50 2T 07-12, NRG POWER DT 50 2T 06-15, NRG POWER DT SERIE SPECIALE 50 2T 07-08, NRG POWER PUREJET 50 2T-IE 04-11, NRG PUREJET 50 2T-IE 02-04, NRG PUREJET 50 2T-IE 10-10, NRG RST MC2 50 2T 96-98, NTT 50 2T 95-96, QUARTZ 50 2T 92-96, SFERA 50 2T 91-93, SFERA MAQUILLAGE 2 50 2T 94-94, SFERA RST 50 2T 95-97, TYPHOON 50 2T 01-11, TYPHOON 2T E2 50 2T 10-12, TYPHOON 2T E3 CH 50 2T 11-11, VESPA ET2 50 2T 97-05, VESPA ET2 INIEZIONE 50 2T 97-00, VESPA LX 2T 50 2T 05-13, VESPA LX 2T TOURING & 30KM 50 2T 10-13, VESPA LXV 2T 50 2T 06-09, VESPA LXV 2T NAVY 50 2T 08-08, VESPA S 2T & COLLEGE 50 2T 07-12, ZIP 50 2T 92-93, ZIP 50 2T 95-96, ZIP 2T 50 2T 08-13, ZIP BIMODALE 50 2T 94-97, ZIP FAST RIDER 50 2T 93-94, ZIP FAST RIDER RST 50 2T 96-97, ZIP LC 50 2T 00-04, ZIP RST 50 2T 96-99, ZIP SP 50 2T 96-04, ZIP SP EURO 2 50 2T 06-13

RICAMBI

9933790	Petalo in carbonio 0,30 mm
---------	----------------------------



cod. **9910780**
Variatore Peugeot con cinghia

APPLICABILITÀ

PEUGEOT BUXY 50 2T 90-02, BUXY RS 50 2T 90-02, SPEEDAKE 50 2T 90-02

RICAMBI

9910790	Cinghia Peugeot 755X18x30
9915530	Tasselli Di Traino Per Variatore Scooter Minarelli 50C

9915570	Sr. Masse Variatore Ø 15 Gr.7,5
----------------	---------------------------------



cod. **9931260**
Variotop TROPHY "TPR" con cinghia per motore scooter 50 cc Piaggio masse Ø 19

APPLICABILITÀ

PIAGGIO VESPA ET2 INIEZIONE 50 2T 97-00, VESPA ET4 50 4T 00-05, VESPA LX 2T 50 2T 05-13, VESPA LX 2T TOURING & 30KM 50 2T 10-13, VESPA LX 4T 50 4T 05-09, VESPA LX 4T 4V 50 4T-4V 09-13, VESPA LX 4T 4V TOURING 50 4T-4V 10-13, VESPA LXV 2T 50 2T 06-09, VESPA LXV 2T NAVY 50 2T 08-08, VESPA S 2T & COLLEGE 50 2T 07-12, VESPA S 4T 4V & COLLEGE 50 4T-4V 08-12, ZIP 2T 50 2T 08-13, ZIP 4T 50 4T 00-13, ZIP LC 50 2T 00-04, ZIP SP 50 2T 96-04, ZIP SP EURO 2 50 2T 06-13

RICAMBI

9919990	Masse variatore Ø 19x15,5 gr. 7
9922040	Cinghia di trasmissione
9930940	Puleggia anteriore mobile
9928400	Piattello portatasselli

9928410	Tasselli di traino
9923070	Distanziale

cod. **9931300**
Variotop TROPHY "TPR" con cinghia per motore scooter 50 cc Piaggio masse Ø 19

APPLICABILITÀ

APRILIA MOJITO CUSTOM 2T MOTORE PIAGGIO 50 2T 04-10, SR MOTARD 50 2T 12-14, SR R 50 2T 04-09, SR R FACTORY CARBURATORE 50 2T 10-14, SR R FACTORY IE 50 2T 10-14, SR STREET CARBURATORE 50 2T 03-12

DERBI ATLANTIS 2T 50 2T 10-10, ATLANTIS 2T EU2 50 2T 07-09, ATLANTIS O2 50 2T 02-02, ATLANTIS O2 BULLET 50 2T 03-05, ATLANTIS O2 CITY 50 2T 04-06, ATLANTIS O2 RED BULLET 50 2T 03-03, ATLANTIS O2 TWO CHIC 50 2T 05-05, GP1 50 2T 01-03, GP1 EU 2 50 2T 05-05, GP1 OPEN EU2 50 2T 06-09, GP1 RACE EU2 50 2T 05-07

GILERA ICE 50 2T 01-05, RUNNER 50 2T 97-00, RUNNER PURE JET 50 2T-IE 02-07, RUNNER PURE JET 50 2T-IE 10-11, RUNNER SP 50 2T 02-04, STALKER 50 2T 97-11, STALKER NAKED 50 2T 08-08, STALKER SPECIAL EDITION 50 2T 07-08, STORM EURO 2 50 2T 07-07, TYPHOON XR 50 2T 00-00

PIAGGIO DIESIS 50 2T 01-01, NRG MC3 50 2T 01-04, NRG POWER DD 50 2T 05-17, NRG POWER DD SERIE SPECIALE 50 2T 07-12, NRG POWER DT 50 2T 06-15, NRG POWER DT SERIE SPECIALE 50 2T 07-08, NRG POWER PUREJET 50 2T-IE04-11, NRG PUREJET 50 2T-IE 02-04, NRG PUREJET 50 2T-IE 10-10, TYPHOON 50 2T 01-11

RICAMBI

9919990	Masse variatore Ø 19x15,5 gr. 7
9922030	Cinghia di trasmissione
9930940	Puleggia anteriore mobile
9928400	Piattello portatasselli

9928410	Tasselli di traino
9923070	Distanziale



cod. 9927610

Variotop TROPHY "TPR" con molla di contrasto per Piaggio 50 cc con masse Ø 19

APPLICABILITÀ

APRILIA MOJITO CUSTOM 2T MOTORE PIAGGIO 50 2T 04-10, SCARABEO 2T EU2 MOTORE PIAGGIO 50 2T 10-12, SCARABEO 2T NET 50 2T 09-10, SCARABEO 4T 50 4T 02-06, SCARABEO 4T 4V 50 4T-4V 10-12, SCARABEO 4T 4V NET 50 4T-4V 09-09, SCARABEO 4T RESTYLING EU3 50 4T 06-09, SCARABEO QUATTRO 50 4T-4V 09-09, SCARABEO STREET 50 2T 05-06, SCARABEO STREET 2T RESTYLING 50 2T 06-09, SPORT CITY ONE 2T 50 2T 08-11, SPORT CITY ONE 4T 50 4T 08-10, SR MOTARD 50 2T 12-14, SR R 50 2T 04-09, SR R FACTORY CARBURATORE 50 2T 10-14, SR R FACTORY IE 50 2T 10-14, SR STREET CARBURATORE 50 2T 03-12

DERBI ATLANTIS 2T 50 2T 10-10, ATLANTIS 2T EU2 50 2T 07-09, ATLANTIS 02 50 2T 02-02, ATLANTIS 02 BULLET 50 2T 03-05, ATLANTIS 02 CITY 50 2T 04-06, ATLANTIS 02 RED BULLET 50 2T 03-03, ATLANTIS 02 TWO CHIC 50 2T 05-05, BOULEVARD 2T 50 2T 09-14, GP1 50 2T 01-03, GP1 EU 2 50 2T 05-05, GP1 OPEN EU2 50 2T 06-09, GP1 RACE EU2 50 2T 05-07, SONAR 2T 50 2T 09-09

GILERA DNA 50 2T 00-02, DNA 50 2T 05-07, DNA GP EXPERIENCE 50 2T 03-04, EASY MOVING 50 2T 95-96, ICE 50 2T 01-05, RUNNER 50 2T 97-00, RUNNER POGGIALI 50 2T 02-02, RUNNER PURE JET 50 2T-IE 02-07, RUNNER PURE JET 50 2T-IE 10-11, RUNNER SP 50 2T 02-07, RUNNER SP 50 2T 10-12, RUNNER SP SPECIAL EDITION 50 2T 07-07, RUNNER SP ST & SIMONCELLI 50 2T 08-09, STALKER 50 2T 97-11, STALKER NAKED 50 2T 08-08, STALKER SPECIAL EDITION 50 2T 07-08, STORM 50 2T 94-95, STORM EURO 2 50 2T 07-07, TYPHOON 50 2T 94-97, TYPHOON X 50 2T 98-99, TYPHOON XR 50 2T 00-00

ITALJET JET SET 50 2T 02-02, TORPEDO 50 4T 97-00, TORPEDO NEW 50 2T 00-01

MALAGUTI CENTRO EURO 2 50 4T 08-08, CIAK MASTER 4T 50 4T 05-06

PIAGGIO DIESEL 50 2T 01-01, FLY 2T 50 2T 05-07, FLY 2T 50 2T 10-11, FLY 4T 50 4T 05-07, FLY 4T & 25-30 KM/H 50 4T 08-11, FLY 4T 4V 50 4T-4V 12-13, FLY 4T MOTORE CHN 50 4T 06-07, FREE 50 2T 92-94, FREE DELIVERY 50 2T 00-01, FREE FL 50 2T 95-02, LIBERTY 50 2T 97-05, LIBERTY 2T 50 2T 06-08, LIBERTY 2T PTT EU2 50 2T 04-05, LIBERTY 2T RST 50 2T 04-04, LIBERTY 2T SPORT 50 2T 06-08, LIBERTY 4T 50 4T 00-02, LIBERTY 4T 3V IE 50 4T-3V 15-17, LIBERTY 4T 3V IE E4 50 4T-3V 17-18, LIBERTY 4T DELIVERY - SINGLE 50 4T 10-14, LIBERTY 4T DELIVERY TNT 50 4T 09-09, LIBERTY 4T IGET CORPORATE E4 50 4T-3V 18-18, LIBERTY 4T PTT - DOUBLE - NEXIVE 50 4T 09-17, LIBERTY 4T RST 50 4T 04-04, LIBERTY 4T SPORT 50 4T 07-08, LIBERTY IGET 4T 3V IE E4 EMEA 50 4T-3V 17-18, LIBERTY MOC 2T & ELLE 50 2T 09-13, LIBERTY MOC 4T & ELLE 50 4T 09-16, NRG 50 2T 94-96, NRG EXTREME LC 50 2T 99-00, NRG MC3 50 2T 01-04, NRG POWER DD 50 2T 05-17, NRG POWER DD SERIE SPECIALE 50 2T 07-12, NRG POWER DT 50 2T 06-15, NRG POWER DT SERIE SPECIALE 50 2T 07-08, NRG POWER PUREJET 50 2T-IE 04-11, NRG PUREJET 50 2T-IE 02-04, NRG PUREJET 50 2T-IE 10-10, NRG RST MC2 50 2T 96-98, NTT 50 2T 95-96, QUARTZ 50 2T 92-96, SFERA 50 2T 91-93, SFERA MAQUILLAGE 2 50 2T 94-94, SFERA RST 50 2T 95-97, TYPHOON 50 2T 01-11, TYPHOON 2T E2 50 2T 10-12, TYPHOON 2T E3 CH 50 2T 11-11, VESPA ET2 50 2T 97-05, VESPA ET2 INIEZIONE 50 2T 97-00, VESPA ET4 50 4T 00-05, VESPA LX 2T 50 2T 05-13, VESPA LX 2T TOURING & 30KM 50 2T 10-13, VESPA LX 4T 50 4T 05-09, VESPA LX 4T 4V 50 4T-4V 09-13, VESPA LX 4T 4V TOURING 50 4T-4V 10-13, VESPA LXV 2T 50 2T 06-09, VESPA LXV 2T NAVY 50 2T 08-08, VESPA PRIMAVERA 4T 3V NOABS E4 50 4T-3V 17-18, VESPA S 2T & COLLEGE 50 2T 07-12, VESPA S 4T 4V & COLLEGE 50 4T-4V 08-12, VESPA SPRINT 4T 3V E4 50 4T-3V 17-18, ZIP 50 2T 92-93, ZIP 50 2T 95-96, ZIP 2 50 2T 08-13, ZIP 4T 50 4T 00-13, ZIP BIMODALE 50 2T 94-97, ZIP FAST RIDER 50 2T 93-94, ZIP FAST RIDER RST 50 2T 96-97, ZIP LC 50 2T 00-04, ZIP RST 50 2T 96-99, ZIP SP 50 2T 96-04, ZIP SP EURO 2 50 2T 06-13

RICAMBI

9914450	Molle contrasto variatore
9919990	Masse variatore Ø 19X15,5 gr. 7
9930940	Puleggia anteriore mobile
9928400	Piattello portatasselli

9928410	Tasselli di traino
9923070	Distanziale

cod. 9924900

Variotop "TPR" con molla di contrasto per Keeway - CPI 50 cc

APPLICABILITÀ

BENELLI PEPE 50 2T 10-10, PEPE LX 50 2T 07-09, PEPE OLD 50 2T 07-09, PEPE OLD 50 2T 11-11, QUATTRONONEX 50 2T 08-11

CPI ARAGON 50 2T 03-03, HUSSAR 50 2T 03-03, OLIVER 50 2T 03-03, POP CORN 50 2T 03-03

EXPLORER CRACKER 50 2T 03-03

KEEWAY ATV EC2 50 2T 06-06, ATV OFF ROAD 50 2T 07-07, F-ACT 50 2T 07-08, FLASH 50 2T 07-08, FOCUS 50 2T 06-06, GOCCIA 50 2T 09-09, HURRICANE 50 2T 06-08, MATRIX 50 2T 06-08, PIXEL EURO 2 50 2T 09-12, RY8 50 2T 08-08

MALAGUTI F10 AC WAP 50 2T 08-08, F12 R PHANTOM AC 50 2T 07-08

RICAMBI

9906140	Masse variatore Ø 15X12 gr. 5,6
9915530	Tasselli di traino
9924920	Boccola

9924930	Piattello portatasselli
9925410	Puleggia anteriore mobile
9925420	Serie rasamenti

cod. 9926130

Variotop "TPR" con molla di contrasto Yamaha - MBK 50 cc 4T

APPLICABILITÀ

MBK BOOSTER X IE 50 4T-3V 08-08, OVETTO 4T 50 4T-3V 09-11

YAMAHA GIGGLE 50 4T-3V 08-08, NEO'S 4 50 4T-3V 09-15

RICAMBI

9912820	Kit rasamenti
9915520	Masse variatore Ø 15X12 gr. 6,5
9915530	Tasselli di traino

9923130	Boccola
9926700	Cappellotto portatasselli



cod. 9931650

Variotop Trophy "TPR" con molla di contrasto per scooter 50 cc Minarelli/Yamaha masse Ø 16

APPLICABILITÀ

APRILIA AMICO 50 2T 94-94, AMICO 50 2T 96-98, AMICO GL/GLE 50 2T 93-95, AMICO LX/SPORT/CAT 50 2T 92-93, AREA 51 50 2T 98-00, GULLIVER 50 2T 95-98, GULLIVER LC 50 2T 96-98, RALLY 50 2T 95-03, RALLY LIQUID COOLED 50 2T 96-99, SCARABEO 50 2T 93-05, SONIC 50 2T 98-07, SONIC GP 50 2T 98-08, SR (ORIZZONTALE) 50 2T 94-96, SR (VERTICALE) 50 2T 93-93, SR LIQUID COOLED 50 2T 94-96, SR RACING 50 2T 97-99, SR STEALTH 50 2T 97-00, SR WWW 50 2T 97-01

ATALA CAROSELLO 50 2T 99-01

BENELLI 491 GT 50 2T 98-99, 491 NAKED 50 2T 02-02, 491 RACING 50 2T 98-99, 491 RR 50 2T 99-01, 491 SP 50 2T 99-99, 491 SPORT 50 2T 98-99, 491 ST 50 2T 99-01, K2 50 2T 98-01, K2 LIQUID COOLED 50 2T 98-01, PEPE 50 2T 99-01, PEPE LX 50 2T 03-04

BETA ARK 50 2T 96-08, ARK LC 50 2T 96-08, CHRONO 50 2T 95-96, EIKON 50 2T 99-03, QUADRA 50 2T 95-95, QUADRA 50 2T 99-01, TEMPO 50 2T 93-02, TEMPO 50 2T 95-95

ITALJET DRAGSTER 50 2T 98-02

KTM K50 50 2T 96-01

MACAL THUNDER 50 2T 95-96

MALAGUTI CENTRO SL 50 2T 94-98, CIAK 50 2T 99-01, CIAK EURO 2,2 50 2T 03-03, CIAK EURO2 50 2T 01-03, CIAK MASTER EURO 2 50 2T 06-06, F10 50 2T 92-00, F10 EURO 2 50 2T 02-06, F10 EURO 2,2 50 2T 03-04, F10 RESTYLING EURO 2 50 2T 06-06, F12 PHANTOM 50 2T 94-98, F12 PHANTOM EURO 2 50 2T 02-02, F12 PHANTOM EURO 2,2 50 2T 03-04, F12 PHANTOM LC 50 2T 94-98, F12 PHANTOM LC EURO 2,2 50 2T 03-04, F12 R PHANTOM LC 50 2T 07-10, F12 RESTYLING EURO 1 50 2T 99-02, F12 RESTYLING EURO 2 50 2T 06-06, F12 RESTYLING LC EURO 2 50 2T 06-06, F15 FIRE FOX 50 2T 96-98, F15 FIRE FOX AIR COOLED 50 2T 05-06, F15 FIRE FOX EURO 2 50 2T 02-06, F15 FIRE FOX EURO 2,2 50 2T 03-04, YESTERDAY 50 2T 97-00

MBK BOOSTER 50 2T 90-04, BOOSTER 50 2T 90-94, BOOSTER EURO 2 50 2T 04-04, BOOSTER NG 50 2T 95-03, BOOSTER ROCKET 50 2T 97-98, BOOSTER SPIRIT 50 2T 96-00, BOOSTER SPIRIT 50 2T 03-03, BOOSTER SPIRIT EURO2 50 2T 03-03, BOOSTER TRACK 50 2T 96-98, EVOLIS 50 2T 92-95, FIZZ 50 2T 94-95, FLIPPER 50 2T 98-04, FLIPPER EURO 2 50 2T 03-03, FORTE 50 2T 94-96, MACH G 50 2T 02-04, MACH G LC 50 2T 02-04, NITRO 50 2T 97-04, NITRO EURO 2 50 2T 03-03, OVETTO 50 2T 97-04, OVETTO EURO 2 50 2T 02-02, STUNT 50 2T 00-02

MOTRON SYNCRO 50 2T 98-00, THUNDER 50 2T 95-98

RIEJU FIRST 50 2T 95-98, WINDY 50 2T 95-98

YAMAHA AEROX 50 2T 97-02, AEROX 50 2T 04-16, AEROX EURO 2 50 2T 03-03, AEROX NAKED 50 2T 13-16, AEROX R 50 2T 99-00, AXIS 50 2T 95-96, BREEZE 50 2T 94-95, BW'S 50 2T 97-16, BW'S BUMP 50 2T 97-98, BW'S EASY 50 2T 13-13, BW'S NAKED 50 2T 03-04, BW'S NAKED 50 2T 09-16, BW'S NEXT GENERATION 50 2T 97-06, BW'S ORIGINAL 50 2T 99-01, BW'S ORIGINAL EURO 2 50 2T 03-03, JOG 50 2T 92-01, JOG R 50 2T 02-02, JOG R EURO2 50 2T 02-02, JOG R EURO2 50 2T 06-15, JOG R LC 50 2T 02-15, NEO'S 50 2T 97-02, NEO'S 50 2T 04-16, NEO'S EASY 50 2T 13-13, NEO'S EURO 2 50 2T 02-02, RS SPY 50 2T 95-98, SLIDER 50 2T 00-02, WHY 50 2T 98-05, WHY EURO 2 50 2T 03-05, ZEST 50 2T 95-92, ZUMA 50 2T 97-01

RICAMBI

9914370	Serie massette Ø 16 Gr. 7
9914470	Molla contrasto carico 26 kg
9915460	Dado con rondella conica
9915470	Scodellino dentato
9915480	Piastrina traino
9916790	Distanziale

9931660	Puleggia mobile anteriore
9928580	Cappellotto porta tasselli
9931350	Tasselli di traino
9931380	Boccola
9931360	Spessore Ø 13,2x22x1,8



cod. 9931670

Variotop Trophy "TPR" con cinghia scooter 50 cc Minarelli/Yamaha verticale/orizzontale lungo e F12 2000 - masse Ø 16

APPLICABILITÀ

APRILIA AMICO 50 2T 94-94, AMICO 50 2T 96-98, AMICO GL/GLE 50 2T 93-95, AMICO LX/SPORT/CAT 50 2T 92-93, AREA 51 50 2T 98-00, GULLIVER 50 2T 95-98, GULLIVER LC 50 2T 96-98, RALLY 50 2T 95-03, RALLY LIQUID COOLED 50 2T 96-99, SCARABEO 50 2T 93-05, SR (ORIZZONTALE) 50 2T 94-96, SR (VERTICALE) 50 2T 93-93, SR LIQUID COOLED 50 2T 94-96, SR RACING 50 2T 97-99, SR STEALTH 50 2T 97-00, SR WWW 50 2T 97-01

ATALA CAROSELLO 50 2T 99-01

BENELLI 491 GT 50 2T 98-99, 491 NAKED 50 2T 02-02, 491 RACING 50 2T 98-99, 491 RR 50 2T 99-01, 491 SP 50 2T 99-99, 491 SPORT 50 2T 98-99, 491 ST 50 2T 99-01, K2 50 2T 98-01, K2 LIQUID COOLED 50 2T 98-01, PEPE 50 2T 99-01, PEPE LX 50 2T 03-04

BETA ARK 50 2T 96-08, ARK LC 50 2T 96-08, CHRONO 50 2T 95-96, EIKON 50 2T 99-03, QUADRA 50 2T 95-95, QUADRA 50 2T 99-01, TEMPO 50 2T 93-02, TEMPO 50 2T 95-95

ITALJET DRAGSTER 50 2T 98-02

KTM K50 50 2T 96-01

MACAL THUNDER 50 2T 95-96

MALAGUTI CENTRO SL 50 2T 94-98, CIAK 50 2T 99-01, CIAK EURO 2,2 50 2T 03-03, CIAK EURO2 50 2T 01-03, CIAK MASTER EURO 2 50 2T 06-06, F12 PHANTOM 50 2T 94-98, F12 PHANTOM EURO 2 50 2T 02-02, F12 PHANTOM EURO 2,2 50 2T 03-04, F12 PHANTOM LC 50 2T 94-98, F12 PHANTOM LC EURO 2,2 50 2T 03-04, F12 R PHANTOM LC 50 2T 07-10, F12 RESTYLING EURO 1 50 2T 99-02, F12 RESTYLING EURO 2 50 2T 06-06, F12 RESTYLING LC EURO 2 50 2T 06-06, F15 FIRE FOX 50 2T 96-98, F15 FIRE FOX AIR COOLED 50 2T 05-06, F15 FIRE FOX EURO 2 50 2T 02-06, F15 FIRE FOX EURO 2,2 50 2T 03-04

MBK BOOSTER 50 2T 90-04, BOOSTER 50 2T 90-94, BOOSTER EURO 2 50 2T 04-04, BOOSTER NG 50 2T 95-03, BOOSTER ROCKET 50 2T 97-98, BOOSTER SPIRIT 50 2T 96-00, BOOSTER SPIRIT 50 2T 03-03, BOOSTER SPIRIT EURO2 50 2T 03-03, BOOSTER TRACK 50 2T 96-98, FLIPPER 50 2T 98-04, FLIPPER EURO 2 50 2T 03-03, MACH G 50 2T 02-04, MACH G LC 50 2T 02-04, NITRO 50 2T 97-04, NITRO EURO 2 50 2T 03-03, OVETTO 50 2T 97-04, OVETTO EURO 2 50 2T 02-02, STUNT 50 2T 00-02

MOTRON SYNCRO 50 2T 98-00, THUNDER 50 2T 95-98

RIEJU FIRST 50 2T 95-98, WINDY 50 2T 95-98

YAMAHA AEROX 50 2T 97-02, AEROX 50 2T 04-16, AEROX EURO 2 50 2T 03-03, AEROX NAKED 50 2T 13-16, AEROX R 50 2T 99-00, BW'S 50 2T 97-16, BW'S BUMP 50 2T 97-98, BW'S EASY 50 2T 13-13, BW'S NAKED 50 2T 03-04, BW'S NAKED 50 2T 09-16, BW'S NEXT GENERATION 50 2T 97-06, BW'S ORIGINAL 50 2T 99-01, BW'S ORIGINAL EURO 2 50 2T 03-03, JOG R 50 2T 02-02, JOG R EURO2 50 2T 02-02, JOG R EURO2 50 2T 06-15, JOG R LC 50 2T 02-15, NEO'S 50 2T 97-02, NEO'S 50 2T 04-16, NEO'S EASY 50 2T 13-13, NEO'S EURO 2 50 2T 02-02, RS SPY 50 2T 95-98, SLIDER 50 2T 00-02, WHY 50 2T 98-05, WHY EURO 2 50 2T 03-05, ZUMA 50 2T 97-01

RICAMBI

9907770	Cinghia racing
9914370	Serie massette Ø 16 Gr. 7
9915460	Dado con rondella conica
9915470	Scodellino dentato
9915480	Piastrina traino
9916790	Distanziale

9931660	Puleggia mobile anteriore
9928580	Cappellotto porta tasselli
9931350	Tasselli di traino
9931380	Boccola
9931360	Spessore Ø 13,2x22x1,8



cod. 9931690

Variotop Trophy "TPR" con cinghia scooter 50 cc Minarelli/Yamaha orizzontale corto (f10)
masse Ø 16

APPLICABILITÀ

APRILIA SONIC 50 2T 98-07, SONIC GP 50 2T 98-08
MALAGUTI F10 50 2T 92-00, F10 EURO 2 50 2T 02-06, F10 EURO 2 2,3 50 2T 03-04, F10 RESTYLING EURO 2 50 2T 06-06, YESTERDAY 50 2T 97-00

MBK EVOLIS 50 2T 92-95, FIZZ 50 2T 94-95, FORTE 50 2T 94-96
YAMAHA AXIS 50 2T 95-96, BREEZE 50 2T 94-95, JOG 50 2T 92-01, ZEST 50 2T 95-92

RICAMBI

9907900	Cinghia racing
9914370	Serie massette Ø 16 Gr. 7
9915460	Dado con rondella conica
9915470	Scodellino dentato
9915480	Piastrina traino
9931660	Puleggia mobile anteriore

9928580	Cappellotto porta tasselli
9931350	Tasselli di traino
9931380	Boccola
9931360	Spessore Ø 13,2x22x1,8



cod. 9915540

Piattello portatasselli inclinazione 67° per variatore Minarelli/Yamaha 50 cc

APPLICABILITÀ

APRILIA AMICO 50 2T 94-94, AMICO 50 2T 96-98, AMICO GL/GLE 50 2T 93-95, AMICO LX/SPORT/CAT 50 2T 92-93, AREA 51 50 2T 98-00, GULLIVER 50 2T 95-98, GULLIVER LC 50 2T 96-98, RALLY 50 2T 95-03, RALLY LIQUID COOLED 50 2T 96-99, SCARABEO 50 2T 93-05, SONIC 50 2T 98-07, SONIC GP 50 2T 98-08, SR (ORIZZONTALE) 50 2T 94-96, SR (VERTICALE) 50 2T 93-93, SR LIQUID COOLED 50 2T 94-96, SR RACING 50 2T 97-99, SR STEALTH 50 2T 97-00, SR WWW 50 2T 97-01

ATALA CAROSELLO 50 2T 99-01

BENELLI 491 GT 50 2T 98-99, 491 NAKED 50 2T 02-02, 491 RACING 50 2T 98-99, 491 RR 50 2T 99-01, 491 SP 50 2T 99-99, 491 SPORT 50 2T 98-99, 491 ST 50 2T 99-01, K2 50 2T 98-01, K2 LIQUID COOLED 50 2T 98-01, PEPE 50 2T 99-01, PEPE LX 50 2T 03-04

BETA ARK 50 2T 96-08, ARK LC 50 2T 96-08, CHRONO 50 2T 95-96, EIKON 50 2T 99-03, QUADRA 50 2T 95-95, QUADRA 50 2T 99-01, TEMPO 50 2T 93-02, TEMPO 50 2T 95-95

ITALJET DRAGSTER 50 2T 98-02

KTM K50 50 2T 96-01

MACAL THUNDER 50 2T 95-96

MALAGUTI CENTRO SL 50 2T 94-98, CIAK 50 2T 99-01, CIAK EURO 2 2,3 50 2T 03-03, CIAK EURO2 50 2T 01-03, CIAK MASTER EURO 2 50 2T 06-06, F10 50 2T 92-00, F10 EURO 2 50 2T 02-06, F10 EURO 2 2,3 50 2T 03-04, F10 RESTYLING EURO 2 50 2T 06-06, F12 PHANTOM 50 2T 94-98, F12 PHANTOM EURO 2 50 2T 02-02, F12 PHANTOM EURO 2 2,3 50 2T 03-04, F12 PHANTOM LC 50 2T 94-98, F12 PHANTOM LC EURO 2 2,3 50 2T 03-04, F12 R PHANTOM LC 50 2T 07-10, F12 RESTYLING EURO 1 50 2T 99-02, F12 RESTYLING EURO 2 50 2T 06-06, F12 RESTYLING LC EURO 2 50 2T 06-06, F15 FIRE FOX 50 2T 96-98, F15 FIRE FOX AIR COOLED 50 2T 05-06, F15 FIRE FOX EURO 2 50 2T 02-06, F15 FIRE FOX EURO 2 2,3 50 2T 03-04, YESTERDAY 50 2T 97-00

MBK BOOSTER 50 2T 90-04, BOOSTER 50 2T 90-94, BOOSTER EURO 2 50 2T 04-04, BOOSTER NG 50 2T 95-03, BOOSTER ROCKET 50 2T 97-98, BOOSTER SPIRIT 50 2T 96-00, BOOSTER SPIRIT 50 2T 03-03, BOOSTER SPIRIT EURO2 50 2T 03-03, BOOSTER TRACK 50 2T 96-98, EVOLIS 50 2T 92-95, FIZZ 50 2T 94-95, FLIPPER 50 2T 98-04, FLIPPER EURO 2 50 2T 03-03, FORTE 50 2T 94-96, MACH G 50 2T 02-04, MACH G LC 50 2T 02-04, NITRO 50 2T 97-04, NITRO EURO 2 50 2T 03-03, OVETTO 50 2T 97-04, OVETTO EURO 2 50 2T 02-02, STUNT 50 2T 00-02

MOTRON SYNCRO 50 2T 98-00, THUNDER 50 2T 95-98

RIEJU FIRST 50 2T 95-98, WINDY 50 2T 95-98

YAMAHA AEROX 50 2T 97-02, AEROX 50 2T 04-16, AEROX EURO 2 50 2T 03-03, AEROX NAKED 50 2T 13-16, AEROX R 50 2T 99-00, AXIS 50 2T 95-96, BREEZE 50 2T 94-95, BW'S 50 2T 97-16, BW'S BUMP 50 2T 97-98, BW'S EASY 50 2T 13-13, BW'S NAKED 50 2T 03-04, BW'S NAKED 50 2T 09-16, BW'S NEXT GENERATION 50 2T 97-06, BW'S ORIGINAL 50 2T 99-01, BW'S ORIGINAL EURO 2 50 2T 03-03, JOG 50 2T 92-01, JOG R 50 2T 02-02, JOG R EURO2 50 2T 02-02, JOG R EURO2 50 2T 06-15, JOG R LC 50 2T 02-15, NEO'S 50 2T 97-02, NEO'S 50 2T 04-16, NEO'S EASY 50 2T 13-13, NEO'S EURO 2 50 2T 02-02, RS SPY 50 2T 95-98, SLIDER 50 2T 00-02, WHY 50 2T 98-05, WHY EURO 2 50 2T 03-05, ZEST 50 2T 95-92, ZUMA 50 2T 97-01



cod. 9923250

Variotop "TPR" Piaggio Beverly 400/500 cc

APPLICABILITÀ

APRILIA ATLANTIC 500 4T 01-04, ATLANTIC ARRECIFE 500 4T 05-08, ATLANTIC SPRINT 500 4T 05-08, SCARABEO 500 4T 03-06, SCARABEO LIGHT 500 4T 06-08

GILERA FUOCO 4T-4V IE E3 LT 500 4T 13-14, FUOCO IE EU3 500 4T 07-13, NEXUS 500 4T 03-05, NEXUS EU3 500 4T 06-08, NEXUS SP EU3 500 4T 06-07

MALAGUTI SPIDER MAX GT 500 4T 04-05, SPIDER MAX GT EU3 500 4T 06-06, SPIDER MAX RS 500 4T 08-08

PEUGEOT GEOPOLIS IE EU3 500 4T-4V 90-02, SATELIS EU3 500 4T 90-02

PIAGGIO BEVERLY 500 4T 02-06, BEVERLY CRUISER 500 4T 07-12, BEVERLY IE EU3 500 4T 06-08, MP3 LT BUSINESS ABS 500 4T 14-16, MP3 LT SPORT/BUSINESS 500 4T 11-13, MP3 RL SPORT-BUSINESS 500 4T 11-12, MP3 SPORT ABS 500 4T 14-16, X10 4T-4V IE EU3 500 4T 12-14, X9 500 4T 01-02, X9 EVOLUTION 500 4T 03-07, X9 EVOLUTION ABS 500 4T 06-07

RICAMBI

9923270	Boccola
9923280	Tasselli
9923290	Piattello portatasselli

9924530	Serie 8 masse variatore Ø 25x17 gr. 16
9924550	Serie 8 masse variatore Ø 25x17 gr. 17



◀ cod. **9923330**
Variotop "TPR" Yamaha Majesty 400 cc 2004-2008

APPLICABILITÀ

YAMAHA MAJESTY 400 4T 04-08, MAJESTY ABS 400 4T 07-08

RICAMBI

9923340	Boccola
9924610	Serie 8 masse variatore Ø 25x15 gr. 11

9924630	Serie 8 masse variatore Ø 25x15 gr. 12
---------	--



◀ cod. **9923410**
Variotop "TPR" Honda SH 125/150 cc fino al 2012

APPLICABILITÀ

HONDA @ [NES] 125 4T 00-06, BALLI 125 4T 96-01, DYLAN [SES] 125 4T 02-04, PANTHEON IE [FES] 125 4T-2V 03-05, PS I [PES] 125 4T 06-10, SH 125 4T-2V 01-04, SH IE SCOOOPY 125 4T-2V 05-12, SILVER WING [FES] 125 4T-2V 07-12, @ [NES] 150 4T 00-06, BALLI 150 4T 96-01, DYLAN [SES] 150 4T 02-04, PANTHEON IE [FES] 150 4T-2V 03-05, PS I [PES] 150 4T 06-10, SH 150 4T-2V 01-04, SH IE SCOOOPY 150 4T 05-12, SILVER WING [FES] 150 4T-2V 07-12

KEEWAY OUTLOOK 125 4T 07-08, OUTLOOK 150 4T 07-08

RICAMBI

9916650	Serie 6 masse variatore Ø 20x15 gr. 10
9916670	Serie 6 masse variatore Ø 20x15 gr. 11

9923440	Boccola
---------	---------



◀ cod. **9923460**
Variotop "TPR" Suzuki Burgman 125/150 cc

APPLICABILITÀ

SUZUKI EPICURO 125 4T 99-01, UH BURGMAN K2/K6 125 4T 02-06, UH BURGMAN K7/LO 125 4T 07-10, UX SIXTEEN K8/LO 125 4T 08-10, EPICURO 150 4T 99-01, UH BURGMAN K2/K6 150 4T 02-06, UX SIXTEEN K8/LO 150 4T 08-10

RICAMBI

9923480	Tasselli di traino
9923510	Serie 6 masse variatore Ø 20x17 gr. 10
9923520	Piattello portatasselli

9923540	Boccola
9923590	Serie 6 masse variatore Ø 20x17 gr. 9



◀ cod. **9923550**
Variotop "TPR" Yamaha Majesty 125/150/180 cc

APPLICABILITÀ

BENELLI VELVET 125 4T 99-01, VELVET 150 4T 99-01
ITALJET JUPITER 125 4T 01-02, MILLENIUM 125 4T 00-02, JUPITER 150 4T 01-02, MILLENIUM 150 4T 00-02
MALAGUTI MADISON 125 4T 99-01, MADISON R RESTYLING 125 4T 02-02, MADISON R RESTYLING EU2 125 4T 03-04, PHANTOM MAX 125 4T 03-03, MADISON T 150 4T 99-01

MBK DOODO 125 4T 00-00, SKYLINER 125 4T 98-02, SKYLINER E 125 4T 03-03, THUNDER 125 4T 01-02, DOODO 150 4T 01-02, SKYLINER 150 4T 00-02, THUNDER 150 4T 01-02, SKYLINER E 180 4T 03-03

YAMAHA MAJESTY 125 4T 98-00, MAJESTY (SNR1) 125 4T 01-01, MAJESTY (SNR8) 125 4T 02-02, MAJESTY E 125 4T 03-09, MAXSTER 125 4T 01-02, TEO'S 125 4T 00-00, MAJESTY 150 4T 00-00, MAJESTY (SN1) 150 4T 01-01, MAJESTY (SN56) 150 4T 02-02, MAXSTER 150 4T 01-02, TEO'S 150 4T 01-02, MAJESTY E 180 4T 03-06

RICAMBI

9923480	Tasselli di traino
9923510	Serie 6 masse variatore Ø 20x17 gr. 10
9923560	Boccola

9923570	Piattello portatasselli
9923590	Serie 6 masse variatore Ø 20x17 gr. 9



◀ **cod. 9923600**
Variotop "TPR" Piaggio Beverly 125 cc

APPLICABILITÀ

- APRILIA** ATLANTIC 125 4T 03-05, ATLANTIC ARRECIFE 125 4T 03-05, ATLANTIC EU3 125 4T 06-08, ATLANTIC EU3 125 4T 10-12, MOJITO 125 4T 03-08, SCARABEO 125 4T 03-06, SCARABEO EU3 125 4T 06-07, SCARABEO IE LIGHT 125 4T 09-12, SCARABEO LIGHT 125 4T 07-08, SPORT CITY 125 4T 04-06, SPORT CITY CUBE 125 4T 08-10, SPORT CITY EU3 125 4T 06-08, SPORT CITY ONE 4T EU3 125 4T 08-11, SPORT CITY STREET 125 4T 12-12, SR MAX 125 4T 11-14, SR MOTARD 125 4T-2V 12-14, MOJITO 150 4T 03-07, SCARABEO 150 4T 04-06, SCARABEO IE LIGHT 200 4T 11-12
- BENELLI** ADIVA 125 4T 01-02, ADIVA 150 4T 01-02
- DERBI** BOULEVARD 125 4T 02-04, GP1 EU2 125 4T 06-06, RAMBLA 125 4T 08-09, BOULEVARD 150 4T 02-04
- GILERA** DNA 125 4T 01-01, NEXUS EU3 125 4T 07-08, NEXUS IE EU3 125 4T 08-10, RUNNER VX 125 4T 00-06, RUNNER 180 4T 00-01, RUNNER VXR 180 4T 00-01
- ITALJET** JET SET 125 4T 01-01, TORPEDO 125 4T 99-02, JET SET 150 4T 01-01, TORPEDO 150 4T 99-02
- MALAGUTI** MADISON 3 125 4T 06-09

PIAGGIO

BEVERLY 125 4T 01-03, BEVERLY EU3 125 4T 07-08, BEVERLY EURO 3 MIC 125 4T 07-07, BEVERLY EURO 3 SPORT 125 4T 07-08, BEVERLY RST 125 4T 04-07, BEVERLY RST 4T 4V IE EU3 125 4T 10-15, BEVERLY TOURER EU3 125 4T 07-10, CARNABY 125 4T 07-10, FLY 125 4T 05-07, HEXAGON GTX 125 4T 00-00, LIBERTY 125 4T 98-02, LIBERTY RST 125 4T 04-05, MP3 125 4T 06-08, MP3 IBRIDO 125 4T 09-10, MP3 IE 125 4T 08-09, MP3 IE TOURING 125 4T 11-12, MP3 YOURBAN ERL 125 4T 11-13, SKYPYPER 4T 125 4T 00-02, SUPER HEXAGON GTX 125 4T 01-02, VESPA ET4 125 4T 96-02, VESPA GRANTURISMO 125 4T 03-07, VESPA GRANTURISMO EU3 125 4T 06-07, VESPA GTS 4T IE SUPER 125 4T 09-16, VESPA GTS EU3 125 4T 07-12, VESPA GTV 125 4T 06-08, VESPA GTV 4T NAVY EU3 125 4T 08-08, VESPA LX 125 4T 05-06, VESPA LX 4T EU3 TOURING 125 4T 10-11, VESPA LX 4T FL 125 4T 09-09, VESPA LX EU3 125 4T 06-08, VESPA LX EU3 IE 125 4T 09-11, VESPA LXV 4T EU3 125 4T 06-09, VESPA LXV IE 4T 125 4T 10-13, VESPA LXV NAVY EU3 125 4T 07-08, VESPA S 4T EU3 125 4T 07-08, VESPA S 4T IE & COLLEGE 125 4T 09-11, X-EVO 125 4T 07-16, X7 EU3 125 4T 08-08, X7 EVO IE EU3 125 4T 09-10, X8 125 4T 04-06, X8 PREMIUM EU2 125 4T 06-06, X8 PREMIUM EU3 125 4T 06-07, X9 125 4T 01-02, X9 EVOLUTION 125 4T 03-03, X9 EVOLUTION 125 4T 05-06, X9 EVOLUTION EU3 125 4T 07-07, ZIP 125 4T 00-02, FLY 150 4T 05-07, LIBERTY 150 4T 01-02, SKYPYPER 4T 150 4T 00-02, VESPA ET4 150 4T 99-02, VESPA LX 150 4T 05-06, VESPA LX 4T FL 150 4T 09-09, VESPA LX EU3 150 4T 06-08, VESPA LX EU3 IE 150 4T 09-11, VESPA LX TOURING 150 4T 10-12, VESPA S 4T 150 4T 08-09, VESPA S 4T IE & COLLEGE 150 4T 09-12, X8 STREET EU2 150 4T 06-08, SUPER HEXAGON GTX 12 180 4T 01-02, LIBERTY RST 200 4T 04-04

RENAULT

FULLTIME 125 4T 02-03

RICAMBI

9923480	Tasselli di traino
9923590	Serie 6 masse variatore Ø 20x17 gr. 9
9923620	Serie 6 masse variatore Ø 20x17 gr. 14

9923630	Piattello portatasselli
9923640	Boccola



◀ **cod. 9923650**
Variotop "TPR" Piaggio Beverly 200/250 cc

APPLICABILITÀ

- APRILIA** Atlantic 200 200 4T 03-05, Atlantic Arrecife 200 200 4T -00, Scarabeo EU3 200 200 4T 06-07, Scarabeo Light 200 200 4T 07-08, Sportcity 200 200 4T 04-06, Sportcity 200 EU3 200 4T 06-08, Atlantic 250 EU3 250 4T 06-08, Atlantic Arrecife 250 250 4T -00, Scarabeo 250 250 4T 04-06, Scarabeo Light 250 250 4T 06-08, Sportcity 250 250 4T -00, Sportcity 250 EU3 250 4T 06-08, Sportcity Cube 250 250 4T 08-12, Atlantic 300 300 4T 10-11, SR MAX 300 300 4T 11-14, Scarabeo Light 300 300 4T 09-10, Sportcity Cube 300 300 4T 08-10, Sport City Street 300 300 4T-4V 12-12
- BENELLI** Adiva 250 EU2 250 4T -00
- DERBI** Boulevard 200 EU2 200 4T 05-06, GP1 250 250 4T 06-07, Rambla 250 EU3 2VER 250 4T 08-08
- GILERA** Runner VXR 200 200 4T 02-06, Nexus 250 EU3 250 4T 06-07, Nexus 300 EU3 300 4T 08-11
- MALAGUTI** Madison R 180 180 4T 01-02, Madison S Restyling 200 200 4T 02-02, Phantom Max 200 200 4T 03-03, Madison 3 250 250 4T 06-09, Madison RS 250 250 4T 04-04, Phantom Max 250 250 4T 04-04
- PEUGEOT** Geopolis 250 IE EU3 250 4T-4V -00, Satelis 250 EU3 250 4T -00

PIAGGIO

Beverly 200 200 4T 01-03, Carnaby 200 200 4T 07-08, Liberty 200 200 4T 06-06, Liberty 200 4T Sport EU3 200 4T 06-07, Vespa GRANTURISMO 200 200 4T 03-07, Vespa GTS 200 EU3 200 4T -00, Vespa GTV 200 EU3 200 4T -00, X8 200 200 4T 04-07, X9 200 200 4T 02-03, Beverly 250 250 4T 06-07, Beverly 250 IE EU3 250 4T 06-08, Beverly RST 250 250 4T 04-05, Carnaby 250 250 4T 08-08, MP3 250 250 4T 06-08, MP3 250 LT 250 4T 08-09, MP3 250 MIC 250 4T 08-09, Vespa GT 60 250 EU3 250 4T 06-07, Vespa GTS 250 250 4T 05-16, Vespa GTS ABS 250 250 4T 05-12, Vespa GTV 250 250 4T 06-09, Vespa GTV 4T NAVY EU3 250 250 4T 07-07, X-Evo 250 250 4T 07-16, X7 250 EU3 250 4T 08-08, X8 250 EU3 250 4T 05-08, X9 Evolution 250 250 4T 04-04, X9 Evolution 250 250 4T 06-06, Beverly Tourer 300 EU3 300 4T 09-10, Carnaby Cruiser 300 300 4T 09-12, MP3 300 4T 4V IE LT Ibrido 300 4T 10-11, MP3 300 IE LT 300 4T 10-11, MP3 300 IE LT Touring 300 4T 11-13, MP3 300 IE LT/Sport 300 4T 11-14, MP3 300 IE MIC 300 4T 10-11, MP3 300 IE Touring 300 4T 11-12, MP3 300 Yourban ERL 300 4T 11-15, MP3 300 Yourban LT ERL 300 4T 11-12, Vespa GTS Super 300 4T 08-15, X7 Evo 300 IE EU3 300 4T 09-10

RICAMBI

9924450	Serie 6 masse variatore Ø 20x17 gr. 12
9923480	Tasselli di traino
9923620	Serie 6 masse variatore Ø 20x17 gr. 14

9923630	Piattello portatasselli
9923660	Boccola



◀ cod. **9923670**
Variotop "TPR" Kymco 250 cc

APPLICABILITÀ

KYMCO B&W 250 4T 00-00, GRAND DINK 250 4T 01-02, PEOPLE LC 250 4T 03-04, PEOPLE S 250 4T 06-06, PEOPLE S I 250 4T 07-07, X CITING 250 4T 05-05, X CITING I 250 4T 06-07, YUP 250 4T 03-03

RICAMBI

9923700	Serie 6 masse variatore Ø 23x18 gr. 20
9923710	Piattello portatasselli
9923720	Tasselli

9923740	Boccola
9923770	Serie 6 masse variatore Ø 23x18 gr. 18



◀ cod. **9923790**
Variotop "TPR" Suzuki AN Burgman 250 cc

APPLICABILITÀ

SUZUKI AN BURGMAN K1/K2 250 4T 01-02, AN BURGMAN K3/K6 250 4T 03-06, AN BURGMAN W/X/Y 250 4T 98-00

RICAMBI

9923720	Tasselli
9923810	Serie 6 masse variatore Ø 23x18 gr. 15
9923820	Cappellotto porta tasselli

9923830	Boccola
---------	---------



◀ cod. **9925020**
Variotop "TPR" Yamaha X-Max 125 cc

APPLICABILITÀ

MBK CITYLINER EU3 125 4T-4V 08-10, SKYCRUISER 125 4T-4V 07-07

YAMAHA X-CITY EU3 125 4T-4V 08-11, X-MAX R 125 4T-4V 06-16, X-MAX R ABS 125 4T-4V 11-11, X-MAX RA ABS 125 4T-4V 13-16

RICAMBI

9918060	Serie 8 masse variatore Ø 20x12 gr. 12
---------	--

9925270	Boccola
---------	---------



◀ cod. **9926010**
Variotop "TPR" Suzuki Burgman 400 cc K7

APPLICABILITÀ

9926010 AN Burgman 400 K7/LO 400 4T 07-10

RICAMBI

9922340	Serie 8 masse variatore Ø 26x12,9 gr. 16
9927310	Serie 8 masse variatore Ø 26x12,9 gr. 14

9923850	Serie rasamenti
9926030	Boccola



◀ cod. **9926040**
Variotop "TPR" Honda SH 300 cc

APPLICABILITÀ

HONDA SH IE SCOPY 300 4T-4V 07-19

RICAMBI

9923800	Serie 6 masse variatore Ø 23x18 gr. 15
---------	--



◀ cod. **9927130**
Variotop "TPR" Yamaha T-Max 500 cc / 530 cc / 560 cc

APPLICABILITÀ

YAMAHA T-MAX 4BS 500 4T 09-11, T-MAX 4BS ABS 500 4T 08-11, T-MAX 5GJ 500 4T 01-03, T-MAX 5VU 500 4T 04-08, T-MAX 5VU ABS 500 4T 05-07, T-MAX 5VU BLACK MAX 500 4T 06-06, T-MAX 5VU BLACK MAX - NIGHT MAX 500 4T 07-07, T-MAX 59C 530 4T 12-16, T-MAX 59C ABS 530 4T 12-16, T-MAX 59C SP 530 4T 15-15, T-MAX 59C SP ABS 530 4T 15-16

RICAMBI

9922090	Boccola
9922150	Serie masse Ø 25x15 gr.15
9922170	Serie masse Ø 25x15 gr.16

9926840	Serie rasamenti
9927140	Cappello porta tasselli
9927150	Tasselli di traino



◀ cod. **9927830**
Variotop "TPR" Kymco Agility 125 cc

APPLICABILITÀ

KYMCO AGILITY 125 4T 06-06, AGILITY R16 125 4T 08-09, AGILITY RS 125 4T 09-09, MOVIE EU3 125 4T 06-07, PEOPLE 125 4T 99-00, PEOPLE EU3 125 4T 07-08, PEOPLE S 125 4T 05-05, SUPER 8 125 4T 08-09, VIVIO 125 4T 00-00, AGILITY 150 4T 06-08, AGILITY R16 150 4T 08-09, PEOPLE 150 4T 99-00, VIVIO 150 4T 00-00, AGILITY R16 200 4T 12-12, AGILITY R16 200 4T 10-10, LIKE IE 200 4T 09-09, LIKE LX 200 4T 12-12

MALAGUTI CIAK MASTER 125 4T 04-04, CIAK MASTER 150 4T 04-04, CIAK MASTER EURO 2 200 4T 06-06

RICAMBI

9922570	Serie 6 masse variatore Ø 20x17 gr. 13,0
9923480	Tasselli di traino

9927840	Boccola
9927860	Cappello porta tasselli

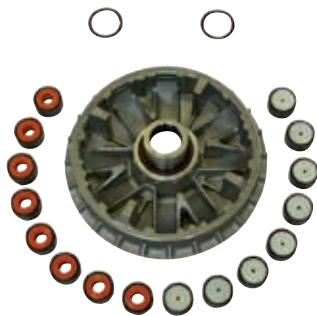

◀ cod. **9930360**
Variotop "TPR" Yamaha Majesty 400 cc X-Max 400 cc 2009

APPLICABILITÀ

YAMAHA MAJESTY 400 4T 09-11, MAJESTY ABS 400 4T 09-11, X-MAX 400 4T-4V 13-16, X-MAX ABS 400 4T-4V 14-17, X-MAX IRONMAX ABS 400 4T-4V 16-16, X-MAX MOMODESIGN 400 4T-4V 14-14, X-MAX MOMODESIGN ABS 400 4T-4V 14-14, X-MAX RA 400 4T-4V 18-18

RICAMBI

9922090	Boccola
9922170	Serie masse Ø 25x15 gr.16

9924650	Serie masse Ø 25x15 gr.13
9926840	Serie rasamenti



◀ cod. **9931790**
Variotop "TPR" Yamaha Majesty 250 cc X-Max 250 cc

APPLICABILITÀ

APRILIA LEONARDO 250 4T 99-04, LEONARDO ST 250 4T 01-01

BENELLI VELVET 250 4T 99-03

ITALJET JUPITER 250 4T 00-02

MALAGUTI MADISON S 250 4T 99-01, PASSWORD 250 4T 05-06, PASSWORD EU3 250 4T 07-08

MBK SKYLINER 250 4T 00-03, SKYLINER ABS 250 4T 03-03, KILIBRE 300 4T 03-06

YAMAHA MAJESTY 250 4T 96-03, MAJESTY ABS 250 4T 03-03, MAJESTY DX 250 4T 98-99, X-CITY 250 4T 07-15, X-MAX 250 4T 05-16, X-MAX ABS 250 4T 11-12, X-MAX ABS 250 4T 14-15, X-MAX BLACK 250 4T 09-09, X-MAX SPORT 250 4T 11-12, VERSITY 300 4T 03-06

RICAMBI

9918060	Serie Masse Ø 20X12 Gr.12
9918310	Serie Masse Ø 20X12 Gr.10
9923320	Boccola

AA00852	Tasselli Di Traino
PL04066	Piattello Porta Tasselli



◀ cod. **9932860**
Variotop "TPR" Kymco Xciting 400 cc

APPLICABILITÀ

KYMCO X CITING I 400 4T 15-15, X CITING I ABS 400 4T 14-15, XCITING I 400 4T 13-13

RICAMBI

9927140	Cappellotto porta tasselli
9927150	Tasselli di traino

9924590	SR Masse Ø 25x15 GR.10
9926840	Serie Rasamenti



◀ cod. **9934100**
Variotop "TPR" BMW C 650 Sport 2016, C 650 GT 2016

APPLICABILITÀ

BMW BMW C 650 GT 2016 [K19] 650 4T 16-16, BMW C 650 SPORT 2016 [K18] 650 4T 16-16



◀ cod. **9937600**
Variotop "TPR" Yamaha T-MAX 530 2017 / 560 2020

APPLICABILITÀ

YAMAHA XP530-A T-MAX SX 530 4T 17-19, XP530D-A T-MAX DX 530 4T 17-19, XP530E-A T-MAX 530 4T 17-18



◀ cod. **9937610**
Variotop "TPR" Kymco Agility 50 cc 4T

APPLICABILITÀ

KYMCO AGILITY 4T CARRY 50 4T 11-11, AGILITY 4T R10 50 4T 06-08, AGILITY 4T R12 50 4T 07-08, AGILITY 4T R16 PLUS EURO4 50 4T 19-19, AGILITY CARRY 4T EURO4 50 4T 19-19, AGILITY PLUS 4T 50 4T 14-14, AGILITY R12 50 4T 05-05, AGILITY R12 ECS 50 4T 16-16, AGILITY R16 50 4T 08-09, AGILITY R16 50 4T 12-12, AGILITY RS 50 4T 09-09, DINK 50 4T 50 4T 07-07, FILLY 50 4T 98-00, FILLY LX 50 4T 01-02, LIKE 50 4T 09-09, LIKE EURO4 4T 50 4T 18-18, PEOPLE S 4T 50 4T 06-08, SENTO 50 4T 08-08, SUPER 8 4T 50 4T 07-07, SUPER 8 4T 50 4T 09-09, VITALITY 4T 50 4T 04-04

MALAGUTI DVD 50 4T 10-10

SYM SYMPLY EURO 2.50 4T 07-08

NOVITÀ



spare parts



◀ cod. **CA00001**
Centralina accensione Vespa 50 PK

RIFERIMENTO ORIGINALE

Piaggio	610324M
---------	---------

APPLICABILITÀ
PIAGGIO CIAO EU1 50 2T 99-01, CIAO EU2 50 2T 02-04, CIAO MIXTEEN 50 2T 96-01, CIAO TRE 50 2T 71-99, SI 50 2T 79-88, SI FL2 50 2T 91-97, SI MIX 50 2T 96-99, VESPA PK 50 2T 82-84, VESPA PK XL 50 2T 85-88, VESPA PK XL RUSH 50 2T 88-89



◀ cod. **CA00002**
Centralina accensione Vespa PX 125-150-200; ET3-PK 125

RIFERIMENTO ORIGINALE

Piaggio	244128
---------	--------

APPLICABILITÀ
PIAGGIO APE 50 2T 09-11, APE FL - FL2 50 2T 89-95, APE FL3 EUROPA 50 2T 96-99, APE MIX 2T 50 2T 98-08, APE RST MIX 50 2T 99-03, APE TM P 50 2T 85-89, VESPA FL 50 2T 90-90, VESPA FL2 AUTOMATICA 50 2T 90-91, VESPA FL2 HP 50 2T 91-97, VESPA N 50 2T 89-90, VESPA PK AUTOMATICA 50 2T 84-89, VESPA PK XL PLURIMATIC 50 2T 85-90, VESPA SPECIAL-L-R 50 2T 67-82, COSA 2 125 2T 91-97, COSA CL, CLX 125 2T 88-91, VESPA ET3 125 2T 76-83, VESPA FL 125 2T 89-90, VESPA PK 125 2T 82-84, VESPA PK XL 125 2T 86-89, VESPA PRIMAVERA 125 2T 67-83, VESPA PX 125 2T 98-01, VESPA PX 125 2T 11-16, VESPA PX 30 ANNI 125 2T 07-08, VESPA PX E ARCOBALENO 125 2T 81-97, VESPA PX EU2 125 2T 01-07, VESPA PX T5 125 2T 85-89, COSA 2 150 2T 91-97, COSA CL, CLX 150 2T 88-91, VESPA PX 150 2T 98-01, VESPA PX 150 2T 11-16, VESPA PX E ARCOBALENO 150 2T 81-97, VESPA PX 200 2T 98-01, VESPA PX E ARCOBALENO 200 2T 81-97

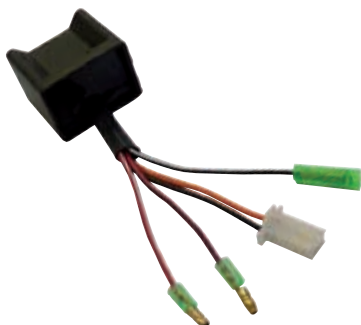

◀ cod. **CA00003**
Centralina accensione per Booster - Nitro

RIFERIMENTO ORIGINALE

Yamaha	3KJH55400000
--------	--------------

APPLICABILITÀ
MBK BOOSTER 50 2T 90-04, BOOSTER 50 2T 90-94, BOOSTER NG 50 2T 95-03, BOOSTER ROCKET 50 2T 97-98, BOOSTER SPIRIT 50 2T 96-00, BOOSTER TRACK 50 2T 96-98, FLIPPER 50 2T 98-04, FORTE 50 2T 94-96, NITRO 50 2T 97-04, OVETTO 50 2T 97-04
YAMAHA AEROX 50 2T 97-02, AEROX 50 2T 04-16, AEROX NAKED 50 2T 13-16, AEROX R 50 2T 99-00, AXIS 50 2T 95-96, BW'S 50 2T 97-04, BW'S BUMP 50 2T 97-98, BW'S NAKED 50 2T 03-03, BW'S NEXT GENERATION 50 2T 97-02, BW'S ORIGINAL 50 2T 99-01, NEO'S 50 2T 97-02, RS SPY 50 2T 95-98, SLIDER 50 2T 00-02, WHY 50 2T 98-05



◀ cod. **CA00004**
Centralina accensione per People 50 E2 2T - People S 50 2T

RIFERIMENTO ORIGINALE

Kymco	00169303
-------	----------

APPLICABILITÀ
KYMCO MXU 50 2T 06-07, MXU SR 50 2T 06-06, PEOPLE 50 2T 99-04, PEOPLE EURO 2 50 2T 03-03, PEOPLE EURO 2 50 2T 08-08, PEOPLE EURO 2 50 2T 11-11, PEOPLE S 50 2T 05-08



◀ cod. **CA00005**
Centralina accensione per Piaggio Sfera - Zip - Liberty'01 - Gilera Typhon

RIFERIMENTO ORIGINALE

Piaggio	638678
---------	--------

APPLICABILITÀ
GILERA EASY MOVING 50 2T 95-96, RUNNER 50 2T 97-00, STALKER 50 2T 97-04, STORM 50 2T 94-95, TYPHOON 50 2T 94-97, TYPHOON X 50 2T 98-99, TYPHOON XR 50 2T 00-00
PIAGGIO FREE 50 2T 92-94, FREE DELIVERY 50 2T 00-01, FREE FL 50 2T 95-02, LIBERTY 50 2T 97-05, LIBERTY 2T PTT EU2 50 2T 04-05, NRG 50 2T 94-96, NRG EXTREME LC 50 2T 99-00, NRG MC3 50 2T 01-04, NRG RST MC2 50 2T 96-98, NTT 50 2T 95-96, QUARTZ 50 2T 92-96, SFERA 50 2T 91-93, SFERA MAQUILLAGE 2 50 2T 94-94, SFERA RST 50 2T 95-97, VESPA ET2 50 2T 97-05, ZIP 50 2T 92-93, ZIP 50 2T 95-96, ZIP BIMODALE 50 2T 94-97, ZIP FAST RIDER 50 2T 93-94, ZIP FAST RIDER RST 50 2T 96-97, ZIP RST 50 2T 96-99, ZIP SP 50 2T 96-00



◀ cod. **CA00006**
Centralina accensione per Kymco Agility 4T R10/R12

RIFERIMENTO ORIGINALE

Kymco	00169187
-------	----------

APPLICABILITÀ
KYMCO AGILITY 4T CARRY 50 4T 11-11, AGILITY 4T R10 50 4T 06-08, AGILITY 4T R12 50 4T 07-08, AGILITY R12 50 4T 05-05, VITALITY 4T 50 4T 04-04



- ◀ cod. **CA00007**
Centralina accensione per Kymco Agility 4T R16

RIFERIMENTO ORIGINALE

Kymco	00130005
-------	----------

APPLICABILITÀ

KYMCO AGILITY R16 50 4T 08-09, AGILITY R16 50 4T 12-12, AGILITY RS 50 4T 09-09, LIKE 50 4T 09-09, SUPER 8 4T 50 4T 07-07, SUPER 8 4T 50 4T 09-09



- ◀ cod. **CA00008**
Centralina accensione per Piaggio Zip 50 4t '00-'05

RIFERIMENTO ORIGINALE

Piaggio	639978
---------	--------

APPLICABILITÀ

APRILIA SCARABEO 4T 50 4T 02-06, SCARABEO 4T RESTYLING EU3 50 4T 06-09
DERBI ATLANTIS 4T 50 4T 04-06

PIAGGIO FLY 4T 50 4T 05-07, FLY 4T & 25-30 KM/H 50 4T 08-11, FLY 4T 2V 50 4T 13-15, FLY 4T MOTORE CHN 50 4T 06-07, LIBERTY 4T 50 4T 00-02, LIBERTY 4T 50 4T 05-08, LIBERTY 4T DELIVERY - SINGLE 50 4T 10-14, LIBERTY 4T DELIVERY TNT 50 4T 09-09, LIBERTY 4T PTT (DEU) 50 4T 07-12, LIBERTY 4T PTT - DOUBLE - NEXIVE 50 4T 09-17, LIBERTY 4T RST 50 4T 04-04, LIBERTY 4T SPORT 50 4T 06-08, LIBERTY MOC 4T & ELLE 50 4T 09-16, VESPA ET4 50 4T 00-05, VESPA LX 4T 50 4T 05-09, ZIP 4T 50 4T 00-05



- ◀ cod. **CA00009**
Centralina Accensione Piaggio Liberty 50 cc 2T

RIFERIMENTO ORIGINALE

Piaggio	58095R
---------	--------

APPLICABILITÀ

APRILIA MOJITO CUSTOM 2T MOTORE PIAGGIO 50 2T 04-10, SCARABEO 2T EU2 MOTORE PIAGGIO 50 2T 10-12, SCARABEO 2T NET 50 2T 09-10, SCARABEO STREET 50 2T 05-06, SCARABEO STREET 2T RESTYLING 50 2T 06-09, SPORT CITY ONE 2T 50 2T 08-11, SR CARBURATORE 50 2T 14-14, SR MOTARD 50 2T 12-14, SR R 50 2T 04-09, SR R FACTORY CARBURATORE 50 2T 10-14, SR STREET CARBURATORE 50 2T 03-12
DERBI BOULEVARD 2T 50 2T 09-14, VARIANT SPORT 2T 50 2T 12-12
GILERA DNA 50 2T 00-02, DNA 50 2T 05-07, DNA GP EXPERIENCE 50 2T 03-04, ICE 50 2T 01-05, RUNNER POGGIALI 50 2T 02-02, RUNNER SP 50 2T 02-07, RUNNER SP 50 2T 10-12, RUNNER SP SPECIAL EDITION 50 2T 07-07, RUNNER SP ST & SIMONCELLI 50 2T 08-09, STALKER 50 2T 05-11, STALKER NAKED 50 2T 08-08, STALKER SPECIAL EDITION 50 2T 07-08, STORM EURO 2 50 2T 07-07

PIAGGIO DIESIS 50 2T 01-01, FLY 2T 50 2T 05-07, FLY 2T 50 2T 10-11, LIBERTY 2T 50 2T 06-08, LIBERTY 2T SPORT 50 2T 06-06, LIBERTY MOC 2T & ELLE 50 2T 09-13, NRG POWER DD 50 2T 05-17, NRG POWER DD SERIE SPECIALE 50 2T 07-12, NRG POWER DT 50 2T 06-15, NRG POWER DT SERIE SPECIALE 50 2T 07-08, TYPHOON 50 2T 01-11, TYPHOON 2T E2 50 2T 10-12, TYPHOON 2T E3 CH 50 2T 11-11, VESPA LX 2T 50 2T 05-08, VESPA LXV 2T 50 2T 06-09, VESPA LXV 2T NAVY 50 2T 08-08, VESPA S 2T & COLLEGE 50 2T 07-12, ZIP 2T 50 2T 08-13, ZIP LC 50 2T 00-04, ZIP SP 50 2T 01-04, ZIP SP EURO 2 50 2T 06-13



- ◀ cod. **CD00001**
Centralina scooter 50 cc Minarelli/Yamaha con volano giapponese 8 poli

RIFERIMENTO ORIGINALE

Ducati	434145000
--------	-----------



- ◀ cod. **CD00002**
Centralina per Minarelli AM6 con volano Ducati

RIFERIMENTO ORIGINALE

Ducati	432399010
--------	-----------



◀ cod. **IM07005**
Albero motore Vespa 50 S normale (cono 19 mm)

RIFERIMENTO ORIGINALE

PIAGGIO	1232946
---------	---------

RICAMBIO

IM07024	BIELLA
---------	--------

NOVITÀ



◀ cod. **IM07006**
Albero Motore Piaggio Vespa 50 S Anticipato (Cono 19 Mm)

APPLICABILITÀ

PIAGGIO VESPA PK 50 2T 82-84, VESPA SPECIAL-L-R 50 2T 67-82

RICAMBIO

IM07024	BIELLA
---------	--------



◀ cod. **IM07007**
Albero motore Vespa 50 PK-XL Normale (cono 20 mm)

RIFERIMENTO ORIGINALE

PIAGGIO	2245875
---------	---------

PIAGGIO	8462675
---------	---------

RICAMBIO

IM07024	BIELLA
---------	--------



◀ cod. **IM07008**
Albero motore Piaggio VESPA 50 PK-XL Anticipato (cono 20 mm)

APPLICABILITÀ

PIAGGIO APE 50 2T 09-17, APE EU4 50 2T 18-18, APE FL - FL2 50 2T 89-95, APE FL3 EUROPA 50 2T 96-99, APE MIX 2T 50 2T 98-08, APE RST MIX 50 2T 99-03, APE TM P 50 2T 85-89, VESPA FL 50 2T 90-90, VESPA N 50 2T 89-90, VESPA PK 50 2T 82-84, VESPA PK XL 50 2T 85-88, VESPA PK XL RUSH 50 2T 88-89

RICAMBIO

IM07024	BIELLA
---------	--------



◀ cod. **IM07013**
Albero motore per scooter 50 cc Minarelli/Yamaha verticale

RIFERIMENTO ORIGINALE

MBK	3VLE14001000
MBK	5WWE14000200

YAMAHA	3VLE14001000
YAMAHA	5WWE14000200

RICAMBIO

IM07032	BIELLA
---------	--------

AA00765	GABBIA
---------	--------

◀ cod. **IM07014**
Albero motore per scooter 50 cc Minarelli/Yamaha orizzontale

RIFERIMENTO ORIGINALE

Mbk	5RNE14001100
-----	--------------

Yamaha	5RNE14001100
--------	--------------

RICAMBIO

IM07032	BIELLA
---------	--------

AA00765	GABBIA
---------	--------



◀ cod. **IM07015**
Albero motore per scooter 50 cc Piaggio/Gilera

RIFERIMENTO ORIGINALE

Piaggio	4316255
Aprilia	4316255

Gilera	4316255
Derbi	4316255

RICAMBIO

IM07031	BIELLA
---------	--------

AA00777	GABBIA
---------	--------



◀ cod. **IM07016**
Albero motore per scooter 50 cc Peugeot Buxy

RIFERIMENTO ORIGINALE

Peugeot	768174
---------	--------

RICAMBIO

AA00766	GABBIA
---------	--------



◀ cod. **IM07017**
Albero motore completo per motore Minarelli AM 345/6

RICAMBI

IM07036	BIELLA
IM07033	BIELLA

AA00766	GABBIA
---------	--------



◀ cod. **IM07018**
Albero motore F12 Phantom H20 versione dal 2000

RIFERIMENTO ORIGINALE

Malaguti	77116200
----------	----------

RICAMBIO

AA00765	GABBIA
---------	--------

APPLICABILITÀ

MALAGUTI F12 PHANTOM EURO 2 50 2T 02-02, F12 PHANTOM EURO 2 2,3 50 2T 03-04, F12 PHANTOM LC EURO 2 2,3 50 2T 03-04, F12 RESTYLING EURO 1 50 2T 99-02, F12 RESTYLING EURO 2 50 2T 06-06, F12 RESTYLING LC EURO 2 50 2T 06-06

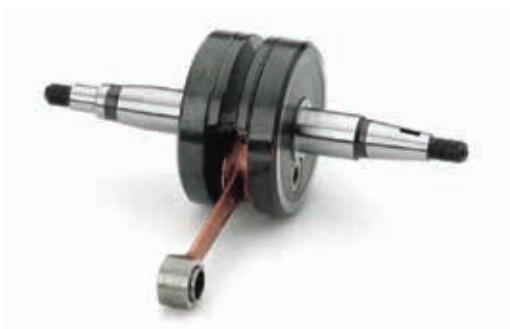

◀ cod. **IM07040**
Albero motore Derbi Senda 50 cc

RIFERIMENTO ORIGINALE

DERBI	00H02506141
-------	-------------

DERBI	00H02508141
-------	-------------

RICAMBIO

AA00766	GABBIA
---------	--------



◀ cod. **IM07044**
Albero motore per 50 cc Aprilia D. Tech 2T IE

RIFERIMENTO ORIGINALE

Aprilia	AP1BFA000699
---------	--------------



◀ cod. **IM07064**
Albero motore scooter Piaggio 50 cc Purejet

RIFERIMENTO ORIGINALE

GILERA	8269405
--------	---------

PIAGGIO	8269405
---------	---------

RICAMBIO

AA00777	GABBIA
---------	--------



◀ cod. **IM07065**
Albero motore scooter 50 cc Keeway/CPI

RIFERIMENTO ORIGINALE

Keeway	208100022000
--------	--------------

Malaguti	59012200
----------	----------

APPLICABILITÀ

BENELLI Pepe 50 2T 10-10, Pepe LX 50 2T 07-09, Pepe Old 50 2T 07-09, Pepe Old 50 2T 11-11, Quattronex 50 2T 08-11

CPI Aragon 50 2T 03-03, Hussar 50 2T 03-03, Oliver 50 2T 03-03, Pop Corn 50 2T 03-03

EXPLORER Cracker 50 2T 03-03

KEEWAY ATV 50 EC2 50 2T 06-06, ATV OFF ROAD 50 2T 07-07, F-Act 50 2T 07-08, Flash 50 2T 07-08, Focus 50 2T 06-06, Goccia 50 2T 09-09, Hurricane 50 2T 06-08, Matrix 50 2T 06-08, Pixel Euro 2 50 2T -00, RY8 50 2T 08-08

MALAGUTI F10 Wap Euro 2 50 2T -00, F12 R Phantom 50 2T 07-07

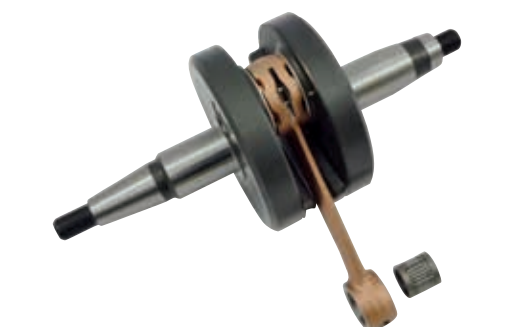

◀ cod. **IM07066**
Albero motore Derbi per Piaggio D50B0, D50B1

RIFERIMENTO ORIGINALE

APRILIA	83052R
APRILIA	847026
APRILIA	874224
DERBI	00H02590141

DERBI	83052R
DERBI	847026
DERBI	874224

RICAMBIO

AA00766	GABBIA
---------	--------

◀ **cod. IM07073**
Albero motore Piaggio 50/100 cc 4T



APPLICABILITÀ

APRILIA SCARABEO 4T 50 4T 02-06, SCARABEO 4T 4V 50 4T-4V 10-12, SCARABEO 4T 4V 50 4T-4V 14-14, SCARABEO 4T 4V NET 50 4T-4V 09-10, SCARABEO 4T RESTYLING EU3 50 4T 06-09, SCARABEO QUATTRO 50 4T-4V 09-09, SPORT CITY ONE 4T 50 4T 08-10, SR MOTARD 4T 4V 50 4T-4V 13-14

DERBI ATLANTIS 4T 50 4T 04-06, ATLANTIS 4T EU2 50 4T 07-07, BOULEVARD 4T EU2 25KM/H 50 4T 09-09

PIAGGIO

FLY 4T 50 4T 05-07, FLY 4T & 25-30 KM/H 50 4T 08-11, FLY 4T 2V 50 4T 13-15, FLY 4T 2V 25-30KM/H 50 4T 12-17, FLY 4T 4V 50 4T-4V 12-13, FLY 4T MOTORE CHN 50 4T 06-07, LIBERTY 4T 50 4T 00-02, LIBERTY 4T 50 4T 05-08, LIBERTY 4T 3V 25 KM/H 50 4T-3V 16-16, LIBERTY 4T 3V IE 50 4T-3V 15-17, LIBERTY 4T 3V IE E4 50 4T-3V 17-18, LIBERTY 4T DELIVERY - SINGLE 50 4T 10-14, LIBERTY 4T DELIVERY TNT 50 4T 09-09, LIBERTY 4T PTT (DEU) 50 4T 07-12, LIBERTY 4T PTT - DOUBLE - NEXIVE 50 4T 09-17, LIBERTY 4T RST 50 4T 04-04, LIBERTY 4T SPORT 50 4T 06-08, LIBERTY IGET 4T 3V 25KM/H 50 4T-3V 16-16, LIBERTY IGET 4T 3V IE 50 4T-3V 15-17, LIBERTY MOC 4T & ELLE 50 4T 09-16, VESPA ET4 50 4T 00-05, VESPA LX 4T 50 4T 05-09, VESPA LX 4T 4V 50 4T-4V 09-13, VESPA LX 4T 4V TOURING 50 4T-4V 10-13, VESPA PRIMAVERA 4T 2V 25KM/H 50 4T-2V 14-17, VESPA PRIMAVERA 4T 4V 50 4T-4V 13-17, VESPA S 4T 4V & COLLEGE 50 4T-4V 08-12, VESPA SPRINT 4T 2V 25KM/H 50 4T-2V 14-17, VESPA SPRINT 4T 4V 50 4T-4V 14-17, ZIP 4T 50 4T 00-13, ZIP 4T 25KM/H 50 4T 06-16

RIFERIMENTO ORIGINALE

PIAGGIO	969428
---------	--------

◀ **cod. IM07074**
Albero motore KYMCO AGILITY 50 cc 4T



APPLICABILITÀ

KYMCO AGILITY 4T CARRY 50 4T 11-11, AGILITY 4T R10 50 4T 06-08, AGILITY 4T R12 50 4T 07-08, AGILITY PLUS 4T 50 4T 14-14, AGILITY R12 50 4T 05-05, AGILITY R12 ECS 50 4T 16-16, AGILITY R16 50 4T 08-09, AGILITY R16 50 4T 12-12, AGILITY RS 50 4T 09-09, FILLY 50 4T 98-00, FILLY LX 50 4T 01-02, LIKE 50 4T 09-09, PEOPLE S 4T 50 4T 06-08, SENTO 50 4T 08-08, SUPER 8 4T 50 4T 07-07, SUPER 8 4T 50 4T 09-09, SUPER 8 4T 50 4T 13-13

RIFERIMENTO ORIGINALE

KYMCO	00101068
-------	----------

KYMCO	13000-LDCS-9000
-------	-----------------

◀ **cod. IM07058**
Albero motore completo di cuscinetti e paraoli per motori scooter 50 cc Minarelli/Yamaha tipo verticale



RICAMBIO

AA00765	GABBIA
---------	--------

◀ **cod. IM07059**
Albero motore completo di cuscinetti e paraoli per motori scooter 50 cc Minarelli/Yamaha tipo orizzontale



RICAMBIO

AA00765	GABBIA
---------	--------



◀ cod. **IM07060**
Albero motore completo di cuscinetti e paraoli per Piaggio/Gilera

RICAMBIO

AA00777	GABBIA
---------	--------



◀ cod. **IM07061**
Albero motore completo di cuscinetti e paraoli per motori scooter 50 cc Peugeot

RICAMBIO

AA00766	GABBIA
---------	--------



◀ cod. **IM07062**
Albero motore completo di cuscinetti e paraoli per AM345/ AM6

RICAMBIO

AA00766	GABBIA
IM07033	BIELLA

IM07036	BIELLA
KK01001	KIT CUSCINETTI E PARAOLI BANCO



◀ cod. **IM07063**
Albero motore completo di cuscinetti e paraoli per Derbi Senda 50 cc

RICAMBIO

AA00766	GABBIA
---------	--------

RIFERIMENTO ORIGINALE

DERBI	00H02506141
-------	-------------

DERBI	00H02508141
-------	-------------



◀ cod. **IM07050**
Albero motore per scooter Suzuki Burgman 250 cc 4T

RIFERIMENTO ORIGINALE

Suzuki	12200-14F00-000
--------	-----------------

APPLICABILITÀ

Suzuki AN Burgman 250 K3/K6 250 4T 03-06



◀ **cod. IM07045**
Albero motore per motori Minarelli YP 125

RIFERIMENTO ORIGINALE

Yamaha	5XLE14001100
Mbk	5XLE14001100

Malaguti	77118600
Benelli	R12040201A0

APPLICABILITÀ

BENELLI VELVET 125 4T 99-01
ITALJET JUPITER 125 4T 01-02, MILLENIUM 125 4T 00-02
MALAGUTI MADISON 125 4T 99-01, MADISON R RESTYLING 125 4T 02-02, MADISON R RESTYLING EU2 125 4T 03-04, PHANTOM MAX 125 4T 03-03

MBK DOODO 125 4T 00-00, SKYLINER 125 4T 98-02, SKYLINER E 125 4T 03-03, THUNDER 125 4T 01-02
YAMAHA MAJESTY 125 4T 98-00, MAJESTY (5NR1) 125 4T 01-01, MAJESTY (5NR8) 125 4T 02-02, MAJESTY E 125 4T 03-09, MAXSTER 125 4T 01-02, TEO'S 125 4T 00-00



◀ **cod. IM07052**
Albero motore per scooter Suzuki Burgman 150 cc 4T

RIFERIMENTO ORIGINALE

Suzuki	12200-49F50-000
--------	-----------------

APPLICABILITÀ

SUZUKI UH BURGMAN K2/K6 150 4T 02-06



◀ **cod. IM07054**
Albero motore per motori Minarelli YP 250

RIFERIMENTO ORIGINALE

Aprilia	AP8122470
---------	-----------

APPLICABILITÀ

APRILIA LEONARDO 250 4T 99-04, LEONARDO ST 250 4T 01-01
BENELLI VELVET 250 4T 99-03
ITALJET JUPITER 250 4T 00-02
MALAGUTI MADISON S 250 4T 99-01, PASSWORD 250 4T 05-06, PASSWORD EU3 250 4T 07-08

MBK SKYLINER 250 4T 00-03, SKYLINER ABS 250 4T 03-03
YAMAHA MAJESTY 250 4T 96-03, MAJESTY ABS 250 4T 03-03, MAJESTY DX 250 4T 98-99, X-CITY 250 4T 07-15, X-MAX 250 4T 05-16, X-MAX ABS 250 4T 14-15

RICAMBI

IM07037	BIELLA
---------	--------



◀ **cod. IM07055**
Albero motore Honda SH 125 cc 4T (fino al 2012)

RIFERIMENTO ORIGINALE

Honda	13000KGF910
-------	-------------

APPLICABILITÀ

HONDA @ [NES] 125 4T 00-06, DYLAN [SES] 125 4T 02-04, PANTHEON IE [FES] 125 4T-2V 03-05, PS I [PES] 125 4T 06-10, SH 125 4T-2V 01-04, SH IE SCOOPY 125 4T-2V 05-12, SILVER WING [FES] 125 4T-2V 07-12



◀ **cod. IM07056**
Albero motore Honda SH 150 cc 4T (fino al 2012)

RIFERIMENTO ORIGINALE

Honda	13000KGG910
-------	-------------

APPLICABILITÀ

HONDA @ [NES] 150 4T 00-06, DYLAN [SES] 150 4T 02-04, PANTHEON IE [FES] 150 4T-2V 03-05, PS I [PES] 150 4T 06-10, SH 150 4T-2V 01-04, SH IE SCOOPY 150 4T 05-12, SILVER WING [FES] 150 4T-2V 07-12



◀ cod. **IM07057**
Albero motore Kymco 250 cc

RIFERIMENTO ORIGINALE

Kymco	00123900
-------	----------

APPLICABILITÀ

KYMCO B&W 250 4T 00-00, B&W EU2 250 4T 03-03, GRAND DINK 250 4T 01-02, GRAND DINK EU2 250 4T 03-04, PEOPLE LC 250 4T 03-04, PEOPLE S 250 4T 06-06, PEOPLE S I 250 4T 07-07, X CITING 250 4T 05-05, X CITING I 250 4T 06-07, YUP 250 4T 03-03



◀ cod. **IM07067**
Albero motore Piaggio Vespa 125 ET3

APPLICABILITÀ

PIAGGIO VESPA ET3 125 2T 76-83, VESPA PRIMAVERA 125 2T 67-83

RIFERIMENTO ORIGINALE

PIAGGIO	1232966
---------	---------



◀ cod. **IM07068**
Albero motore Piaggio Vespa 125 PX

APPLICABILITÀ

PIAGGIO VESPA PX 125 2T 98-01, VESPA PX 125 2T 11-16, VESPA PX 30 ANNI 125 2T 07-08, VESPA PX E ARCOBALENO 125 2T 81-97, VESPA PX EU2 125 2T 01-07, VESPA PX 150 2T 98-01, VESPA PX 150 2T 11-16, VESPA PX E ARCOBALENO 150 2T 81-97

RIFERIMENTO ORIGINALE

PIAGGIO	1331545
---------	---------



◀ cod. **IM07069**
Albero Motore Sym Symphony 125 cc

APPLICABILITÀ

SYM FIDDLE II 125 4T 10-10, JET 4 125 4T 09-10, SYMPHONY 125 4T 09-09, SYMPHONY S 125 4T 09-10, SYMPHONY SR 125 4T 10-10

RIFERIMENTO ORIGINALE

Sym	13000ARA000
-----	-------------



◀ cod. **IM07071**
Albero Motore Kymco Agility 125 cc

APPLICABILITÀ

KYMCO AGILITY 125 4T 06-06, AGILITY CARRY 125 4T 11-11, AGILITY EU3 125 4T 06-08, AGILITY PLUS 125 4T 14-14, AGILITY PLUS E4 125 4T 16-16, AGILITY R16 125 4T 08-09, AGILITY RS 125 4T 09-09, LIKE 125 4T 09-09, LIKE LX 125 4T 12-12, MOVIE 125 4T 99-00, MOVIE EU3 125 4T 06-07, MOVIE XL 125 4T 01-01, MOVIE XL EU2 125 4T 03-04, PEOPLE 125 4T 99-00, PEOPLE EU2 125 4T 03-03, PEOPLE EU3 125 4T 07-08, PEOPLE EU3 125 4T 11-11, PEOPLE ONE E4 125 4T 16-16, PEOPLE ONE I 125 4T 13-13, PEOPLE ONE I DD 125 4T 15-15, PEOPLE S 125 4T 05-05, PEOPLE S DD EU3 125 4T 07-08, SUPER 8 125 4T 08-09, VIVIO 125 4T 00-00, AGILITY R16 150 4T 08-09, MOVIE XL 150 4T 01-01, MOVIE XL EU2 150 4T 03-04, PEOPLE 150 4T 99-00, PEOPLE EU2 150 4T 03-03, VIVIO 150 4T 00-00

RIFERIMENTO ORIGINALE

Kymco	123127
-------	--------



◀ cod. **IM07072**
Albero Motore Yamaha X-Max 125 cc

APPLICABILITÀ

MBK CITYLINER EU3 125 4T-4V 08-10, SKYCRUISER 125 4T-4V 07-07

YAMAHA

X-CITY EU3 125 4T-4V 08-11, X-MAX R 125 4T-4V 06-16, X-MAX R ABS 125 4T-4V 11-11, X-MAX RA ABS 125 4T-4V 13-16

RIFERIMENTO ORIGINALE

Yamaha	39DE14003000
--------	--------------



◀ cod. **IM070701**
Albero Motore Piaggio Liberty 125cc (sel.1)

APPLICABILITÀ

APRILIA ATLANTIC EU3 125 4T 06-08, ATLANTIC EU3 125 4T 10-12, MOJITO 125 4T 03-08, SCARABEO EU3 125 4T 06-07, SPORT CITY CUBE 125 4T 08-10, SPORT CITY EU3 125 4T 06-08, SPORT CITY ONE 4T EU3 125 4T 08-11

DERBI BOULEVARD 4T EU3 125 4T 08-12, BOULEVARD EU2 125 4T 04-07, GP1 EU 2 125 4T 06-06, GP1 LOW SEAT EU3 125 4T 07-08, RAMBLA 125 4T 08-09, RAMBLA EU3 2VER 125 4T 08-08, SONAR 4T 125 4T 09-11, VARIANT SPORT 4T EU3 125 4T 12-12, BOULEVARD 4T E3 150 4T 10-10, BOULEVARD EU3 150 4T 04-07, SONAR 4T 150 4T 09-09

GILERA NEXUS EU3 125 4T 07-08, RUNNER VX 125 4T 02-06, RUNNER VX 4T EU3 125 4T 06-07, RUNNER VX RACE 125 4T 06-06, RUNNER VX SC 125 4T 06-07

PIAGGIO BEVERLY 125 4T 01-03, BEVERLY EU3 125 4T 07-08, BEVERLY RST 125 4T 05-07, BEVERLY TOURER EU3 125 4T 07-10, CARNABY 125 4T 07-10, FLY 125 4T 05-07, FLY EU3 125 4T 07-11, HEXAGON GTX 125 4T 00-00, LIBERTY 125 4T 01-02, LIBERTY 4T 125 4T 06-07, LIBERTY 4T EU3 125 4T 06-08, LIBERTY 4T EU3 DELIVERY - TNT 125 4T 08-15, LIBERTY 4T SPORT EU3 125 4T 06-08, LIBERTY RST PTT 125 4T 05-11, LIBERTY SPORT 125 4T 06-06, MP3 125 4T 06-08, SKYPPER 4T 125 4T 00-02, TYPHOON 4T 2V E3 125 4T 10-11, VESPA ET4 125 4T 99-02, VESPA GRANTURISMO 125 4T 03-07, VESPA GRANTURISMO

EU3 125 4T 06-07, VESPA GTS EU3 125 4T 07-12, VESPA GTV 125 4T 06-08, VESPA GTV 4T NAVY EU3 125 4T 08-08, VESPA LX 125 4T 05-06, VESPA LX 4T EU3 TOURING 125 4T 10-11, VESPA LX 4T FL 125 4T 09-09, VESPA LX EU3 125 4T 06-08, VESPA LX EU3 IE 125 4T 09-11, VESPA LXV 4T EU3 125 4T 06-09, VESPA LXV IE 4T 125 4T 10-13, VESPA LXV NAVY EU3 125 4T 07-08, VESPA S 4T EU3 125 4T 07-08, VESPA S 4T IE & COLLEGE 125 4T 09-11, X-EVO 125 4T 07-16, X7 EU3 125 4T 08-08, X8 125 4T 04-06, X8 PREMIUM EU2 125 4T 06-06, X8 PREMIUM EU3 125 4T 06-07, X8 STREET EU2 125 4T 06-07, X9 125 4T 01-02, X9 EVOLUTION 125 4T 03-03, X9 EVOLUTION 125 4T 05-06, X9 EVOLUTION EU3 125 4T 07-07, ZIP 125 4T 00-02, FLY 150 4T 05-07, FLY EU3 150 4T 08-11, LIBERTY 150 4T 01-02, LIBERTY 4T EU3 150 4T 08-08, LIBERTY 4T SPORT EU3 150 4T 08-08, LIBERTY MOC 4T 150 4T 09-13, VESPA LX 150 4T 05-06, VESPA LX 4T FL 150 4T 09-09, VESPA LX EU3 150 4T 06-08, VESPA LX EU3 IE 150 4T 09-11, VESPA LX TOURING 150 4T 10-12, VESPA S 4T 150 4T 08-09, VESPA S 4T IE & COLLEGE 150 4T 09-12, X8 STREET EU2 150 4T 06-08

RIFERIMENTO ORIGINALE

PIAGGIO	8412985001
---------	------------



◀ cod. **IM070702**
Albero Motore Piaggio Liberty 125 cc (sel.2)

APPLICABILITÀ

APRILIA ATLANTIC EU3 125 4T 06-08, ATLANTIC EU3 125 4T 10-12, MOJITO 125 4T 03-08, SCARABEO EU3 125 4T 06-07, SPORT CITY CUBE 125 4T 08-10, SPORT CITY EU3 125 4T 06-08, SPORT CITY ONE 4T EU3 125 4T 08-11

DERBI BOULEVARD 4T EU3 125 4T 08-12, BOULEVARD EU2 125 4T 04-07, GP1 EU 2 125 4T 06-06, GP1 LOW SEAT EU3 125 4T 07-08, RAMBLA 125 4T 08-09, RAMBLA EU3 2VER 125 4T 08-08, SONAR 4T 125 4T 09-11, BOULEVARD 4T E3 150 4T 10-10, BOULEVARD EU3 150 4T 04-07, SONAR 4T 150 4T 09-09

GILERA NEXUS EU3 125 4T 07-08, RUNNER VX 125 4T 02-06, RUNNER VX 4T EU3 125 4T 06-07, RUNNER VX RACE 125 4T 06-06, RUNNER VX SC 125 4T 06-07

PIAGGIO BEVERLY 125 4T 01-03, BEVERLY EU3 125 4T 07-08, BEVERLY RST 125 4T 05-07, BEVERLY TOURER EU3 125 4T 07-10, CARNABY 125 4T 07-10, FLY 125 4T 05-07, FLY EU3 125 4T 07-11, HEXAGON GTX 125 4T 00-00, LIBERTY 125 4T 01-02, LIBERTY 4T 125 4T 06-07, LIBERTY 4T EU3 125 4T 06-08, LIBERTY 4T EU3 DELIVERY - TNT 125 4T 08-15, LIBERTY 4T SPORT EU3 125 4T 06-08, LIBERTY RST PTT 125 4T 05-11, LIBERTY SPORT 125 4T 06-06, MP3 125 4T 06-08, SKYPPER 4T 125 4T 00-02, TYPHOON 4T 2V E3 125 4T 10-11, VESPA ET4 125 4T 99-02, VESPA GRANTURISMO

125 4T 03-07, VESPA GRANTURISMO EU3 125 4T 06-07, VESPA GTS EU3 125 4T 07-12, VESPA GTV 125 4T 06-08, VESPA GTV 4T NAVY EU3 125 4T 08-08, VESPA LX 125 4T 05-06, VESPA LX 4T EU3 TOURING 125 4T 10-11, VESPA LX 4T FL 125 4T 09-09, VESPA LX EU3 125 4T 06-08, VESPA LX EU3 IE 125 4T 09-11, VESPA LXV 4T EU3 125 4T 06-09, VESPA LXV IE 4T 125 4T 10-13, VESPA LXV NAVY EU3 125 4T 07-08, VESPA S 4T EU3 125 4T 07-08, VESPA S 4T IE & COLLEGE 125 4T 09-11, X-EVO 125 4T 07-16, X7 EU3 125 4T 08-08, X8 125 4T 04-06, X8 PREMIUM EU2 125 4T 06-06, X8 PREMIUM EU3 125 4T 06-07, X8 STREET EU2 125 4T 06-07, X9 125 4T 01-02, X9 EVOLUTION 125 4T 03-03, X9 EVOLUTION 125 4T 05-06, X9 EVOLUTION EU3 125 4T 07-07, ZIP 125 4T 00-02, FLY 150 4T 05-07, FLY EU3 150 4T 08-11, LIBERTY 150 4T 01-02, LIBERTY 4T EU3 150 4T 08-08, LIBERTY 4T SPORT EU3 150 4T 08-08, LIBERTY MOC 4T 150 4T 09-13, VESPA LX 150 4T 05-06, VESPA LX 4T FL 150 4T 09-09, VESPA LX EU3 150 4T 06-08, VESPA LX EU3 IE 150 4T 09-11, VESPA LX TOURING 150 4T 10-12, VESPA S 4T 150 4T 08-09, VESPA S 4T IE & COLLEGE 150 4T 09-12, X8 STREET EU2 150 4T 06-08

RIFERIMENTO ORIGINALE

PIAGGIO	8412985002
---------	------------



◀ **cod. 12481N**
Mitsubishi IR/IF
35 Amp/12 Volt, Splined Shaft

MAKE / MODEL	YEAR
Kawasaki ZG1200 Voyager XII	1986-2003
Kawasaki ZR1100	1992-1995



◀ **cod. 12494N**
Bosch IR
50 Amp/12 Volt, w/o Pulley

MAKE / MODEL	YEAR
BMW K1100LT	1992-1999
BMW K1100LT High Line	1997
BMW K1100LT Special Edition	1997
BMW K1100RS	1992-1996
BMW K1100RS SE	1996
BMW K75	1988-1995
BMW K75C	1985-1990
BMW K75RT	1990-1995
BMW K75RT ABS	1991-1995
BMW K75S	1986-1995
BMW K75S ABS	1991-1995
BMW R1100GS	1994-2006
BMW R1100GS ABS	1995-1999
BMW R1100GS SE	1999
BMW R1100R	1994-2000
BMW R1100R SE	1999
BMW R1100RL	2001
BMW R1100RS	1992-2001
BMW R1100RS ABS	1994-2001
BMW R1100RSL	1994-1996
BMW R1100RT	1994-2001
BMW R1100RT SE	2000
BMW R1100RTL	1996-1997
BMW R1100S	1998-2005
BMW R1150GS	1999-2004
BMW R1150GS Adventure	2001-2005
BMW R1150R	2001-2006
BMW R1150R Roadster	2002-2006
BMW R1150RS	2000-2004
BMW R1150RT	2000-2005
BMW R1200C	1998-2004
BMW R1200C Avantgarde	2000-2003
BMW R1200C Classic	1996-2004
BMW R1200C Euro	1998-2002
BMW R1200C Independent	2000-2004
BMW R1200C Montana	2000-2003
BMW R1200C Phoenix	2000-2002
BMW R1200C Stiletto	2001
BMW R850C Classic	1998-2000
BMW R850R	1995-2001
BMW R850R ABS	1996
BMW R850R Special Edition	1997
BMW R850RT	2002-2006



◀ cod. **AM00001**
Albero primario nudo per AM6 1° serie



◀ cod. **AM00002**
Albero secondario nudo per AM6 1° serie



◀ cod. **AM00003**
Albero selettore per AM6



◀ cod. **AM00004**
Raccordo entrata pompa acqua per AM6



◀ cod. **AM00005**
Tappo alimentazione olio per AM6



◀ cod. **AM00006**
Ingranaggio 2a velocità su primario Z=16 per AM6 1° serie



◀ cod. **AM00007**
Ingranaggio 3a-4a velocità su primario Z=19-22 adat. AM6 1° serie



◀ cod. **AM00008**
Ingranaggio 5a velocità su primario Z=24 per AM6 1° serie



◀ cod. **AM00009**
Ingranaggio 6a velocità su primario Z=25 per AM6 1° serie



◀ cod. **AM00010**
Ingranaggio 1a velocità su secondario Z=36 per AM6 1° serie



◀ cod. **AM00011**
Ingranaggio 2a velocità su secondario Z=33 per AM6 1° serie



◀ cod. **AM00012**
Ingranaggio 3a velocità su secondario Z=29 per AM6 1° serie



◀ cod. **AM00013**
Ingranaggio 4a velocità su secondario Z=27 per AM6 1° serie



◀ cod. **AM00014**
Ingranaggio 5a velocità su secondario Z=25 per AM6 1° serie



◀ cod. **AM00015**
Ingranaggio 6a velocità su secondario Z=24 per AM6 1° serie



◀ cod. **AM00016**
Ingranaggio doppio intermedio Z=13-24 per AM6 1° serie



◀ cod. **AM00017**
Leva frizione completa per AM



◀ cod. **AM00018**
Chiavetta per pignone motore AM



◀ cod. **AM00019**
Chiavetta per volano motore AM



◀ cod. **AM00020**
Astuccio a rulli DB 14-12



◀ cod. **AM00021**
OR 11,8x2,4



◀ cod. **AM00022**
Guarnizioni coperchio frizione per AM



◀ cod. **AM00023**
Guarnizioni corpo pompa acqua per AM



◀ cod. **AM00024**
Paraolio 10x18x8



◀ cod. **AM00025**
Girante con perno per pompa acqua AM



◀ cod. **AM00026**
Interruttore spia folle per AM

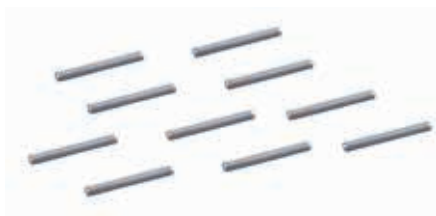

◀ cod. **AM00027**
Rullo per ingranaggio condotto pompa per AM



◀ cod. **AM00028**
Rullo riferimento corpo pompa per AM



◀ cod. **AM00030**
Albero messa in moto completo AM6

APPLICABILITÀ

APRILIA CLASSIC 50 2T 92-99, EUROPA 50 2T 90-92, MX 50 2T 04-04, MX MOTARD 50 2T 95-03, PEGASO 50 2T 92-94, RS 50 2T 91-05, RX 50 2T 89-04, RX 3-5 MARCE 50 2T 91-94, RX ENDURO 50 2T 95-03, RX RACING 50 2T 03-06, TUONO 50 2T 03-04

BETA RR 2T 50 EU4 50 2T 18-20, RR 50 RACING EU4 50 2T 18-20, RR ALU 50 2T 08-12, RR ENDURO 50 2T 06-17, RR MOTARD 50 2T 06-17

CH HUSQVARNA SM 50 2T 00-10, WR 50 2T 00-10, WSM 50 2T 00-10

CMC ENDURO 50 2T 11-11, MOTARD 50 2T 11-11

FANTIC CABALLERO MOTARD 50 2T 06-10, CABALLERO REGOLARITÀ 50 2T 06-10, ENDURO COMPETITION EU4 50 2T 18-20, ENDURO PERFORMANCE EU4 50 2T 18-20, MOTARD COMPETITION EU4 50 2T 18-20, MOTARD PERFORMANCE EU4 50 2T 18-20

HM BAJA, DERAPAGE BASIC 50 2T 10-11, CMC 50 2T 10-11, CRE BAJA RR, DERAPAGE RR 50 2T 07-11, CRE BAJA, DERAPAGE 50 2T 07-11, CRE SIX COMPETITION 50 2T 10-11, CRE SIX, BAJA, DERAPAGE 50 2T 95-06, CRE SIX, DERAPAGE COMPETITION 50 2T 07-09, DERAPAGE COMPETITION 50 2T 10-11

MALAGUTI CNK DRAGON 50 2T 05-07, FIFTY EVOLUTION 50 2T 90-93, XSM 50 2T 03-03, XTM 50 2T 03-03

MBK X LIMIT 50 2T 03-04, X POWER 50 2T 03-04

MINARELLI MOTORE AM 3-4-5 50 2T 91-95, MOTORE AM 6 1° SERIE 50 2T 96-11, MOTORE AM 6 2° SERIE 50 2T 12-18

MOTORHISPANIA FURIA 50 2T 97-00, FURIA MAX 50 2T 10-12, RX 50 2T 09-12, RX R 50 2T 09-12

PEUGEOT SUPERMOTARD 50 2T 90-02, XP6 TRAIL S/AVV. ELETTRICO 50 2T 90-02, XR6 RACING CAT. C/AVV.ELETT. 50 2T 90-02

RIEJU MRT 50 2T 09-12, MRT 50 EU4 50 2T 18-20, MRT PRO 50 2T 09-12, MRT PRO EU4 50 2T 18-20, MRT PRO REPLICA EU4 50 2T 18-20, MRT PRO REPLICA SM EU4 50 2T 18-20, MRT PRO SM 50 2T 09-12, MRT PRO SM EU4 50 2T 18-20, MRT SM 50 2T 09-12, MRT SM EU4 50 2T 18-20, MRT TROPHY EU4 50 2T 18-20, MRX 50 2T 01-04, MRX PRO 50 2T 01-04, RR 50 2T 05-06, RS1 50 2T 98-01, RS2 MATRIX 50 2T 05-06, RS2 MATRIX PRO 50 2T 05-06, RS2 NAKED 50 2T 04-05, RS3 EU4 50 2T 18-20, RS3 NKD EU4 50 2T 18-20, SMX E.S./K.S. 50 2T 01-01, SMX PRO E.S./K.S. 50 2T 03-03, SPIKE 50 2T 98-01

SHERCO FACTORY SE-R EU4 50 2T 18-20, FACTORY SE-RS EU4 50 2T 18-20, FACTORY SILVER SM-R EU4 50 2T 18-20, FACTORY SILVER SM-RS EU4 50 2T 18-20, FACTORY SM-R EU4 50 2T 18-20, FACTORY SM-RS EU4 50 2T 18-20, HRD ENDURO 50 2T 09-13, HRD MOTARD 50 2T 09-13

VENT BAJA 50 2T 18-20, BAJA RR 50 2T 18-20, DERAPAGE 50 2T 18-20, DERAPAGE RR 50 2T 18-20

YAMAHA DT R 50 2T 03-11, DT RSM 50 2T 03-05, DT X 50 2T 06-11, TZR 50 2T 03-08, TZR 50 2T 10-11, TZR RR 50 2T 05-05



◀ cod. **AM00031**
Cambio completo AM6 seconda serie

APPLICABILITÀ

MINARELLI MOTORE AM 6 2° SERIE 50 2T 12-18

VENT BAJA 50 2T 18-20, BAJA RR 50 2T 18-20, DERAPAGE 50 2T 18-20, DERAPAGE RR 50 2T 18-20

RICAMBI

AM00032	Albero primario z=12 AM6 2° serie
AM00033	Ingran. 5° marcia su primario z=24 AM6 2a serie
AM00034	Ingran. 3°- 4° marcia su prim. Z=19-22 AM6 2° serie
AM00035	Ingran. 6° marcia su primario z=25 AM6 2° serie
AM00036	Ingran. 2° marcia su primario z=16 AM6 2° serie
AM00037	Albero secondario AM6 2° serie
AM00038	Ingran. 1° marcia su secondario z=36 AM6 2° serie

AM00039	Ingran. 5° marcia su secondario z=25 AM6 2° serie
AM00040	Ingran. 4° marcia su secondario z=27 AM6 2° serie
AM00041	Ingran. 3° marcia su secondario z=29 AM6 2° serie
AM00042	Ingran. 6° marcia su secondario z=24 AM6 2° serie
AM00043	Ingran. 2° marcia su secondario z=33 AM6 2° serie
AM00044	Kit rasamenti e seeger cambio AM6 2° serie



◀ cod. **AM00032**
Albero primario z=12 AM6 seconda serie

APPLICABILITÀ

MINARELLI MOTORE AM 6 2° SERIE 50 2T 12-18

VENT BAJA 50 2T 18-20, BAJA RR 50 2T 18-20, DERAPAGE 50 2T 18-20, DERAPAGE RR 50 2T 18-20

A RICAMBIO PER

AM00031	Cambio completo AM6 2° serie
---------	------------------------------



◀ **cod. AM00033**
Ingran. 5ª marcia su primario z=24 AM6 seconda serie

APPLICABILITÀ

MINARELLI MOTORE AM 6 2° SERIE 50 2T 12-18

VENT

BAJA 50 2T 18-20, BAJA RR 50 2T 18-20, DERAPAGE 50 2T 18-20, DERAPAGE RR 50 2T 18-20

A RICAMBIO PER

AM00031	Cambio completo AM6 2ª serie
---------	------------------------------



◀ **cod. AM00034**
Ingran. 3ª-4ª marcia su primario z=19-22 AM6 seconda serie

APPLICABILITÀ

MINARELLI MOTORE AM 6 2° SERIE 50 2T 12-18

VENT

BAJA 50 2T 18-20, BAJA RR 50 2T 18-20, DERAPAGE 50 2T 18-20, DERAPAGE RR 50 2T 18-20

A RICAMBIO PER

AM00031	Cambio completo AM6 2ª serie
---------	------------------------------



◀ **cod. AM00035**
Ingran. 6ª marcia su primario z=25 AM6 seconda serie

APPLICABILITÀ

MINARELLI MOTORE AM 6 2° SERIE 50 2T 12-18

VENT

BAJA 50 2T 18-20, BAJA RR 50 2T 18-20, DERAPAGE 50 2T 18-20, DERAPAGE RR 50 2T 18-20

A RICAMBIO PER

AM00031	Cambio completo AM6 2ª serie
---------	------------------------------



◀ **cod. AM00036**
Ingran. 2ª marcia su primario z=16 AM6 seconda serie

APPLICABILITÀ

MINARELLI MOTORE AM 6 2° SERIE 50 2T 12-18

VENT

BAJA 50 2T 18-20, BAJA RR 50 2T 18-20, DERAPAGE 50 2T 18-20, DERAPAGE RR 50 2T 18-20

A RICAMBIO PER

AM00031	Cambio completo AM6 2ª serie
---------	------------------------------



◀ **cod. AM00037**
Albero secondario am6 seconda serie

APPLICABILITÀ

MINARELLI MOTORE AM 6 2° SERIE 50 2T 12-18

VENT

BAJA 50 2T 18-20, BAJA RR 50 2T 18-20, DERAPAGE 50 2T 18-20, DERAPAGE RR 50 2T 18-20

A RICAMBIO PER

AM00031	Cambio completo AM6 2ª serie
---------	------------------------------



◀ **cod. AM00038**
Ingran. 1ª marcia su secondario z=36 AM6 2ª serie

APPLICABILITÀ

MINARELLI MOTORE AM 6 2° SERIE 50 2T 12-18

VENT

BAJA 50 2T 18-20, BAJA RR 50 2T 18-20, DERAPAGE 50 2T 18-20, DERAPAGE RR 50 2T 18-20

A RICAMBIO PER

AM00031	Cambio completo AM6 2ª serie
---------	------------------------------



◀ cod. **AM00039**
Ingran. 5ª marcia su secondario z=25 AM6 2ª serie

APPLICABILITÀ

MINARELLI MOTORE AM 6 2° SERIE 50 2T 12-18

VENT

BAJA 50 2T 18-20, BAJA RR 50 2T 18-20, DERAPAGE 50 2T 18-20, DERAPAGE RR 50 2T 18-20

A RICAMBIO PER

AM00031	Cambio completo AM6 2ª serie
---------	------------------------------



◀ cod. **AM00040**
Ingran. 4ª marcia su secondario z=27 AM6 2ª serie

APPLICABILITÀ

MINARELLI MOTORE AM 6 2° SERIE 50 2T 12-18

VENT

BAJA 50 2T 18-20, BAJA RR 50 2T 18-20, DERAPAGE 50 2T 18-20, DERAPAGE RR 50 2T 18-20

A RICAMBIO PER

AM00031	Cambio completo AM6 2ª serie
---------	------------------------------



◀ cod. **AM00041**
Ingran. 4ª marcia su secondario z=27 AM6 2ª serie

APPLICABILITÀ

MINARELLI MOTORE AM 6 2° SERIE 50 2T 12-18

VENT

BAJA 50 2T 18-20, BAJA RR 50 2T 18-20, DERAPAGE 50 2T 18-20, DERAPAGE RR 50 2T 18-20

A RICAMBIO PER

AM00031	Cambio completo AM6 2ª serie
---------	------------------------------



◀ cod. **AM00042**
Ingran. 6ª marcia su secondario z=24 AM6 seconda serie

APPLICABILITÀ

MINARELLI MOTORE AM 6 2° SERIE 50 2T 12-18

VENT

BAJA 50 2T 18-20, BAJA RR 50 2T 18-20, DERAPAGE 50 2T 18-20, DERAPAGE RR 50 2T 18-20

A RICAMBIO PER

AM00031	Cambio completo AM6 2ª serie
---------	------------------------------



◀ cod. **AM00043**
Ingran. 2ª marcia su secondario z=33 AM6 seconda serie

APPLICABILITÀ

MINARELLI MOTORE AM 6 2° SERIE 50 2T 12-18

VENT

BAJA 50 2T 18-20, BAJA RR 50 2T 18-20, DERAPAGE 50 2T 18-20, DERAPAGE RR 50 2T 18-20

A RICAMBIO PER

AM00031	Cambio completo AM6 2ª serie
---------	------------------------------



◀ cod. **AM00044**
Kit rasamenti e seeger cambio AM6 seconda serie

APPLICABILITÀ

MINARELLI MOTORE AM 6 2° SERIE 50 2T 12-18

VENT

BAJA 50 2T 18-20, BAJA RR 50 2T 18-20, DERAPAGE 50 2T 18-20, DERAPAGE RR 50 2T 18-20

A RICAMBIO PER

AM00031	Cambio completo AM6 2ª serie
---------	------------------------------

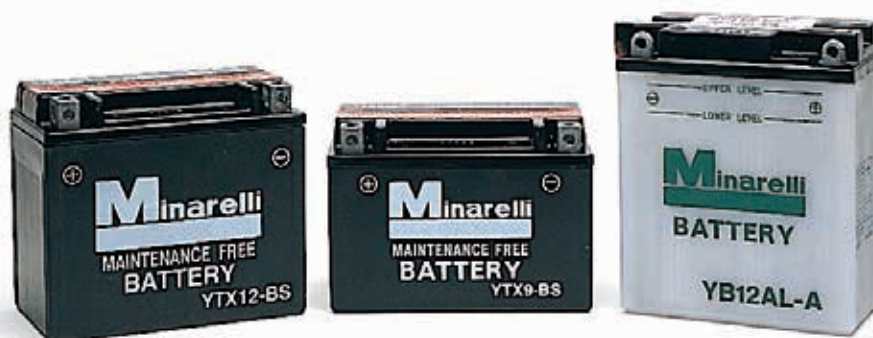
MINARELLI

Codice Reference	Sigla Sygn	Ah	Spunto-CCA (-18°C) A	Tipo Type	Poli Poles	Lunghezza Length	Larghezza Width	Altezza Height
0012180	YB4L-B	4	50	Convenzionale / Conventional	[- +]	120	70	92
0012240	YB5L-B	5	55	Convenzionale / Conventional	[- +]	120	60	130
0012260	YB10L-A2	11	160	Convenzionale / Conventional	[- +]	134	90	146
0012310	YTX4L-BS	3	40	Senza Manutenzione / Maintenance Free	[- +]	112	71	86
0012320	YTX12-BS	10	150	Senza Manutenzione / Maintenance Free	[+ -]	150	87	130
0012330	YTX9-BS	8	120	Senza Manutenzione / Maintenance Free	[+ -]	150	87	105
0012340	YB12AL-A	12	165	Convenzionale / Conventional	[- +]	133	80	160
0012350	YTX7A-BS	6	85	Senza Manutenzione / Maintenance Free	[+ -]	150	87	96
0012380	YTX5L-BS	4	60	Senza Manutenzione / Maintenance Free	[- +]	112	70	105
0012390	YTX14-BS	12	200	Senza Manutenzione / Maintenance Free	[+ -]	150	87	147
0012420	YB7L-B2	8	90	Convenzionale / Conventional	[- +]	136	76	132
0012430	YTX7L-BS	6	85	Senza Manutenzione / Maintenance Free	[- +]	112	70	128
0012470	YT12A-BS	10	140	Senza Manutenzione / Maintenance Free	[+ -]	150	87	106
0012480	YB10L-B	11	160	Convenzionale / Conventional	[- +]	134	90	145
0012500	YTZ7S-BS	6	100	Senza Manutenzione / Maintenance Free	[- +]	114	70	105
0012510	YTZ12S-BS	11	210	Senza Manutenzione / Maintenance Free	[+ -]	150	87	110
0012520	YT7B-BS	6	85	Senza Manutenzione / Maintenance Free	[+ -]	150	65	95
0012530	YT9B-BS	8	115	Senza Manutenzione / Maintenance Free	[+ -]	150	70	105
0012540	YTZ10S-BS	8,6	190	Senza Manutenzione / Maintenance Free	[+ -]	150	87	93
0012550	YT12B-BS	10	160	Senza Manutenzione / Maintenance Free	[+ -]	150	69	132
0012560	52015	22	440	Sigillata / Factory Activated	[- +]	181	77	173
0012570	YB10L-BP	12	160	Convenzionale / Conventional	[- +]	134	90	145
0012580	YTZ14S-BS	11,2	160	Senza Manutenzione / Maintenance Free	[+ -]	150	87	110
0012600	YB9-B-BS	9	120	Senza Manutenzione / Maintenance Free	[+ -]	135	75	135
0012610	YTX14AH-BS	12	210	Senza Manutenzione / Maintenance Free	[+ -]	134	89	166
0012620	YTX14AHL-BS	12	210	Senza Manutenzione / Maintenance Free	[- +]	134	89	166
0012630	YTX20-BS	18	270	Senza Manutenzione / Maintenance Free	[+ -]	175	87	155
0012640	YTX20L-BS	18	270	Senza Manutenzione / Maintenance Free	[- +]	175	87	155
0012650	YB12A-A	12	165	Convenzionale / Conventional	[+ -]	134	80	160
0012660	YB4L-B-BS	4	40	Senza Manutenzione / Maintenance Free	[- +]	120	70	92



◀ cod. **IM07024**
Biella Vespa 50 S PK XL normale



◀ cod. **IM07031**
Biella scooter Piaggio/Gilera 50 cc



◀ cod. **IM07032**
Biella con gabbia per motore scooter 50 cc Minarelli/Yamaha



◀ cod. **IM07033**
Biella con gabbia per motore Minarelli AM AXE 16 mm



◀ cod. **IM07036**
Biella con gabbia per motore Minarelli AM6 AXE 18 mm



◀ cod. **IM07037**
Biella completa per motore Minarelli YP 250 cc

APPLICABILITÀ

APRILIA LEONARDO 250 4T 99-04, LEONARDO ST 250 4T 01-01,
LEONARDO 300 4T 02-04

BENELLI VELVET 250 4T 99-03

ITALJET JUPITER 250 4T 00-02

MALAGUTI MADISON S 250 4T 99-01, PASSWORD 250 4T 05-06,
PASSWORD EU3 250 4T 07-08

MBK

SKYLINER 250 4T 00-03, SKYLINER ABS 250 4T 03-03,
KILIBRE 300 4T 03-06

YAMAHA

MAJESTY 250 4T 96-03, MAJESTY ABS 250 4T 03-03,
MAJESTY DX 250 4T 98-99, X-CITY 250 4T 07-15, X-MAX
250 4T 05-16, X-MAX ABS 250 4T 14-15, VERSITY 300
4T 03-06



◀ cod. **BA00006**
Blocco accensione e serratura MBK Nitro



◀ cod. **BA00007**
Blocco accensione e serratura MBK Booster Stunt



◀ cod. **BA00014**
Blocco accensione e serratura Kymco Agility 50 cc



◀ cod. **BD00001**
Bobina A.T. scooter 50 cc Minarelli/Yamaha con volano giapponese

RIFERIMENTO ORIGINALE

Ducati	432261000
---------------	-----------



◀ **cod. B000001**
Bobina A.T. per Kymco Agility

RIFERIMENTO ORIGINALE

Kymco	00168770
Kymco	00168585
Kymco	00169202

Kymco	00169400
Malaguti	02412700
Piaggio	58083R

APPLICABILITÀ

APRILIA SPORT CITY ONE 4T EU3 125 4T 08-11, SPORT CITY STREET 125 4T 12-12

DERBI BOULEVARD 125 4T 03-04, BOULEVARD 4T EU3 125 4T 08-12, BOULEVARD EU2 125 4T 04-07, GP1 EU 2 125 4T 06-06, BOULEVARD 150 4T 03-04, BOULEVARD 4T E3 150 4T 10-10, BOULEVARD EU3 150 4T 04-07, BOULEVARD EU2 200 4T 05-06, GP1 250 4T 06-07, GP1 LOW SEAT EU3 250 4T 07-08

GILERA NEXUS EU3 125 4T 07-08, RUNNER 4T ST EU3 125 4T 08-16, RUNNER VX 125 4T 05-06, RUNNER VX 4T EU3 125 4T 06-07, RUNNER VXR 4T ST EU3 200 4T 08-11, RUNNER VXR EU3 200 4T 07-07, OREGON 250 4T 06-10

KYMCO AGILITY 4T CARRY 50 4T 11-11, AGILITY 4T R10 50 4T 06-08, AGILITY 4T R12 50 4T 07-08, AGILITY R12 50 4T 05-05, AGILITY RS 50 4T 09-09, B&W 50 2T 02-02, B&W EU2 50 2T 03-03, DINK LC 50 2T 98-02, FILLY LX 50 4T 01-02, LIKE 50 4T 09-09, MXER 50 2T 02-03, MXER EU2 50 2T 04-04, PEOPLE S 50 2T 05-08, SNIPER 50 2T 93-93, SNIPER DD 50 2T 94-96, SUPER 9 50 2T 00-00, SUPER 9 EU2 50 2T 03-04, VITALITY 4T 50 4T 04-04, AGILITY 125 4T 06-06, AGILITY EU3 125 4T 06-08,

AGILITY R16 125 4T 08-09, AGILITY RS 125 4T 09-09, HEROISM 125 4T 95-97, LIKE 125 4T 09-09, MOVIE 125 4T 99-00, MOVIE EU3 125 4T 06-07, MOVIE XL 125 4T 01-01, MOVIE XL EU2 125 4T 03-04, SUPER 8 125 4T 08-09, VIVIO 125 4T 00-00, AGILITY R16 150 4T 08-09, HEROISM 150 4T 95-97, MOVIE EU3 150 4T 06-07, MOVIE XL 150 4T 01-01, MOVIE XL EU2 150 4T 03-04, VIVIO 150 4T 00-00, LIKE LX 200 4T 12-12

MALAGUTI CIAK MASTER EU3 125 4T 06-06, CIAK MASTER EURO 2 200 4T 06-06

PIAGGIO FLY 125 4T 05-07, FLY EU3 125 4T 07-11, MP3 125 4T 06-08, SKYPPER 4T 125 4T 00-02, TYPHOON 4T 2V E3 125 4T 10-11, X-EVO 125 4T 07-16, X7 EU3 125 4T 08-08, X8 125 4T 04-06, X8 PREMIUM EU2 125 4T 06-06, X8 PREMIUM EU3 125 4T 06-07, X8 STREET EU2 125 4T 06-07, X9 125 4T 01-02, X9 EVOLUTION 125 4T 03-03, X9 EVOLUTION 125 4T 05-06, X9 EVOLUTION EU3 125 4T 07-07, ZIP 125 4T 00-02, FLY 150 4T 05-07, FLY EU3 150 4T 08-11, X8 STREET EU2 150 4T 06-08, X9 AMALFI 180 4T 00-03, X8 200 4T 05-07, X9 200 4T 02-03, X9 EVOLUTION 200 4T 03-03, X9 EVOLUTION 250 4T 04-04, X9 EVOLUTION 250 4T 06-06



◀ **cod. B000002**
Bobina A.T. per Booster R - Ovetto - Majesty 125/150 dal 2000

RIFERIMENTO ORIGINALE

Yamaha	3KJ823101000
--------	--------------

APPLICABILITÀ

MBK BOOSTER 50 2T 90-04, BOOSTER 50 2T 90-94, BOOSTER NG 50 2T 95-03, BOOSTER ROCKET 50 2T 97-98, BOOSTER SPIRIT 50 2T 96-00, BOOSTER SPIRIT 50 2T 03-03, BOOSTER SPIRIT EURO2 50 2T 03-03, BOOSTER TRACK 50 2T 96-98, EVOLIS 50 2T 92-95, FIZZ 50 2T 94-95, FLIPPER 50 2T 98-04, FLIPPER EURO 2 50 2T 03-03, FORTE 50 2T 94-96, NITRO 50 2T 97-04, NITRO EURO 2 50 2T 03-03, OVETTO 50 2T 97-04, OVETTO EURO 2 50 2T 02-02, STUNT 50 2T 00-02, NITRO 100 2T 00-02, OVETTO 100 2T 99-02, DODOO 125 4T 00-00, SKYLINER 125 4T 98-00, SKYLINER 150 4T 00-00

YAMAHA AEROX 50 2T 97-02, AEROX 50 2T 04-16, AEROX EURO 2 50 2T 03-03, AEROX NAKED 50 2T 13-16, AEROX R 50 2T 99-00, AXIS 50 2T 95-96, BREEZE 50 2T 94-95, BW'S 50 2T 97-16, BW'S BUMP 50 2T 97-98, BW'S EASY 50 2T 13-13, BW'S NAKED 50 2T 03-04, BW'S NAKED 50 2T 09-16, BW'S NEXT GENERATION 50 2T 97-06, BW'S ORIGINAL 50 2T 99-01, BW'S ORIGINAL EURO 2 50 2T 03-03, DT R 50 2T 07-11, DT X 50 2T 07-11, NEO'S 50 2T 97-02, NEO'S 50 2T 04-16, NEO'S EASY 50 2T 13-13, NEO'S EURO 2 50 2T 02-02, SLIDER 50 2T 00-02, WHY 50 2T 98-05, WHY EURO 2 50 2T 03-05, AEROX 100 2T 00-02, NEO'S 100 2T 99-02, MAJESTY 125 4T 98-00, TEO'S 125 4T 00-00, MAJESTY 150 4T 00-00



◀ **cod. B000003**
Bobina A.T. Piaggio Liberty 125/150cc

RIFERIMENTO ORIGINALE

Piaggio	82597R
---------	--------

APPLICABILITÀ

APRILIA ATLANTIC 125 4T 03-05, ATLANTIC EU3 125 4T 06-08, ATLANTIC EU3 125 4T 10-12, MOJITO 125 4T 03-08, SCARABEO 125 4T 03-06, SPORT CITY 125 4T 04-06, SPORT CITY CUBE 125 4T 08-10, SPORT CITY EU3 125 4T 06-08, SR MAX 125 4T 11-14, SPORT CITY CUBE 250 4T 08-12, ATLANTIC 300 4T 10-11, SPORT CITY STREET 300 4T-4V 12-12, SR MAX 300 4T 11-14, ATLANTIC SPRINT 400 4T 05-08, SCARABEO LIGHT 400 4T 06-08, ATLANTIC SPRINT 500 4T 05-08, SCARABEO LIGHT 500 4T 06-08

DERBI GP1 LOW SEAT EU3 125 4T 07-08, RAMBLA 125 4T 08-09, RAMBLA EU3 2V ER 125 4T 08-08, SONAR 4T 125 4T 09-11, SONAR 4T 150 4T 09-09, RAMBLA 300 4T 10-11

GILERA DNA 125 4T 01-01, NEXUS IE EU3 125 4T 08-10, RUNNER VX 125 4T 00-04, RUNNER VX RACE 125 4T 06-06, RUNNER VX SC 125 4T 06-07, RUNNER VXR RACE 200 125 4T 06-06, DNA 180 4T 01-01, RUNNER VXR 200 4T 02-06, NEXUS EU3 250 4T 06-07, NEXUS SP EU3 250 4T 06-07, NEXUS EU3 300 4T 08-11, FUOCO 4T-4V IE E3 LT 500 4T 13-14, FUOCO IE EU3 500 4T 07-13, NEXUS 500 4T 03-05, NEXUS EU3 500 4T 06-11, NEXUS SP EU3 500 4T 06-07

PIAGGIO BEVERLY 125 4T 01-03, BEVERLY EU3 125 4T 07-08, BEVERLY EURO 3 MIC 125 4T 07-07, BEVERLY EURO 3 SPORT 125 4T 07-08, BEVERLY RST 125 4T 04-07, BEVERLY TOURER EU3 125 4T 07-10, CARNABY 125 4T 07-10, HEXAGON GTX 125 4T 00-00, LIBERTY 125 4T 98-02, LIBERTY 4T 125 4T 06-07, LIBERTY 4T 2V EURO3 125 4T 09-12, LIBERTY 4T EU3 125 4T 06-08, LIBERTY 4T EU3 DELIVERY - SINGLE 125 4T 07-15, LIBERTY 4T EU3 DELIVERY - TNT 125 4T 08-15, LIBERTY 4T SPORT EU3 125 4T 06-08, LIBERTY RST 125 4T 04-05, LIBERTY RST PTT 125 4T 05-11, LIBERTY SPORT 125 4T 06-06, SFERA 125 4T 95-97, SUPER HEXAGON GTX 125 4T 01-02, VESPA ET4 125 4T 96-02, VESPA GRANTURISMO 125 4T 03-07,

VESPA GRANTURISMO EU3 125 4T 06-07, VESPA GTS EU3 125 4T 07-12, VESPA GTV 125 4T 06-08, VESPA GTV 4T NAVY EU3 125 4T 08-08, VESPA LX 125 4T 05-06, VESPA LX 4T FL 125 4T 09-09, VESPA LX EU3 125 4T 06-08, VESPA LXV 4T EU3 125 4T 06-09, VESPA LXV NAVY EU3 125 4T 07-08, VESPA S 4T EU3 125 4T 07-08, LIBERTY 150 4T 01-02, LIBERTY 4T EU3 150 4T 08-08, LIBERTY 4T SPORT EU3 150 4T 08-08, LIBERTY MOC 4T 150 4T 09-13, VESPA LX 150 4T 05-06, VESPA LX 4T FL 150 4T 09-09, VESPA LX EU3 150 4T 06-08, SUPER HEXAGON GTX 12 180 4T 01-02, CARNABY 200 4T 07-08, LIBERTY 200 4T 06-06, LIBERTY 4T EU3 200 4T 06-08, LIBERTY 4T SPORT EU3 200 4T 06-07, LIBERTY RST 200 4T 04-04, LIBERTY SPORT 200 4T 06-06, VESPA GRANTURISMO 200 4T 06-07, BEVERLY 250 4T 05-07, BEVERLY CRUISER 250 4T 07-09, BEVERLY EURO 3 MIC 250 4T 07-07, BEVERLY IE EU3 250 4T 06-08, BEVERLY RST 250 4T 04-05, BEVERLY SPORT 250 4T 06-08, BEVERLY TOURER EU3 250 4T 07-09, CARNABY 250 4T 08-09, MP3 250 4T 06-08, MP3 LT 250 4T 08-09, MP3 MIC 250 4T 08-09, VESPA GT 60 EU3 250 4T 06-07, VESPA GTS 250 4T 05-16, VESPA GTS ABS 250 4T 05-12, VESPA GTV 250 4T 06-09, VESPA GTV 4T NAVY EU3 250 4T 07-07, X-EVO 250 4T 07-16, X7 EU3 250 4T 08-08, X8 EU3 250 4T 05-08, BEVERLY TOURER EU3 300 4T 09-10, BEVERLY EU3 400 4T 06-07, BEVERLY TOURER EU3 400 4T 08-10, MP3 400 4T 07-08, MP3 IE LT TOURING 400 4T 11-11, MP3 IE LT/SPORT 400 4T 08-10, MP3 MIC 400 4T 08-10, MP3 RL TOURING 400 4T 11-11, X-EVO 400 4T 07-11, X8 EU3 400 4T 06-08, BEVERLY 500 4T 02-06, BEVERLY IE EU3 500 4T 06-08, MP3 LT BUSINESS ABS 500 4T 14-16, MP3 LT SPORT/BUSINESS 500 4T 11-13, MP3 RL SPORT-BUSINESS 500 4T 11-12, MP3 SPORT ABS 500 4T 14-16, X9 500 4T 01-02, X9 EVOLUTION 500 4T 03-07, X9 EVOLUTION ABS 500 4T 06-07



◀ cod. **CPS25**

Honda, Kawasaki, Suzuki, Yamaha
12 Volt

MAKE / MODEL	YEAR
Honda ANF 125 Innova	2003-2010
Honda CG125 Titan	1984-2008
Honda CR80R	1982
Honda CX500	1978-1979
Honda CX500C Custom	1979-1982
Honda CX500D Deluxe	1979-1981
Honda CX500EC Sports	1982
Honda CX500TC Turbo	1982
Honda CX650C Custom	1983
Honda FES125 Pantheon	1988-2002
Honda GL500 Silver Wing	1981-1982
Honda GL500I Silver Wing Interstate	1981-1982
Honda H100-A	1980-1982
Honda MB5	1980-1981
Honda NH125 Lead	1986-1987
Honda NH80 Vision	1986-1994
Honda NX500	1988-1999
Honda NX650	1988-1999
Honda QR50	1984-2000
Honda RVT1000R RC51	2000-2006
Honda SCV100 Lead	2003-2008
Honda VTR1000SP	2000-2006
Honda XR125L	2003-2006
Kawasaki AR125	1983-1991
Kawasaki EL250 Eliminator	1987-1996
Kawasaki EL252 Eliminator 252	1996-2003
Kawasaki ER250 Scorpion	1983-1988
Kawasaki EX250 Ninja 250R	1988-2007
Kawasaki EX305 GPZ	1983-1994
Kawasaki KE175	1980-1983
Kawasaki KLE500	1991-2000
Kawasaki KLR250	1985-2005
Kawasaki KLR600 KL600	1984-1994
Kawasaki ZZR250 EX250	1990-2002
Suzuki AN250 Burgman	1988-2002
Suzuki AN400 Burgman	1999-2006
Suzuki AN400S Burgman Type S	2003-2006
Suzuki DR750S	1988-1989
Suzuki DR800S	1990-1997
Suzuki PE175	1978-1981
Suzuki PE250	1977-1982
Suzuki PE400	1980-1981
Suzuki RG125BU Gamma I	1988
Suzuki RG125UC Gamma I	1985-1988
Suzuki RM100	1976-1981
Suzuki RM125	1975-1981
Suzuki RM400	1978-1980
Suzuki RM465	1981-1982
Suzuki RM500	1983-1985
Suzuki RM80	1977-1981
Suzuki RS175	1980-1982
Suzuki RS250	1980-1981
Suzuki TS100	1982-1986

◀ cod. **CPS25** - continued

MAKE / MODEL	YEAR
Suzuki TS125	1982
Suzuki TS185	1973-1981
Suzuki TS250	1971-1978
Suzuki TS250X	1984-1989
Yamaha SR500	1978-1995
Yamaha SZR660	1995-1997
Yamaha TDM850	1996-2001
Yamaha TT500	1977-1981
Yamaha WR250F	2001-2002
Yamaha WR250Z	1994-1998
Yamaha WR400F	1998-2000
Yamaha WR426F	2001-2002
Yamaha XT500	1976-1985
Yamaha XT550	1982-1983
Yamaha XT600E	1990-2002
Yamaha XT600Z Tenere	1983-1985
Yamaha XTZ660 Tenere	1991-1998
Yamaha XV535 Virago	1987-2002
Yamaha XV535SP Virago Special	1994-1997
Yamaha YFM700R Raptor	2006-2015
Yamaha YP250 Majesty	1996-2003
Yamaha YP400 Majesty	2004-2014
Yamaha YZ250	1997-2002
Yamaha YZ250F	2001-2002
Yamaha YZ400F	1998-1999
Yamaha YZ426F	2000-2002



◀ cod. **CPS27**

Honda, Kawasaki, Suzuki, Yamaha
12 Volt

MAKE / MODEL	YEAR
Honda ATC110	1981-1984
Honda ATC125M	1984
Honda ATC185S	1979-1983
Honda ATC200	1981-1983
Honda ATC200E	1982-1983
Honda ATC200ES	1984
Honda ATC200M	1984
Honda ATC200S	1984
Honda ATC200X	1983-1985
Honda ATC250R	1981-1984
Honda CB125TD	1982-1987
Honda CB250RS	1980-1983
Honda CL250SC	1981-1984
Honda CR125R	1999
Honda CR250R	1981-1999
Honda CR450R	1981
Honda CR480R	1982-1983
Honda CR80R	1980-1986
Honda CRM50R	1992-1996
Honda CRM75R	1989-1994
Honda FL250 Odyssey	1981-1984
Honda FT500 Ascot	1982-1983
Honda MB5	1982

◀ cod. CPS27 - continued

MAKE / MODEL	YEAR
Honda MBX50	1983-1986
Honda MBX80	1983-1986
Honda MT5 / MT50	1980-1993
Honda MTX125	1983-1995
Honda MTX200	1983-1985
Honda MTX50	1982-1995
Honda NB50 Aero	1984
Honda NC50	1982-1983
Honda NH125 Aero	1983-1984
Honda NH80 Mascot	1983-1984
Honda NH80 Vision	1983-1984
Honda NU50	1982-1983
Honda NV50	1984
Honda NX50	1980-1982
Honda PX50	1981-1986
Honda PXR50	1984-1987
Honda XL125S	1979-1983
Honda XL185S	1979-1983
Honda XL200R	1983
Honda XL250R	1982-1983
Honda XL250R	1982
Honda XR185	1979
Honda XR200	1980-1983
Honda XR200R	1981-1983
Honda XR250R	1981-1983
Honda XR350R	1983-1984
Honda XR500R	1981-1982
Kawasaki AE50	1981-1982
Kawasaki AE80	1981-1984
Kawasaki AR50	1981-1994
Kawasaki AR80	1981-1990
Kawasaki KDX200	1995-2006
Kawasaki KDX200R	1997-2001
Kawasaki KDX220R	2002-2005
Kawasaki KDX250	1991-1995
Kawasaki KL250 Super Sherpa	2000-2010
Kawasaki KLX250	2006-2007
Suzuki DS80	1978-2000
Suzuki GS450E	1983-1988
Suzuki GS450G	1982-1983
Suzuki GS450GA	1983-1985
Suzuki GS450L	1983-1988
Suzuki GS450TX	1983
Suzuki GSX250E	1982-1983
Suzuki GSX400E	1982
Suzuki JR80	2001-2004
Suzuki RG125FU Gamma II	1992-1994
Suzuki RG125U Wolf	1992
Suzuki RGV250	1988-1996
Suzuki RMX250	1989-1999
Suzuki TS125	1989-1994
Suzuki TS50	1984-1994
Yamaha BL125 Beluga	1985-1987
Yamaha DT125 LC	1982-1988
Yamaha RD125	1982-1989

◀ cod. CPS27 - continued

MAKE / MODEL	YEAR
Yamaha RD80	1982-1984
Yamaha RX100	1985-1996
Yamaha SA50 Passola	1980-1984
Yamaha T50 Townmate	1986
Yamaha T80 Townmate	1983-1996
Yamaha XT125R	2005-2007
Yamaha XT125X Supermotard	2005-2007
Yamaha YZ125	1983-1989
Yamaha YZ250	1983-1989
Yamaha YZ80	1983



◀ cod. CPS28 Kawasaki, Yamaha 12 Volt

MAKE / MODEL	YEAR
Kawasaki VN900B Vulcan 900 Classic	2006-2015
Kawasaki VN900C Vulcan 900 Custom	2007-2015
Kawasaki VN900D Vulcan 900 Classic LT	2006-2015
Yamaha RD250	1978-1979
Yamaha TDM850	1991-1995
Yamaha XV1000 Virago	1984-1989
Yamaha XV1100 Virago	1986-1999
Yamaha XV1100SP Virago Special	1996-1998
Yamaha XV700 Virago	1984-1987
Yamaha XV750 Virago	1988-1997
Yamaha XVS11 V-Star 1100 Custom	2004-2009
Yamaha XVS11 V-Star 1100 Midnight Custom	2005-2009
Yamaha XVS1100 Custom Dragstar	1999-2002
Yamaha XVS1100 V Star 1100 Custom	1999-2003
Yamaha XVS1100A V Star 1100 Classic	1999-2006
Yamaha XVS1100AT V Star 1100 Silverado	2003
Yamaha XVS11A V-Star 1100 Classic	2004-2009
Yamaha XVS11A V-Star 1100 Silverado	2004-2009



◀ cod. CPS29 Honda, Kawasaki, Suzuki, Yamaha 12 Volt

MAKE / MODEL	YEAR
Honda CR125R	2001
Honda CR250R	2001-2007
Honda TRX450ER Electric Start	2006-2014
Honda TRX450R	2004-2009
Honda XR650R	2000-2007
Kawasaki KDX200	1983-1994
Kawasaki KDX250	1981-1984
Kawasaki KFX400	2003-2006
Kawasaki KLX400R	2003-2004
Kawasaki KLX400SR	2003-2004
Kawasaki KX100	2001-2005
Kawasaki KX125	1982-1994
Kawasaki KX250	1982-1994
Kawasaki KX500	1985-1987
Kawasaki KX60	1985-1990



cod. CPS29 - continued

MAKE / MODEL	YEAR
Kawasaki KX85	2001-2005
Kawasaki KXF250 Tecate 4	1987-1988
Suzuki DR100	1985-1990
Suzuki DR650RE Dakar	1994-1995
Suzuki DR650RSE Dakar	1991-1996
Suzuki GSXR50	1986-1987
Suzuki LT125	1983-1987
Suzuki LT160	2003-2004
Suzuki LT160E	1989-1992
Suzuki LT250EF	1985-1986
Suzuki LT250R QuadRacer	1985-1992
Suzuki LT-4WD QuadRunner 250	1990-1998
Suzuki LT-500X KingQuad	2009-2014
Suzuki LT-A450AZ KingQuad	2007-2010
Suzuki LT-A450X KingQuad AXi 4x4	2007-2010
Suzuki LT-A700X KingQuad 4x4	2005-2007
Suzuki LT-A750X KingQuad	2008-2013
Suzuki LT-F160 QuadRunner	1990-2004
Suzuki LT-F250 QuadRunner	1990-2001
Suzuki LT-F250F QuadRunner 4x4	1999-2002
Suzuki LT-F300 KingQuad 4x4	1999-2002
Suzuki LT-F4WDX King Quad 300	1991-1998
Suzuki PE175	1982-1984
Suzuki RM100	2003
Suzuki RM125	1982-1995
Suzuki RM80	1982-2001
Suzuki UH125 Burgman	2002-2006
Yamaha BW80	1986-1990
Yamaha CG50 Jog	1988-1991
Yamaha CS50R Jog R	2002-2009
Yamaha CS50Z Jog RR	2003-2010
Yamaha CV80 Beluga	1983-1987
Yamaha CW50 BWs Original	2004-2009
Yamaha CW50 Zuma	1989-1990
Yamaha CW50 Zuma II	1997-2001
Yamaha CW50RS BWs	1996-2005
Yamaha CW50RSP BWs Spy	1997-1998
Yamaha CW50T BWs B-Wizz	1990-1994
Yamaha DT125 R	1988-2003
Yamaha DT125 RE	2004-2007
Yamaha DT125 X	2005-2006
Yamaha DT50X Supermotard	2007-2008
Yamaha EW50 Slider	2000-2004
Yamaha IT200	1984-1986
Yamaha IT250	1983
Yamaha IT490	1983-1984
Yamaha LC50M Bop	1980
Yamaha PW80	1983-2009
Yamaha QT50	1979-1987
Yamaha SR185	1997-2000
Yamaha SV80 Snoscoot	1988-1990
Yamaha TDR125	1991-2002
Yamaha TT250	1995-2002
Yamaha TT350	1986-1987
Yamaha TTR110E	2008-2016

◀ cod. **CPS29** - continued

MAKE / MODEL	YEAR
Yamaha TTR125	2000-2013
Yamaha TTR125E	2003-2016
Yamaha TTR125L	2000-2013
Yamaha TTR125LE	2003-2016
Yamaha TTR125LW	2000-2013
Yamaha TTR125LWE	2003-2016
Yamaha TTR125S	2003-2007
Yamaha TTR225	1999-2004
Yamaha TTR230	2005-2016
Yamaha TTR250	1999-2006
Yamaha TTR90	2000-2007
Yamaha TTR90E	2003-2007
Yamaha TTR90R	2000-2007
Yamaha TTR90S	2000-2007
Yamaha TW125	1999-2004
Yamaha TW200	1998-2016
Yamaha TY250R	1984-1994
Yamaha TY350	1985-1986
Yamaha TZR125	1987-1993
Yamaha TZR125R	1992-1993
Yamaha TZR125RR	1994-1995
Yamaha TZR50	2003-2008
Yamaha WR200R	1992-1995
Yamaha WR250Z	1991-1993
Yamaha WR500Z	1992-1993
Yamaha XC125 TR Cygnus	1999-2001
Yamaha XG250 Tricker	2005
Yamaha XN125 Teos	2000-2002
Yamaha XN125 Teos	1982
Yamaha XQ125 Maxster	2001-2003
Yamaha XT225	1995-2007
Yamaha XT250	2008-2012
Yamaha YE50 Zest	1993-1995
Yamaha YFA-1 Breeze125	1989-2004
Yamaha YFB250FW Timberwolf 4x4	1994-2000
Yamaha YFM100 Champ	1989-1991
Yamaha YFM125 Raptor	2011-2013
Yamaha YFM125G Grizzly 125	2004-2013
Yamaha YFM200 Moto-4	1985-1990
Yamaha YFM225 Moto-4	1986-1988
Yamaha YFM250 Moto-4	1989-1991
Yamaha YFM250 Raptor SE	2008-2012
Yamaha YFM250B Big Bear 250	2006-2009
Yamaha YFM250BT Bruin 250 2WD	2005-2006
Yamaha YFM250F Timberwolf 2WD	1992-1999
Yamaha YFM250R Raptor	2008-2013
Yamaha YFM250X Bear Tracker	1999-2004
Yamaha YFM350BA Bruin 350 2WD	2004-2006
Yamaha YFM350ER Moto-4	1987-1995
Yamaha YFM350FA Bruin Auto 4x4	2004-2006
Yamaha YFM350FG Grizzly 350 4WD	2007-2014
Yamaha YFM350FG Grizzly 350 4WD Hunter	2012-2014
Yamaha YFM350FW Big Bear 4x4	1987-1999
Yamaha YFM350FX Wolverine 350	1995-2001
Yamaha YFM350G Grizzly 350 2WD	2007-2014

◀ cod. **CPS29** - continued

MAKE / MODEL	YEAR
Yamaha YFM350R Raptor 350	2004-2013
Yamaha YFM350RSE Raptor 350	2005-2007
Yamaha YFM350U Big Bear 2x4	1996-1999
Yamaha YFM350X Warrior	1987-2001
Yamaha YFM350X Wolverine 350	2006-2009
Yamaha YFM400A Kodiak	2000-2004
Yamaha YFM400FA Kodiak 400 4WD	2000-2006
Yamaha YFM400FW Kodiak 400 4WD	1993-1999
Yamaha YFM450DAE Grizzly 450 4WD Hunting	2014
Yamaha YFM450FA Kodiak 450 4x4	2003-2006
Yamaha YFM450FG Grizzly 450 4WD	2011-2014
Yamaha YFM450FG Grizzly 450 4WD	2007-2010
Yamaha YFM450FGH Grizzly 450 4WD Hunter	2007-2013
Yamaha YFM450FGI Grizzly 450 4WD	2011-2014
Yamaha YFM450FGI Grizzly 450 4WD	2007-2010
Yamaha YFM450FGP Grizzly 450 EPS 4WD	2011-2014
Yamaha YFM450FX Wolverine 4x4	2006-2010
Yamaha YFM450GPH Grizzly 450 EPS 4WD Hunter	2011-2014
Yamaha YFM4FG Grizzly 400	2007-2008
Yamaha YFM50 Raptor	2004-2009
Yamaha YFM600FWA Grizzly 600	1998-2001
Yamaha YFM660F Grizzly 4x4	2002-2008
Yamaha YFM660R Raptor	2001-2005
Yamaha YFM80 Badger	1992-2001
Yamaha YFM80 Grizzly	2005-2008
Yamaha YFM80 Moto-4	1985-1988
Yamaha YFM80 Raptor 80	2002-2008
Yamaha YFS200 Blaster	1997-2007
Yamaha YFU1W Pro Hauler	1989
Yamaha YH50 Why	1999-2006
Yamaha YJ50 Vino	2001-2004
Yamaha YJ50 Vino Classic	2002-2005
Yamaha YN100 Neos	1999-2003
Yamaha YN50 (2T) Neos	1998-2009
Yamaha YP125 Majesty	1998-2006
Yamaha YQ100 Aerox	2000-2002
Yamaha YQ50 Aerox	1999-2009
Yamaha YT60 Zinger	1984-1985
Yamaha YTM200 Tri-Moto	1983-1986
Yamaha YTZ250 Tri-Moto	1985-1986
Yamaha YZ125	1996-2003
Yamaha YZ250	1994-2004
Yamaha YZ490	1983-1990
Yamaha YZ80	1993-2001
Yamaha YZ80 LW	1994-2001



◀ cod. **CPS32**

Suzuki
12 Volt

MAKE / MODEL	YEAR
Suzuki DR125SE	1994-1996
Suzuki DR200SE	1996-2009
Suzuki GN125E	1991-1997



- ◀ cod. **FZ00368**
Campana frizione per motore scooter 50 cc Minarelli/Yamaha Ø 105 mm



- ◀ cod. **FZ00369**
Campana frizione per motore scooter 50 cc Minarelli/Yamaha Ø 107 mm



- ◀ cod. **FZ00375**
Campana frizione Honda @ - SH 125/150

RIFERIMENTO ORIGINALE

Honda	22101KCW850
Kymco	00127702

Malaguti	65044600
Keeway	200093120000

APPLICABILITÀ

HONDA @ [NES] 125 4T 00-06, DYLAN [SES] 125 4T 02-04, PANTHEON IE [FES] 125 4T-2V 03-05, PS I [PES] 125 4T 06-10, SH 125 4T-2V 01-04, SH IE SCOOPI 125 4T-2V 05-12, SILVER WING [FES] 125 4T-2V 07-12, @ [NES] 150 4T 00-06, DYLAN [SES] 150 4T 02-04, PANTHEON IE [FES] 150 4T-2V 03-05, PS I [PES] 150 4T 06-10, SH 150 4T-2V 01-04, SH IE SCOOPI 150 4T 05-12, SILVER WING [FES] 150 4T-2V 07-12

KEEWAY OUTLOOK 125 4T 07-08, OUTLOOK 150 4T 07-08

KYMCO AGILITY 125 4T 06-06, AGILITY EU3 125 4T 06-08, AGILITY PLUS 125 4T 14-14, AGILITY R16 125 4T 08-09, AGILITY R16 125 4T 12-12, AGILITY RS 125 4T 09-09, HEROISM 125 4T 95-97, K-XCT I 125 4T 12-14, LIKE 125 4T 09-09, MOVIE 125 4T 99-00, MOVIE EU3 125 4T 06-07, MOVIE XL 125 4T 01-01, MOVIE XL EU2 125 4T 03-04, PEOPLE 125 4T 99-00, PEOPLE EU3 125 4T 07-08, PEOPLE EU3 125 4T 11-11, PEOPLE ONE I 125 4T 13-13, PEOPLE S 125 4T 05-05, PEOPLE S DD EU3 125 4T 07-08,

MALAGUTI SUPER 8 125 4T 08-09, VIVIO 125 4T 00-00, AGILITY R16 150 4T 08-09, HEROISM 150 4T 95-97, MOVIE EU3 150 4T 06-07, MOVIE XL 150 4T 01-01, MOVIE XL EU2 150 4T 03-04, PEOPLE 150 4T 99-00, PEOPLE EU2 150 4T 03-03, VIVIO 150 4T 00-00, AGILITY I PLUS 200 4T 14-14, AGILITY R16 200 4T 12-12, AGILITY R16 200 4T 10-10, LIKE IE 200 4T 09-09, LIKE LX 200 4T 12-12, PEOPLE S 200 4T 05-05, PEOPLE S I 200 4T 07-07

BLOG IE 125 4T 09-10, CENTRO IE EU3 125 4T 08-09, CENTRO SL IE EU3 125 4T 09-10, CIAK MASTER 125 4T 04-04, CIAK MASTER 150 4T 04-04, BLOG IE 160 4T 09-10, CENTRO IE EU3 160 4T 08-09, CENTRO SL IE EU3 160 4T 09-10, CIAK MASTER EURO 2 200 4T 06-06



- ◀ cod. **FZ00376**
Campana frizione per motore scooter 50 cc Piaggio

RIFERIMENTO ORIGINALE

Piaggio	289933
---------	--------



- ◀ cod. **FZ00377**
Campana frizione per motore scooter 125/150/180 4T Piaggio

RIFERIMENTO ORIGINALE

Piaggio	8440494
Aprilia	8440494
Gilera	8440494

Derbi	8440494
Malaguti	42606500
Peugeot	756258

APPLICABILITÀ

APRILIA ATLANTIC 125 4T 03-05, ATLANTIC ARRECIFE 125 4T 03-05, SCARABEO 125 4T 04-06, SPORT CITY 125 4T 04-06, ATLANTIC 200 4T 03-05, ATLANTIC ARRECIFE 200 4T 03-05, SPORT CITY 200 4T 04-06, SCARABEO 250 4T 04-06

DERBI BOULEVARD 125 4T 02-04, BOULEVARD EU2 125 4T 04-07, GP1 EU 2 125 4T 06-06, BOULEVARD 150 4T 02-04, BOULEVARD EU3 150 4T 04-07

GILERA DNA 125 4T 01-01, RUNNER VX 125 4T 00-06, DNA 180 4T 01-01, RUNNER 180 4T 00-01, RUNNER VXR 180 4T 00-01

MALAGUTI MADISON S RESTYLING 200 4T 02-02

PIAGGIO BEVERLY 125 4T 01-03, SKYPPER 4T 125 4T 00-02, SUPER HEXAGON GTX 12 125 4T 01-02, VESPA ET4 125 4T 99-02, X9 125 4T 01-02, ZIP 125 4T 00-02, SKYPPER 4T 150 4T 00-02, VESPA ET4 150 4T 99-02, HEXAGON GTX 180 4T 00-00, SUPER HEXAGON GTX 12 180 4T 01-02, X9 AMALFI 180 4T 00-03, BEVERLY 200 4T 01-03, VESPA GRANTURISMO 200 4T 03-05, VESPA GTS EU3 200 4T 07-12, VESPA GTV EU3 200 4T 06-08

RENAULT FULLTIME 125 4T 02-03



◀ **cod. FZ00379**
Campana frizione per motore scooter 125 cc Minarelli/Yamaha

RIFERIMENTO ORIGINALE

Yamaha	4CWE66110000
Yamaha	5DSE66110000

Yamaha	5XLE66110000
--------	--------------

APPLICABILITÀ

ITALJET JUPITER 125 4T 01-02, MILLENNIUM 125 4T 00-02
MALAGUTI MADISON 125 4T 99-01, MADISON R RESTYLING 125 4T 02-02, MADISON R RESTYLING EU2 125 4T 03-04, PHANTOM MAX 125 4T 03-03
MBK DOODO 125 4T 00-00, FLAMET 125 4T 95-99, SKYLINER 125 4T 98-02, SKYLINER E 125 4T 03-03, THUNDER 125 4T 01-02

YAMAHA BW'S 4T 125 4T 10-10, CYGNUS R (XC K) 125 4T 97-98, CYGNUS R (XC) 125 4T 99-03, CYGNUS X (NXC) 125 4T 04-06, CYGNUS X IE EU3 (NXC) 125 4T 07-11, CYGNUS125 (XCT) 125 4T 95-98, MAJESTY 125 4T 98-00, MAJESTY (SNR1) 125 4T 01-01, MAJESTY (SNR8) 125 4T 02-02, MAJESTY E 125 4T 03-09, MAXSTER 125 4T 01-02, TEO'S 125 4T 00-00, FLY ONE R (XC) 150 4T 97-98



◀ **cod. FZ00380**
Campana frizione per motore scooter 50 cc Aprilia D. Tech

RIFERIMENTO ORIGINALE

Aprilia	AP2MDA000426
---------	--------------



◀ **cod. FZ00384**
Campana frizione per Piaggio Beverly 500 cc 4T

RIFERIMENTO ORIGINALE

Piaggio	825176
---------	--------

APPLICABILITÀ

APRILIA ATLANTIC 500 4T 01-04, SCARABEO 500 4T 03-06
GILERA FUOCO IE EU3 500 4T 07-13, NEXUS 500 4T 03-05, NEXUS EU3 500 4T 06-11, NEXUS SP EU3 500 4T 06-07
MALAGUTI SPIDER MAX GT 500 4T 04-05, SPIDER MAX GT EU3 500 4T 06-06, SPIDER MAX RS 500 4T 08-08
PEUGEOT GEOPOLIS IE EU3 400 4T-4V 90-02, SATELIS EU3 400 4T 07-12, GEOPOLIS IE EU3 500 4T-4V 90-02, SATELIS EU3 500 4T 90-02

PIAGGIO BEVERLY EU3 400 4T 06-07, BEVERLY TOURER EU3 400 4T 08-10, MP3 400 4T 07-08, MP3 IE LT TOURING 400 4T 11-11, MP3 IE LT/SPORT 400 4T 08-10, MP3 MIC 400 4T 08-10, MP3 RL TOURING 400 4T 11-11, X-EVO 400 4T 07-11, X8 EU3 400 4T 06-08, BEVERLY 500 4T 02-06, BEVERLY IE EU3 500 4T 06-08, MP3 LT SPORT/BUSINESS 500 4T 11-13, MP3 RL SPORT-BUSINESS 500 4T 11-12, X9 500 4T 01-02, X9 EVOLUTION 500 4T 03-07



◀ **cod. FZ00391**
Campana frizione Honda SH 300 cc

RIFERIMENTO ORIGINALE

Honda	22100KF6000
-------	-------------

APPLICABILITÀ

HONDA PANTHEON [FES] 125 2T 98-02, PANTHEON [FES] 150 2T 98-02, FORESIGHT [FES] 250 4T 98-99, FORZA [NSS] 250 4T-2V 02-07, JAZZ ES REFLEX [NSS] 250 4T-2V 01-04, JAZZ REFLEX [NSS] 250 4T-2V 01-01, SH IE SCOOPY 300 4T-4V 07-19



◀ cod. **FZ00395**
Campana frizione Piaggio 125cc

RIFERIMENTO ORIGINALE

Piaggio	8440494
---------	---------

Piaggio	875973
---------	--------

APPLICABILITÀ

APRILIA ATLANTIC EU3 125 4T 06-08, ATLANTIC EU3 125 4T 10-12, MOJITO 125 4T 03-08, SCARABEO 125 4T 03-03, SCARABEO EU3 125 4T 06-07, SPORT CITY CUBE 125 4T 08-10, SPORT CITY EU3 125 4T 06-08, SPORT CITY ONE 4T EU3 125 4T 08-11, SPORT CITY STREET 125 4T 12-12, SR MOTARD 125 4T-2V 12-14, MOJITO 150 4T 03-07, SPORT CITY CUBE 200 4T 08-10, SPORT CITY EU3 200 4T 06-08, ATLANTIC EU3 250 4T 06-08, SCARABEO LIGHT 250 4T 06-08, SPORT CITY CUBE 250 4T 08-12, SPORT CITY EU3 250 4T 06-08, ATLANTIC 300 4T 10-11, SCARABEO LIGHT 300 4T 09-10, SPORT CITY CUBE 300 4T 08-10, SPORT CITY STREET 300 4T-4V 12-12

DERBI BOULEVARD 4T EU3 125 4T 08-12, GP1 LOW SEAT EU3 125 4T 07-08, RAMBLA 125 4T 08-09, BOULEVARD EU2 200 4T 05-06, GP1 250 4T 06-07, GP1 LOW SEAT EU3 250 4T 07-08, RAMBLA 250 4T 08-09, RAMBLA EU3 2VER 250 4T 08-08, RAMBLA 300 4T 10-11

GILERA NEXUS EU3 125 4T 07-08, NEXUS IE EU3 125 4T 08-10, RUNNER VXR 200 4T 02-06, NEXUS EU3 250 4T 06-07, NEXUS EU3 300 4T 08-11

MALAGUTI MADISON 3 125 4T 06-09, MADISON R 180 4T 01-02, PHANTOM MAX 200 4T 03-03, MADISON 3 250 4T 06-09, MADISON RS 250 4T 04-04, PHANTOM MAX 250 4T 04-04

PIAGGIO BEVERLY EU3 125 4T 07-08, BEVERLY RST 125 4T 04-07, BEVERLY TOURER EU3 125 4T 07-10, CARNABY 125 4T 07-10, FLY 125 4T 05-07, HEXAGON GTX 125 4T 00-00, LIBERTY 125 4T 98-02, MP3 125 4T 06-08, MP3 IBRIDO 125 4T 09-10, MP3 IE 125 4T 08-09, MP3 IE TOURING 125 4T 11-12, MP3 YOURBAN ERL 125 4T 11-13, VESPA GRANTURISMO 125 4T 03-07, VESPA GRANTURISMO EU3 125 4T 06-07, VESPA GTS 4T IE SUPER 125 4T 09-16, VESPA LX 125 4T 05-06, VESPA LX 4T EU3 TOURING 125 4T 10-11, VESPA LX 4T FL 125 4T 09-09, VESPA LX EU3 125 4T 06-08, VESPA LX EU3 IE 125 4T 09-11, VESPA LXV 4T EU3 125 4T 06-09, VESPA LXV IE 4T 125 4T 10-13, VESPA LXV NAVY EU3 125 4T 07-08, VESPA S 4T EU3 125 4T 07-08, VESPA S 4T IE & COLLEGE 125 4T 09-11, X-EVO 125 4T 07-16, X7 EU3 125 4T 08-08, X7 EVO IE EU3 125 4T 09-10, X8 125 4T 04-06, FLY 150 4T 05-07, LIBERTY 150 4T 01-02, VESPA LX 150 4T 05-06, VESPA LX EU3 150 4T 06-08, VESPA LX EU3 IE 150 4T 09-11, X8 STREET EU2 150 4T 06-08,

CARNABY 200 4T 07-08, LIBERTY 200 4T 06-06, LIBERTY 4T SPORT EU3 200 4T 06-07, VESPA GRANTURISMO 200 4T 06-07, X8 200 4T 04-07, BEVERLY 250 4T 05-07, BEVERLY IE EU3 250 4T 06-08, BEVERLY TOURER EU3 250 4T 07-09, MP3 250 4T 06-08, MP3 LT 250 4T 08-09, MP3 MIC 250 4T 08-09, VESPA GT 60 EU3 250 4T 06-07, VESPA GTS 250 4T 05-16, VESPA GTS ABS 250 4T 05-12, VESPA GTV 250 4T 06-09, X-EVO 250 4T 07-16, X7 EU3 250 4T 08-08, BEVERLY TOURER EU3 300 4T 09-10, CARNABY CRUISER 300 4T 09-12, MP3 4T 4V IE LT IBRIDO 300 4T 10-11, MP3 IE LT 300 4T 10-11, MP3 IE LT TOURING 300 4T 11-13, MP3 IE LT/SPORT 300 4T 11-14, MP3 IE MIC 300 4T 10-11, MP3 IE TOURING 300 4T 11-12, MP3 YOURBAN ERL 300 4T 11-15, MP3 YOURBAN LT ERL 300 4T 11-12, VESPA GTS SUPER 300 4T 08-16, VESPA GTV VIA MONTENAPOLEONE 300 4T 10-10, X7 EVO IE EU3 300 4T 09-10



◀ cod. **FZ00397**
Campana frizione Yamaha X-Max 250 Ø 145

RIFERIMENTO ORIGINALE

Yamaha	5GM166110000
--------	--------------

APPLICABILITÀ

APRILIA LEONARDO 250 4T 02-04, LEONARDO 300 4T 02-04

ITALJET JUPITER 250 4T 00-00

MALAGUTI MADISON S 250 4T 99-01, PASSWORD 250 4T 05-06, PASSWORD EU3 250 4T 07-08

MBK SKYLINER 250 4T 00-03, SKYLINER ABS 250 4T 03-03, KILIBRE 300 4T 03-06

YAMAHA MAJESTY 250 4T 00-03, MAJESTY ABS 250 4T 03-03, X-CITY 250 4T 07-15, X-MAX 250 4T 05-16, X-MAX ABS 250 4T 14-15, VERSITY 300 4T 03-06



◀ cod. **FZ00399**
Campana frizione Kymco Xciting 300 cc

RIFERIMENTO ORIGINALE

Kymco	00127980
-------	----------

APPLICABILITÀ

KYMCO B&W 250 4T 00-00, B&W EU2 250 4T 03-03, GRAND DINK 250 4T 01-02, GRAND DINK EU2 250 4T 03-04, PEOPLE LC 250 4T 03-04, PEOPLE S 250 4T 06-06, X CITING I 250 4T 06-07, YUP 250 4T 03-03, X CITING I 300 4T 08-08, X CITING I R 300 4T 08-09



◀ cod. **FZ00402**
Campana Frizione Suzuki Burgman 400cc K7-L3

RIFERIMENTO ORIGINALE

Suzuki	21220-05H20-000
--------	-----------------

APPLICABILITÀ

SUZUKI AN BURGMAN K7/L0 400 4T 07-10, AN BURGMAN L1 400 4T 11-11, AN BURGMAN L2 400 4T 12-12, AN BURGMAN L3 400 4T 13-13, AN BURGMAN L4 400 4T 14-14, AN BURGMAN L5 400 4T 15-15, AN BURGMAN L6 400 4T 16-16



◀ cod. **FZ00404**
Campana Frizione Honda Vision 110cc

RIFERIMENTO ORIGINALE

Honda	22100-GFM-900
-------	---------------

APPLICABILITÀ

Honda Vision 110 [NSC] 110 4T-2V 12-12



◀ cod. **FZ00406**
Campana Frizione Honda PCX125cc

RIFERIMENTO ORIGINALE

Honda	22100-KWN-900
-------	---------------

APPLICABILITÀ

Honda PCX 125 125 4T-2V 10-13



◀ cod. **FZ00408**
Campana Frizione Kymco Downtown 200/300cc

RIFERIMENTO ORIGINALE

Kymco	122150
-------	--------

APPLICABILITÀ

KYMCO DOWNTOWN I 200 4T 10-10, PEOPLE GTI 200 4T 10-10, DOWNTOWN ABS 300 4T 10-10, DOWNTOWN I 300 4T 09-09, DOWNTOWN I 300 4T 11-11, DOWNTOWN I ABS 300 4T 11-16, PEOPLE GTI 300 4T 10-11



◀ cod. **FZ00412**
Campana Frizione Suzuki Burgman 125cc K7-L3

RIFERIMENTO ORIGINALE

Suzuki	21220-20E50-000
--------	-----------------

APPLICABILITÀ

SUZUKI UH BURGMAN K7/LO 125 4T 07-10, UH BURGMAN L1 125 4T 11-11, UH BURGMAN L3 125 4T 13-13, UX SIXTEEN K8/LO 125 4T 08-10, UX SIXTEEN L1 125 4T 11-11, UX SIXTEEN K8/LO 150 4T 08-10, UX SIXTEEN L1 150 4T 11-11



◀ cod. **FZ00415**
Campana frizione Yamaha X-MAX 125cc

RIFERIMENTO ORIGINALE

Yamaha	1B9E66110000
--------	--------------

APPLICABILITÀ

YAMAHA X-CITY EU3 125 4T-4V 08-11, X-MAX R 125 4T-4V 06-16, X-MAX R ABS 125 4T-4V 11-11, X-MAX RA ABS 125 4T-4V 13-16



◀ cod. **FZ00416**
Campana frizione Sym Symphony 125/150cc

RIFERIMENTO ORIGINALE

Sym	22101M9Q000
-----	-------------

APPLICABILITÀ

SYM ATTILA 125 4T 99-00, EURO MX 125 4T 02-02, EURO MX EU2 125 4T 03-04, FIDDLE II 125 4T 08-10, GTS JOYMAX 125 4T 06-07, HD EU2 125 4T-4V 03-04, HD EU3 125 4T-4V 07-08, HD EVO 125 4T-4V 05-06, HD EVO EU3 125 4T-4V 07-08, HD EVO EU3 125 4T-4V 10-11, HD EVO TAMBURO EU3 125 4T-4V 08-09, HD2 125 4T-4V 11-11, JET 4 125 4T 09-10, JET V 125 4T 11-11, JOYRIDE EU2 125 4T-4V 05-06, JOYRIDE EU3 125 4T-4V 07-07, JOYRIDE EVO 125 4T-4V 09-10, MEGALO 125 4T 06-07, NEW DUKE 125 4T 00-01, SHARK 125 4T 99-02, SUPER DUKE 125 4T 99-02, SYMPHONY 125 4T 09-09, SYMPHONY S 125 4T 09-10, SYMPHONY SR 125 4T 10-10, SYMPLY 125 4T 07-08, SYMPLY II 125 4T 09-10, VS 125 4T-4V 06-06, VS EU3 125 4T-4V 07-08, ATTILA 150 4T 99-00, EURO MX 150 4T 02-02, EURO MX EU2 150 4T 03-04, FIDDLE II 150 4T 10-10, SHARK 150 4T 00-01, SYMPHONY 150 4T 09-09, SYMPHONY S 150 4T 10-10, SYMPHONY SR 150 4T 10-10, VS 150 4T-4V 06-06, VS EU3 150 4T-4V 07-08, TRACK RUNNER 180 4T 06-07



◀ cod. **FZ00420**
Campana frizione piaggio vespa primavera 125cc 3V Iget

APPLICABILITÀ

PIAGGIO LIBERTY IGET 4T 3V IE 125 4T-3V 15-17, VESPA PRIMAVERA 4T 3V E4 IGET ABS 125 4T-3V 16-17, VESPA SPRINT IGET 4T 3V ABS (EMEA) 125 4T-3V 16-17



◀ cod. **FZ00421**
Campana frizione piaggio liberty 125cc 3V Iget

APPLICABILITÀ

PIAGGIO LIBERTY 4T 3V IE E3 125 4T-3V 13-14, VESPA LX PRIMAVERA 4T 3V IE 125 4T-3V 13-17, VESPA SPRINT 4T 3V IE 125 4T-3V 14-15



- ◀ cod. **CB03002**
Carburatore SHA 13-13 (Si) 1851
- ◀ cod. **CB03003**
Carburatore SHA 13-13 (Ciao,PX) 2044
- ◀ cod. **CB03008**
Carburatore SHBC 19-19 (Vespa) 773
- ◀ cod. **CB03013**
Carburatore PHVA 17.5 ED (Sfera-Zip)1012
- ◀ cod. **CB03014**
Carburatore PHBN 17.5 LS (Booster-Amico) 3067
- ◀ cod. **CB03016**
Carburatore PHVA 17,5 LS Phantom 1097



- ◀ cod. **CB03020**
Carburatore PHBG 19 DS (R.2631) con resca depressore e arrivo olio



- ◀ cod. **CB03021**
Carburatore PHBG 19 DD scooter Piaggio (R.2685) con resca depressore e arrivo olio



- ◀ cod. **CB03022**
Carburatore PHBG 21 DS scooter (R.2632) con resca depressore e arrivo olio



- ◀ cod. **CB03023**
Carburatore PHBG 21 BS (R.2660) con resca depressore e arrivo olio



- ◀ cod. **CB03024**
Carburatore PHBG 21 BD scooter Piaggio (R.2665) con resca depressore e arrivo olio



- ◀ cod. **CB03025**
Carburatore PHBG 21 BS plurimarce (R.2671) con resca depressore e arrivo olio



◀ **cod. HNC1001**

Honda CDI Module
12 Volt

MAKE / MODEL	YEAR
Honda XL600V Transalp	1989-1990



◀ **cod. HNC1018**

Honda CDI Module
12 Volt

MAKE / MODEL	YEAR
Honda XR250R	1996-2004



◀ **cod. HNC1047**

Honda CDI Module
12 Volt

MAKE / MODEL	YEAR
Honda NX650	1988-1989
Honda XR650L	1993-2016

SCOOTER 50 cc

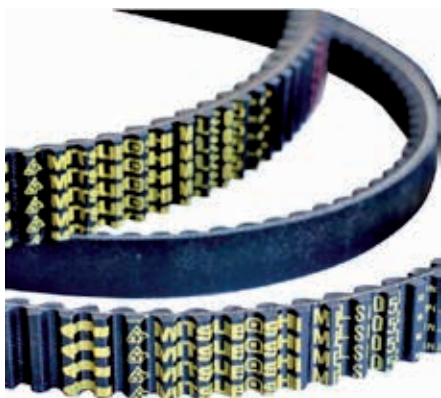

◀ cod. **9934180** **BANDO**
Cinghia Peugeot Kisbee 50 cc 4T

RIFERIMENTO ORIGINALE

Peugeot	724257
---------	--------

APPLICABILITÀ

PEUGEOT KISBEE 4T 50 4T 10-17

◀ cod. **9935240** **MITSUBOSHI**
Cinghia di trasmissione per motori scooter 50 cc Honda

RIFERIMENTO ORIGINALE

Honda	23100GW2013
-------	-------------

APPLICABILITÀ

HONDA BALI 50 2T 93-99, SFX / SXR 50 2T 95-01, SHADOW 50 2T 98-01

PEUGEOT BUXY 50 2T 90-02, BUXY RS 50 2T 90-02, ELYSEO 50 2T 90-02, JET FORCE 50 2T 90-02, LUDIX 50 2T 90-02, SPEEDAKE 50 2T 90-02, SPEEDFIGHT 50 2T 97-04, SPEEDFIGHT LC 50 2T 97-04, SQUAB 50 2T 90-02, TREKKER 50 2T 90-02, VIVACITY 50 2T 90-02, X-FIGHT 50 2T 00-02

◀ cod. **9935270** **MITSUBOSHI**
Cinghia di trasmissione per motori scooter 50 cc Minarelli/Yamaha

RIFERIMENTO ORIGINALE

Aprilia	AP8206109
Benelli	R16140011A0

Yamaha	SRNE76411000
--------	--------------

APPLICABILITÀ: SCOOTER 50 cc

APRILIA	AMICO 50 2T 94-94, AMICO 50 2T 96-98, AMICO GL/GLE 50 2T 93-95, AMICO LX/SPORT/CAT 50 2T 92-93, AREA 51 50 2T 98-00, GULLIVER 50 2T 95-98, GULLIVER LC 50 2T 96-98, RALLY 50 2T 95-03, RALLY LIQUID COOLED 50 2T 96-99, SCARABEO 50 2T 93-05, SR (ORIZZONTALE) 50 2T 94-96, SR (VERTICALE) 50 2T 93-93, SR LIQUID COOLED 50 2T 94-96, SR RACING 50 2T 97-99, SR STEALTH 50 2T 97-00, SR WWW 50 2T 97-01
ATALA	CAROSSELLO 50 2T 99-01
BENELLI	491 GT 50 2T 98-99, 491 NAKED 50 2T 02-02, 491 RACING 50 2T 98-99, 491 RR 50 2T 99-01, 491 SP 50 2T 99-99, 491 SPORT 50 2T 98-99, 491 ST 50 2T 99-01, K2 50 2T 98-01, K2 LIQUID COOLED 50 2T 98-01, PEPE 50 2T 99-01, PEPE LX 50 2T 03-04
BETA	ARK 50 2T 96-08, ARK LC 50 2T 96-08, CHRONO 50 2T 95-96, EIKON 50 2T 99-03, QUADRA 50 2T 95-95, QUADRA 50 2T 99-01, TEMPO 50 2T 93-02, TEMPO 50 2T 95-95
ITALJET	DRAGSTER 50 2T 98-02, PISTA 2 50 2T 97-98, SCOOP 2 50 2T 96-98, YANKEE 50 2T 93-97

KTM	K50 50 2T 96-01
MACAL	THUNDER 50 2T 95-96
MALAGUTI	CENTRO SL 50 2T 94-98, CIAK 50 2T 99-01, CIAK EURO 2 2,3 50 2T 03-03, CIAK EURO2 50 2T 01-03, CIAK MASTER EURO 2 50 2T 06-06, F12 PHANTOM 50 2T 94-98, F12 PHANTOM EURO 2 50 2T 02-02, F12 PHANTOM EURO 2 2,3 50 2T 03-04, F12 PHANTOM LC 50 2T 94-98, F12 PHANTOM LC EURO 2 2,3 50 2T 03-04, F12 R PHANTOM LC 50 2T 07-10, F12 RESTYLING EURO 1 50 2T 99-02, F12 RESTYLING EURO 2 50 2T 06-06, F12 RESTYLING LC EURO 2 50 2T 06-06, F15 FIRE FOX 50 2T 96-98, F15 FIRE FOX AIR COOLED 50 2T 05-06, F15 FIRE FOX EURO 2 50 2T 02-06, F15 FIRE FOX EURO 2 2,3 50 2T 03-04
MBK	BOOSTER 50 2T 90-04, BOOSTER 50 2T 90-94, BOOSTER EURO 2 50 2T 04-04, BOOSTER NG 50 2T 95-03, BOOSTER ROCKET 50 2T 97-98, BOOSTER SPIRIT 50 2T 96-00, BOOSTER SPIRIT 50 2T 03-03, BOOSTER SPIRIT EURO2 50 2T 03-03, BOOSTER TRACK 50 2T 96-98, FLIPPER 50 2T 98-04, FLIPPER EURO 2 50 2T 03-03, MACH G 50 2T 02-04, MACH G LC 50 2T 02-04, NITRO 50 2T 97-04, NITRO EURO 2 50 2T 03-03, OVETTO 50 2T 97-04, OVETTO EURO 2 50 2T 02-02, STUNT 50 2T 00-02

MOTRON	SYNCR0 50 2T 98-00, THUNDER 50 2T 95-98
RIEJU	FIRST 50 2T 95-98, WINDY 50 2T 95-98
YAMAHA	AEROX 50 2T 97-02, AEROX 50 2T 04-16, AEROX EURO 2 50 2T 03-03, AEROX NAKED 50 2T 13-16, AEROX R 50 2T 99-00, BW'S 50 2T 97-16, BW'S BUMP 50 2T 97-98, BW'S EASY 50 2T 13-13, BW'S NAKED 50 2T 03-04, BW'S NAKED 50 2T 09-16, BW'S NEXT GENERATION 50 2T 97-06, BW'S ORIGINAL 50 2T 99-01, BW'S ORIGINAL EURO 2 50 2T 03-03, JOG R 50 2T 02-02, JOG R EURO2 50 2T 02-02, JOG R EURO2 50 2T 06-15, JOG R LC 50 2T 02-15, NEO'S 50 2T 97-02, NEO'S 50 2T 04-16, NEO'S EASY 50 2T 13-13, NEO'S EURO 2 50 2T 02-02, RS SPY 50 2T 95-98, SLIDER 50 2T 00-02, WHY 50 2T 98-05, WHY EURO 2 50 2T 03-05, ZUMA 50 2T 97-01

◀ cod. **9935340** **MITSUBOSHI**
Cinghia di trasmissione per motori scooter 50 cc Minarelli/Yamaha tipo orizzontale corto

RIFERIMENTO ORIGINALE

Aprilia	AP8206818
---------	-----------

Yamaha	3WF176410000
--------	--------------

APPLICABILITÀ: SCOOTER 50 cc - ATV QUAD

APRILIA	SONIC 50 2T 98-07, SONIC GP 50 2T 98-08	MALAGUTI	F10 50 2T 92-00, F10 EURO 2 50 2T 02-06, F10 EURO 2 2,3 50 2T 03-04, F10 RESTYLING EURO 2 50 2T 06-06, YESTERDAY 50 2T 97-00
DINLI	HELIX DL603 50 2T 07-13, HELIX DL603 90 50 2T 07-13, T-REX 50 2T 07-13	MBK	EVOLIS 50 2T 92-95, FIZZ 50 2T 94-95, FORTE 50 2T 94-96
E-TON	VIPER RXL 50 2T 06-06	YAMAHA	AXIS 50 2T 95-96, BREEZE 50 2T 94-95, CRZ 50 2T 91-95, JOG 50 2T 92-01, ZEST 50 2T 95-95
LAVERDA	QUASAR 50 2T 02-04		

◀ cod. **9935370** **MITSUBOSHI**
Cinghia di trasmissione per motori scooter 50 cc Peugeot

RIFERIMENTO ORIGINALE

Peugeot	776648
---------	--------

APPLICABILITÀ

PEUGEOT KISBEE 50 2T 00-00, LUDIX 50 2T 90-02

SCOOTER 50 cc

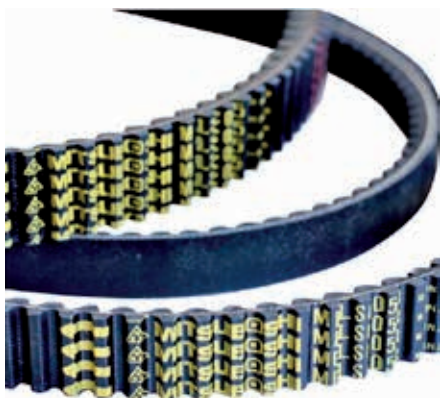

◀ **cod. 9935410** **MITSUBISHI**
Cinghia di trasmissione per motori scooter 50 cc Peugeot

APPLICABILITÀ
Peugeot E-Vivacity (EC-45 km/H)

◀ **cod. 9935420** **MITSUBISHI**
Cinghia di trasmissione per motori scooter 50 cc Piaggio

RIFERIMENTO ORIGINALE
Piaggio 82712R

APPLICABILITÀ

- APRILIA** SCARABEO 2T 50 2T 14-14, SCARABEO 2T EU2 MOTORE PIAGGIO 50 2T 10-12, SCARABEO 2T NET 50 2T 09-10, SCARABEO 4T 50 4T 02-06, SCARABEO 4T 4V 50 4T-4V 10-12, SCARABEO 4T 4V 50 4T-4V 14-14, SCARABEO 4T 4V NET 50 4T-4V 09-10, SCARABEO 4T RESTYLING EU3 50 4T 06-09, SCARABEO QUATTRO 50 4T-4V 09-09, SCARABEO STREET 50 2T 05-06, SCARABEO STREET 2T RESTYLING 50 2T 06-09, SPORT CITY ONE 2T 50 2T 08-11, SPORT CITY ONE 4T 50 4T 08-10, SR MOTARD 50 2T 12-14, SR MOTARD 4T 4V 50 4T-4V 13-14
- DERBI** BOULEVARD 2T 50 2T 09-14, SONAR 2T 50 2T 09-09, VARIANT SPORT 2T 50 2T 12-12

- GILERA** DNA 50 2T 00-02, DNA 50 2T 05-07, DNA GP EXPERIENCE 50 2T 03-04
- PEUGEOT** E-VIVACITY (EC-45 KM/H) 50 16-16
- PIAGGIO** FLY 2T 50 2T 05-07, FLY 2T 50 2T 10-11, LIBERTY 50 2T 97-05, LIBERTY 2T 50 2T 06-08, LIBERTY 2T PTT EU2 50 2T 04-05, LIBERTY 2T RST 50 2T 04-04, LIBERTY 2T SPORT 50 2T 06-08, LIBERTY 4T 50 4T 00-02, LIBERTY 4T 50 4T 05-08, LIBERTY 4T 3V 25 KM/H 50 4T-3V 16-16, LIBERTY 4T 3V IE 50 4T-3V 15-17, LIBERTY 4T 3V IE E4 50 4T-3V 17-18, LIBERTY 4T DELIVERY - SINGLE 50 4T 10-14, LIBERTY 4T DELIVERY TNT 50 4T 09-09, LIBERTY 4T IGET CORPORATE E4 50 4T-3V 18-18, LIBERTY 4T PTT (DEU) 50 4T 07-12, LIBERTY 4T PTT - DOUBLE - NEXIVE 50 4T 09-17,

LIBERTY 4T RST 50 4T 04-04, LIBERTY 4T SPORT 50 4T 06-08, LIBERTY IGET 4T 3V 25KM/H 50 4T-3V 16-16, LIBERTY IGET 4T 3V IE 50 4T-3V 15-17, LIBERTY IGET 4T 3V IE E4 EMEA 50 4T-3V 17-18, LIBERTY IGET 4T 3V IE E4 EMEA 25KM/H 50 4T-3V 18-18, LIBERTY MOC 2T & ELLE 50 2T 09-13, LIBERTY MOC 4T & ELLE 50 4T 09-16, TYPHOON 2T E2 50 2T 10-12, TYPHOON 2T E3 CH 50 2T 11-11, TYPHOON 2T EURO4 50 4T-3V 18-18

◀ **cod. 9935480** **MITSUBISHI**
Cinghia di trasmissione per motori scooter 50 cc Piaggio

RIFERIMENTO ORIGINALE
Piaggio 842907

APPLICABILITÀ
DERBI ATLANTIS 4T 50 4T 04-06, ATLANTIS 4T EU2 50 4T 07-07, BOULEVARD 4T EU2 25KM/H 50 4T 09-09

PIAGGIO FLY 4T 50 4T 05-07, FLY 4T & 25-30 KM/H 50 4T 08-11, FLY 4T 2V 50 4T 13-15, FLY 4T 2V 25-30KM/H 50 4T 12-17, FLY 4T 4V 50 4T-4V 12-13, FLY 4T MOTORE CHN 50 4T 06-07, VESPA PRIMAVERA 4T 4V 50 4T-4V 13-17, VESPA SPRINT 4T 4V 50 4T-4V 14-17

◀ **cod. 9935570** **MITSUBISHI**
Cinghia di trasmissione per motori scooter 50 cc Peugeot

RIFERIMENTO ORIGINALE
Peugeot 729171

APPLICABILITÀ
PEUGEOT BUXY 50 2T 90-02, BUXY RS 50 2T 90-02, ELYSEO 50 2T 90-02, JET FORCE 50 2T 90-02, LUDIX 50 2T 90-02, SPEEDAKE 50 2T 90-02, SPEEDFIGHT 50 2T 97-04, SPEEDFIGHT LC 50 2T 97-04, SQUAB 50 2T 90-02, TREKKER 50 2T 90-02, VIVACITY 50 2T 90-02, X-FIGHT 50 2T 00-02

◀ **cod. 9935590** **MITSUBISHI**
Cinghia di trasmissione per motori scooter 50 cc Minarelli/Yamaha

RIFERIMENTO ORIGINALE
Yamaha 5C3-E7641-00

APPLICABILITÀ
YAMAHA GIGGLE 50 4T-3V 08-08

◀ **cod. 9935600** **MITSUBISHI**
Cinghia di trasmissione per motori scooter 50 cc Minarelli/Yamaha

RIFERIMENTO ORIGINALE
Yamaha 5C3-E7641-00

APPLICABILITÀ
YAMAHA NEO'S 4.50 4T-3V 09-15

SCOOTER 50 cc

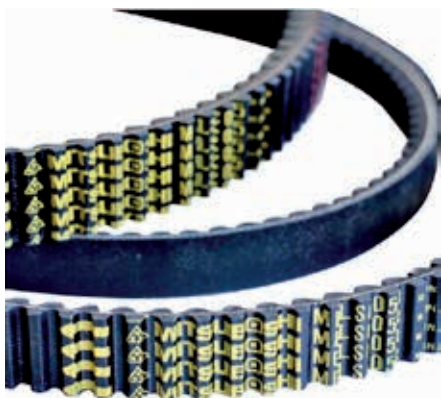

◀ cod. **9935800**  **MITSUBOSHI**
Cinghia di trasmissione per motori scooter 50 cc Piaggio

RIFERIMENTO ORIGINALE

Benelli	R030424102000
Garelli	GA06570
Garelli	GA02165
Gilera	430728

Keeway	24107B01F000
Malaguti	59015000
Piaggio	430728

APPLICABILITÀ: SCOOTER 50 CC - ATV QUAD

BENELLI PEPE 50 2T 10-10, PEPE LX 50 2T 07-09, PEPE OLD 50 2T 07-09, PEPE OLD 50 2T 11-11, QUATTRONONEX 50 2T 08-11

CPI ARAGON 50 2T 03-03, HUSSAR 50 2T 03-03, OLIVER 50 2T 03-03, POP CORN 50 2T 03-03

EXPLORER CRACKER 50 2T 03-03

GARELLI TIESSE 2T 50 2T 08-08, VIP 50 4T 06-06

GILERA STORM 50 2T 94-95, TYPHOON 50 2T 94-97, TYPHOON X 50 2T 98-99

HUPPER MONTECARLO 30 50 2T 09-09

KEEWAY ATV EC2 50 2T 06-06, ATV OFF ROAD 50 2T 07-07, F-ACT 50 2T 07-08, FLASH 50 2T 07-08, FOCUS 50 2T 06-06, GOCCIA 50 2T 09-09, HURRICANE 50 2T 06-08, MATRIX 50 2T 06-08, PIXEL EURO 2 50 2T 09-12, RY8 50 2T 08-08

MALAGUTI F10 AC WAP 50 2T 08-08, F12 R PHANTOM AC 50 2T 07-08

PIAGGIO FREE 50 2T 92-94, FREE FL 50 2T 95-02, NRG 50 2T 94-96, NRG RST MC2 50 2T 96-98, NTT 50 2T 95-96

◀ cod. **9935810**  **MITSUBOSHI**
Cinghia di trasmissione per motori scooter 50 cc Piaggio

RIFERIMENTO ORIGINALE

Piaggio	431190
---------	--------

APPLICABILITÀ

GILERA EASY MOVING 50 2T 95-96

PIAGGIO QUARTZ 50 2T 92-96, SFERA MAQUILLAGE 2 50 2T 94-94, SFERA RST 50 2T 95-97, VESPA ET2 50 2T 97-98, ZIP 50 2T 95-96, ZIP BIMODALE 50 2T 94-97, ZIP FAST RIDER 50 2T 93-94, ZIP FAST RIDER RST 50 2T 96-97, ZIP RST 50 2T 96-99, ZIP SP 50 2T 96-00

◀ cod. **9935820**  **MITSUBOSHI**
Cinghia di trasmissione per motori scooter 50 cc Aprilia

RIFERIMENTO ORIGINALE

Aprilia	AP2MCA000014
---------	--------------

APPLICABILITÀ

APRILIA HABANA-MOJITO CUSTOM 50 2T 99-03, HABANA-MOJITO RETRO' 50 2T 99-03, SCARABEO DITECH 50 2T-IE 01-04, SR DITECH EU2 50 2T-IE 02-04, SR H2O DITECH 50 2T-IE 00-04, SR R FACTORY MOTORE APRILIA 50 2T-IE 05-05

SUZUKI ESTILETE UF 50 2T 00-00, KATANA K1-K4 50 2T 01-04, KATANA V-Y 50 2T 97-00, ZILLION UX 50 2T 99-99

SYM SYMPHONY EURO 2 50 4T 09-09

◀ cod. **9935830**  **MITSUBOSHI**
Cinghia di trasmissione per motori scooter 50 cc Piaggio

RIFERIMENTO ORIGINALE

Piaggio	436864
---------	--------

APPLICABILITÀ

APRILIA MOJITO CUSTOM 2T MOTORE PIAGGIO 50 2T 04-10, SR CARBURATORE 50 2T 14-14, SR R 50 2T 04-09, SR R FACTORY CARBURATORE 50 2T 10-14, SR R FACTORY IE 50 2T 10-14, SR STREET CARBURATORE 50 2T 03-12

DERBI ATLANTIS 2T 50 2T 10-10, ATLANTIS 2T EU2 50 2T 07-09, ATLANTIS O2 50 2T 02-02, ATLANTIS O2 BULLET 50 2T 03-05, ATLANTIS O2 CITY 50 2T 04-06, ATLANTIS O2 RED BULLET 50 2T 03-03, ATLANTIS O2 TWO CHIC 50 2T 05-05, GP1 50 2T 01-03, GP1 EU 2 50 2T 05-05, GP1 OPEN EU2 50 2T 06-09, GP1 RACE EU2 50 2T 05-07

GILERA ICE 50 2T 01-05, RUNNER 50 2T 97-00, RUNNER POGGIALI 50 2T 02-02, RUNNER PURE JET 50 2T-IE 02-04, RUNNER SP 50 2T 02-07, RUNNER SP 50 2T 10-12, RUNNER SP SPECIAL EDITION 50 2T 07-07, RUNNER SP ST & SIMONCELLI 50 2T 08-09, STALKER 50 2T 97-11, STALKER NAKED 50 2T 08-08, STALKER SPECIAL EDITION 50 2T 07-08, STORM EURO 2 50 2T 07-07, TYPHOON XR 50 2T 00-00

PIAGGIO DIESIS 50 2T 01-01, FREE DELIVERY 50 2T 00-01, NRG MC3 50 2T 01-04, NRG POWER DD 50 2T 05-17, NRG POWER DD SERIE SPECIALE 50 2T 07-12, NRG POWER DT 50 2T 06-15, NRG POWER DT SERIE SPECIALE 50 2T 07-08, NRG PUREJET 50 2T-IE 02-04, TYPHOON 50 2T 01-11

◀ cod. **9935840**  **MITSUBOSHI**
Cinghia di trasmissione per motori scooter 50 cc Piaggio

RIFERIMENTO ORIGINALE

Piaggio	82645R
---------	--------

APPLICABILITÀ

PIAGGIO VESPA ET2 50 2T 98-05, VESPA ET2 INIEZIONE 50 2T 97-00, VESPA ET4 50 4T 00-05, VESPA LX 2T 50 2T 05-13, VESPA LX 2T TOURING & 30KM 50 2T 10-13, VESPA LX 4T 50 4T 05-09, VESPA LX 4T 4V 50 4T-4V 09-13, VESPA LX 4T 4V TOURING 50 4T-4V 10-13, VESPA LXV 2T 50 2T 06-09, VESPA LXV 2T NAVY 50 2T 08-08, VESPA S 2T & COLLEGE 50 2T 07-12, VESPA S 4T 4V & COLLEGE 50 4T-4V 08-12, ZIP 2T 50 2T 08-13, ZIP 4T 50 4T 00-13, ZIP LC 50 2T 00-04, ZIP SP 50 2T 01-04, ZIP SP EURO 2 50 2T 06-13, ZIP 4T 100 4T 06-10

SCOOTER 50 cc

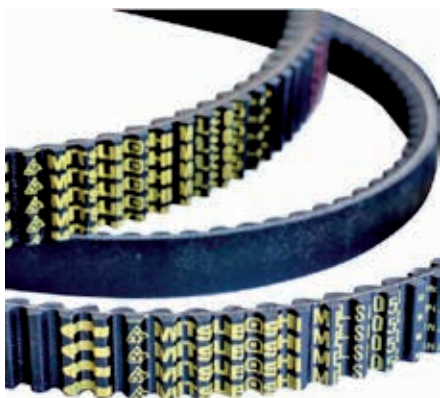

◀ cod. **9935850**  **MITSUBOSHI**

Cinghia Honda SH 50 cc H'84-'95

APPLICABILITÀ

Honda SH 50 2T 84-89

◀ cod. **9935860**  **MITSUBOSHI**

Cinghia Honda NH 50 cc LEAD '87-'95

APPLICABILITÀ

Honda LEAD 50 2T 89-90

◀ cod. **9935950**  **MITSUBOSHI**

Cinghia Suzuki Katana 50 cc

APPLICABILITÀ

Suzuki AP 50 2T 94-97, KATANA K1-K4 50 2T 01-04, KATANA V-Y 50 2T 97-00

SCOOTER 100 cc

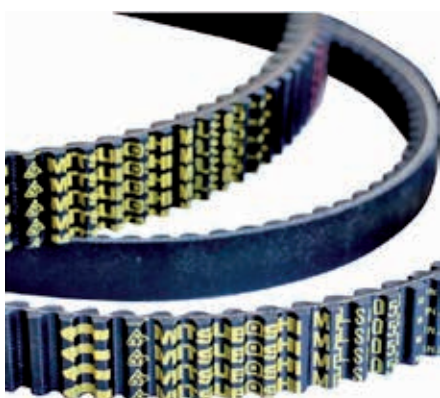

◀ cod. **9935200**  **MITSUBOSHI**

Cinghia di trasmissione per motori scooter 100 cc 2T Aprilia

RIFERIMENTO ORIGINALE

Aprilia	AP8510802	Yamaha	5FA176410
---------	-----------	--------	-----------

APPLICABILITÀ

APRILIA SCARABEO (YAMAHA) 100 2T 00-00
YAMAHA AEROX 100 2T 00-02, BW'S 100 2T 99-01, NEO'S 100 2T 99-02

◀ cod. **9935210**  **MITSUBOSHI**

Cinghia di trasmissione per motori scooter 100 cc 4T Aprilia

RIFERIMENTO ORIGINALE

Aprilia	82646R
---------	--------

APPLICABILITÀ

APRILIA SCARABEO 4T 100 4T 01-05, SCARABEO 4T 100 4T 10-12, SCARABEO 4T 100 4T 14-14, SCARABEO 4T NET 100 4T 09-09, SCARABEO 4T NET EU3 100 4T 10-10, SCARABEO 4T RESTYLING 100 4T 06-09

◀ cod. **9935440**  **MITSUBOSHI**

Cinghia di trasmissione per motori scooter 100 cc 4T Piaggio

RIFERIMENTO ORIGINALE

Piaggio	829484
---------	--------

APPLICABILITÀ

DERBI ATLANTIS 4T 100 4T 04-06, BOULEVARD 4T 100 4T 10-11 **PIAGGIO** FLY 100 4T 06-14, FREE 100 4T 02-03

MAXI SCOOTER

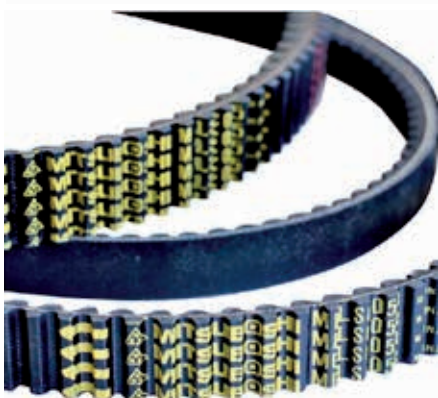

◀ cod. **9915220** **BANDO**

◀ cod. **9935660** **MITSUBOSHI**

Cinghia di trasmissione per motori scooter 125/150 cc Aprilia - Rotax

RIFERIMENTO ORIGINALE

Aprilia	AP0280102
Beta	3610750000

Kymco	00127985
Malaguti	51700300

APPLICABILITÀ

APRILIA LEONARDO 125 4T 96-02, LEONARDO ST 125 4T 03-04, SCARABEO 125 4T 99-03, LEONARDO 150 4T 96-02, SCARABEO 150 4T 99-03

BETA EIKON 125 4T 00-02, EIKON 150 4T 00-02

BMW C1 125 4T 00-03, C1 200 4T 02-03

KYMCO B&W 125 4T 00-00, B&W EU2 125 4T 03-04, DINK 125 4T 97-98, DINK CLASSIC 125 4T 02-02, DINK CLASSIC EU2 125 4T 03-03, DINK EU3 125 4T 06-07, DINK LX 125 4T 98-00, GRAND DINK 125 4T 01-02, GRAND DINK EU2 125 4T 03-04, B&W 150 4T 00-00, B&W EU2 150 4T 03-04, DINK 150 4T 97-98, DINK CLASSIC 150 4T 02-02, DINK CLASSIC EU2 150 4T 03-03, DINK LX 150 4T 98-00, GRAND DINK 150 4T 01-02, GRAND DINK EU2 150 4T 03-04

MALAGUTI F18 WARRIOR 125 4T 00-02, F18 WARRIOR 150 4T 00-02

◀ cod. **9915340** **BANDO**

◀ cod. **9935780** **MITSUBOSHI**

Cinghia di trasmissione per motori scooter 180 cc Piaggio

RIFERIMENTO ORIGINALE

Piaggio	484497
---------	--------

Gilera	484497
--------	--------

APPLICABILITÀ

Gilera Runner FXR 180 180 2T 97-02

Piaggio Hexagon LXT180 180 2T 98-00

◀ cod. **9915350** **BANDO**

◀ cod. **9935670** **MITSUBOSHI**

Cinghia di trasmissione per motori scooter 125/150 cc Piaggio

RIFERIMENTO ORIGINALE

Piaggio	434812
---------	--------

Gilera	434812
--------	--------

APPLICABILITÀ

APRILIA SR 125 2T 99-01, SR 150 2T 99-01

GILERA RUNNER FX 125 2T 97-02, TYPHOON 125 2T 95-98, TYPHOON X-XR 125 2T 99-00

PIAGGIO SKIPPER LX 125 2T 98-99, HEXAGON 150 2T 94-97, SKIPPER LX 150 2T 98-99, SKYPPER 150 2T 94-97

◀ cod. **9915360** **BANDO**

◀ cod. **9935680** **MITSUBOSHI**

Cinghia di trasmissione per motori scooter 125 cc Piaggio

RIFERIMENTO ORIGINALE

Piaggio	431258
---------	--------

APPLICABILITÀ

Piaggio Hexagon 125 125 2T 94-97, Hexagon LX 125 125 2T 98-99, Skypper 125 125 2T 94-97

◀ cod. **9915370** **BANDO**

◀ cod. **9935690** **MITSUBOSHI**

Cinghia di trasmissione per motori scooter 125 cc Piaggio

RIFERIMENTO ORIGINALE

Piaggio	478547
---------	--------

APPLICABILITÀ

Piaggio Sfera 125 4T 95-97, Vespa ET4 125 125 4T 96-98

MAXI SCOOTER

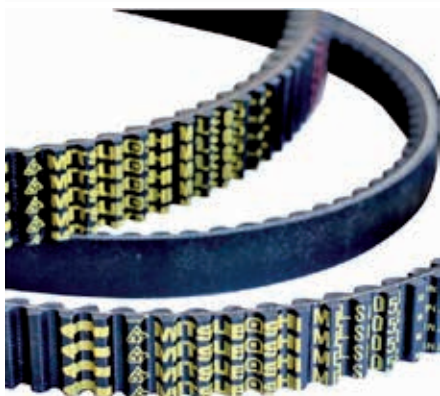

◀ cod. **9915380** **BANDO**

◀ cod. **9935700** **MITSUBISHI**

Cinghia di trasmissione per motori scooter 125/150/180 cc Minarelli/Yamaha

RIFERIMENTO ORIGINALE

Benelli	R16140631A0
Malaguti	71700900
Yamaha	5DS176410000
MBK	5DS176410000

Yamaha	5NSE76411000
Yamaha	5XME76410000
Aprilia	AP8550130
Italjet	4871702090

APPLICABILITÀ

BENELLI VELVET 125 4T 99-01, VELVET TOURING 125 4T 02-03, VELVET 150 4T 99-01, VELVET TOURING 150 4T 02-03

ITALJET JUPITER 125 4T 01-02, MILLENNIUM 125 4T 00-02, JUPITER 150 4T 01-02, MILLENNIUM 150 4T 00-02

MALAGUTI MADISON 125 4T 99-01, MADISON R RESTYLING 125 4T 02-02, MADISON R RESTYLING EU2 125 4T 03-04, PHANTOM MAX 125 4T 03-03, MADISON T 150 4T 99-01

MBK DOODO 125 4T 00-00, SKYLINER 125 4T 98-02, SKYLINER E 125 4T 03-03, THUNDER 125 4T 01-02, DOODO 150 4T 01-02, SKYLINER 150 4T 00-02, THUNDER 150 4T 01-02

YAMAHA MAJESTY 125 4T 98-00, MAJESTY (5NR1) 125 4T 01-01, MAJESTY (5NR8) 125 4T 02-02, MAJESTY E 125 4T 03-09, MAXSTER 125 4T 01-02, TEO'S 125 4T 00-00, MAJESTY 150 4T 00-00, MAJESTY (5NS1) 150 4T 01-01, MAJESTY (5NS6) 150 4T 02-02, MAXSTER 150 4T 01-02, TEO'S 150 4T 01-02, MAJESTY E 180 4T 03-06

◀ cod. **9915410** **BANDO**

Cinghia di trasmissione per motori scooter 250 cc Honda

RIFERIMENTO ORIGINALE

Honda	23100KM1671
-------	-------------

Piaggio	495158
---------	--------

APPLICABILITÀ

HONDA CN SPAZIO/HELIX 250 4T 86-99

PIAGGIO HEXAGON GT 250 4T 98-00

◀ cod. **9915640** **BANDO**

Cinghia di trasmissione per motori scooter 125/150 cc Kymco

RIFERIMENTO ORIGINALE

Kymco	00127785
-------	----------

APPLICABILITÀ

Kymco Heroism 125 125 4T 95-97, Movie 125 125 4T 99-00, Vivio 125 125 4T 00-00, Heroism 150 150 4T 95-97, Vivio 150 150 4T 00-00

◀ cod. **9915790** **BANDO**

Cinghia di trasmissione per motori scooter 250 cc Suzuki

RIFERIMENTO ORIGINALE

Suzuki	27601-14F11-000
--------	-----------------

APPLICABILITÀ

SUZUKI AN BURGMAN K1/K2 250 4T 01-02, AN BURGMAN K3/K6 250 4T 03-06

◀ cod. **9915800** **BANDO**

◀ cod. **9935710** **MITSUBISHI**

Cinghia di trasmissione per motori scooter 250 cc Yamaha

RIFERIMENTO ORIGINALE

Aprilia	AP8122639
Benelli	R16040171A0
Malaguti	91700200

Yamaha	5CG176410000
MBK	5CG176410000

APPLICABILITÀ

APRILIA LEONARDO 250 4T 99-04, LEONARDO ST 250 4T 01-01, LEONARDO 300 4T 02-04

BENELLI VELVET 250 4T 99-03

ITALJET JUPITER 250 4T 00-02

MALAGUTI MADISON S 250 4T 99-01

MBK SKYLINER 250 4T 00-03, SKYLINER ABS 250 4T 03-03

YAMAHA MAJESTY 250 4T 96-03, MAJESTY ABS 250 4T 03-03, MAJESTY DX 250 4T 98-99

MAXI SCOOTER



◀ cod. **9917990** **BANDO**

◀ cod. **9935720** **MITSUBOSHI**
Cinghia di trasmissione per motori scooter 250 cc Honda

RIFERIMENTO ORIGINALE

Honda	23100KFG003
Honda	23100KTB003

Piaggio	496304
---------	--------

APPLICABILITÀ

HONDA FORESIGHT [FES] 250 4T 98-99, FORESIGHT [FES] D.D. 250 4T 00-05, FORZA [NSS] 250 4T-2V 02-07, JAZZ ES REFLEX [NSS] 250 4T-2V 01-04, JAZZ REFLEX [NSS] 250 4T-2V 01-01

PIAGGIO X9 250 4T 00-01

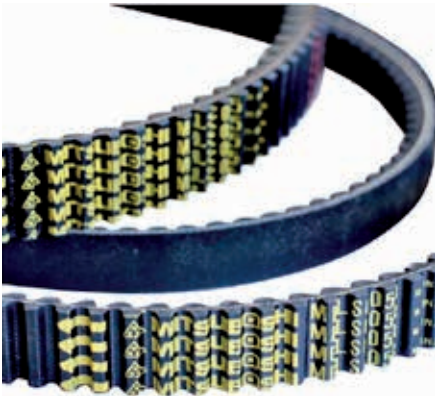

◀ cod. **9918000** **BANDO**

Cinghia di trasmissione per motori scooter 125/150 cc Honda

RIFERIMENTO ORIGINALE

Honda	23100KFF901
-------	-------------

APPLICABILITÀ

HONDA PANTHEON [FES] 125 2T 98-02, PANTHEON [FES] 150 2T 98-02

◀ cod. **9920430** **BANDO**

◀ cod. **9935730** **MITSUBOSHI**
Cinghia di trasmissione per motori scooter 400 cc Suzuki

RIFERIMENTO ORIGINALE

Suzuki	27601-15F10-000
--------	-----------------

APPLICABILITÀ

Suzuki AN Burgman 400 K3/K6 400 4T 03-06

◀ cod. **9922420**

Cinghia di trasmissione per motori scooter 250 cc Kymco

RIFERIMENTO ORIGINALE

Kymco	00127998
-------	----------

APPLICABILITÀ

KYMCO B&W 250 4T 00-00, B&W EU2 250 4T 03-03, GRAND DINK 250 4T 01-02, GRAND DINK EU2 250 4T 03-04, YUP 250 4T 03-03

◀ cod. **9923140**

◀ cod. **9935770** **MITSUBOSHI**
Cinghia di trasmissione per motori scooter 125/150 cc Honda

RIFERIMENTO ORIGINALE

Honda	23100KGF901
Honda	23100KGG911

Keeway	200013160000
Malaguti	65044800

APPLICABILITÀ

HONDA @ [NES] 125 4T 00-06, BALLI 125 4T 96-01, DYLAN [SES] 125 4T 02-04, PANTHEON IE [FES] 125 4T-2V 03-05, PS I [PES] 125 4T 06-10, SH 125 4T-2V 01-04, SH IE SCOOPY 125 4T-2V 05-12, SILVER WING [FES] 125 4T-2V 07-12, @ [NES] 150 4T 00-06, BALLI 150 4T 96-01, DYLAN [SES] 150 4T 02-04, PANTHEON IE [FES] 150 4T-2V 03-05, PS I [PES] 150 4T 06-10, SH 150 4T-2V 01-04, SH IE SCOOPY 150 4T 05-12, SILVER WING [FES] 150 4T-2V 07-12

KEEWAY OUTLOOK 125 4T 07-08, OUTLOOK DR 125 4T 07-11, SILVERBLADE 4T 125 4T 11-11, OUTLOOK 150 4T 07-08, OUTLOOK DR 150 4T 07-11

MALAGUTI BLOG 125 4T 11-11, BLOG IE 125 4T 09-10, CENTRO IE EU3 125 4T 08-09, CENTRO SL 125 4T 11-11, CENTRO SL IE EU3 125 4T 09-10, BLOG 160 4T 11-11, BLOG IE 160 4T 09-10, CENTRO IE EU3 160 4T 08-09, CENTRO SL 160 4T 11-11, CENTRO SL IE EU3 160 4T 09-10

WT MOTORS ATENE 150 4T 08-10

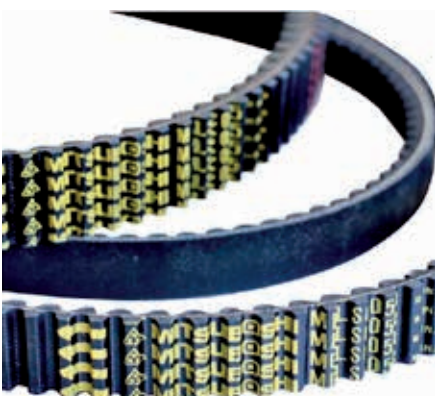

MAXI SCOOTER



◀ **cod. 9925280**  **MITSUBISHI**
Cinghia di trasmissione per motori scooter 125 cc Minarelli/Yamaha

RIFERIMENTO ORIGINALE

Yamaha	1B9E76410000	MBK	1B9E76410000
--------	--------------	-----	--------------

APPLICABILITÀ

MBK	CITYLINER EU3 125 4T-4V 08-10, SKYCRUISER 125 4T-4V 07-07	YAMAHA	X-CITY EU3 125 4T-4V 08-11, X-MAX R 125 4T-4V 06-16, X-MAX R ABS 125 4T-4V 11-11, X-MAX RA ABS 125 4T-4V 13-16
------------	---	---------------	--

◀ **cod. 9925600**  **MITSUBISHI**
Cinghia di trasmissione per motori scooter 250/300 cc Minarelli/Yamaha

RIFERIMENTO ORIGINALE

Malaguti	71701100	Malaguti	71701100
Yamaha	5SEE76410200		

APPLICABILITÀ

MALAGUTI	PASSWORD 250 4T 05-06, PASSWORD EU3 250 4T 07-08	YAMAHA	X-CITY 250 4T 07-15, X-MAX 250 4T 05-16, X-MAX ABS 250 4T 11-12, X-MAX ABS 250 4T 14-15, X-MAX BLACK 250 4T 09-09, X-MAX SPORT 250 4T 11-12, VERSITY 300 4T 03-06
MBK	KILIBRE 300 4T 03-06		

◀ **cod. 9925850** 

◀ **cod. 9935790**  **MITSUBISHI**
Cinghia di trasmissione per motori scooter 125/250 cc Sym

RIFERIMENTO ORIGINALE

Sym	1B01HMA01
-----	-----------

APPLICABILITÀ

SYM	GTS 250 4T-4V 07-08, JOYMAX 250 4T-4V 05-07, JOYMAX EU3 I 250 4T-4V 07-08
------------	---

◀ **cod. 9925860** 

Cinghia di trasmissione per motori scooter 200 cc Sym

RIFERIMENTO ORIGINALE

Sym	1B01HHA01
-----	-----------

APPLICABILITÀ

SYM	HD EU2 200 4T-4V 03-04, HD EU3 I 200 4T-4V 07-07, HD EVO EU2 200 4T-4V 05-06, HD EVO EU3 I 200 4T-4V 07-07, HD EVO I EU3 200 4T-4V 10-10, HD EVO I TAMBURO EU3 200 4T-4V 08-09, HD2 I 200 4T-4V 11-11
------------	---

◀ **cod. 9926420** 

Cinghia di trasmissione per motori scooter 125/200 cc Kymco

RIFERIMENTO ORIGINALE

Kymco	00127099	Sym	1B01KN701
-------	----------	-----	-----------

APPLICABILITÀ

KYMCO	DINK I E EU3 200 4T 06-07
SYM	FIDDLE II 125 4T 08-09, SYMPLY 125 4T 07-08, SYMPLY II 125 4T 09-10

MAXI SCOOTER

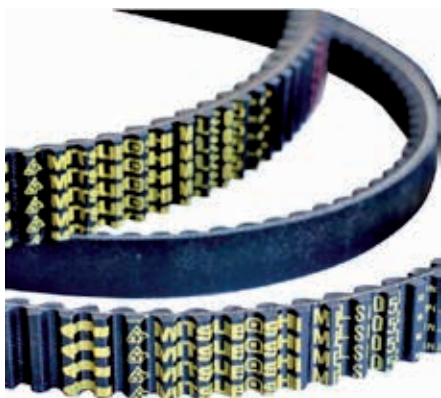

◀ cod. **9926430** **BANDO**

◀ cod. **9935740** **MITSUBOSHI**

Cinghia di trasmissione per motori scooter 125/150/200 cc Kymco

RIFERIMENTO ORIGINALE

Kymco	00127541
Kymco	00127542

Malaguti	51700600
Malaguti	51700700

APPLICABILITÀ

KYMCO AGILITY 125 4T 06-06, AGILITY CARRY 125 4T 11-11, AGILITY EU3 125 4T 06-08, AGILITY PLUS 125 4T 14-14, AGILITY PLUS E4 125 4T 16-16, AGILITY R16 125 4T 08-09, AGILITY R16 125 4T 12-12, AGILITY RS 125 4T 09-09, LIKE 125 4T 09-09, LIKE LX 125 4T 12-12, MOVIE EU3 125 4T 06-07, MOVIE XL 125 4T 01-01, MOVIE XL EU2 125 4T 03-04, PEOPLE 125 4T 99-00, PEOPLE EU2 125 4T 03-03, PEOPLE EU3 125 4T 07-08, PEOPLE EU3 125 4T 11-11, PEOPLE ONE E4 125 4T 16-16, PEOPLE ONE I 125 4T 13-13, PEOPLE ONE I DD 125 4T 15-15, PEOPLE S 125 4T 05-05, PEOPLE S DD EU3 125 4T 07-08, SUPER 8 125 4T 08-09, AGILITY R16 150 4T 08-09, MOVIE EU3 150 4T 06-07, MOVIE XL 150 4T 01-01, MOVIE XL EU2 150 4T 03-04, PEOPLE 150 4T 99-00, PEOPLE EU2 150 4T 03-03

◀ cod. **9927480** **MITSUBOSHI**

Cinghia di trasmissione per motori scooter 300 cc Honda

RIFERIMENTO ORIGINALE

Honda	23100KTW901
-------	-------------

APPLICABILITÀ

HONDA FORZA 300 4T 4V 13-17, SH IE SCOOPY 300 4T-4V 07-19

◀ cod. **9927490** **MITSUBOSHI**

Cinghia di trasmissione per motori scooter 400 cc Honda

RIFERIMENTO ORIGINALE

Honda	23100MEF003
-------	-------------

APPLICABILITÀ

HONDA SILVER WING [FJS] 400 4T 06-08, SW-T [FJS] 400 4T 09-13

◀ cod. **9927500** **MITSUBOSHI**

Cinghia di trasmissione per motori scooter 125/150 cc Suzuki

RIFERIMENTO ORIGINALE

Suzuki	27601-21F11-000
--------	-----------------

APPLICABILITÀ

SUZUKI EPICURO 125 4T 99-01, UH BURGMAN K2/K6 125 4T 02-06, EPICURO 150 4T 99-01, UH BURGMAN K2/K6 150 4T 02-06

◀ cod. **9927510** **MITSUBOSHI**

Cinghia di trasmissione per motori scooter 125 cc Suzuki

RIFERIMENTO ORIGINALE

Suzuki	27601-03H00-000
--------	-----------------

APPLICABILITÀ

SUZUKI UH BURGMAN K7/L0 125 4T 07-10, UH BURGMAN L1 125 4T 11-11, UH BURGMAN L3 125 4T 13-13, UH BURGMAN L4 125 4T 14-14, UH BURGMAN L6 125 4T 16-16

MAXI SCOOTER

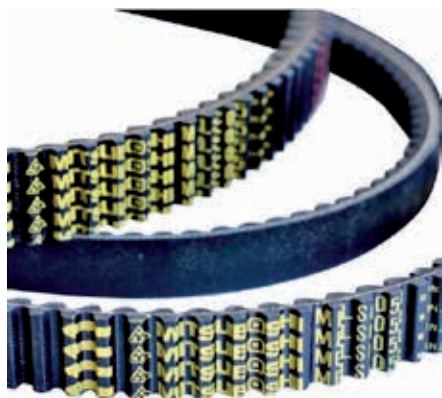

◀ cod. **9927520**  **MITSUBOSHI**
Cinghia di trasmissione per motori scooter 200 cc Suzuki

RIFERIMENTO ORIGINALE

Suzuki	27601-14F30-000
--------	-----------------

APPLICABILITÀ

SUZUKI UH BURGMAN K7/LO 200 4T 07-10, UH BURGMAN L1 200 4T 11-12, UH BURGMAN L3 200 4T 13-13, UH BURGMAN L4 200 4T 14-14

◀ cod. **9927530**  **MITSUBOSHI**
Cinghia di trasmissione per motori scooter 400 cc Yamaha

RIFERIMENTO ORIGINALE

Yamaha	SRU176410000
--------	--------------

APPLICABILITÀ

Yamaha Majesty 400 4T 04-06

◀ cod. **9927550**  **MITSUBOSHI**
Cinghia di trasmissione per motori scooter 500 cc Minarelli/Yamaha

RIFERIMENTO ORIGINALE

Yamaha	5VU176410000
--------	--------------

APPLICABILITÀ

YAMAHA T-MAX 4BS 500 4T 09-11, T-MAX 4BS ABS 500 4T 08-11, T-MAX 5GJ 500 4T 01-03, T-MAX 5VU 500 4T 04-08, T-MAX 5VU ABS 500 4T 05-07, T-MAX 5VU BLACK MAX 500 4T 06-06, T-MAX 5VU BLACK MAX - NIGHT MAX 500 4T 07-07

◀ cod. **9927630**  **MITSUBOSHI**
Cinghia di trasmissione per motori scooter 400/500 cc Piaggio

RIFERIMENTO ORIGINALE

Piaggio	832738
Piaggio	849090

Malaguti	41701600
----------	----------

APPLICABILITÀ

APRILIA ATLANTIC ARRECIFE 400 4T 05-08, ATLANTIC SPRINT 400 4T 05-08, SCARABEO LIGHT 400 4T 06-08, ATLANTIC ARRECIFE 500 4T 05-08, ATLANTIC SPRINT 500 4T 05-08, SCARABEO 500 4T 03-06, SCARABEO LIGHT 500 4T 06-08

GILERA NEXUS 500 4T 03-05, NEXUS EU3 500 4T 09-11

MALAGUTI SPIDER MAX GT 500 4T 04-05, SPIDER MAX GT EU3 500 4T 06-06, SPIDER MAX RS 500 4T 08-08

PEUGEOT GEOPOLIS IE EU3 400 4T 4V 90-02, SATELIS EU3 400 4T 07-12, GEOPOLIS IE EU3 500 4T 4V 90-02, SATELIS EU3 500 4T 90-02

PIAGGIO BEVERLY EU3 400 4T 06-07, BEVERLY TOURER EU3 400 4T 08-10, MP3 400 4T 07-08, MP3 IE LT TOURING 400 4T 11-11, MP3 IE LT/SPORT 400 4T 08-10, MP3 MIC 400 4T 08-10, MP3 RL TOURING 400 4T 11-11, X-EVO 400 4T 07-11, X8 EU3 400 4T 06-08, BEVERLY 500 4T 02-06, BEVERLY IE EU3 500 4T 06-08, X9 EVOLUTION 500 4T 03-07, X9 EVOLUTION ABS 500 4T 06-07

◀ cod. **9927640**  **MITSUBOSHI**
Cinghia di trasmissione per motori scooter Piaggio Beverly 250 cc

RIFERIMENTO ORIGINALE

Piaggio	B013360
Aprilia	B013360

Derbi	B013360
-------	---------

APPLICABILITÀ

APRILIA SCARABEO 250 4T 04-06, SCARABEO LIGHT 250 4T 06-08, SPORT CITY CUBE 250 4T 08-12, SPORT CITY EU3 250 4T 06-08, SCARABEO LIGHT 300 4T 09-10, SPORT CITY CUBE 300 4T 08-10, SPORT CITY STREET 300 4T 4V 12-12

DERBI RAMBLA 250 4T 08-09, RAMBLA EU3 2VER 250 4T 08-08, RAMBLA 300 4T 10-11

PIAGGIO BEVERLY 250 4T 05-07, BEVERLY CRUISER 250 4T 07-09, BEVERLY EURO 3 MIC 250 4T 07-07, BEVERLY IE EU3 250 4T 06-08, BEVERLY RST 250 4T 04-05, BEVERLY SPORT 250 4T 06-08, BEVERLY TOURER EU3 250 4T 07-09, CARNABY 250 4T 08-09, BEVERLY RST 4T 4V IE EU3 300 4T 10-16, BEVERLY TOURER EU3 300 4T 09-10, CARNABY CRUISER 300 4T 09-12

MAXI SCOOTER

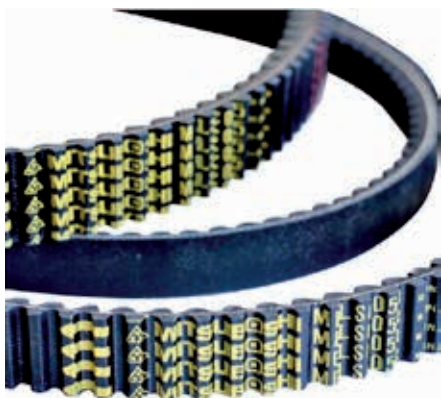

◀ cod. **9927650**  **MITSUBISHI**
Cinghia di trasmissione per motori scooter 125/150 cc Piaggio

RIFERIMENTO ORIGINALE

Piaggio	841213
Benelli	R13440941A0
Aprilia	841213

Derbi	841213
Gilera	841213

APPLICABILITÀ

APRILIA ATLANTIC 125 4T 03-05, ATLANTIC ARRECIFE 125 4T 03-05, ATLANTIC EU3 125 4T 06-08, ATLANTIC EU3 125 4T 10-12, MOJITO 125 4T 03-08, SPORT CITY ONE 4T EU3 125 4T 08-11, SR MAX 125 4T 11-14, SR MOTARD 125 4T-2V 12-14, MOJITO 150 4T 03-07

BENELLI ADIVA 125 4T 01-02, ADIVA 150 4T 01-02

DERBI BOULEVARD 125 4T 02-04, BOULEVARD 4T EU3 125 4T 08-12, BOULEVARD EU2 125 4T 04-07, GP1 EU 2 125 4T 06-06, GP1 LOW SEAT EU3 125 4T 07-08, SONAR 4T 125 4T 09-11, VARIANT SPORT 4T EU3 125 4T 12-12, BOULEVARD 150 4T 02-04, BOULEVARD 4T E3 150 4T 10-10, BOULEVARD EU3 150 4T 04-07, SONAR 4T 150 4T 09-09

GILERA DNA 125 4T 01-01, NEXUS EU3 125 4T 07-08, NEXUS IE EU3 125 4T 08-10, RUNNER 4T ST EU3 125 4T 08-16, RUNNER VX 125 4T 00-06, RUNNER VX 4T EU3 125 4T 06-07, RUNNER VX RACE 125 4T 06-06, RUNNER VX SC 125 4T 06-07

PIAGGIO FLY 125 4T 05-07, FLY EU3 125 4T 07-11, HEXAGON GTX 125 4T 00-00, LIBERTY 125 4T 01-02, LIBERTY 4T 125 4T 06-07, LIBERTY 4T 2V EURO3 125 4T 09-12, LIBERTY 4T EU3 125 4T 06-08, LIBERTY 4T EU3 DELIVERY - TNT 125 4T 08-15, LIBERTY 4T SPORT EU3 125 4T 06-08, LIBERTY RST 125 4T 04-05, LIBERTY RST PTT 125 4T 05-11, LIBERTY SPORT 125 4T 06-06, MP3 125 4T 06-08, MP3 IBRIDO 125 4T 09-10, MP3 IE 125 4T 08-09, MP3 IE TOURING 125 4T 11-12, MP3 YOURBAN ERL 125 4T 11-13, SKYPYPER 4T 125 4T 00-02, SUPER HEXAGON GTX 125 4T 01-02, TYPHOON 4T 2V E3 125 4T 10-11, VESPA ET4 125 4T 99-02, VESPA GRANTURISMO 125 4T 03-07, VESPA GRANTURISMO EU3 125 4T 06-07, VESPA GTS 4T IE SUPER 125 4T 09-16, VESPA GTS EU3 125 4T 07-12, VESPA GTV 125 4T 06-08, VESPA GTV 4T NAVY EU3 125 4T 08-08, VESPA LX 125 4T 05-06, VESPA LX 4T EU3 TOURING 125 4T 10-11, VESPA LX 4T FL 125 4T 09-09, VESPA LX EU3 125 4T 06-08, VESPA LX EU3 IE 125 4T 09-11, VESPA LXV 4T EU3 125 4T 06-09, VESPA LXV IE 4T 125 4T 10-13, VESPA LXV NAVY EU3 125 4T 07-08, VESPA S 4T EU3 125 4T 07-08, VESPA S 4T IE & COLLEGE 125 4T 09-11, X-EVO 125 4T 07-16, X7 EU3 125 4T 08-08, X7 EVO IE EU3 125 4T 09-10, X8 125 4T 04-06, X8 PREMIUM EU2 125 4T 06-06, X8 PREMIUM EU3 125 4T 06-07, X8 STREET EU2 125 4T 06-07, X9 125 4T 01-02, X9 EVOLUTION 125 4T 03-03, X9 EVOLUTION 125 4T 05-06, X9 EVOLUTION EU3 125 4T 07-07, ZIP 125 4T 00-02, FLY 150 4T 05-07, FLY EU3 150 4T 08-11, LIBERTY 150 4T 01-02, LIBERTY 4T EU3 150 4T 08-08, LIBERTY 4T SPORT EU3 150 4T 08-08, LIBERTY MOC 4T 150 4T 09-13, SKYPYPER 4T 150 4T 00-02, VESPA ET4 150 4T 99-02, VESPA LX 150 4T 05-06, VESPA LX 4T FL 150 4T 09-09, VESPA LX EU3 150 4T 06-08, VESPA LX EU3 IE 150 4T 09-11, VESPA LX TOURING 150 4T 10-12, VESPA S 4T 150 4T 08-09, VESPA S 4T IE & COLLEGE 150 4T 09-12, X8 STREET EU2 150 4T 06-08

RENAULT FULLTIME 125 4T 02-03

◀ cod. **9927660**  **MITSUBISHI**
Cinghia di trasmissione per motori scooter 400 cc Suzuki

RIFERIMENTO ORIGINALE

Suzuki	27601-05H00-000
--------	-----------------

APPLICABILITÀ

SUZUKI AN BURGMAN K7/L0 400 4T 07-10, AN BURGMAN L1 400 4T 11-11, AN BURGMAN L2 400 4T 12-12, AN BURGMAN L3 400 4T 13-13, AN BURGMAN L4 400 4T 14-14, AN BURGMAN L5 400 4T 15-15, AN BURGMAN L6 400 4T 16-16

◀ cod. **9928540**  **MITSUBISHI**
Cinghia di trasmissione per motori scooter 125/250 cc Piaggio

RIFERIMENTO ORIGINALE

Piaggio	842009
Aprilia	842009

Derbi	842009
-------	--------

APPLICABILITÀ

APRILIA SCARABEO 125 4T 03-06, SCARABEO EU3 125 4T 06-07, SPORT CITY 125 4T 04-06, SPORT CITY CUBE 125 4T 08-10, SPORT CITY EU3 125 4T 06-08, SPORT CITY STREET 125 4T 12-12, SCARABEO 150 4T 04-06

DERBI RAMBLA 125 4T 08-09, RAMBLA EU3 2VER 125 4T 08-08

PIAGGIO BEVERLY 125 4T 01-03, BEVERLY EU3 125 4T 07-08, BEVERLY EURO 3 MIC 125 4T 07-07, BEVERLY EURO 3 SPORT 125 4T 07-08, BEVERLY RST 125 4T 04-07, BEVERLY RST 4T 4V IE EU3 125 4T 10-15, BEVERLY TOURER EU3 125 4T 07-10, CARNABY 125 4T 07-10, X10 4T 4V EU3 125 4T-4V 12-15

WT MOTORS MIAMI 250 4T 11-17

MAXI SCOOTER



◀ cod. **9929770**  **MITSUBOSHI**
Cinghia di trasmissione per motori scooter 300 cc Kymco

RIFERIMENTO ORIGINALE

Kymco	00123195
-------	----------

APPLICABILITÀ

KYMCO X CITING I 300 4T 08-08, X CITING I R 300 4T 08-09

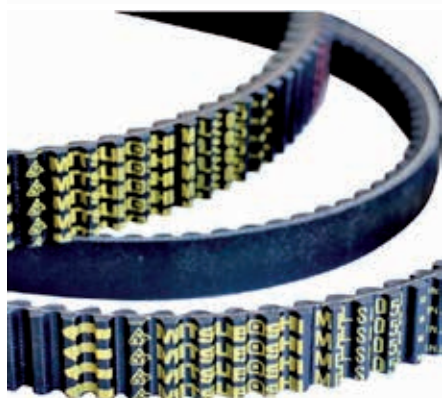

◀ cod. **9931550**  **BANDO**
Cinghia di trasmissione per motori scooter 125 cc Yamaha

RIFERIMENTO ORIGINALE

Yamaha	4CW176410200
--------	--------------

APPLICABILITÀ

MBK FLAME F 125 4T 00-00, FLAME R 125 4T 96-99, FLAME T 125 4T 95-99 **YAMAHA** CYGNUS R (XC K) 125 4T 97-98, CYGNUS R (XC) 125 4T 99-03, CYGNUS125 (XCT) 125 4T 95-98

◀ cod. **9931560**  **BANDO**

◀ cod. **9935750**  **MITSUBOSHI**
Cinghia di trasmissione per motori scooter 125 cc Yamaha

RIFERIMENTO ORIGINALE

Yamaha	5ML176410000
--------	--------------

APPLICABILITÀ

YAMAHA CYGNUS X (NXC) 125 4T 04-06, CYGNUS X IE EU3 (NXC) 125 4T 07-11

◀ cod. **9931610**

◀ cod. **9935760**  **MITSUBOSHI**
Cinghia di trasmissione per motori scooter 150 cc Yamaha

RIFERIMENTO ORIGINALE

Yamaha	52SE76410000
--------	--------------

APPLICABILITÀ

YAMAHA XC125R MAJESTY S 125 4T 14-14, XENTER 125 4T 12-17, XENTER 150 4T 12-16

◀ cod. **9931680**  **BANDO**
Cinghia di trasmissione per motori scooter 150 cc Sym

RIFERIMENTO ORIGINALE

Sym	1B01ARA01
-----	-----------

APPLICABILITÀ

SYM SYMPHONY 125 4T 09-09, SYMPHONY S 125 4T 09-10, SYMPHONY S 125 4T 12-14, SYMPHONY SR 125 4T 10-10, SYMPHONY SR 125 4T 12-12, SYMPHONY 150 4T 09-09, SYMPHONY S 150 4T 10-10, SYMPHONY S 150 4T 12-14, SYMPHONY SR 150 4T 10-10, SYMPHONY SR 150 4T 12-12

◀ cod. **9935220**  **MITSUBOSHI**
Cinghia di trasmissione per motori scooter 125/200 cc Aprilia

RIFERIMENTO ORIGINALE

Aprilia	856026
---------	--------

APPLICABILITÀ

APRILIA SCARABEO IE LIGHT 125 4T 09-12, SCARABEO LIGHT 125 4T 07-08, SCARABEO IE LIGHT 200 4T 11-12

◀ cod. **9935230**  **MITSUBOSHI**
Cinghia di trasmissione per motori scooter 600 cc BMW

RIFERIMENTO ORIGINALE

BMW	24827729767
-----	-------------

APPLICABILITÀ

BMW BMW C 600 SPORT [K18] 650 4T 11-15, BMW C 650 GT 2016 [K19] 650 4T 16-16, BMW C 650 GT [K19] 650 4T 11-15, BMW C 650 SPORT 2016 [K18] 650 4T 16-16

MAXI SCOOTER

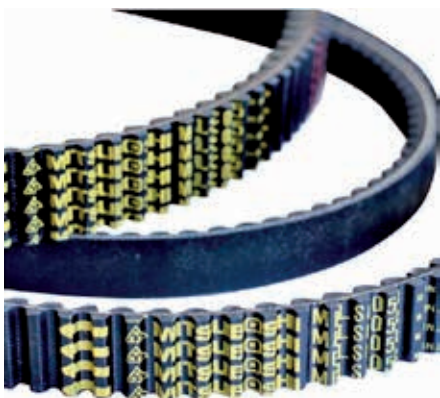

- ◀ cod. **9935250**  **MITSUBISHI**
Cinghia di trasmissione per motori scooter 600cc Honda

RIFERIMENTO ORIGINALE

Honda	23100MCT003
-------	-------------

APPLICABILITÀ

HONDA SILVER WING [FJS] 600 4T 01-10, SW-T [FJS] 600 4T 11-13

- ◀ cod. **9935260**  **MITSUBISHI**
Cinghia di trasmissione per motori scooter 125/150 cc Keeway

RIFERIMENTO ORIGINALE

Keeway	24160-J05-F000
--------	----------------

APPLICABILITÀ

KEEWAY ARN 125 4T 06-08, F-ACT 125 4T 07-08, FOCUS 125 4T 06-06, MATRIX 125 4T 06-08, ARN 150 4T 06-08, F-ACT 150 4T 07-08, FOCUS 150 4T 06-06, MATRIX 150 4T 06-08

- ◀ cod. **9935280**  **MITSUBISHI**
Cinghia di trasmissione per motori scooter 250 cc Kymco

RIFERIMENTO ORIGINALE

Kymco	23100-LLJ3-E00 (00127543)
-------	---------------------------

APPLICABILITÀ

KYMCO PEOPLE LC 250 4T 03-04, PEOPLE S 250 4T 06-06, PEOPLE S I 250 4T 07-07, X CITING 250 4T 05-05, PEOPLE S I 300 4T 08-08

- ◀ cod. **9935290**  **MITSUBISHI**
Cinghia di trasmissione per motori scooter 500cc Kymco

RIFERIMENTO ORIGINALE

Kymco	23100-LBA2-E001 (00127038)
-------	----------------------------

APPLICABILITÀ

KYMCO X CITING 500 4T 05-05, X CITING I 500 4T 06-08, X CITING I R 500 4T 07-08, X CITING R 500 4T 09-09

- ◀ cod. **9935300**  **MITSUBISHI**
Cinghia di trasmissione per motori scooter 250 cc Kymco

RIFERIMENTO ORIGINALE

Kymco	23100-LDF2-9000 (00127086)
-------	----------------------------

APPLICABILITÀ

KYMCO X CITING I 250 4T 06-07

- ◀ cod. **9935310**  **MITSUBISHI**
Cinghia di trasmissione per motori scooter 125 cc Kymco

RIFERIMENTO ORIGINALE

Kymco	23100-LFA7-E0A (00123267)
-------	---------------------------

APPLICABILITÀ

KYMCO DOWNTOWN E4 125 4T 16-16, DOWNTOWN I 125 4T 09-16, K-XCT I 125 4T 12-14, PEOPLE GTI 125 4T 10-10, PEOPLE GTI 125 4T 14-14, X-TOWN CBS 125 4T-4V 16-16

- ◀ cod. **9935320**  **MITSUBISHI**
Cinghia di trasmissione per motori scooter 300 cc Kymco

RIFERIMENTO ORIGINALE

Kymco	23100LEA7 E00 (00123257)
-------	--------------------------

APPLICABILITÀ

KYMCO DOWNTOWN ABS 300 4T 10-10, DOWNTOWN I 300 4T 09-09, DOWNTOWN I 300 4T 11-11, DOWNTOWN I ABS 300 4T 11-16, K-XCT I 300 4T 12-12, K-XCT I ABS 300 4T 14-14, PEOPLE GTI 300 4T 10-11, PEOPLE GTI 300 4T 14-14, PEOPLE GTI ABS 300 4T 12-12, PEOPLE GTI ABS 300 4T 14-14, PEOPLE GTI ABS E4 300 4T 16-16, DOWNTOWN ABS E4 350 4T 16-16, DOWNTOWN I ABS 350 4T 15-15

MAXI SCOOTER

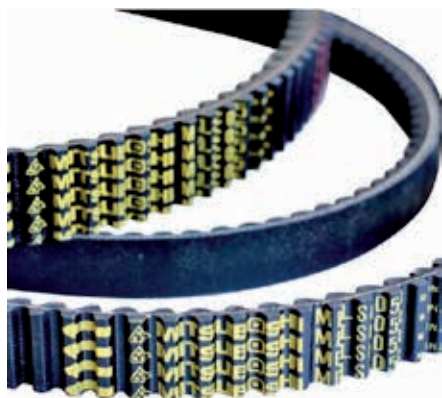

◀ **cod. 9935330**  **MITSUBOSHI**
Cinghia di trasmissione per motori scooter 200 cc Kymco

RIFERIMENTO ORIGINALE

Kymco	23100-LGF9-E0B (00123279)
-------	---------------------------

APPLICABILITÀ

KYMCO DOWNTOWN I 200 4T 10-10, PEOPLE GTI 200 4T 10-10,
PEOPLE GTI 200 4T 14-14

◀ **cod. 9935350**  **MITSUBOSHI**
CINGHIA DI TRASMISSIONE PER MOTORI SCOOTER 125 CC PEUGEOT

RIFERIMENTO ORIGINALE

Peugeot	771534
---------	--------

APPLICABILITÀ

PEUGEOT CITYSTAR 125 4T-2V 11-14, CITYSTAR LC 125 4T-4V 11-16, SATELIS 125 4T-4V 06-11, SATELIS 2 PREMIUM 125
4T-4V 12-14, SATELIS RS IE 125 4T-4V 06-11

◀ **cod. 9935360**  **MITSUBOSHI**
Cinghia di trasmissione per motori scooter 400 cc Peugeot

RIFERIMENTO ORIGINALE

Peugeot	781317
---------	--------

APPLICABILITÀ

Peugeot Metropolis 400

◀ **cod. 9935380**  **MITSUBOSHI**
Cinghia di trasmissione per motori scooter 125 cc Peugeot

RIFERIMENTO ORIGINALE

Peugeot	775218
---------	--------

APPLICABILITÀ

PEUGEOT GEOPOLIS 125 4T-4V 06-13

◀ **cod. 9935390**  **MITSUBOSHI**
Cinghia di trasmissione per motori scooter 125 cc Peugeot

RIFERIMENTO ORIGINALE

Peugeot	772816
---------	--------

APPLICABILITÀ

PEUGEOT SATELIS COMPRESSOR 125 4T-4V 06-06, CITYSTAR LC 200 4T-4V 12-15

◀ **cod. 9935400**  **MITSUBOSHI**
Cinghia di trasmissione per motori scooter 400 cc Peugeot

RIFERIMENTO ORIGINALE

Peugeot	786232
---------	--------

APPLICABILITÀ

PEUGEOT METROPOLIS 400 4T 13-16, SATELIS 400 4T 13-16

MAXI SCOOTER

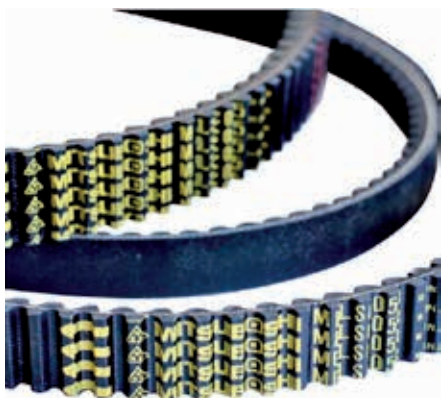

◀ cod. **9935430**  **MITSUBISHI**
Cinghia di trasmissione per motori scooter 125 cc Piaggio

RIFERIMENTO ORIGINALE

Piaggio	825059
---------	--------

APPLICABILITÀ

APRILIA MOJITO RETRO' CUSTOM 125 4T 99-01 **PIAGGIO** HEXAGON LX4 125 4T 98-99, LIBERTY 125 4T 98-00

◀ cod. **9935450**  **MITSUBISHI**
Cinghia di trasmissione per motori scooter 200 cc Piaggio

RIFERIMENTO ORIGINALE

Piaggio	842011
---------	--------

APPLICABILITÀ

APRILIA SCARABEO 200 4T 03-03, SCARABEO EU3 200 4T 06-06, SPORT CITY CUBE 200 4T 08-10, SPORT CITY EU3 200 4T 06-08 **PIAGGIO** BEVERLY 200 4T 01-03, CARNABY 200 4T 07-08

◀ cod. **9935460**  **MITSUBISHI**
Cinghia di trasmissione per motori scooter 500 cc Piaggio

RIFERIMENTO ORIGINALE

Piaggio	827826
---------	--------

APPLICABILITÀ

APRILIA ATLANTIC 500 4T 01-04 **PIAGGIO** X9 500 4T 01-02

◀ cod. **9935470**  **MITSUBISHI**
Cinghia di trasmissione per motori scooter 250 cc Piaggio

RIFERIMENTO ORIGINALE

Piaggio	82941R
---------	--------

APPLICABILITÀ

APRILIA ATLANTIC 250 4T 03-05, ATLANTIC EU3 250 4T 06-08, ATLANTIC 300 4T 10-11, SR MAX 300 4T 11-14
DERBI GP1 250 4T 06-07, GP1 LOW SEAT EU3 250 4T 07-08
GILERA NEXUS EU3 250 4T 06-07, OREGON 250 4T 06-10, NEXUS EU3 300 4T 08-11
MALAGUTI MADISON 3 250 4T 06-09, MADISON RS 250 4T 04-04, PHANTOM MAX 250 4T 04-04

PIAGGIO MP3 250 4T 06-08, MP3 LT 250 4T 08-09, MP3 MIC 250 4T 08-09, VESPA GT 60 EU3 250 4T 06-07, VESPA GTS 250 4T 05-16, VESPA GTS ABS 250 4T 05-12, VESPA GTV 250 4T 06-09, VESPA GTV 4T NAVY EU3 250 4T 07-07, X-EVO 250 4T 07-16, X7 EU3 250 4T 08-08, X8 EU3 250 4T 05-08, X9 EVOLUTION 250 4T 04-04, X9 EVOLUTION 250 4T 06-06, MP3 4T 4V IE ERL IBRIDO 300 4T-4V 10-13, MP3 4T 4V IE LT IBRIDO 300 4T 10-11, MP3 IE LT 300 4T 10-11, MP3 IE LT TOURING 300 4T 11-13, MP3 IE LT/SPORT 300 4T 11-14, MP3 IE MIC 300 4T 10-11, MP3 IE TOURING 300 4T 11-12, MP3 LT BUSINESS - SPORT ABS - ENJOY 300 4T 14-15, MP3 YOURBAN ERL 300 4T 11-15, MP3 YOURBAN LT ERL 300 4T 11-12, VESPA GTS IE & TOURING 300 4T 12-16, VESPA GTS IE TOURING 300 4T 11-12, VESPA GTS SUPER 300 4T 08-16, VESPA GTS SUPER SPORT 300 4T 10-13, VESPA GTV 4T 4V IE 300 4T 10-13, VESPA GTV VIA MONTENAPOLEONE 300 4T 10-10, X7 EVO IE EU3 300 4T 09-10

◀ cod. **9935490**  **MITSUBISHI**
Cinghia di trasmissione per motori scooter 350 cc Piaggio

RIFERIMENTO ORIGINALE

Piaggio	83025R
---------	--------

APPLICABILITÀ

PIAGGIO BEVERLY 4T 4V IE EU3 350 4T 11-14, BEVERLY 4T ST IE ABS 350 4T 16-16, X10 4T 4V IE EURO3 350 4T 12-15

◀ cod. **9935500**  **MITSUBISHI**
Cinghia di trasmissione per motori scooter 500 cc Piaggio

RIFERIMENTO ORIGINALE

Piaggio	849090
---------	--------

APPLICABILITÀ

APRILIA SCARABEO LIGHT 500 4T 06-08
GILERA FUOCO 4T-4V IE E3 LT 500 4T 13-14, FUOCO IE EU3 500 4T 07-13, NEXUS EU3 500 4T 06-08, NEXUS SP EU3 500 4T 06-07

PIAGGIO BEVERLY CRUISER 500 4T 07-12, MP3 LT BUSINESS ABS 500 4T 14-16, MP3 LT SPORT/BUSINESS 500 4T 11-13, MP3 RL SPORT-BUSINESS 500 4T 11-12, MP3 SPORT ABS 500 4T 14-16, X10 4T-4V IE EU3 500 4T 12-14

MAXI SCOOTER

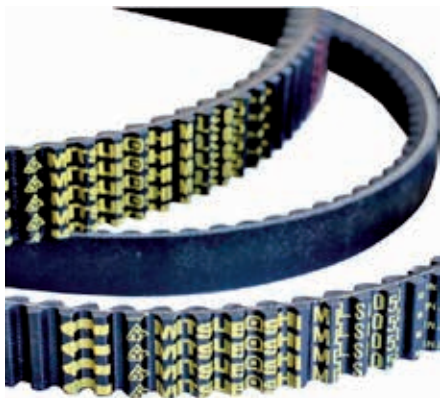

◀ cod. **9935510**  **MITSUBOSHI**
Cinghia di trasmissione per motori scooter 250 cc Suzuki

RIFERIMENTO ORIGINALE

Suzuki	27601-14F01-000
--------	-----------------

APPLICABILITÀ

SUZUKI AN BURGMAN K1/K2 250 4T 01-02, AN BURGMAN W/X/Y 250 4T 98-00

◀ cod. **9935520**  **MITSUBOSHI**
Cinghia di trasmissione per motori scooter 400 cc Suzuki

RIFERIMENTO ORIGINALE

Suzuki	27601-15F03-000
--------	-----------------

APPLICABILITÀ

SUZUKI AN BURGMAN X/K2 400 4T 99-02

◀ cod. **9935530**  **MITSUBOSHI**
Cinghia di trasmissione per motori scooter 125 cc Suzuki

RIFERIMENTO ORIGINALE

Suzuki	27601-20H00-000
--------	-----------------

APPLICABILITÀ

SUZUKI UX SIXTEEN K8/LO 150 4T 08-10, UX SIXTEEN L1 150 4T 11-11

◀ cod. **9935540**  **MITSUBOSHI**
Cinghia di trasmissione per motori scooter 150 cc Suzuki

RIFERIMENTO ORIGINALE

Suzuki	27601-20H60-000
--------	-----------------

APPLICABILITÀ

SUZUKI UX SIXTEEN K8/LO 150 4T 08-10, UX SIXTEEN L1 150 4T 11-11

◀ cod. **9935550**  **MITSUBOSHI**
Cinghia di trasmissione per motori scooter 300 cc Sym

RIFERIMENTO ORIGINALE

Sym	1B01LEA01 (23100-LEA-000)
-----	---------------------------

APPLICABILITÀ

SYM CITYCOM 300 4T-4V 08-09, CITYCOM EFI 300 4T-4V 10-11, CITYCOM I CBS 300 4T-4V 12-12

◀ cod. **9935560**  **MITSUBOSHI**
Cinghia di trasmissione per motori scooter 300 cc Sym

RIFERIMENTO ORIGINALE

Sym	1B01HWA01
-----	-----------

APPLICABILITÀ

SYM JOYMAX EVO 300 4T-4V 09-09, JOYMAX EVO I 300 4T-4V 10-10

◀ cod. **9935580**  **MITSUBOSHI**
Cinghia di trasmissione per motori scooter 400 cc Yamaha

RIFERIMENTO ORIGINALE

Yamaha	5RU176411000
--------	--------------

APPLICABILITÀ

YAMAHA MAJESTY 400 4T 07-08, MAJESTY ABS 400 4T 07-08

MAXI SCOOTER

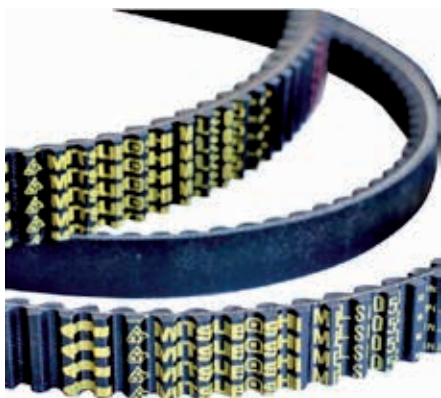

◀ cod. **9935610**  **MITSUBOSHI**
Cinghia di trasmissione per motori scooter 400 cc Yamaha

RIFERIMENTO ORIGINALE

Yamaha	34B176410000
--------	--------------

APPLICABILITÀ

YAMAHA MAJESTY 400 4T 09-11, MAJESTY ABS 400 4T 09-11

◀ cod. **9935620**  **MITSUBOSHI**
Cinghia di trasmissione per motori scooter 125 cc 4T Yamaha

RIFERIMENTO ORIGINALE

Yamaha	5NWE76410000
--------	--------------

APPLICABILITÀ

Yamaha Vity 125 cc 2008/2012

◀ cod. **9935630**  **MITSUBOSHI**
Cinghia di trasmissione per motori scooter 125 cc 4T Yamaha

RIFERIMENTO ORIGINALE

Yamaha	5S9E76410000
--------	--------------

APPLICABILITÀ

YAMAHA BW'S 4T 125 4T 10-10

◀ cod. **9935640**  **MITSUBOSHI**
Cinghia di trasmissione per motori scooter 125 cc 4T Yamaha

RIFERIMENTO ORIGINALE

Yamaha	5NWE76410000
--------	--------------

APPLICABILITÀ

Yamaha 125 Vity

◀ cod. **9935650**  **MITSUBOSHI**
Cinghia di trasmissione per motori scooter 400 cc Minarelli/Yamaha

RIFERIMENTO ORIGINALE

Yamaha	1SDE76410000
--------	--------------

APPLICABILITÀ

YAMAHA X-MAX 400 4T-4V 13-16, X-MAX ABS 400 4T-4V 14-17, X-MAX IRONMAX ABS 400 4T-4V 16-16, X-MAX MOMODESIGN 400 4T-4V 14-14, X-MAX MOMODESIGN ABS 400 4T-4V 14-14, X-MAX RA 400 4T-4V 18-18

◀ cod. **9935870**  **MITSUBOSHI**
Cinghia Honda SH 125 / 150 cc ABS DAL 2013

APPLICABILITÀ

HONDA SH I ABS 125 4T-2V 13-17, SH I ABS 150 4T-2V 13-17

◀ cod. **9935880**  **MITSUBOSHI**
Cinghia Kymco ATV 500 MXU

APPLICABILITÀ

KYMCO MXU 500 4T 05-06, MXU I RS 500 4T 10-10, UXV I 500 4T 08-08, UXV I 500 4T 10-10, MXU 700 I 700 4T 13-13

MAXI SCOOTER

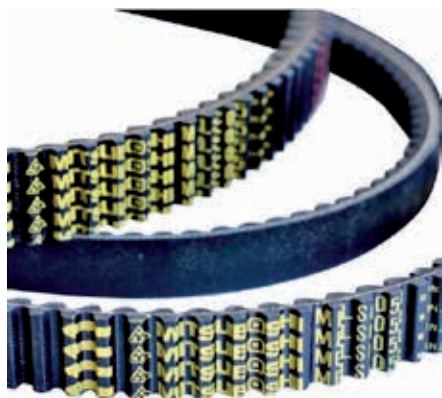

◀ cod. **9935890**  **MITSUBOSHI**
Cinghia Kymco My Road 700

APPLICABILITÀ

KYMCO MYROAD I 700 4T 11-16

◀ cod. **9935900**  **MITSUBOSHI**
Cinghia Kymco X-Citing 400 cc

APPLICABILITÀ

KYMCO X CITING I 400 4T 15-15, X CITING I ABS 400 4T 14-15, X CITING I ABS E4 400 4T 16-17, XCITING I 400 4T 13-13

◀ cod. **9935910**  **MITSUBOSHI**
Cinghia Kymco G- Dink 300 cc

APPLICABILITÀ

KYMCO G-DINK 300 4T-2V 12-12, G-DINK I ABS E4 300 4T-2V 17-17

◀ cod. **9935920**  **MITSUBOSHI**
Cinghia piaggio x9 200 - runner 200 cc

APPLICABILITÀ

APRILIA ATLANTIC 200 4T 03-05

DERBI BOULEVARD EU2 200 4T 05-06

GILERA DNA 180 4T 01-01, RUNNER VXR 180 4T 00-01, RUNNER VXR 200 4T 02-06, RUNNER VXR 4T ST EU3 200 4T 08-11, RUNNER VXR EU3 200 4T 07-07

PIAGGIO HEXAGON GTX 180 4T 00-00, SUPER HEXAGON GTX 12 180 4T 01-02, X9 AMALFI 180 4T 00-03, LIBERTY 200 4T 06-06, LIBERTY 4T EU3 200 4T 06-08, LIBERTY 4T SPORT EU3 200 4T 06-07, LIBERTY RST 200 4T 04-04, LIBERTY SPORT 200 4T 06-06, VESPA GRANTURISMO 200 4T 03-07, X8 200 4T 04-07, X9 200 4T 02-03, X9 EVOLUTION 200 4T 03-03

◀ cod. **9935930**  **MITSUBOSHI**
Cinghia Aprilia-Gilera 850 cc

APPLICABILITÀ

APRILIA MANA 850 4T-4V 07-11, MANA GT 850 4T-4V 09-16, SRV - SRV ABS ATC 850 4T-4V 12-14

GILERA GP 800 4T-4V 07-11, GP CENTENARIO 800 4T-4V 09-09

◀ cod. **9935940**  **MITSUBOSHI**
Cinghia Suzuki An125 cc

APPLICABILITÀ

Suzuki AN S-Y 125 4T 95-00

◀ cod. **9935960**  **MITSUBOSHI**
Cinghia Yamaha T- Max 530 cc

APPLICABILITÀ

YAMAHA T-MAX 59C 530 4T 12-16, T-MAX 59C ABS 530 4T 12-16, T-MAX 59C SP 530 4T 15-15, T-MAX 59C SP ABS 530 4T 15-16, XP530-A T-MAX SX 530 4T 17-19, XP530D-A T-MAX DX 530 4T 17-19, XP530E-A T-MAX 530 4T 17-18



◀ cod. **CT00725**

Collettore aspirazione motore scooter 50 cc Minarelli/Yamaha orizzontale

RIFERIMENTO ORIGINALE

Yamaha	4CUE35552000
Mbk	4CUE35552000

Malaguti	76004500
Aprilia	AP8206466



◀ cod. **CT00726**

Collettore aspirazione motore scooter 50 cc Minarelli/Yamaha verticale

RIFERIMENTO ORIGINALE

Yamaha	3VLE35552000
Mbk	3VLE35552000

Aprilia	AP8206514
---------	-----------



◀ cod. **CT00727**

Collettore aspirazione per motore scooter 50 cc Gilera/Piaggio

RIFERIMENTO ORIGINALE

Piaggio	830939
Gilera	830939

Derbi	830939
Aprilia	830939



◀ cod. **CT00728**

Collettore aspirazione per motore scooter Piaggio 125/150/180 cc

RIFERIMENTO ORIGINALE

Aprilia	AP8550171
---------	-----------

Piaggio	430206
---------	--------

APPLICABILITÀ

APRILIA SR 125 2T 99-01, SR 150 2T 99-01
GILERA RUNNER FX 125 2T 97-02, TYPHOON 125 2T 95-98, TYPHOON X-XR 125 2T 99-00, RUNNER FXR 180 2T 97-02

PIAGGIO HEXAGON 125 2T 94-97, SKYPPER 125 2T 94-97, HEXAGON 150 2T 94-97, SKYPPER 150 2T 94-97, HEXAGON LXT180 180 2T 98-99



◀ cod. **CT00729**

Collettore aspirazione per scooter YP 125cc '03

RIFERIMENTO ORIGINALE

Yamaha	5XME35850000
--------	--------------

MBK	5XME35850000
-----	--------------

APPLICABILITÀ

MBK SKYLINER E 125 4T 03-03, SKYLINER E 180 4T 03-03

YAMAHA MAJESTY E 125 4T 03-09, MAJESTY E 180 4T 03-06



◀ **cod. CT00730**
Collettore aspirazione per scooter YP 125 cc '02

RIFERIMENTO ORIGINALE

Yamaha	5DS135850000
MBK	5DS135850000

Malaguti	76005500
----------	----------

APPLICABILITÀ

BENELLI VELVET 125 4T 99-01, VELVET 150 4T 99-01
ITALJET JUPITER 125 4T 01-02, MILLENNIUM 125 4T 00-02, JUPITER 150 4T 01-02, MILLENNIUM 150 4T 00-02
MALAGUTI MADISON 125 4T 99-01, MADISON R RESTYLING 125 4T 02-02, PHANTOM MAX 125 4T 03-03, MADISON T 150 4T 99-01

MBK DOODO 125 4T 00-00, FLAME T 125 4T 95-99, SKYLINER 125 4T 98-02, THUNDER 125 4T 01-02, DOODO 150 4T 01-02, SKYLINER 150 4T 00-02, THUNDER 150 4T 01-02
YAMAHA MAJESTY 125 4T 98-00, MAJESTY (SNR1) 125 4T 01-01, MAJESTY (SNR8) 125 4T 02-02, MAXSTER 125 4T 01-02, TEO'S 125 4T 00-00, MAJESTY 150 4T 00-00, MAJESTY (SNS1) 150 4T 01-01, MAJESTY (SNS6) 150 4T 02-02, MAXSTER 150 4T 01-02, TEO'S 150 4T 01-02



◀ **cod. CT00734**
Collettore Aspirazione Piaggio Beverly 125cc'01-'03

RIFERIMENTO ORIGINALE

Aprilia	484748
Gilera	484748

Piaggio	484748
---------	--------

APPLICABILITÀ

APRILIA ATLANTIC 125 4T 03-05, SCARABEO 125 4T 03-06, SPORT CITY 125 4T 04-06, ATLANTIC 200 4T 03-05
GILERA DNA 125 4T 01-01, RUNNER VX 125 4T 00-04, DNA 180 4T 01-01, RUNNER VXR 180 4T 00-01, RUNNER VXR 200 4T 02-04

PIAGGIO BEVERLY 125 4T 01-03, HEXAGON GTX 125 4T 00-00, SUPER HEXAGON GTX 125 4T 01-02, VESPA GRANTURISMO 125 4T 03-05, X9 125 4T 01-02, X9 EVOLUTION 125 4T 03-03, X9 AMALFI 180 4T 00-03, X9 200 4T 02-03, X9 EVOLUTION 200 4T 03-03



◀ **cod. CT00735**
Collettore Aspirazione Piaggio Beverly 125/250cc'04-'07

RIFERIMENTO ORIGINALE

Aprilia	840949
Derbi	840949
Gilera	840949

Piaggio	840949
---------	--------

APPLICABILITÀ

APRILIA ATLANTIC 250 4T 03-05, SCARABEO 250 4T 04-06
DERBI GP1 EU 2 125 4T 06-06, GP1 250 4T 06-07
GILERA RUNNER 4T ST EU3 125 4T 08-16, RUNNER VX 125 4T 05-06, RUNNER VX RACE 125 4T 06-06, RUNNER VX SC 125 4T 06-07, RUNNER VXR RACE 200 125 4T 06-06, RUNNER VXR 200 4T 05-06, RUNNER VXR EU3 200 4T 07-07, OREGON 250 4T 06-10

PIAGGIO BEVERLY RST 125 4T 04-07, VESPA GRANTURISMO 125 4T 06-07, VESPA GRANTURISMO EU3 125 4T 06-07, VESPA GTV 125 4T 06-08, X8 125 4T 04-06, X8 PREMIUM EU2 125 4T 06-06, X9 EVOLUTION 125 4T 05-06, VESPA GRANTURISMO 200 4T 06-07, X8 200 4T 04-07, BEVERLY 250 4T 05-07, BEVERLY RST 250 4T 04-05, X9 EVOLUTION 250 4T 04-04, X9 EVOLUTION 250 4T 06-06



◀ **cod. CT00736**
Collettore Aspirazione Piaggio Liberty 125/150/200cc

RIFERIMENTO ORIGINALE

Aprilia	849465
Derbi	849465

Piaggio	849465
---------	--------

APPLICABILITÀ

APRILIA MOJITO 125 4T 03-08, SPORT CITY ONE 4T EU3 125 4T 08-11, SR MOTARD 125 4T-2V 12-14
DERBI BOULEVARD 125 4T 03-04, BOULEVARD 4T EU3 125 4T 08-12, BOULEVARD EU2 125 4T 04-07, SONAR 4T 125 4T 09-11, VARIANT SPORT 4T EU3 125 4T 12-12, BOULEVARD 150 4T 03-04, BOULEVARD 4T E3 150 4T 10-10, BOULEVARD EU3 150 4T 04-07, SONAR 4T 150 4T 09-09, BOULEVARD EU2 200 4T 05-06

PIAGGIO FLY 125 4T 05-07, FLY EU3 125 4T 07-11, LIBERTY 4T 125 4T 06-07, LIBERTY 4T 2V EURO3 125 4T 09-12, LIBERTY 4T EU3 DELIVERY - TINT 125 4T 08-15, LIBERTY RST 125 4T 04-05, LIBERTY SPORT 125 4T 06-06, TYPHOON 4T 2V E3 125 4T 10-11, VESPA LX 125 4T 05-06, VESPA LX EU3 125 4T 06-08, VESPA LXV 4T EU3 125 4T 06-09, X8 STREET EU2 125 4T 06-07, FLY 150 4T 05-07, FLY EU3 150 4T 08-11, LIBERTY MOC 4T 150 4T 09-13, VESPA LX 150 4T 05-06, VESPA LX EU3 150 4T 06-08, X8 STREET EU2 150 4T 06-08, LIBERTY 200 4T 06-06, LIBERTY RST 200 4T 04-04, LIBERTY SPORT 200 4T 06-06



◀ cod. **CT00737**
Collettore Aspirazione Aprilia Scarabeo 50cc 4T '09

RIFERIMENTO ORIGINALE

Aprilia	845946
Derbi	845946

Piaggio	845946
---------	--------

APPLICABILITÀ

APRILIA	SCARABEO 4T RESTYLING EU3 50 4T 06-09, SPORT CITY ONE 4T 50 4T 08-10	PIAGGIO	FLY 4T 50 4T 05-07, FLY 4T & 25-30 KM/H 50 4T 08-11, FLY 4T MOTORE CHN 50 4T 06-07, LIBERTY 4T 50 4T 05-08, LIBERTY 4T DELIVERY - SINGLE 50 4T 10-14, LIBERTY 4T DELIVERY TNT 50 4T 09-09, LIBERTY 4T PTT - DOUBLE - NEXIVE 50 4T 09-17, LIBERTY 4T SPORT 50 4T 06-08, LIBERTY MOC 4T & ELLE 50 4T 09-16, VESPA LX 4T 50 4T 05-09, ZIP 4T 50 4T 06-13
DERBI	ATLANTIS 4T EU2 50 4T 07-07, BOULEVARD 4T EU2 25KM/H 50 4T 09-09		



◀ cod. **CT00738**
Collettore Aspirazione Aprilia Scarabeo 50cc 4T '06

RIFERIMENTO ORIGINALE

Aprilia	969405
Derbi	969405

Piaggio	969405
---------	--------

APPLICABILITÀ

APRILIA	SCARABEO 4T 50 4T 02-06	PIAGGIO	LIBERTY 4T 50 4T 00-02, LIBERTY 4T RST 50 4T 04-04, VESPA ET4 50 4T 00-05, ZIP 4T 50 4T 00-05
DERBI	ATLANTIS 4T 50 4T 04-06		



◀ cod. **CT00739**
Collettore Aspirazione Piaggio Liberty 125cc '98-'00

RIFERIMENTO ORIGINALE

Piaggio	480799
---------	--------

APPLICABILITÀ

PIAGGIO	LIBERTY 125 4T 98-00, SFERA 125 4T 95-97, VESPA ET4 125 4T 96-98
----------------	--



◀ cod. **CT00740**
Collettore Aspirazione Piaggio Liberty 125cc '00-'02

RIFERIMENTO ORIGINALE

Derbi	485587
Piaggio	485587

APPLICABILITÀ

DERBI	BOULEVARD 125 4T 02-02, BOULEVARD 150 4T 02-02	PIAGGIO	LIBERTY 125 4T 01-02, SKYPPER 4T 125 4T 00-02, VESPA ET4 125 4T 99-02, ZIP 125 4T 00-02, SKYPPER 4T 150 4T 00-02, VESPA ET4 150 4T 99-02
--------------	--	----------------	--



◀ cod. **CT00741**
Collettore Aspirazione Peugeot Ludix 50cc

RIFERIMENTO ORIGINALE

Peugeot	768537
---------	--------

APPLICABILITÀ

PEUGEOT	JET C-TECH 50 2T 90-02, JET FORCE 50 2T 90-02, LUDIX 50 2T 90-02, LUDIX BLASTER 50 2T 90-02
----------------	---



◀ **cod. CT00742**
Collettore Aspirazione Kymco Agility 125/150cc R16

RIFERIMENTO ORIGINALE

Kymco	117091	Kymco	1711A-LEJ3-E10
-------	--------	-------	----------------

APPLICABILITÀ

KYMCO AGILITY R16 125 4T 08-09, SUPER 8 125 4T 08-09, AGILITY R16 150 4T 08-09



◀ **cod. CT00743**
Collettore Aspirazione Kymco Agility 50cc 4T

RIFERIMENTO ORIGINALE

Kymco	117075	Kymco	1711A-LEJ3-E10
-------	--------	-------	----------------

APPLICABILITÀ

KYMCO AGILITY 4T R12 50 4T 07-08, AGILITY R12 50 4T 05-05, AGILITY R16 50 4T 08-09, AGILITY R16 50 4T 12-12, AGILITY RS 50 4T 09-09, FILLY 50 4T 98-00, FILLY LX 50 4T 01-02, LIKE 50 4T 09-09, PEOPLE S 4T 50 4T 06-08, SUPER 8 4T 50 4T 07-07, SUPER 8 4T 50 4T 09-09, VITALITY 4T 50 4T 04-04



◀ **cod. CT00744**
Collettore aspiraz. sx Yamaha T-Max ie 500cc '04-'11

APPLICABILITÀ

YAMAHA T-MAX 4B5 500 4T 09-11, T-MAX 4B5 ABS 500 4T 08-11, T-MAX 5VU 500 4T 04-08, T-MAX 5VU ABS 500 4T 05-07, T-MAX 5VU BLACK MAX 500 4T 06-06, T-MAX 5VU BLACK MAX - NIGHT MAX 500 4T 07-07



◀ **cod. CT00745**
Collettore aspiraz. dx Yamaha T-Max ie 500cc '04-'11

APPLICABILITÀ

YAMAHA T-MAX 4B5 500 4T 09-11, T-MAX 4B5 ABS 500 4T 08-11, T-MAX 5VU 500 4T 04-08, T-MAX 5VU ABS 500 4T 05-07, T-MAX 5VU BLACK MAX 500 4T 06-06, T-MAX 5VU BLACK MAX - NIGHT MAX 500 4T 07-07



◀ **cod. CT00746**
Collettore aspiraz. AM6

APPLICABILITÀ

APRILIA CLASSIC 50 2T 92-99, MX 50 2T 04-04, MX MOTARD 50 2T 95-03, RS 50 2T 96-05, RX 50 2T 03-04, RX ENDURO 50 2T 95-03, RX RACING 50 2T 03-06, TUONO 50 2T 03-04

BETA RR 2T 50 EU4 50 2T 18-20, RR 50 RACING EU4 50 2T 18-20

CH SM 50 2T 00-10, WR 50 2T 00-10, WSM 50 2T 00-10

HUSQUARNA ENDURO 50 2T 11-11, MOTARD 50 2T 11-11

CMC CABALLERO MOTARD 50 2T 06-10, CABALLERO REGOLARITÀ 50 2T 06-10, ENDURO COMPETITION EU4 50 2T 18-20, ENDURO PERFORMANCE EU4 50 2T 18-20, MOTARD COMPETITION EU4 50 2T 18-20, MOTARD PERFORMANCE EU4 50 2T 18-20

FANTIC BAJA, DERAPAGE BASIC 50 2T 10-11, CMC 50 2T 10-11, CRE BAJA RR, DERAPAGE RR 50 2T 07-11, CRE BAJA, DERAPAGE 50 2T 07-11, CRE SIX COMPETITION 50 2T 10-11, CRE SIX, BAJA, DERAPAGE 50 2T 95-06, CRE SIX, DERAPAGE COMPETITION 50 2T 07-09, DERAPAGE COMPETITION 50 2T 10-11

HM CNK DRAGON 50 2T 05-07, XSM 50 2T 03-03, XTM 50 2T 03-03

MALAGUTI X LIMIT 50 2T 03-04, X POWER 50 2T 03-04

MBK FURIA 50 2T 97-00, FURIA MAX 50 2T 10-12, RX 50 2T 09-12, RX R 50 2T 09-12

PEUGEOT SUPERMOTARD 50 2T 90-02, XP6 TRAIL S/AVV. ELETTRICO 50 2T 90-02, XR6 RACING CAT. C/AVV.ELETT. 50 2T 90-02

RIEJU MRT 50 2T 09-12, MRT 50 EU4 50 2T 18-20, MRT PRO 50 2T 09-12, MRT PRO EU4 50 2T 18-20, MRT PRO REPLICA EU4 50 2T 18-20, MRT PRO REPLICA SM EU4 50 2T 18-20, MRT PRO SM 50 2T 09-12, MRT PRO SM EU4 50 2T 18-20, MRT SM 50 2T 09-12, MRT SM EU4 50 2T 18-20, MRT TROPHY EU4 50 2T 18-20, MRX 50 2T 01-04, MRX PRO 50 2T 01-04, RR 50 2T 05-06, RS1 50 2T 98-01, RS2 MATRIX 50 2T 05-06, RS2 MATRIX PRO 50 2T 05-06, RS2 NAKED 50 2T 04-05, RS3 EU4 50 2T 18-20, RS3 NKD EU4 50 2T 18-20, SMX E.S./K.S. 50 2T 01-01, SMX PRO E.S./K.S. 50 2T 03-03, SPIKE 50 2T 98-01

SHERCO FACTORY SE-R EU4 50 2T 18-20, FACTORY SE-RS EU4 50 2T 18-20, FACTORY SILVER SM-R EU4 50 2T 18-20, FACTORY SILVER SM-RS EU4 50 2T 18-20, FACTORY SM-R EU4 50 2T 18-20, FACTORY SM-RS EU4 50 2T 18-20, HRD ENDURO 50 2T 09-13, HRD MOTARD 50 2T 09-13

VENT BAJA 50 2T 18-20, BAJA RR 50 2T 18-20, DERAPAGE 50 2T 18-20, DERAPAGE RR 50 2T 18-20

YAMAHA DT R 50 2T 03-11, DT RSM 50 2T 03-05, DT X 50 2T 06-11, TZR 50 2T 03-08, TZR 50 2T 10-11, TZR RR 50 2T 05-05



◀ cod. **CO00001**

Convogliatore per motori scooter 50 cc Minarelli/Yamaha tipo verticale

◀ cod. **CO00002**

Convogliatore per motori scooter 50 cc Minarelli/Yamaha tipo orizzontale corto e lungo

◀ cod. **CO00003**

Cuffia convogliatore per motori scooter 50 cc Minarelli/Yamaha tipo orizzontale

◀ cod. **CO00004**

Cuffia convogliatore per motori scooter 50 cc Minarelli/Yamaha tipo verticale

KIT CUSCINETTI E PARAOLI DI BANCO



◀ cod. **KK01000**
Kit cuscinetti (Kojo) paraoli di banco scooter Minarelli/Yamaha 50 cc

◀ cod. **KK01001**
Kit cuscinetti paraoli di banco AM 345/6

◀ cod. **KK01002**
Kit cuscinetti SKF e paraoli di banco scooter Minarelli/Yamaha 50 cc

◀ cod. **KK01003**
Kit cuscinetti paraoli di banco scooter Piaggio 50 cc

◀ cod. **KK01005**
Kit cuscinetti paraoli di banco Peugeot Speedfight 50 cc

◀ cod. **KK01008**
Kit cuscinetti paraoli di banco Derbi plurimarca 50 cc

◀ cod. **KK01009**
Kit cuscinetti SKF (speciali) e paraoli di banco scooter Piaggio 50 cc



◀ cod. **KK01011**
Kit cuscinetti SKF e paraoli di banco Vespa 50/90 cc
1 paraolio BASF 22,7x47,05x7,5 - 1 paraolio BAB 19x32x7 - 1 cuscinetto 20x47x14 (6204) - 1 cuscinetto 17x47x14 (6303)

◀ cod. **KK01012**
Kit cuscinetti SKF e paraoli di banco Vespa PK XL 50 cc Ape 50 cc
1 paraolio BA 20x32x70 - 1 paraolio BASF 22,7x47,05x7,5 - 1 cuscinetto 20x47x14 (6204) - 1 cuscinetto 17x47x14 (6303)

KIT CUSCINETTI E PARAOLI DI BANCO



◀ cod. **KK01013**
Kit cuscinetti paraoli di banco Kymco 50 cc 2T



◀ cod. **KK01006**
Kit cuscinetti paraoli di banco Suzuki Burgman 250/400 cc

APPLICABILITÀ

SUZUKI EPICURO 125 4T 99-01, UH BURGMAN K2/K6 125 4T 02-06, UH BURGMAN K7/LO 125 4T 07-10, UX SIXTEEN K8/LO 125 4T 08-10, EPICURO 150 4T 99-01, UH BURGMAN K2/K6 150 4T 02-06, UX SIXTEEN K8/LO 150 4T 08-10, UH BURGMAN K7/LO 200 4T 07-10, AN BURGMAN K3/K6 250 4T 03-06, AN BURGMAN K3/K6 400 4T 03-06, AN BURGMAN K7/LO 400 4T 07-10, AN BURGMAN X/K2 400 4T 99-02

◀ cod. **KK01007**
Kit cuscinetti paraoli di banco Yamaha Majesty 250/300 cc

APPLICABILITÀ

APRILIA	LEONARDO 250 4T 99-04, LEONARDO ST 250 4T 01-01, LEONARDO 300 4T 02-04	MBK	SKYLINER 250 4T 00-03, SKYLINER ABS 250 4T 03-03, KILIBRE 300 4T 03-06
BENELLI	VELVET 250 4T 99-03	YAMAHA	MAJESTY 250 4T 96-03, MAJESTY ABS 250 4T 03-03, MAJESTY DX 250 4T 98-99, X-CITY 250 4T 07-15, X-MAX 250 4T 05-16, X-MAX ABS 250 4T 14-15, VERSITY 300 4T 03-06
ITALJET	JUPITER 250 4T 00-02		
MALAGUTI	MADISON S 250 4T 99-01, PASSWORD 250 4T 05-06, PASSWORD EU3 250 4T 07-08		

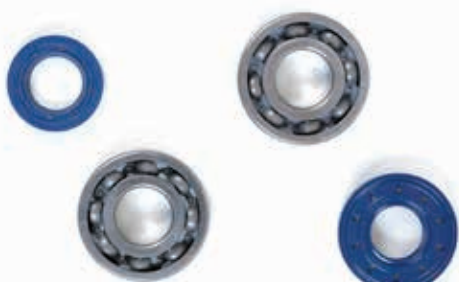

◀ cod. **KK01010**
Kit cuscinetti paraoli di banco Minarelli/Yamaha 125/150/180 cc

APPLICABILITÀ

BENELLI	VELVET 125 4T 99-01, VELVET 150 4T 99-01	MBK	DOODO 125 4T 00-00, SKYLINER 125 4T 98-02, SKYLINER E 125 4T 03-03, THUNDER 125 4T 01-02, DOODO 150 4T 01-02, SKYLINER 150 4T 00-02, THUNDER 150 4T 01-02, SKYLINER E 180 4T 03-03
ITALJET	JUPITER 125 4T 01-02, MILLENNIUM 125 4T 00-02, JUPITER 150 4T 01-02, MILLENNIUM 150 4T 00-02	YAMAHA	MAJESTY 125 4T 98-00, MAJESTY (5NR1) 125 4T 01-01, MAJESTY (5NR8) 125 4T 02-02, MAJESTY E 125 4T 03-09, MAXSTER 125 4T 01-02, TEO'S 125 4T 00-00, MAJESTY 150 4T 00-00, MAJESTY (5NS1) 150 4T 01-01, MAJESTY (5NS6) 150 4T 02-02, MAXSTER 150 4T 01-02, TEO'S 150 4T 01-02, MAJESTY E 180 4T 03-06
MALAGUTI	MADISON 125 4T 99-01, MADISON R RESTYLING 125 4T 02-02, MADISON R RESTYLING EU2 125 4T 03-04, PHANTOM MAX 125 4T 03-03, MADISON T 150 4T 99-01		



◀ cod. **KF00050**
Alberi cambio **Vespa**
sigla: 6200
misure: 10x30x9

◀ cod. **KF00100**
Mozzi ciclomotore
sigla: 6201
misure: 12x32x10

◀ cod. **KF00150**
Tamburo **PX**
sigla: 6201/ZZ
misure: 12x32x10

◀ cod. **KF00200**
sigla: 6004
misure: 20x42x12

◀ cod. **KF00250**
Piaggio 102258
sigla: 6202
misure: 15x35x11

◀ cod. **KF00350**
Schermato
sigla: 6202/ZZ
misure: 15x35x11

◀ cod. **KF00450**
Piaggio banco frizione -
banco **Minarelli P4 - RV - GL - DL**
sigla: 6203
misure: 17x40x12

◀ cod. **KF00550**
Piaggio banco volano
sigla: 6204
misure: 20x47x14

◀ cod. **KF00600**
sigla: 6204/C3
misure: 20x47x14

◀ cod. **KF01000**
Lato trazione **Vespa** 50/90/125 cc
sigla: 6303
misure: 17x47x14

◀ cod. **KF01050**
sigla: 6303/C3
misure: 17x47x14

◀ cod. **KF01150**
Lato trazione **Lambretta**
sigla: 6305
misure: 25x62x17

◀ cod. **KF01450**
Campana frizione **Vespa** 50 cc/ET3
sigla: 16005
misure: 25x47x8

◀ cod. **KF01460**
Pompa acqua scooter
Minarelli/Yamaha 50 cc
sigla: 608-2RS1-C3
misure: 8x22x7

◀ cod. **KF01500**
Suzuki Burgman 250/400 cc
sigla: 6207
misure: 35x72x17

◀ cod. **KF05000**
Banco tutti i modelli scooter
Minarelli/Yamaha 50 cc
sigla: 6204TN9/C3
misure: 20x47x14

◀ cod. **KF05010**
Banco **P4 - RV - GL - DL**
sigla: 6203TN9/C3
misure: 17x40x12

◀ cod. **KF05020**
Albero frizione scooter **F10**
sigla: 6003TN9/C3
misure: 17x35x10

◀ cod. **KF05030**
Lato trazione **Vespa** 50/90/125 cc
sigla: 6303TN9/C3
misure: 17x47x14

◀ cod. **KF05040**
sigla: 6202TN9/C3
misure: 15x35x11



◀ cod. **KF05050**

Albero motore **Sfera**
sigla: BB1B447205A
misure: 20x52x12

◀ cod. **KF05060**

sigla: 6204TN9/C4
misure: 20x47x14

◀ cod. **KF05070**

Albero motore **Piaggio**
sigla: BB1-3055 B

◀ cod. **KF05080**

sigla: 6202 2RSH
misure: 15x35x11

◀ cod. **KF05090**

sigla: 61901 2RS1
misure: 12x24x6

◀ cod. **KF05100**

sigla: 6203/C3
misure: 17x40x12

◀ cod. **KF05110**

sigla: 6200/C3
misure: 10x30x9

◀ cod. **KF05120**

sigla: 6000-2RSH
misure: 10x26x8

◀ cod. **KF05130**

sigla: 6200-2RSH
misure: 10x30x9

◀ cod. **KF05140**

sigla: 6300-2RSH
misure: 10x35x11

◀ cod. **KF05150**

sigla: 6001-2RSH
misure: 12x28x8

◀ cod. **KF05160**

sigla: 6201/C3
misure: 12x32x10

◀ cod. **KF05170**

sigla: 6201-2RSH
misure: 12x32x10

◀ cod. **KF05180**

sigla: 6201-2RSH/C3
misure: 12x32x10

◀ cod. **KF05190**

sigla: 6301-2RSH
misure: 12x37x12

◀ cod. **KF05200**

sigla: 61902-2RS1
misure: 15x28x7

◀ cod. **KF05210**

sigla: 6002-2RSH
misure: 15x32x9

◀ cod. **KF05220**

sigla: 6202/C3
misure: 15x35x11

◀ cod. **KF05230**

sigla: 6202/C4
misure: 15x35x11

◀ cod. **KF05240**

sigla: 6202-RSH
misure: 15x35x11



◀ cod. **KF05250**
sigla: 6202-2RSH/C3
misure: 15x35x11

◀ cod. **KF05350**
sigla: 6303-2RSH
misure: 17x47x14

◀ cod. **KF05260**
sigla: 6302
misure: 15x42x13

◀ cod. **KF05360**
sigla: 6303-2RSH/C3
misure: 17x47x14

◀ cod. **KF05270**
sigla: 6302/C3
misure: 15x42x13

◀ cod. **KF05370**
sigla: 61904-2RS1
misure: 20x37x9

◀ cod. **KF05280**
sigla: 6302-2RSH
misure: 15x42x13

◀ cod. **KF05380**
sigla: 6004/C3
misure: 20x42x12

◀ cod. **KF05290**
sigla: 6302-2RSH/C3
misure: 15x42x13

◀ cod. **KF05390**
sigla: 6004-2RSH
misure: 20x42x12

◀ cod. **KF05300**
sigla: 6003-2RSH
misure: 17x35x10

◀ cod. **KF05400**
sigla: 6204/C5
misure: 20x47x14

◀ cod. **KF05310**
sigla: 6003-2RSH/C3
misure: 17x35x10

◀ cod. **KF05410**
sigla: 6204-2RSH
misure: 20x47x14

◀ cod. **KF05320**
sigla: 6203-2RSH
misure: 17x40x12

◀ cod. **KF05420**
sigla: 6204-2RSH/C3
misure: 20x47x14

◀ cod. **KF05330**
sigla: 6203-2RSH/C3
misure: 17x40x12

◀ cod. **KF05430**
sigla: 6204 TN9/C4H LHT23
misure: 20x47x14

◀ cod. **KF05340**
sigla: 6303/C4
misure: 17x47x14

◀ cod. **KF05440**
sigla: 6304/C3
misure: 20x52x15



◀ cod. **KF05450**
sigla: 6304-2RSH
misure: 20x52x15

◀ cod. **KF05460**
sigla: 6304 TN9/C4
misure: 20x52x15

◀ cod. **KF05470**
sigla: 61905-2RS1
misure: 25x42x9

◀ cod. **KF05480**
sigla: 6005-2RSH
misure: 25x47x12

◀ cod. **KF05490**
sigla: 6005-2RSH/C3
misure: 25x47x12

◀ cod. **KF05500**
sigla: BB1-3056 C
misure: 25x52x13

◀ cod. **KF05510**
sigla: 6205/C3
misure: 25x52x15

◀ cod. **KF05520**
sigla: 6205-2RSH
misure: 25x52x15

◀ cod. **KF05530**
sigla: 6205-2RSH/C3
misure: 25x52x15

◀ cod. **KF05540**
sigla: 6205 ETN9/C4
misure: 25x52x15

◀ cod. **KF05550**
sigla: BB1-0855
misure: 25x62x12

◀ cod. **KF05560**
sigla: 6305/C3
misure: 25x62x17

◀ cod. **KF05570**
sigla: 6305/C5
misure: 25x62x17

◀ cod. **KF05580**
sigla: 6305 TN9/C4
misure: 25x62x17

◀ cod. **KF05590**
sigla: 6206/C4
misure: 30x62x16

◀ cod. **KF05600**
sigla: 6206 TN9/C3
misure: 30x62x16

◀ cod. **KF05610**
sigla: 6206 TN9/C4H
misure: 30x62x16

◀ cod. **KF05620**
sigla: 608-2RSH/C3 LHT23
misure: 8x22x7

◀ cod. **KF05630**
sigla: 6207/C3
misure: 32x72x17



◀ **cod. NT06001**
 sigla: 6304C3
 misure: 20x52x15
APPLICABILITÀ: Carter Motore
RIFERIMENTO ORIGINALE

Yamaha	933063042100
MBK	933063042100

◀ **cod. NT06008**
 sigla: 608LLUC3/5K
 misure: 8x22x7
APPLICABILITÀ: Pompa Acqua
RIFERIMENTO ORIGINALE

Beta	1293388000
------	------------

◀ **cod. NT06002**
 sigla: SC04A31CS34Px1/2ASQF
 misure: 20x47x12
APPLICABILITÀ: Albero Motore
RIFERIMENTO ORIGINALE

Honda	91001-GM4-0331
-------	----------------

◀ **cod. NT06009**
 sigla: SF05A26Px1
 misure: 26x47x15
APPLICABILITÀ: Cuscinetto Sterzo
RIFERIMENTO ORIGINALE

Honda	91015-KV6-0030
-------	----------------

◀ **cod. NT06003**
 sigla: TMB204CCS24-1
 misure: 20x47x14
APPLICABILITÀ: Trasmissione
RIFERIMENTO ORIGINALE

Piaggio	82990R
Piaggio	833701

◀ **cod. NT06010**
 sigla: 6206C3
 misure: 30x62x16
APPLICABILITÀ: Carter Motore
RIFERIMENTO ORIGINALE

Yamaha	933062062700
MBK	933062062700

◀ **cod. NT06004**
 sigla: 63/22C3
 misure: 22x56x16
APPLICABILITÀ: Carter Motore
RIFERIMENTO ORIGINALE

Cagiva	800088828	Yamaha	933063720700
MBK	933063720400	Yamaha	993063720300
Yamaha	933063720400		

◀ **cod. NT06011**
 sigla: 6005
 misure: 25x47x12
APPLICABILITÀ: Scatola Ingranaggi
RIFERIMENTO ORIGINALE

Cagiva	751132566
Ducati	751132566
Peugeot	753581

◀ **cod. NT06006**
 sigla: 6303U1
 misure: 17x47x14
APPLICABILITÀ: Trasmissione
RIFERIMENTO ORIGINALE

MBK	933063021200	Yamaha	93306302Y800
Yamaha	933063021200	MBK	933063030200
MBK	93306302Y800	Yamaha	933063030200

◀ **cod. NT06012**
 sigla: 6204T2x3C4
 misure: 20x47x14
APPLICABILITÀ: Carter Motore
RIFERIMENTO ORIGINALE

Kymco	00109225	Malaguti	75106600
Malaguti	10403400	MBK	93306204X200
Italjet	337126018	Yamaha	93306204X200
Italjet	4405102459	MBK	93306204X700
Malaguti	60322800	Yamaha	93306204X700
Malaguti	75105000		

◀ **cod. NT06007**
 sigla: 6006LLUC3/2A
 misure: 30x55x13
APPLICABILITÀ: Ruota
RIFERIMENTO ORIGINALE

Suzuki	08133-60067-000	Aprilia	82659R
Ducati	751623075	Piaggio	82659R

◀ **cod. NT06013**
 sigla: 6301C3
 misure: 12x37x12
APPLICABILITÀ: Carter Motore
RIFERIMENTO ORIGINALE

Italjet	5301510
Sym	961006301300



◀ cod. **NT06014**

sigla: 6303LLUC3/5K
misure: 17x47x14

APPLICABILITÀ: Trasmissione

RIFERIMENTO ORIGINALE

MBK	933062030600	MBK	933063031700
Yamaha	933062030600	Yamaha	933063031700

◀ cod. **NT06020**

sigla: 6201
misure: 12x32x10

APPLICABILITÀ: Trasmissione

RIFERIMENTO ORIGINALE

Kymco	00108211	Italjet	337126016
Italjet	210478261	Malaguti	60324300
Italjet	3341120	Peugeot	706433

◀ cod. **NT06015**

sigla: 6203
misure: 17x40x12

APPLICABILITÀ: Carter Motore

RIFERIMENTO ORIGINALE

Ducati	70240331A
--------	-----------

◀ cod. **NT06021**

sigla: 6205C3
misure: 25x52x15

APPLICABILITÀ: Carter Motore

RIFERIMENTO ORIGINALE

Beta	1295610000	MBK	933063042100
Italjet	3340413	Yamaha	933063042100
Peugeot	724646	MBK	933063044200
MBK	933062052900	Yamaha	933063044200
Yamaha	933062052900		

◀ cod. **NT06016**

sigla: 16005
misure: 25x47x8

APPLICABILITÀ: Scatola Ingranaggi

RIFERIMENTO ORIGINALE

Derbi	007130
Piaggio	007130

◀ cod. **NT06022**

sigla: 6201ZZ/5K
misure: 12x32x10

RIFERIMENTO ORIGINALE

Italjet	5301011
---------	---------

◀ cod. **NT06017**

sigla: 6201C3
misure: 12x32x10

APPLICABILITÀ: Carter Motore

RIFERIMENTO ORIGINALE

Beta	1293456000
------	------------

◀ cod. **NT06023**

sigla: 6302U1
misure: 15x42x13

APPLICABILITÀ: Carter Motore

RIFERIMENTO ORIGINALE

Kymco	00121011	Peugeot	737884
Suzuki	08110-63020-000	Malaguti	75109600
Italjet	5301521	Malaguti	95100900

◀ cod. **NT06018**

sigla: TMB206JR2C3
misure: 30x62x16

APPLICABILITÀ: Albero Motore

RIFERIMENTO ORIGINALE

KTM	0625060206
-----	------------

◀ cod. **NT06024**

sigla: TM-Sx07E39C4
misure: 35x72x17

APPLICABILITÀ: Albero Motore

RIFERIMENTO ORIGINALE

KTM	0625062071
Beta	1299700000

◀ cod. **NT06019**

sigla: 62/22CM
misure: 22x50x14

APPLICABILITÀ: Trasmissione

RIFERIMENTO ORIGINALE

Moto Guzzi	3GAN000051
Italjet	4875102529
Peugeot	755439

◀ cod. **NT06025**

sigla: 6205CC3
misure: 25x52x15

APPLICABILITÀ: Carter Motore

RIFERIMENTO ORIGINALE

Ducati	751202567
--------	-----------



◀ **cod. NT06026**

sigla: 6200C3
misure: 10x30x9

APPLICABILITÀ: Ruota

RIFERIMENTO ORIGINALE

Italjet	3351107
Malaguti	75104700
Honda	96140-620-000

◀ **cod. NT06032**

sigla: 4T-CR-0643L
misure: 30x52x16

APPLICABILITÀ: Cuscinetto Sterzo

RIFERIMENTO ORIGINALE

Suzuki	09265-30014-000
--------	-----------------

◀ **cod. NT06027**

sigla: 6000ZZ/5K
misure: 10x26x8

RIFERIMENTO ORIGINALE

Honda	91051-Z0H-AJ000
-------	-----------------

◀ **cod. NT06033**

sigla: 6002LLU/5K
misure: 15x32x9

APPLICABILITÀ: Ruota

RIFERIMENTO ORIGINALE

Kymco	00121714	Yamaha	93306002Y000
MBK	933060020100	Italjet	9510803
Yamaha	933060020100		

◀ **cod. NT06028**

sigla: SC04A73C3
misure: 22x56x15

APPLICABILITÀ: Scatola Ingranaggi

RIFERIMENTO ORIGINALE

Suzuki	09262-22023-000
--------	-----------------

◀ **cod. NT06034**

sigla: 6205LLUC3/5K
misure: 25x52x15

APPLICABILITÀ: Ruota

RIFERIMENTO ORIGINALE

MBK	933060780600	MBK	933062056700
Yamaha	933060780600	Yamaha	933062056700

◀ **cod. NT06029**

sigla: 6203C3
misure: 17x40x12

APPLICABILITÀ: Carter Motore

RIFERIMENTO ORIGINALE

Kymco	00108019	Italjet	7500047
Italjet	4405102059	Ducati	751201747

◀ **cod. NT06035**

sigla: SF0649Px1
misure: 30x55x17

APPLICABILITÀ: Cuscinetto Sterzo

RIFERIMENTO ORIGINALE

Honda	91016-MB4-7710M1
-------	------------------

◀ **cod. NT06030**

sigla: 63/28C3
misure: 28x68x18

APPLICABILITÀ: Carter Motore

RIFERIMENTO ORIGINALE

Ducati	70240243A
--------	-----------

◀ **cod. NT06036**

sigla: 3TM-Sx06C62CS44
misure: 30x72x16

APPLICABILITÀ: Albero Motore

RIFERIMENTO ORIGINALE

Honda	91001-KRN-6710M1
-------	------------------

◀ **cod. NT06031**

sigla: 6203LLUC3/5K
misure: 17x40x12

RIFERIMENTO ORIGINALE

Italjet	9511106
---------	---------

◀ **cod. NT06037**

sigla: 8E-NK39x58x16-2Px1
misure: 39x58x16

APPLICABILITÀ: Biella

RIFERIMENTO ORIGINALE

Honda	91002-KRN-6710M1
-------	------------------



◀ cod. **NT06038**
 sigla: TM-Sx06C42CS44
 misure: 30x72x19
APPLICABILITÀ: Albero Motore
RIFERIMENTO ORIGINALE

Honda	91001-MBE-6710M1
-------	------------------

◀ cod. **NT06044**
 sigla: SF07A17Px1
 misure: 35x55x14,5
APPLICABILITÀ: Cuscinetto Sterzo
RIFERIMENTO ORIGINALE

Ducati	70240041A
Honda	91016-MR7-0031

◀ cod. **NT06039**
 sigla: 6004LLUC3/5K
 misure: 20x42x12
APPLICABILITÀ: Albero Motore
RIFERIMENTO ORIGINALE

Honda	91009-GEO-004
-------	---------------

◀ cod. **NT06045**
 sigla: 16001JRx
 misure: 12x28x7
APPLICABILITÀ: Scatola Ingranaggi
RIFERIMENTO ORIGINALE

KTM	0625160011
-----	------------

◀ cod. **NT06040**
 sigla: 6005LLUC3/5K
 misure: 25x47x12
APPLICABILITÀ: Ruota
RIFERIMENTO ORIGINALE

Derbi	56205
-------	-------

◀ cod. **NT06046**
 sigla: 6200LLU/5K
 misure: 10x30x9
APPLICABILITÀ: Ruota
RIFERIMENTO ORIGINALE

Italjet	3343003	MBK	933062000900
Italjet	5301015	Yamaha	933062000900

◀ cod. **NT06041**
 sigla: 6304JR2/22CS36
 misure: 22x52x15
APPLICABILITÀ: Carter Motore
RIFERIMENTO ORIGINALE

Beta	1299100000
------	------------

◀ cod. **NT06047**
 sigla: 63/22C4
 misure: 22x56x16
APPLICABILITÀ: Carter Motore
RIFERIMENTO ORIGINALE

Honda	91002-KY4-901
-------	---------------

◀ cod. **NT06042**
 sigla: 3TM-SC04C27CS40
 misure: 20x60x13
APPLICABILITÀ: Albero Motore
RIFERIMENTO ORIGINALE

Piaggio	82671R
---------	--------

◀ cod. **NT06048**
 sigla: 6305JR2CS36
 misure: 25x62x17
APPLICABILITÀ: Albero Motore
RIFERIMENTO ORIGINALE

KTM	0625063055
-----	------------

◀ cod. **NT06043**
 sigla: 8E-NK39x65x18-3
 misure: 39x65x18
APPLICABILITÀ: Biella
RIFERIMENTO ORIGINALE

Honda	91002-MEB-6710M1
-------	------------------

◀ cod. **NT06049**
 sigla: NJ206ET2xCS46
 misure: 30x62x16
APPLICABILITÀ: Motore
RIFERIMENTO ORIGINALE

KTM	50330082000
-----	-------------



◀ **cod. NT06050**

sigla: 6204LLU/5K
misure: 20x47x14

APPLICABILITÀ: Ruota
RIFERIMENTO ORIGINALE

Italjet	3341130
MBK	933062046000
Yamaha	933062046000

◀ **cod. NT06056**

sigla: SF0581Px1
misure: 26x47x15

APPLICABILITÀ: Cuscinetto Sterzo
RIFERIMENTO ORIGINALE

Honda	91015MB4771
-------	-------------

◀ **cod. NT06051**

sigla: 6303LLU/5K
misure: 17x47x14

RIFERIMENTO ORIGINALE

Italjet	210432305
---------	-----------

◀ **cod. NT06057**

sigla: SC04B19CS30Px1/3AS
misure: 20x56x12

APPLICABILITÀ: Albero Motore
RIFERIMENTO ORIGINALE

Honda	91005GW3961
-------	-------------

◀ **cod. NT06052**

sigla: 6305C3
misure: 25x62x17

APPLICABILITÀ: Carter Motore
RIFERIMENTO ORIGINALE

Cagiva	800016794
MBK	933063053600
Yamaha	933063053600

◀ **cod. NT06058**

sigla: TM-SC03A39CS20
misure: 17x42x13

APPLICABILITÀ: Albero Motore
RIFERIMENTO ORIGINALE

Piaggio	96925R
---------	--------

◀ **cod. NT06053**

sigla: TMB207x46JR2CS32-2Px35

RIFERIMENTO ORIGINALE

Honda	91006-KGF-9110
-------	----------------

◀ **cod. NT06059**

sigla: 6303C3
misure: 17x47x14

APPLICABILITÀ: Albero Motore
RIFERIMENTO ORIGINALE

Italjet	337126019
---------	-----------

◀ **cod. NT06054**

sigla: 6204LLUC3/5K
misure: 20x47x14

APPLICABILITÀ: Ruota
RIFERIMENTO ORIGINALE

Italjet	210434735	MBK	933062042200
Italjet	337126017	Yamaha	933062042200
Malaguti	60324400	MBK	933062044600-M
Husqvarna	800015659	Yamaha	933062044600
MBK	933062004Y400	MBK	933062045800
MBK	933062041700	MBK	933062046100
Yamaha	933062041700	MBK	933062046900
MBK	933062042000	Yamaha	93306204Y400
Yamaha	933062042000	MBK	93306204YH00
MBK	933062042100	Yamaha	93306204YH00-

◀ **cod. NT06060**

sigla: 6203LLU/5K
misure: 17x40x12

APPLICABILITÀ: Trasmissione
RIFERIMENTO ORIGINALE

MBK	93306203Y800
Yamaha	93306203Y800

◀ **cod. NT06055**

sigla: SF07A22Px1
misure: 35x55x14,5

APPLICABILITÀ: Cuscinetto Sterzo
RIFERIMENTO ORIGINALE

Piaggio	8110077
Aprilia	AP8110077

◀ **cod. NT06061**

sigla: 6201LLU/5K
misure: 12x32x10

APPLICABILITÀ: Distribuzione
RIFERIMENTO ORIGINALE

Malaguti	11941100
Ducati	751661238



◀ cod. **NT06062**

sigla: 6302LLU/5K
misure: 15x42x13

APPLICABILITÀ: Ruota

RIFERIMENTO ORIGINALE

MBK	933063020200	MBK	933063021200
Yamaha	933063020200	Yamaha	933063021200

◀ cod. **NT06068**

sigla: 6202C3
misure: 15x35x11

APPLICABILITÀ: Carter Motore

RIFERIMENTO ORIGINALE

Peugeot	722669
Honda	961006202300

◀ cod. **NT06063**

sigla: 6004LLU/5K
misure: 20x42x12

APPLICABILITÀ: Ruota

RIFERIMENTO ORIGINALE

Italjet	5302008
Cagiva	800039651

◀ cod. **NT06069**

sigla: 6202LLUC3/5K
misure: 15x35x11

APPLICABILITÀ: Ruota

RIFERIMENTO ORIGINALE

Beta	1294005000	MBK	933062020500
Derbi	58020200	Yamaha	933062020500
Peugeot	750578	Yamaha	933062020900
MBK	9330620203BL	MBK	933062022600
Yamaha	9330620203BL	Yamaha	933062022600
MBK	933062020400	Yamaha	933062020400
Yamaha	933062020400		

◀ cod. **NT06064**

sigla: 6201LLUC3/5K
misure: 12x32x10

APPLICABILITÀ: Ruota

RIFERIMENTO ORIGINALE

Italjet	5301012
Ducati	70250161A
Honda	961406200010

◀ cod. **NT06070**

sigla: TM-SC07A87CS32Px11
misure: 35x72x15

APPLICABILITÀ: Albero Motore

RIFERIMENTO ORIGINALE

Honda	91005KGF911
-------	-------------

◀ cod. **NT06065**

sigla: 6204C3
misure: 20x47x14

APPLICABILITÀ: Carter Motore

RIFERIMENTO ORIGINALE

Italjet	337126018	MBK	93306204Y00
Cagiva	738220425	Yamaha	93306204Y00
Husqvarna	800085380	Yamaha	933063043900
Yamaha	933062045400	MBK	933063044200
MBK	933062046100	Yamaha	933063044200
Yamaha	933062046100	Italjet	9510208
Yamaha	933062046800		

◀ cod. **NT06071**

sigla: 6204JR2C4
misure: 20x47x14

APPLICABILITÀ: Carter Motore

RIFERIMENTO ORIGINALE

KTM	0625062041
Beta	1298501000
Italjet	4405102459

◀ cod. **NT06066**

sigla: SC05B61CS35Px1/2AS
misure: 25x56x12

APPLICABILITÀ: Albero Motore

RIFERIMENTO ORIGINALE

Honda	961006202300
-------	--------------

◀ cod. **NT06072**

sigla: 3TM-SC05B31CS37
misure: 25x68x12

APPLICABILITÀ: Albero Motore

RIFERIMENTO ORIGINALE

Piaggio	483970
---------	--------

◀ cod. **NT06067**

sigla: 6202LLU/5K
misure: 15x35x11

APPLICABILITÀ: Ruota

RIFERIMENTO ORIGINALE

Moto Guzzi	92230320
------------	----------

◀ cod. **NT06073**

sigla: SC04A47CS29Px1
misure: 20x52x12

APPLICABILITÀ: Albero Motore

RIFERIMENTO ORIGINALE

Piaggio	431125
Peugeot	722483



◀ cod. **NT06074**
sigla: 6200U1

◀ cod. **NT06082**
sigla: 6301LLU/5K

◀ cod. **NT06075**
sigla: 4T-30205

◀ cod. **NT06083**
sigla: SC05A12

◀ cod. **NT06076**
sigla: 4T-320/28x

◀ cod. **NT06084**
sigla: 6204
misure: 20x47x14
APPLICABILITÀ: Carter Motore
RIFERIMENTO ORIGINALE

Suzuki	09262-20069-000
Suzuki	09262-20121-000

◀ cod. **NT06077**
sigla: 4T-32006x

◀ cod. **NT06086**
sigla: 6302LLUC3/5K

◀ cod. **NT06078**
sigla: 4T-32007x

◀ cod. **NT06087**
sigla: 6000LLU/5K
APPLICABILITÀ: Distribuzione
RIFERIMENTO ORIGINALE

Yamaha	933063042100
MBK	933063042100

◀ cod. **NT06079**
sigla: 60/22LLU/5K

◀ cod. **NT06088**
sigla: 6003LLUC3/5K
misure: 17x35x10
RIFERIMENTO ORIGINALE

Suzuki	24123-89010-000
Ducati	70250014A
Ducati	70250015A

◀ cod. **NT06080**
sigla: 6000
misure: 30x52x16

◀ cod. **NT06089**
sigla: 6305
misure: 25x62x17
APPLICABILITÀ: Albero Motore
RIFERIMENTO ORIGINALE

Yamaha	933063054300
Yamaha	933063055600

◀ cod. **NT06081**
sigla: 6207C3



◀ cod. **FA10100**
Filtro Aria Kymco Dink 125/150 cc 02-07

APPLICABILITÀ

KYMCO DINK CLASSIC 125 4T 02-02, DINK CLASSICEU2 125 4T 03-03, DINK LX 125 4T 98-00, DINK CLASSIC 150 4T 02-02, DINK CLASSICEU2 150 4T 03-03, DINK LX 150 4T 98-00, DINK CLASSIC 200 4T 04-04

RIFERIMENTO ORIGINALE

Kymco	162993
-------	--------



◀ cod. **FA10101**
Filtro Aria Kymco Dink 50 cc 4T

APPLICABILITÀ

KYMCO AGILITY R16 50 4T 08-09, AGILITY R16 50 4T 12-12, DINK 50 4T 50 4T 07-07, PEOPLE S 4T 50 4T 06-08, SENTO 50 4T 08-08, SUPER 8 4T 50 4T 07-07, SUPER 8 4T 50 4T 09-09, SUPER 8 4T 50 4T 13-13

RIFERIMENTO ORIGINALE

Kymco	101074
-------	--------



◀ cod. **FA10102**
Filtro Aria Honda SH 125/150 cc

APPLICABILITÀ

HONDA @ [NES] 125 4T 00-06, DYLAN [SES] 125 4T 02-04, PS I [PES] 125 4T 06-10, SH 125 4T-2V 01-04, SH IE SCOOPIY 125 4T-2V 05-12, @ [NES] 150 4T 00-06, DYLAN [SES] 150 4T 02-04, PS I [PES] 150 4T 06-10, SH 150 4T-2V 01-04

RIFERIMENTO ORIGINALE

Honda	17210-KGF-900
-------	---------------

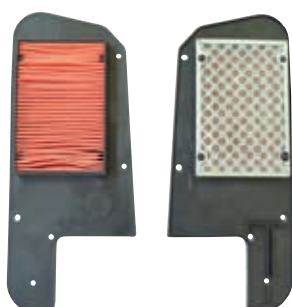

◀ cod. **FA10103**
Filtro Aria Honda Foresight 250 cc

APPLICABILITÀ

HONDA FORESIGHT [FES] 250 4T 98-99, FORESIGHT [FES] D.D. 250 4T 00-05, JAZZ ES REFLEX (NSS) 250 4T-2V 01-04, JAZZ REFLEX(NSS) 250 4T-2V 01-01

RIFERIMENTO ORIGINALE

Honda	17210-KGF-900
-------	---------------



◀ **cod. FA10104**
Filtro Aria Kymco Agility 125-150cc R16

APPLICABILITÀ

KYMCO FILLY LX 50 4T 01-02, PEOPLE S 50 2T 05-08, AGILITY PLUS 125 4T 14-14, AGILITY R16 125 4T 08-09, AGILITY R16 125 4T 12-12, PEOPLE 125 4T 99-00, PEOPLE EU2 125 4T 03-03, PEOPLE EU3 125 4T 07-08, PEOPLE EU3 125 4T 11-11, PEOPLE ONE I 125 4T 13-13, PEOPLE S DD EU3 125 4T 07-08, SUPER 8 125 4T 08-09, AGILITY R16 150 4T 08-09, PEOPLE 150 4T 99-00, PEOPLE EU2 150 4T 03-03, AGILITY I PLUS 200 4T 14-14, AGILITY R16 200 4T 12-12, AGILITY R16 200 4T 10-10, PEOPLE S 200 4T 05-05, PEOPLE S I 200 4T 07-07

RIFERIMENTO ORIGINALE

Kymco	162377
-------	--------

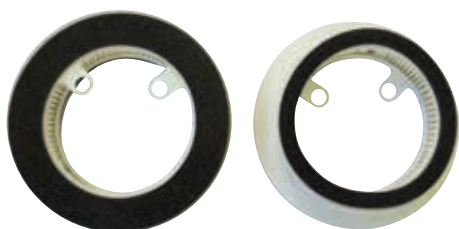

◀ **cod. FA10105**
Filtro Aria Cinghia DX Yamaha T-MAX 500cc 01-11

APPLICABILITÀ

YAMAHA T-MAX 4BS 500 4T 09-11, T-MAX 4BS ABS 500 4T 08-11, T-MAX 5GJ 500 4T 01-03, T-MAX 5VU 500 4T 04-08, T-MAX 5VU ABS 500 4T 05-07, T-MAX 5VU BLACK MAX 500 4T 06-06, T-MAX 5VU BLACK MAX - NIGHT MAX 500 4T 07-07

RIFERIMENTO ORIGINALE

Yamaha	5GJ154080000
--------	--------------



◀ **cod. FA10106**
Filtro Aria Yamaha T-MAX 500cc 01-07

APPLICABILITÀ

YAMAHA T-MAX 5GJ 500 4T 01-03, T-MAX 5VU 500 4T 04-07, T-MAX 5VU ABS 500 4T 05-07, T-MAX 5VU BLACK MAX 500 4T 06-06, T-MAX 5VU BLACK MAX - NIGHT MAX 500 4T 07-07

RIFERIMENTO ORIGINALE

Yamaha	4BH144510100
--------	--------------

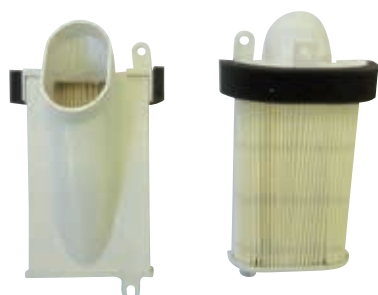

◀ **cod. FA10107**
Filtro Aria Cinghia SX Yamaha T-MAX 500cc 01-07

APPLICABILITÀ

YAMAHA T-MAX 5GJ 500 4T 01-03, T-MAX 5VU 500 4T 04-07, T-MAX 5VU ABS 500 4T 05-07, T-MAX 5VU BLACK MAX 500 4T 06-06, T-MAX 5VU BLACK MAX - NIGHT MAX 500 4T 07-07

RIFERIMENTO ORIGINALE

Yamaha	5GJ154070100
--------	--------------



◀ cod. **FA10109**
Filtro Aria Kymco Dink 125cc EU3 06-10

APPLICABILITÀ

KYMCO DINK EU3 125 4T 06-07, GRAND DINK 125 4T 01-02, GRAND DINK EU2 125 4T 03-04, GRAND DINK 150 4T 01-02, GRAND DINK EU2 150 4T 03-04, DINK IE EU3 200 4T 06-07, GRAND DINK 250 4T 01-02, GRAND DINK EU2 250 4T 03-04, X CITING 250 4T 05-05, X CITING I 250 4T 06-07, X CITING I 300 4T 08-08, X CITING I R 300 4T 08-09

RIFERIMENTO ORIGINALE

Kymco	162475
-------	--------



◀ cod. **FA10110**
Filtro Aria Kymco People S 250cc 06-09

APPLICABILITÀ

KYMCO PEOPLE LC 250 4T 03-04, PEOPLE S 250 4T 06-06, PEOPLE S I 250 4T 07-07, PEOPLE S I 300 4T 08-08

RIFERIMENTO ORIGINALE

Kymco	162380
-------	--------



◀ cod. **FA10111**
Filtro Aria Kymco Agility 50cc 4T R12 05-10

APPLICABILITÀ

KYMCO AGILITY 4T CARRY 50 4T 11-11, AGILITY 4T R12 50 4T 07-08, AGILITY R12 50 4T 05-05, AGILITY RS 50 4T 09-09, DINK CLASSIC EU2 50 2T 03-03

RIFERIMENTO ORIGINALE

Kymco	164044
-------	--------



◀ cod. **FA10112**
Filtro Aria Kymco Agility 50cc 4T R10 06-10

APPLICABILITÀ

KYMCO AGILITY 4T R10 50 4T 06-08

RIFERIMENTO ORIGINALE

Kymco	163126
-------	--------



◀ cod. **FA10113**
Filtro Aria Variatore Yamaha Majesty 250 cc

APPLICABILITÀ

MALAGUTI PASSWORD 250 4T 05-06, PASSWORD EU3 250 4T 07-08

YAMAHA MAJESTY 250 4T 00-03, MAJESTY ABS 250 4T 03-03, X-CITY 250 4T 07-15, X-MAX 250 4T 05-16, X-MAX ABS 250 4T 11-12, X-MAX ABS 250 4T 14-15, X-MAX BLACK 250 4T 09-09, X-MAX SPORT 250 4T 11-12, VERSITY 300 4T 03-06

RIFERIMENTO ORIGINALE

Yamaha	5GM154070000
--------	--------------



◀ cod. **FA10115**
Filtro Aria Yamaha X-MAX 250 cc 05-10

APPLICABILITÀ

YAMAHA X-CITY EU3 125 4T-4V 08-11, X-MAX R 125 4T-4V 06-16, X-MAX R ABS 125 4T-4V 11-11, X-MAX RA ABS 125 4T-4V 13-16, X-CITY 250 4T 07-15, X-MAX 250 4T 05-16, X-MAX ABS 250 4T 11-12, X-MAX ABS 250 4T 14-15, X-MAX BLACK 250 4T 09-09, X-MAX SPORT 250 4T 11-12

RIFERIMENTO ORIGINALE

Yamaha	1B9144510000
--------	--------------



◀ cod. **FA10116**
Filtro Aria Honda SH 300 cc i.e.

APPLICABILITÀ

Honda SH IE 300 Scoopy 300 4T-4V 07-12

RIFERIMENTO ORIGINALE

Honda	17210-KTW-900
-------	---------------



◀ cod. **FA10118**
Filtro Aria Variatore Yamaha Majesty 400 cc 04-10

APPLICABILITÀ

YAMAHA MAJESTY 400 4T 04-11, MAJESTY ABS 400 4T 07-11, X-MAX 400 4T-4V 13-16, X-MAX ABS 400 4T-4V 14-17, X-MAX IRONMAX ABS 400 4T-4V 16-16, X-MAX MOMODESIGN 400 4T-4V 14-14, X-MAX MOMODESIGN ABS 400 4T-4V 14-14, X-MAX RA 400 4T-4V 18-18

RIFERIMENTO ORIGINALE

Yamaha	5RU154070200
--------	--------------



◀ cod. **FA10119**
Filtro Aria Sym Joymax 250/300 cc

APPLICABILITÀ

SYM GTS 250 4T-4V 07-08, JOYMAX 250 4T-4V 05-07, JOYMAX EU3 1250 4T-4V 07-08, JOYMAX EVO 300 4T-4V 09-09, JOYMAX EVO 1300 4T-4V 10-10, JOYMAX I 300 4T-4V 12-12, JOYMAX I 300 4T-4V 14-14, JOYMAX I ABS 300 4T-4V 13-13

RIFERIMENTO ORIGINALE

Sym	17211HMA000
-----	-------------

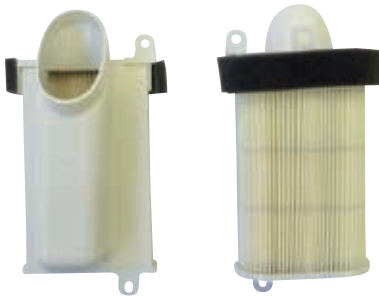

◀ cod. **FA10120**
Filtro Aria Cinghia SX Yamaha T-MAX 500 cc 08-11

APPLICABILITÀ

YAMAHA T-MAX 4B5 500 4T 09-11, T-MAX 4B5 ABS 500 4T 08-11, T-MAX 5VU 500 4T 08-08

RIFERIMENTO ORIGINALE

Yamaha	4B5154070000
--------	--------------



◀ cod. **FA10121**
Filtro Aria SX Yamaha Majesty 400 cc 04-10

APPLICABILITÀ

YAMAHA MAJESTY 400 4T 04-11, MAJESTY ABS 400 4T 07-11

RIFERIMENTO ORIGINALE

Yamaha	5RU144513000
--------	--------------

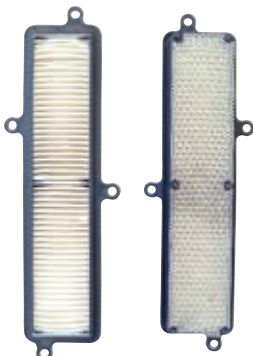

◀ cod. **FA10122**
Filtro Aria Suzuki Burgman 125/200 cc 07-10

APPLICABILITÀ

SUZUKI UH BURGMAN K7/LO 125 4T 07-10, UH BURGMAN L1 125 4T 11-11, UH BURGMAN L3 125 4T 13-13, UH BURGMAN L4 125 4T 14-14, UH BURGMAN K7/LO 200 4T 07-10, UH BURGMAN L1 200 4T 11-12, UH BURGMAN L3 200 4T 13-13, UH BURGMAN L4 200 4T 14-14

RIFERIMENTO ORIGINALE

Suzuki	13780-03H00-000
--------	-----------------



◀ cod. **FA10123**
Filtro Aria Kymco Downtown 300 cc

APPLICABILITÀ

KYMCO DOWNTOWN ABS 300 4T 10-10, DOWNTOWN I 300 4T 09-09, DOWNTOWN I 300 4T 11-11, DOWNTOWN I ABS 300 4T 11-16

RIFERIMENTO ORIGINALE

Kymco	117245
-------	--------



◀ cod. **FA10124**
Filtro Aria Honda PCX 125 cc

APPLICABILITÀ

HONDA PCX 125 4T-2V 10-11, PCX 125 4T-2V 13-13, PCX 150 4T-2V 13-17

RIFERIMENTO ORIGINALE

Honda	17210-KMN-900
-------	---------------



◀ cod. **FA10126**
Filtro Aria Kymco Downtown 125 cc

APPLICABILITÀ

KYMCO DOWNTOWN I 125 4T 09-16, DOWNTOWN I 200 4T 10-10

RIFERIMENTO ORIGINALE

Kymco	117199
-------	--------

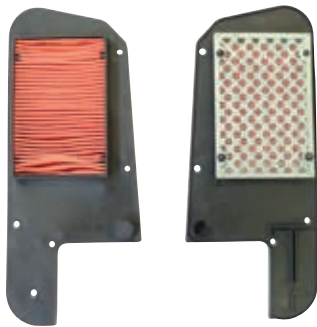

◀ cod. **FA10127**
Filtro Aria Honda S-WING 125/150 cc 4T

APPLICABILITÀ

HONDA SILVER WING [FES] 125 4T-2V 07-12, SILVER WING [FES] 150 4T-2V 07-12

RIFERIMENTO ORIGINALE

Honda	17210-KRJ-900
-------	---------------



◀ cod. **FA10128**
Filtro Aria Cinghia SX Yamaha T-MAX 530 cc

APPLICABILITÀ

YAMAHA T-MAX 59C 530 4T 12-16, T-MAX 59C ABS 530 4T 12-16, T-MAX 59C SP 530 4T 15-15, T-MAX 59C SP ABS 530 4T 15-16

RIFERIMENTO ORIGINALE

Yamaha	59C154070000
--------	--------------



◀ cod. **FA10129**
Filtro Aria Cinghia DX Yamaha T-MAX 530 cc

APPLICABILITÀ

YAMAHA T-MAX 59C 530 4T 12-16, T-MAX 59C ABS 530 4T 12-16, T-MAX 59C SP 530 4T 15-15, T-MAX 59C SP ABS 530 4T 15-16, XP530-A T-MAX SX 530 4T 17-19, XP530D-A T-MAX DX 530 4T 17-19, XP530E-A T-MAX 530 4T 17-18

RIFERIMENTO ORIGINALE

Yamaha	59C154080000
--------	--------------



◀ cod. **F007510**



◀ cod. **F007511**



◀ cod. **F007512**



◀ cod. **F007513**



◀ cod. **F007514**



◀ cod. **F007515**



◀ cod. **F007516**



◀ cod. **F007517**



◀ cod. **F007519**



◀ cod. **F007520**



◀ cod. **F007521**



◀ cod. **F007522**



◀ cod. **F007523**



◀ cod. **F007524**

Marca	Modello	CC	Anno	Codice
APRILIA	ATLANTIC	125	2003>2005	F007515
	ATLANTIC	200	2003>2005	F007515
	ATLANTIC	250	2003>2005	F007515
	ATLANTIC	300	2010>2011	F007515
	ATLANTIC	500	2001>2004	F007524
	ATLANTIC ARRECIFE	125	2003>2005	F007515
	ATLANTIC ARRECIFE	200	2003>2005	F007515
	ATLANTIC ARRECIFE	250	2003>2005	F007515
	ATLANTIC ARRECIFE	400	2005>2008	F007524
	ATLANTIC ARRECIFE	500	2005>2008	F007524
	ATLANTIC EU3	125	2006>2008	F007515
	ATLANTIC EU3	125	2010>2012	F007515
	ATLANTIC EU3	250	2006>2008	F007515
	ATLANTIC SPRINT	400	2005>2008	F007524
	ATLANTIC SPRINT	500	2005>2008	F007524
	LEONARDO	125	1996>1998	F007516
	LEONARDO	125	1999>2002	F007516
	LEONARDO	150	1996>1998	F007516
	LEONARDO	150	1999>2002	F007516
	LEONARDO ST	125	2003>2004	F007516
	MOJITO	125	2003>2007	F007515
	MOJITO	125	2008>2008	F007515
	MOJITO	150	2003>2007	F007515
	MOJITO RETRO' CUSTOM	125	1999>2001	F007514
	SCARABEO	125	1999>2003	F007516
	SCARABEO	125	2003>2003	F007515
	SCARABEO	125	2004>2006	F007515
	SCARABEO	150	1999>2003	F007516
	SCARABEO	150	2004>2006	F007515
	SCARABEO	200	2001>2003	F007516
	SCARABEO	200	2003>2003	F007515
	SCARABEO	250	2004>2006	F007515
	SCARABEO	500	2003>2006	F007524
	SCARABEO EU3	125	2006>2007	F007515
	SCARABEO EU3	200	2006>2006	F007515
	SCARABEO LIGHT	250	2006>2008	F007515
	SCARABEO LIGHT	300	2009>2010	F007515

Marca	Modello	CC	Anno	Codice
APRILIA	SCARABEO LIGHT	400	2006>2008	F007524
	SCARABEO LIGHT	500	2006>2008	F007524
	SPORT CITY	125	2004>2006	F007515
	SPORT CITY	200	2004>2006	F007515
	SPORT CITY CUBE	125	2008>2010	F007515
	SPORT CITY CUBE	200	2008>2010	F007515
	SPORT CITY CUBE	250	2008>2012	F007515
	SPORT CITY CUBE	300	2008>2010	F007515
	SPORT CITY EU3	125	2006>2008	F007515
	SPORT CITY EU3	200	2006>2008	F007515
	SPORT CITY EU3	250	2006>2008	F007515
	SPORT CITY ONE 4T EU3	125	2008>2011	F007515
	SPORT CITY STREET	125	2012>2012	F007515
	SPORT CITY STREET	300	2012>2012	F007515
	SR MAX	125	2011>2014	F007515
	SR MAX	300	2011>2014	F007515
	SR MOTARD	125	2012>2014	F007515
BENELLI	ADIVA	125	2001>2002	F007515
	ADIVA	150	2001>2002	F007515
	ADIVA EU2	250	2006>2008	F007515
	VELVET DUSK	400	2003>2004	F007510
BETA	RR	125	2010>2017	F007523
BMW	C1	125	2000>2003	F007516
	C1	200	2002>2003	F007516
DERBI	BOULEVARD	125	2002>2002	F007515
	BOULEVARD	125	2003>2004	F007515
	BOULEVARD	150	2002>2002	F007515
	BOULEVARD	150	2003>2004	F007515
	BOULEVARD 4T E3	150	2010>2010	F007515
	BOULEVARD 4T EU3	125	2008>2012	F007515
	BOULEVARD EU2	125	2004>2007	F007515
	BOULEVARD EU2	200	2005>2006	F007515
	BOULEVARD EU3	150	2004>2007	F007515
	GP1	250	2006>2007	F007515
	GP1 EU 2	125	2006>2006	F007515
	GP1 LOW SEAT EU3	125	2007>2008	F007515
	GP1 LOW SEAT EU3	250	2007>2008	F007515

Marca	Modello	CC	Anno	Codice
DERBI	RAMBLA	125	2008>2009	F007515
	RAMBLA	250	2008>2009	F007515
	RAMBLA	300	2010>2011	F007515
	RAMBLA EU3 2VER	125	2008>2008	F007515
	RAMBLA EU3 2VER	250	2008>2008	F007515
	SONAR 4T	125	2009>2011	F007515
	SONAR 4T	150	2009>2009	F007515
	VARIANT SPORT 4T EU3	125	2012>2012	F007515
FANTIC	CABALLERO MOTARD	125	2008>2018	F007523
	CABALLERO REGOLARITÀ	125	2008>2008	F007523
GILERA	DNA	125	2001>2001	F007515
	DNA	180	2001>2001	F007515
	FUOCO 4T-4V IE E3 LT	500	2013>2014	F007524
	FUOCO IE EU3	500	2007>2013	F007524
	GP	800	2007>2008	F007524
	GP	800	2009>2011	F007524
	GP CENTENARIO	800	2009>2009	F007524
	NEXUS	500	2003>2005	F007524
	NEXUS EU3	125	2007>2008	F007515
	NEXUS EU3	250	2006>2006	F007515
	NEXUS EU3	250	2007>2007	F007515
	NEXUS EU3	300	2008>2008	F007515
	NEXUS EU3	300	2009>2011	F007515
	NEXUS EU3	500	2006>2008	F007524
	NEXUS EU3	500	2009>2011	F007524
	NEXUS IE EU3	125	2008>2008	F007515
	NEXUS IE EU3	125	2009>2010	F007515
	NEXUS SP EU3	250	2006>2007	F007515
	NEXUS SP EU3	500	2006>2007	F007524
	RUNNER	180	2000>2001	F007515
	RUNNER 4T ST EU3	125	2008>2016	F007515
	RUNNER VX	125	2000>2001	F007515
RUNNER VX	125	2002>2004	F007515	
RUNNER VX	125	2005>2006	F007515	
RUNNER VX 4T EU3	125	2006>2007	F007515	
RUNNER VX RACE	125	2006>2006	F007515	
RUNNER VX SC	125	2006>2007	F007515	

Marca	Modello	CC	Anno	Codice
GILERA	RUNNER VXR	180	2000>2001	F007515
	RUNNER VXR	200	2002>2004	F007515
	RUNNER VXR	200	2005>2006	F007515
	RUNNER VXR 4T ST EU3	200	2008>2011	F007515
	RUNNER VXR EU3	200	2007>2007	F007515
	RUNNER VXR RACE 200	125	2006>2006	F007515
	HM	CITY	125	2011>2013
CITY		200	2011>2013	F007523
CRE F125X		125	2008>2009	F007523
CRE F125X BAJA		125	2010>2012	F007523
CRE F125X SIX		125	2010>2011	F007523
CRM F125X		125	2008>2009	F007523
CRM F125X DERAPAGE		125	2010>2012	F007523
CRM F125X DERAPAGE COMPETITION		125	2010>2011	F007523
CRM F125X DERAPAGE RR		125	2010>2012	F007523
LOCUSTA		125	2011>2013	F007523
LOCUSTA	200	2011>2013	F007523	
HONDA	CBR 600 F	600	1998>1998	F007512
	FORZA [NSS A]	250	2008>2011	F007513
	FORZA [NSS S]	250	2008>2011	F007513
	SH IE SCOOPY	300	2007>2010	F007513
	SH IE SCOOPY	300	2011>2019	F007513
	SILVER WING [FJS]	400	2006>2008	F007513
	SILVER WING [FJS]	600	2001>2010	F007513
	SW-T [FJS]	400	2009>2013	F007513
	SW-T [FJS]	600	2011>2013	F007513
	HUSQVARNA	SM	125	2010>2010
TE		125	2010>2010	F007523
ITALJET	JET SET	125	2001>2001	F007515
	JET SET	150	2001>2001	F007515
	TORPEDO	125	1999>2002	F007515
	TORPEDO	150	1999>2002	F007515
MALAGUTI	MADISON 3	125	2006>2009	F007515
	MADISON 3	250	2006>2009	F007515
	MADISON R	180	2001>2002	F007515
	MADISON RS	250	2004>2004	F007515
	MADISON S RESTYLING	200	2002>2002	F007515

Marca	Modello	CC	Anno	Codice
MALAGUTI	PHANTOM MAX	200	2003>2003	F007515
	PHANTOM MAX	250	2004>2004	F007515
	SPIDER MAX GT	500	2004>2005	F007524
	SPIDER MAX GT EU3	500	2006>2006	F007524
	SPIDER MAX RS	500	2008>2008	F007524
MBK	CITYLINER EU3	125	2008>2010	F007523
	SKYCRUISER	125	2007>2007	F007523
MOTORHISPANIA	KN1	125	2008>2008	F007523
	MH7	125	2008>2008	F007523
	RX-R	125	2008>2008	F007523
PEUGEOT	GEPOLIS IE EU3	250	1990>2002	F007515
	GEPOLIS IE EU3	400	1990>2002	F007524
	GEPOLIS IE EU3	500	1990>2002	F007524
	SATELIS EU3	250	1990>2002	F007515
	SATELIS EU3	400	2007>2012	F007524
	SATELIS EU3	500	1990>2002	F007524
PIAGGIO	BEVERLY	125	2001>2003	F007515
	BEVERLY	200	2001>2003	F007515
	BEVERLY	250	2005>2007	F007515
	BEVERLY	500	2002>2004	F007524
	BEVERLY	500	2005>2006	F007524
	BEVERLY EU3	400	2006>2007	F007524
	BEVERLY CRUISER	250	2007>2009	F007515
	BEVERLY CRUISER	500	2007>2012	F007524
	BEVERLY EU3	125	2007>2008	F007515
	BEVERLY EURO 3 MIC	125	2007>2007	F007515
	BEVERLY EURO 3 MIC	250	2007>2007	F007515
	BEVERLY EURO 3 SPORT	125	2007>2008	F007515
	BEVERLY IE EU3	250	2006>2008	F007515
	BEVERLY IE EU3	500	2006>2008	F007524
	BEVERLY RST	125	2004>2005	F007515
	BEVERLY RST	125	2005>2007	F007515
	BEVERLY RST	250	2004>2005	F007515
	BEVERLY RST 4T 4V IE EU3	125	2010>2015	F007515
	BEVERLY RST 4T 4V IE EU3	300	2010>2016	F007515
	BEVERLY SPORT	250	2006>2008	F007515
BEVERLY TOURER EU3	125	2007>2010	F007515	

Marca	Modello	CC	Anno	Codice
PIAGGIO	BEVERLY TOURER EU3	250	2007>2009	F007515
	BEVERLY TOURER EU3	300	2009>2010	F007515
	BEVERLY TOURER EU3	400	2008>2010	F007524
	CARNABY	125	2007>2010	F007515
	CARNABY	200	2007>2008	F007515
	CARNABY	250	2008>2009	F007515
	CARNABY CRUISER	300	2009>2012	F007515
	FLY	125	2005>2007	F007515
	FLY	150	2005>2007	F007515
	FLY EU3	125	2007>2007	F007515
	FLY EU3	125	2008>2011	F007515
	FLY EU3	150	2008>2011	F007515
	HEXAGON GTX	125	2000>2000	F007515
	HEXAGON GTX	180	2000>2000	F007515
	HEXAGON LX4	125	1998>1999	F007514
	LIBERTY	125	1998>2000	F007514
	LIBERTY	125	2001>2002	F007515
	LIBERTY	150	2001>2002	F007515
	LIBERTY	200	2006>2006	F007515
	LIBERTY 4T	125	2006>2007	F007515
	LIBERTY 4T 2V EURO3	125	2009>2012	F007515
	LIBERTY 4T EU3	125	2006>2008	F007515
	LIBERTY 4T EU3	200	2006>2008	F007515
	LIBERTY 4T EU3 DELIVERY - TNT	125	2008>2015	F007515
	LIBERTY 4T SPORT EU3	125	2006>2008	F007515
	LIBERTY 4T SPORT EU3	150	2008>2008	F007515
	LIBERTY 4T SPORT EU3	200	2006>2007	F007515
	LIBERTY MOC 4T	150	2009>2013	F007515
	LIBERTY RST	125	2004>2005	F007515
	LIBERTY RST	200	2004>2004	F007515
LIBERTY RST PTT	125	2005>2011	F007515	
LIBERTY SPORT	125	2006>2006	F007515	
LIBERTY SPORT	200	2006>2006	F007515	
MP3	125	2006>2008	F007515	
MP3	250	2006>2008	F007515	
MP3	400	2007>2008	F007524	
MP3 4T 4V IE LT IBRIDO	300	2010>2011	F007515	

Marca	Modello	CC	Anno	Codice
PIAGGIO	MP3 IBRIDO	125	2009>2010	F007515
	MP3 IE	125	2008>2009	F007515
	MP3 IE LT	300	2010>2011	F007515
	MP3 IE LT TOURING	300	2011>2013	F007515
	MP3 IE LT TOURING	400	2011>2011	F007524
	MP3 IE LT/SPORT	300	2011>2014	F007515
	MP3 IE LT/SPORT	400	2008>2010	F007524
	MP3 IE MIC	300	2010>2010	F007515
	MP3 IE MIC	300	2011>2011	F007515
	MP3 IE TOURING	125	2011>2012	F007515
	MP3 IE TOURING	300	2011>2012	F007515
	MP3 LT	250	2008>2009	F007515
	MP3 LT BUSINESS ABS	500	2014>2016	F007524
	MP3 LT SPORT/BUSINESS	500	2011>2013	F007524
	MP3 MIC	250	2008>2009	F007515
	MP3 MIC	400	2008>2010	F007524
	MP3 RL SPORT-BUSINESS	500	2011>2012	F007524
	MP3 RL TOURING	400	2011>2011	F007524
	MP3 SPORT ABS	500	2014>2016	F007524
	MP3 YOURBAN ERL	125	2011>2013	F007515
	MP3 YOURBAN ERL	300	2011>2015	F007515
	MP3 YOURBAN LT ERL	300	2011>2012	F007515
	SFERA	125	1995>1997	F007514
	SKYPPER 4T	125	2000>2002	F007515
	SKYPPER 4T	150	2000>2002	F007515
	SUPER HEXAGON GTX 12	125	2001>2002	F007515
	SUPER HEXAGON GTX 12	180	2001>2002	F007515
	TYPHOON 4T 2V E3	125	2010>2011	F007515
	VESPA ET4	125	1996>1998	F007514
	VESPA ET4	125	1999>2002	F007515
	VESPA ET4	150	1999>2002	F007515
	VESPA GRANTURISMO	125	2003>2005	F007515
	VESPA GRANTURISMO	125	2006>2007	F007515
	VESPA GRANTURISMO	200	2003>2005	F007515
	VESPA GRANTURISMO	200	2006>2007	F007515
	VESPA GRANTURISMO EU3	125	2006>2007	F007515
	VESPA GT 60 EU3	250	2006>2007	F007515

Marca	Modello	CC	Anno	Codice
PIAGGIO	VESPA GTS	250	2005>2016	F007515
	VESPA GTS 4T IE SUPER	125	2009>2016	F007515
	VESPA GTS ABS	250	2005>2012	F007515
	VESPA GTS EU3	125	2007>2012	F007515
	VESPA GTS IE TOURING	300	2011>2012	F007515
	VESPA GTS SUPER	300	2008>2016	F007515
	VESPA GTS SUPER SPORT	300	2010>2013	F007515
	VESPA GTV	125	2006>2008	F007515
	VESPA GTV	250	2006>2009	F007515
	VESPA GTV 4T 4V IE	300	2010>2013	F007515
	VESPA GTV 4T NAVY EU3	125	2008>2008	F007515
	VESPA GTV 4T NAVY EU3	250	2007>2007	F007515
	VESPA GTV VIA MONTENAPOLEONE	300	2010>2010	F007515
	VESPA LX	125	2005>2006	F007515
	VESPA LX	150	2005>2006	F007515
	VESPA LX 4T EU3 TOURING	125	2010>2011	F007515
	VESPA LX 4T FL	125	2009>2009	F007515
	VESPA LX 4T FL	150	2009>2009	F007515
	VESPA LX EU3	125	2006>2008	F007515
	VESPA LX EU3	150	2006>2008	F007515
	VESPA LX EU3 IE	125	2009>2011	F007515
	VESPA LX EU3 IE	150	2009>2011	F007515
	VESPA LX TOURING	150	2010>2012	F007515
	VESPA LXV 4T EU3	125	2006>2009	F007515
	VESPA LXV IE 4T	125	2010>2013	F007515
	VESPA LXV NAVY EU3	125	2007>2008	F007515
	VESPA S 4T	150	2008>2009	F007515
	VESPA S 4T EU3	125	2007>2008	F007515
	VESPA S 4T IE & COLLEGE	125	2009>2011	F007515
	VESPA S 4T IE & COLLEGE	150	2009>2012	F007515
	X-EVO	125	2007>2016	F007515
	X-EVO	250	2007>2016	F007515
	X-EVO	400	2007>2011	F007524
	X10 4T-4V IE EU3	500	2012>2014	F007524
	X7 EU3	125	2008>2008	F007515
	X7 EU3	250	2008>2008	F007515
	X7 EVO IE EU3	125	2009>2010	F007515

Marca	Modello	CC	Anno	Codice	
PIAGGIO	X7 EVO IE EU3	300	2009>2010	F007515	
	X8	125	2004>2004	F007515	
	X8	125	2005>2006	F007515	
	X8	200	2004>2004	F007515	
	X8	200	2005>2007	F007515	
	X8 EU3	250	2005>2008	F007515	
	X8 EU3	400	2006>2008	F007524	
	X8 PREMIUM EU2	125	2006>2006	F007515	
	X8 PREMIUM EU3	125	2006>2007	F007515	
	X8 STREET EU2	125	2006>2007	F007515	
	X8 STREET EU2	150	2006>2008	F007515	
	X9	125	2001>2002	F007515	
	X9	200	2002>2003	F007515	
	X9	500	2001>2002	F007524	
	X9 AMALFI	180	2000>2003	F007515	
	X9 EVOLUTION	125	2003>2003	F007515	
	X9 EVOLUTION	125	2005>2006	F007515	
	X9 EVOLUTION	200	2003>2003	F007515	
	X9 EVOLUTION	250	2004>2004	F007515	
	X9 EVOLUTION	250	2006>2006	F007515	
	X9 EVOLUTION	500	2003>2005	F007524	
	X9 EVOLUTION	500	2006>2007	F007524	
	X9 EVOLUTION ABS	500	2006>2007	F007524	
	X9 EVOLUTION EU3	125	2007>2007	F007515	
	ZIP	125	2000>2002	F007515	
	RENAULT	FULLTIME	125	2002>2003	F007515
	RIEJU	MARATHON	125	2009>2009	F007523
MARATHON PRO		125	2009>2009	F007523	
MARATHON PRO COMPETITION		125	2011>2011	F007523	
RS3		125	2011>2011	F007523	
SUZUKI	AN BURGMAN K1/K2	250	2001>2002	F007510	
	AN BURGMAN K3-K5	650	2003>2005	F007511	
	AN BURGMAN K3/K6	250	2003>2006	F007510	
	AN BURGMAN K3/K6	400	2003>2006	F007510	
	AN BURGMAN K7/LO	400	2007>2010	F007522	
	AN BURGMAN L1	400	2011>2011	F007522	
	AN BURGMAN L2	400	2012>2012	F007522	

Marca	Modello	CC	Anno	Codice
SUZUKI	AN BURGMAN L3	400	2013>2013	F007522
	AN BURGMAN L4	400	2014>2014	F007522
	AN BURGMAN L5	400	2015>2015	F007522
	AN BURGMAN L6	400	2016>2016	F007522
	AN BURGMAN W/X/Y	250	1998>2000	F007510
	AN BURGMAN X/K2	400	1999>2002	F007510
	AN S-Y	125	1995>2000	F007522
	AN T-Y	150	1996>2000	F007522
	DL V-STROM L4	1000	2014>2014	F007515
	DL V-STROM L5	1000	2015>2015	F007515
	DL V-STROM L6	1000	2016>2017	F007515
	EPICURO	125	1999>2001	F007522
	EPICURO	150	1999>2001	F007522
	LT-A KINGQUAD K6/K7	700	2006>2007	F007511
	LT-A KINGQUAD X L2	500	2012>2012	F007511
	LT-A KINGQUAD XP K9/LO	500	2009>2010	F007511
	LT-A KINGQUAD XP L1	500	2011>2011	F007511
	LT-A KINGQUAD XP L2	500	2012>2012	F007511
	LT-A X KINGQUAD K8/LO	750	2008>2010	F007511
	LT-A X KINGQUAD L1	750	2011>2011	F007511
	LT-A X KINGQUAD L2	750	2012>2012	F007511
	LT-A XP KINGQUAD K9/LO	750	2009>2010	F007511
	LT-A XP KINGQUAD L1	750	2011>2011	F007511
	LT-A XP KINGQUAD L2	750	2012>2012	F007511
	LT-A400F KINGQUAD 4X4 K8/LO	400	2008>2010	F007511
	LT-A400F KINGQUAD 4X4 L1	400	2011>2011	F007511
	LT-A450F KINGQUAD 4X4 K7/LO	450	2007>2010	F007511
	LT-A500F VINSON K4/K7	500	2004>2007	F007511
	LT-Z QUADSPORT K7/LO	90	2007>2010	F007522
	UE CT K1	125	2001>2001	F007522
	UE CT K1	150	2001>2001	F007522
	UH BURGMAN K2/K6	125	2002>2006	F007522
UH BURGMAN K2/K6	150	2002>2006	F007522	
UH BURGMAN K7/LO	125	2007>2010	F007522	
UH BURGMAN K7/LO	200	2007>2010	F007522	
UH BURGMAN L1	125	2011>2011	F007522	
UH BURGMAN L1	200	2011>2012	F007522	

Marca	Modello	CC	Anno	Codice
SUZUKI	UX SIXTEEN K8/LO	125	2008>2010	F007522
	UX SIXTEEN K8/LO	150	2008>2010	F007522
	UX SIXTEEN L1	125	2011>2011	F007522
	UX SIXTEEN L1	150	2011>2011	F007522
VENT	BAJA	125	2018>2019	F007523
	BAJA RR	125	2018>2019	F007523
	DERAPAGE	125	2018>2019	F007523
	DERAPAGE RR	125	2018>2019	F007523
	TRAIL	125	2018>2019	F007523
YAMAHA	MAJESTY	400	2004>2005	F007521
	MAJESTY	400	2006>2006	F007521
	MAJESTY	400	2007>2008	F007521
	MAJESTY	400	2009>2011	F007521
	MAJESTY ABS	400	2007>2007	F007521
	MAJESTY ABS	400	2008>2008	F007521
	MAJESTY ABS	400	2009>2011	F007521
	MT	125	2015>2015	F007523
	MT A	125	2015>2015	F007523
	T-MAX 4B5	500	2009>2011	F007517
	T-MAX 4B5 ABS	500	2008>2011	F007517
	T-MAX 59C	530	2012>2012	F007517
	T-MAX 59C	530	2013>2014	F007517
	T-MAX 59C	530	2015>2016	F007517
	T-MAX 59C ABS	530	2012>2012	F007517
	T-MAX 59C ABS	530	2013>2014	F007517
	T-MAX 59C ABS	530	2015>2016	F007517
	T-MAX 59C SP	530	2015>2015	F007517
	T-MAX 59C SP ABS	530	2015>2016	F007517
	T-MAX 5GJ	500	2001>2003	F007517
	T-MAX 5VU	500	2004>2005	F007517
	T-MAX 5VU	500	2006>2006	F007517
	T-MAX 5VU	500	2007>2007	F007517
	T-MAX 5VU	500	2008>2008	F007517
	T-MAX 5VU ABS	500	2005>2005	F007517
	T-MAX 5VU ABS	500	2006>2006	F007517
T-MAX 5VU ABS	500	2007>2007	F007517	
T-MAX 5VU BLACK MAX	500	2006>2006	F007517	

Marca	Modello	CC	Anno	Codice
YAMAHA	T-MAX 5VU BLACK MAX - NIGHT MAX	500	2007>2007	F007517
	WR-R IE	125	2009>2011	F007523
	WR-X IE	125	2009>2011	F007523
	WR-X IE	125	2013>2014	F007523
	X-CITY EU3	125	2008>2011	F007523
	X-MAX	400	2013>2014	F007521
	X-MAX	400	2015>2016	F007521
	X-MAX ABS	400	2014>2014	F007521
	X-MAX ABS	400	2015>2017	F007521
	X-MAX IRONMAX ABS	400	2016>2016	F007521
	X-MAX MOMODESIGN	400	2014>2014	F007521
	X-MAX MOMODESIGN ABS	400	2014>2014	F007521
	X-MAX R	125	2006>2007	F007523
	X-MAX R	125	2008>2009	F007523
	X-MAX R	125	2010>2012	F007523
	X-MAX R	125	2012>2013	F007523
	X-MAX R	125	2014>2014	F007523
	X-MAX R	125	2015>2016	F007523
	X-MAX R ABS	125	2011>2011	F007523
	X-MAX RA	400	2018>2018	F007521
	X-MAX RA ABS	125	2013>2013	F007523
	X-MAX RA ABS	125	2014>2015	F007523
	X-MAX RA ABS	125	2016>2016	F007523
	XT-R	660	2004>2005	F007519
	YZF R6	600	2001>2002	F007520
	YZF R6	600	2007>2007	F007520
	YZF R6	600	2008>2008	F007520
	YZF R6	600	2009>2009	F007520
	YZF R6	600	2010>2012	F007520
	YZF R6	600	2013>2015	F007520
	YZF R6 & LIMITED EDITION 07	600	2006>2006	F007520
	YZF R6 50TH	600	2012>2012	F007520
YZF-R A IE	125	2015>2015	F007523	
YZF-R IE	125	2008>2011	F007523	
YZF-R IE	125	2012>2012	F007523	
YZF-R IE	125	2013>2013	F007523	
YZF-R IE	125	2014>2014	F007523	
YZF-R IE	125	2015>2015	F007523	



- ◀ cod. **FZ00363**
Frizione tipo originale per motore scooter 50 cc Morini/Suzuki ad aria



- ◀ cod. **FZ00364**
Frizione tipo originale per motore scooter 50 cc Piaggio/Honda

RIFERIMENTO ORIGINALE

Piaggio	CM1002045
---------	-----------



- ◀ cod. **FZ00365**
Frizione per motori scooter 50 cc Minarelli/Yamaha 3 ceppi con campana Ø interno 107 mm



- ◀ cod. **FZ00366**
Frizione completa per motori scooter 50 cc Minarelli/Yamaha 2 ceppi con campana Ø interno 105 mm



- ◀ cod. **FZ00371**
Frizione tipo originale per motore scooter Minarelli/Yamaha 125 cc

RIFERIMENTO ORIGINALE

Yamaha	5DSE66200000
Mbk	5DSE66200000

Malaguti	73503300
----------	----------

APPLICABILITÀ

ITALJET	JUPITER 125 4T 01-02, MILLENIUM 125 4T 00-02
MALAGUTI	MADISON 125 4T 99-01, MADISON R RESTYLING 125 4T 02-02, MADISON R RESTYLING EU2 125 4T 03-04, PHANTOM MAX 125 4T 03-03
MBK	DOODO 125 4T 00-00, SKYLINER 125 4T 98-02, SKYLINER E 125 4T 03-03, THUNDER 125 4T 01-02

YAMAHA	CYGNUS X (NXC) 125 4T 04-06, CYGNUS X IE EU3 (NXC) 125 4T 07-11, MAJESTY 125 4T 98-00, MAJESTY (SNR1) 125 4T 01-01, MAJESTY (SNR8) 125 4T 02-02, MAJESTY E 125 4T 03-09, MAXSTER 125 4T 01-02, TEO'S 125 4T 00-00
---------------	---



◀ **cod. FZ00378**

Frizione tipo originale per motore scooter 125/150/180 4T Piaggio

RIFERIMENTO ORIGINALE

Piaggio	CM161202
Aprilia	CM161202
Gilera	CM161202

Derbi	CM161202
Malaguti	43500800

APPLICABILITÀ

APRILIA ATLANTIC ARRECIFE 125 4T 03-05, ATLANTIC 200 4T 03-05, ATLANTIC ARRECIFE 200 4T 03-05, SPORT CITY 200 4T 04-06

GILERA RUNNER VX 125 4T 00-06, RUNNER 180 4T 00-01, RUNNER VXR 180 4T 00-01

MALAGUTI MADISON 3 125 4T 06-09, MADISON S RESTYLING 200 4T 02-02, PHANTOM MAX 200 4T 03-03

PIAGGIO FLY 125 4T 05-07, FLY 150 4T 05-07, LIBERTY 150 4T 01-02, SKYPPER 4T 150 4T 00-02, VESPA ET4 150 4T 99-02, HEXAGON GTX 180 4T 00-00, SUPER HEXAGON GTX 12 180 4T 01-02, X9 AMALFI 180 4T 00-03, CARNABY 200 4T 07-08, LIBERTY 200 4T 06-06, VESPA GRANTURISMO 200 4T 03-05, VESPA GTS EU3 200 4T 07-12, VESPA GTV EU3 200 4T 06-08, X8 200 4T 04-04

RENAULT FULLTIME 125 4T 02-03



◀ **cod. FZ00382**

Frizione completa per motore scooter Piaggio Beverly 250 cc 4T

RIFERIMENTO ORIGINALE

Piaggio	8722515
Aprilia	8722515
Gilera	8722515

Derbi	8722515
Malaguti	43500700

APPLICABILITÀ

APRILIA ATLANTIC ARRECIFE 250 4T 03-05, ATLANTIC EU3 250 4T 06-08, SCARABEO 250 4T 04-06, SPORT CITY EU3 250 4T 06-08

DERBI GP1 250 4T 06-07

GILERA NEXUS EU3 250 4T 06-07

MALAGUTI MADISON 3 250 4T 06-09, MADISON RS 250 4T 04-04, PHANTOM MAX 250 4T 04-04

PIAGGIO BEVERLY 250 4T 05-07, CARNABY 250 4T 08-09, MP3 250 4T 06-08, MP3 LT 250 4T 08-09, MP3 MIC 250 4T 08-09, VESPA GT 60 EU3 250 4T 06-07, VESPA GTS 250 4T 05-16, VESPA GTS ABS 250 4T 05-12, VESPA GTV 250 4T 06-09, X-EVO 250 4T 07-16, X8 EU3 250 4T 05-08, MP3 4T 4V IE LT IBRIDO 300 4T 10-11, MP3 IE LT 300 4T 10-11, MP3 IE LT TOURING 300 4T 11-13, MP3 IE LT/SPORT 300 4T 11-14, MP3 IE MIC 300 4T 10-11, MP3 IE TOURING 300 4T 11-12, MP3 YOURBAN ERL 300 4T 11-15, MP3 YOURBAN LT ERL 300 4T 11-12



◀ **cod. FZ00383**

Frizione completa per motore scooter Piaggio Beverly 500 cc 4T

RIFERIMENTO ORIGINALE

Piaggio	8405775
Aprilia	8405775

Gilera	8405775
Malaguti	43500500

APPLICABILITÀ

APRILIA ATLANTIC 500 4T 01-04, SCARABEO 500 4T 03-06

GILERA NEXUS 500 4T 03-05

MALAGUTI SPIDER MAX GT 500 4T 04-05, SPIDER MAX GT EU3 500 4T 06-06, SPIDER MAX RS 500 4T 08-08

PEUGEOT GEOPOLIS IE EU3 400 4T-4V 90-02, SATELIS EU3 400 4T 07-12, GEOPOLIS IE EU3 500 4T-4V 90-02, SATELIS EU3 500 4T 90-02

PIAGGIO BEVERLY 500 4T 02-06, BEVERLY CRUISER 500 4T 07-12, BEVERLY IE EU3 500 4T 06-08, X9 500 4T 01-02, X9 EVOLUTION 500 4T 03-07



◀ **cod. FZ00385**

Frizione completa per motore scooter 50 cc Piaggio Pure Jet

RIFERIMENTO ORIGINALE

Piaggio	CM1002045
---------	-----------



◀ **cod. FZ00386**
Frizione completa per Honda SH 125/150 cc

RIFERIMENTO ORIGINALE

Honda	22300KGF912
Honda	22300KGG911

Malaguti	65044700
Keeway	200203160000

APPLICABILITÀ

HONDA @ [NES] 125 4T 00-06, DYLAN [SES] 125 4T 02-04, PS I [PES] 125 4T 06-10, SH 125 4T-2V 01-04, SH IE SCOOOPY 125 4T-2V 05-12, SILVER WING [FES] 125 4T-2V 07-12, @ [NES] 150 4T 00-06, DYLAN [SES] 150 4T 02-04, PANTHEON IE [FES] 150 4T-2V 03-05, PS I [PES] 150 4T 06-10, SH 150 4T-2V 01-04, SH IE SCOOOPY 150 4T 05-12, SILVER WING [FES] 150 4T-2V 07-12

KEEWAY OUTLOOK 125 4T 07-08, OUTLOOK 150 4T 07-08

KYMCO AGILITY 125 4T 06-06, AGILITY EU3 125 4T 06-08, AGILITY PLUS 125 4T 14-14, AGILITY R16 125 4T 08-09, AGILITY R16 125 4T 12-12, AGILITY RS 125 4T 09-09, HEROISM 125 4T 95-97, K-XCT I 125 4T 12-14, LIKE 125 4T 09-09, MOVIE 125 4T 99-00, MOVIE EU3 125 4T 06-07, MOVIE XL 125 4T 01-01, MOVIE XL EU2 125 4T 03-04, PEOPLE 125 4T 99-00, PEOPLE EU2 125 4T 03-03, PEOPLE EU3 125 4T 07-08, PEOPLE EU3 125 4T 11-11, PEOPLE ONE I 125 4T 13-13, PEOPLE S 125 4T 05-05, PEOPLE S DD EU3 125 4T 07-08, SUPER 8 125 4T 08-09, VIVIO 125 4T 00-00, AGILITY R16 150 4T 08-09, HEROISM 150 4T 95-97, MOVIE EU3 150 4T 06-07, MOVIE XL 150 4T 01-01, MOVIE XL EU2 150 4T 03-04, PEOPLE 150 4T 99-00, PEOPLE EU2 150 4T 03-03, VIVIO 150 4T 00-00, AGILITY I PLUS 200 4T 14-14, AGILITY R16 200 4T 12-12, AGILITY R16 200 4T 10-10, LIKE IE 200 4T 09-09, LIKE LX 200 4T 12-12, PEOPLE S 200 4T 05-05, PEOPLE S I 200 4T 07-07

MALAGUTI BLOG IE 125 4T 09-10, CENTRO IE EU3 125 4T 08-09, CENTRO SL IE EU3 125 4T 09-10, CIAK MASTER 125 4T 04-04, CIAK MASTER 150 4T 04-04, BLOG IE 160 4T 09-10, CENTRO IE EU3 160 4T 08-09, CENTRO SL IE EU3 160 4T 09-10, CIAK MASTER EURO 2 200 4T 06-06

WT MOTORS ATENE 150 4T 08-10



◀ **cod. FZ00388**
Frizione completa Yamaha Majesty 250 cc STD type

RIFERIMENTO ORIGINALE

Yamaha	5GM166200100
Mbk	5GM166200100
Aprilia	AP8122452

Malaguti	73504300
Sym	22300HMB300

APPLICABILITÀ

APRILIA LEONARDO 250 4T 02-04, LEONARDO 300 4T 02-04

ITALJET JUPITER 250 4T 00-00

MALAGUTI MADISON S 250 4T 99-01, PASSWORD 250 4T 05-06, PASSWORD EU3 250 4T 07-08

MBK SKYLINER 250 4T 00-03, SKYLINER ABS 250 4T 03-03, KILIBRE 300 4T 03-06

SYM GTS 250 4T-4V 07-08, JOYMAX 250 4T-4V 05-07, CITYCOM 300 4T-4V 08-09, JOYMAX EVO 300 4T-4V 09-09

TGB X MOTION 250 4T-4V 08-09

YAMAHA MAJESTY 250 4T 00-03, MAJESTY ABS 250 4T 03-03, X-CITY 250 4T 07-15, X-MAX 250 4T 05-16, X-MAX ABS 250 4T 14-15, VERSITY 300 4T 03-06



◀ **cod. FZ00390**
Frizione completa Honda Forsight 250 cc

RIFERIMENTO ORIGINALE

Honda	22535KFG000
-------	-------------

APPLICABILITÀ

HONDA FORESIGHT [FES] 250 4T 98-99, FORESIGHT [FES] D.D. 250 4T 00-05

PIAGGIO X9 250 4T 00-01



◀ **cod. FZ00392**
Frizione completa Honda SH 300 cc

RIFERIMENTO ORIGINALE

Honda	22300KTW902
-------	-------------

APPLICABILITÀ

HONDA SH IE SCOOOPY 300 4T-4V 07-19



◀ **cod. FZ00394**
Frizione completa 5 ceppi Yamaha Majesty 400 cc

RIFERIMENTO ORIGINALE

Yamaha	5RU166202000
--------	--------------

APPLICABILITÀ

YAMAHA MAJESTY 400 4T 04-11, MAJESTY ABS 400 4T 07-11, X-MAX 400 4T-4V 13-16, X-MAX ABS 400 4T-4V 14-17, X-MAX IRONMAX ABS 400 4T-4V 16-16, X-MAX MOMODESIGN 400 4T-4V 14-14, X-MAX MOMODESIGN ABS 400 4T-4V 14-14, X-MAX RA 400 4T-4V 18-18



◀ **cod. FZ00396**
Frizione completa Piaggio Beverly 125 cc

RIFERIMENTO ORIGINALE

Piaggio	CM161202
---------	----------

APPLICABILITÀ

APRILIA ATLANTIC 125 4T 03-05, ATLANTIC EU3 125 4T 06-08, ATLANTIC EU3 125 4T 10-12, MOJITO 125 4T 03-08, SCARABEO 125 4T 03-06, SCARABEO EU3 125 4T 06-07, SPORT CITY 125 4T 04-06, SPORT CITY CUBE 125 4T 08-10, SPORT CITY EU3 125 4T 06-08

DERBI BOULEVARD 125 4T 02-04, BOULEVARD EU2 125 4T 04-07, GP1 EU 2 125 4T 06-06, GP1 LOW SEAT EU3 125 4T 07-08, RAMBLA 125 4T 08-09, BOULEVARD 150 4T 02-04, BOULEVARD EU3 150 4T 04-07

GILERA DNA 125 4T 01-01, NEXUS EU3 125 4T 07-08, NEXUS IE EU3 125 4T 08-10

PIAGGIO BEVERLY 125 4T 01-03, BEVERLY EU3 125 4T 07-08, BEVERLY RST 125 4T 04-07, BEVERLY TOURER EU3 125 4T 07-10, CARNABY 125 4T 07-10, HEXAGON GTX 125 4T 00-00, LIBERTY 125 4T 98-02, MP3 125 4T 06-08, MP3 IBRIDO 125 4T 09-10, MP3 IE 125 4T 08-09, SKYPPER 4T 125 4T 00-02, SUPER HEXAGON GTX 12 125 4T 01-02, VESPA ET4 125 4T 99-02, VESPA GRANTURISMO 125 4T 03-07, VESPA GRANTURISMO EU3 125 4T 06-07, VESPA GTS 4T IE SUPER 125 4T 09-16, VESPA GTS EU3 125 4T 07-12, VESPA GTV 125 4T 06-08, VESPA GTV 4T NAVY EU3 125 4T 08-08, X-EVO 125 4T 07-16, X7 EU3 125 4T 08-08, X7 EVO IE EU3 125 4T 09-10, X8 125 4T 04-06, X9 125 4T 01-02, ZIP 125 4T 00-02



◀ **cod. FZ00400**
Frizione Kymco Xciting 300 cc

RIFERIMENTO ORIGINALE

Kymco	00127965
-------	----------

APPLICABILITÀ

KYMCO B&W 250 4T 00-00, B&W EU2 250 4T 03-03, GRAND DINK 250 4T 01-02, GRAND DINK EU2 250 4T 03-04, PEOPLE LC 250 4T 03-04, PEOPLE S 250 4T 06-06, PEOPLE S 1 250 4T 07-07, X CITING 250 4T 05-05, X CITING 1 250 4T 06-07, YUP 250 4T 03-03, PEOPLE S 1 300 4T 08-08, X CITING 1 300 4T 08-08, X CITING 1 R 300 4T 08-09

◀ **cod. FZ00401**
Frizione Yamaha X-Max 125 cc

RIFERIMENTO ORIGINALE

Yamaha	1B9E66200200
Yamaha	5CG166200100
Yamaha	5KDE66200000

Mbk	5KDE66200000
Mbk	5CG166200100
Malaguti	73503600

APPLICABILITÀ

APRILIA LEONARDO 250 4T 99-01, LEONARDO ST 250 4T 01-01

ITALJET JUPITER 150 4T 01-02, MILLENNIUM 150 4T 00-02, JUPITER 250 4T 01-02

MALAGUTI MADISON T 150 4T 99-01

MBK SKYCRUISER 125 4T-4V 07-07, DOODO 150 4T 01-02, SKYLINER 150 4T 00-02, THUNDER 150 4T 01-02, SKYLINER E 180 4T 03-03

YAMAHA X-CITY EU3 125 4T-4V 08-11, X-MAX R 125 4T-4V 06-16, X-MAX R ABS 125 4T-4V 11-11, X-MAX RA ABS 125 4T-4V 13-16, MAJESTY 150 4T 00-00, MAJESTY (SNS1) 150 4T 01-01, MAJESTY (SNS6) 150 4T 02-02, MAXSTER 150 4T 01-02, TEO'S 150 4T 01-02, MAJESTY E 180 4T 03-06, MAJESTY 250 4T 96-98, MAJESTY DX 250 4T 98-99



◀ cod. **FZ00403**
Frizione Suzuki Burgman 400 cc X-K2 / K3-K6

RIFERIMENTO ORIGINALE

Suzuki	21501-15F01-000
--------	-----------------

APPLICABILITÀ

SUZUKI AN BURGMAN K3/K6 400 4T 03-06, AN BURGMAN X/K2 400 4T 99-02



◀ cod. **FZ00405**
Frizione Honda Vision 110 cc

APPLICABILITÀ

HONDA VISION [NSC] 110 4T-2V 12-12, SH I ABS 125 4T-2V 13-17, SH I ABS 150 4T-2V 13-17



◀ cod. **FZ00407**
Frizione Honda PCX 125 cc

APPLICABILITÀ

HONDA PCX 125 4T-2V 10-11, PCX 125 4T-2V 13-13, PCX 150 4T-2V 13-17



◀ cod. **FZ00409**
Frizione Kymco DOWNTOWN 200/300 cc

RIFERIMENTO ORIGINALE

Kymco	122241
Kymco	22300-LGE5-E00

APPLICABILITÀ

KYMCO DOWNTOWN I 200 4T 10-10, PEOPLE GTI 200 4T 10-10, DOWNTOWN ABS 300 4T 10-10, DOWNTOWN I 300 4T 09-09, DOWNTOWN I 300 4T 11-11, DOWNTOWN I ABS 300 4T 11-16, PEOPLE GTI 300 4T 10-11



◀ cod. **FZ00411**
Frizione completa Ø 130 Kymco DOWNTOWN 125 cc

RIFERIMENTO ORIGINALE

Kymco	122170
-------	--------

APPLICABILITÀ

KYMCO DOWNTOWN I 125 4T 09-16



◀ cod. **FZ00413**
Frizione Suzuki Burgman 125 cc K7-L3

APPLICABILITÀ

SUZUKI UH BURGMAN K7/LO 125 4T 07-10, UH BURGMAN L1 125 4T 11-11, UH BURGMAN L3 125 4T 13-13, UX SIXTEEN K8/LO 125 4T 08-10, UX SIXTEEN L1 125 4T 11-11

RIFERIMENTO ORIGINALE

Suzuki	21501-46G10-000
--------	-----------------



◀ cod. **FZ00414**
Frizione Suzuki Burgman 200 cc k7-L4

APPLICABILITÀ

SUZUKI UH BURGMAN K7/LO 200 4T 07-10, UH BURGMAN L1 200 4T 11-12

RIFERIMENTO ORIGINALE

Suzuki	21501-03H30-000
--------	-----------------



◀ cod. **FZ00417**
Frizione Sym Symphony 125/150 cc

RIFERIMENTO ORIGINALE

Sym	22300F6A000
-----	-------------

APPLICABILITÀ

SYM FIDDLE II 125 4T 10-10, JET 4 125 4T 09-10, SYMPHONY 125 4T 09-09, SYMPHONY S 125 4T 09-10, SYMPHONY SR 125 4T 10-10, FIDDLE II 150 4T 10-10, SYMPHONY 150 4T 09-09, SYMPHONY S 150 4T 10-10, SYMPHONY SR 150 4T 10-10



◀ cod. **FZ00418**
Frizione Piaggio Liberty 125 cc EU3

RIFERIMENTO ORIGINALE

Piaggio	CM1612015
---------	-----------

APPLICABILITÀ

APRILIA SPORT CITY ONE 4T EU3 125 4T 08-11, SR MOTARD 125 4T-2V 12-14

DERBI BOULEVARD 4T EU3 125 4T 08-12, SONAR 4T 125 4T 09-11, VARIANT SPORT 4T EU3 125 4T 12-12, BOULEVARD 4T E3 150 4T 10-10, SONAR 4T 150 4T 09-09

PIAGGIO FLY EU3 125 4T 07-07, LIBERTY 4T EU3 125 4T 06-08, TYPHOON 4T 2V E3 125 4T 10-11, VESPA LX 4T EU3 TOURING 125 4T 10-11, VESPA LXV IE 4T 125 4T 10-13, VESPA S 4T EU3 125 4T 07-08, VESPA S 4T IE & COLLEGE 125 4T 09-11, X8 STREET EU2 125 4T 06-07, FLY EU3 150 4T 08-11, LIBERTY MOC 4T 150 4T 09-13, VESPA LX EU3 IE 150 4T 09-11, VESPA LX TOURING 150 4T 10-12, VESPA S 4T 150 4T 08-09, X8 STREET EU2 150 4T 06-08



◀ cod. **FZ00419**
Frizione Suzuki Burgman 400 cc K7-L3

APPLICABILITÀ

SUZUKI AN BURGMAN K7/LO 400 4T 07-10, AN BURGMAN L1 400 4T 11-11, AN BURGMAN L2 400 4T 12-12, AN BURGMAN L3 400 4T 13-13, AN BURGMAN L4 400 4T 14-14, AN BURGMAN L5 400 4T 15-15, AN BURGMAN L6 400 4T 16-16



◀ cod. **FZ00422**
Frizione piaggio liberty 125 cc 3V Iget

APPLICABILITÀ

PIAGGIO LIBERTY 4T 3V IE E3 125 4T-3V 13-13



◀ cod. **FZ00423**
Frizione piaggio vespa lx primavera 125 cc 3V Iget

APPLICABILITÀ

PIAGGIO LIBERTY 4T 3V IE E3 125 4T-3V 13-14, VESPA LX PRIMAVERA 4T 3V IE 125 4T-3V 13-17, VESPA SPRINT 4T 3V IE 125 4T-3V 14-15



◀ cod. **FZ00424**
Frizione piaggio vespa sprint 125 cc 3V Abs

APPLICABILITÀ

PIAGGIO LIBERTY IGET 4T 3V IE 125 4T-3V 15-17, VESPA PRIMAVERA 4T 3V E4 IGET ABS 125 4T-3V 16-17, VESPA SPRINT IGET 4T 3V ABS (EMEA) 125 4T-3V 16-17



◀ cod. **AA00780**
Perno pompa acqua con girante motore scooter 50 cc Minarelli/Yamaha



◀ cod. **AA00785**
Traino per girante pompa acqua motore scooter 50 cc Minarelli/Yamaha



◀ cod. **AA00786**
Gommino su perno traino pompa acqua motore scooter 50 cc Minarelli/Yamaha



◀ cod. **AA00787**
Perno per traino girante pompa acqua motore scooter 50 cc Minarelli/Yamaha



◀ cod. **AA00797**
Perno lungo per traino girante pompa acqua motore scooter 50 cc Minarelli/Yamaha Aerox '06-'16

APPLICABILITÀ

YAMAHA AEROX 50 2T 06-16, AEROX NAKED 50 2T 13-16



◀ cod. **AA00788**
Kit revisione pompa acqua per scooter 50 cc Minarelli/Yamaha

APPLICABILITÀ

APRILIA AREA 51 50 2T 98-00, GULLIVER LC 50 2T 96-98, RALLY LIQUID COOLED 50 2T 96-99, SONIC GP 50 2T 98-08, SR LIQUID COOLED 50 2T 94-96, SR RACING 50 2T 97-99, SR STEALTH 50 2T 97-00
BENELLI 491 RACING 50 2T 98-99, 491 RR 50 2T 99-01, 491 SP 50 2T 99-99, 491 SPORT 50 2T 98-99, K2 LIQUID COOLED 50 2T 98-01
BETA ARK LC 50 2T 96-08, EIKON 50 2T 99-03
ITALJET DRAGSTER 50 2T 98-02

MALAGUTI F12 PHANTOM EURO 2 50 2T 02-02, F12 PHANTOM LC 50 2T 94-98, F12 PHANTOM LC EURO 2,2,3 50 2T 03-04, F12 R PHANTOM LC 50 2T 07-10, F12 RESTYLING EURO 1 50 2T 99-02, F12 RESTYLING LC EURO 2 50 2T 06-06, F15 FIRE FOX 50 2T 96-98, F15 FIRE FOX EURO 2 50 2T 02-06, F15 FIRE FOX EURO 2,3 50 2T 03-04

MBK MACH G LC 50 2T 02-04, NITRO 50 2T 97-04, NITRO EURO 2 50 2T 03-03

YAMAHA AEROX 50 2T 97-02, AEROX 50 2T 04-16, AEROX EURO 2 50 2T 03-03, AEROX NAKED 50 2T 13-16, AEROX R 50 2T 99-00, JOG R LC 50 2T 02-15

RICAMBIO

AA00784 Paraolio BA 10 18 4 Corcos



◀ cod. **AA00789**
Kit revisione pompa acqua per motore Minarelli AM6

APPLICABILITÀ

APRILIA CLASSIC 50 2T 92-99, EUROPA 50 2T 91-92, MX 50 2T 04-04, MX MOTARD 50 2T 95-03, PEGASO 50 2T 92-94, RS 50 2T 91-05, RX 50 2T 03-04, RX 3-5 MARCE 50 2T 91-94, RX ENDURO 50 2T 95-03, RX RACING 50 2T 03-06, TUONO 50 2T 03-04
BETA RR 2T 50 EU4 50 2T 18-20, RR 50 RACING EU4 50 2T 18-20, RR ALU 50 2T 08-12, RR ENDURO 50 2T 06-17, RR MOTARD 50 2T 06-17
CH HUSQUAR-SM 50 2T 00-10, WR 50 2T 00-10, WSM 50 2T 00-10
NA
CMC ENDURO 50 2T 11-11, MOTARD 50 2T 11-11
FANTIC CABALLERO MOTARD 50 2T 06-10, CABALLERO REGOLARITÀ 50 2T 06-10, ENDURO COMPETITION EU4 50 2T 18-20, ENDURO PERFORMANCE EU4 50 2T 18-20, MOTARD COMPETITION EU4 50 2T 18-20, MOTARD PERFORMANCE EU4 50 2T 18-20
HM BAJA, DERAPAGE BASIC 50 2T 10-11, CMC 50 2T 10-11, CRE BAJA RR, DERAPAGE RR 50 2T 07-11, CRE BAJA, DERAPAGE 50 2T 07-11, CRE SIX COMPETITION 50 2T 10-11, CRE SIX, BAIA, DERAPAGE 50 2T 95-06, CRE SIX, DERAPAGE COMPETITION 50 2T 07-09, DERAPAGE COMPETITION 50 2T 10-11
MALAGUTI CNK DRAGON 50 2T 05-07, FIFTY EVOLUTION 50 2T 90-93, XSM 50 2T 03-03, XTM 50 2T 03-03
MBK X LIMIT 50 2T 03-04, X POWER 50 2T 03-04

MINARELLI MOTORE AM 3-4-5 50 2T 91-95, MOTORE AM 6 1° SERIE 50 2T 96-11, MOTORE AM 6 2° SERIE 50 2T 12-18

MOTORHISPANIA FURIA 50 2T 97-00, FURIA MAX 50 2T 10-12, RX 50 2T 09-12, RX R 50 2T 09-12

PEUGEOT SUPERMOTARD 50 2T 90-02, XP6 TRAIL S/AVV. ELETTRICO 50 2T 90-02, XR6 RACING CAT. C/AVV.ELETT. 50 2T 90-02

RIEJU MRT 50 2T 09-12, MRT 50 EU4 50 2T 18-20, MRT PRO 50 2T 09-12, MRT PRO EU4 50 2T 18-20, MRT PRO REPLICIA EU4 50 2T 18-20, MRT PRO REPLICIA SM EU4 50 2T 18-20, MRT PRO SM 50 2T 09-12, MRT PRO SM EU4 50 2T 18-20, MRT SM 50 2T 09-12, MRT SM EU4 50 2T 18-20, MRT TROPHY EU4 50 2T 18-20, MRX 50 2T 01-04, MRX PRO 50 2T 01-04, RR 50 2T 05-06, RS1 50 2T 98-01, RS2 MATRIX 50 2T 05-06, RS2 MATRIX PRO 50 2T 05-06, RS2 NAKED 50 2T 04-05, RS3 EU4 50 2T 18-20, RS3 MKD EU4 50 2T 18-20, SMX E.S./K.S. 50 2T 01-01, SMX PRO E.S./K.S. 50 2T 03-03, SPIKE 50 2T 98-01

SHERCO FACTORY SE-R EU4 50 2T 18-20, FACTORY SE-RS EU4 50 2T 18-20, FACTORY SILVER SM-R EU4 50 2T 18-20, FACTORY SILVER SM-RS EU4 50 2T 18-20, FACTORY SM-R EU4 50 2T 18-20, FACTORY SM-RS EU4 50 2T 18-20, HRD ENDURO 50 2T 09-13, HRD MOTARD 50 2T 09-13

VENT BAJA 50 2T 18-20, BAJA RR 50 2T 18-20, DERAPAGE 50 2T 18-20, DERAPAGE RR 50 2T 18-20

YAMAHA DT R 50 2T 03-11, DT RSM 50 2T 03-05, DT X 50 2T 06-11, TZR 50 2T 03-08, TZR 50 2T 10-11, TZR RR 50 2T 05-05

KIT REVISIONE POMPA ACQUA



◀ cod. **AA00792**
Corpo pompa acqua per motore Minarelli AM6



◀ cod. **AA00796**
Kit revisione pompa acqua per motore scooter 50 cc Piaggio/Gilera

APPLICABILITÀ

APRILIA SR CARBURATORE 50 2T 14-14, SR MOTARD 50 2T 12-14, SR R 50 2T 04-09, SR R FACTORY CARBURATORE 50 2T 10-14, SR R FACTORY IE 50 2T 10-14, SR R FACTORY IE 50 2T-IE 10-12, SR STREET CARBURATORE 50 2T 03-12

DERBI GP1 50 2T 01-03, GP1 EU 2.50 2T 05-05, GP1 OPEN EU2 50 2T 06-09, GP1 RACE EU2 50 2T 05-07

GILERA DNA 50 2T 00-02, DNA 50 2T 05-07, DNA GP EXPERIENCE 50 2T 03-04, RUNNER 50 2T 97-00, RUNNER POGGIALI 50 2T 02-02, RUNNER PURE JET 50 2T-IE 02-07, RUNNER PURE JET 50 2T-IE 10-11, RUNNER PURE JET ST 50 2T-IE 08-08, RUNNER SP 50 2T 02-07, RUNNER SP 50 2T 10-12, RUNNER SP SPECIAL EDITION 50 2T 07-07, RUNNER SP ST & SIMONCELLI 50 2T 08-09

PIAGGIO NRG 50 2T 94-96, NRG EXTREME LC 50 2T 99-00, NRG MC3 50 2T 01-04, NRG POWER DD 50 2T 05-17, NRG POWER DD SERIE SPECIALE 50 2T 07-12, NRG POWER PUREJET 50 2T-IE 04-11, NRG PUREJET 50 2T-IE 02-04, NRG PUREJET 50 2T-IE 10-10, NRG RST MC2 50 2T 96-98, NTT 50 2T 95-96, QUARTZ 50 2T 92-96, ZIP 2T 50 2T 08-13, ZIP LC 50 2T 00-04, ZIP SP 50 2T 96-04, ZIP SP EURO 2.50 2T 06-13



◀ cod. **AA00805**
Kit revisione pompa acqua per motore scooter Minarelli/Yamaha YP 125/150/180 cc

APPLICABILITÀ

BENELLI VELVET 125 4T 99-01, VELVET 150 4T 99-01

ITALJET JUPITER 125 4T 01-02, MILLENNIUM 125 4T 00-02, JUPITER 150 4T 01-02, MILLENNIUM 150 4T 00-02

MALAGUTI MADISON 125 4T 99-01, MADISON R RESTYLING 125 4T 02-02, MADISON R RESTYLING EU2 125 4T 03-04, PHANTOM MAX 125 4T 03-03, MADISON T 150 4T 99-01

MBK DOODO 125 4T 00-00, SKYLINER 125 4T 98-02, SKYLINER E 125 4T 03-03, THUNDER 125 4T 01-02, DOODO 150 4T 01-02, SKYLINER 150 4T 00-02, THUNDER 150 4T 01-02, SKYLINER E 180 4T 03-03

YAMAHA MAJESTY 125 4T 98-00, MAJESTY (5NR1) 125 4T 01-01, MAJESTY (5NR8) 125 4T 02-02, MAJESTY E 125 4T 03-09, MAXSTER 125 4T 01-02, TEO'S 125 4T 00-00, MAJESTY 150 4T 00-00, MAJESTY (5NS1) 150 4T 01-01, MAJESTY (5NS6) 150 4T 02-02, MAXSTER 150 4T 01-02, TEO'S 150 4T 01-02, MAJESTY E 180 4T 03-06



◀ cod. **AA00806**
Kit revisione pompa acqua per motore scooter Minarelli/Yamaha YP 250/270 cc

APPLICABILITÀ

APRILIA LEONARDO 250 4T 99-04, LEONARDO ST 250 4T 01-01, LEONARDO 300 4T 02-04

BENELLI VELVET 250 4T 99-03

ITALJET JUPITER 250 4T 00-02

MALAGUTI MADISON S 250 4T 99-01, PASSWORD 250 4T 05-06, PASSWORD EU3 250 4T 07-08

MBK SKYLINER 250 4T 00-03, SKYLINER ABS 250 4T 03-03, KI-LIBRE 300 4T 03-06

YAMAHA MAJESTY 250 4T 96-03, MAJESTY ABS 250 4T 03-03, MAJESTY DX 250 4T 98-99, X-CITY 250 4T 07-15, X-MAX 250 4T 05-16, X-MAX ABS 250 4T 14-15, VERSITY 300 4T 03-06



◀ cod. **AA00808**
Kit revisione pompa acqua Katana-Ditech 13 mm 2SR

APPLICABILITÀ

SUZUKI KATANA K1-K4 50 2T 01-04, KATANA V-Y 50 2T 97-00



◀ cod. **AA00809**
Kit revisione pompa acqua Katana-Ditech 50 cc con girante a pale basse 7 mm

APPLICABILITÀ

APRILIA SR DITECH EU2 50 2T-IE 02-04, SR H2O CARBURATORE 50 2T 00-03, SR H2O DITECH 50 2T-IE 00-04, SR R FACTORY MOTORE APRILIA 50 2T-IE 05-05 **SUZUKI** KATANA K1-K4 50 2T 01-04, ZILLION UX 50 2T 99-99



◀ cod. **AA00810**
Kit revisione pompa acqua Aprilia Scarabeo 125/150 cc

APPLICABILITÀ

APRILIA LEONARDO 125 4T 99-02, LEONARDO ST 125 4T 03-04, SCARABEO 125 4T 99-03, LEONARDO 150 4T 99-02, SCARABEO 150 4T 99-03 **BMW** C1 125 4T 00-03



◀ cod. **AA00811**
Kit revisione pompa acqua Aprilia Leonardo 125/150 cc

APPLICABILITÀ

APRILIA LEONARDO 125 4T 96-98, LEONARDO 150 4T 96-98



◀ cod. **AA00812**
Kit revisione pompa acqua Honda Pantheon 125/150 cc 2T

APPLICABILITÀ

HONDA PANTHEON [FES] 125 2T 98-02, PANTHEON [FES] 150 2T 98-02



◀ cod. **AA00813**
Kit revisione pompa acqua Honda SH 125/150 cc 4T

APPLICABILITÀ

HONDA @ [NES] 125 4T 00-06, DYLAN [SES] 125 4T 02-04, PANTHEON IE [FES] 125 4T-2V 03-05, PS I [PES] 125 4T 06-10, SH 125 4T-2V 01-04, SH IE SCOOPY 125 4T-2V 05-12, SILVER WING [FES] 125 4T-2V 07-12, @ [NES] 150 4T 00-06, DYLAN [SES] 150 4T 02-04, PANTHEON IE [FES] 150 4T-2V 03-05, PS I [PES] 150 4T 06-10, SH 150 4T-2V 01-04, SH IE SCOOPY 150 4T 05-12, SILVER WING [FES] 150 4T-2V 07-12



◀ cod. **AA00814**
Kit revisione pompa acqua Honda Foresight 250 cc 4T

APPLICABILITÀ

HONDA FORESIGHT [FES] 250 4T 98-99, FORESIGHT [FES] D.D. 250 4T 00-05



◀ cod. **AA00815**
Kit revisione pompa acqua Kymco 125/150 cc 4T

APPLICABILITÀ

KYMCO B&W 125 4T 00-00, B&W EU2 125 4T 03-04, DINK 125 4T 97-98, DINK CLASSIC 125 4T 02-02, DINK CLASSIC EU2 125 4T 03-03, DINK LX 125 4T 98-00, GRAND DINK 125 4T 01-02, GRAND DINK EU2 125 4T 03-04, B&W 150 4T 00-00, B&W EU2 150 4T 03-04, DINK 150 4T 97-98, DINK CLASSIC 150 4T 02-02, DINK CLASSIC EU2 150 4T 03-03, DINK LX 150 4T 98-00, GRAND DINK 150 4T 01-02, GRAND DINK EU2 150 4T 03-04, DINK CLASSIC 200 4T 04-04



◀ cod. **AA00816**
Kit revisione pompa acqua Kymco 250 cc 4T

APPLICABILITÀ

KYMCO B&W 250 4T 00-00, B&W EU2 250 4T 03-03, GRAND DINK 250 4T 01-02, GRAND DINK EU2 250 4T 03-04, PEOPLE LC 250 4T 03-04, PEOPLE S 250 4T 06-06, PEOPLE S I 250 4T 07-07, X CITING 250 4T 05-05, X CITING I 250 4T 06-07, YUP 250 4T 03-03, PEOPLE S I 300 4T 08-08, X CITING I 300 4T 08-08, X CITING I R 300 4T 08-09



◀ cod. **AA00817**
Kit revisione pompa acqua Piaggio/Aprilia 125/200 cc

APPLICABILITÀ

APRILIA ATLANTIC 125 4T 03-05, ATLANTIC ARRECIFE 125 4T 03-05, SCARABEO 125 4T 04-06, SPORT CITY 125 4T 04-06, SCARABEO 150 4T 04-06, ATLANTIC 200 4T 03-05, ATLANTIC ARRECIFE 200 4T 03-05, SPORT CITY 200 4T 04-06

GILERA DNA 125 4T 01-01, RUNNER VX 125 4T 00-06, RUNNER 180 4T 00-01, RUNNER VXR 180 4T 00-01

PIAGGIO BEVERLY 125 4T 01-03, BEVERLY RST 125 4T 04-05, CARNABY 125 4T 07-10, HEXAGON GTX 125 4T 00-00, SUPER HEXAGON GTX 125 4T 01-02, VESPA GRANTURISMO 125 4T 03-05, X8 125 4T 04-04, X9 125 4T 01-02, X9 EVOLUTION 125 4T 03-03, HEXAGON GTX 180 4T 00-00, SUPER HEXAGON GTX 125 180 4T 01-02, X9 AMALFI 180 4T 00-03, BEVERLY 200 4T 01-03, X8 200 4T 04-04, X9 200 4T 02-03, X9 EVOLUTION 200 4T 03-03

RENAULT FULLTIME 125 4T 02-03



◀ cod. **AA00818**
Kit revisione pompa acqua Yamaha Majesty 400 cc

APPLICABILITÀ

YAMAHA MAJESTY 400 4T 04-08, MAJESTY ABS 400 4T 07-08, X-MAX 400 4T-4V 13-16, X-MAX ABS 400 4T-4V 14-17, X-MAX IRONMAX ABS 400 4T-4V 16-16, X-MAX MOMODESIGN 400 4T-4V 14-14, X-MAX MOMODESIGN ABS 400 4T-4V 14-14, X-MAX RA 400 4T-4V 18-18



◀ cod. **AA00819**
Kit revisione pompa acqua Suzuki Burgman 125/150 /200/250/400 cc

APPLICABILITÀ

SUZUKI EPICURO 125 4T 99-01, UH BURGMAN K2/K6 125 4T 02-06, UH BURGMAN K7/LO 125 4T 07-10, UH BURGMAN L1 125 4T 11-11, EPICURO 150 4T 99-01, UH BURGMAN K2/K6 150 4T 02-06, UH BURGMAN K7/LO 200 4T 07-10, UH BURGMAN L1 200 4T 11-12, AN BURGMAN K1/K2 250 4T 01-02, AN BURGMAN K3/K6 250 4T 03-06, AN BURGMAN W/X/Y 250 4T 98-00, AN BURGMAN K3/K6 400 4T 03-06, AN BURGMAN X/K2 40

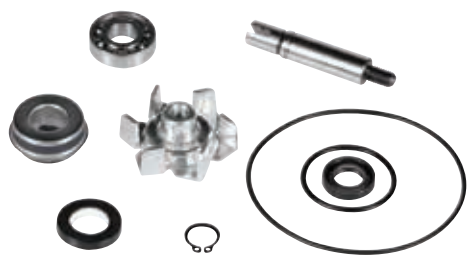

◀ cod. **AA00820**
Kit revisione pompa acqua Yamaha T-Max '04-'11 (5vu)

APPLICABILITÀ

YAMAHA T-MAX 4B5 500 4T 09-11, T-MAX 4B5 ABS 500 4T 08-11, T-MAX 5VU 500 4T 04-08, T-MAX 5VU ABS 500 4T 05-07, T-MAX 5VU BLACK MAX 500 4T 06-06, T-MAX 5VU BLACK MAX - NIGHT MAX 500 4T 07-07



◀ cod. **AA00822**
Kit revisione pompa acqua Honda SH 300 cc

APPLICABILITÀ

HONDA SH IE SCOOPY 300 4T-4V 07-19

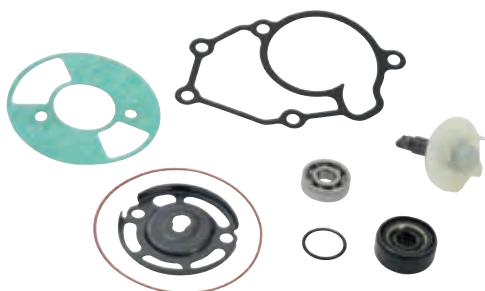

◀ cod. **AA00823**
Kit revisione pompa acqua Yamaha X-Max 125 cc

APPLICABILITÀ

MBK CITYLINER EU3 125 4T-4V 08-10, SKYCRUISER 125 4T-4V 07-07

YAMAHA X-CITY EU3 125 4T-4V 08-11, X-MAX R 125 4T-4V 06-16, X-MAX R ABS 125 4T-4V 11-11, X-MAX RA ABS 125 4T-4V 13-16



◀ cod. **AA00824**
Kit revisione pompa acqua Piaggio 500 cc Euro 3

APPLICABILITÀ

APRILIA SCARABEO LIGHT 400 4T 06-08, SCARABEO LIGHT 500 4T 06-08

GILERA FUOCO IE EU3 500 4T 07-13, NEXUS EU3 500 4T 06-08

PIAGGIO BEVERLY EU3 400 4T 06-07, BEVERLY TOURER EU3 400 4T 08-10, MP3 400 4T 07-08, MP3 IE LT TOURING 400 4T 11-11, MP3 IE LT/SPORT 400 4T 08-10, MP3 MIC 400 4T 08-10, MP3 RL TOURING 400 4T 11-11, X-EVO 400 4T 07-11, BEVERLY CRUISER 500 4T 07-12, BEVERLY IE EU3 500 4T 06-08, MP3 LT SPORT/BUSINESS 500 4T 11-13, MP3 RL SPORT-BUSINESS 500 4T 11-12



◀ cod. **AA00825**
Kit revisione pompa acqua Derbi d50b0 (motore Piaggio)

APPLICABILITÀ

APRILIA RS 50 2T 06-10, RS4 50 2T 11-13, RS4 REPLICA 50 2T 14-16, RX 50 2T 06-10, RX 50 2T 14-16, SX 50 2T 06-16, SX LIMITED EDITION 50 2T 14-16

DERBI GPR 2T 50 2T 13-13, GPR 2T EU2 50 2T 09-10, GPR NUDE & GPR NUDE TUNING 50 2T 06-08, GPR NUDE SPORT 50 2T 06-06, GPR R EU2 - GPR REPLICA EU2 50 2T 08-08, GPR RACING EU2 50 2T 06-06, GPR REPLICA & GPR R EU2 50 2T 06-06, GPR REPLICA 2T MALOSSÌ 50 2T 07-07, GPR REPLICA PESEK EU2 50 2T 07-07, SENDA HYP DRD EVO EU2 50 2T 08-09, SENDA HYP DRD EVO LIMITED EDITION EU2 50 2T 08-08, SENDA R DRD PRO EU2 50 2T 05-11, SENDA R DRD RACING EU2 50 2T 05-08, SENDA R DRD X-TREME 2T EU2 50 2T 14-15, SENDA R DRD X-TREME 2T EURO2 50 2T 10-12, SENDA R X-RACE 2T EU2 50 2T 10-10, SENDA R X-RACE EU2 50 2T 06-09, SENDA R X-TREME 2T EU2 50 2T 10-10,

SENDA R X-TREME EU2 50 2T 05-08, SENDA SM DRD PRO EU2 50 2T 05-11, SENDA SM DRD PRO EU2 2VER 50 2T 05-08, SENDA SM DRD RACING EU2 50 2T 05-08, SENDA SM DRD RACING LTD EU2 50 2T 07-07, SENDA SM DRD X-TREME 2T EU2 50 2T 14-15, SENDA SM DRD X-TREME 2T EU2 LIMITED ED 50 2T 14-15, SENDA SM X-RACE 2T EU2 50 2T 10-10, SENDA SM X-RACE EU2 50 2T 06-09, SENDA SM X-RACE EU2 2VER 50 2T 07-09, SENDA SM X-TREME 2T EU2 50 2T 10-10, SENDA SM X-TREME EU2 50 2T 05-08

GILERA RCR 50 2T 06-07, RCR 50 2T 11-12, RCR (CHE-SYC) 50 2T 13-15, SMT 50 2T 06-17, SMT RACING 50 2T 11-12

VALENTI RACING RME 50 2T 15-17, SM 50 2T 15-17

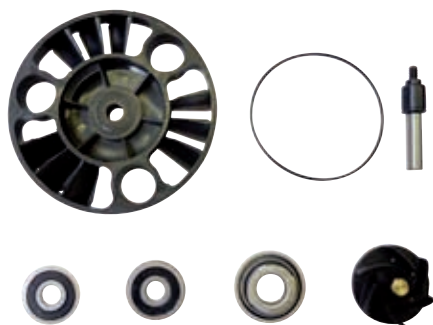

◀ cod. **AA00826**
Kit revisione pompa acqua Piaggio/Aprilia 125/200 cc Euro 3

APPLICABILITÀ

APRILIA ATLANTIC EU3 125 4T 06-08, ATLANTIC EU3 125 4T 10-12, SCARABEO EU3 125 4T 06-07, SPORT CITY CUBE 125 4T 08-10, SPORT CITY EU3 125 4T 06-08, SPORT CITY STREET 125 4T 12-12

DERBI GP1 EU 2 125 4T 06-06, GP1 LOW SEAT EU3 125 4T 07-08, RAMBLA 125 4T 08-09, RAMBLA EU3 2VER 125 4T 08-08

GILERA NEXUS EU3 125 4T 07-08, RUNNER 4T ST EU3 125 4T 08-16, RUNNER VX 4T EU3 125 4T 06-07, RUNNER VX RACE 125 4T 06-06, RUNNER VX SC 125 4T 06-07, RUNNER VXR 200 4T 02-06, RUNNER VXR 4T ST EU3 200 4T 08-11, RUNNER VXR EU3 200 4T 07-07

PIAGGIO BEVERLY EU3 125 4T 07-08, BEVERLY EURO 3 MIC 125 4T 07-07, BEVERLY EURO 3 SPORT 125 4T 07-08, BEVERLY RST 125 4T 05-07, BEVERLY RST 4T 4V IE EU3 125 4T 10-15, BEVERLY TOURER EU3 125 4T 07-10, MP3 125 4T 06-08, VESPA GRANTURISMO 125 4T 06-07, VESPA GRANTURISMO EU3 125 4T 06-07, VESPA GTS EU3 125 4T 07-12, VESPA GTV 125 4T 06-08, VESPA GTV 4T NAVY EU3 125 4T 08-08, X-EVO 125 4T 07-16, X7 EU3 125 4T 08-08, X8 125 4T 05-06, X8 PREMIUM EU2 125 4T 06-06, X8 PREMIUM EU3 125 4T 06-07, X9 EVOLUTION 125 4T 05-06, X9 EVOLUTION EU3 125 4T 07-07, CARNABY 200 4T 07-08, VESPA GRANTURISMO 200 4T 06-07, X8 200 4T 05-07

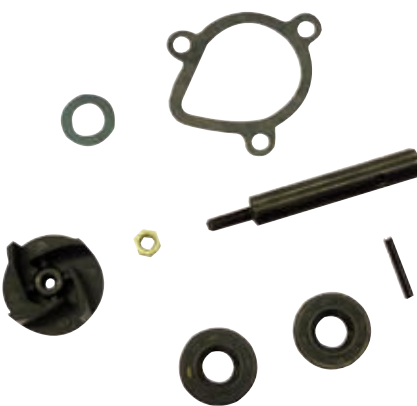

◀ cod. **AA00827**
Kit revisione pompa acqua Derbi ebs050 (vecchio modello)

APPLICABILITÀ

DERBI BULTACO LOBITO 50 2T 98-01, GPR NUDE 50 2T 04-05, GPR R 50 2T 97-00, GPR RACING 50 2T 04-05, GPR REPLICA 50 2T 99-01, GPR REPLICA RACING 50 2T 02-03, GPR REPLICA RACING EU2 50 2T 05-05, SENDA BLACK EDITION 50 2T 03-03, SENDA R 50 2T 99-01, SENDA R DRD BLACK DEVIL 2A EDIZIONE 50 2T 03-03, SENDA R DRD EU1 EU1R 50 2T 02-02, SENDA R DRD RACING 50 2T 04-05, SENDA R DRD RACING LTD 50 2T 05-05, SENDA R RACER 50 2T 03-03, SENDA R X-RACE 50 2T 04-05, SENDA R X-TREME 50 2T 03-03, SENDA R X-TREME 50 2T 05-05, SENDA R X-TREME EU2 50 2T 04-04, SENDA SM 50 2T 00-01, SENDA SM DRD EDITION BLACK 50 2T 05-05, SENDA SM DRD EU1 EU1R 50 2T 02-03, SENDA SM DRD RACING 50 2T 04-05, SENDA SM DRD RACING LTD 50 2T 05-05, SENDA SM X-RACE 50 2T 04-05, SENDA SM X-TREME 50 2T 02-03, SENDA SM X-TREME EU2 50 2T 04-04, SENDA SM X-TREME EU2 2A EDIZIONE 50 2T 05-05

GILERA GSM 50 2T 01-01, RCR 50 2T 03-03, SMT 50 2T 03-03



◀ cod. **AA00828**
Kit revisione pompa acqua Piaggio 300cc

APPLICABILITÀ

APRILIA ATLANTIC 250 4T 03-05, ATLANTIC EU3 250 4T 06-08, SCARABEO 250 4T 04-06, SCARABEO LIGHT 250 4T 06-08, ATLANTIC 300 4T 10-11, SCARABEO LIGHT 300 4T 09-10, SPORT CITY STREET 300 4T 4V 12-12, SR MAX 300 4T 11-14

DERBI RAMBLA 250 4T 08-09, RAMBLA EU3 2VER 250 4T 08-08, RAMBLA 300 4T 10-11

GILERA NEXUS EU3 250 4T 06-07, NEXUS SP EU3 250 4T 06-07, OREGON 250 4T 06-10, NEXUS EU3 300 4T 08-11

PIAGGIO BEVERLY 250 4T 05-07, BEVERLY CRUISER 250 4T 07-09, BEVERLY EURO 3 MIC 250 4T 07-07, BEVERLY IE EU3 250 4T 06-08, BEVERLY SPORT 250 4T 06-08, BEVERLY TOURER EU3 250 4T 07-09, CARNABY 250 4T 08-09, MP3 250 4T 06-08, MP3 LT 250 4T 08-09, MP3 MIC 250 4T 08-09, VESPA GT 60 EU3 250 4T 06-07, VESPA GTS 250 4T 05-16, VESPA GTS ABS 250 4T 05-12, VESPA GTV 250 4T 06-09, VESPA GTV 4T NAVY EU3 250 4T 07-07, X-EVO 250 4T 07-16, X7 EU3 250 4T 08-08, X8 EU3 250 4T 05-08, X9 EVOLUTION 250 4T 06-06, BEVERLY RST 4T 4V IE EU3 300 4T 10-16, BEVERLY TOURER EU3 300 4T 09-10, CARNABY CRUISER 300 4T 09-12, MP3 4T 4V IE LT IBRIDO 300 4T 10-11, MP3 IE LT 300 4T 10-11, MP3 IE LT TOURING 300 4T 11-13, MP3 IE LT/SPORT 300 4T 11-14, MP3 IE MIC 300 4T 10-11, MP3 IE TOURING 300 4T 11-12, MP3 YOURBAN ERL 300 4T 11-15, MP3 YOURBAN LT ERL 300 4T 11-12, VESPA GTS IE TOURING 300 4T 11-12, VESPA GTS SUPER 300 4T 08-16, VESPA GTS SUPER SPORT 300 4T 10-13, VESPA GTV 4T 4V IE 300 4T 10-13, VESPA GTV VIA MONTENAPOLEONE 300 4T 10-10, X7 EVO IE EU3 300 4T 09-10



◀ cod. **AA00829**
Kit revisione pompa acqua Piaggio Beverly 350 cc

APPLICABILITÀ

PIAGGIO BEVERLY 4T 4V IE EU3 350 4T 11-14, BEVERLY 4T ST IE ABS 350 4T 16-16, X10 4T 4V IE EURO3 350 4T 12-15



◀ cod. **AA00831**
Kit revisione pompa acqua Yamaha T-Max 530 cc

APPLICABILITÀ

YAMAHA T-MAX 59C 530 4T 12-16, T-MAX 59C ABS 530 4T 12-16, T-MAX 59C SP 530 4T 15-15, T-MAX 59C SP ABS 530 4T 15-16, XP530-A T-MAX SX 530 4T 17-19, XP530D-A T-MAX DX 530 4T 17-19, XP530E-A T-MAX 530 4T 17-18



◀ cod. **AA00832**
Kit Revisione Pompa Acqua Yamaha Xenter 125/150 cc

APPLICABILITÀ

YAMAHA XC125R MAJESTY S 125 4T 14-14, XENTER 125 4T 12-17, XENTER 150 4T 12-16



◀ cod. **AA00833**
Kit Revisione Pompa Acqua Kymco Downtown 300 cc

APPLICABILITÀ

KYMCO DOWNTOWN I 200 4T 10-10, PEOPLE GTI 200 4T 10-10, DOWNTOWN ABS 300 4T 10-10, DOWNTOWN I 300 4T 09-09, DOWNTOWN I 300 4T 11-11, DOWNTOWN I ABS 300 4T 11-16, PEOPLE GTI 300 4T 10-11

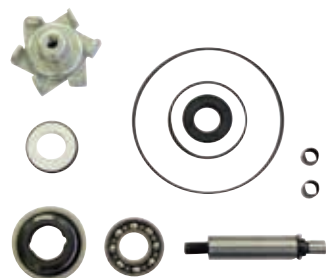

◀ cod. **AA00834**
Kit Revisione Pompa Acqua Honda PCX 125 cc

APPLICABILITÀ

HONDA PCX 125 4T-2V 10-13, SH I ABS 125 4T-2V 13-17, PCX 150 4T-2V 13-17, SH I ABS 150 4T-2V 13-17



◀ cod. **AA00835**
Kit Revisione Pompa Acqua Kymco Downtown 125 cc

APPLICABILITÀ

KYMCO DOWNTOWN I 125 4T 09-16



◀ cod. **AA00836**
Kit Revisione Pompa Acqua Honda Silver Wing 400/600 cc

APPLICABILITÀ

HONDA SILVER WING [FJS] 400 4T 06-08, SW-T [FJS] 400 4T 09-13, SILVER WING [FJS] 600 4T 01-10, SW-T [FJS] 600 4T 11-13

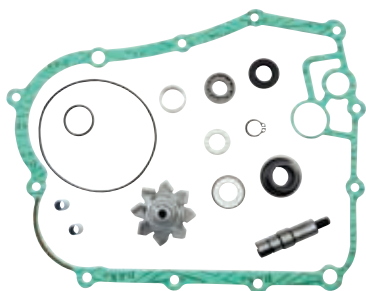

◀ cod. **AA00837**
Kit Revisione Pompa Acqua Kymco Xciting 400 cc

APPLICABILITÀ

KYMCO X CITING I 400 4T 15-15, X CITING I ABS 400 4T 14-15, XCITING I 400 4T 13-13



◀ cod. **AA00838**
Pompa Acqua Completa Yamaha YP 250/270 cc

APPLICABILITÀ

APRILIA	LEONARDO 250 4T 99-04, LEONARDO ST 250 4T 01-01, LEONARDO 300 4T 02-04	MBK	SKYLINER 250 4T 00-03, SKYLINER ABS 250 4T 03-03, KILIBRE 300 4T 03-06
BENELLI	VELVET 250 4T 99-03	YAMAHA	MAJESTY 250 4T 96-03, MAJESTY ABS 250 4T 03-03, MAJESTY DX 250 4T 98-99, X-CITY 250 4T 07-15, X-MAX 250 4T 05-16, X-MAX ABS 250 4T 14-15, VERSITY 300 4T 03-06
ITALJET	JUPITER 250 4T 00-02		
MALAGUTI	MADISON S 250 4T 99-01, PASSWORD 250 4T 05-06, PASSWORD EU3 250 4T 07-08		

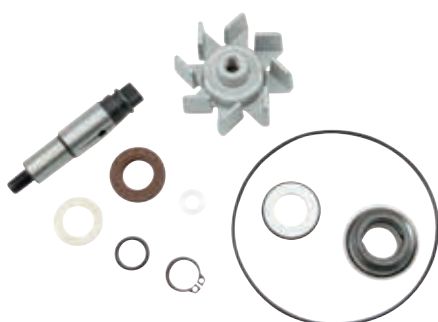

◀ cod. **AA00839**
Kit revisione pompa Acqua Bmw C 600 sport, C 650 sport/gt

APPLICABILITÀ

BMW BMW C 600 SPORT [K18] 650 4T 11-15, BMW C 650 GT 2016 [K19] 650 4T 16-16, BMW C 650 GT [K19] 650 4T 11-15, BMW C 650 SPORT 2016 [K18] 650 4T 16-16



◀ cod. **AA00840**
Kit revisione pompa acqua Kymco Xciting 500 cc

APPLICABILITÀ

KYMCO X CITING 500 4T 05-05, X CITING I 500 4T 06-08, X CITING I R 500 4T 07-08, X CITING R 500 4T 09-09

NOVITÀ



◀ **cod. TG00100**
Kit Tagliando Piaggio Liberty 125 Eu3 '07/'15

APPLICABILITÀ

DERBI SONAR 4T 125 4T 09-11, SONAR 4T 150 4T 09-09

PIAGGIO LIBERTY 4T 125 4T 06-07, LIBERTY 4T EU3 125 4T 06-08, LIBERTY 4T EU3 DELIVERY - TNT 125 4T 08-15, LIBERTY 4T SPORT EU3 125 4T 06-08, LIBERTY SPORT 125 4T 06-06, LIBERTY 4T EU3 150 4T 08-08, LIBERTY 4T SPORT EU3 150 4T 08-08



◀ **cod. TG00101**
Kit Tagliando Piaggio Beverly 250 '04/'09

APPLICABILITÀ

PIAGGIO BEVERLY 250 4T 05-07, BEVERLY CRUISER 250 4T 07-09, BEVERLY EURO 3 MIC 250 4T 07-07, BEVERLY IE EU3 250 4T 06-08, BEVERLY RST 250 4T 04-05, BEVERLY SPORT 250 4T 06-08, BEVERLY TOURER EU3 250 4T 07-09, CARNABY 250 4T 08-09



◀ **cod. TG00102**
Kit Tagliando Piaggio Beverly 300 '09/'18

APPLICABILITÀ

APRILIA SPORT CITY CUBE 250 4T 08-12, SCARABEO LIGHT 300 4T 09-10, SPORT CITY STREET 300 4T-4V 12-12

PIAGGIO BEVERLY RST 4T 4V IE EU3 300 4T 10-16, BEVERLY TOURER EU3 300 4T 09-10, CARNABY CRUISER 300 4T 09-12

DERBI RAMBLA 300 4T 10-11

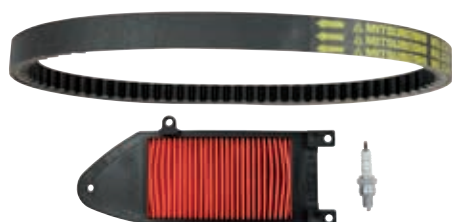

◀ **cod. TG00103**
Kit Tagliando Kymco Agility R16 125 '08/'12

APPLICABILITÀ

KYMCO AGILITY PLUS 125 4T 14-14, AGILITY PLUS E4 125 4T 16-16, AGILITY R16 125 4T 08-09, AGILITY R16 125 4T 12-12, PEOPLE 125 4T 99-00, PEOPLE EU2 125 4T 03-03, PEOPLE EU3 125 4T 07-08, PEOPLE EU3 125 4T 11-11, PEOPLE ONE E4 125 4T 16-16, PEOPLE ONE I 125 4T 13-13, PEOPLE ONE I DD 125 4T 15-15, PEOPLE S 125 4T 05-05, PEOPLE S DD EU3 125 4T 07-08, SUPER 8 125 4T 08-09, AGILITY R16 150 4T 08-09, PEOPLE 150 4T 99-00, PEOPLE EU2 150 4T 03-03



◀ cod. **TG00104**
Kit Tagliando Suzuki Burgman 400'07/'16

APPLICABILITÀ

SUZUKI AN BURGMAN K7/LO 400 4T 07-10, AN BURGMAN L1 400 4T 11-11, AN BURGMAN L2 400 4T 12-12, AN BURGMAN L3 400 4T 13-13, AN BURGMAN L4 400 4T 14-14, AN BURGMAN L5 400 4T 15-15, AN BURGMAN L6 400 4T 16-16



◀ cod. **TG00105**
Kit Tagliando Honda SH 125-150'01/'12

APPLICABILITÀ

HONDA SH 125 4T-2V 01-04, SH IE SCOOOPY 125 4T-2V 05-12, SH 150 4T-2V 01-04, SH IE SCOOOPY 150 4T 05-12



◀ cod. **TG00106**
Kit Tagliando Honda SH 300'06/'16

APPLICABILITÀ

HONDA SH IE SCOOOPY 300 4T-4V 07-16



◀ cod. **TG00107**
Kit Tagliando Yamaha T-Max 500'01/'07

APPLICABILITÀ

YAMAHA T-MAX 485 500 4T 09-11, T-MAX 485 ABS 500 4T 08-11, T-MAX 5GJ 500 4T 01-03, T-MAX 5VU 500 4T 04-08, T-MAX 5VU ABS 500 4T 05-07, T-MAX 5VU BLACK MAX 500 4T 06-06, T-MAX 5VU BLACK MAX - NIGHT MAX 500 4T 07-07



◀ cod. **TG00108**
Kit Tagliando Yamaha T-Max 530'12//16

APPLICABILITÀ

YAMAHA T-MAX 59C 530 4T 12-16, T-MAX 59C ABS 530 4T 12-16, T-MAX 59C SP 530 4T 15-15, T-MAX 59C SP ABS 530 4T 15-16



◀ cod. **TG00109**
Kit Tagliando Yamaha X-Max 250'06//16

APPLICABILITÀ

YAMAHA X-CITY 250 4T 07-15, X-MAX 250 4T 07-16, X-MAX ABS 250 4T 11-12, X-MAX ABS 250 4T 14-15, X-MAX BLACK 250 4T 09-09, X-MAX SPORT 250 4T 11-12



◀ cod. **TG00110**
Kit Tagliando Yamaha X-Max 125'06//16

APPLICABILITÀ

YAMAHA X-CITY EU3 125 4T-4V 08-11, X-MAX R 125 4T-4V 06-16, X-MAX R ABS 125 4T-4V 11-11, X-MAX RA ABS 125 4T-4V 13-16



◀ cod. **TG00111**
Kit Tagliando Piaggio Mp3 125 le'08//11 - Vespa Gts Eu3 125'07//12

APPLICABILITÀ

PIAGGIO MP3 125 4T 06-08, MP3 IBRIDO 125 4T 09-10, MP3 IE 125 4T 08-09, MP3 IE TOURING 125 4T 11-12, VESPA GRANTURISMO 125 4T 03-07, VESPA GRANTURISMO EU3 125 4T 06-07, VESPA GTS EU3 125 4T 07-12, VESPA GTV 125 4T 06-08, VESPA GTV 4T NAVY EU3 125 4T 08-08, X-EVO 125 4T 07-16, X8 PREMIUM EU2 125 4T 06-06, X8 PREMIUM EU3 125 4T 06-07, X9 EVOLUTION EU3 125 4T 07-07



◀ cod. **TG00112**
Kit Tagliando Piaggio Mp3 500 Lt Sport Business '11/'13

APPLICABILITÀ

GILERA FUOCO 4T-4V IE E3 LT 500 4T 13-14, FUOCO IE EU3 500 4T 07-13
PIAGGIO BEVERLY CRUISER 500 4T 07-12, MP3 LT SPORT/BUSINESS 500 4T 11-13, MP3 RL SPORT-BUSINESS 500 4T 11-12, X10 4T-4V IE EU3 500 4T 12-14



◀ cod. **TG00118**
Kit Tagliando Suzuki Burgman 125 Dal 2013

APPLICABILITÀ

SUZUKI UH BURGMAN K7/LO 125 4T 07-10, UH BURGMAN L1 125 4T 11-11, UH BURGMAN L3 125 4T 13-13, UH BURGMAN L4 125 4T 14-14, UH BURGMAN L6 125 4T 16-16, UH BURGMAN L7 125 4T 17-17, UH BURGMAN L8 125 4T 18-18, UH BURGMAN L9 125 4T 19-19



◀ cod. **TG00119**
Kit Tagliando Suzuki Burgman 650 '06/'18

APPLICABILITÀ

SUZUKI AN BURGMAN K3-K5 650 4T 03-05, AN BURGMAN K6-LO 650 4T 06-10, AN BURGMAN L1 650 4T 11-11, AN BURGMAN L2 650 4T 12-12, AN BURGMAN L3 650 4T 13-13, AN BURGMAN L4 650 4T 14-14, AN BURGMAN L5 650 4T 15-15, AN BURGMAN L6 650 4T 16-16, AN650Z BURGMAN 650 4T 18-18

MOTORPARTS



KIT	RICAMBI		
	CATENA	CORONA	PIGNONE

APRILIA	SHIVER	750	4T	07 > 08	PEK1101G	PEK525SROZ2110	P436344C45	P21501618NC
	MANA	850	4T	07 > 12	PEK1102G	PEK525SROZ2104	P444740C45	P21481818NC
	RS4	125	4T	13 > 13	PEK1122	PEK428DEH136	P460660C45	P22231318NC
	RS4	125	4T	15 > 15	PEK1126	PEK428DEH136	P460660C45	P22891318NC
	RED ROSE	50	2T	92 > 01	PEK131	PEK415SH130	P356446F	P5991218NC
	RX	50	2T	96 > 98	PEK142	PEK415SH126	P356551F	P6001218NC
	RS REPLICA	125	2T	93 > 02	PEK145	PEK520110	P71439C45	P4061718NC
	RS REPLICA	125	2T	93 > 02	PEK145-Z40-16			
	PEGASO	650	4T	91 > 97	PEK164G	PEK520SR06110	P355247C45	P4021618NC
	ETV CAPO NORD	1000	4T	03 > 03	PEK166G	PEK525MVXZ2112	P442745C45	P20781718NC
	RS	125	2T	06 > 06	PEK187	PEK520110	P439640C45	P4061718NC
	RS	125	2T	06 > 06	PEK187-Z40-16			
	RS	50	2T	06 > 06	PEK189	PEK420SR132	P441253F	P21531218NC
BMW	F800GS	800		08 > 08	PEK1200G	PEK525SROZ2116	P455042C45	P20781618NC
	F800GS	800		10 > 10	PEK1214G	PEK525SROZ2116	P461342C45	P20781618NC
	F800R	800		09 > 14	PEK1261G	PEK525SROZ2120	P461347C45	P2078M2018NC
	F GS	650		04 > 04	PEK182G	PEK520SR06112	P355247C45	P4021618NC
CAGIVA	SST	125		82 > 85	PEK205	PEK428DEH136	P70462F	P4161418NC
	ELEFANT	125		85 > 86	PEK206	PEK428DEH124	P48645C45	P7101618NC
DERBI	GP1	50		05 > 08	PEK1290	PEK420H134	P441245F	P21071218NC
DERBI	GPR R	50		05 > 08	PEK1295	PEK420H134	P441253F	P21071218NC
	GPR 4T	125		11 > 11	PEK2292	PEK428H130	P460749C45	P21181418NC
DUCATI	696 MONSTER	696		09 > 09	PEK1310G	PEK520MVXZ2108	P102745C45	P490BL1518N
	MULTISTRADA	1200		10 > 12	PEK1337G	PEK530ZVX3110	P464340LD	P22541518NC
	MONSTER	600		95 > 99	PEK315G	PEK520SRX2102	P102743C45	P4901518NC
	MONSTER	900		94 > 99	PEK319G	PEK520MVXZ298	P102739C45	P4901518NC
	MONSTER	600		00 > 01	PEK336G	PEK520SRX2102	P102746C45	P4901518NC

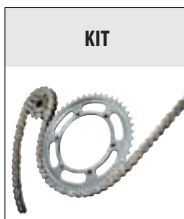
MOTORPARTS

RICAMBI			
KIT	CATENA	CORONA	PIGNONE

DUCATI	MONSTER	620		02 > 03	PEK358G	PEK520MVXZ2106	P102746C45	P490BL1518N
	MONSTER I.E.	620		00 > 00	PEK375G	PEK520MVXZ2106	P102748C45	P490BL1518N
FANTIC	CABALLERO MOTARD	125		08 > 11	PEK1354	PEK428DEH140	P450254L5	P21821418NC
GILERA	GP	800		07 > 11	PEK453G	PEK525SROZ2104	P455747C45	P21962218NC
HM	CRE SIX, BAIA, DERAPAGE	50		04 > 06	PEK1549	PEK428DEH140	P441362L	P2064M1418N
	CRE SIX, BAIA, DERAPAGE	50		04 > 06	PEK2521	PEK428DEH140	P441362L	P2064M1218N
	CRE ENDURO	50		02 > 02	PEK580		P439056F	P20641218NC
	CRE SIX, BAIA, DERAPAGE	50		02 > 02	PEK581	PEK428DEH140	P439056F	P20641318NC
HONDA	VT C SHADOW	125		02 > 02	PEK1516	PEK520114	P466841C45	P2791418NC
	XL LM-F/RM-G	600		85 > 88	PEK1536G	PEK520SRX2106	P24541C45	P2811518NC
	XL V TRANSALP	650		00 > 02	PEK1540G	PEK525SROZ2118	P30048C45	P3461518NC
	CB HORNET	900		02 > 03	PEK1544G	PEK530SROZ2114	P40843C45	P3471618NC
	XL V VARADERO	125		02 > 02	PEK1552	PEK520SR110	P466844C45	P2791418NC
	CBR RR	600		03 > 06	PEK1557G	PEK525SROZ2114	P440542C45	P20681618NC
	CBF N(S) (ABS)	600		04 > 04	PEK1574G	PEK525SROZ2116	P435743C45	P20731518NC
	CB HORNET	600		07 > 09	PEK2507G	PEK525SROZ2118	P435743C45	P20681618NC
	XL V TRANSALP	700		08 > 08	PEK2511G	PEK525MVXZ2118	P30047C45	P3461518NC
	CB R (ABS)	1000		08 > 09	PEK2514G	PEK530MVXZ2116	P456244C45	P3471618NC
	INTEGRA	700		12 > 13	PEK2538G	PEK520SRX2112	P438439C45	P20421618NC
	INTEGRA	700		12 > 13	PEK2538GOM			
	CB F,X, ABS, CBR R	500		13 > 14	PEK2541G	PEK520SRO6112	P438441C45	P20421518NC
	NC X	750		14 > 15	PEK2544G	PEK520SRX2114	P438443C45	P20421718NC
	NC X	750		14 > 15	PEK2544GOM			
	NC D INTEGRA	750		15 > 15	PEK2545G	PEK520SRX2114	P438439C45	P20421718NC
	CRF 1000 L AFRICA TWIN ABS	1000		17 > 17	PEK2550G	PEK525MVXZ2124	P435042C45	P20681618NC
	CTX N	700		14 > 14	PEK2620GOM			
	NC D INTEGRA	750		15 > 15	PEK3144GOM			

MOTORPARTS



KIT	RICAMBI		
	CATENA	CORONA	PIGNONE

MARCHIO	MODELLO	CC	ANNO	KIT	RICAMBI		
					CATENA	CORONA	PIGNONE
HONDA	XL VK TRANSALP	600	89 > 00	PEK517G	PEK525SROZ2118	P30047C45	P3461518NC
	VT C SHADOW	600	90 > 02	PEK539G	PEK525SROZ2120	P435044C45	P3461618NC
	XRV AFRICA TWIN	750	93 > 01	PEK541G	PEK525SROZ2124	P435045C45	P3481618NC
	CA REBEL	125	95 > 99	PEK548	PEK520114	P27939C45	P3291318NC
	NX S	650	95 > 00	PEK567G	PEK520SR06110	P23646C45	P3451518NC
	CB S	500	98 > 00	PEK574G	PEK525SROZ2108	P435040C45	P20411518NC
HONDA	CB HORNET	600	97 > 04	PEK575G	PEK525SROZ2110	P435742C45	P20731518NC
	VT C SHADOW	750	97 > 09	PEK577G	PEK525SROZ2122	P435741C45	P22681718NC
HUSQVARNA	SM	125	10 > 12	PEK1993	PEK428DEH136	P459054C45	P21821418NC
	SM S	610	09 > 09	PEK2904G	PEK520SR06112	P82045C45	P7271518NC
HYOSUNG	GV AQUILA	250	04 > 05	PEK2931	PEK520SR116	P454046C45	P21931418NC
KAWASAKI	ZR-7 ZR-7S	750	99 > 01	PEK1640G	PEK525SROZ2108	P530138C45	P5821618NC
	Z /S-ZR-ABS	750	12 > 12	PEK1656G	PEK520MVXZ2112	P47843C45	P21191518NC
	NINJA ZX-6R	600	05 > 06	PEK1688G	PEK520MVXZ2112	P47843C45	P2093M1518N
	ER-6N	650	06 > 06	PEK1695G	PEK520SR06114	P47846C45	P5651518NC
KAWASAKI	KLE VERSYS	650	07 > 09	PEK2602G	PEK520SR06114	P47846C45	P5651518NC
	KLE VERSYS	650	07 > 09	PEK3106GOM			
KTM	DUKE	125	14 > 15	PEK2979	PEK520SR120	P467545C45	P22471418NC
MALAGUTI	FIFTY TOP	50	90 > 99	PEK1151	PEK415SH110	P334F	P1471318NC
MOTOCROSS	CNK DRAGON	50	05 > 08	PEK1166	PEK420H134	P453148F	P600M1118NC
	RIEJU	MRX	50	05 > 05	PEK2682	PEK420H134	P440252F
RIEJU	SMX E.S./K.S.	50	07 > 07	PEK2685	PEK420H134	P455152F	P600M1118NC
	SUZUKI	GS-E X	500	99 > 04	PEK1759G	PEK520SR06110	P79539C45
SUZUKI	GSF-Y BANDIT	600	00 > 05	PEK1760G	PEK530SROZ2112	P82447C45	P5661518NC
SUZUKI	DL V-STROM	1000	02 > 03	PEK1761G	PEK525MVXZ2112	P439842C45	P5641718NC
SUZUKI	DL V-STROM	650	04 > 04	PEK1771G	PEK525SROZ2116	P439847C45	P5641518NC
SUZUKI	GSX-R	600	06 > 09	PEK1779G	PEK525SROZ2114	P439843C45	P5641618NC

KIT TRASMISSIONE

MOTORPARTS



					RICAMBI			
					KIT	CATENA	CORONA	PIGNONE
SUZUKI	GSR	600		06 > 06				
	SFV GLADIUS	650		09 > 09				
	DL V-STROM-ABS	650		07 > 09				
	VZ800 MARAUDER	800		97 > 98				
	SV	650		99 > 02				
YAMAHA	SV S	650		99 > 00				
	TDM (ABS)	900		02 > 02				
	FZ6 FAZER S2 ABS	600		04 > 04				
	XT-R	660		04 > 14				
	MT-03	660		06 > 12				
	YZF-R IE	125		08 > 10				
	TRICKER	250		06 > 08				
	WR-X/R-Y-E	125		09 > 09				
	MT-09	850		15 > 15				
	XT	600		87 > 94				
	XT E	600		90 > 00				
	XT Z SUPER TENERE	750		89 > 90				



		PART NUMBER	DESCRIZIONE	ECE	V	W	ATTACCO	Q.TÀ
	NIGHT RACER® 110 Lampade Moto Più 110% di luce e 20% più bianca	64193NR1-01B	NIGHT RACER® 110 H4 12V BLI1	H4	12	60/55	P43t	1
		64193NR1-02B	NIGHT RACER® 110 H4 12V BLI2	H4	12	60/55	P43t	2
		64210NR1-01B	NIGHT RACER® 110 H7 12V BLI1	H7	12	55	PX26d	1
		64210NR1-02B	NIGHT RACER® 110 H7 12V BLI2	H7	12	55	PX26d	2
		64212NR1-01B	NIGHT RACER® 110 H8 12V BLI1	H8	12	35	PGJ19-1	1
		64211NR1-01B	NIGHT RACER® 110 H11 12V BLI1	H11	12	55	PGJ19-2	1
	NIGHT RACER® 90 Lampade Moto Più 90% di luce e 20% più bianca	64185NR9-01B	NIGHT RACER® 90 HS1 12V BLI1	HS1	12	35/35	PX43t	1
	NIGHT RACER® 50 Lampade Moto Più 50% di luce	64193NR5-01B	NIGHT RACER® 50 H4 12V BLI1	H4	12	60/55	P43t	1
		64210NR5-01B	NIGHT RACER® 50 H7 12V BLI1	H7	12	55	PX26d	1
		64211NR5-01B	NIGHT RACER® 50 H11 12V BLI1	H11	12	55	PGJ19-2	1
		64185NR5-01B	NIGHT RACER® 50 HS1 12V BLI1	HS1	12	35/35	PX43t	1
		64185NR5	NIGHT RACER® 50 HS1 12V	HS1	12	35/35	PX43t	1
	X-RACER® Lampade Moto Xenon Look Più 20% di luce fino a 4200K	64193XR-01B	X-RACER® H4 12V BLI1	H4	12	60/55	P43t	1
		64193XR-02B	X-RACER® H4 12V BLI2	H4	12	60/55	P43t	2
		64210XR-01B	X-RACER® H7 12V BLI1	H7	12	55	PX26d	1
		64210XR-02B	X-RACER® H7 12V BLI2	H7	12	55	PX26d	2
		64212XR-01B	X-RACER® H8 12V BLI1	H8	12	35	PGJ19-1	1
		64211XR-01B	X-RACER® H11 12V BLI1	H11	12	55	PGJ19-2	1
		64185XR-01B	X-RACER® HS1 12V BLI1	HS1	12	35/35	PX43t	1
		64327XR-01B	X-RACER® S2 12V BLI1	S2	12	35/35	BA20d	1
	ORIGINAL LINE LAMPADE MOTO OEM QUALITY	64193MC	ORIGINAL MOTO H4 12V	H4	12	60/55	P43t	1
		64210MC	ORIGINAL MOTO H7 12V	H7	12	55	PX26d	1
		64326	ORIGINAL S1 12V	S1	12	25/25	BA20d	1
		64327	ORIGINAL S2 12V	S2	12	35/35	BA20d	1
		64327-01B	ORIGINAL S2 12V BLI1	S2	12	35/35	BA20d	1
		64185	ORIGINAL HS1 12V	HS1	12	35/35	PX43t	1<<

Kit Led Headlight - Led headlight kit

HEADLIGHT SIMPLY | 12 Volt | 15W | 1500 Lumen | 6500° K CCT Operating Temperature -40° + 80°

	CODE	CHIP	RETROFIT	Q.TÀ
	LP417577	LP CSP	H7	

HEADLIGHT K2 | 9-32 Volt | 30 W | 5000 Lumen | 6500° K CCT Operating Temperature -45° + 115°

	CODE	CHIP	RETROFIT	Q.TÀ
	LP4172841	PHILIPS ZES	HS1 - H4	
	4172871	PHILIPS ZES	HS1 - H4	

HEADLIGHT BASIC PLUS | 12 Volt | 28 W | 3200 Lumen | 6500° K CCT Operating Temperature -40° + 80°

	CODE	CHIP	RETROFIT	Q.TÀ
		FLIP COB	H1 - H4 - H7 - H8/9/11	

HEADLIGHT B | 12-24 Volt | 36W | 8000 Lumen | 6500° K CCT Operating Temperature -40° +80°

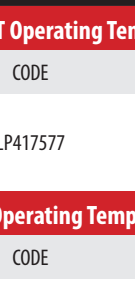
	CODE	CHIP	RETROFIT	Q.TÀ
	LP39362	TYPE COB	H1	1
	LP39125	TYPE COB	H7	1
	LP39124	TYPE COB	H4	1
	LP39126	TYPE COB	H8 - H9 - H11	1

HEADLIGHT TOKYO | 12-24 Volt | 42 W | 8000 Lumen | 6500° K CCT Operating Temperature -40° +80°

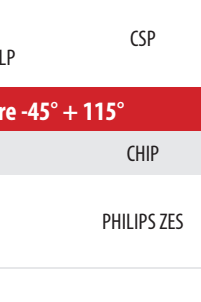
	CODE	CHIP	RETROFIT	Q.TÀ
	LP39627	TYPE CREE XHP50	H1	1
	LP39630	TYPE CREE XHP50	H3	1
	LP39614	TYPE CREE XHP50	H4	1
	LP39659	TYPE CREE XHP50	H7	1
	LP39288	LP TYPE CREE XHP50	H8 - H9 - H11	1
	LP39616	TYPE CREE XHP50	HB3 - 9005	1
	LP39619	TYPE CREE XHP50	HB4 - 9006	1

KIT PREMIUM STATIC | 12-24 Volt | 25 W | 4000Lumen | 6500° K CCT Operating Temperature -40° +80°

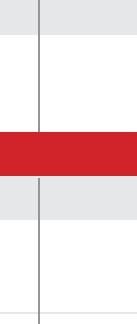
	CODE	CHIP	RETROFIT	Q.TÀ
	LP39665	TYPE ZES	H1	1
	LP39663	TYPE ZES	H4	1
	LP39667	TYPE ZES	H7	1
	LP39661	TYPE ZES	H8 - H9 - H11	1

KIT PREMIUM AVIO | 12-24 Volt | 25 W | 4000Lumen | 6500° K CCT Operating Temperature -40° +80°

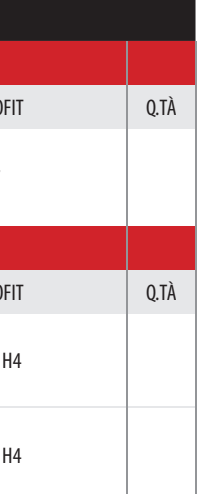
	CODE	CHIP	RETROFIT	Q.TÀ
	LP39689	TYPE ZES	H1	1
	LP39093	TYPE ZES	H3	1
	LP39688	TYPE ZES	H4	1
	LP39287	TYPE ZES	H7	1
	LP39669	TYPE ZES	H8 - H9 - H11	1
	LP39679	TYPE ZES	HB3 - 9005	1
	LP39681	TYPE ZES	HB4 - 9006	1

KIT PREMIUM AVIO 2 | 12-24 Volt | 30 W | 6000 Lumen | 6500° K CCT Operating Temperature -40° +80°

CODE	CHIP	RETROFIT	Q.TÀ
LP39879	TYPE ZES 2	H1	1
LP39883	TYPE ZES 2	H3	1
LP39885	TYPE ZES 2	H4	1
LP39891	TYPE ZES 2	H7	1
LP39899	TYPE ZES 2	H8 - H9 - H11	1
LP39887	TYPE ZES 2	HB3 - 9005	1
LP39889	TYPE ZES 2	HB4 - 9006	1







KIT NEW FASHION | 8-32 Volt | 12W | 1050Lumen | 6500° K CCT Operating Temperature -40° +80°

CODE	CHIP	RETROFIT	Q.TÀ
LP39558	TYPE COB	BA20d	1







Lampade LED - Led Lamps
LED SMD -COB | 12 Volt

	CODE	VOLT	LED	BASE	RETROFIT	NOTE	Q.TÀ
	LP39204	12	Led Bianco / white	W2,1X9,5d	T10		2
	LP39121	12	Led Bianco / white	BA9s	T4W		2
	LP39537	12	1 SMD EPISTAR	BA9s	R5W		2

LED SMD -CANBUS | 12 Volt





	CODE	VOLT	LED	BASE	RETROFIT	NOTE	Q.TÀ
	LP39205	12	1 SMD EPISTAR	W2,1X9,5d	T10		2
	LP39206	12	8 SMD EPISTAR	W2,1X9,5d	T10	BMW, Mini...	2
	LP39469	12	SMD EPISTAR	W2,1X9,5d	T10	AMBER	2
	LP39421	12	5 SMD EPISTAR	BA9s	R5W		2
	LP39181	12	8 SMD EPISTAR	BAX9s	H6W		2
	LP39212	12	4 SMD EPISTAR	SV8,5-8	Festoon	12x38 mm	2
	LP39213	12	3 SMD EPISTAR	SV8,5-8	Festoon	12x36 mm	2

LAMPADE TOPLIGHT

	LP39215	12	6 SMD EPISTAR	SV8,5-8	Festoon	16x36 mm	2
	LP39216	12	27 SMD EPISTAR	BA15s	P21/W	1 LUCE / LIGHT 1156	2
	LP39217	12	27 SMD EPISTAR	BAY15d	P21/5W	2 LUCI / LIGHTS 1157	2
	LP39218	12	1 LUCE / LIGHT EPISTAR	W3X16d	T20W21W		2
	LP39568	12	2 LUCI / LIGHTS EPISTAR	W3X16d	T20 W21/5W		2
	LP41368	12		BA15S	P21W	AMBER	2
	LP41369	12		BAU15S	P21W	AMBER	2
	LP41375	12		BAY15d	P21W	AMBER	3

Lampade Energy White

LAMPADE PER PROIETTORI ENERGY WHITE 4000 K - LAMPS

	CODE	VOLT	WATT	BASE	ECE	NOTE	Q.TÀ
	LP39060	12	55	P14,5s	H1		2
	LP39191	12	55	PK22s	H3		2
	LP39061	12	60/55	P43t	H4		2
	LP39062	12	55	PX26d	H7		2

LAMPADE PER PROIETTORI ENERGY WHITE 4000 K - LAMPS







	CODE	VOLT	WATT	BASE	ECE	NOTE	Q.TÀ
	LP39164	12	65	P20d	HB3	9005	2
	LP39165	12	55	P22d	HB4	9006	2
	LP39183	12	35	PGJ19-1	H8		2
	LP39063	12	55	PGJ19-2	H11		2
	LP39344	12	35/30	P23t	HS5		1

LAMPADE AUSILIARIE ENERGY WHITE · AUXILIARY BULBS							
	CODE	VOLT	WATT	BASE	ECE	NOTE	Q.TÀ
	LP39139	12	5	W2,1X9,5d	W5W	4000K T10 PAINTED	10
	LP39286	12	5	W2,1X9,5d	W5W	5000K T10 ORIGINAL GLASS	2
	LP39402	12	5	SW2,1X9,5d	W5W	T10 - 4000K HALOGEN	2
	LP39348	12	21/5	W3X16q	T20	5000K	2
	LP39396	12	21	W3X16d	T20	5000K	2
	LP39159	12	21/5	W3X16q	T20	6000K CRYSTAL CROMO	2
	LP39380	12	10	BA9s	H10W	4000K	2
	LP39129	12	6	BAX9s	H6W	4000K	1
	LP39174	12	5	SV8,5	C5W	6000K 11x38 mm CRYSTAL CROMO	2
	LP39176	12	5	SV8,5	C5W	4000K 11X38	2







Lampade Standard

LAMPADE PER PROIETTORI STANDARD - STANDARD LAMPS | 12Volt

	CODE	VOLT	WATT	BASE	ECE	NOTE	Q.TÀ
	LP39042	12	55	PX26d	H7	PREMIUM	1
	LP39001	12	60/55	P43t	H4		1
	LP39008	12	55	P14,5s	H1		1
	LP39023	12	55	PK22s	H3		1
	LP39025	12	55	PGJ19-2	H11		1
	LP39026	12	65	P20d	HB3	9005	1
	LP39031	12	55	P22d	HB4	9006	1

LAMPADE PER PROIETTORI STANDARD - STANDARD LAMPS | 6-12 Volt

	CODE	VOLT	WATT	BASE	ECE	NOTE	Q.TÀ
	LP39343	12	35/30	P23t	HS5		1
	LP39028	12	35	PGJ19-1	H8		1
	LP39349	12	35/35	BA20d	S2		1
	LP39350	12	45/40	BA20d			1
	LP39555	6	25/25	BA20d			1
	LP39353	12	35/35	PX43t	HS1		1
	LP39368	12	15	P26s	S3		10
	LP39556	6	15	P26s	S3		10

LAMPADE AUSILIARIE - AUXILIARY BULBS 12 Volt							
	CODE	VOLT	WATT	BASE	ECE	NOTE	Q.TÀ
	LP39003	12	21/5	BAY15d	P21/5W		10
	LP39004	12	21	BA15s	P21W		10
	LP39345	12	21	BA15s	PY21W	AMBER PAINTED	10
	LP39014	12	21	BAU15s	PY21W	AMBER PAINTED	10
	LP39357	12	21	BA15s	PR21W	ROSSA RED	10
	LP39560	12	21/5	BAY15d	PR21/5W	ROSSA RED	2
	LP39005	12	5	BA15s	R5W		10
	LP39011	12	10	BA15s	R10W		10
	LP39111	12	2	BA9s	T2W		10
	LP39012	12	4	BA9s	T4W		10
	LP39007	12	5	SV8,5	C5W	10,5x38 mm	10
	LP39096	12	3	SV7	C3W	7,5x30 mm	10
	LP39013	12	3	W2,1X9,5d	W3W	T10	10
	LP39002	12	5	W2,1X9,5d	W5W	T10	10
	LP39108	12	5	W2,1X9,5d	WY5W	T10 - AMBER	10
	LP39018	12	16	W2,1X9,5d	W16W	T15	10
	LP39019	12	21/5	W3X16q	W21/5W	T20	10
	LP39020	12	21	W3X16d	W21W	T20	10
	LP39138	12	21	W3X16d	WY21W	T20 - AMBER painted	10

LAMPADE TOPLIGHT

	LP39192	12	21/5	W3X16q	WY5/21W	T20 - ROSSA RED	1
	LP39015	12	6	BAX9s	H6W		10
	LP39351	12	10	BA9s	H10W		1
	LP39022	12	21	BAY9s	H21W		1

Fari da lavoro - Led Worklights



FARI DA LAVORO A LED - LED WORKLIGHTS | 10/30 Volt

	CODE	DESCRIZIONE / DESCRIPTION	LED	WATT	LUMEN	Q.TÀ
	LP39127	FARETTO UNIVERSALE A LED IP67 LENTE IN PC / LED WORK LIGHT IP 67 PC LENS	9 LED EPISTAR	27	1750	1
	LP39222	FARETTO UNIVERSALE A LED TONDO IP67 LENTE IN PC / LED WORK LIGHT IP 67 PC LENS	9 LED EPISTAR	27	1750	1
	LP39266	BASE MAGNETICA UNIVERSALE Max 50kg Max 120 km/h / MAGNETIC BASE				1

LAMPADE DA OFFICINA - LAMPS FOR WORKSHOPS

	CODE	DESCRIZIONE / DESCRIPTION	Q.TÀ
	LP39267	LAMPADA DA OFFICINA / INSPECTION LAMP SMARTLite	1
	LP39268	PENNA LUMINOSA / LIGHT PEN SMARTLite Mini	1
	LP39269	ESPOSITORE / DISPLAY SMARTLite Mini	10

LAMPADE DA LAVORO - LAMPS FOR WORKLIGHTS | 3.7 Volt

	CODE	DESCRIZIONE / DESCRIPTION	LED	WATT	LUMEN	Q.TÀ
	LP39927	SMARTLite POCKET	2W COB + 1W Torcia	Li-ion 14500 type Li-ion 3.7V 800mAh	220 Lumen per la lampada 60 Lumen per la torcia	
	LP39929	SMARTLite BASIC	2W COB	Li-ion 18650 type Li-ion 3.7V 2200mAh	220	
	LP39932	SMARTLite HEAD	3W COB	Li-Poly 3.7V 1400mAh	2 ore a 260 Lumen 4 ore a 120 Lumen	



◀ **cod. MC12001**
Membrana carburatore per scooter Minarelli/Yamaha 250/300 cc

RIFERIMENTO ORIGINALE

Yamaha	4HC143400100
--------	--------------

APPLICABILITÀ

APRILIA	LEONARDO 250 4T 99-04, LEONARDO ST 250 4T 01-01, LEONARDO 300 4T 02-04	MBK	SKYLINER E 125 4T 03-03, SKYLINER E 180 4T 03-03, SKYLINER 250 4T 00-03, SKYLINER ABS 250 4T 03-03, KILIBRE 300 4T 03-06
BENELLI	VELVET 250 4T 99-03	YAMAHA	MAJESTY E 125 4T 03-09, MAJESTY E 180 4T 03-06, MAJESTY 250 4T 96-03, MAJESTY ABS 250 4T 03-03, MAJESTY DX 250 4T 98-99, VERSITY 300 4T 03-06
ITALJET	JUPITER 250 4T 00-02		
MALAGUTI	MADISON R RESTYLING EU2 125 4T 03-04, MADISON S 250 4T 99-01		

◀ **cod. MC12002**
Membrana carburatore per scooter Piaggio 125 cc

RIFERIMENTO ORIGINALE

Piaggio	CM140501
---------	----------

APPLICABILITÀ

APRILIA	MOJITO 125 4T 03-08, MOJITO 150 4T 03-07	PIAGGIO	BEVERLY 125 4T 01-03, HEXAGON GTX 125 4T 00-00, LIBERTY 125 4T 98-02, SKYPPER 4T 125 4T 00-02, VESPA ET4 125 4T 96-02, X9 125 4T 01-02, ZIP 125 4T 00-02, LIBERTY 150 4T 01-02, SKYPPER 4T 150 4T 00-02, VESPA ET4 150 4T 99-02, HEXAGON GTX 180 4T 00-00
DERBI	BOULEVARD EU2 125 4T 04-07, BOULEVARD 150 4T 03-04		



◀ **cod. MC12004**
Membrana Carburatore Honda SH 125/150 cc

RIFERIMENTO ORIGINALE

Honda	16111-KFG-911
-------	---------------

APPLICABILITÀ

HONDA	@ [NES] 125 4T 00-06, DYLAN [SES] 125 4T 02-04, SH 125 4T-2V 01-04, @ [NES] 150 4T 00-06, DYLAN [SES] 150 4T 02-04, SH 150 4T-2V 01-04
--------------	--



◀ **cod. MC12005**
Membrana Carburatore Sym Symphony 125-150 cc

RIFERIMENTO ORIGINALE

Sym	16142Z7A000
-----	-------------

APPLICABILITÀ

SYM	SYMPHONY S 125 4T 12-14, SYMPHONY SR 125 4T 12-12, SYMPHONY S 150 4T 12-14, SYMPHONY SR 150 4T 12-12
------------	--



◀ **cod. MC12009**
Membrana carburatore KYMCO AGILITY 50 cc 4T

RIFERIMENTO ORIGINALE

Kymco	00105115
-------	----------

APPLICABILITÀ

KYMCO	AGILITY 4T CARRY 50 4T 11-11, AGILITY 4T R10 50 4T 06-08, AGILITY 4T R12 50 4T 07-08, AGILITY PLUS 4T 50 4T 14-14, AGILITY R12 50 4T 05-05, AGILITY R16 50 4T 08-09, AGILITY R16 50 4T 12-12, AGILITY RS 50 4T 09-09, DINK 50 4T 50 4T 07-07, LIKE 50 4T 09-09, SUPER 8 4T 50 4T 07-07, SUPER 8 4T 50 4T 09-09, SUPER 8 4T 50 4T 13-13
--------------	--



cod. MC12100

Membrana Carburatore Adattabile a Yamaha Majesty 125-150 cc '98-'02

RIFERIMENTO ORIGINALE

Honda	5D51434A1000
-------	--------------

APPLICABILITÀ

BENELLI VELVET 125 4T 99-01, VELVET 150 4T 99-01

ITALJET JUPITER 125 4T 01-02, MILLENIUM 125 4T 00-02, JUPITER 150 4T 01-02, MILLENIUM 150 4T 00-02

MALAGUTI MADISON 125 4T 99-01, MADISON R RESTYLING 125 4T 02-02, PHANTOM MAX 125 4T 03-03, MADISON T 150 4T 99-01

MBK

DOODO 125 4T 00-00, SKYLINER 125 4T 98-02, THUNDER 125 4T 01-02, DOODO 150 4T 01-02, THUNDER 150 4T 01-02

YAMAHA

MAJESTY 125 4T 98-00, MAJESTY (5NR1) 125 4T 01-01, MAJESTY (5NR8) 125 4T 02-02, MAXSTER 125 4T 01-02, TEO'S 125 4T 00-00, MAJESTY 150 4T 00-00, MAJESTY (5NS1) 150 4T 01-01, MAJESTY (5NS6) 150 4T 02-02, MAXSTER 150 4T 01-02, TEO'S 150 4T 01-02



cod. MC12101

Membrana Carburatore adattabile a scooter Minarelli/Yamaha 250/300 cc

RIFERIMENTO ORIGINALE

Yamaha	4HC143400100
--------	--------------

APPLICABILITÀ

APRILIA LEONARDO 250 4T 99-04, LEONARDO ST 250 4T 01-01, LEONARDO 300 4T 02-04

BENELLI VELVET 250 4T 99-03

ITALJET JUPITER 250 4T 00-02

MALAGUTI MADISON R RESTYLING EU2 125 4T 03-04, MADISON S 250 4T 99-01

MBK

SKYLINER E 125 4T 03-03, SKYLINER E 180 4T 03-03, SKYLINER 250 4T 00-03, SKYLINER ABS 250 4T 03-03, KILIBRE 300 4T 03-06

YAMAHA

MAJESTY E 125 4T 03-09, MAJESTY E 180 4T 03-06, MAJESTY 250 4T 96-03, MAJESTY ABS 250 4T 03-03, MAJESTY DX 250 4T 98-99, VERSITY 300 4T 03-06



cod. MC12103

Membrana Carburatore adattabile a Kymco Agility 125/150 cc

RIFERIMENTO ORIGINALE

Kymco	00105036
-------	----------

APPLICABILITÀ

KYMCO AGILITY 125 4T 06-06, AGILITY R16 125 4T 08-09, DINK EU3 125 4T 06-07, LIKE 125 4T 09-09, MOVIE EU3 125 4T 06-07, MOVIE XL EU2 125 4T 03-04, PEOPLE EU2 125 4T 03-03, PEOPLE EU3 125 4T 07-08, PEOPLE EU3 125 4T 11-11, PEOPLE S 125 4T 05-05, PEOPLE S DD EU3 125 4T 07-08, SUPER 8 125 4T 08-08, AGILITY R16 150 4T 08-09, MOVIE EU3 150 4T 06-07, MOVIE XL EU2 150 4T 03-04, PEOPLE EU2 150 4T 03-03, LIKE LX 200 4T 12-12, PEOPLE S 200 4T 05-05



cod. MC12104

Membrana Carburatore adattabile a Honda SH 125/150 cc

RIFERIMENTO ORIGINALE

Honda	16111-KGF-911
-------	---------------

APPLICABILITÀ

HONDA @ [NES] 125 4T 00-06, DYLAN [SES] 125 4T 02-04, SH 125 4T-2V 01-04, @ [NES] 150 4T 00-06, DYLAN [SES] 150 4T 02-04, SH 150 4T-2V 01-04



◀ **cod. MC12105**
Membrana carburatore adattabile a scooter Sym Symphony 125/150 cc

RIFERIMENTO ORIGINALE

Sym	16142Z7A000
-----	-------------

APPLICABILITÀ

SYM SYMPHONY S 125 4T 12-14, SYMPHONY SR 125 4T 12-12, SYMPHONY S 150 4T 12-14, SYMPHONY SR 150 4T 12-12



◀ **cod. MC12106**
Membrana carburatore adattabile scooter Aprilia scarabeo 125 cc

RIFERIMENTO ORIGINALE

Aprilia	AP8575049
---------	-----------

Piaggio	CM140301
---------	----------

APPLICABILITÀ

APRILIA ATLANTIC 125 4T 03-05, ATLANTIC EU3 125 4T 06-08, ATLANTIC EU3 125 4T 10-12, SCARABEO 125 4T 04-06, SCARABEO EU3 125 4T 06-07, SPORT CITY 125 4T 04-06, SPORT CITY CUBE 125 4T 08-10, SPORT CITY EU3 125 4T 06-08, SPORT CITY STREET 125 4T 12-12

DERBI GP1 EU 2 125 4T 06-06, GP1 LOW SEAT EU3 125 4T 07-08, RAMBLA 125 4T 08-09, RAMBLA EU3 2VER 125 4T 08-08

GILERA NEXUS EU3 125 4T 07-08, RUNNER 4T ST EU3 125 4T 08-16, RUNNER VX 125 4T 05-06, RUNNER VX 4T EU3 125 4T 06-07, RUNNER VX RACE 125 4T 06-06, RUNNER VX SC 125 4T 06-07, RUNNER VXR RACE 200 125 4T 06-06, RUNNER VXR 4T ST EU3 200 4T 08-11, RUNNER VXR EU3 200 4T 07-07, OREGON 250 4T 06-10

PIAGGIO BEVERLY EU3 125 4T 07-08, BEVERLY EURO 3 MIC 125 4T 07-07, BEVERLY EURO 3 SPORT 125 4T 07-08, BEVERLY RST 125 4T 05-07, BEVERLY TOURER EU3 125 4T 07-10, CARNABY 125 4T 07-10, MP3 125 4T 06-08, VESPA GRANTURISMO 125 4T 06-07, VESPA GRANTURISMO EU3 125 4T 06-07, VESPA GTS EU3 125 4T 07-12, VESPA GTV 125 4T 06-08, VESPA GTV 4T NAVY EU3 125 4T 08-08, X-EVO 125 4T 07-16, X7 EU3 125 4T 08-08, X8 125 4T 05-06, X8 PREMIUM EU2 125 4T 06-06, X8 PREMIUM EU3 125 4T 06-07, X9 EVOLUTION 125 4T 05-06, X9 EVOLUTION EU3 125 4T 07-07, CARNABY 200 4T 07-08, VESPA GRANTURISMO 200 4T 03-07, X8 200 4T 05-07, BEVERLY 250 4T 05-07, X9 EVOLUTION 250 4T 04-04, X9 EVOLUTION 250 4T 06-06



◀ **cod. MC12107**
Membrana carburatore adattabile scooter Piaggio Vespa Lx 125 cc

RIFERIMENTO ORIGINALE

Aprilia	AP8540170
---------	-----------

Piaggio	CM140302
---------	----------

APPLICABILITÀ

APRILIA MOJITO 125 4T 03-08, SPORT CITY ONE 4T EU3 125 4T 08-11, SR MOTARD 125 4T-2V 12-14

DERBI BOULEVARD 4T EU3 125 4T 08-12, BOULEVARD EU2 125 4T 04-07, SONAR 4T 125 4T 09-11, VARIANT SPORT 4T EU3 125 4T 12-12, BOULEVARD 4T E3 150 4T 10-10, SONAR 4T 150 4T 09-09, BOULEVARD EU2 200 4T 05-06

PIAGGIO FLY 125 4T 05-07, FLY EU3 125 4T 07-11, LIBERTY 4T 125 4T 06-07, LIBERTY 4T 2V EURO3 125 4T 09-12, LIBERTY 4T EU3 125 4T 06-08, LIBERTY 4T EU3 DELIVERY - SINGLE 125 4T 07-15, LIBERTY 4T EU3 DELIVERY - TNT 125 4T 08-15, LIBERTY 4T SPORT EU3 125 4T 06-08, LIBERTY RST PTT 125 4T 05-11, LIBERTY SPORT 125 4T 06-06, VESPA GRANTURISMO 125 4T 03-05, VESPA LX 125 4T 05-06, VESPA LX 4T FL 125 4T 09-09, VESPA LX EU3 125 4T 06-08, VESPA LXV 4T EU3 125 4T 06-09, VESPA LXV NAVY EU3 125 4T 07-08, VESPA S 4T EU3 125 4T 07-08, X8 STREET EU2 125 4T 06-07, FLY 150 4T 05-07, FLY EU3 150 4T 08-11, LIBERTY 4T EU3 150 4T 08-08, LIBERTY 4T SPORT EU3 150 4T 08-08, LIBERTY MOC 4T 150 4T 09-13, VESPA LX 150 4T 05-06, VESPA LX 4T FL 150 4T 09-09, VESPA LX EU3 150 4T 06-08, VESPA S 4T 150 4T 08-09, X8 STREET EU2 150 4T 06-08, LIBERTY 200 4T 06-06, LIBERTY 4T EU3 200 4T 06-08, LIBERTY 4T SPORT EU3 200 4T 06-07, LIBERTY SPORT 200 4T 06-06



◀ **cod. MC12108**
Membrana carburatore adattabile a scooter PIAGGIO ZIP 50 cc 4T

RIFERIMENTO ORIGINALE

Piaggio	CM146601
---------	----------

APPLICABILITÀ

PIAGGIO FLY 4T 50 4T 05-07, FLY 4T & 25-30 KM/H 50 4T 08-11, FLY 4T 2V 50 4T 13-15, FLY 4T 2V 25-30KM/H 50 4T 12-17, FLY 4T MOTORE CHN 50 4T 06-07, LIBERTY 4T 50 4T 00-02, LIBERTY 4T 50 4T 05-08, LIBERTY 4T DELIVERY - SINGLE 50 4T 10-14, LIBERTY 4T DELIVERY TNT 50 4T 09-09, LIBERTY 4T PTT (DEU) 50 4T 07-12, LIBERTY 4T PTT - DOUBLE - NEXIVE 50 4T 09-17, LIBERTY 4T RST 50 4T 04-04, LIBERTY 4T SPORT 50 4T 06-08, LIBERTY MOC 4T & ELLE 50 4T 09-16, VESPA ET4 50 4T 00-05, VESPA LX 4T 50 4T 05-09, ZIP 4T 50 4T 00-13, ZIP 4T 25KM/H 50 4T 06-16



◀ cod. **9980200**

Molla a gas per sella T-Max 500/530/560 cc '08-'20

RIFERIMENTO ORIGINALE

YAMAHA	4B52478G0200
--------	--------------

YAMAHA	4B52478G0400
--------	--------------

APPLICABILITÀ

Yamaha T-MAX 4B5 500 4T 09-11, T-MAX 4B5 ABS 500 4T 08-11, T-MAX 5VU 500 4T 08-08, T-MAX 5VU BLACK MAX 500 4T 06-06, T-MAX SV 500 4T 11-11, T-MAX SV ABS 500 4T 10-11, T-MAX WHITE MAX 500 4T 10-10, T-MAX 59C 530 4T 12-16, T-MAX 59C ABS 530 4T 12-16, T-MAX 59C SP 530 4T 15-15, T-MAX 59C SP ABS 530 4T 15-16, XP530-A T-MAX SX 530 4T 17-19, XP530D-A T-MAX DX 530 4T 17-19, XP530E-A T-MAX 530 4T 17-18

NOVITÀ



◀ cod. **9980210**

Molla a gas per sella Yamaha Majesty 400 cc

APPLICABILITÀ

YAMAHA MAJESTY 400 4T 04-11, MAJESTY ABS 400 4T 07-11

RIFERIMENTO ORIGINALE

YAMAHA	34B2478G0000
--------	--------------

YAMAHA	5RU2478G0000
--------	--------------



◀ cod. **9980220**

Molla a gas per sella Honda Silverwing 400/600 cc

APPLICABILITÀ

HONDA SILVER WING [FJS] 400 4T 06-08, SW-T [FJS] 400 4T 09-13, SILVER WING [FJS] 600 4T 01-10, SW-T [FJS] 600 4T 11-13

RIFERIMENTO ORIGINALE

Honda	83590-MCT-003
-------	---------------

Honda	83590-MCT-D61
-------	---------------

NOVITÀ



◀ cod. **9980250**

Molla a gas per sella Yamaha X-Max 125/250/400 cc dal 2013

RIFERIMENTO ORIGINALE

YAMAHA	1SDF478G0000
--------	--------------

APPLICABILITÀ

YAMAHA X-MAX R 125 4T-4V 14-16, X-MAX RA ABS 125 4T-4V 14-16, X-MAX 250 4T 14-16, X-MAX ABS 250 4T 14-15, X-MAX 400 4T-4V 13-16, X-MAX ABS 400 4T-4V 14-17, X-MAX IRONMAX ABS 400 4T-4V 16-16, X-MAX MOMODESIGN 400 4T-4V 14-14, X-MAX MOMODESIGN ABS 400 4T-4V 14-14

NOVITÀ



◀ cod. **9980260**

Molla a gas per sella Suzuki Burgman 400 cc K7-L6

RIFERIMENTO ORIGINALE

SUZUKI	45270-05H01-000
--------	-----------------

APPLICABILITÀ

SUZUKI AN BURGMAN K7/LO 400 4T 07-10, AN BURGMAN L1 400 4T 11-11, AN BURGMAN L2 400 4T 12-12, AN BURGMAN L3 400 4T 13-13, AN BURGMAN L4 400 4T 14-14, AN BURGMAN L5 400 4T 15-15, AN BURGMAN L6 400 4T 16-16



cod. **MA00001**
Motorino avviamento Minarelli

RIFERIMENTO ORIGINALE

Aprilia	AP8224103
Benelli	R19240011A0
Malaguti	2404400
Yamana	45BH18001000

Yamana	4CUH18001000
MBK	45BH18001000
MBK	4CUH18001000

APPLICABILITÀ

- APRILIA** AMICO 50 2T 94-94, AMICO 50 2T 96-98, AMICO GL/GLE 50 2T 93-95, AMICO LX/SPORT/CAT 50 2T 92-93, AREA S1 50 2T 98-00, GULLIVER 50 2T 95-98, GULLIVER LC 50 2T 96-98, RALLY 50 2T 95-03, RALLY LIQUID COOLED 50 2T 96-99, SCARABEO 50 2T 93-05, SONIC 50 2T 98-07, SONIC GP 50 2T 98-08, SR (ORIZZONTALE) 50 2T 94-96, SR (VERTICALE) 50 2T 93-93, SR LIQUID COOLED 50 2T 94-96, SR RACING 50 2T 97-99, SR STEALTH 50 2T 97-00, SR WWW 50 2T 97-01
- ATALA** CAROSELLO 50 2T 99-01
- BENELLI** 491 GT 50 2T 98-99, 491 NAKED 50 2T 02-02, 491 RACING 50 2T 98-99, 491 RR 50 2T 99-01, 491 SP 50 2T 99-99, 491 SPORT 50 2T 98-99, 491 ST 50 2T 99-01, K2 50 2T 98-01, K2 LIQUID COOLED 50 2T 98-01, PEPE 50 2T 99-01, PEPE LX 50 2T 03-04
- BETA** ARK 50 2T 96-08, ARK LC 50 2T 96-08, CHRONO 50 2T 95-96, EIKON 50 2T 99-03, QUADRA 50 2T 95-95, QUADRA 50 2T 99-01, TEMPO 50 2T 93-02, TEMPO 50 2T 95-95
- ITALJET** DRAGSTER 50 2T 98-02
- KTM** K50 50 2T 96-01
- MACAL** STING 50 2T 95-96, THUNDER 50 2T 95-96
- MALAGUTI** CENTRO SL 50 2T 94-98, CIAK 50 2T 99-01, CIAK EURO 2 2,3 50 2T 03-03, CIAK EURO2 50 2T 01-03, CIAK MASTER EURO 2 50 2T 06-06, F10 50 2T 92-00, F10 EURO 2 50 2T 02-06, F10 EURO 2,3 50 2T 03-04, F10 RESTYLING EURO 2 50 2T 06-06, F12 PHANTOM 50 2T 94-98, F12 PHANTOM EURO 2 50 2T 02-02, F12 PHANTOM EURO 2,3 50 2T 03-04, F12 PHANTOM LC 50 2T 94-98, F12 PHANTOM LC EURO 2,3 50 2T 03-04, F12 R PHANTOM LC 50 2T 07-10, F12 RESTYLING EURO 1 50 2T 99-02, F12 RESTYLING EURO 2 50 2T 06-06, F12 RESTYLING LC EURO 2 50 2T 06-06, F15 FIRE FOX 50 2T 96-98, F15 FIRE FOX AIR COOLED 50 2T 05-06, F15 FIRE FOX EURO 2 50 2T 02-06, F15 FIRE FOX EURO 2,3 50 2T 03-04, YESTERDAY 50 2T 97-00

- MBK** BOOSTER 50 2T 90-04, BOOSTER 50 2T 90-94, BOOSTER EURO 2 50 2T 04-04, BOOSTER NG 50 2T 95-03, BOOSTER ROCKET 50 2T 97-98, BOOSTER SPIRIT 50 2T 96-00, BOOSTER SPIRIT 50 2T 03-03, BOOSTER SPIRIT EURO2 50 2T 03-03, BOOSTER TRACK 50 2T 96-98, EVOLIS 50 2T 92-95, FIZZ 50 2T 94-95, FLIPPER 50 2T 98-04, FLIPPER EURO 2 50 2T 03-03, FORTE 50 2T 94-96, MACH G 50 2T 02-04, MACH G LC 50 2T 02-04, NITRO 50 2T 97-04, NITRO EURO 2 50 2T 03-03, OVETTO 50 2T 97-04, OVETTO EURO 2 50 2T 02-02, STUNT 50 2T 00-02
- MOTRON** STING 50 2T 95-96, SYNCRO 50 2T 98-00, THUNDER 50 2T 95-98
- RIEJU** FIRST 50 2T 95-98, WINDY 50 2T 95-98
- YAMAHA** AEROX 50 2T 97-02, AEROX 50 2T 04-16, AEROX EURO 2 50 2T 03-03, AEROX NAKED 50 2T 13-16, AEROX R 50 2T 99-00, AXIS 50 2T 95-96, BREEZE 50 2T 94-95, BW'S 50 2T 97-16, BW'S BUMP 50 2T 97-98, BW'S EASY 50 2T 13-13, BW'S NAKED 50 2T 03-04, BW'S NAKED 50 2T 09-16, BW'S NEXT GENERATION 50 2T 97-06, BW'S ORIGINAL 50 2T 99-01, BW'S ORIGINAL EURO 2 50 2T 03-03, JOG R 50 2T 02-02, JOG R EURO2 50 2T 02-02, JOG R EURO2 50 2T 06-15, JOG R LC 50 2T 02-15, NEO'S 50 2T 97-02, NEO'S 50 2T 04-16, NEO'S EASY 50 2T 13-13, NEO'S EURO 2 50 2T 02-02, RS SPY 50 2T 95-98, SLIDER 50 2T 00-02, WHY 50 2T 98-05, WHY EURO 2 50 2T 03-05, ZEST 50 2T 95-92, ZUMA 50 2T 97-01



cod. **MA00002**
Motorino avviamento Piaggio

RIFERIMENTO ORIGINALE

Piaggio	82530R
---------	--------

APPLICABILITÀ

- APRILIA** MOJITO CUSTOM 2T MOTORE PIAGGIO 50 2T 04-10, SCARABEO 2T EU2 MOTORE PIAGGIO 50 2T 10-12, SCARABEO 2T NET 50 2T 09-10, SCARABEO STREET 50 2T 05-06, SCARABEO STREET 2T RESTYLING 50 2T 06-09, SPORT CITY ONE 2T 50 2T 08-11, SR MOTARD 50 2T 12-14, SR R FACTORY CARBURATORE 50 2T 10-14, SR STREET CARBURATORE 50 2T 03-12
- DERBI** ATLANTIS 2T 50 2T 10-10, ATLANTIS 2T EU2 50 2T 07-09, ATLANTIS O2 50 2T 02-02, ATLANTIS O2 BULLET 50 2T 03-05, ATLANTIS O2 CITY 50 2T 04-06, ATLANTIS O2 RED BULLET 50 2T 03-03, ATLANTIS O2 TWO CHIC 50 2T 05-05, BOULEVARD 2T 50 2T 09-14, GP1 50 2T 01-03, GP1 EU 2 50 2T 05-05, GP1 OPEN EU2 50 2T 06-09, GP1 RACE EU2 50 2T 05-07, SONAR 2T 50 2T 09-09
- GILERA** DNA 50 2T 00-02, DNA 50 2T 05-07, DNA GP EXPERIENCE 50 2T 03-04, EASY MOVING 50 2T 95-96, ICE 50 2T 01-05, RUNNER 50 2T 97-00, RUNNER POGGIALI 50 2T 02-02, RUNNER SP 50 2T 02-07, RUNNER SP 50 2T 10-12, RUNNER SP SPECIAL EDITION 50 2T 07-07, RUNNER SP ST & SIMONCELLI 50 2T 08-09, STALKER 50 2T 97-11, STALKER NAKED 50 2T 08-08, STALKER SPECIAL EDITION 50 2T 07-08, STORM 50 2T 94-95, STORM EURO 2 50 2T 07-07, TYPHOON 50 2T 94-97, TYPHOON X 50 2T 98-99, TYPHOON XR 50 2T 00-00

- PIAGGIO** DIESIS 50 2T 01-01, FLY 2T 50 2T 05-07, FLY 2T 50 2T 10-11, FREE 50 2T 92-94, FREE DELIVERY 50 2T 00-01, FREE FL 50 2T 95-02, LIBERTY 50 2T 97-05, LIBERTY 2T 50 2T 06-08, LIBERTY 2T PTT EU2 50 2T 04-05, LIBERTY 2T RST 50 2T 04-04, LIBERTY 2T SPORT 50 2T 06-08, NRG 50 2T 94-96, NRG EXTREME LC 50 2T 99-00, NRG MC3 50 2T 01-04, NRG POWER DD 50 2T 05-17, NRG POWER DD SERIE SPECIALE 50 2T 07-12, NRG POWER DT 50 2T 06-15, NRG POWER DT SERIE SPECIALE 50 2T 07-08, NRG RST MC2 50 2T 96-98, NIT 50 2T 95-96, QUARTZ 50 2T 92-96, SFERA 50 2T 91-93, SFERA MAQUILLAGE 2 50 2T 94-94, SFERA RST 50 2T 95-97, TYPHOON 50 2T 01-11, TYPHOON 2T E2 50 2T 10-12, TYPHOON 2T E3 CH 50 2T 11-11, VESPA ET2 50 2T 97-05, VESPA ET2 INIEZIONE 50 2T 97-00, VESPA LX 2T 50 2T 05-08, VESPA LX 2T TOURING & 30KM 50 2T 10-13, VESPA LXV 2T 50 2T 06-09, VESPA LXV 2T NAVY 50 2T 08-08, VESPA S 2T & COLLEGE 50 2T 07-12, ZIP 50 2T 92-93, ZIP 50 2T 95-96, ZIP 2T 50 2T 08-13, ZIP BIMODALE 50 2T 94-97, ZIP FAST RIDER 50 2T 93-94, ZIP FAST RIDER RST 50 2T 96-97, ZIP LC 50 2T 00-04, ZIP SP 50 2T 96-04, ZIP SP EURO 2 50 2T 06-13



◀ **cod. MA00004**
Motorino avviamento Peugeot/Sym 125cc 12v 9 denti Ø 11,4 rotazione dx

RIFERIMENTO ORIGINALE

Sym	31200H9A000
-----	-------------

Peugeot	801068
---------	--------

APPLICABILITÀ

SYM GTS JOYMAX 125 4T 06-07, HD EU3 125 4T-4V 07-08, HD EVO 125 4T-4V 05-06, HD EVO EU3 125 4T-4V 07-08, HD EVO EU3 125 4T-4V 10-11, HD EVO TAMBURO EU3 125 4T-4V 08-09, HD2 125 4T-4V 11-11, JOYRIDE 125 4T-4V 01-02, JOYRIDE EU2 125 4T-4V 05-06, JOYRIDE EU3 125 4T-4V 07-07, JOYRIDE EVO 125 4T-4V 09-10, JOYRIDE 150 4T-4V 01-02



◀ **cod. MA00006**
Motorino avv. Honda Mitsuba sm14 12v/0,45kw 9 denti Ø 11,7 rotazione dx

RIFERIMENTO ORIGINALE

Honda	31200-KGF-901
-------	---------------

APPLICABILITÀ

HONDA @ [NES] 125 4T 00-06, DYLAN [SES] 125 4T 02-04, PANTHEON IE [FES] 125 4T-2V 03-05, PS I [PES] 125 4T 06-10, SH 125 4T-2V 01-04, SH IE SCOOPY 125 4T-2V 05-12, SILVER WING [FES] 125 4T-2V 07-12, @ [NES] 150 4T 00-06, DYLAN [SES] 150 4T 02-04, PANTHEON IE [FES] 150 4T-2V 03-05, PS I [PES] 150 4T 06-10, SH 150 4T-2V 01-04, SH IE SCOOPY 150 4T 05-12, SILVER WING [FES] 150 4T-2V 07-12



◀ **cod. MA00007**
Motorino avviamento Sym 125 cc 12v rotazione dx

RIFERIMENTO ORIGINALE

Kymco	00126011
Kymco	00128741
Malaguti	54800100

Sym	31200M92100
Sym	31200ARA000

APPLICABILITÀ

KYMCO AGILITY 125 4T 06-06, AGILITY EU3 125 4T 06-08, AGILITY R16 125 4T 08-09, AGILITY RS 125 4T 09-09, B&W 125 4T 00-00, B&W EU2 125 4T 03-04, DINK 125 4T 97-98, DINK CLASSIC 125 4T 02-02, DINK CLASSIC EU2 125 4T 03-03, DINK LX 125 4T 98-00, HEROISM 125 4T 95-97, LIKE 125 4T 09-09, MOVIE 125 4T 99-00, MOVIE EU3 125 4T 06-07, MOVIE XL EU2 125 4T 03-04, PEOPLE 125 4T 99-00, PEOPLE EU2 125 4T 03-03, PEOPLE EU3 125 4T 07-08, PEOPLE EU3 125 4T 11-11, PEOPLE S 125 4T 05-05, PEOPLE S DD EU3 125 4T 07-08, SUPER 8 125 4T 08-09, VIVIO 125 4T 00-00, AGILITY 150 4T 06-08, AGILITY R16 150 4T 08-09, B&W 150 4T 00-00, B&W EU2 150 4T 03-04, DINK 150 4T 97-98, DINK CLASSIC 150 4T 02-02, DINK CLASSIC EU2 150 4T 03-03, DINK LX 150 4T 98-00, HEROISM 150 4T 95-97, MOVIE EU3 150 4T 06-07, MOVIE XL EU2 150 4T 03-04, PEOPLE 150 4T 99-00, PEOPLE EU2 150 4T 03-03, VIVIO 150 4T 00-00, AGILITY R16 200 4T 12-12, AGILITY R16 200 4T 10-10, DINK CLASSIC 200 4T 04-04, LIKE IE 200 4T 09-09, LIKE LX 200 4T 12-12, PEOPLE S 200 4T 05-05, PEOPLE S 1200 4T 07-07

MALAGUTI CIAK 125 4T 00-01, CIAK MASTER 125 4T 04-04, CIAK MASTER EU3 125 4T 06-06, CIAK RESTYKING EU2 125 4T 03-03, F18 WARRIOR 125 4T 00-02, CIAK 150 4T 00-02, CIAK MASTER 150 4T 04-04, CIAK RESTYKING EU2 150 4T 03-03, F18 WARRIOR 150 4T 00-02, CIAK MASTER EURO 2 200 4T 06-06

SYM FIDDLE II 125 4T 08-09, SUPER DUKE 125 4T 99-02, SYMPLY 125 4T 07-08, SUPER DUKE 150 4T 99-02



◀ **cod. MA00010**
Motorino avviamento Yamaha 250 cc 12v 9 denti Ø 11,7 rotazione dx

RIFERIMENTO ORIGINALE

Aprilia	AP8122628
Benelli	R19040191A0
Malaguti	94800100

Malaguti	74800500
Yamaha	4HC818900000
Yamaha	1COH18000000

APPLICABILITÀ

APRILIA LEONARDO 250 4T 99-04, LEONARDO ST 250 4T 01-01, LEONARDO 300 4T 02-04

BENELLI VELVET 250 4T 99-03

ITALJET JUPITER 250 4T 00-02

MALAGUTI MADISON S 250 4T 99-01, PASSWORD 250 4T 05-06, PASSWORD EU3 250 4T 07-08

MBK SKYLINER 250 4T 00-03, SKYLINER ABS 250 4T 03-03, KILIBRE 300 4T 03-06

YAMAHA MAJESTY 250 4T 96-03, MAJESTY ABS 250 4T 03-03, MAJESTY DX 250 4T 98-99, X-CITY 250 4T 07-15, X-MAX 250 4T 05-16, X-MAX ABS 250 4T 14-15, VERSITY 300 4T 03-06, MAJESTY 400 4T 04-11, MAJESTY ABS 400 4T 07-11, X-MAX 400 4T-4V 13-16, X-MAX ABS 400 4T-4V 14-17, X-MAX IRONMAX ABS 400 4T-4V 16-16, X-MAX MOMODESIGN 400 4T-4V 14-14, X-MAX MOMODESIGN ABS 400 4T-4V 14-14, X-MAX RA 400 4T-4V 18-18



◀ **cod. MA00012**
Motorino avviamento Piaggio 50 cc 12v/0,45kw rotazione sx 4 spazzole

RIFERIMENTO ORIGINALE

Piaggio	82611R
---------	--------

APPLICABILITÀ

APRILIA ATLANTIC 125 4T 03-05, ATLANTIC EU3 125 4T 06-08, ATLANTIC EU3 125 4T 10-12, MOJITO 125 4T 03-08, SCARABEO 125 4T 03-06, SCARABEO EU3 125 4T 06-07, SPORT CITY 125 4T 04-06, SPORT CITY CUBE 125 4T 08-10, SPORT CITY EU3 125 4T 06-08, SPORT CITY ONE 4T EU3 125 4T 08-11, SPORT CITY STREET 125 4T 12-12, SR MOTARD 125 4T-2V 12-14

DERBI BOULEVARD 125 4T 02-04, BOULEVARD 4T EU3 125 4T 08-12, BOULEVARD EU2 125 4T 04-07, GP1 EU 2 125 4T 06-06, GP1 LOW SEAT EU3 125 4T 07-08, RAMBLA 125 4T 08-09, RAMBLA EU3 2VER 125 4T 08-08, SONAR 4T 125 4T 09-11, VARIANT SPORT 4T EU3 125 4T 12-12, BOULEVARD 150 4T 02-04, BOULEVARD 4T E3 150 4T 10-10, BOULEVARD EU3 150 4T 04-07, SONAR 4T 150 4T 09-09, BOULEVARD EU2 200 4T 05-06

GILERA DNA 125 4T 01-01, NEXUS EU3 125 4T 07-08, RUNNER 4T ST EU3 125 4T 08-16, RUNNER VX 125 4T 00-06, RUNNER VX 4T EU3 125 4T 06-07, RUNNER VX RACE 125 4T 06-06, RUNNER VX SC 125 4T 06-07, RUNNER VXR RACE 200 125 4T 06-06, DNA 180 4T 01-01, RUNNER VXR 180 4T 00-01, RUNNER VXR 200 4T 02-06, RUNNER VXR 4T ST EU3 200 4T 08-11, RUNNER VXR EU3 200 4T 07-07

PIAGGIO BEVERLY 125 4T 01-03, BEVERLY EU3 125 4T 07-08, BEVERLY EURO 3 MIC 125 4T 07-07, BEVERLY EURO 3 SPORT 125 4T 07-08, BEVERLY RST 125 4T 04-07, BEVERLY TOURER EU3 125 4T 07-10, CARNABY 125 4T 07-10, FLY 125 4T 05-07, FLY EU3 125 4T 07-11, HEXAGON GTX 125 4T 00-00, LIBERTY 125 4T 01-02, LIBERTY 4T 125 4T 06-07, LIBERTY 4T 2V EURO3 125 4T 09-12, LIBERTY 4T EU3 125 4T 06-08, LIBERTY 4T EU3 DELIVERY - TNT 125 4T 08-15, LIBERTY 4T SPORT EU3 125 4T 06-08, LIBERTY RST 125 4T 04-05, LIBERTY SPORT 125 4T 06-06, MP3 125 4T 06-08, SKYPYPER 4T 125 4T 00-02, SUPER HEXAGON GTX 12 125 4T 01-02, TYPHOON 4T 2V E3 125 4T 10-11, VESPA ET4 125 4T 99-02, VESPA GRANTURISMO 125 4T 03-07, VESPA GRANTURISMO EU3 125 4T 06-07, VESPA GTS EU3 125 4T 07-12, VESPA GTV 125 4T 06-08, VESPA GTV 4T NAVY EU3 125 4T 08-08, VESPA LX 125 4T 05-06, VESPA LX 4T EU3 TOURING 125 4T 10-11, VESPA LX 4T FL 125 4T 09-09, VESPA LX EU3 125 4T 06-08, VESPA LX IE 125 4T 09-11, VESPA LXV 4T EU3 125 4T 06-09, VESPA LXV IE 4T 125 4T 10-13, VESPA LXV NAVY EU3 125 4T 07-08, VESPA S 4T EU3 125 4T 07-08, VESPA S 4T IE & COLLEGE 125 4T 09-11, X-EVO 125 4T 07-16, X7 EU3 125 4T 08-08, X8 125 4T 04-06, X8 PREMIUM EU2 125 4T 06-06, X8 PREMIUM EU3 125 4T 06-07, X8 STREET EU2 125 4T 06-07, X9 125 4T 01-02, X9 EVOLUTION 125 4T 03-03, X9 EVOLUTION 125 4T 05-06, X9 EVOLUTION EU3 125 4T 07-07, ZIP 125 4T 00-02, FLY 150 4T 05-07, FLY EU3 150 4T 08-11, LIBERTY 4T EU3 150 4T 08-08, LIBERTY 4T SPORT EU3 150 4T 08-08, LIBERTY MOC 4T 150 4T 09-13, SKYPYPER 4T 150 4T 00-02, VESPA ET4 150 4T 99-02, VESPA LX 150 4T 05-06, VESPA LX 4T FL 150 4T 09-09, VESPA LX EU3 150 4T 06-08, VESPA LX IE 150 4T 09-11, VESPA LX TOURING 150 4T 10-12, VESPA S 4T 150 4T 08-09, VESPA S 4T IE & COLLEGE 150 4T 09-12, X8 STREET EU2 150 4T 06-08, HEXAGON GTX 180 4T 00-00, SUPER HEXAGON GTX 12 180 4T 01-02, X9 AMALFI 180 4T 00-03, CARNABY 200 4T 07-08, LIBERTY 200 4T 06-06, LIBERTY 4T EU3 200 4T 06-08, LIBERTY 4T SPORT EU3 200 4T 06-07, LIBERTY RST 200 4T 04-04, LIBERTY SPORT 200 4T 06-06, VESPA GRANTURISMO 200 4T 03-07, X8 200 4T 05-07, X9 200 4T 02-03, X9 EVOLUTION 200 4T 03-03



◀ **cod. MA00014**
Motorino avviamento Kymco 50 cc 12v/0,20kw rotazione sx

RIFERIMENTO ORIGINALE

Kymco	00104202
-------	----------

Sym	31200GAK900
-----	-------------

APPLICABILITÀ

KYMCO B&W 50 2T 02-02, B&W EU2 50 2T 03-03, DINK LC 50 2T 98-02, DINK CLASSIC EU2 50 2T 03-03, HEROISM 50 2T 95-97, KXR 50 2T 04-04, MAXXR 50 2T 05-05, MXER 50 2T 02-03, MXER EU2 50 2T 04-04, MXU 50 2T 06-07, MXU SR 50 2T 06-06, PEOPLE 50 2T 99-04, PEOPLE EURO 2 50 2T 03-03, PEOPLE EURO 2 50 2T 08-08, PEOPLE EURO 2 50 2T 11-11, PEOPLE S 50 2T 05-08, SNIPER 50 2T 93-93, SNIPER DD 50 2T 94-96, SUPER 9 50 2T 00-00, SUPER 9 EU2 50 2T 03-04, TOP BOY 50 2T 97-00, VITALITY 2T 50 2T 04-04, YUP 50 2T 02-02, YUP EU2 50 2T 03-03

SYM JET 50 2T 99-01, JUNGLE 50 2T 99-00, MASK 50 2T 00-01, MASK EU2 50 2T 03-04, RED DEVIL 50 2T 99-99, SUPER FANCY 50 2T 98-00

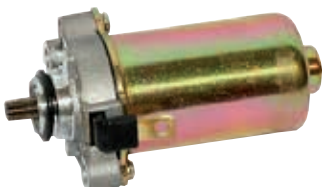

◀ **cod. MA00015**
Motorino avviamento Piaggio 50 cc 12v/0,25kw 10 denti rotazione sx

RIFERIMENTO ORIGINALE

Piaggio	96921R
---------	--------

Malaguti	44800500
----------	----------

APPLICABILITÀ

APRILIA RS 50 2T 06-10, RS4 50 2T 11-13, SCARABEO 4T 50 4T 02-06, SCARABEO 4T 4V 50 4T-4V 10-12, SCARABEO 4T 4V NET 50 4T-4V 09-10, SCARABEO 4T RESTYLING EU3 50 4T 06-09, SCARABEO QUATTRO 50 4T-4V 09-09, SPORT CITY ONE 4T 50 4T 08-10, SR R 50 2T 04-09, SR R FACTORY IE 50 2T 10-14

DERBI ATLANTIS 4T 50 4T 04-06, ATLANTIS 4T EU2 50 4T 07-07, BOULEVARD 4T EU2 25KM/H 50 4T 09-09, GPR R EU2 - GPR REPLICA EU2 50 2T 08-08, GPR RACING EU2 50 2T 06-06, GPR REPLICA & GPR R EU2 50 2T 06-06, GPR REPLICA PESEK EU2 50 2T 07-07, SENDA R DRD PRO EU2 50 2T 05-11, SENDA SM DRD PRO EU2 50 2T 05-11

GILERA RUNNER PURE JET 50 2T-IE 02-07, RUNNER PURE JET 50 2T-IE 10-11, RUNNER PURE JET ST 50 2T-IE 08-08

MALAGUTI CENTRO EURO 2 50 4T 08-08, CENTRO SL 4T 50 4T 10-10, CIAK MASTER 4T 50 4T 05-06

PIAGGIO FLY 4T 50 4T 05-07, FLY 4T & 25-30 KM/H 50 4T 08-11, FLY 4T MOTORE CHN 50 4T 06-07, LIBERTY 4T 50 4T 00-02, LIBERTY 4T 50 4T 05-08, LIBERTY 4T DELIVERY - SINGLE 50 4T 10-14, LIBERTY 4T DELIVERY TNT 50 4T 09-09, LIBERTY 4T PTT - DOUBLE - NEXIVE 50 4T 09-17, LIBERTY 4T RST 50 4T 04-04, LIBERTY 4T SPORT 50 4T 06-08, LIBERTY MOC 2T & ELLE 50 2T 09-13, NRG POWER PUREJET 50 2T-IE 04-11, NRG PUREJET 50 2T-IE 02-04, NRG PUREJET 50 2T-IE 10-10, VESPA ET4 50 4T 00-05, VESPA LX 4T 50 4T 05-09, VESPA LX 4T 4V 50 4T-4V 09-13, VESPA LX 4T 4V TOURING 50 4T-4V 10-13, VESPA S 4T 4V & COLLEGE 50 4T-4V 08-12, ZIP 4T 50 4T 00-13, ZIP RST 50 2T 96-99, DIESIS 100 2T 01-01



cod. MA00016

Motorino avviamento Piaggio 125/250/300 cc 12v/0,45kw 9 denti Ø 11,7 rotazione dx

RIFERIMENTO ORIGINALE

Piaggio	58142R
---------	--------

APPLICABILITÀ

APRILIA SR MAX 125 4T 11-14, ATLANTIC 250 4T 03-05, ATLANTIC EU3 250 4T 06-08, SCARABEO 250 4T 04-06, SCARABEO LIGHT 250 4T 06-08, SPORT CITY CUBE 250 4T 08-12, SPORT CITY EU3 250 4T 06-08, ATLANTIC 300 4T 10-11, SCARABEO LIGHT 300 4T 09-10, SPORT CITY STREET 300 4T-4V 12-12, SR MAX 300 4T 11-14

DERBI GP1 250 4T 06-07, GP1 LOW SEAT EU3 250 4T 07-08, RAMBLA 250 4T 08-09, RAMBLA EU3 2VER 250 4T 08-08, RAMBLA 300 4T 10-11

GILERA NEXUS IE EU3 125 4T 08-10, NEXUS EU3 250 4T 06-07, NEXUS SP EU3 250 4T 06-07, OREGON 250 4T 06-10, NEXUS EU3 300 4T 08-11

PIAGGIO VESPA GTS 4T IE SUPER 125 4T 09-16, X7 EVO IE EU3 125 4T 09-10, BEVERLY 250 4T 05-07, BEVERLY CRUISER 250 4T 07-09, BEVERLY IE EU3 250 4T 06-08, BEVERLY RST 250 4T 04-05, BEVERLY TOURER EU3 250 4T 07-09, CARNABY 250 4T 08-09, MP3 250 4T 06-08, MP3 LT 250 4T 08-09, MP3 MIC 250 4T 08-09, VESPA GT 60 EU3 250 4T 06-07, VESPA GTS 250 4T 05-16, VESPA GTS ABS 250 4T 05-12, VESPA GTV 250 4T 06-09, VESPA GTV 4T NAVY EU3 250 4T 07-07, X-EVO 250 4T 07-16, X7 EU3 250 4T 08-08, X8 EU3 250 4T 05-08, X9 EVOLUTION 250 4T 04-04, X9 EVOLUTION 250 4T 06-06, BEVERLY RST 4T 4V IE EU3 300 4T 10-16, BEVERLY TOURER EU3 300 4T 09-10, CARNABY CRUISER 300 4T 09-12, VESPA GTS IE TOURING 300 4T 11-12, VESPA GTS SUPER 300 4T 08-16, VESPA GTS SUPER SPORT 300 4T 10-13, VESPA GTV 4T 4V IE 300 4T 10-13, VESPA GTV VIA MONTENAPOLEONE 300 4T 10-10, X7 EVO IE EU3 300 4T 09-10



cod. MA00017

Motorino avviamento Minarelli 125/150/180 cc 12v 9 denti Ø 11,5 rotazione sx

RIFERIMENTO ORIGINALE

Benelli	R19010111A0
Malaguti	74800400
Yamaha	4CWH18000000
Yamaha	5MLH18000000

Yamaha	5DSH18000000
Yamaha	5DS818000000
Yamaha	5XLH18000000

APPLICABILITÀ

BENELLI VELVET 125 4T 99-01, VELVET TOURING 125 4T 02-03, VELVET 150 4T 99-01, VELVET TOURING 150 4T 02-03

ITALJET JUPITER 125 4T 01-02, MILLENNIUM 125 4T 00-02, JUPITER 150 4T 01-02, MILLENNIUM 150 4T 00-02

MALAGUTI MADISON 125 4T 99-01, MADISON R RESTYLING 125 4T 02-02, MADISON R RESTYLING EU2 125 4T 03-04, PHANTOM MAX 125 4T 03-03, MADISON T 150 4T 99-01

MBK DOODO 125 4T 00-00, SKYLINER 125 4T 98-02, SKYLINER E 125 4T 03-03, THUNDER 125 4T 01-02, DOODO 150 4T 01-02, SKYLINER 150 4T 00-02, THUNDER 150 4T 01-02, SKYLINER E 180 4T 03-03

YAMAHA CYGNUS R (XC K) 125 4T 97-98, CYGNUS R (XC) 125 4T 99-99, CYGNUS X (NXC) 125 4T 04-06, CYGNUS125 (XC T) 125 4T 95-98, MAJESTY 125 4T 98-00, MAJESTY (SNR1) 125 4T 01-01, MAJESTY (SNR8) 125 4T 02-02, MAJESTY E 125 4T 03-09, MAXSTER 125 4T 01-02, TEO'S 125 4T 00-00, MAJESTY 150 4T 00-00, MAJESTY (SN51) 150 4T 01-01, MAJESTY (SN56) 150 4T 02-02, MAXSTER 150 4T 01-02, TEO'S 150 4T 01-02, MAJESTY E 180 4T 03-06



cod. MA00018

Motorino avviamento Minarelli AM 345/6

RIFERIMENTO ORIGINALE

Aprilia	AP8212367
Piaggio	4800180

Piaggio	2402700
Yamaha	4YVH18002000

APPLICABILITÀ

APRILIA CLASSIC 50 2T 92-99, EUROPA 50 2T 91-92, PEGASO 50 2T 92-94, RS 50 2T 91-05, TUONO 50 2T 03-04

HM BAJA, DERAPAGE BASIC 50 2T 10-11, CRE BAJA RR, DERAPAGE RR 50 2T 07-11, CRE BAJA, DERAPAGE 50 2T 07-11, CRE SIX, BAIA, DERAPAGE 50 2T 95-00, CRE SIX, BAIA, DERAPAGE 50 2T 03-06, DERAPAGE COMPETITION 50 2T 10-11

MALAGUTI FIFTY EVOLUTION 50 2T 90-93

MINARELLI MOTORE AM 6 1° SERIE 50 2T 96-11, MOTORE AM 6 2° SERIE 50 2T 12-18

VENT BAJA 50 2T 18-20, BAJA RR 50 2T 18-20, DERAPAGE 50 2T 18-20, DERAPAGE RR 50 2T 18-20

YAMAHA TZR 50 2T 03-08, TZR 50 2T 10-11, TZR RR 50 2T 05-05



cod. MA00019

Motorino avviamento Peugeot 50 cc 12v/0,15kw 11 denti rotazione sx con cavi

RIFERIMENTO ORIGINALE

Peugeot	744049
---------	--------

APPLICABILITÀ

PEUGEOT BUXY 50 2T 90-02, ELYSEO 50 2T 90-02, KISBEE 50 2T 00-00, LOOXOR 50 2T 90-02, LUDIX 50 2T 90-02, METAL X 50 2T 90-02, SPEEDAKE 50 2T 90-02, SPEEDFIGHT 50 2T 97-04, SPEEDFIGHT 3 50 2T 09-14, SPEEDFIGHT LC 50 2T 97-04, SQUAB 50 2T 90-02, TREKKER 50 2T 90-02, VIVACITY 50 2T 90-02, X-FIGHT 50 2T 00-02, X-FIGHT LC 50 2T 00-02, ZENITH 50 2T 90-02



◀ cod. **MA00021**
Motorino avviamento Suzuki 125/150/250/400 cc

RIFERIMENTO ORIGINALE

Suzuki	31100-14F01-000
--------	-----------------

APPLICABILITÀ

SUZUKI EPICURO 125 4T 99-01, UH BURGMAN K2/K6 125 4T 02-06, EPICURO 150 4T 99-01, UH BURGMAN K2/K6 150 4T 02-06, AN BURGMAN K1/K2 250 4T 01-02, AN BURGMAN K3/K6 250 4T 03-06, AN BURGMAN W/X/Y 250 4T 98-00, AN BURGMAN K3/K6 400 4T 03-06, AN BURGMAN X/K2 400 4T 99-02



◀ cod. **MA00022**
Motorino avviamento Aprilia Leonardo/Scarabeo 125 cc (Rotax)

RIFERIMENTO ORIGINALE

Aprilia	AP0296390	Malaguti	65030700
---------	-----------	----------	----------

APPLICABILITÀ

APRILIA LEONARDO 125 4T 96-02, LEONARDO ST 125 4T 03-04, SCARABEO 125 4T 99-03, LEONARDO 150 4T 96-02, SCARABEO 150 4T 99-03, SCARABEO 200 4T 01-03
MALAGUTI BLOG 125 4T 11-11, BLOG IE 125 4T 09-10, CENTRO IE EU3 125 4T 08-09, CENTRO SL 125 4T 11-11, CENTRO SL IE EU3 125 4T 09-10, BLOG 160 4T 11-11, BLOG IE 160 4T 09-10, CENTRO IE EU3 160 4T 08-09, CENTRO SL 160 4T 11-11, CENTRO SL IE EU3 160 4T 09-10



◀ cod. **MA00023**
Motorino avviamento Piaggio Vespa/Ape 50 cc

RIFERIMENTO ORIGINALE

Piaggio	179116
---------	--------

APPLICABILITÀ

PIAGGIO APE 50 2T 09-17, APE EU4 50 2T 18-18, APE FL - FL2 50 2T 89-95, APE FL3 EUROPA 50 2T 96-99, APE MIX 2T 50 2T 98-08, APE RST MIX 50 2T 99-03, APE TM P 50 2T 85-89, VESPA FL 50 2T 90-90, VESPA FL2 AUTOMATICA 50 2T 90-91, VESPA FL2 HP 50 2T 91-97, VESPA N 50 2T 89-90, VESPA PK 50 2T 82-84, VESPA PK AUTOMATICA 50 2T 84-89, VESPA PK XL 50 2T 85-88, VESPA PK XL PLURIMATIC 50 2T 85-90, VESPA PK XL RUSH 50 2T 88-89, VESPA FL 125 2T 89-90



◀ cod. **MA00024**
Motorino Avviamento Peugeot Sym 50 cc 4T

RIFERIMENTO ORIGINALE

SYM	31200A1A000	SYM	31200AWA000
-----	-------------	-----	-------------

APPLICABILITÀ

SYM MIO 50 4T 06-09, SYMPHONY EURO 2 50 4T 09-09, SYMPHONY S 50 4T 10-10, SYMPHONY SR 50 4T 10-10



◀ cod. **MA00025**
Motorino Avviamento Kymco Agility/ People 50 cc 4T

RIFERIMENTO ORIGINALE

Kymco	107242
-------	--------

APPLICABILITÀ

KYMC AGILITY 4T CARRY 50 4T 11-11, AGILITY 4T R10 50 4T 06-08, AGILITY 4T R12 50 4T 07-08, AGILITY PLUS 4T 50 4T 14-14, AGILITY R12 50 4T 05-05, AGILITY R12 ECS 50 4T 16-16, AGILITY R16 50 4T 08-09, AGILITY R16 50 4T 12-12, AGILITY RS 50 4T 09-09, DINK 50 4T 50 4T 07-07, FILLY 50 4T 98-00, FILLY LX 50 4T 01-02, LIKE 50 4T 09-09, PEOPLE S 4T 50 4T 06-08, SENTO 50 4T 08-08, SUPER 8 4T 50 4T 07-07, SUPER 8 4T 50 4T 09-09



◀ cod. **MA00026**
Motorino Avviamento Sym Symphony 125/150 cc

RIFERIMENTO ORIGINALE

Sym	31200-ARA-000	Sym	31200-M92-100
-----	---------------	-----	---------------

APPLICABILITÀ

SYM EURO MX 125 4T 02-02, EURO MX EU2 125 4T 03-04, SHARK 125 4T 99-02, SYMPHONY 125 4T 09-09, SYMPHONY S 125 4T 09-10, SYMPHONY SR 125 4T 10-10, EURO MX 150 4T 02-02, EURO MX EU2 150 4T 03-04, SHARK 150 4T 00-01, SYMPHONY 150 4T 09-09, SYMPHONY S 150 4T 10-10, SYMPHONY SR 150 4T 10-10



◀ cod. **MA00027**
Motorino Avviamento Kymco Dink 125/200 cc EU3

RIFERIMENTO ORIGINALE

Kymco	128751
-------	--------

APPLICABILITÀ

KYMCO DINK EU3 125 4T 06-07, G-DINK 125 4T 12-12, GRAND DINK 125 4T 01-02, GRAND DINK EU2 125 4T 03-04, GRAND DINK 150 4T 01-02, GRAND DINK EU2 150 4T 03-04



◀ cod. **MA00028**
Motorino Avviamento Yamaha X-MAX 125 cc

RIFERIMENTO ORIGINALE

Yamaha	1B9H18000100
--------	--------------

APPLICABILITÀ

MBK CITYLINER EU3 125 4T-4V 08-10, SKYCRUISER 125 4T-4V 07-07

YAMAHA X-CITY EU3 125 4T-4V 08-11, X-MAX R 125 4T-4V 06-16, X-MAX R ABS 125 4T-4V 11-11, X-MAX RA ABS 125 4T-4V 13-16



◀ cod. **MA00029**
Motorino Avviamento Piaggio Vespa PX 125 cc

RIFERIMENTO ORIGINALE

Piaggio	249235
---------	--------

APPLICABILITÀ

PIAGGIO VESPA PX 125 2T 98-01, VESPA PX 125 2T 11-16, VESPA PX 30 ANNI 125 2T 07-08, VESPA PX E ARCOBALENO 125 2T 81-97, VESPA PX EU2 125 2T 01-07, COSA CL, CLX 150 2T 88-91, VESPA PX 150 2T 98-01, VESPA PX 150 2T 11-16, VESPA PX E ARCOBALENO 150 2T 81-97, VESPA PX E ARCOBALENO 200 2T 81-97



◀ **cod. MA00030**
Motorino avviamento Piaggio 400/500 cc

RIFERIMENTO ORIGINALE

PIAGGIO	82699R
---------	--------

APPLICABILITÀ

APRILIA ATLANTIC SPRINT 400 4T 05-08, SCARABEO LIGHT 400 4T 06-08, ATLANTIC 500 4T 01-04, ATLANTIC SPRINT 500 4T 05-08, SCARABEO 500 4T 03-06, SCARABEO LIGHT 500 4T 06-08
GILERA FUOCO 4T-4V IE E3 LT 500 4T 13-14, FUOCO IE EU3 500 4T 07-13, NEXUS 500 4T 03-05, NEXUS EU3 500 4T 06-11, NEXUS SP EU3 500 4T 06-07

PIAGGIO BEVERLY EU3 400 4T 06-07, BEVERLY TOURER EU3 400 4T 08-10, MP3 400 4T 07-08, MP3 IE LT TOURING 400 4T 11-11, MP3 IE LT/SPORT 400 4T 08-10, MP3 MIC 400 4T 08-10, MP3 RL TOURING 400 4T 11-11, X-EVO 400 4T 07-11, X8 EU3 400 4T 06-08, BEVERLY 500 4T 02-06, BEVERLY CRUISER 500 4T 07-12, BEVERLY IE EU3 500 4T 06-08, MP3 LT BUSINESS ABS 500 4T 14-16, MP3 LT E4 SPORT/BUSINESS 500 4T 16-17, MP3 LT SPORT/BUSINESS 500 4T 11-13, MP3 RL SPORT-BUSINESS 500 4T 11-12, MP3 SPORT ABS 500 4T 14-16, X10 4T-4V IE EU3 500 4T 12-14, X9 500 4T 01-02, X9 EVOLUTION 500 4T 03-07, X9 EVOLUTION ABS 500 4T 06-07



◀ **cod. MA00031**
Motorino avviamento Kymco Xciting 300 cc / Sym Joymax 250 cc

RIFERIMENTO ORIGINALE

Kymco	00128750
Kymco	31210KHE790A

Sym	31200HMA000
-----	-------------

APPLICABILITÀ

KYMCO B&W 250 4T 00-00, B&W EU2 250 4T 03-03, GRAND DINK 250 4T 01-02, GRAND DINK EU2 250 4T 03-04, PEOPLE LC 250 4T 03-04, PEOPLE S 250 4T 06-06, PEOPLE S I 250 4T 07-07, X CITING 250 4T 05-05, X CITING I 250 4T 06-07, YUP 250 4T 03-03, G-DINK 300 4T-2V 12-12, PEOPLE S I 300 4T 08-08, X CITING I 300 4T 08-08, X CITING I R 300 4T 08-09

SYM GTS 250 4T-4V 07-08, JOYMAX 250 4T-4V 05-07, JOYMAX EU3 I 250 4T-4V 07-08, CITYCOM 300 4T-4V 08-09, CITYCOM EFI 300 4T-4V 10-11, CITYCOM I CBS 300 4T-4V 12-12, CITYCOM I S EURO4 300 4T-4V 17-17, CITYCOM S I CBS 300 4T-4V 15-15, JOYMAX EVO 300 4T-4V 09-09, JOYMAX EVO I 300 4T-4V 10-10, JOYMAX I 300 4T-4V 12-12, JOYMAX I 300 4T-4V 14-14, JOYMAX I ABS 300 4T-4V 13-14



◀ **cod. MA00032**
Motorino avviamento Honda SH 300 cc

RIFERIMENTO ORIGINALE

Honda	31200-KTW-901
-------	---------------

APPLICABILITÀ

HONDA SH IE SCOOPY 300 4T-4V 07-19



◀ **cod. MA00033**
Motorino avviamento Yamaha T-Max 500/530 cc

RIFERIMENTO ORIGINALE

Yamaha	4B5818900000
--------	--------------

Yamaha	BC3818900000
--------	--------------

APPLICABILITÀ

YAMAHA T-MAX 4BS 500 4T 09-11, T-MAX 4BS ABS 500 4T 08-11, T-MAX 5VU 500 4T 08-08, T-MAX 5VU BLACK MAX 500 4T 06-06, T-MAX SV 500 4T 11-11, T-MAX SV ABS 500 4T 10-11, T-MAX WHITE MAX 500 4T 10-10, T-MAX 59C 530 4T 12-16, T-MAX 59C ABS 530 4T 12-16, T-MAX 59C SP 530 4T 15-15, T-MAX 59C SP ABS 530 4T 15-16, XP530-A-T-MAX SX 530 4T 17-19, XP530D-A T-MAX DX 530 4T 17-19, XP530E-A-T-MAX 530 4T 17-18



cod. 5780BN

Prestolite

DD 12 Volt, CCW, 10-Tooth Pinion

MAKE / MODEL	YEAR
Harley Davidson FL	1941-1964
Harley Davidson FL Series (Pre 1977)	1965-1976
Harley Davidson FLF	1954-1964
Harley Davidson FLFB	1965-1969
Harley Davidson FLH Electra Glide	1955-1983
Harley Davidson FLHB	1965-1969
Harley Davidson FLHC Electra Glide Classic	1979-1981
Harley Davidson FLHF	1955-1972
Harley Davidson FLHFB	1965-1969
Harley Davidson FLHS Electra Glide Sport	1980-1981
Harley Davidson FLT Tour Glide	1980-1983
Harley Davidson FLTC Tour Glide Classic	1981
Harley Davidson FLTC/I Tour Glide Classic	1981
Harley Davidson FXR Super Glide II	1982-1983
Harley Davidson FXRS Low Glide	1982-1983
Harley Davidson XLC	1958
Harley Davidson XLCH	1958-1979
Harley Davidson XLCH Sportster	1975-1978
Harley Davidson XLCR Cafe Racer	1977-1978
Harley Davidson XLH Sportster	1975-1985
Harley Davidson XLH Sportster Anniv.	1978
Harley Davidson XLH Touring	1977
Harley Davidson XLH1000	1972-1980
Harley Davidson XLH900	1958-1971
Harley Davidson XLHA Sportster Annv.	1982
Harley Davidson XLR	1959-1960
Harley Davidson XLRTT	1958-1964
Harley Davidson XLS Roadster	1978-1985
Harley Davidson XLSA Roadster Anniv.	1982
Harley Davidson XLT	1977-1978
Harley Davidson XLX-61	1983-1985
Harley Davidson XR	1969-1975
Harley Davidson XR1000	1983-1985



cod. 5780CN

Prestolite

DD 12 Volt, CCW, 10-Tooth Pinion

MAKE / MODEL	YEAR
Harley Davidson FL	1941-1964
Harley Davidson FL Series (Pre 1977)	1965-1976
Harley Davidson FLF	1953-1964
Harley Davidson FLFB	1965-1969
Harley Davidson FLH Electra Glide	1955-1983
Harley Davidson FLHB	1965-1969
Harley Davidson FLHC Electra Glide Classic	1979-1981
Harley Davidson FLHF	1955-1972
Harley Davidson FLHFB	1965-1969
Harley Davidson FLHS Electra Glide Sport	1980-1981
Harley Davidson FLT Tour Glide	1980-1983

◀ **cod. 5780CN** - continued

MAKE / MODEL	YEAR
Harley Davidson FLTC Tour Glide Classic	1981
Harley Davidson FLTC/I Tour Glide Classic	1981
Harley Davidson FXR Super Glide II	1982-1983
Harley Davidson FXRS Low Glide	1982-1983
Harley Davidson XLC	1958
Harley Davidson XLCH	1958-1979
Harley Davidson XLCH Sportster	1975-1978
Harley Davidson XLCR Cafe Racer	1977-1978
Harley Davidson XLH Sportster	1975-1985
Harley Davidson XLH Sportster Anniv.	1978
Harley Davidson XLH Touring	1977
Harley Davidson XLH1000	1972-1980
Harley Davidson XLH900	1958-1971
Harley Davidson XLHA Sportster Anniv.	1982
Harley Davidson XLR	1959-1960
Harley Davidson XLRTT	1958-1964
Harley Davidson XLS Roadster	1978-1985
Harley Davidson XLSA Roadster Anniv.	1982
Harley Davidson XLT	1977-1978
Harley Davidson XLX-61	1983-1985
Harley Davidson XR	1969-1975
Harley Davidson XR1000	1983-1985

◀ **cod. 11834N**

KTM PMDD
12 Volt, CW, 9-Tooth Pinion

MAKE / MODEL	YEAR
KTM 250 SX-F	2012-2014
KTM 350 EXC-F	2012-2014
KTM 350 Freeride	2012
KTM 350 SX-F	2011-2014
KTM 350 XC-F	2012-2014
KTM 350 XCF-W	2012-2014
KTM 450 SX-F	2014

◀ **cod. 11835N**

KTM PMDD
0.5kW/12 Volt, CCW, 9-Tooth Pinion

MAKE / MODEL	YEAR
KTM 450 SX-F	2013
KTM 450 SX-F Factory Edition	2013
KTM 450 XC-F	2011-2013
KTM 450 XC-W	2012-2014
KTM 500 EXC	2012-2014
KTM 500 EXC Six Days	2012
KTM 500 XC-W	2012-2014





◀ **cod. 15410BN**

Prestolite
10 Amp/12 Volt, CCW

MAKE / MODEL	YEAR
Harley Davidson FL Series (Pre 1977)	1965-1969
Harley Davidson FLFB	1965-1969
Harley Davidson FLHB	1965-1969
Harley Davidson XLC	1958
Harley Davidson XLCH	1958-1979
Harley Davidson XLCR Cafe Racer	1977-1978
Harley Davidson XLH Sportster	1979-1984
Harley Davidson XLH1000	1972-1981
Harley Davidson XLHA Sportster Annv.	1982
Harley Davidson XLS Roadster	1979-1984
Harley Davidson XLSA Roadster Anniv.	1982
Harley Davidson XLX-61	1983-1984
Harley Davidson XR1000	1983-1985



◀ **cod. 16071N**

Mitsuba PMDD
12 Volt

MAKE / MODEL	YEAR
Honda CBR250R	2011-2013
Honda CBR300R	2015-2016



◀ **cod. 16072N**

Mitsuba PMDD
12 Volt, 9-Tooth Pinion

MAKE / MODEL	YEAR
Honda SH300	2007-2013



◀ **cod. 16073N**

Mitsuba PMDD
12 Volt, CW

MAKE / MODEL	YEAR
Aprilia Atlantic 400 Sprint	2005-2008
Aprilia Atlantic 500	2001-2005
Aprilia Atlantic 500 Sprint	2005-2008
Aprilia Scarabeo 500	2003-2006
Aprilia Scarabeo 500 Light	2006-2013
Aprilia Scarabeo 500 Sprint	2006





◀ **cod. 16075N**
Mitsuba PMDD
12 Volt, CW, 9-Tooth Pinion

MAKE / MODEL	YEAR
Yamaha WR450F	2007-2015



◀ **cod. 16079N**
Mitsuba PMDD
12 Volt, CCW, 9-Tooth Pinion

MAKE / MODEL	YEAR
Yamaha TTR125E	2003-2007
Yamaha TTR125LE	2003-2007



◀ **cod. 16087N**
Mitsuba PMDD
12 Volt, CCW, 9-Tooth Pinion

MAKE / MODEL	YEAR
Suzuki GSF1250S Bandit	2007-2009
Suzuki GSF1250SA Bandit ABS	2007-2009
Suzuki GSX1250FA	2011



◀ **cod. 16088N**
Mitsuba PMDD
12 Volt, CCW, 12-Tooth Pinion

MAKE / MODEL	YEAR
Aprilia Scarabeo 100	2002-2008
Aprilia Scarabeo 100 4T	2006-2010
Aprilia SR 125	1999-2001
Aprilia SR 150	1999-2001
Piaggio Fly 100	All
Piaggio Free 100	All
Piaggio Hexagon 125	All
Piaggio Hexagon 150	All
Piaggio Hexagon 180	All
Piaggio Skipper 125	All
Piaggio Skipper 150	All
Piaggio Zip 100	All

◀ cod. 16090N

Mitsuba PMDD
12 Volt, CCW, 9-Tooth Pinion



MAKE / MODEL	YEAR
Yamaha YW125 Zuma 125	2009-2015

◀ cod. 16091N

Mitsuba PMDD
12 Volt, CCW, 10-Tooth Pinion

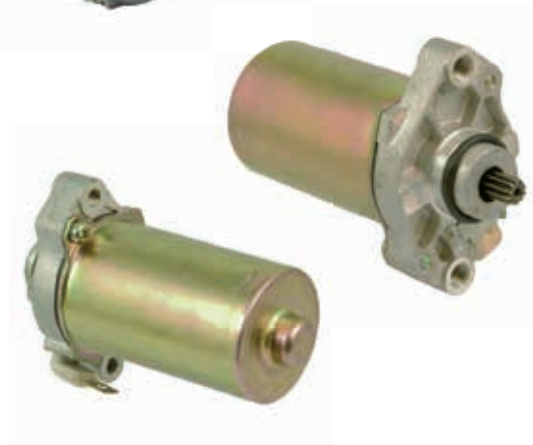

MAKE / MODEL	YEAR
Peugeot - Europe Elystar 50	All
Peugeot - Europe Jet Force 50	All
Peugeot - Europe Looxor 50 TDSI	All

◀ cod. 17629BN

Denso OSGR
1.4kW/12 Volt, CW, 18 Tooth Spline



MAKE / MODEL	YEAR
Harley Davidson FLHS Electra Glide Sport	1989-1993
Harley Davidson FLHTC Electra Glide Classic	1989-1993
Harley Davidson FLHTCI Electra Glide Classic	1989-1993
Harley Davidson FLHTCU Electra Glide Ultra Classic	1989-1993
Harley Davidson FLHTCUI Electra Glide Ultra Classic	1989-1993
Harley Davidson FLHTP Police	1989
Harley Davidson FLSTC Heritage Softail Classic	1989-1993
Harley Davidson FLSTCI Heritage Softail Classic	1988-1993
Harley Davidson FLSTF Fat Boy	1990-1993
Harley Davidson FLSTFI Fat Boy	1990-1993
Harley Davidson FLSTI Heritage Softail	1989-1990
Harley Davidson FLSTN Heritage Softail Nostalgia	1993
Harley Davidson FLSTNI Softail Deluxe	1993
Harley Davidson FLTC Tour Glide Classic	1989-1991
Harley Davidson FLTC/I Tour Glide Classic	1989-1991
Harley Davidson FLTCU Tour Glide Ultra Classic	1989-1993
Harley Davidson FLTCUI Tour Glide Ultra Classic	1989-1993
Harley Davidson FXDB-D Dyna Glide Daytona	1992
Harley Davidson FXDB-S Dyna Glide Sturgis	1991
Harley Davidson FXDC Super Glide Custom	1992
Harley Davidson FXDL Dyna Low Rider	1993
Harley Davidson FXDLI Dyna Low Rider	1993
Harley Davidson FXDWG Dyna Wide Glide	1993
Harley Davidson FXDWGI Dyna Wide Glide	1993
Harley Davidson FXLR Low Rider Custom	1989-1993
Harley Davidson FXR Super Glide II	1989-1993

◀ cod. **17629BN** - continued

MAKE / MODEL	YEAR
Harley Davidson FXRP Police	1989
Harley Davidson FXRS Low Glide	1989-1992
Harley Davidson FXRS-Conv Low Rider Sport Convertible	1990-1993
Harley Davidson FXRS-SP Low Rider Sport	1986-1993
Harley Davidson FXRT Sport Glide	1989-1992
Harley Davidson FXST Softail Standard	1989-1990
Harley Davidson FXSTC Softail Custom	1989-1993
Harley Davidson FXSTI Softail Standard	1989-1990
Harley Davidson FXSTS Springer Softail	1989-1993
Harley Davidson FXSTSI Springer Softail	1989-1993



◀ cod. **17629CN**

Denso OSGR
1.4kW/12 Volt, CW, Chrome

MAKE / MODEL	YEAR
Harley Davidson FLHS Electra Glide Sport	1989-1993
Harley Davidson FLHTC Electra Glide Classic	1989-1993
Harley Davidson FLHTCI Electra Glide Classic	1989-1993
Harley Davidson FLHTCU Electra Glide Ultra Classic	1989-1993
Harley Davidson FLHTCUI Electra Glide Ultra Classic	1989-1993
Harley Davidson FLHTP Police	1989
Harley Davidson FLSTC Heritage Softail Classic	1989-1993
Harley Davidson FLSTCI Heritage Softail Classic	1988-1993
Harley Davidson FLSTF Fat Boy	1990-1993
Harley Davidson FLSTFI Fat Boy	1990-1993
Harley Davidson FLSTI Heritage Softail	1989-1990
Harley Davidson FLSTN Heritage Softail Nostalgia	1993
Harley Davidson FLSTNI Softail Deluxe	1993
Harley Davidson FLTC Tour Glide Classic	1989-1991
Harley Davidson FLTC/I Tour Glide Classic	1989-1991
Harley Davidson FLTCU Tour Glide Ultra Classic	1989-1993
Harley Davidson FLTCUI Tour Glide Ultra Classic	1989-1993
Harley Davidson FXDB-D Dyna Glide Daytona	1992
Harley Davidson FXDB-S Dyna Glide Sturgis	1991
Harley Davidson FXDC Super Glide Custom	1992
Harley Davidson FXDL Dyna Low Rider	1993
Harley Davidson FXDLI Dyna Low Rider	1993
Harley Davidson FXDWG Dyna Wide Glide	1993
Harley Davidson FXDWGI Dyna Wide Glide	1993
Harley Davidson FXLR Low Rider Custom	1989-1993
Harley Davidson FXR Super Glide II	1989-1993
Harley Davidson FXRP Police	1989
Harley Davidson FXRS Low Glide	1989-1992
Harley Davidson FXRS-Conv Low Rider Sport Convertible	1990-1993
Harley Davidson FXRS-SP Low Rider Sport	1986-1993
Harley Davidson FXRT Sport Glide	1989-1992
Harley Davidson FXST Softail Standard	1989-1990
Harley Davidson FXSTC Softail Custom	1989-1993
Harley Davidson FXSTI Softail Standard	1989-1990
Harley Davidson FXSTS Springer Softail	1989-1993
Harley Davidson FXSTSI Springer Softail	1989-1993



◀ **cod. 17629CN-HT**

Denso OSGR
1.8kW/12 Volt, CW, Chrome

MAKE / MODEL	YEAR
Harley Davidson FLHS Electra Glide Sport	1991-1993
Harley Davidson FLHTC Electra Glide Classic	1991-1993
Harley Davidson FLHTCI Electra Glide Classic	1991-1993
Harley Davidson FLHTCU Electra Glide Ultra Classic	1991-1993
Harley Davidson FLHTCUI Electra Glide Ultra Classic	1991-1993
Harley Davidson FLSTC Heritage Softail Classic	1991-1993
Harley Davidson FLSTCI Heritage Softail Classic	1992-1993
Harley Davidson FLSTF Fat Boy	1991-1993
Harley Davidson FLSTFI Fat Boy	1991-1993
Harley Davidson FLSTN Heritage Softail Nostalgia	1993
Harley Davidson FLSTNI Softail Deluxe	1993
Harley Davidson FLTC Tour Glide Classic	1991
Harley Davidson FLTC/I Tour Glide Classic	1991
Harley Davidson FLTCU Tour Glide Ultra Classic	1991-1993
Harley Davidson FLTCUI Tour Glide Ultra Classic	1991-1993
Harley Davidson FXDB-D Dyna Glide Daytona	1992
Harley Davidson FXDB-S Dyna Glide Sturgis	1991
Harley Davidson FXDC Super Glide Custom	1992
Harley Davidson FXDL Dyna Low Rider	1993
Harley Davidson FXDLI Dyna Low Rider	1993
Harley Davidson FXDWG Dyna Wide Glide	1993
Harley Davidson FXDWGI Dyna Wide Glide	1993
Harley Davidson FXLR Low Rider Custom	1991-1993
Harley Davidson FXR Super Glide II	1991-1993
Harley Davidson FXRS Low Glide	1991-1992
Harley Davidson FXRS-Conv Low Rider Sport Convertible	1991-1993
Harley Davidson FXRS-SP Low Rider Sport	1991-1993
Harley Davidson FXRT Sport Glide	1991-1992
Harley Davidson FXSTC Softail Custom	1991-1993
Harley Davidson FXSTS Springer Softail	1991-1993
Harley Davidson FXSTSI Springer Softail	1991-1993



◀ **cod. 17629N**

Denso OSGR
1.4kW/12 Volt, CW

MAKE / MODEL	YEAR
Harley Davidson FLHS Electra Glide Sport	1991-1993
Harley Davidson FLHTC Electra Glide Classic	1991-1993
Harley Davidson FLHTCI Electra Glide Classic	1991-1993
Harley Davidson FLHTCU Electra Glide Ultra Classic	1991-1993
Harley Davidson FLHTCUI Electra Glide Ultra Classic	1991-1993
Harley Davidson FLSTC Heritage Softail Classic	1991-1993
Harley Davidson FLSTCI Heritage Softail Classic	1991-1993
Harley Davidson FLSTF Fat Boy	1991-1993
Harley Davidson FLSTFI Fat Boy	1991-1993
Harley Davidson FLSTN Heritage Softail Nostalgia	1993
Harley Davidson FLSTNI Softail Deluxe	1993
Harley Davidson FLTC Tour Glide Classic	1991

◀ **cod. 17629N** - continued

MAKE / MODEL	YEAR
Harley Davidson FLTC/I Tour Glide Classic	1991
Harley Davidson FLTCU Tour Glide Ultra Classic	1991-1993
Harley Davidson FLTCUI Tour Glide Ultra Classic	1991-1993
Harley Davidson FXDB-D Dyna Glide Daytona	1992
Harley Davidson FXDB-S Dyna Glide Sturgis	1991
Harley Davidson FXDC Super Glide Custom	1992
Harley Davidson FXDL Dyna Low Rider	1993
Harley Davidson FXDLI Dyna Low Rider	1993
Harley Davidson FXDWG Dyna Wide Glide	1993
Harley Davidson FXDWGI Dyna Wide Glide	1993
Harley Davidson FXLR Low Rider Custom	1991-1993
Harley Davidson FXR Super Glide II	1991-1993
Harley Davidson FXRS Low Glide	1991-1992
Harley Davidson FXRS-Conv Low Rider Sport Convertible	1991-1993
Harley Davidson FXRS-SP Low Rider Sport	1991-1993
Harley Davidson FXRT Sport Glide	1991-1992
Harley Davidson FXSTC Softail Custom	1991-1993
Harley Davidson FXSTS Springer Softail	1991-1993
Harley Davidson FXSTSI Springer Softail	1991-1993



◀ **cod. 18199BN**

Denso OSGR
1.4kW/12 Volt, CW, 18-Tooth Spline

MAKE / MODEL	YEAR
Harley Davidson FLHR Road King	1994-2006
Harley Davidson FLHRCI Road King Classic	1998-2006
Harley Davidson FLHRI Road King	1996-2006
Harley Davidson FLHRS Road King Custom	2004-2006
Harley Davidson FLHRSEI Screamin Eagle Road King	2002
Harley Davidson FLHRSI Road King Custom	2004-2006
Harley Davidson FLHT Electra Glide Standard	1995-2006
Harley Davidson FLHTC Electra Glide Classic	1994-2005
Harley Davidson FLHTCI Electra Glide Classic	1994-2006
Harley Davidson FLHTCU Electra Glide Ultra Classic	1994-1997
Harley Davidson FLHTCUI Electra Glide Ultra Classic	1995-2006
Harley Davidson FLHTI Electra Glide Standard	1995-2006
Harley Davidson FLHX Street Glide	2006
Harley Davidson FLHXI Street Glide	2006
Harley Davidson FLST Heritage Softail	2006
Harley Davidson FLSTC Heritage Softail Classic	1994-2006
Harley Davidson FLSTCI Heritage Softail Classic	1994-2006
Harley Davidson FLSTF Fat Boy	1994-2006
Harley Davidson FLSTFI Fat Boy	1994-2006
Harley Davidson FLSTI Heritage Softail	2006
Harley Davidson FLSTN Heritage Softail Special	1994-1996
Harley Davidson FLSTN Softail Deluxe	2005-2006
Harley Davidson FLSTNI Softail Deluxe	1993-2006
Harley Davidson FLSTS Heritage Springer	1997-2003
Harley Davidson FLSTSC Softail Springer Classic	2005-2006
Harley Davidson FLSTSCI Softail Springer Classic	2005-2006



◀ cod. 18199BN - continued

MAKE / MODEL	YEAR
Harley Davidson FLSTSI Heritage Springer	1997-2003
Harley Davidson FLTCU Tour Glide Ultra Classic	1994-1995
Harley Davidson FLTCUI Tour Glide Ultra Classic	1994-1996
Harley Davidson FLTR Road Glide	1998-2002
Harley Davidson FLTRI Road Glide	1998-2006
Harley Davidson FLTRSEI Screamin Eagle Road Glide	2000
Harley Davidson FLTRSEI2 Screamin Eagle Road Glide 2	2001
Harley Davidson FXD Dyna Super Glide	1995-2005
Harley Davidson FXD35 Super Golden Anniversary	2006
Harley Davidson FXDBI Street Bob	2006
Harley Davidson FXDC Super Glide Custom	2005
Harley Davidson FXDCI Super Glide Custom	2005-2006
Harley Davidson FXDI Dyna Super Glide	1995-2006
Harley Davidson FXDL Dyna Low Rider	1994-2005
Harley Davidson FXDLI Dyna Low Rider	1994-2006
Harley Davidson FXDS-Conv Dyna Convertible	1994-2000
Harley Davidson FXDWG Dyna Wide Glide	1994-2005
Harley Davidson FXDWG2	2001
Harley Davidson FXDWG3	2002
Harley Davidson FXDWGI Dyna Wide Glide	1994-2006
Harley Davidson FXDX Dyna Super Glide Sport	1999-2005
Harley Davidson FXDXI Dyna Super Glide Sport	2004-2005
Harley Davidson FXDXT Dyna Super Glide T-Sport	2001-2003
Harley Davidson FXLR Low Rider Custom	1994
Harley Davidson FXR Super Glide II	1994
Harley Davidson FXR2	1999
Harley Davidson FXR3	1999
Harley Davidson FXR4	2000
Harley Davidson FXST Softail Standard	1999-2006
Harley Davidson FXSTB Night Train	1999-2006
Harley Davidson FXSTBI Night Train	1999-2006
Harley Davidson FXSTC Softail Custom	1994-1999
Harley Davidson FXSTD Softail Deuce	2000-2006
Harley Davidson FXSTDI Softail Deuce	2000-2006
Harley Davidson FXSTDSE Screamin Eagle Softail Deuce	2003
Harley Davidson FXSTDSE2 Screamin Eagle Softail Deuce 2	2004
Harley Davidson FXSTI Softail Standard	1999-2006
Harley Davidson FXSTS Springer Softail	1994-2006
Harley Davidson FXSTSB Bad Boy	1995-1997
Harley Davidson FXSTSI Springer Softail	1994-2006

◀ cod. 18199CN

Denso OSGR

1.4kW/12 Volt, CW, Chrome, 18-Tooth Spline

MAKE / MODEL	YEAR
Harley Davidson FLHRCI Road King Classic	1998-2006
Harley Davidson FLHRI Road King	1996-2006
Harley Davidson FLHRSEI Screamin Eagle Road King	2002
Harley Davidson FLHRSI Road King Custom	2004-2006
Harley Davidson FLHT Electra Glide Standard	1995-2006



◀ cod. **18199CN** - continued

MAKE / MODEL	YEAR
Harley Davidson FLHTCI Electra Glide Classic	1994-2006
Harley Davidson FLHTCUI Electra Glide Ultra Classic	1995-2006
Harley Davidson FLHTI Electra Glide Standard	1995-2006
Harley Davidson FLHXI Street Glide	2006
Harley Davidson FLST Heritage Softail	2006
Harley Davidson FLSTC Heritage Softail Classic	1994-2006
Harley Davidson FLSTCI Heritage Softail Classic	1994-2006
Harley Davidson FLSTF Fat Boy	1994-2006
Harley Davidson FLSTFI Fat Boy	1994-2006
Harley Davidson FLSTI Heritage Softail	2006
Harley Davidson FLSTN Heritage Softail Special	1994-1996
Harley Davidson FLSTN Softail Deluxe	2005-2006
Harley Davidson FLSTNI Softail Deluxe	1993-2006
Harley Davidson FLSTS Heritage Springer	1997-2003
Harley Davidson FLSTSCI Softail Springer Classic	2005-2006
Harley Davidson FLSTSI Heritage Springer	1997-2003
Harley Davidson FLTCU Tour Glide Ultra Classic	1994-1995
Harley Davidson FLTCUI Tour Glide Ultra Classic	1994-1996
Harley Davidson FLTR Road Glide	1998-2002
Harley Davidson FLTRI Road Glide	1998-2006
Harley Davidson FLTRSEI Screamin Eagle Road Glide	2000
Harley Davidson FLTRSEI2 Screamin Eagle Road Glide 2	2001
Harley Davidson FXD Dyna Super Glide	1995-2005
Harley Davidson FXDBI Street Bob	2006
Harley Davidson FXDC Super Glide Custom	2005
Harley Davidson FXDCI Super Glide Custom	2005-2006
Harley Davidson FXDI Dyna Super Glide	1995-2006
Harley Davidson FXDL Dyna Low Rider	1994-2005
Harley Davidson FXDLI Dyna Low Rider	1994-2006
Harley Davidson FXDS-Conv Dyna Convertible	1994-2000
Harley Davidson FXDWG Dyna Wide Glide	1994-2005
Harley Davidson FXDWG2	2001
Harley Davidson FXDWG3	2002
Harley Davidson FXDWGI Dyna Wide Glide	1994-2003
Harley Davidson FXDX Dyna Super Glide Sport	1999-2005
Harley Davidson FXDXI Dyna Super Glide Sport	2004-2005
Harley Davidson FXDXT Dyna Super Glide T-Sport	2001-2003
Harley Davidson FXLR Low Rider Custom	1994
Harley Davidson FXR Super Glide II	1994
Harley Davidson FXR2	1999
Harley Davidson FXR3	1999
Harley Davidson FXR4	2000
Harley Davidson FXST Softail Standard	1999-2006
Harley Davidson FXSTB Night Train	1999-2006
Harley Davidson FXSTBI Night Train	1999-2006
Harley Davidson FXSTC Softail Custom	1994-1999
Harley Davidson FXSTD Softail Deuce	2000-2006
Harley Davidson FXSTDI Softail Deuce	2000-2006
Harley Davidson FXSTDSE Screamin Eagle Softail Deuce	2003
Harley Davidson FXSTDSE2 Screamin Eagle Softail Deuce 2	2004
Harley Davidson FXSTI Softail Standard	1999-2006
Harley Davidson FXSTS Springer Softail	1994-2006
Harley Davidson FXSTSB Bad Boy	1995-1997
Harley Davidson FXSTSI Springer Softail	1994-2006



◀ cod. **18199N**
Denso OSGR
1.4kW/12 Volt, CW, 18-Tooth Spline

MAKE / MODEL	YEAR
Harley Davidson FLHR Road King	1994-2006
Harley Davidson FLHRCI Road King Classic	1998-2006
Harley Davidson FLHRI Road King	1996-2006
Harley Davidson FLHRS Road King Custom	2004-2006
Harley Davidson FLHRSEI Screamin Eagle Road King	2002
Harley Davidson FLHRSI Road King Custom	2004-2006
Harley Davidson FLHT Electra Glide Standard	1995-2006
Harley Davidson FLHTC Electra Glide Classic	1994-2005
Harley Davidson FLHTCI Electra Glide Classic	1994-2006
Harley Davidson FLHTCU Electra Glide Ultra Classic	1994-1997
Harley Davidson FLHTCUI Electra Glide Ultra Classic	1995-2006
Harley Davidson FLHTI Electra Glide Standard	1995-2006
Harley Davidson FLHX Street Glide	2006
Harley Davidson FLHXI Street Glide	2006
Harley Davidson FLST Heritage Softail	2006
Harley Davidson FLSTC Heritage Softail Classic	1994-2006
Harley Davidson FLSTCI Heritage Softail Classic	1994-2006
Harley Davidson FLSTF Fat Boy	1994-2006
Harley Davidson FLSTFI Fat Boy	1994-2006
Harley Davidson FLSTI Heritage Softail	2006
Harley Davidson FLSTN Heritage Softail Special	1994-1996
Harley Davidson FLSTN Softail Deluxe	2005-2006
Harley Davidson FLSTNI Softail Deluxe	1993-2006
Harley Davidson FLSTS Heritage Springer	1997-2003
Harley Davidson FLSTSC Softail Springer Classic	2005-2006
Harley Davidson FLSTSCI Softail Springer Classic	2005-2006
Harley Davidson FLSTSI Heritage Springer	1997-2003
Harley Davidson FLTCU Tour Glide Ultra Classic	1994-1995
Harley Davidson FLTCUI Tour Glide Ultra Classic	1994-1996
Harley Davidson FLTR Road Glide	1998-2002
Harley Davidson FLTRI Road Glide	1998-2006
Harley Davidson FLTRSEI Screamin Eagle Road Glide	2000
Harley Davidson FLTRSEI2 Screamin Eagle Road Glide 2	2001
Harley Davidson FXD Dyna Super Glide	1995-2005
Harley Davidson FXD35 Super Golden Anniversary	2006
Harley Davidson FXDBI Street Bob	2006
Harley Davidson FXDC Super Glide Custom	2005
Harley Davidson FXDCI Super Glide Custom	2005-2006
Harley Davidson FXDI Dyna Super Glide	1995-2006
Harley Davidson FXDL Dyna Low Rider	1994-2005
Harley Davidson FXDLI Dyna Low Rider	1994-2006
Harley Davidson FXDS-Conv Dyna Convertible	1994-2000
Harley Davidson FXDWG Dyna Wide Glide	1994-2005
Harley Davidson FXDWG2	2001
Harley Davidson FXDWG3	2002
Harley Davidson FXDWGI Dyna Wide Glide	1994-2006
Harley Davidson FXDX Dyna Super Glide Sport	1999-2005
Harley Davidson FXDXI Dyna Super Glide Sport	2004-2005
Harley Davidson FXDXT Dyna Super Glide T-Sport	2001-2003
Harley Davidson FXLR Low Rider Custom	1994
Harley Davidson FXR Super Glide II	1994
Harley Davidson FXR2	1999

◀ **cod. 18199N** - continued

MAKE / MODEL	YEAR
Harley Davidson FXR3	1999
Harley Davidson FXR4	2000
Harley Davidson FXST Softail Standard	1999-2006
Harley Davidson FXSTB Night Train	1999-2006
Harley Davidson FXSTBI Night Train	1999-2006
Harley Davidson FXSTC Softail Custom	1994-1999
Harley Davidson FXSTD Softail Deuce	2000-2006
Harley Davidson FXSTDI Softail Deuce	2000-2006
Harley Davidson FXSTDSE Screamin Eagle Softail Deuce	2003
Harley Davidson FXSTDSE2 Screamin Eagle Softail Deuce 2	2004
Harley Davidson FXSTI Softail Standard	1999-2006
Harley Davidson FXSTS Springer Softail	1994-2006
Harley Davidson FXSTSB Bad Boy	1995-1997
Harley Davidson FXSTSI Springer Softail	1994-2006



◀ **cod. 18300BN**

Hitachi DD

12 Volt, CCW, 10-Tooth Pinion

MAKE / MODEL	YEAR
Harley Davidson FLH Electra Glide	1984-1985
Harley Davidson FLHC Electra Glide Classic	1980
Harley Davidson FLHS Electra Glide Sport	1984-1988
Harley Davidson FLHT Electra Glide Standard	1986-1987
Harley Davidson FLHTC Electra Glide Classic	1983-1988
Harley Davidson FLHTCI Electra Glide Classic	1983-1988
Harley Davidson FLHTI Electra Glide Standard	1986-1987
Harley Davidson FLHTP Police	1985-1988
Harley Davidson FLHX Electra Glide Special	1984-1985
Harley Davidson FLST Heritage Softail	1986-1990
Harley Davidson FLSTC Heritage Softail Classic	1988
Harley Davidson FLSTI Heritage Softail	1986-1988
Harley Davidson FLT Tour Glide	1983
Harley Davidson FLTC Tour Glide Classic	1982-1988
Harley Davidson FLTC/I Tour Glide Classic	1982-1988
Harley Davidson FX Super Glide	1971-1978
Harley Davidson FXB Sturgis	1980-1982
Harley Davidson FXDG Disc Glide	1983
Harley Davidson FXE Super Glide	1974-1984
Harley Davidson FXEF Fat Bob	1979-1985
Harley Davidson FXLR Low Rider Custom	1987-1988
Harley Davidson FXR Super Glide II	1983-1988
Harley Davidson FXRC Low Rider Chrome	1985-1987
Harley Davidson FXRD Sport Glide Grand Touring	1986
Harley Davidson FXRDG Disc Glide	1984
Harley Davidson FXRP Police	1985-1988
Harley Davidson FXRS Low Glide	1984-1988
Harley Davidson FXRS Low Rider Liberty	1986
Harley Davidson FXRT Sport Glide	1983-1988
Harley Davidson FXS Low Rider	1977-1982
Harley Davidson FXSB Low Rider - Belt	1983-1985

◀ cod. 18300BN - continued

MAKE / MODEL	YEAR
Harley Davidson FXST Softail Standard	1984-1988
Harley Davidson FXSTC Softail Custom	1986-1988
Harley Davidson FXSTI Softail Standard	1984-1988
Harley Davidson FXSTS Springer Softail	1988
Harley Davidson FXSTSI Springer Softail	1988
Harley Davidson FXWG Wide Glide	1980-1986
Harley Davidson XLCH	1974-1976



◀ cod. 18300CN

Hitachi DD
12 Volt, CCW, 10-Tooth Pinion

MAKE / MODEL	YEAR
Harley Davidson FLH Electra Glide	1984-1985
Harley Davidson FLHC Electra Glide Classic	1980
Harley Davidson FLHS Electra Glide Sport	1984-1988
Harley Davidson FLHT Electra Glide Standard	1986-1987
Harley Davidson FLHTC Electra Glide Classic	1983-1988
Harley Davidson FLHTCI Electra Glide Classic	1983-1988
Harley Davidson FLHTI Electra Glide Standard	1986-1987
Harley Davidson FLHTP Police	1985-1988
Harley Davidson FLHX Electra Glide Special	1984-1985
Harley Davidson FLST Heritage Softail	1986-1990
Harley Davidson FLSTC Heritage Softail Classic	1988
Harley Davidson FLSTI Heritage Softail	1986-1988
Harley Davidson FLT Tour Glide	1983
Harley Davidson FLTC Tour Glide Classic	1982-1988
Harley Davidson FLTC/I Tour Glide Classic	1982-1988
Harley Davidson FX Super Glide	1971-1978
Harley Davidson FXB Sturgis	1980-1982
Harley Davidson FXDG Disc Glide	1983
Harley Davidson FXE Super Glide	1974-1984
Harley Davidson FXEF Fat Bob	1979-1985
Harley Davidson FXLR Low Rider Custom	1987-1988
Harley Davidson FXR Super Glide II	1983-1988
Harley Davidson FXRC Low Rider Chrome	1985-1987
Harley Davidson FXRD Sport Glide Grand Touring	1986
Harley Davidson FXRDG Disc Glide	1984
Harley Davidson FXRP Police	1985-1988
Harley Davidson FXRS Low Glide	1984-1988
Harley Davidson FXRS Low Rider Liberty	1986
Harley Davidson FXRT Sport Glide	1983-1988
Harley Davidson FXS Low Rider	1977-1982
Harley Davidson FXSB Low Rider - Belt	1983-1985
Harley Davidson FXST Softail Standard	1984-1988
Harley Davidson FXSTC Softail Custom	1986-1988
Harley Davidson FXSTI Softail Standard	1984-1988
Harley Davidson FXSTS Springer Softail	1988
Harley Davidson FXSTSI Springer Softail	1988
Harley Davidson FXWG Wide Glide	1980-1986
Harley Davidson XLCH	1974-1976



◀ **cod. 18446CN**

Denso OSGR

2.0kW/12 Volt, CW, Chrome, 18-Tooth Spline

MAKE / MODEL	YEAR
Harley Davidson FLHR Road King	1994-2006
Harley Davidson FLHRCI Road King Classic	1998-2006
Harley Davidson FLHRI Road King	1996-2006
Harley Davidson FLHRS Road King Custom	2004-2006
Harley Davidson FLHRSEI Screamin Eagle Road King	2002
Harley Davidson FLHRSI Road King Custom	2004-2006
Harley Davidson FLHT Electra Glide Standard	1995-2006
Harley Davidson FLHTC Electra Glide Classic	1994-2005
Harley Davidson FLHTCI Electra Glide Classic	1994-2006
Harley Davidson FLHTCU Electra Glide Ultra Classic	1994-1997
Harley Davidson FLHTCUI Electra Glide Ultra Classic	1994-2006
Harley Davidson FLHTI Electra Glide Standard	1995-2006
Harley Davidson FLHX Street Glide	2006
Harley Davidson FLSTC Heritage Softail Classic	1994-2006
Harley Davidson FLSTCI Heritage Softail Classic	1994-2006
Harley Davidson FLSTF Fat Boy	1994-2006
Harley Davidson FLSTFI Fat Boy	1994-2006
Harley Davidson FLSTI Heritage Softail	2006
Harley Davidson FLSTN Heritage Softail Special	1994-1996
Harley Davidson FLSTN Softail Deluxe	2005-2006
Harley Davidson FLSTNI Softail Deluxe	1993-2006
Harley Davidson FLSTS Heritage Springer	1997-2003
Harley Davidson FLSTSC Softail Springer Classic	2005-2006
Harley Davidson FLSTSCI Softail Springer Classic	2005-2006
Harley Davidson FLSTSI Heritage Springer	1997-2003
Harley Davidson FLTCU Tour Glide Ultra Classic	1994-1995
Harley Davidson FLTCUI Tour Glide Ultra Classic	1994-1996
Harley Davidson FLTR Road Glide	1998-2002
Harley Davidson FLTRI Road Glide	1998-2006
Harley Davidson FLTRSEI Screamin Eagle Road Glide	2000
Harley Davidson FLTRSEI2 Screamin Eagle Road Glide 2	2001
Harley Davidson FXD Dyna Super Glide	1995-2005
Harley Davidson FXD35 Super Golden Anniversary	2006
Harley Davidson FXDBI Street Bob	2006
Harley Davidson FXDC Super Glide Custom	2005
Harley Davidson FXDCI Super Glide Custom	2005-2006
Harley Davidson FXDI Dyna Super Glide	1995-2006
Harley Davidson FXDL Dyna Low Rider	1994-2005
Harley Davidson FXDLI Dyna Low Rider	1994-2006
Harley Davidson FXDS-Conv Dyna Convertible	1994-2000
Harley Davidson FXDWG Dyna Wide Glide	1994-2005
Harley Davidson FXDWG2	2001
Harley Davidson FXDWG3	2002
Harley Davidson FXDWGI Dyna Wide Glide	1994-2006
Harley Davidson FXDX Dyna Super Glide Sport	1999-2005
Harley Davidson FXDXI Dyna Super Glide Sport	2004-2005
Harley Davidson FXDXT Dyna Super Glide T-Sport	2001-2003
Harley Davidson FXLR Low Rider Custom	1994
Harley Davidson FXR Super Glide II	1994
Harley Davidson FXR2	1999
Harley Davidson FXR3	1999
Harley Davidson FXR4	2000

◀ cod. 18446CN - continued

MAKE / MODEL	YEAR
Harley Davidson FXST Softail Standard	1999-2006
Harley Davidson FXSTB Night Train	1999-2006
Harley Davidson FXSTBI Night Train	1999-2006
Harley Davidson FXSTC Softail Custom	1994-1999
Harley Davidson FXSTD Softail Deuce	2000-2006
Harley Davidson FXSTDI Softail Deuce	2000-2006
Harley Davidson FXSTDSE Screamin Eagle Softail Deuce	2003
Harley Davidson FXSTDSE2 Screamin Eagle Softail Deuce 2	2004
Harley Davidson FXSTI Softail Standard	2000-2006
Harley Davidson FXSTS Springer Softail	1994-2006
Harley Davidson FXSTSB Bad Boy	1995-1997
Harley Davidson FXSTSI Springer Softail	1994-2006

◀ cod. 18446N

Denso OSGR

2.0kW/12 Volt, CW, 18-Tooth Spline



MAKE / MODEL	YEAR
Harley Davidson FLHR Road King	1994-1999
Harley Davidson FLHRCI Road King Classic	1998-2006
Harley Davidson FLHRI Road King	1996-2006
Harley Davidson FLHRS Road King Custom	2004-2006
Harley Davidson FLHRSEI Screamin Eagle Road King	2002
Harley Davidson FLHRSI Road King Custom	2004-2006
Harley Davidson FLHT Electra Glide Standard	1995-2006
Harley Davidson FLHTC Electra Glide Classic	1994-2005
Harley Davidson FLHTCI Electra Glide Classic	1994-2006
Harley Davidson FLHTCU Electra Glide Ultra Classic	1994-1997
Harley Davidson FLHTCUI Electra Glide Ultra Classic	1994-2006
Harley Davidson FLHTI Electra Glide Standard	1995-2006
Harley Davidson FLHX Street Glide	2006
Harley Davidson FLSTC Heritage Softail Classic	1994-2006
Harley Davidson FLSTCI Heritage Softail Classic	1994-2006
Harley Davidson FLSTF Fat Boy	1994-2006
Harley Davidson FLSTFI Fat Boy	1994-2006
Harley Davidson FLSTI Heritage Softail	2006
Harley Davidson FLSTN Heritage Softail Special	1994-1996
Harley Davidson FLSTN Softail Deluxe	2005-2006
Harley Davidson FLSTNI Softail Deluxe	1993-2006
Harley Davidson FLSTS Heritage Springer	1997-2003
Harley Davidson FLSTSC Softail Springer Classic	2005-2006
Harley Davidson FLSTSCI Softail Springer Classic	2005-2006
Harley Davidson FLSTSI Heritage Springer	1997-2003
Harley Davidson FLTCU Tour Glide Ultra Classic	1994-1995
Harley Davidson FLTCUI Tour Glide Ultra Classic	1994-1996
Harley Davidson FLTR Road Glide	1998-2002
Harley Davidson FLTRI Road Glide	1998-2006
Harley Davidson FLTRSEI Screamin Eagle Road Glide	2000
Harley Davidson FLTRSEI2 Screamin Eagle Road Glide 2	2001
Harley Davidson FXD Dyna Super Glide	1995-2005
Harley Davidson FXD35 Super Golden Anniversary	2006
Harley Davidson FXDBI Street Bob	2006
Harley Davidson FXDC Super Glide Custom	2005

◀ **cod. 18446N** - continued

MAKE / MODEL	YEAR
Harley Davidson FXDCI Super Glide Custom	2005-2006
Harley Davidson FXDI Dyna Super Glide	1995-2006
Harley Davidson FXDL Dyna Low Rider	1994-2005
Harley Davidson FXDLI Dyna Low Rider	1994-2006
Harley Davidson FXDS-Conv Dyna Convertible	1994-2000
Harley Davidson FXDWG Dyna Wide Glide	1994-2005
Harley Davidson FXDWG2	2001
Harley Davidson FXDWG3	2002
Harley Davidson FXDWGI Dyna Wide Glide	1994-2006
Harley Davidson FXDX Dyna Super Glide Sport	1999-2005
Harley Davidson FXDXI Dyna Super Glide Sport	2004-2005
Harley Davidson FXDXT Dyna Super Glide T-Sport	2001-2003
Harley Davidson FXLR Low Rider Custom	1994
Harley Davidson FXR Super Glide II	1994
Harley Davidson FXR2	1999
Harley Davidson FXR3	1999
Harley Davidson FXR4	2000
Harley Davidson FXST Softail Standard	1999-2006
Harley Davidson FXSTB Night Train	1999-2006
Harley Davidson FXSTBI Night Train	1999-2006
Harley Davidson FXSTC Softail Custom	1994-1999
Harley Davidson FXSTD Softail Deuce	2000-2006
Harley Davidson FXSTDI Softail Deuce	2000-2006
Harley Davidson FXSTDSE Screamin Eagle Softail Deuce	2003
Harley Davidson FXSTDSE2 Screamin Eagle Softail Deuce 2	2004
Harley Davidson FXSTI Softail Standard	2000-2006
Harley Davidson FXSTS Springer Softail	1994-2006
Harley Davidson FXSTSB Bad Boy	1995-1997
Harley Davidson FXSTSI Springer Softail	1994-2006

◀ **cod. 18477N**

Denso OSGR

1.4kW/12 Volt, CW, 9-Tooth Pinion



MAKE / MODEL	YEAR
Harley Davidson XL1200C Sportster 1200 Custom	1996-2014
Harley Davidson XL1200V Seventy-Two	2012-2014
Harley Davidson XL1200X Forty-Eight	2010-2014
Harley Davidson XL883L SuperLow	2011-2014
Harley Davidson XL883N Iron 883	2009-2014
Harley Davidson XLH Sportster	1981-1990
Harley Davidson XLH Sportster Liberty	1986
Harley Davidson XLH1000	1981-1985
Harley Davidson XLH1100	1986-1987
Harley Davidson XLH1200	1988-1990
Harley Davidson XLH883	1986-1990
Harley Davidson XLH883DLX Sportster 883 Deluxe	1986-1990
Harley Davidson XLH883HUG Sportster 883 Hugger	1987-1990
Harley Davidson XLS Roadster	1981-1985
Harley Davidson XLSA Roadster Anniv.	1982
Harley Davidson XLX 1000	1983-1985
Harley Davidson XLX-61	1983-1985
Harley Davidson XR1000	1983-1985



◀ **cod. 18477NC**
Denso OSGR
1.4kW/12 Volt, CW, 9-Tooth Pinion

MAKE / MODEL	YEAR
Harley Davidson XL Sportster	1993-2003
Harley Davidson XL Sportster Anniv.	1993
Harley Davidson XL Sportster Deluxe	1993-1995
Harley Davidson XL Sportster Hugger	1993-2002
Harley Davidson XL1200C Sportster 1200 Custom	2014
Harley Davidson XL1200L Sportster 1200 Low	2006-2011
Harley Davidson XL1200N Sportster 1200 Nightster	2007-2012
Harley Davidson XL1200R Sportster 1200 Roadster	2004-2008
Harley Davidson XL1200S Sportster 1200 Sport	1996-2003
Harley Davidson XL1200V Seventy-Two	2014
Harley Davidson XL1200X Forty-Eight	2014
Harley Davidson XL50 50th Anniversary Sportster	2007
Harley Davidson XL883 Sportster	2004-2008
Harley Davidson XL883C Sportster 883 Custom	1998-2010
Harley Davidson XL883L Sportster 883 Low	2005-2011
Harley Davidson XL883L SuperLow	2011-2014
Harley Davidson XL883N Iron 883	2014
Harley Davidson XL883R Sportster 883 Roadster	2002-2013
Harley Davidson XLC Sportster Custom	2000-2007
Harley Davidson XLH Sportster	1981-1992
Harley Davidson XLH Sportster Liberty	1986
Harley Davidson XLH1000	1981-1985
Harley Davidson XLH1100	1986-1987
Harley Davidson XLH1200	1988-2003
Harley Davidson XLH883	1986-2003
Harley Davidson XLH883DLX Sportster 883 Deluxe	1986-1995
Harley Davidson XLH883HUG Sportster 883 Hugger	1987-2003
Harley Davidson XLL Sportster Low	2005-2007
Harley Davidson XLN Nightster	2007
Harley Davidson XLR Sportster Roadster	2002-2007
Harley Davidson XLS Roadster	1981-1985
Harley Davidson XLS Sportster Sport	2000-2003
Harley Davidson XLSA Roadster Anniv.	1982
Harley Davidson XLX 1000	1983-1985
Harley Davidson XLX-61	1983-1985
Harley Davidson XR1000	1983-1985
Harley Davidson XR1200	2009-2010
Harley Davidson XR1200X	2010-2013



◀ **cod. 18478N**
Denso PMDD
0.8kW/12 Volt, CCW, 9-Tooth Pinion

MAKE / MODEL	YEAR
Harley Davidson VRSCA V-Rod	2002-2006
Harley Davidson VRSCAW V-Rod	2007-2010
Harley Davidson VRSCB V-Rod	2004-2005
Harley Davidson VRSCD Night Rod	2006-2008
Harley Davidson VRSCDX ANN V-Rod Anniversary Edition	2012
Harley Davidson VRSCDX Night Rod Special	2007-2014

◀ **cod. 18478N** - continued

MAKE / MODEL	YEAR
Harley Davidson VRSCF V-Rod Muscle	2009-2014
Harley Davidson VRSCR Street Rod	2006-2007
Harley Davidson VRSCSE Screamin Eagle V-Rod	2005
Harley Davidson VRSCSE2 Screamin Eagle V-Rod 2	2006
Harley Davidson VRSCX V-Rod	2007
Harley Davidson VRXSE Screamin Eagle Destroyer	2006



◀ **cod. 18478NC**

Denso PMDD
0.8kW/12 Volt, CCW, 9-Tooth Pinion

MAKE / MODEL	YEAR
Harley Davidson VRSCA V-Rod	2002-2006
Harley Davidson VRSCAW V-Rod	2007-2010
Harley Davidson VRSCB V-Rod	2004-2005
Harley Davidson VRSCD Night Rod	2006-2008
Harley Davidson VRSCDX ANN V-Rod Anniversary Edition	2012
Harley Davidson VRSCDX Night Rod Special	2007-2014
Harley Davidson VRSCF V-Rod Muscle	2009-2014
Harley Davidson VRSCR Street Rod	2006-2007
Harley Davidson VRSCSE Screamin Eagle V-Rod	2005
Harley Davidson VRSCSE2 Screamin Eagle V-Rod 2	2006
Harley Davidson VRSCX V-Rod	2007
Harley Davidson VRXSE Screamin Eagle Destroyer	2006



◀ **cod. 18600N**

Mitsuba PMDD
0.6kW/12 Volt, CW, 13-Tooth Pinion

MAKE / MODEL	YEAR
Honda GL1100 Gold Wing	1980-1983
Honda GL1100A Gold Wing Aspencade	1982-1983
Honda GL1100I Gold Wing Interstate	1980-1983



◀ **cod. 18611N**

Mitsuba PMDD
12 Volt, CCW, 13-Tooth Pinion

MAKE / MODEL	YEAR
Honda CB250 Nighthawk	1991-2008
Honda CMX250C Rebel	1996-2015



◀ **cod. 18656N**
Mitsuba PMDD
12 Volt, CW, 10-Spline Shaft

MAKE / MODEL	YEAR
Honda PC800 Pacific Coast	1989-1998
Honda VT1100C Shadow	1995-1996
Honda VT1100C Shadow Spirit	1997-2007
Honda VT1100C2 Shadow Sabre	2004-2007



◀ **cod. 18657N**
Mitsuba PMDD
12 Volt, CCW, 9-Tooth Pinion

MAKE / MODEL	YEAR
Honda ST1100	1991-2003
Honda ST1100 ABS	1992-2003



◀ **cod. 18660N**
Mitsuba PMDD
12 Volt, CCW, 10-Spline Shaft

MAKE / MODEL	YEAR
Honda VF700C Magna	1984-1987
Honda VF700S Sabre	1984-1985
Honda VF750C Magna	1988
Honda VF750C V45 Magna	1982-1983
Honda VF750S V45 Sabre	1982-1983



◀ **cod. 18661N**
Mitsuba PMDD
12 Volt, CW, 10-Tooth Spline

MAKE / MODEL	YEAR
Honda VF700F Interceptor	1984-1985
Honda VF750F V45 Interceptor	1983-1984



◀ **cod. 18671N**
Mitsuba PMDD
12 Volt, CCW, 10-Spline Shaft

MAKE / MODEL	YEAR
Honda NX650	1988-1989
Honda XR650L	1993-2015



◀ **cod. 18690N**
Mitsuba PMDD
12 Volt, CW, 9-Tooth Pinion

MAKE / MODEL	YEAR
Kawasaki KL650B Tengai	1990-1991
Kawasaki KLR650	1987-2015



◀ **cod. 18692N**
Mitsuba PMDD
12 Volt, CCW, 9-Tooth Pinion

MAKE / MODEL	YEAR
Kawasaki VN1500A Vulcan 1500	1996-1999
Kawasaki VN1500A Vulcan 88	1987-1995
Kawasaki VN1500B Vulcan 88 SE	1987-1990
Kawasaki VN1500C Vulcan L	1996-1997
Kawasaki VN1500E Vulcan 1500 Classic	1996-2008
Kawasaki VN1500G Vulcan 1500 Nomad	1999-2001
Kawasaki VN1500J/R Vulcan 1500 Drifter	1999-2005



◀ **cod. 18702N**
Mitsuba PMDD
12 Volt, CCW, 9-Tooth Spline

MAKE / MODEL	YEAR
Kawasaki KLF400 Bayou 4x4	1993-1999
Kawasaki KVF400 Prairie 2x4	1998-2002
Kawasaki KVF400 Prairie 4x4	1997-2002



◀ **cod. 18704N**
Mitsuba PMDD
12 Volt, CW, 12-Tooth Pinion

MAKE / MODEL	YEAR
Kawasaki EN450A 454 LTD	1985-1990
Kawasaki EX500	1987-1993
Kawasaki EX500 Ninja 500	1994-1996
Kawasaki EX500 Ninja 500R	1997-2009



◀ **cod. 18715N**
Mitsuba PMDD
12 Volt, 9-Tooth Spline

MAKE / MODEL	YEAR
Kawasaki KL250 Super Sherpa	2000-2010
Kawasaki KLX250S	2006-2007



◀ **cod. 18716N**
Mitsuba PMDD
12 Volt, CCW, 9-Spline Shaft

MAKE / MODEL	YEAR
Kawasaki KLF220 Bayou	1988-2002
Kawasaki KLF250 Bayou	2003-2011



◀ **cod. 18718N**
Mitsuba PMDD
12 Volt, CW, 9-Spline Shaft

MAKE / MODEL	YEAR
Arctic Cat DVX 400	2004-2008
Arctic Cat DVX 400 TS	2006-2007
Kawasaki KFX400	2003-2006
Kawasaki KLX400R	2003
Kawasaki KLX400SR	2003
Suzuki DR-Z400	2000-2004
Suzuki DR-Z400E	2000-2007
Suzuki DR-Z400S	2000-2015
Suzuki DR-Z400SM	2005-2015
Suzuki LT-Z400 QuadSport Z	2003-2009



◀ **cod. 18727N**
Mitsuba PMDD
0.6kW/12 Volt, CW, 31-Spline Shaft

MAKE / MODEL	YEAR
Yamaha XV700 Virago	1984-1987
Yamaha XV750 Virago	1981-1997
Yamaha XV920 Virago	1982-1983
Yamaha XV920M Mid-Virago	1983
Yamaha XV920R Seca	1981-1982



◀ **cod. 18733N**
Mitsuba PMDD
12 Volt, CCW, 9-Tooth Spline

MAKE / MODEL	YEAR
Suzuki GSF1200S Bandit	1997-2006
Suzuki GSX1100G	1991-1993
Suzuki GSX-R1100	1989-1992



◀ **cod. 18734N**
Mitsuba PMDD
12 Volt, CW, 9-Spline Shaft

MAKE / MODEL	YEAR
Yamaha FJ1100	1984-1985
Yamaha FJ1200	1986-1993



◀ **cod. 18737N**
Mitsuba PMDD
12 Volt, CW, 31-Spline Shaft

MAKE / MODEL	YEAR
Yamaha XV1000 Virago	1984-1985
Yamaha XV1100 Virago	1986-1998
Yamaha XV700 Virago	1986-1987
Yamaha XV750 Virago	1990-1997



◀ **cod. 18743N**
Suzuki PMDD
12 Volt, CCW, 9-Tooth Spline

MAKE / MODEL	YEAR
Suzuki GSF400 Bandit	1991-1993
Suzuki GSF600S Bandit	1996-2003
Suzuki GSX600F Katana	1998-2006
Suzuki GSX750F Katana	1998-2006



◀ **cod. 18746N**
Mitsuba PMDD
12 Volt, CW, 22/13-Spline Shaft/Pinion

MAKE / MODEL	YEAR
Yamaha XV1600A Road Star	1999-2003
Yamaha XV1600AS Road Star Midnight	2000
Yamaha XV1600AT Road Star Silverado	1999-2003
Yamaha XV1700AT Road Star Silverado	2006-2007



◀ **cod. 18747N**
Mitsuba PMDD
12 Volt, CCW, 9-Spline Shaft

MAKE / MODEL	YEAR
Suzuki DR250SE	1990-1995
Suzuki DR350S	1990-1993
Suzuki DR350SE	1994-1999
Yamaha TTR225	1999
Yamaha XT225	1992-1999



◀ **cod. 18748N**
Mitsuba PMDD
12 Volt, CW, 13-Tooth Pinion

MAKE / MODEL	YEAR
Yamaha XV1100 Virago	1999
Yamaha XVS1100 V Star 1100 Custom	1999-2009
Yamaha XVS1100A V Star 1100 Classic	2000-2009
Yamaha XVS1100AT V Star 1100 Silverado	2002-2009



◀ **cod. 18749N**
Mitsuba PMDD
12 Volt, CCW, 10-Spline Shaft

MAKE / MODEL	YEAR
Yamaha YJ50 Vino	2001-2004
Yamaha YJ50RA Vino Classic	2002-2005



◀ **cod. 18750N**
Mitsuba PMDD
12 Volt, CW, 9-Spline Shaft

MAKE / MODEL	YEAR
Yamaha VMX1200 V-Max	1985-2000



◀ **cod. 18760N**
Mitsuba PMDD
12 Volt, CW, 12-Tooth Pinion

MAKE / MODEL	YEAR
Aprilia Pegaso 650 Trail	2005-2009
Yamaha YFM660R Raptor	2001-2005



◀ **cod. 18761N**
Mitsuba PMDD
12 Volt, CW, 9-Spline Shaft

MAKE / MODEL	YEAR
Yamaha YFZ450	2004-2013
Yamaha YFZ450 Bill Balance Edition	2006-2007
Yamaha YFZ450 SE	2007-2008



◀ **cod. 18762N**
Mitsuba PMDD
12 Volt, CW, 9-Tooth Pinion

MAKE / MODEL	YEAR
Yamaha TTR250	1999-2006



◀ **cod. 18763N**
Mitsuba PMDD
12 Volt, CCW, 9-SPL

MAKE / MODEL	YEAR
Yamaha FZS600 FZ6	2004-2009
Yamaha YZF-R6	1999-2005
Yamaha YZF-R6S	2006-2009



◀ **cod. 18764N**
Mitsuba PMDD
12 Volt, 9-Tooth Spline

MAKE / MODEL	YEAR
Yamaha FZS1000 FZ1	2001-2005



◀ **cod. 18767N**
Mitsuba PMDD
12 Volt, 12-Tooth Pinion

MAKE / MODEL	YEAR
Yamaha XV1600A Road Star	2003
Yamaha XV1600AS Road Star Midnight	2001-2003
Yamaha XV1700A Road Star	2004-2007
Yamaha XV1700AM Road Star Midnight	2004-2007
Yamaha XV1700AT Road Star Silverado	2004-2005
Yamaha XV1700ATM Road Star Midnight Silverado	2004-2007



◀ **cod. 18768N**
Mitsuba PMDD
12 Volt, CCW, 9-Tooth Spline

MAKE / MODEL	YEAR
Yamaha XV250 Route 66	1988-1990
Yamaha XV250 V Star 250	2008-2015
Yamaha XV250 Virago	1995-2007



◀ **cod. 18769N**
Mitsuba PMDD
12 Volt, CW, 9-Tooth Spline

MAKE / MODEL	YEAR
Yamaha XVZ1300A Royal Star	1996-1998
Yamaha XVZ1300AL Royal Star Boulevard	1999-2001
Yamaha XVZ1300AT Royal Star Tour Classic	1996-2000
Yamaha XVZ1300CT Royal Star Tour Deluxe	1997-2010
Yamaha XVZ1300CTM Royal Star Midnight Tour Deluxe	2006-2007
Yamaha XVZ1300CTS Royal Star Tour Deluxe S	2008-2009
Yamaha XVZ1300TF Royal Star Venture	1999-2009
Yamaha XVZ1300TFM Royal Star Midnight Venture	2002-2007
Yamaha XVZ1300TFS Royal Star Venture S	2009-2013



◀ **cod. 18784N**
Mitsuba PMDD
12 Volt, CW, 9-Spline Shaft

MAKE / MODEL	YEAR
Suzuki GSX-R1100	1993-1998
Suzuki GSX-R600	1992-1993
Suzuki GSX-R750	1993-1995
Suzuki RF600	1994-1996
Suzuki RF900	1994-1997



◀ **cod. 18787N**
Mitsuba PMDD
12 Volt, CW, 9-Tooth Pinion

MAKE / MODEL	YEAR
Suzuki C50 Boulevard	2005-2013
Suzuki C50 Boulevard B.O.S.S.	2014
Suzuki C50 Boulevard SE	2009-2013
Suzuki C50B Boulevard	2005-2008
Suzuki C50C Boulevard	2006-2008
Suzuki C50T Boulevard	2005-2013

◀ cod. 18787N - continued

MAKE / MODEL	YEAR
Suzuki CS0T Boulevard Classic	2012
Suzuki M50 Boulevard	2005-2013
Suzuki M50 Boulevard Limited	2007
Suzuki M50 Boulevard SE	2009
Suzuki M50B Boulevard	2005-2006
Suzuki S50 Boulevard	2005-2009
Suzuki VL800	2013-2015
Suzuki VL800 Intruder Volusia	2001-2004
Suzuki VS700 Intruder	1985-1987
Suzuki VS750GL Intruder	1988-1991
Suzuki VS800GL Intruder	1992-2008
Suzuki VX800	1990-1993
Suzuki VZ800	2013
Suzuki VZ800 Marauder	2005-2008



◀ cod. 18788N

Denso PMDD
0.6kW/12 Volt, CCW, 10-Tooth Spline

MAKE / MODEL	YEAR
Kawasaki ZX900 Ninja ZX-9R	1998-2003
Suzuki GS500	1989-2002
Suzuki GS500F	2004-2009
Suzuki GSX750F Katana	1989-1997
Suzuki GSX-R750	1988-1992



◀ cod. 18791N

Mitsuba PMDD
12 Volt, CCW, 9-Tooth Spline

MAKE / MODEL	YEAR
Suzuki GSX-R600	1997-2000



◀ cod. 18792N

Mitsuba PMDD
12 Volt, CCW, 9-Tooth Spline

MAKE / MODEL	YEAR
Suzuki GSX-R750	1996-1999



◀ **cod. 18798N**
Denso PMDD
12 Volt, CCW, 9-Spline Shaft

MAKE / MODEL	YEAR
Suzuki GSX1300R Hayabusa	1999-2003



◀ **cod. 18814N**
Denso PMDD
12 Volt, CCW, 9-Spline Shaft

MAKE / MODEL	YEAR
Suzuki GSX1300R Hayabusa	1999-2007
Suzuki GSX1300R Hayabusa Limited Edition	2006



◀ **cod. 18820N**
Denso PMDD
12 Volt, CCW, 9-Spline Shaft

MAKE / MODEL	YEAR
Aprilia Pegaso 650	1992-2004
BMW F650	1993-2000
BMW F650 Enduro	1998-2001
BMW F650 Funduro	1993-1997
BMW F650 SE	1999
BMW F650CS	2000-2006
BMW F650CS ABS	2003-2005
BMW F650GS	1999-2012
BMW F650GS ABS	2001-2005
BMW F650GS Dakar	2001-2007
BMW F650GS Dakar ABS	2002-2005
BMW F650GS Dakota	2000-2007
BMW F650ST	1997-1999
BMW F700GS	2011-2014
BMW F800GS	2008-2014
BMW F800GS Adventure	2012-2014
BMW F800GT	2011-2014
BMW F800R	2005-2014
BMW F800S	2006-2008
BMW F800ST	2006-2012
Bombardier DS650	2000-2007
Bombardier DS650 Baja	2001-2004
Bombardier DS650 X	2004-2007
Can-Am DS 650 X	2007



◀ **cod. 18825N**
Mitsuba PMDD
12 Volt, CW, 9-Tooth Spline

MAKE / MODEL	YEAR
Yamaha VMX1200 V-Max	2001-2007



◀ **cod. 18833N**
Mitsuba PMDD
12 Volt, CW, 9-Tooth Spline

MAKE / MODEL	YEAR
Kawasaki ZX600 Ninja ZX6-RR	2003-2006
Kawasaki ZX636 Ninja ZX-6R	2003-2006



◀ **cod. 18836N**
Mitsuba PMDD
12 Volt, 10-Tooth Spline

MAKE / MODEL	YEAR
Kawasaki ZX1000 Ninja ZX-10R	2004-2006



◀ **cod. 18837N**
Mitsuba PMDD
12 Volt, CCW, 9-Tooth Spline

MAKE / MODEL	YEAR
Kawasaki VN2000A Vulcan 2000	2004-2009
Kawasaki VN2000D Vulcan 2000 Limited	2005-2006
Kawasaki VN2000E Vulcan 2000 Classic	2006-2009
Kawasaki VN2000F Vulcan 2000 Classic LT	2006-2010



◀ **cod. 18843N**
Mitsuba PMDD
12 Volt, CW, 9-Tooth Spline

MAKE / MODEL	YEAR
Yamaha CP250 Morphous	2006-2008
Yamaha YP400 Majesty	2005-2012

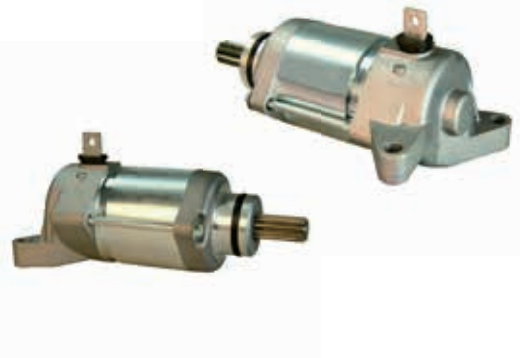

◀ **cod. 18844N**
Mitsuba PMDD
12 Volt, CW, 9-Tooth Spline

MAKE / MODEL	YEAR
Yamaha WR450F	2003-2006



◀ **cod. 18845N**
Mitsuba PMDD
12 Volt, CCW, 9-Tooth Spline

MAKE / MODEL	YEAR
Yamaha TT225	1986-1987
Yamaha TTR225	1999-2004
Yamaha XT225	2000-2002



◀ **cod. 18850N**
Mitsuba PMDD
12 Volt, CW, 9-Tooth Pinion

MAKE / MODEL	YEAR
Honda CRF230F	2003-2009



◀ **cod. 18851N**
Mitsuba PMDD
12 Volt, CCW, 9-Spline Shaft

MAKE / MODEL	YEAR
Honda CRF250X	2004-2015



◀ **cod. 18852N**
Mitsuba PMDD
12 Volt, CW, 9-Tooth Spline

MAKE / MODEL	YEAR
Honda CRF450X	2005-2015



◀ **cod. 18859N**
Mitsuba PMDD
12 Volt, CCW, 9-Spline Shaft

MAKE / MODEL	YEAR
Honda FSC600 Silver Wing	2002-2010
Honda FSC600A Silver Wing ABS	2003-2013



◀ **cod. 18886N**
Denso PMDD
0.7kW/ 2 Volt, CW, 9-Tooth Pinion

MAKE / MODEL	YEAR
Suzuki AN400 Burgman	2003-2012
Suzuki AN400 Burgman ABS	2009-2013
Suzuki AN400S Burgman Type S	2003-2006
Suzuki AN650A Burgman ABS	2013



◀ **cod. 18905BN**
Mitsuba PMDD
1.4kW/12 Volt, 10-Tooth Pinion

MAKE / MODEL	YEAR
Harley Davidson FLHR Road King	2007
Harley Davidson FLHRC Road King Classic	2007
Harley Davidson FLHRCl Road King Classic	2007
Harley Davidson FLHRI Road King	2007
Harley Davidson FLHRS Road King Custom	2007
Harley Davidson FLHRSE3 Screamin Eagle Road King	2007
Harley Davidson FLHRSE4 Screamin Eagle Road King	2008
Harley Davidson FLHRSE5 CVO Road King	2013
Harley Davidson FLHT Electra Glide Standard	2007
Harley Davidson FLHTC Electra Glide Classic	2007

◀ **cod. 18905BN** - continued

MAKE / MODEL	YEAR
Harley Davidson FLHTCI Electra Glide Classic	2007
Harley Davidson FLHTCUSE2 Screamin Eagle Ultra Classic Electra Gli	2007
Harley Davidson FLHTCUSE3 Screamin Eagle Ultra Classic Electra Gli	2008
Harley Davidson FLHTCUSE4 CVO Ultra Classic Electra Glide	2009
Harley Davidson FLHTCUSE5 CVO Ultra Classic Electra Glide	2010
Harley Davidson FLHTCUSE6 CVO Ultra Classic Electra Glide	2011
Harley Davidson FLHTCUSE7 CVO Ultra Classic Electra Glide	2012
Harley Davidson FLHTCUSE8 CVO Ultra Classic Electra Glide	2013
Harley Davidson FLHTI Electra Glide Standard	2007
Harley Davidson FLHX Street Glide	2007
Harley Davidson FLHXSE CVO Street Glide	2010
Harley Davidson FLHXSE2 CVO Street Glide	2011-2012
Harley Davidson FLHXSE3 CVO Street Glide	2012
Harley Davidson FLSTC Heritage Softail Classic	2007
Harley Davidson FLSTCI Heritage Softail Classic	2007
Harley Davidson FLSTF Fat Boy	2007-2013
Harley Davidson FLSTN Softail Deluxe	2007-2013
Harley Davidson FLSTSC Softail Springer Classic	2007
Harley Davidson FLSTSE CVO Softail Convertible	2010
Harley Davidson FLSTSE2 CVO Softail Convertible	2011-2012
Harley Davidson FLSTSE3 CVO Softail Convertible	2012
Harley Davidson FLTR Road Glide	2007
Harley Davidson FLTRSE3 CVO Road Glide	2009
Harley Davidson FLTRUSE CVO Road Glide Ultra	2011
Harley Davidson FXD Dyna Super Glide	2007
Harley Davidson FXDFSE CVO Dyna Fat Bob	2009
Harley Davidson FXDFSE2 CVO Dyna Fat Bob	2010
Harley Davidson FXDL Dyna Low Rider	2007
Harley Davidson FXDSE Screamin Eagle Dyna	2007
Harley Davidson FXDSE2 Screamin Eagle Dyna	2008
Harley Davidson FXDWG Dyna Wide Glide	2007
Harley Davidson FXSBSE CVO Breakout	2013
Harley Davidson FXST Softail Standard	2007
Harley Davidson FXSTB Night Train	2007
Harley Davidson FXSTC Softail Custom	2007
Harley Davidson FXSTD Softail Deuce	2007
Harley Davidson FXSTSSE Screamin Eagle Softail Springer	2007
Harley Davidson FXSTSSE2 Screamin Eagle Softail Springer	2008
Harley Davidson FXSTSSE3 CVO Softail Springer	2009



◀ **cod. 18905CN**
Denso OSGR
1.4kW/12 Volt, 10-Tooth Pinion, Chrome

MAKE / MODEL	YEAR
Harley Davidson FLHR Road King	2007
Harley Davidson FLHRC Road King Classic	2007
Harley Davidson FLHRCI Road King Classic	2007
Harley Davidson FLHRI Road King	2007
Harley Davidson FLHRS Road King Custom	2007
Harley Davidson FLHRSE3 Screamin Eagle Road King	2007
Harley Davidson FLHRSE4 Screamin Eagle Road King	2008

◀ cod. 18905CN - continued

MAKE / MODEL	YEAR
Harley Davidson FLHT Electra Glide Standard	2007
Harley Davidson FLHTC Electra Glide Classic	2007
Harley Davidson FLHTCI Electra Glide Classic	2007
Harley Davidson FLHTCUSE2 Screamin Eagle Ultra Classic Electra Gli	2007
Harley Davidson FLHTCUSE3 Screamin Eagle Ultra Classic Electra Gli	2008
Harley Davidson FLHTCUSE4 CVO Ultra Classic Electra Glide	2009
Harley Davidson FLHTCUSE5 CVO Ultra Classic Electra Glide	2010
Harley Davidson FLHTCUSE6 CVO Ultra Classic Electra Glide	2011
Harley Davidson FLHTCUSE7 CVO Ultra Classic Electra Glide	2012
Harley Davidson FLHTCUSE8 CVO Ultra Classic Electra Glide	2013
Harley Davidson FLHTI Electra Glide Standard	2007
Harley Davidson FLHX Street Glide	2007
Harley Davidson FLHXSE CVO Street Glide	2010
Harley Davidson FLHXSE2 CVO Street Glide	2011-2012
Harley Davidson FLHXSE3 CVO Street Glide	2012
Harley Davidson FLSTC Heritage Softail Classic	2007
Harley Davidson FLSTCI Heritage Softail Classic	2007
Harley Davidson FLSTF Fat Boy	2007-2013
Harley Davidson FLSTN Softail Deluxe	2007-2013
Harley Davidson FLSTSC Softail Springer Classic	2007
Harley Davidson FLTSE CVO Softail Convertible	2010
Harley Davidson FLTSE2 CVO Softail Convertible	2011-2012
Harley Davidson FLTSE3 CVO Softail Convertible	2012
Harley Davidson FLTR Road Glide	2007
Harley Davidson FLTRSE3 CVO Road Glide	2009
Harley Davidson FLTRUSE CVO Road Glide Ultra	2011
Harley Davidson FXD Dyna Super Glide	2007
Harley Davidson FXDFSE CVO Dyna Fat Bob	2009
Harley Davidson FXDFSE2 CVO Dyna Fat Bob	2010
Harley Davidson FXDL Dyna Low Rider	2007
Harley Davidson FXDSE Screamin Eagle Dyna	2007
Harley Davidson FXDSE2 Screamin Eagle Dyna	2008
Harley Davidson FXDWG Dyna Wide Glide	2007
Harley Davidson FXST Softail Standard	2007
Harley Davidson FXSTB Night Train	2007
Harley Davidson FXSTC Softail Custom	2007
Harley Davidson FXSTD Softail Deuce	2007
Harley Davidson FXSTSSE Screamin Eagle Softail Springer	2007
Harley Davidson FXSTSSE2 Screamin Eagle Softail Springer	2008
Harley Davidson FXSTSSE3 CVO Softail Springer	2009

◀ cod. 18915N

Valeo PMGR
1.2kW/12 Volt, CW, 9-Tooth Pinion

MAKE / MODEL	YEAR
BMW R100	1976-1984
BMW R100/7	1976-1978
BMW R100CS	1980-1984
BMW R100GS	1987-1995
BMW R100GS Paris-Dakar	1987-1995
BMW R100R	1991-1995



◀ **cod. 18915N** - continued

MAKE / MODEL	YEAR
BMW R100R Mystic	1994-1995
BMW R100RS	1976-1993
BMW R100RT	1978-1995
BMW R100RT Classic	1995-1996
BMW R100S	1976-1980
BMW R100T	1978-1984
BMW R45	1978-1985
BMW R45N	1978-1985
BMW R45T	1985-1980
BMW R45TN	1985-1980
BMW R50/5	1969-1973
BMW R60/6	1973-1976
BMW R60/7	1976-1980
BMW R65	1978-1987
BMW R65LS	1981-1985
BMW R65T	1981-1985
BMW R75/5	1969-1980
BMW R75/6	1974-1976
BMW R75/7	1976-1977
BMW R80	1984-1995
BMW R80/7	1976-1980
BMW R80G/S	1980-1996
BMW R80R	1991-1994
BMW R80RT	1982-1995
BMW R80ST	1982-1984
BMW R90/6	1973-1976
BMW R90S	1973-1976



◀ **cod. 19091N**
Denso PMDD
12 Volt, CCW, 9-Tooth Pinion

MAKE / MODEL	YEAR
KTM 250 XC	2009-2014
KTM 250 XC-W	2008-2014
KTM 300 XC	2008-2014
KTM 300 XC-W	2008-2014



◀ **cod. 19162N**
Mitsubishi PMGR
1.2kW/12 Volt, CW, 8-Tooth Pinion

MAKE / MODEL	YEAR
Bobcat 2200S (Diesel)	2004-2006
Husqvarna HUV-4421-DXP	2006-2010



◀ **cod. 19200N**
Mitsuba PMDD
12 Volt, CW, 9-Tooth Pinion

MAKE / MODEL	YEAR
Yamaha YFZ450R	2009-2015
Yamaha YFZ450R SE	2009-2015
Yamaha YFZ450X	2011-2010
Yamaha YFZ450X Bill Balance	2010
Yamaha YFZ450X SE	2011



◀ **cod. 19228N**
China (Made) PMDD
12 Volt, CW, 9-Tooth Spline

MAKE / MODEL	YEAR
Kymco MXU500	2006-2009
Kymco MXU500 4x4 IRS	2012-2014
Kymco MXU500 IRS	2011-2010
Kymco MXU500i 4x4 IRS	2012-2014
Kymco MXU500i 4x4 IRS LE	2012-2014
Kymco UXV 500 4X4 SE	2011
Kymco UXV 500i 4X4	2012-2014
Kymco UXV 500i HE	2014
Kymco UXV 500i LE	2012-2014
Kymco UXV 500i SE	2012-2013
Kymco UXV 500i SP	2011-2013
Kymco UXV 500i TURF	2014
Kymco Xciting 500	2005-2008
Kymco Xciting 500Ri	2009-2012
Kymco Xciting 500Ri ABS	2009-2014



◀ **cod. 19571N**
China (Made) PMDD
12 Volt, CW, 9-Tooth Pinion

MAKE / MODEL	YEAR
Aprilia Scarabeo 125	1999-2005
Aprilia Scarabeo 150	1999-2004
BMW C1 125	1999-2003



◀ **cod. 19587N**
China (Made) PMDD
12 Volt, CCW, 9-Tooth Pinion

MAKE / MODEL	YEAR
China Built ATV's & Scooters	All
Yamaha YBR125	All



◀ **cod. 19588N**
Mitsuba PMDD
12 Volt, CCW, 9-Tooth Pinion

MAKE / MODEL	YEAR
Aprilia Atlantic 125	2003-2013
Aprilia Atlantic 200	2003-2006
Aprilia Mojito 125	2003-2010
Aprilia Mojito 150	2003-2007
Aprilia Scarabeo 125 Euro	2003-2007
Aprilia Scarabeo 200GT	2003-2006
Aprilia Sportcity 125 Euro	2004-2009
Aprilia Sportcity Cube 200	2008-2010
Aprilia Sportcity Cube 200 Euro	2004-2009
Aprilia Sportcity One 125	2008-2010
Aprilia SR 125	2012-2013
Benelli Adiva 125	2001-2006
Benelli Adiva 150	2001-2006



◀ **cod. 19595N**
Chinese PMDD
12 Volt, CCW, 11-Tooth Pinion

MAKE / MODEL	YEAR
Aprilia Mojito Custom 50	2004-2008
Aprilia Scarabeo 50 2T	2005-2013
Aprilia Scarabeo 50 2T E2	2006-2008
Aprilia Sportcity One 50	2008-2013
Aprilia SR 50	2003-2008
Aprilia SR 50 IE	2003-2008
Aprilia SR 50 R Factory	2005-2013
Aprilia SR50R Factory	2006-2013
Honda SA50 Elite LX	1988-1990
Honda SA50 Elite SR	1988-1993
Kymco CX50	1993-1997
Kymco DJ50	1993-2006
Kymco DJW 50 World	1995-1997
Kymco DJX50	1991-1992
Kymco K12 Sport 50	1995-2006
Kymco KB50	1995-2000



◀ **cod. 19597N**
Chinese PMDD
12 Volt, CCW, 10-Tooth Pinion

MAKE / MODEL	YEAR
GMI GMI 101	2004-2008
GMI GMI 102	2004-2008
GMI GMI 102P	2004-2008
GMI GMI 103	2004-2008
GMI GMI 104	2004-2008
GMI GMI 106	2004-2008
GMI GMI 106I	2004-2008

◀ cod. 19597N - continued

MAKE / MODEL	YEAR
GMI GMI 107	2004-2008
GMI GMI 107XP	2004-2008
GMI GMI 108	2004-2008
GMI GMI 109	2004-2008
GMI GMI 110	2005-2008
GMI GMI 111	2004-2008
GMI GMI 301	2004-2008
GMI GMI 304	2004-2008
Kymco Mongoose 50	2004-2009
Kymco Mongoose 70	2007-2010
Kymco Sting 50	2009-2011
Kymco Super 9	2002-2009
Kymco Vitality 50	2004-2007
Kymco Yup 50	2002-2003



◀ cod. 19620N Mitsuba PMDD 12 Volt, CCW, 9-Tooth Pinion

MAKE / MODEL	YEAR
KTM 400 EXC	2000-2006
KTM 400 MXC	2001-2002
KTM 400 SX	2000-2002
KTM 400 XC-W	2007-2010
KTM 450 EXC	2003-2005
KTM 450 EXC-R	2008-2011
KTM 450 MXC	2003-2005
KTM 450 SMR	2005-2006
KTM 450 SMS	2004
KTM 450 SX-F	2003-2006
KTM 450 SXS	2003-2006
KTM 450 XC	2008-2010
KTM 450 XC-F	2006
KTM 450 XC-W	2006-2011
KTM 520 EXC	2000-2002
KTM 520 MXC	2000-2002
KTM 520 SX	2000-2002
KTM 525 EXC	2003-2006
KTM 525 EXC-G	2006-2007
KTM 525 MXC	2003-2005
KTM 525 SMR	2004-2006
KTM 525 SX	2003-2006
KTM 525 XC	2008-2010
KTM 525 XC-G	2006-2007
KTM 525 XC-W	2007
KTM 530 EXC-R	2008-2011
KTM 530 XC-W	2008-2011
KTM 540 SXC	2000-2006
Polaris Outlaw 450 MXR	2008-2010
Polaris Outlaw 525 IRS	2007-2011
Polaris Outlaw 525 S	2008-2010



◀ **cod. 19628N**
China (Made) PMGR
12 Volt, CW, 9-Tooth Pinion

MAKE / MODEL	YEAR
Aprilia Classic 125	2000-2005
Aprilia Extreme 125	2001-2005
Aprilia Replica 125	2001-2005
Aprilia RS 125	1996-2005
Aprilia Tuono 125	2003-2005



◀ **cod. 19633N**
Mitsuba PMDD
12 Volt, CCW, 9-Tooth Pinion

MAKE / MODEL	YEAR
KTM 400 LC4	1998-2001
KTM 400 LSE	1997-1998
KTM 400 RXC	1996-1998
KTM 400 TXC	1998
KTM 620 Comp Limited	1997
KTM 620 Duke	1996-1997
KTM 620 EGS	1994-1997
KTM 620 EGS-E	1997
KTM 620 EXC	1994-1997
KTM 620 LC4 EXC	1994-1997
KTM 620 LC4 SX	1997-1998
KTM 620 RXC	1995-1998
KTM 620 SC	1994-2001
KTM 620 Super Moto	1998-2001
KTM 620 SX	1996-1999
KTM 620 SXC	1997
KTM 620 TXC	1998
KTM 625 SMC	2004-2006
KTM 625 SXC	2003-2004
KTM 640 Adventure	1998-2008
KTM 640 Duke	1998
KTM 640 Duke II	1999-2006
KTM 640 Enduro	1999-2002
KTM 640 Supermoto	1999-2005
KTM 660 Rally	2000-2006
KTM 660 SMC	2002-2006
KTM 660 SMS	2004



◀ **cod. 19639N**
Mitsuba PMDD
12 Volt, CW, 9-Tooth Pinion

MAKE / MODEL	YEAR
Yamaha XT250	2008-2015
Yamaha YFM250 Raptor	2008-2013
Yamaha YFM250 Raptor SE	2008
Yamaha YFM250 Raptor SE Custom	2008
Yamaha YFM250R Raptor	2011



◀ **cod. 19643N**
Mitsuba PMDD
12 Volt, CW, 10-Tooth Pinion

MAKE / MODEL	YEAR
Honda NSA700 DN-01	2009
Honda NT700V	2011-2010
Honda NT700VA ABS	2011-2010
Honda VT750C Shadow Aero	2008-2015
Honda VT750C2 Shadow Spirit	2007-2015
Honda VT750C2 Shadow Spirit ABS	2011-2013
Honda VT750C2B Shadow Phantom	2012-2015
Honda VT750CA Shadow Aero ABS	2012-2014
Honda VT750RS Shadow RS	2013



◀ **cod. 19646N**
Denso PMDD
12 Volt, CW, 9-Tooth Pinion

MAKE / MODEL	YEAR
BMW K1200GT	2005-2008
BMW K1200R	2004-2008
BMW K1200R Sport	2005-2008
BMW K1200S	2003-2008
BMW K1300GT	2007-2010
BMW K1300R	2007-2012
BMW K1300S	2007-2015
BMW K1600GT	2010-2015
BMW K1600GTL	2010-2015
BMW K1600GTL EXCL	2011-2013



◀ **cod. 19876N**
Denso PMDD
0.7kW/12 Volt, CCW, 15-Tooth Pinion

MAKE / MODEL	YEAR
Ducati 748	2000-2003
Ducati 749	2003-2006
Ducati 750	1999-2002
Ducati 800	2003-2004
Ducati 900	1997-2002
Ducati 996	2002
Ducati 999	2003-2006
Ducati 1000	2003-2005
Ducati 1098	2007-2008
Ducati 1000DS	2005-2006
Ducati 1098 S	2007-2008
Ducati 1098 S Tricolore	2007

cod. 19876N - continued

MAKE / MODEL	YEAR
Ducati 620 Sport	2003
Ducati 748 Monoposto	2001-2002
Ducati 748R	2000-2002
Ducati 748R Biposto	2002
Ducati 748S	2000-2002
Ducati 748S Monoposto	2001-2002
Ducati 749 Dark	2004-2006
Ducati 749R	2004-2006
Ducati 749S	2003-2006
Ducati 750 Sport	2001-2002
Ducati 800 Sport	2003
Ducati 900 Sport	2002
Ducati 916 SP	1995
Ducati 916 SPS	1997-1998
Ducati 996 Biposto	2001
Ducati 996 Monoposto	2001
Ducati 996 SPS	1999-2000
Ducati 996R	2001
Ducati 996S	2001-2003
Ducati 996S Monoposto	2001
Ducati 998 Biposto	2002-2003
Ducati 998 F Edition Biposto	2004
Ducati 998 F Edition Monoposto	2004
Ducati 998 Matrix	2004
Ducati 998 Monoposto	2002-2004
Ducati 998R	2002
Ducati 998S	2002
Ducati 998S Bayliss	2002
Ducati 998S Bostrom	2002
Ducati 998S Monoposto	2002
Ducati 999R	2003-2006
Ducati 999R FILA	2003-2004
Ducati 999R Xerox	2006
Ducati 999S	2003-2006
Ducati GT1000	2007-2010
Ducati GT1000 Touring	2009
Ducati MH900e	2001-2002
Ducati Monster 1000	2004-2005
Ducati Monster 1000 Dark	2003
Ducati Monster 1000s	2003-2005
Ducati Monster 400	2001-2005
Ducati Monster 400 Dark	2002-2004
Ducati Monster 400 Metallic	2001
Ducati Monster 400s	2003
Ducati Monster 600	2000-2001
Ducati Monster 600 Dark	2001
Ducati Monster 600 Metallic	2001
Ducati Monster 620	2002-2006
Ducati Monster 620 Capirex	2004
Ducati Monster 620 Dark	2005-2006
Ducati Monster 620 Matrix	2004
Ducati Monster 620s	2002-2003
Ducati Monster 695	2007-2008
Ducati Monster 696	2008-2009

◀ cod. **19876N** - continued

MAKE / MODEL	YEAR
Ducati Monster 750	2000-2002
Ducati Monster 750 Dark	2001-2002
Ducati Monster 750 Metallic	2001-2002
Ducati Monster 800	2004
Ducati Monster 800 Dark	2003
Ducati Monster 800s	2003
Ducati Monster 900	2000-2002
Ducati Monster 900 Cromo	2001
Ducati Monster 900 Dark	2001-2002
Ducati Monster 900 Metallic	2001
Ducati Monster 900s	2000-2001
Ducati Monster S2R	2005-2006
Ducati Monster S2R 1000	2006-2008
Ducati Monster S2R 800	2007
Ducati Monster S2R Dark	2005-2006
Ducati Monster S4	2001-2002
Ducati Monster S4 Fogarty	2002
Ducati Monster S4R	2003-2007
Ducati Monster S4R Testastretta	2007-2008
Ducati Monster S4Rs	2006
Ducati Monster S4Rs Testastretta	2006-2008
Ducati Monster S4Rs Tricolore	2008
Ducati Multistrada 1000	2003-2005
Ducati Multistrada 1000 DS	2005-2006
Ducati Multistrada 1000s DS	2005-2006
Ducati Multistrada 1100	2007-2008
Ducati Multistrada 1100 S	2007-2009
Ducati Multistrada 620	2005-2006
Ducati Multistrada 620 Dark	2005-2006
Ducati PaulSmart 1000 LE	2005-2006
Ducati Sport 1000	2006
Ducati Sport 1000 Biposto	2007-2008
Ducati Sport 1000 Monoposto	2007
Ducati Sport 1000s	2007-2008
Ducati ST2	2000-2003
Ducati ST3	2004-2007
Ducati ST3S ABS	2006-2007
Ducati ST4	2000-2004
Ducati ST4S	2001-2005
Ducati ST4S ABS	2005



◀ cod. **37009N**
China (Made) PMDD
12 Volt, CW

MAKE / MODEL	YEAR
Kymco Bet & Win 250	2002-2004
Kymco Grandvista 250	2004-2011
Kymco People 250	2004-2007
Kymco People S 250	2006-2011
Kymco Xciting 250	2006-2011



◀ **cod. 37010N**

China (Made) PMDD
12 Volt, CCW

MAKE / MODEL	YEAR
Kymco Cobra 50	2001-2003
Kymco Cobra Cross	2002-2003
Kymco Compagno 50i	2011-2013
Kymco People 50	2001-2012



◀ **cod. 37033N**

China (Made) PMDD
12 Volt, CCW, 9-Tooth Pinion

MAKE / MODEL	YEAR
Aprilia Habana 125	1999-2003
Aprilia Mojito 125	1993-2003
Piaggio Hexagon LX4 125	1999-2003
Piaggio Liberty 125	1999-2003
Piaggio Sfera 125	1999-2003
Piaggio Vespa ET4	1999-2003



◀ **cod. 37034N**

China (Made) PMDD
12 Volt, CCW, 11-Tooth Pinion

MAKE / MODEL	YEAR
Piaggio APE 50	All
Piaggio PK125	All
Piaggio PK50	All



◀ **cod. 37036N**

China (Made) PMDD
12 Volt, CCW, 10-Tooth Pinion

MAKE / MODEL	YEAR
Aprilia Habana 50	1999-2003
Aprilia Mojito Custom 50	1999-2004
Aprilia Mojito Retro 50	1999-2003
Aprilia Scarabeo 50 Ditech	2001-2006
Aprilia SR 50 Ditech	2002-2004
Aprilia SR 50 R Factory	2005-2013
Atala Byte AT 1050	1997-1998
Atala Hacker AT12.50	1998-1999
Atala Hacker LC 50	1997-1998
Atala Hacker Racing 50	1997-1999
Atala Skeggia 50	1998-1999
Benelli 491 RR SBK	2003-2004
Benelli 491 Sport	2003-2004
Benelli 491 ST Rage	2003-2004
Benelli Naked Morini 50	2003
Suzuki AP50	1996-1997
Suzuki TR50 Street Magic	1998-1999



◀ **cod. 37039N**

Mitsuba PMDD
12 Volt

MAKE / MODEL	YEAR
Yamaha XP500 TMAX	2009-2015



◀ **cod. 37042N**

China (Made) PMDD
12 Volt

MAKE / MODEL	YEAR
Sym GTS 125	2006-2008
Sym Joy-Max 300	2006-2008
Sym Voyager 125	2007-2008



◀ **cod. 37044N**

China (Made) PMDD
12 Volt, CCW, 9-Tooth Pinion

MAKE / MODEL	YEAR
Honda SH 100	2000-2008
Honda Shadow 50	2010-2013
Honda Shadow 90	2010-2013



◀ **cod. 37045N**

China (Made) PMDD
12 Volt

MAKE / MODEL	YEAR
Kymco Eruo 2	2001-2009
Kymco Eruo 3	2001-2009
Kymco Gran Dink 125	2001-2009
Kymco Gran Dink 150	2001-2009



◀ **cod. 37046N**

Mitsuba PMDD
12 Volt, CW, 9-Tooth Pinion

MAKE / MODEL	YEAR
Honda SH 125	2001-2008
Honda SH 150	2001-2008



- ◀ cod. **K060040**
Serie paraoli Vespa 50-125 Primavera-125 ET3
- ◀ cod. **K06004A**
Serie paraoli originali Vespa 50-125 Primavera 125 ET3
- ◀ cod. **K060050**
Serie paraoli Piaggio Vespa 125PX-150 PX-T5
- ◀ cod. **K060070**
Serie paraoli Vespa 125 PX Arcobaleno
- ◀ cod. **K060100**
Serie paraoli banco Vespa 50 PK-XL Ape 50
- ◀ cod. **K070050**
Serie paraoli scooter 50 cc Minarelli/Yamaha (6 pezzi)
- ◀ cod. **K070060**
Serie paraoli (AM 345/6)
- ◀ cod. **K070070**
Serie paraoli banco scooter 50 cc Minarelli/Yamaha
- ◀ cod. **K070080**
Serie paraoli banco scooter 50 cc Piaggio/Gilera
- ◀ cod. **K070090**
Serie paraoli banco AM 345/6
- ◀ cod. **K070100**
Serie paraoli banco scooter Piaggio Skipper 125/150 cc 2T
- ◀ cod. **K070110**
Serie paraoli banco Piaggio Beverly 125/200 4T
- ◀ cod. **K070120**
Serie paraoli banco Aprilia Scarabeo 125/150
- ◀ cod. **K070130**
Serie paraoli banco Honda Forsight 250 cc



- ◀ cod. **H102670**
Aprilia: 125/150 cc (motori Rotax)
 misure: 10x26x7
- ◀ cod. **H202840**
Mbk: Booster 100 cc, Skyliner 125 cc - **Yamaha:** Majesty 125cc
 misure: 20x28x4
- ◀ cod. **H203050**
Kymco: People 125/150 cc
 misure: 19,8x30x5 in viton
- ◀ cod. **H203260**
Kymco: People 125/150 cc
 misure: 20x32x6
- ◀ cod. **H223270**
Mbk: Skyliner 125cc - **Yamaha:** Majesty 125cc
 misure: 22x32x7
- ◀ cod. **H254080**
Kymco: People 125/150 cc
 misure: 25x40x8
- ◀ cod. **H255270**
Aprilia: 125/150 cc (motori Rotax)
 misure: 25x52x7 in viton
- ◀ cod. **H274170**
Honda: 125/150 cc
 misure: 27,4x41x7
- ◀ cod. **H274270**
Kymco: People 125/150 cc
 misure: 27x42x7
- ◀ cod. **H284080**
Honda: 250 cc
 misure: 27,9x40x8
- ◀ cod. **H294370**
Honda: 125/150 cc
 misure: 29,4x43x7
- ◀ cod. **H305270**
Aprilia: 125/150 cc (motori Rotax)
 misure: 30x52x7
- ◀ cod. **H345260**
Suzuki: Burgman 250/400 cc, Epicuro 125/150 cc
 misure: 34x52x5,8 in viton
- ◀ cod. **H372560**
Suzuki: Burgman 400 cc
 misure: 37x25x6
- ◀ cod. **H385270**
Suzuki: Burgman 250/400 cc
 misure: 38x52x7



cod. **PB00900**

Pompa Benzina Yamaha T-Max 500/530 Suzuki Burgman 125/200 cc

APPLICABILITÀ

SUZUKI

UH BURGMAN K7/LO 125 4T 07-10, UH BURGMAN L1 125 4T 11-11, UX SIXTEEN K8/LO 125 4T 08-10, UX SIXTEEN L1 125 4T 11-11, UX SIXTEEN K8/LO 150 4T 08-10, UX SIXTEEN L1 150 4T 11-11, UH BURGMAN K7/LO 200 4T 07-10, UH BURGMAN L1 200 4T 11-12

YAMAHA

NEO'S 4 50 4T-3V 09-15, X-MAX R 125 4T-4V 06-14, X-MAX R ABS 125 4T-4V 11-11, X-MAX RA ABS 125 4T-4V 14-15, X-MAX 250 4T 07-16, X-MAX ABS 250 4T 11-12, X-MAX ABS 250 4T 14-15, X-MAX BLACK 250 4T 09-09, X-MAX SPORT 250 4T 11-12, MAJESTY 400 4T 04-11, MAJESTY ABS 400 4T 07-11, T-MAX 4BS 500 4T 09-11, T-MAX 4BS ABS 500 4T 08-11, T-MAX SVU 500 4T 04-08, T-MAX SVU ABS 500 4T 05-07, T-MAX SVU BLACK MAX 500 4T 06-06, T-MAX SVU BLACK MAX - NIGHT MAX 500 4T 07-07, T-MAX SV 500 4T 11-11, T-MAX SV ABS 500 4T 10-11, T-MAX WHITE MAX 500 4T 10-10, T-MAX 59C 530 4T 12-16, T-MAX 59C ABS 530 4T 12-16, T-MAX 59C SP ABS 530 4T 15-15, T-MAX 59C SP ABS 530 4T 15-16



cod. **PB00901**

Pompa Benzina Honda SH 125/150/300 cc

APPLICABILITÀ

HONDA

SH IE SCOOPY 125 4T-2V 05-12, SH IE SCOOPY 150 4T 05-12, SH IE SCOOPY 300 4T-4V 07-19



cod. **PB00902**

Kit Pompa Benzina Scooter Piaggio 125/250/300 cc

APPLICABILITÀ

APRILIA

SCARABEO LIGHT 250 4T 06-08, SPORT CITY CUBE 250 4T 08-12, SPORT CITY STREET 300 4T-4V 12-12

PIAGGIO

VESPA GTS 4T IE SUPER 125 4T 09-16, BEVERLY IE EU3 250 4T 06-08, BEVERLY SPORT 250 4T 06-08, VESPA GTS IE TOURING 300 4T 11-12, VESPA GTS SUPER 300 4T 08-16, VESPA GTS SUPER SPORT 300 4T 10-13, VESPA GTV 4T 4V IE 300 4T 10-13, VESPA GTV VIA MONTENAPOLEONE 300 4T 10-10



cod. **PB00903**

Kit Pompa Benzina Piaggio 500 cc

APPLICABILITÀ

APRILIA

SCARABEO LIGHT 400 4T 06-08, SCARABEO LIGHT 500 4T 06-08

PIAGGIO

BEVERLY 500 4T 02-06

MALAGUTI

SPIDER MAX GT 500 4T 04-05, SPIDER MAX GT EU3 500 4T 06-06, SPIDER MAX RS 500 4T 08-08



◀ cod. **PB00904**
Pompa Benzina Suzuki Burgman 400 cc K7

APPLICABILITÀ

KAWASAKI NINJA ZX-6R 600 4T 07-16, NINJA ZX-6R 636 4T 13-16,
NINJA ZX-6R ABS 636 4T 13-16

SUZUKI AN BURGMAN K7/LO 400 4T 07-10, AN BURGMAN L1 400
4T 11-11, AN BURGMAN L2 400 4T 12-12, AN BURGMAN
L3 400 4T 13-13, AN BURGMAN L4 400 4T 14-14, AN
BURGMAN L5 400 4T 15-15, AN BURGMAN L6 400 4T
16-16



◀ cod. **PB00905**
Kit Pompa Benzina BMW R1200GS

APPLICABILITÀ

BMW R 1200 GS (K25) 1200 4T 02-09, R 1200 GS ADVENTURE
(K25) 1200 4T 05-13, R RT (K26) 1200 4T 03-14, K GT
(K44) 1300 4T 04-10



◀ cod. **PB00907**
Pompa Benzina Honda SH 125/150 cc ABS '13-'17

APPLICABILITÀ

HONDA SH I ABS 125 4T-2V 13-17, SH I ABS 150 4T-2V 13-17



◀ cod. **PB00908**
Pompa benzina Yamaha T-Max 530 cc dal '17

APPLICABILITÀ

YAMAHA XP530-A T-MAX SX 530 4T 17-19, XP530D-A T-MAX DX 530
4T 17-19, XP530E-A T-MAX 530 4T 17-18



◀ cod. **AA00850**
Tasselli traino Piaggio 125/150/180/200 cc

RIFERIMENTO ORIGINALE

PIAGGIO	4348555
---------	---------



◀ cod. **AA00852**
Tasselli traino Majesty 250 cc



◀ cod. **AA00853**
Serie Tasselli di Traino Suzuki Burgman 125/250/400 cc - Honda 300/400 cc

RIFERIMENTO ORIGINALE

Suzuki	21481-14F00-000
Honda	22011-KAB-000

Honda	22011-MCT-305
-------	---------------



◀ cod. **AA00854**
Serie tasselli di traino Honda SH 125/150 cc fino al 2012

RIFERIMENTO ORIGINALE

Honda	22011-KCW-851
-------	---------------

APPLICABILITÀ

HONDA @ [NES] 125 4T 00-06, DYLAN [SES] 125 4T 02-04, PANTHEON IE [FES] 125 4T-2V 03-05, PS I [PES] 125 4T 06-10, SH 125 4T-2V 01-04, SH IE SCOOOPY 125 4T-2V 05-12, SILVER WING [FES] 125 4T-2V 07-12, @ [NES] 150 4T 00-06, DYLAN [SES] 150 4T 02-04, PANTHEON IE [FES] 150 4T-2V 03-05, PS I [PES] 150 4T 06-10, SH 150 4T-2V 01-04, SH IE SCOOOPY 150 4T 05-12, SILVER WING [FES] 150 4T-2V 07-12



◀ cod. **ML06232**
Molla contrasto variatore grezza carico tipo originale per motori scooter 50 cc Minarelli/Yamaha con campana frizione Ø interno 105 mm



◀ cod. **PL04055**
Puleggia fissa anteriore per motori scooter 50 cc Minarelli/Yamaha



◀ cod. **PL04056**

Puleggia fissa anteriore per motori per scooter 50 cc Minarelli/Yamaha completa di piastrina



◀ cod. **PL04058**

Puleggia fissa anteriore per motori scooter 50 cc Gilera/Piaggio

RIFERIMENTO ORIGINALE

Piaggio	479561
---------	--------



◀ cod. **PL04059**

Puleggia mobile anteriore per motori scooter 50 cc Piaggio/Gilera con masse Ø 19



◀ cod. **PL04060**

Puleggia fissa anteriore per motori scooter Gilera/Piaggio 125/150 cc Ø esterno 142 mm

RIFERIMENTO ORIGINALE

Piaggio	485118
---------	--------



◀ cod. **PL04061**

Puleggia fissa anteriore per motori scooter 180 cc 4T Piaggio

RIFERIMENTO ORIGINALE

Piaggio	832720
---------	--------



◀ cod. **PL04062**
Puleggia mobile per motori scooter 125/150/180 cc 4T Piaggio

RIFERIMENTO ORIGINALE

Piaggio	CM103901
---------	----------



◀ cod. **PL04063**
Puleggia fissa per motori scooter 50 cc Aprilia D.Tech

RIFERIMENTO ORIGINALE

APRILIA	AP3MEA000620
---------	--------------



◀ cod. **PL04064**
Puleggia mobile completa per motori scooter 50 cc Aprilia D.Tech



◀ cod. **PL04066**
Piattello porta tasselli Majesty 250 cc

RIFERIMENTO ORIGINALE

YAMAHA	1C0E76231000
--------	--------------

YAMAHA	4HC176230000
--------	--------------

RICAMBIO

AA00852	Tasselli traino
---------	-----------------



◀ cod. **PL04067**
Piattello porta tasselli Piaggio 125/150/180/200 cc

RIFERIMENTO ORIGINALE

Piaggio	842204
---------	--------

RICAMBIO

AA00850	Tasselli traino
---------	-----------------

AA00851	Distanziale
---------	-------------

NOVITÀ



- ◀ cod. **PL04072**
Puleggia fissa anteriore completa scooter Piaggio 125/150 cc

RIFERIMENTO ORIGINALE

Piaggio	8456075
---------	---------

NOVITÀ



- ◀ cod. **PL04073**
Puleggia fissa anteriore Honda SH 125/150 cc fino al 2012

RIFERIMENTO ORIGINALE

Honda	22102-KGF-910
-------	---------------

NOVITÀ



- ◀ cod. **PL04074**
Puleggia fissa anteriore Kymco Agility 125/150/200 cc

RIFERIMENTO ORIGINALE

KYMCO	00126115	KYMCO	22102KUDU220
-------	----------	-------	--------------

NOVITÀ



- ◀ cod. **PL04075**
Puleggia fissa anteriore Minarelli/Yamaha YP 250/270 cc



◀ **cod. RD00001**
Regolatore **Ducati** per Enduro 50 cc Malaguti/Yamaha

RIFERIMENTO ORIGINALE

Malaguti	02602100	Yamaha	104H35980000
----------	----------	--------	--------------

APPLICABILITÀ

MALAGUTI CNK DRAGON 50 2T 05-07, XSM 50 2T 03-03, XTM 50 2T 03-03
YAMAHA DT R 50 2T 03-06, DT RSM 50 2T 03-05, DT X 50 2T 06-06



◀ **cod. RE00004**
Regolatore per scooter 500 cc Piaggio

RIFERIMENTO ORIGINALE

Piaggio	639110	Gilera	639110
Aprilia	639110	Derbi	639110

APPLICABILITÀ

APRILIA SR MAX 125 4T 11-14, ATLANTIC EU3 250 4T 06-08, SCARABEO LIGHT 250 4T 06-08, SPORT CITY CUBE 250 4T 08-12, SPORT CITY EU3 250 4T 06-08, SCARABEO LIGHT 300 4T 09-10, SPORT CITY STREET 300 4T-4V 12-12, SR MAX 300 4T 11-14, ATLANTIC SPRINT 400 4T 05-08, SCARABEO LIGHT 400 4T 06-08, ATLANTIC 500 4T 01-04, ATLANTIC SPRINT 500 4T 05-08, SCARABEO 500 4T 03-06, SCARABEO LIGHT 500 4T 06-08
DERBI GP1 LOW SEAT EU3 250 4T 07-08, RAMBLA 250 4T 08-09, RAMBLA EU3 2VER 250 4T 08-08, RAMBLA 300 4T 10-11
GILERA NEXUS IE EU3 125 4T 08-10, NEXUS EU3 250 4T 06-07, NEXUS SP EU3 250 4T 06-07, NEXUS EU3 300 4T 08-11, FUOCO IE EU3 500 4T 07-13, NEXUS 500 4T 03-05, NEXUS EU3 500 4T 06-11, NEXUS SP EU3 500 4T 06-07
PIAGGIO MP3 IBRIDO 125 4T 09-10, MP3 IE 125 4T 08-09, BEVERLY CRUISER 250 4T 07-09, BEVERLY IE EU3 250 4T 06-08, BEVERLY SPORT 250 4T 06-08, BEVERLY TOURER EU3 250 4T 07-09, CARNABY 250 4T 08-09, MP3 250 4T 06-08, MP3 LT 250 4T 08-09, MP3 MIC 250 4T 08-09, VESPA GT 60 EU3 250 4T 06-07, VESPA GTS 250 4T 05-16, VESPA GTS ABS 250 4T 05-12, VESPA GTV 250 4T 06-09, VESPA GTV 4T NAVY EU3 250 4T 07-07, X-EVO 250 4T 07-16, X7 EU3 250 4T 08-08, X8 EU3 250 4T 05-08, BEVERLY TOURER EU3 300 4T 09-10, CARNABY CRUISER 300 4T 09-12, VESPA GTS SUPER 300 4T 08-16, BEVERLY EU3 400 4T 06-07, BEVERLY TOURER EU3 400 4T 08-10, MP3 400 4T 07-08, MP3 IE LT TOURING 400 4T 11-11, MP3 IE LT/SPORT 400 4T 08-10, MP3 MIC 400 4T 08-10, MP3 RL TOURING 400 4T 11-11, X-EVO 400 4T 07-11, X8 EU3 400 4T 06-08, BEVERLY 500 4T 02-06, BEVERLY CRUISER 500 4T 07-12, BEVERLY IE EU3 500 4T 06-08, MP3 LT SPORT/BUSINESS 500 4T 11-13, MP3 RL SPORT-BUSINESS 500 4T 11-12, X9 500 4T 01-02, X9 EVOLUTION 500 4T 03-07, X9 EVOLUTION ABS 500 4T 06-07



◀ **cod. RE00008**
Regolatore di tensione per Vespa PX 50-125 cc

RIFERIMENTO ORIGINALE

Piaggio	2308245
---------	---------

APPLICABILITÀ

PIAGGIO APE TM P 50 2T 85-89, VESPA FL 50 2T 90-90, VESPA N 50 2T 89-90, VESPA PK XL 50 2T 85-88, VESPA PK XL RUSH 50 2T 88-89, COSA 2 125 2T 91-97, COSA CL, CLX 125 2T 88-91, VESPA FL 125 2T 89-90, VESPA PK XL 125 2T 86-89, VESPA PX 125 2T 98-01, VESPA PX 125 2T 11-16, VESPA PX 30 ANNI 125 2T 07-08, VESPA PX EU2 125 2T 01-07, COSA 2 150 2T 91-97, COSA CL, CLX 150 2T 88-91, VESPA PX 150 2T 98-01, VESPA PX 150 2T 11-16, COSA 2 200 2T 91-97, COSA CL, CLX 200 2T 88-91, VESPA PX 200 2T 98-01



◀ **cod. RE00009**
Regolatore di tensione per Vespa PK 50-125 cc

RIFERIMENTO ORIGINALE

Piaggio	2940165
---------	---------

APPLICABILITÀ

GILERA EASY MOVING 50 2T 95-96, STORM 50 2T 94-95, TYPHOON 50 2T 94-97
PIAGGIO APE FL - FL2 50 2T 89-95, APE FL3 EUROPA 50 2T 96-99, FREE 50 2T 92-94, FREE FL 50 2T 95-02, NRG 50 2T 94-96, NRG RST MC2 50 2T 96-98, NTT 50 2T 95-96, QUARTZ 50 2T 92-96, SFERA 50 2T 91-93, SFERA MAQUILLAGE 2 50 2T 94-94, SFERA RST 50 2T 95-97, VESPA ET2 50 2T 97-05, VESPA FL2 AUTOMATICA 50 2T 90-91, VESPA FL2 HP 50 2T 91-97, ZIP 50 2T 92-93, ZIP 50 2T 95-96, ZIP FAST RIDER 50 2T 93-94, ZIP FAST RIDER RST 50 2T 96-97, ZIP RST 50 2T 96-99, ZIP SP 50 2T 96-00, SFERA 125 4T 95-97



cod. RE00010

Regolatore di tensione per Vespa ET4 125 - PX Arcobaleno 125/150/200 cc

RIFERIMENTO ORIGINALE

Piaggio	1616395
---------	---------

APPLICABILITÀ

PIAGGIO VESPA PK XL PLURIMATIC 50 2T 85-90, VESPA PX E ARCOBALENO 125 2T 81-97, VESPA PXT5 125 2T 85-89, VESPA PX E ARCOBALENO 150 2T 81-97, VESPA PX E ARCOBALENO 200 2T 81-97



cod. RE00011

Regolatore di tensione per Majesty 125cc

RIFERIMENTO ORIGINALE

Piaggio	58090R
Yamaha	5NRW19600000

APPLICABILITÀ

APRILIA SR R FACTORY IE 50 2T 10-14, SR R FACTORY IE 50 2T-IE 10-12, ATLANTIC 125 4T 03-05, ATLANTIC EU3 125 4T 06-08, ATLANTIC EU3 125 4T 10-12, MOJITO 125 4T 03-08, RS4 125 4T 11-13, SCARABEO 125 4T 03-06, SCARABEO EU3 125 4T 06-07, SPORT CITY 125 4T 04-06, SPORT CITY CUBE 125 4T 08-10, SPORT CITY EU3 125 4T 06-08, SPORT CITY ONE 4T EU3 125 4T 08-11, SPORT CITY STREET 125 4T 12-12, MOJITO 150 4T 03-07, SCARABEO 150 4T 04-06

DERBI BOULEVARD 125 4T 02-04, BOULEVARD 4T EU3 125 4T 08-12, BOULEVARD EU2 125 4T 04-07, GP1 EU 2 125 4T 06-06, GP1 LOW SEAT EU3 125 4T 07-08, RAMBLA 125 4T 08-09, RAMBLA EU3 2VER 125 4T 08-08, SONAR 4T 125 4T 09-11, VARIANT SPORT 4T EU3 125 4T 12-12, BOULEVARD 150 4T 02-04, BOULEVARD 4T E3 150 4T 10-10, BOULEVARD EU3 150 4T 04-07, SONAR 4T 150 4T 09-09, BOULEVARD EU2 200 4T 05-06, GP1 250 4T 06-07

GILERA RUNNER PURE JET 50 2T-IE 02-07, RUNNER PURE JET 50 2T-IE 10-11, RUNNER PURE JET ST 50 2T-IE 08-08, DNA 125 4T 01-01, NEXUS EU3 125 4T 07-08, RUNNER 4T ST EU3 125 4T 08-16, RUNNER VX 125 4T 00-06, RUNNER VX 4T EU3 125 4T 06-07, RUNNER VX RACE 125 4T 06-06, RUNNER VX SC 125 4T 06-07, RUNNER VXR RACE 200 125 4T 06-06, DNA 180 4T 01-01, RUNNER VXR 200 4T 02-06, RUNNER VXR 4T ST EU3 200 4T 08-11, RUNNER VXR EU3 200 4T 07-07, OREGON 250 4T 06-10

PIAGGIO APE 50 2T 12-17, APE EU4 50 2T 18-18, NRG POWER PUREJET 50 2T-IE 04-11, NRG PUREJET 50 2T-IE 02-04, NRG PUREJET 50 2T-IE 10-10, BEVERLY 125 4T 01-03, BEVERLY EU3 125 4T 07-08, BEVERLY EURO 3 MIC 125 4T 07-07, BEVERLY EURO 3 SPORT 125 4T 07-08, BEVERLY RST 125 4T 04-07, BEVERLY TOURER EU3 125 4T 07-10, CARNABY 125 4T 07-10, FLY 125 4T 05-07, FLY EU3 125 4T 07-11, HEXAGON GTX 125 4T 00-00, LIBERTY 125 4T 01-02, LIBERTY 4T 125 4T 06-07, LIBERTY 4T EU3 125 4T 06-08, LIBERTY 4T EU3 DELIVERY - TNT 125 4T 08-15, LIBERTY 4T SPORT EU3 125 4T 06-08, LIBERTY RST 125 4T 04-05, LIBERTY SPORT 125 4T 06-06, MP3 125 4T 06-08, SKYPPER 4T 125 4T 00-02, SUPER HEXAGON GTX 12 125 4T 01-02, TYPHOON 4T 2V E3 125 4T 10-11, VESPA ET4 125 4T 99-02, VESPA GRANTURISMO 125 4T 03-07, VESPA GRANTURISMO EU3 125 4T 06-07, VESPA GTS EU3 125 4T 07-12, VESPA GTV 125 4T 06-08, VESPA GTV 4T NAVY EU3 125 4T 08-08, VESPA LX 125 4T 05-06, VESPA LX 4T FL 125 4T 09-09, VESPA LX EU3 125 4T 06-08, VESPA LXV 4T EU3 125 4T 06-09,

VESPA LXV NAVY EU3 125 4T 07-08, VESPA S 4T EU3 125 4T 07-08, X-EVO 125 4T 07-16, X7 EU3 125 4T 08-08, X8 125 4T 04-06, X8 PREMIUM EU2 125 4T 06-06, X8 PREMIUM EU3 125 4T 06-07, X8 STREET EU2 125 4T 06-07, X9 125 4T 01-02, X9 EVOLUTION 125 4T 03-03, X9 EVOLUTION 125 4T 05-06, X9 EVOLUTION EU3 125 4T 07-07, ZIP 125 4T 00-02, FLY 150 4T 05-07, FLY EU3 150 4T 08-11, LIBERTY 4T EU3 150 4T 08-08, LIBERTY 4T SPORT EU3 150 4T 08-08, LIBERTY MOC 4T 150 4T 09-13, VESPA LX 150 4T 05-06, VESPA LX 4T FL 150 4T 09-09, VESPA LX EU3 150 4T 06-08, VESPA S 4T 150 4T 08-09, X8 STREET EU2 150 4T 06-08, SUPER HEXAGON GTX 12 180 4T 01-02, X9 AMALFI 180 4T 00-03, CARNABY 200 4T 07-08, LIBERTY 200 4T 06-06, LIBERTY 4T EU3 200 4T 06-08, LIBERTY 4T SPORT EU3 200 4T 06-07, LIBERTY RST 200 4T 04-04, LIBERTY SPORT 200 4T 06-06, VESPA GRANTURISMO 200 4T 03-07, X8 200 4T 05-07, X9 200 4T 02-03, X9 EVOLUTION 200 4T 03-03, BEVERLY 250 4T 05-07, BEVERLY RST 250 4T 04-05, X9 EVOLUTION 250 4T 04-04, X9 EVOLUTION 250 4T 06-06

cod. RE00012

Regolatore di tensione per Aprilia Scarabeo 50 2T - Ape '03/'10

RIFERIMENTO ORIGINALE

Piaggio	58096R
---------	--------

APPLICABILITÀ

APRILIA SCARABEO 2T EU2 MOTORE PIAGGIO 50 2T 10-12, SCARABEO 2T NET 50 2T 09-10, SCARABEO STREET 50 2T 05-06, SCARABEO STREET 2T RESTYLING 50 2T 06-09, SPORT CITY ONE 2T 50 2T 08-11, SR MOTARD 50 2T 12-14, SR R 50 2T 04-09, SR R FACTORY CARBURATORE 50 2T 10-14, SR STEALTH 50 2T 97-00, SR STREET CARBURATORE 50 2T 03-12, MOJITO RETRO 'CUSTOM 125 4T 99-01, SR MOTARD 125 4T-2V 12-14

DERBI ATLANTIS 02 50 2T 02-02, BOULEVARD 2T 50 2T 09-14, GP1 50 2T 01-03, GP1 EU 2 50 2T 05-05, GP1 OPEN EU2 50 2T 06-09, GP1 RACE EU2 50 2T 05-07, SONAR 2T 50 2T 09-09

GILERA DNA 50 2T 00-02, DNA 50 2T 05-07, DNA GP EXPERIENCE 50 2T 03-04, ICE 50 2T 01-05, RUNNER 50 2T 97-00, RUNNER POGGIALI 50 2T 02-02, RUNNER SP 50 2T 02-07, RUNNER SP 50 2T 10-12, RUNNER SP SPECIAL EDITION 50 2T 07-07, RUNNER SP ST & SIMONCELLI 50 2T 08-09, STALKER 50 2T 97-11, STALKER NAKED 50 2T 08-08, STALKER SPECIAL EDITION 50 2T 07-08, STORM EURO 2 50 2T 07-07, TYPHOON X 50 2T 98-99, TYPHOON XR 50 2T 00-00

PIAGGIO APE 50 2T 09-11, APE MIX 2T 50 2T 98-08, APE RST MIX 50 2T 99-03, DIESIS 50 2T 01-01, FLY 2T 50 2T 05-07, FLY 2T 50 2T 10-11, FREE DELIVERY 50 2T 00-01, LIBERTY 50 2T 97-05, LIBERTY 2T 50 2T 06-08, LIBERTY 2T PTT EU2 50 2T 04-05, LIBERTY 2T RST 50 2T 04-04, LIBERTY 2T SPORT 50 2T 06-08, LIBERTY MOC 2T & ELLE 50 2T 09-13, NRG EXTREME LC 50 2T 99-00, NRG MC3 50 2T 01-04, NRG POWER DD 50 2T 05-17, NRG POWER DD SERIE SPECIALE 50 2T 07-12, NRG POWER DT 50 2T 06-15, NRG POWER DT SERIE SPECIALE 50 2T 07-08, TYPHOON 50 2T 01-11, TYPHOON 2T E2 50 2T 10-12, TYPHOON 2T E3 CH 50 2T 11-11, VESPA LX 2T 50 2T 05-13, VESPA LXV 2T 50 2T 06-09, VESPA LXV 2T NAVY 50 2T 08-08, VESPA S 2T & COLLEGE 50 2T 07-12, ZIP 2T 50 2T 08-13, ZIP LC 50 2T 00-04, ZIP SP 50 2T 01-04, ZIP SP EURO 2 50 2T 06-13, HEXAGON LX4 125 4T 98-99, LIBERTY 125 4T 98-00, VESPA ET4 125 4T 96-98





◀ **cod. RE00013**
Regolatore di tensione per Kymco - Sym

RIFERIMENTO ORIGINALE

Kymco	00169004
Malaguti	02601500

Sym	31600KBN920
-----	-------------

APPLICABILITÀ

KYMCO AGILITY 4T R10 50 4T 06-08, AGILITY 4T R12 50 4T 07-08, AGILITY R12 50 4T 05-05, B&W 50 2T 02-02, B&W EU2 50 2T 03-03, CX 50 2T 93-93, CX SUPER 50 2T 94-97, DINK LC 50 2T 98-02, DINK 50 4T 50 4T 07-07, DINK CLASSIC EU2 50 2T 03-03, DJ WORLD 50 2T 94-00, DJ X 50 2T 91-92, DJ Y 50 2T 93-93, FEVER ZX 50 2T 99-00, FEVER ZX EU2 50 2T 03-04, FILLY 50 4T 98-00, FILLY LX 50 4T 01-02, HEROISM 50 2T 95-97, K 12 50 2T 95-00, KB 50 2T 95-00, MXER 50 2T 02-03, MXER EU2 50 2T 04-04, PEOPLE 50 2T 99-04, PEOPLE EURO 2 50 2T 03-03, PEOPLE EURO 2 50 2T 08-08, PEOPLE S 4T 50 4T 06-08, SNIPER 50 2T 93-93, SNIPER DD 50 2T 94-96, SUPER 9 50 2T 00-00, SUPER 9 EU2 50 2T 03-04, TOP BOY 50 2T 97-00, VITALITY 2T 50 2T 04-04, VITALITY 4T 50 4T 04-04, YUP 50 2T 02-02, YUP EU2 50 2T 03-03, AGILITY 125 4T 06-06, AGILITY EU3 125 4T 06-08, MOVIE 125 4T 99-00, MOVIE EU3 125 4T 06-07, MOVIE XL 125 4T 01-01, MOVIE XL EU2 125 4T 03-04, PEOPLE 125 4T 99-00, PEOPLE EU2 125 4T 03-03, PEOPLE EU3 125 4T 07-08, VIVIO 125 4T 00-00, MOVIE EU3 150 4T 06-07, MOVIE XL 150 4T 01-01, MOVIE XL EU2 150 4T 03-04, PEOPLE 150 4T 99-00, PEOPLE EU2 150 4T 03-03, VIVIO 150 4T 00-00

MALAGUTI CIAK 125 4T 00-01, CIAK MASTER 125 4T 04-04, CIAK RESTYKING EU2 125 4T 03-03, CIAK 150 4T 00-02, CIAK MASTER 150 4T 04-04, CIAK RESTYKING EU2 150 4T 03-03
SYM JET 50 2T 99-01, JUNGLE 50 2T 99-00, MASK 50 2T 00-01, RED DEVIL 50 2T 99-99, SUPER FANCY 50 2T 98-00, JET 100 2T 99-00, SUPER DUKE 125 4T 99-02, SUPER DUKE 150 4T 99-02



◀ **cod. RE00014**
Regolatore di tensione per F10-F12 - Booster - Nitro

RIFERIMENTO ORIGINALE

Aprilia	AP8212799
Malaguti	02601100

Yamaha	4VWH19600100
--------	--------------

APPLICABILITÀ

APRILIA AMICO 50 2T 94-94, AMICO 50 2T 96-98, AMICO GL/GLE 50 2T 93-95, AMICO LX/SPORT/CAT 50 2T 92-93, GULLIVER 50 2T 95-98, GULLIVER LC 50 2T 96-98, RALLY 50 2T 95-03, RALLY LIQUID COOLED 50 2T 96-99, SCARABEO 50 2T 93-05, SCARABEO 2T NET 50 2T 10-10, SONIC 50 2T 98-07, SONIC GP 50 2T 98-08, SR (ORIZZONTALE) 50 2T 94-96, SR (VERTICALE) 50 2T 93-93, SR LIQUID COOLED 50 2T 94-96, SR RACING 50 2T 97-99, SR STEALTH 50 2T 97-00, SR WWW 50 2T 97-01, SCARABEO (MINARELLI) 100 2T 00-00, SCARABEO (YAMAHA) 100 2T 00-00
MALAGUTI CENTRO SL 50 2T 94-98, CIAK 50 2T 99-01, CIAK EURO2 50 2T 01-03, CROSSER CR1 50 2T 95-98, F10 50 2T 92-00, F10 AC WAP 50 2T 08-08, F10 EURO 2 50 2T 02-06, F12 PHANTOM EURO 2 50 2T 02-02, F12 PHANTOM LC 50 2T 94-98, F12 R PHANTOM AC 50 2T 07-08, F12 RESTYLING EURO 1 50 2T 99-02, F15 FIRE FOX 50 2T 96-98, F15 FIRE FOX AIR COOLED 50 2T 05-06, F15 FIRE FOX EURO 2 50 2T 02-06, YESTERDAY 50 2T 97-00, CIAK 100 4T 99-00, F12 PHANTOM 100 4T 99-00

MBK BOOSTER 50 2T 90-04, BOOSTER 50 2T 90-94, BOOSTER NG 50 2T 95-03, BOOSTER ROCKET 50 2T 97-98, BOOSTER SPIRIT 50 2T 96-00, BOOSTER TRACK 50 2T 96-98, EVOLIS 50 2T 92-95, FIZZ 50 2T 94-95, FLIPPER 50 2T 98-04, FORTE 50 2T 94-96, NITRO 50 2T 97-04, OVETTO 50 2T 97-04, STUNT 50 2T 00-02, NITRO 100 2T 00-02
YAMAHA AEROX 50 2T 97-02, AEROX 50 2T 04-16, AEROX NAKED 50 2T 13-16, AEROX R 50 2T 99-00, AXIS 50 2T 95-96, BREEZE 50 2T 94-95, BW'S 50 2T 97-04, BW'S BUMP 50 2T 97-98, BW'S NAKED 50 2T 03-03, BW'S NEXT GENERATION 50 2T 97-02, BW'S ORIGINAL 50 2T 99-01, NEO'S 50 2T 97-02, NEO'S 50 2T 04-16, NEO'S EASY 50 2T 13-13, RS SPY 50 2T 95-98, SLIDER 50 2T 00-02, WHY 50 2T 98-05, AEROX 100 2T 00-02



◀ **cod. RE00015**
Regolatore di tensione per Yamaha - BW'S - Aerox - Neo's - Nitro

RIFERIMENTO ORIGINALE

Yamaha	5RNN19600000
--------	--------------

APPLICABILITÀ

MBK BOOSTER EURO 2 50 2T 04-04, BOOSTER NG 50 2T 03-03, BOOSTER SPIRIT 50 2T 03-03, BOOSTER SPIRIT EURO2 50 2T 03-03, FLIPPER EURO 2 50 2T 03-03, MACH G 50 2T 02-04, MACH G LC 50 2T 02-04, NITRO EURO 2 50 2T 03-03, OVETTO EURO 2 50 2T 02-02, OVETTO 100 2T 99-02

YAMAHA AEROX EURO 2 50 2T 03-03, BW'S 50 2T 04-16, BW'S EASY 50 2T 13-13, BW'S NAKED 50 2T 04-04, BW'S NAKED 50 2T 09-16, BW'S NEXT GENERATION 50 2T 03-06, BW'S ORIGINAL EURO 2 50 2T 03-03, DT R 50 2T 07-11, DT X 50 2T 07-11, JOG R 50 2T 02-02, JOG R EURO2 50 2T 02-02, JOG R EURO2 50 2T 06-15, JOG R LC 50 2T 02-15, NEO'S EURO 2 50 2T 02-02, TZR 50 2T 03-08, TZR 50 2T 10-11, TZR RR 50 2T 05-05, WHY EURO 2 50 2T 03-05, NEO'S 100 2T 99-02, XT-R 125 4T-2V 05-08, XT-X 125 4T-2V 05-08



cod. RE00018

Regolatore di tensione per Scarabeo 50-100 cc 4T - Vespa LX 4T

RIFERIMENTO ORIGINALE

Piaggio 9693825

Malaguti 02602800

APPLICABILITÀ

APRILIA SCARABEO 4T 50 4T 02-06, SCARABEO 4T RESTYLING EU3 50 4T 06-09, SCARABEO 4T 100 4T 01-05, SCARABEO 4T 100 4T 10-12, SCARABEO 4T NET 100 4T 09-09, SCARABEO 4T NET EU3 100 4T 10-10, SCARABEO 4T RESTYLING 100 4T 06-09

DERBI ATLANTIS 4T 50 4T 04-06, BOULEVARD 4T EU2 25KM/H 50 4T 09-09, BOULEVARD 4T 100 4T 10-11

MALAGUTI CENTRO EURO 2 50 4T 08-08, CENTRO SL 4T 50 4T 10-10, CIAK MASTER EURO 2 50 4T 05-06

PIAGGIO FLY 4T 50 4T 05-07, FLY 4T MOTORE CHN 50 4T 06-07, LIBERTY 4T 50 4T 00-02, LIBERTY 4T 50 4T 05-08, LIBERTY 4T DELIVERY - SINGLE 50 4T 10-14, LIBERTY 4T DELIVERY TNT 50 4T 09-09, LIBERTY 4T PTT - DOUBLE - NEXIVE 50 4T 09-17, LIBERTY 4T RST 50 4T 04-04, LIBERTY 4T SPORT 50 4T 06-08, LIBERTY MOC 4T & ELLE 50 4T 09-16, VESPA ET4 50 4T 00-05, VESPA LX 4T 50 4T 05-09, ZIP 4T 50 4T 00-13, FLY 100 4T 06-14, FREE 100 4T 02-03, ZIP 4T 100 4T 06-10



cod. RE00019

Regolatore di tensione per People S 250 cc '08/'10 - Agility 125/150 cc R16 '09/'10

RIFERIMENTO ORIGINALE

Kymco 00169587

Malaguti 02603000

APPLICABILITÀ

KYMCO AGILITY PLUS 4T 50 4T 14-14, AGILITY R12 ECS 50 4T 16-16, AGILITY R16 50 4T 08-09, AGILITY R16 50 4T 12-12, AGILITY R16 2T 50 2T 10-10, AGILITY R16 2T 50 2T 12-12, AGILITY RS 50 4T 09-09, AGILITY RS NAKED 50 2T 10-10, LIKE 50 4T 09-09, SUPER 8 50 2T 09-09, SUPER 8 4T 50 4T 07-07, SUPER 8 4T 50 4T 09-09, AGILITY PLUS 125 4T 14-14, AGILITY R16 125 4T 08-09, AGILITY R16 125 4T 12-12, AGILITY RS 125 4T 09-09, LIKE 125 4T 09-09, PEOPLE S 125 4T 05-05, PEOPLE S DD EU3 125 4T 07-08, SUPER 8 125 4T 08-09, AGILITY R16 150 4T 08-09, LIKE LX 200 4T 12-12, PEOPLE S 200 4T 05-05

MALAGUTI CIAK MASTER EU3 125 4T 06-06, CIAK MASTER EURO 2 200 4T 06-06



cod. RE00020

Regolatore di tensione per Majesty 125/150 cc '98/'00 - Skyliner 125/150 - Madison 125/150 cc

RIFERIMENTO ORIGINALE

Yamaha 5NRW19600000

APPLICABILITÀ

MBK SKYLINER 125 4T 98-02, DOODO 150 4T 01-02, SKYLINER 150 4T 00-02

YAMAHA MAJESTY 125 4T 98-00, MAJESTY (5NR1) 125 4T 01-01, MAJESTY 150 4T 00-00, MAJESTY (5NS1) 150 4T 01-01, TEO'S 150 4T 01-02

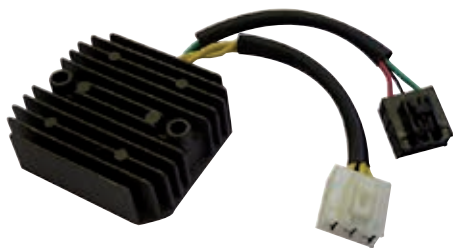

◀ cod. **RE00021**
Regolatore di tensione per Honda SH 125/150 cc IE '05/'10

RIFERIMENTO ORIGINALE

Honda	31600-KTF-641
-------	---------------

APPLICABILITÀ

HONDA SH IE SCOOPIY 125 4T-2V 05-12, SH IE SCOOPIY 150 4T 05-12



◀ cod. **RE00022**
Regolatore di Tensione Yamaha T-MAX 500 '08-'09

RIFERIMENTO ORIGINALE

Yamaha	4XY819600000
--------	--------------

APPLICABILITÀ

YAMAHA XVS DRAG STAR 125 4T 00-03, MAJESTY 250 4T 02-03, MAJESTY ABS 250 4T 03-03, WR250R 250 4T 08-08, WR250R 250 4T 13-13, WR250X 250 4T 08-08, X-MAX 250 4T 05-06, XVS DRAG STAR 250 4T 04-04, VERSITY 300 4T 03-06, MAJESTY 400 4T 04-11, MAJESTY ABS 400 4T 07-11, SR400 400 4T 14-14, T-MAX 4BS 500 4T 09-11, T-MAX 4BS ABS 500 4T 08-11, T-MAX SVU 500 4T 08-08, T-MAX SV 500 4T 11-11, T-MAX SV ABS 500 4T 10-11, T-MAX WHITE MAX 500 4T 10-10, YZF R6 600 4T 07-15, YZF R6 & LIMITED EDITION 07 600 4T 06-06, YZF R6 50TH 600 4T 12-12, MT-03 660 4T 06-11, XT Z TENERE 660 4T 08-13, DRAG STAR CLASSIC XVS A 1100 4T 03-03, DRAG STAR CLASSIC XVS A 1100 4T 06-06, XVS A DRAG STAR CLASSIC 1100 4T 05-05, XVZ TF ROYAL STAR VENTURE 1300 4T 00-00



◀ cod. **RE00023**
Regolatore di Tensione Yamaha X-MAX 250 cc '07-'09

RIFERIMENTO ORIGINALE

Yamaha	5BN819600000
--------	--------------

APPLICABILITÀ

SYM SYMPLY II 125 4T 09-10

YAMAHA X-CITY EUJ 125 4T-4V 08-11, X-MAX R 125 4T-4V 06-09, X-MAX R 125 4T-4V 14-16, X-MAX RA ABS 125 4T-4V 14-16, XVS DRAG STAR 125 4T 04-04, X-CITY 250 4T 07-15, X-MAX 250 4T 07-09, X-MAX 250 4T 14-16, X-MAX ABS 250 4T 14-15, X-MAX BLACK 250 4T 09-09, XVS DRAG STAR 250 4T 01-03, YBR 250 4T 07-11, XVS A DRAG STAR CLASSIC 650 4T 98-01, XVS DRAG STAR 650 4T 97-02, BT BULLDOG 1100 4T 02-06, DRAG STAR CLASSIC XVS A 1100 4T 00-02, XVS DRAG STAR 1100 4T 99-02, XV A WILD STAR 1600 4T 99-02



◀ cod. **RE00024**
Regolatore di Tensione Derbi Senda X-Treme 50 cc

APPLICABILITÀ

APRILIA RS 50 2T 06-10, RS4 50 2T 11-13, RS4 REPLICA 50 2T 14-16, RX 50 2T 06-10, RX 50 2T 14-16, SX 50 2T 06-16, SX LIMITED EDITION 50 2T 14-16

DERBI GPR 2T 50 2T 13-13, GPR 2T EU2 50 2T 09-10, GPR NUDE 50 2T 04-05, GPR NUDE & GPR NUDE TUNING 50 2T 06-08, GPR NUDE SPORT 50 2T 06-06, GPR R EU2 - GPR REPLICA EU2 50 2T 08-08, GPR RACING 50 2T 04-05, GPR RACING EU2 50 2T 06-06, GPR REPLICA 50 2T 99-01, GPR REPLICA & GPR R EU2 50 2T 06-06, GPR REPLICA 2T MALOSSJ 50 2T 07-07, GPR REPLICA PESEK EU2 50 2T 07-07, GPR REPLICA RACING 50 2T 02-03, GPR REPLICA RACING EU2 50 2T 05-05, SENDA BLACK EDITION 50 2T 03-03, SENDA HYP DRD EVO EU2 50 2T 08-09, SENDA HYP DRD EVO LIMITED EDITION EU2 50 2T 08-08, SENDA R 50 2T 00-01, SENDA R DRD BLACK DEVIL 2A EDIZIONE 50 2T 03-03, SENDA R DRD EU1 EU1R 50 2T 02-02, SENDA R DRD PRO EU2 50 2T 05-11, SENDA R DRD RACING EU2 50 2T 05-08, SENDA R DRD X-TREME 2T EU2 50 2T 14-15, SENDA R DRD X-TREME 2T EURO2 50 2T 10-12, SENDA R RACER 50 2T 03-03, SENDA R X-RACE 50 2T 05-05, SENDA R X-RACE 2T EU2 50 2T 10-10, SENDA R X-RACE EU2 50 2T 06-09, SENDA R X-TREME 50 2T 03-03, SENDA R X-TREME 50 2T 05-05, SENDA R X-TREME 2T EU2 50 2T 10-10, SENDA R X-TREME EU2 50 2T 05-08, SENDA SM 50 2T 00-01, SENDA SM DRD EU1 EU1R 50 2T 02-03, SENDA SM DRD PRO EU2 50 2T 05-11, SENDA SM DRD PRO EU2 2VER 50 2T 05-08, SENDA SM DRD RACING EU2 50 2T 05-08, SENDA SM DRD RACING EU2 50 2T 10-13, SENDA SM DRD RACING LTD EU2 50 2T 07-07, SENDA SM DRD X-TREME 2T EU2 50 2T 14-15, SENDA SM DRD X-TREME 2T EU2 LIMITED ED 50 2T 14-15, SENDA SM X-RACE 50 2T 05-05, SENDA SM X-RACE 2T EU2 50 2T 10-10, SENDA SM X-RACE EU2 50 2T 06-09, SENDA SM X-RACE EU2 2VER 50 2T 07-09, SENDA SM X-TREME 50 2T 02-03, SENDA SM X-TREME 2T EU2 50 2T 10-10, SENDA SM X-TREME EU2 50 2T 07-08, SENDA SM X-TREME EU2 2A EDIZIONE 50 2T 05-05

GILERA RCR 50 2T 03-03, RCR 50 2T 06-07, RCR 50 2T 11-13, RCR (CHE-SYC) 50 2T 13-15, SMT 50 2T 03-03, SMT 50 2T 06-13, SMT RACING 50 2T 11-12



◀ cod. **RE00025**
Regolatore di Tensione Derbi Atlantis 50 cc

RIFERIMENTO ORIGINALE

Derbi	00G01001841
-------	-------------

APPLICABILITÀ

DERBI ATLANTIS 50 2T 99-01, ATLANTIS LC 50 2T 99-01, BULTACO LOBITO 50 2T 98-01, PREDATOR LC 50 2T 98-01, PREDATOR 02 50 2T 98-01, ATLANTIS 100 2T 00-01

PIAGGIO DIESIS 100 2T 01-01

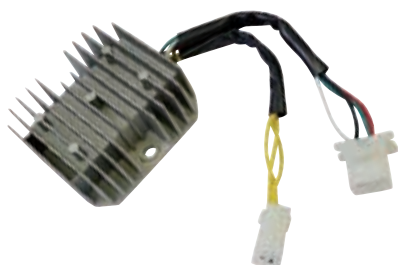

◀ cod. **RE00026**
Regolatore di Tensione Kymco Dink 125/150 cc

RIFERIMENTO ORIGINALE

Kymco	00168780
-------	----------

APPLICABILITÀ

KYMCO B&W 125 4T 00-00, B&W EU2 125 4T 03-04, DINK 125 4T 97-98, DINK CLASSIC 125 4T 02-02, DINK CLASSIC EU2 125 4T 03-03, DINK LX 125 4T 98-00, GRAND DINK 125 4T 01-02, GRAND DINK EU2 125 4T 03-04, HEROISM 125 4T 95-97, B&W 150 4T 00-00, B&W EU2 150 4T 03-04, DINK 150 4T 97-98, DINK CLASSIC 150 4T 02-02, DINK CLASSIC EU2 150 4T 03-03, DINK LX 150 4T 98-00, GRAND DINK 150 4T 01-02, GRAND DINK EU2 150 4T 03-04, HEROISM 150 4T 95-97, DINK CLASSIC 200 4T 04-04, PEOPLE S I 200 4T 07-07, B&W 250 4T 00-00, B&W EU2 250 4T 03-03, GRAND DINK 250 4T 01-02, GRAND DINK EU2 250 4T 03-04, PEOPLE LC 250 4T 03-04, X CITING 250 4T 05-05, YUP 250 4T 03-03



◀ cod. **RE00028**
Regolatore di Tensione Kymco Dntown 300 cc



◀ cod. **RE00029**
Regolatore di Tensione Honda SH 300cc dal 2011



◀ cod. **RE00030**
Regolatore di Tensione Yamaha X-MAX 250 cc

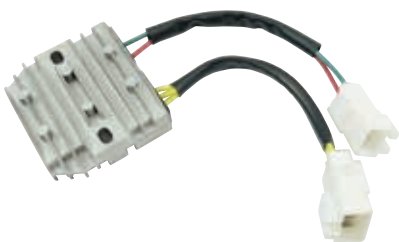

◀ cod. **RE00031**
Regolatore di Tensione Honda SH 300 cc '07-'10



◀ cod. **RE00033**
Regolatore di tensione Yamaha T-Max 500/530 cc

APPLICABILITÀ

YAMAHA T-MAX 5VU 500 4T 04-07, T-MAX 5VU ABS 500 4T 05-07, T-MAX 5VU BLACK MAX 500 4T 06-06, T-MAX 5VU BLACK MAX - NIGHT MAX 500 4T 07-07, T-MAX 59C 530 4T 12-16, T-MAX 59C ABS 530 4T 12-16, T-MAX 59C SP 530 4T 15-15, T-MAX 59C SP ABS 530 4T 15-16, XP530-A T-MAX SX 530 4T 17-19, XP530D-A T-MAX DX 530 4T 17-19, XP530E-A T-MAX 530 4T 17-18, FZ6 600 4T 04-07, FZ6 FAZER 600 4T 04-07, FZ6 FAZER ABS 600 4T 06-07, FZ6 FAZER S2 600 4T 07-08, FZ6 FAZER S2 ABS 600 4T 08-08, FZ6 NS 600 4T 05-06, FZ6 S2 600 4T 07-08



◀ cod. **RE00034**
Regolatore Yamaha MT-09 '14-'17

APPLICABILITÀ

BMW F 750 GS (K80) 750 4T 16-18, F 850 GS (K81) 850 4T 16-18, R 1200 GS (K50) 1200 4T 11-18, R 1200 GS ADVENTURE (K51) 1200 4T 12-18, R 1200 R (K53) 1200 4T 13-18, R 1200 RS (K54) 1200 4T 14-18, R 1200 RT (K52) 1200 4T 13-18

HONDA TRX 420 FOURTRAX 420 4T 14-17, CB 500 F ABS 500 4T 13-17, CB 500 X ABS 500 4T 13-17, CBR 500 R ABS 500 4T 14-17, REBEL 500 4T 17-18, TRX 500 FOURTRAX 500 4T 14-17, CBR 600 RR ABS 600 4T 13-16, CB 650 F ABS 650 4T 14-17, CBR 650 F ABS 650 4T 14-17, CRF 1000 L AFRICA TWIN ABS 1000 4T 16-18, CB 1100 ABS 1100 4T 14-14, CB 1100 EX ABS 1100 4T 15-16

YAMAHA FZ8-N 800 4T 11-13, FZ8-N 800 4T 15-15, FZ8-NA 800 4T 11-13, FZ8-NA 800 4T 15-15, FZ8-S 800 4T 11-11, FZ8-S 800 4T 15-15, FZ8-SA 800 4T 11-15, MT-09 850 4T 14-15, MT-09 (MTN850-A) 850 4T 17-18, MT-09 SP (MTN850D) 850 4T 18-18, MT-09A ABS 850 4T 14-16, MT-09A RACER 850 4T 15-17, XRS900 850 4T 16-18, SCR950 950 4T 17-17, XV950 950 4T 14-14, XV950 RACER 950 4T 15-16, XV950CU 950 4T 14-16, XV950R 950 4T 14-17, XVS950A MIDNIGHT STAR 950 4T 09-12, FZ1 1000 4T 06-09, FZ1 FAZER 1000 4T 06-12, FZ1 FAZER ABS 1000 4T 07-12, FZ1-N 1000 4T 11-11, FZ1-NA 1000 4T 10-11, YZF R1 1000 4T 07-14, XT1200Z SUPER TENERE 1200 4T 10-15, XT1200Z SUPER TENERE 1200 4T 17-17, XT1200ZE SUPER TENERE 1200 4T 14-15, XT1200ZE SUPER TENERE 1200 4T 17-17, FJR1300A 1300 4T 16-18, FJR1300A ABS 1300 4T 06-08, FJR1300A ABS 1300 4T 10-11, FJR1300A ABS 1300 4T 13-15, FJR1300AE 1300 4T 14-18, FJR1300AS 1300 4T 06-08, FJR1300AS 1300 4T 13-18, XVS1300A MIDNIGHT STAR 1300 4T 07-08, V-MAX 1700 4T 09-16, MT-01 1900 4T 09-09, MT-01S 1900 4T 09-09, XV1900A MIDNIGHT STAR 1900 4T 06-09, XV1900A MIDNIGHT STAR 1900 4T 13-13



◀ cod. **AC1003N**

Kymco Applications
12 Volt Regulator Rectifier Assembly

MAKE / MODEL	YEAR
Kymco Agility 125	2009-2013
Kymco Agility 50	2012-2014



◀ cod. **B1001N**

Aprilia / BMW Motorcycles
12 Volt Regulator Rectifier Assembly

MAKE / MODEL	YEAR
Aprilia Pegaso 650	1996-2000
BMW F650 Funduro	1993-2000



◀ cod. **H0502**

Harley-Davidson 38-48A Systems
12 Volt - Black finish

MAKE / MODEL	YEAR
Harley Davidson FLHRCI Road King Classic	2002
Harley Davidson FLHRI Road King	2002-2003
Harley Davidson FLTR Road Glide	2002
Harley Davidson FLTRI Road Glide	2002-2003



◀ cod. **H0502C**

Harley-Davidson 38-48A Systems
12 Volt - Chrome Finish

MAKE / MODEL	YEAR
Harley Davidson FLHRCI Road King Classic	2002
Harley Davidson FLHRI Road King	2002-2003
Harley Davidson FLTR Road Glide	2002
Harley Davidson FLTRI Road Glide	2002-2003



◀ **cod. H0505**
Harley-Davidson Systems
12 Volt Regulator Rectifier Assembly

MAKE / MODEL	YEAR
Harley Davidson FLHR Road King	2009-2014
Harley Davidson FLHRC Road King Classic	2009-2013
Harley Davidson FLHT Electra Glide Standard	2009
Harley Davidson FLHTC Electra Glide Classic	2009-2013
Harley Davidson FLHTCU Electra Glide Ultra Classic	2009-2013
Harley Davidson FLHTCUTG Tri Glide Ultra	2014
Harley Davidson FLHTCUTG Tri Glide Ultra Classic	2009-2013
Harley Davidson FLHTK Electra Glide Ultra Limited	2010-2013
Harley Davidson FLHTP Police	2012-2014
Harley Davidson FLHX Street Glide	2009-2013
Harley Davidson FLHXXX Street Glide Trike	2010-2011
Harley Davidson FLTR Road Glide	2009
Harley Davidson FLTRU Road Glide Ultra	2011-2013
Harley Davidson FLTRX Road Glide Custom	2010-2013



◀ **cod. H0505C**
Harley-Davidson Systems
12 Volt Regulator Rectifier Assembly

MAKE / MODEL	YEAR
Harley Davidson FLHP Road King	2011-2014
Harley Davidson FLHR Road King	2009-2013
Harley Davidson FLHRC Road King Classic	2009-2013
Harley Davidson FLHT Electra Glide Standard	2009
Harley Davidson FLHTC Electra Glide Classic	2009-2013
Harley Davidson FLHTCU Electra Glide Ultra Classic	2009-2013
Harley Davidson FLHTCUTG Tri Glide Ultra	2014
Harley Davidson FLHTCUTG Tri Glide Ultra Classic	2009-2013
Harley Davidson FLHTK Electra Glide Ultra Limited	2010-2013
Harley Davidson FLHTP Police	2012-2014
Harley Davidson FLHX Street Glide	2009-2013
Harley Davidson FLHXXX Street Glide Trike	2010-2011
Harley Davidson FLTR Road Glide	2009
Harley Davidson FLTRU Road Glide Ultra	2011-2013
Harley Davidson FLTRX Road Glide Custom	2010-2013



◀ **cod. H0506**
Harley-Davidson Systems
12 Volt - Black Finish

MAKE / MODEL	YEAR
Harley Davidson FLHP Road King	2007
Harley Davidson FLHR Road King	2006-2008
Harley Davidson FLHRC Road King Classic	2007-2008
Harley Davidson FLHRCI Road King Classic	2006-2008
Harley Davidson FLHRI Road King	2006-2008
Harley Davidson FLHRS Road King Custom	2006-2007
Harley Davidson FLHRSE4 Screamin Eagle Road King	2008
Harley Davidson FLHRSI Road King Custom	2006
Harley Davidson FLHT Electra Glide Standard	2006-2008

cod. H0506 - continued

MAKE / MODEL	YEAR
Harley Davidson FLHTC Electra Glide Classic	2007-2008
Harley Davidson FLHTCI Electra Glide Classic	2006-2008
Harley Davidson FLHTCU Electra Glide Ultra Classic	2007-2008
Harley Davidson FLHTCUI Electra Glide Ultra Classic	2006-2008
Harley Davidson FLHTI Electra Glide Standard	2007-2008
Harley Davidson FLHTP Police	2007
Harley Davidson FLHX Street Glide	2006-2008
Harley Davidson FLHXI Street Glide	2006
Harley Davidson FLTR Road Glide	2007-2008
Harley Davidson FLTRI Road Glide	2006-2008

cod. H0506C Harley-Davidson Systems 12 Volt - Chrome Finish



MAKE / MODEL	YEAR
Harley Davidson FLHP Road King	2007
Harley Davidson FLHR Road King	2006-2008
Harley Davidson FLHRC Road King Classic	2007-2008
Harley Davidson FLHRCI Road King Classic	2006-2008
Harley Davidson FLHRI Road King	2006-2008
Harley Davidson FLHRS Road King Custom	2006-2007
Harley Davidson FLHRSE4 Screamin Eagle Road King	2008
Harley Davidson FLHRSI Road King Custom	2006
Harley Davidson FLHT Electra Glide Standard	2006-2008
Harley Davidson FLHTC Electra Glide Classic	2007-2008
Harley Davidson FLHTCI Electra Glide Classic	2006-2008
Harley Davidson FLHTCU Electra Glide Ultra Classic	2007-2008
Harley Davidson FLHTCUI Electra Glide Ultra Classic	2006-2008
Harley Davidson FLHTI Electra Glide Standard	2007-2008
Harley Davidson FLHTP Police	2007
Harley Davidson FLHX Street Glide	2006-2008
Harley Davidson FLHXI Street Glide	2006
Harley Davidson FLTR Road Glide	2007-2008
Harley Davidson FLTRI Road Glide	2006-2008

cod. H0597 Harley-Davidson Systems 12 Volt, Series-Type, 14.4 Vset



MAKE / MODEL	YEAR
Harley Davidson FLHRCI Road King Classic	1999-2001
Harley Davidson FLHRI Road King	2000-2001
Harley Davidson FLHTCI Electra Glide Classic	1997-2001
Harley Davidson FLHTCUI Electra Glide Ultra Classic	1997-2001
Harley Davidson FLHTI Electra Glide Standard	1997-2001
Harley Davidson FLTR Road Glide	1999-2001
Harley Davidson FLTRI Road Glide	1999-2001



◀ **cod. H0597C**
Harley-Davidson Systems
12 Volt, Series-Type, 14.4 Vset

MAKE / MODEL	YEAR
Harley Davidson FLHRCI Road King Classic	1999-2001
Harley Davidson FLHRI Road King	2000-2001
Harley Davidson FLHTCI Electra Glide Classic	1997-2001
Harley Davidson FLHTCUI Electra Glide Ultra Classic	1997-2001
Harley Davidson FLHTI Electra Glide Standard	1997-2001
Harley Davidson FLTR Road Glide	1999-2001
Harley Davidson FLTRI Road Glide	1999-2001



◀ **cod. H1001**
Harley-Davidson Systems
12 Volt, Series-Type, 14.4 Vset

MAKE / MODEL	YEAR
Harley Davidson FLSTCI Heritage Softail Classic	2001-2006
Harley Davidson FLSTFSE Screamin Eagle Fat Boy	2005
Harley Davidson FLSTFSE2 Screamin Eagle Fat Boy	2006
Harley Davidson FLSTI Heritage Softail	2006
Harley Davidson FLSTNI Softail Deluxe	2005-2006
Harley Davidson FLSTSCI Softail Springer Classic	2005-2006
Harley Davidson FXSTDI Softail Deuce	2001-2006
Harley Davidson FXSTI Softail Standard	2001-2006
Harley Davidson FXSTSI Springer Softail	2001-2006



◀ **cod. H1001C**
Harley-Davidson Systems
12 Volt, Series-Type, 14.4 Vset

MAKE / MODEL	YEAR
Harley Davidson FLSTCI Heritage Softail Classic	2001-2006
Harley Davidson FLSTFSE Screamin Eagle Fat Boy	2005
Harley Davidson FLSTFSE2 Screamin Eagle Fat Boy	2006
Harley Davidson FLSTI Heritage Softail	2006
Harley Davidson FLSTNI Softail Deluxe	2005-2006
Harley Davidson FLSTSCI Softail Springer Classic	2005-2006
Harley Davidson FXSTDI Softail Deuce	2001-2006
Harley Davidson FXSTI Softail Standard	2001-2006
Harley Davidson FXSTSI Springer Softail	2001-2006



◀ **cod. H1070**
Harley-Davidson 15A Systems
12 Volt, Shunt Type, 14.5 Vset

MAKE / MODEL	YEAR
Harley Davidson FLH Electra Glide	1970-1975
Harley Davidson FLHF	1970-1972
Harley Davidson FX Super Glide	1971-1975
Harley Davidson FXE Super Glide	1974-1975
Harley Davidson XLCH	1972-1975
Harley Davidson XLH1000	1972-1975
Harley Davidson XLH900	1971



◀ **cod. H1070C**
Harley-Davidson 15A Systems
12 Volt, Shunt Type, 14.5 Vset

MAKE / MODEL	YEAR
Harley Davidson FLH Electra Glide	1970-1975
Harley Davidson FLHF	1970-1972
Harley Davidson FX Super Glide	1971-1975
Harley Davidson FXE Super Glide	1974-1975
Harley Davidson XLCH	1972-1975
Harley Davidson XLH1000	1972-1975
Harley Davidson XLH900	1971



◀ **cod. H1075**
Harley-Davidson 17.8A Systems
12 Volt, Shunt-Type, 14.5 Vset

MAKE / MODEL	YEAR
Harley Davidson FLH Electra Glide	1976-1980
Harley Davidson FLT Tour Glide	1980



◀ **cod. H1075C**
Harley-Davidson 17.8A System
12 Volt, Shunt-Type, 14.5 Vset

MAKE / MODEL	YEAR
Harley Davidson FLH Electra Glide	1976-1980
Harley Davidson FLT Tour Glide	1980



◀ **cod. H1108**
Harley-Davidson 32A Systems
12 Volt Regulator Rectifier Assembly

MAKE / MODEL	YEAR
Harley Davidson XL1200C Sportster 1200 Custom	2009-2013
Harley Davidson XL1200CA 1200 Custom Limited A	2013
Harley Davidson XL1200CB 1200 Custom Limited B	2013
Harley Davidson XL1200CP 1200 Custom	2011-2013
Harley Davidson XL1200L Sportster 1200 Low	2009-2010
Harley Davidson XL1200N Sportster 1200 Nightster	2009-2012
Harley Davidson XL1200R Sportster 1200 Roadster	2009
Harley Davidson XL1200V Seventy-Two	2012-2013
Harley Davidson XL1200X Forty-Eight	2011-2013
Harley Davidson XL883 Sportster	2009
Harley Davidson XL883C Sportster 883 Custom	2009-2010
Harley Davidson XL883L Sportster 883 Low	2009-2010
Harley Davidson XL883L SuperLow	2011-2013
Harley Davidson XL883N Iron 883	2009-2013
Harley Davidson XL883R Sportster 883 Roadster	2009-2013
Harley Davidson XLR1200X 1200X	2011-2013
Harley Davidson XR1200	2009-2010
Harley Davidson XR1200X	2010



◀ **cod. H1108C**
Harley-Davidson 32A Systems
12 Volt Regulator Rectifier Assembly

MAKE / MODEL	YEAR
Harley Davidson XL1200C Sportster 1200 Custom	2009-2013
Harley Davidson XL1200CA 1200 Custom Limited A	2013
Harley Davidson XL1200CB 1200 Custom Limited B	2013
Harley Davidson XL1200CP 1200 Custom	2011-2013
Harley Davidson XL1200L Sportster 1200 Low	2009-2010
Harley Davidson XL1200N Sportster 1200 Nightster	2009-2012
Harley Davidson XL1200R Sportster 1200 Roadster	2009
Harley Davidson XL1200V Seventy-Two	2012-2013
Harley Davidson XL1200X Forty-Eight	2011-2013
Harley Davidson XL883 Sportster	2009
Harley Davidson XL883C Sportster 883 Custom	2009-2010
Harley Davidson XL883L Sportster 883 Low	2009-2010
Harley Davidson XL883L SuperLow	2011-2013
Harley Davidson XL883N Iron 883	2009-2013
Harley Davidson XL883R Sportster 883 Roadster	2009-2013
Harley Davidson XLR1200X 1200X	2011-2013
Harley Davidson XR1200	2009-2010
Harley Davidson XR1200X	2010



◀ **cod. H1200**
Harley-Davidson Systems
12 Volt, Shunt-Type, 14.5 Vset

MAKE / MODEL	YEAR
Harley Davidson FLSTCI Heritage Softail Classic	2000
Harley Davidson FLSTFI Fat Boy	2000
Harley Davidson FLSTSI Heritage Springer	2000
Harley Davidson FXSTBI Night Train	2000
Harley Davidson FXSTDI Softail Deuce	2000
Harley Davidson FXSTI Softail Standard	2000
Harley Davidson FXSTSI Springer Softail	2000



◀ **cod. H1200C**
Harley-Davidson Systems
12 Volt, Shunt-Type, 14.5 Vset

MAKE / MODEL	YEAR
Harley Davidson FLSTCI Heritage Softail Classic	2000
Harley Davidson FLSTFI Fat Boy	2000
Harley Davidson FLSTSI Heritage Springer	2000
Harley Davidson FXSTBI Night Train	2000
Harley Davidson FXSTDI Softail Deuce	2000
Harley Davidson FXSTI Softail Standard	2000
Harley Davidson FXSTSI Springer Softail	2000



◀ **cod. H1686**
Harley-Davidson 22A Systems
12 Volt, Shunt-Type, 14.5 Vset

MAKE / MODEL	YEAR
Harley Davidson FLH Electra Glide	1981-1985
Harley Davidson FLHC Electra Glide Classic	1981
Harley Davidson FLHS Electra Glide Sport	1981-1988
Harley Davidson FLHTCI Electra Glide Classic	1983-1988
Harley Davidson FLHTI Electra Glide Standard	1986-1987
Harley Davidson FLHX Electra Glide Special	1984-1985
Harley Davidson FXDG Disc Glide	1983
Harley Davidson FXR Super Glide II	1982-1988
Harley Davidson FXRC Low Rider Chrome	1985-1987
Harley Davidson FXRD Sport Glide Grand Touring	1986
Harley Davidson FXRDG Disc Glide	1984
Harley Davidson FXRS Low Glide	1982-1988
Harley Davidson FXRS-SP Low Rider Sport	1986-1988
Harley Davidson FXRT Sport Glide	1983-1988



◀ **cod. H1899**
Harley-Davidson Systems
12 Volt, Shunt-Type, 14.5 Vset

MAKE / MODEL	YEAR
Harley Davidson FXDI Dyna Super Glide	1999-2003
Harley Davidson FXDLI Dyna Low Rider	1999-2003
Harley Davidson FXDS-Conv Dyna Convertible	1999-2000
Harley Davidson FXDWGI Dyna Wide Glide	1999-2003
Harley Davidson FXDX Dyna Super Glide Sport	1999-2003
Harley Davidson FXDXT Dyna Super Glide T-Sport	2001-2003



◀ **cod. H1899C**
Harley-Davidson Systems
12 Volt, Shunt-Type, 14.5 Vset

MAKE / MODEL	YEAR
Harley Davidson FXDI Dyna Super Glide	1999-2003
Harley Davidson FXDLI Dyna Low Rider	1999-2003
Harley Davidson FXDS-Conv Dyna Convertible	1999-2000
Harley Davidson FXDWGI Dyna Wide Glide	1999-2003
Harley Davidson FXDX Dyna Super Glide Sport	1999-2003
Harley Davidson FXDXT Dyna Super Glide T-Sport	2001-2003



◀ **cod. H1988**
Harley-Davidson 32A Systems
12 Volt, Shunt-Type, 14.5 Vset

MAKE / MODEL	YEAR
Harley Davidson FLHRCI Road King Classic	1998
Harley Davidson FLHRI Road King	1996-1997
Harley Davidson FLHS Electra Glide Sport	1989-1993
Harley Davidson FLHTCI Electra Glide Classic	1989-1996
Harley Davidson FLHTCUI Electra Glide Ultra Classic	1989-1996

◀ **cod. H1988** - continued

MAKE / MODEL	YEAR
Harley Davidson FLHTI Electra Glide Standard	1995-1998
Harley Davidson FLSTCI Heritage Softail Classic	1989-1998
Harley Davidson FLSTI Heritage Softail	1989-1990
Harley Davidson FLSTNI Softail Deluxe	1993-1996
Harley Davidson FLSTSI Heritage Springer	1997-1998
Harley Davidson FLTC/I Tour Glide Classic	1989-1991
Harley Davidson FLTCUI Tour Glide Ultra Classic	1989-1996
Harley Davidson FLTRI Road Glide	1998
Harley Davidson FXDI Dyna Super Glide	1995-1998
Harley Davidson FXDLI Dyna Low Rider	1993-1998
Harley Davidson FXDWGI Dyna Wide Glide	1993-1998
Harley Davidson FXLR Low Rider Custom	1989-1994
Harley Davidson FXR Super Glide II	1989-1994
Harley Davidson FXR2	1999
Harley Davidson FXR3	1999
Harley Davidson FXRS Low Glide	1989-1992
Harley Davidson FXRS-Conv Low Rider Sport Convertible	1990-1993
Harley Davidson FXRS-SP Low Rider Sport	1989-1993
Harley Davidson FXRT Sport Glide	1989-1992
Harley Davidson FXSTBI Night Train	1999
Harley Davidson FXSTC Softail Custom	1989-1999
Harley Davidson FXSTI Softail Standard	1989-1991
Harley Davidson FXSTSB Bad Boy	1995-1997
Harley Davidson FXSTSI Springer Softail	1989-1999



◀ **cod. H1988C**
Harley-Davidson 32A Systems
12 Volt, Shunt-Type, 14.5 Vset

MAKE / MODEL	YEAR
Harley Davidson FLHRCI Road King Classic	1998
Harley Davidson FLHRI Road King	1996-1997
Harley Davidson FLHS Electra Glide Sport	1989-1993
Harley Davidson FLHTCI Electra Glide Classic	1989-1996
Harley Davidson FLHTCUI Electra Glide Ultra Classic	1989-1996
Harley Davidson FLHTI Electra Glide Standard	1995-1998
Harley Davidson FLSTCI Heritage Softail Classic	1989-1998
Harley Davidson FLSTI Heritage Softail	1989-1990
Harley Davidson FLSTNI Softail Deluxe	1993-1996
Harley Davidson FLSTSI Heritage Springer	1997-1998
Harley Davidson FLTC/I Tour Glide Classic	1989-1991
Harley Davidson FLTCUI Tour Glide Ultra Classic	1989-1996
Harley Davidson FLTRI Road Glide	1998
Harley Davidson FXDI Dyna Super Glide	1995-1998
Harley Davidson FXDLI Dyna Low Rider	1993-1998
Harley Davidson FXDWGI Dyna Wide Glide	1993-1998
Harley Davidson FXLR Low Rider Custom	1989-1994
Harley Davidson FXR Super Glide II	1989-1994
Harley Davidson FXR2	1999
Harley Davidson FXR3	1999
Harley Davidson FXRS Low Glide	1989-1992
Harley Davidson FXRS-Conv Low Rider Sport Convertible	1990-1993

◀ cod. **H1988C** - continued

MAKE / MODEL	YEAR
Harley Davidson FXRS-SP Low Rider Sport	1989-1993
Harley Davidson FXRT Sport Glide	1989-1992
Harley Davidson FXSTBI Night Train	1999
Harley Davidson FXSTC Softail Custom	1989-1999
Harley Davidson FXSTI Softail Standard	1989-1991
Harley Davidson FXSTSB Bad Boy	1995-1997
Harley Davidson FXSTSI Springer Softail	1989-1999



◀ cod. **H2304**

Harley-Davidson 22A Systems
12 Volt Regulator Rectifier Assembly

MAKE / MODEL	YEAR
Harley Davidson XL1200C Sportster 1200 Custom	2004-2006
Harley Davidson XL1200L Sportster 1200 Low	2006
Harley Davidson XL1200R Sportster 1200 Roadster	2004-2006
Harley Davidson XL883 Sportster	2004-2006
Harley Davidson XL883C Sportster 883 Custom	2004-2006
Harley Davidson XL883L Sportster 883 Low	2005-2006
Harley Davidson XL883R Sportster 883 Roadster	2005-2006



◀ cod. **H2304C**

Harley-Davidson 22A Systems
12 Volt Regulator Rectifier Assembly

MAKE / MODEL	YEAR
Harley Davidson XL1200C Sportster 1200 Custom	2004-2006
Harley Davidson XL1200L Sportster 1200 Low	2006
Harley Davidson XL1200R Sportster 1200 Roadster	2004-2006
Harley Davidson XL883 Sportster	2004-2006
Harley Davidson XL883C Sportster 883 Custom	2004-2006
Harley Davidson XL883L Sportster 883 Low	2005-2006
Harley Davidson XL883R Sportster 883 Roadster	2005-2006



◀ cod. **H2384**

Harley-Davidson Systems
12 Volt, Shunt-Type, 14.5 Vset

MAKE / MODEL	YEAR
Harley Davidson XLH1000	1984-1985
Harley Davidson XLH1100	1986
Harley Davidson XLH883	1986
Harley Davidson XLH883DLX Sportster 883 Deluxe	1986
Harley Davidson XLX 1000	1984-1985
Harley Davidson XR1000	1984-1985



◀ **cod. H2386**
Harley-Davidson 19A Systems
12 Volt, Shunt-Type, 14.5 Vset

MAKE / MODEL	YEAR
Harley Davidson XLH1100	1986-1987
Harley Davidson XLH1200	1988-1990
Harley Davidson XLH883	1986-1990
Harley Davidson XLH883DLX Sportster 883 Deluxe	1986-1990
Harley Davidson XLH883HUG Sportster 883 Hugger	1987-1990



◀ **cod. H2386C**
Harley-Davidson 19A Systems
12 Volt, Shunt-Type, 14.5 Vset

MAKE / MODEL	YEAR
Harley Davidson XLH1100	1986-1987
Harley Davidson XLH1200	1988-1990
Harley Davidson XLH883	1986-1990
Harley Davidson XLH883DLX Sportster 883 Deluxe	1986-1990
Harley Davidson XLH883HUG Sportster 883 Hugger	1987-1990



◀ **cod. H2391**
Harley-Davidson 32A Systems
12 Volt, Shunt-Type, 14.5 Vset

MAKE / MODEL	YEAR
Harley Davidson XLH1200	1991
Harley Davidson XLH883	1991
Harley Davidson XLH883DLX Sportster 883 Deluxe	1991
Harley Davidson XLH883HUG Sportster 883 Hugger	1991



◀ **cod. H2391C**
Harley-Davidson 32A Systems
12 Volt, Shunt-Type, 14.5 Vset

MAKE / MODEL	YEAR
Harley Davidson XLH1200	1991
Harley Davidson XLH883	1991
Harley Davidson XLH883DLX Sportster 883 Deluxe	1991
Harley Davidson XLH883HUG Sportster 883 Hugger	1991



◀ **cod. H2392**
Harley-Davidson Systems
12 Volt, Shunt-Type, 14.5 Vset

MAKE / MODEL	YEAR
Harley Davidson XLH1200	1992-1993
Harley Davidson XLH883	1992-1993
Harley Davidson XLH883DLX Sportster 883 Deluxe	1992-1993
Harley Davidson XLH883HUG Sportster 883 Hugger	1992-1993



◀ **cod. H2392C**
Harley-Davidson Systems
12 Volt, Shunt-Type, 14.5 Vset

MAKE / MODEL	YEAR
Harley Davidson XLH1200	1992-1993
Harley Davidson XLH883	1992-1993
Harley Davidson XLH883DLX Sportster 883 Deluxe	1992-1993
Harley Davidson XLH883HUG Sportster 883 Hugger	1992-1993



◀ **cod. H2394**
Harley-Davidson Systems
12 Volt, Shunt-Type, 14.5 Vset

MAKE / MODEL	YEAR
Harley Davidson XL1200C Sportster 1200 Custom	1996-2003
Harley Davidson XL1200S Sportster 1200 Sport	1996-2003
Harley Davidson XL883C Sportster 883 Custom	1998-2003
Harley Davidson XL883R Sportster 883 Roadster	2002-2003
Harley Davidson XLH1200	1994-2003
Harley Davidson XLH883	1994-2003
Harley Davidson XLH883DLX Sportster 883 Deluxe	1994-1995
Harley Davidson XLH883HUG Sportster 883 Hugger	1994-2003



◀ **cod. H2394C**
Harley-Davidson Systems
12 Volt, Shunt-Type, 14.5 Vset

MAKE / MODEL	YEAR
Harley Davidson XL1200C Sportster 1200 Custom	1996-2003
Harley Davidson XL1200S Sportster 1200 Sport	1996-2003
Harley Davidson XL883C Sportster 883 Custom	1998-2003
Harley Davidson XL883R Sportster 883 Roadster	2002-2003
Harley Davidson XLH1200	1994-2003
Harley Davidson XLH883	1994-2003
Harley Davidson XLH883DLX Sportster 883 Deluxe	1994-1995
Harley Davidson XLH883HUG Sportster 883 Hugger	1994-2003



◀ **cod. H3104**
Harley-Davidson 32A, Three-Phase Systems
12 Volt Regulator Rectifier Assembly

MAKE / MODEL	YEAR
Harley Davidson FXD Dyna Super Glide	2005
Harley Davidson FXDC Super Glide Custom	2005
Harley Davidson FXDCI Super Glide Custom	2005
Harley Davidson FXDI Dyna Super Glide	2004-2005
Harley Davidson FXDL Dyna Low Rider	2005
Harley Davidson FXDLI Dyna Low Rider	2004-2005
Harley Davidson FXDWG Dyna Wide Glide	2005
Harley Davidson FXDWGI Dyna Wide Glide	2004-2005
Harley Davidson FXDX Dyna Super Glide Sport	2004-2005
Harley Davidson FXDXI Dyna Super Glide Sport	2004-2005





◀ **cod. H3104C**
Harley-Davidson 32A, Three-Phase Systems
12 Volt Regulator Rectifier Assembly

MAKE / MODEL	YEAR
Harley Davidson FXD Dyna Super Glide	2005
Harley Davidson FXDC Super Glide Custom	2005
Harley Davidson FXDCI Super Glide Custom	2005
Harley Davidson FXDI Dyna Super Glide	2004-2005
Harley Davidson FXDL Dyna Low Rider	2005
Harley Davidson FXDLI Dyna Low Rider	2004-2005
Harley Davidson FXDWG Dyna Wide Glide	2005
Harley Davidson FXDWGI Dyna Wide Glide	2004-2005
Harley Davidson FXDX Dyna Super Glide Sport	2004-2005
Harley Davidson FXDXI Dyna Super Glide Sport	2004-2005



◀ **cod. H3106**
Harley-Davidson 38A, Three-Phase Systems
12 Volt Regulator Rectifier Assembly

MAKE / MODEL	YEAR
Harley Davidson FXD Dyna Super Glide	2007
Harley Davidson FXD35 Super Golden Anniversary	2006
Harley Davidson FXDB Street Bob	2007
Harley Davidson FXDBA Street Bob	2006
Harley Davidson FXDBI Street Bob	2006
Harley Davidson FXDC Super Glide Custom	2007
Harley Davidson FXDCI Super Glide Custom	2006
Harley Davidson FXDI Dyna Super Glide	2006-2007
Harley Davidson FXDI35 Dyna 35th Anniversary Super Glide	2006
Harley Davidson FXDL Dyna Low Rider	2006-2007
Harley Davidson FXDLI Dyna Low Rider	2006-2007
Harley Davidson FXDSE Screamin Eagle Dyna	2007
Harley Davidson FXDWG Dyna Wide Glide	2007
Harley Davidson FXDWGI Dyna Wide Glide	2006-2007



◀ **cod. H3106C**
Harley-Davidson 38A, Three-Phase Systems
12 Volt Regulator Rectifier Assembly

MAKE / MODEL	YEAR
Harley Davidson FXD Dyna Super Glide	2007
Harley Davidson FXD35 Super Golden Anniversary	2006
Harley Davidson FXDB Street Bob	2007
Harley Davidson FXDBA Street Bob	2006
Harley Davidson FXDBI Street Bob	2006
Harley Davidson FXDC Super Glide Custom	2007
Harley Davidson FXDCI Super Glide Custom	2006
Harley Davidson FXDI Dyna Super Glide	2006-2007
Harley Davidson FXDI35 Dyna 35th Anniversary Super Glide	2006
Harley Davidson FXDL Dyna Low Rider	2006-2007
Harley Davidson FXDLI Dyna Low Rider	2006-2007
Harley Davidson FXDSE Screamin Eagle Dyna	2007
Harley Davidson FXDWG Dyna Wide Glide	2007
Harley Davidson FXDWGI Dyna Wide Glide	2006-2007

◀ cod. **H3108**

Harley-Davidson 40A, Three-Phase Systems
12 Volt Regulator Rectifier Assembly



MAKE / MODEL	YEAR
Harley Davidson FLD Switchback	2012-2014
Harley Davidson FXD Dyna Super Glide	2008-2010
Harley Davidson FXDB Street Bob	2009-2014
Harley Davidson FXDBA Street Bob	2013
Harley Davidson FXDBP Street Bob	2013-2014
Harley Davidson FXDC Super Glide Custom	2008-2014
Harley Davidson FXDF Fat Bob	2008-2014
Harley Davidson FXDFSE CVO Dyna Fat Bob	2009
Harley Davidson FXDI Dyna Super Glide	2008-2009
Harley Davidson FXDL Dyna Low Rider	2008-2011
Harley Davidson FXDLI Dyna Low Rider	2008-2009
Harley Davidson FXDSE2 Screamin Eagle Dyna	2008
Harley Davidson FXDWG Dyna Wide Glide	2008-2014
Harley Davidson FXDWGI Dyna Wide Glide	2008

◀ cod. **H3108C**

Harley-Davidson 40A, Three-Phase Systems
12 Volt Regulator Rectifier Assembly



MAKE / MODEL	YEAR
Harley Davidson FLD Switchback	2012-2014
Harley Davidson FXD Dyna Super Glide	2008-2010
Harley Davidson FXDB Street Bob	2008-2014
Harley Davidson FXDBA Street Bob	2013
Harley Davidson FXDBP Street Bob	2013-2014
Harley Davidson FXDC Super Glide Custom	2008-2014
Harley Davidson FXDF Fat Bob	2008-2014
Harley Davidson FXDFSE CVO Dyna Fat Bob	2009
Harley Davidson FXDI Dyna Super Glide	2008-2009
Harley Davidson FXDL Dyna Low Rider	2008-2011
Harley Davidson FXDLI Dyna Low Rider	2008-2009
Harley Davidson FXDSE2 Screamin Eagle Dyna	2008
Harley Davidson FXDWG Dyna Wide Glide	2008-2014
Harley Davidson FXDWGI Dyna Wide Glide	2008

◀ cod. **H4007**

Harley-Davidson 40A, Three-Phase Systems
12 Volt Regulator Rectifier Assembly



MAKE / MODEL	YEAR
Harley Davidson FLSTC Heritage Softail Classic	2007
Harley Davidson FLSTCI Heritage Softail Classic	2007
Harley Davidson FLSTF Fat Boy	2007
Harley Davidson FLSTFI Fat Boy	2007
Harley Davidson FLSTN Softail Deluxe	2007
Harley Davidson FLSTNI Softail Deluxe	2007
Harley Davidson FLSTSC Softail Springer Classic	2007
Harley Davidson FLSTSCI Softail Springer Classic	2007

◀ **cod. H4007** - continued

MAKE / MODEL	YEAR
Harley Davidson FXST Softail Standard	2007
Harley Davidson FXSTB Night Train	2007
Harley Davidson FXSTBI Night Train	2007
Harley Davidson FXSTC Softail Custom	2007
Harley Davidson FXSTD Softail Deuce	2007
Harley Davidson FXSTDI Softail Deuce	2007
Harley Davidson FXSTI Softail Standard	2007
Harley Davidson FXSTSSE Screamin Eagle Softail Springer	2007



◀ **cod. H4007C**
Harley-Davidson 40A, Three-Phase Systems
12 Volt Regulator Rectifier Assembly

MAKE / MODEL	YEAR
Harley Davidson FLSTC Heritage Softail Classic	2007
Harley Davidson FLSTCI Heritage Softail Classic	2007
Harley Davidson FLSTF Fat Boy	2007
Harley Davidson FLSTFI Fat Boy	2007
Harley Davidson FLSTN Softail Deluxe	2007
Harley Davidson FLSTNI Softail Deluxe	2007
Harley Davidson FLSTSC Softail Springer Classic	2007
Harley Davidson FLSTSCI Softail Springer Classic	2007
Harley Davidson FXST Softail Standard	2007
Harley Davidson FXSTB Night Train	2007
Harley Davidson FXSTBI Night Train	2007
Harley Davidson FXSTC Softail Custom	2007
Harley Davidson FXSTD Softail Deuce	2007
Harley Davidson FXSTDISoftail Deuce	2007
Harley Davidson FXSTI Softail Standard	2007
Harley Davidson FXSTSSE Screamin Eagle Softail Springer	2007

◀ **cod. H4008**
Harley-Davidson 40A, Three-Phase Systems
12 Volt Regulator Rectifier Assembly

MAKE / MODEL	YEAR
Harley Davidson FLSTB Softail Fat Boy Special	2010
Harley Davidson FLSTC Heritage Softail Classic	2008-2010
Harley Davidson FLSTCI Heritage Softail Classic	2008-2009
Harley Davidson FLSTF Fat Boy	2008-2010
Harley Davidson FLSTFI Fat Boy	2008-2009
Harley Davidson FLSTN Softail Deluxe	2008-2010
Harley Davidson FLSTNI Softail Deluxe	2008-2009
Harley Davidson FLSTSB Cross Bones	2008-2010
Harley Davidson FXCW Rocker	2008-2009
Harley Davidson FXCWC Rocker C	2008-2010
Harley Davidson FXST Softail Standard	2008
Harley Davidson FXSTB Night Train	2008
Harley Davidson FXSTBI Night Train	2008-2009
Harley Davidson FXSTC Softail Custom	2008-2010
Harley Davidson FXSTSSE2 Screamin Eagle Softail Springer	2008
Harley Davidson FXSTSSE3 CVO Softail Springer	2009





◀ **cod. H4008C**
Harley-Davidson 40A, Three-Phase Systems
12 Volt Regulator Rectifier Assembly

MAKE / MODEL	YEAR
Harley Davidson FLSTB Softail Fat Boy Special	2010
Harley Davidson FLSTC Heritage Softail Classic	2008-2010
Harley Davidson FLSTCI Heritage Softail Classic	2008-2009
Harley Davidson FLSTF Fat Boy	2008-2010
Harley Davidson FLSTFI Fat Boy	2008-2009
Harley Davidson FLSTN Softail Deluxe	2008-2010
Harley Davidson FLSTNI Softail Deluxe	2008-2009
Harley Davidson FLSTSB Cross Bones	2008-2010
Harley Davidson FXCW Rocker	2008-2009
Harley Davidson FXCWC Rocker C	2008-2010
Harley Davidson FXST Softail Standard	2008
Harley Davidson FXSTB Night Train	2008
Harley Davidson FXSTBI Night Train	2008-2009
Harley Davidson FXSTC Softail Custom	2008-2010
Harley Davidson FXSTSSE2 Screamin Eagle Softail Springer	2008
Harley Davidson FXSTSSE3 CVO Softail Springer	2009



◀ **cod. H4408**
Harley Davidson Motorcycle
12 Volt Regulator Rectifier Assembly

MAKE / MODEL	YEAR
Harley Davidson VRSCAW V-Rod	2008-2010
Harley Davidson VRSCD Night Rod	2008
Harley Davidson VRSCDX ANN V-Rod Anniversary Edition	2012
Harley Davidson VRSCDX Night Rod Special	2008-2014
Harley Davidson VRSCF V-Rod Muscle	2009-2014



◀ **cod. H4408C**
Harley Davidson Motorcycle
12 Volt Regulator Rectifier Assembly

MAKE / MODEL	YEAR
Harley Davidson VRSCAW V-Rod	2008-2010
Harley Davidson VRSCD Night Rod	2008
Harley Davidson VRSCDX ANN V-Rod Anniversary Edition	2012
Harley Davidson VRSCDX Night Rod Special	2008-2014
Harley Davidson VRSCF V-Rod Muscle	2009-2014



◀ **cod. H4607**
Harley-Davidson 32A Systems
12 Volt Regulator Rectifier Assembly

MAKE / MODEL	YEAR
Harley Davidson XL1200C Sportster 1200 Custom	2007-2008
Harley Davidson XL1200L Sportster 1200 Low	2007-2008
Harley Davidson XL1200N Sportster 1200 Nightster	2007-2008
Harley Davidson XL1200R Sportster 1200 Roadster	2007-2008
Harley Davidson XL50 50th Anniversary Sportster	2007
Harley Davidson XL883 Sportster	2007-2008
Harley Davidson XL883C Sportster 883 Custom	2007-2008
Harley Davidson XL883L Sportster 883 Low	2007-2008
Harley Davidson XL883R Sportster 883 Roadster	2007-2008



◀ **cod. H4607C**
Harley-Davidson 32A Systems
12 Volt Regulator Rectifier Assembly

MAKE / MODEL	YEAR
Harley Davidson XL1200C Sportster 1200 Custom	2007-2008
Harley Davidson XL1200L Sportster 1200 Low	2007-2008
Harley Davidson XL1200N Sportster 1200 Nightster	2007-2008
Harley Davidson XL1200R Sportster 1200 Roadster	2007-2008
Harley Davidson XL50 50th Anniversary Sportster	2007
Harley Davidson XL883 Sportster	2007-2008
Harley Davidson XL883C Sportster 883 Custom	2007-2008
Harley Davidson XL883L Sportster 883 Low	2007-2008
Harley Davidson XL883R Sportster 883 Roadster	2007-2008



◀ **cod. HN1004N**
Honda Applications
12 Volt Regulator Rectifier Assembly

MAKE / MODEL	YEAR
Honda CRF230F	2003-2004
Honda SA50 Elite SR	1994-2001
Honda SA50P Elite S	1994-2001



◀ **cod. HN1005N**
Honda Applications
12 Volt Regulator Rectifier Assembly

MAKE / MODEL	YEAR
Honda CBR900RR	2002-2003



◀ cod. **HN1006N**

Honda Applications
12 Volt Regulator Rectifier Assembly

MAKE / MODEL	YEAR
Honda CBR1000RR	2008-2013
Honda NC700X	2012



◀ cod. **HN1007N**

Honda Applications
12 Volt Regulator Rectifier Assembly

MAKE / MODEL	YEAR
Honda NTV650V	1998-2005
Honda VT125 Shadow	2001-2007
Husqvarna SMS 125	2011-2013
Husqvarna TE250	2008-2012
Husqvarna TE310	2011-2012
Husqvarna TXC 250	2008-2012
Husqvarna WRE 125	2011-2013



◀ cod. **HN1008N**

Honda Applications
12 Volt Regulator Rectifier Assembly

MAKE / MODEL	YEAR
Honda NX650	1988-1989



◀ cod. **HN1009N**

Honda Applications
12 Volt Regulator Rectifier Assembly

MAKE / MODEL	YEAR
Honda CBR1000RR	2004-2005



◀ **cod. HN1010N**
Honda Applications
12 Volt Regulator Rectifier Assembly

MAKE / MODEL	YEAR
Aprilia RXV 450	2006-2012
Aprilia RXV 550	2006-2012
Aprilia SXV 450	2006-2012
Aprilia SXV 550	2006-2012
Honda CB250 Nighthawk	1991-2001
Honda CB600F 599	2004-2006
Honda FES250 Foresight	1998-2005
Honda NSS250 Reflex	2001-2003
Honda NSS250A Reflex ABS	2001-2003
Honda VT750C Shadow Aero	2001
Honda VT750C/CD Shadow ACE	2002-2003



◀ **cod. HN1011N**
Honda Applications
12 Volt Regulator Rectifier Assembly

MAKE / MODEL	YEAR
Honda CBR600F	1990
Honda CBR600F Hurricane	1987-1989



◀ **cod. HN1012N**
Honda Applications
12 Volt Regulator Rectifier Assembly

MAKE / MODEL	YEAR
Honda SH300iA	2007-2010
Honda SH300iR	2008-2010



◀ **cod. HN1014N**
Honda Applications
12 Volt Regulator Rectifier Assembly

MAKE / MODEL	YEAR
Honda CB1000	1994-1995
Honda CB750 Nighthawk	1991-2003
Honda CBR1000F	1993-1996
Honda CBR1000F Hurricane	1990-1991
Honda ST1100	1991-1995
Honda ST1100 ABS	1992-1995



◀ **cod. HN1015N**
Honda Applications
12 Volt Regulator Rectifier Assembly

MAKE / MODEL	YEAR
Honda TRX350FE FourTrax Rancher 4x4 ES	2000-2003
Honda TRX350FM FourTrax Rancher 4X4	2000-2003
Honda TRX350TE FourTrax Rancher ES	2000-2003
Honda TRX350TM FourTrax Rancher	2000-2003
Honda TRX400FW Foreman 4x4	1995-2003
Honda TRX450ES	1998-2001
Honda TRX450R	2004-2005
Honda TRX450S	1998-2001
Honda VT750C Shadow Aero	2004-2009
Honda VT750C2 Shadow Spirit	2007-2009
Honda VT750C2F	2007-2008
Honda VT750CA	2004-2009



◀ **cod. HN1017**
Honda Applications
12 Volt Regulator Rectifier Assembly

MAKE / MODEL	YEAR
Honda CB400A Hondamatic	1978
Honda CB400T Hawk	1980-1981
Honda CB400TI Hawk I	1978-1979
Honda CB400TII Hawk II	1978-1979
Honda CB450SC Nighthawk	1982-1986
Honda CB450T Hawk	1982
Honda CH125 Elite	1984
Honda CH150 Elite	1987
Honda CM200T Twinstar	1981-1982
Honda CM400A Hondamatic	1979-1981
Honda CM400C Custom	1981
Honda CM400E	1980-1981
Honda CM400T	1979-1981
Honda CM450A Hondamatic	1982-1983
Honda CM450C Custom	1982
Honda CM450E	1982
Honda CMX450C Rebel	1986-1987
Honda CN250 Helix	2004-2007
Honda FT500 Ascot	1982-1983
Honda GB500	1989-1990

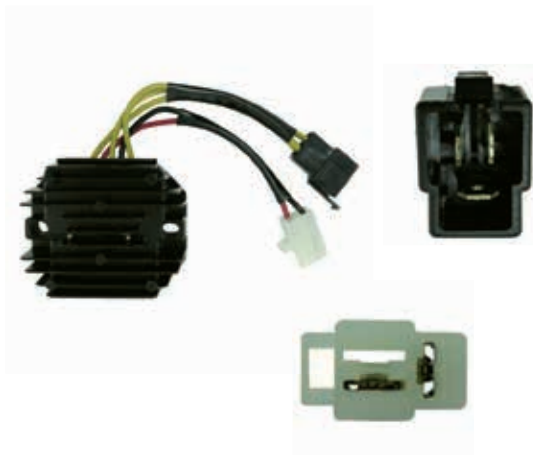

◀ **cod. HN1018**
Honda Applications
12 Volt Regulator Rectifier Assembly

MAKE / MODEL	YEAR
Honda CB400F Super Sport	1975-1977
Honda CB550F Super Sport	1975-1977
Honda CB550K	1975-1978
Honda CB750A Automatic	1976-1977
Honda CB750F Super Sport	1975-1978
Honda CB750K	1975-1978



◀ **cod. HN1020**
Honda Applications
12 Volt Regulator Rectifier Assembly

MAKE / MODEL	YEAR
Honda CB650	1979-1982
Honda CB650C Custom	1980-1981
Honda CB650SC Nighthawk	1982
Honda CBR1000F Hurricane	1987-1988



◀ **cod. HN1021**
Honda Applications
12 Volt Regulator Rectifier Assembly

MAKE / MODEL	YEAR
Honda CB1000C Custom	1983
Honda CB1100F	1983
Honda CB700SC Nighthawk S	1984-1986
Honda CB750C Custom	1980-1982
Honda CB750F Super Sport	1979-1982
Honda CB750K	1979-1982
Honda CB750L	1979
Honda CB750SC Nighthawk	1982-1983
Honda CB900C Custom	1980-1982
Honda CB900F Super Sport	1981-1982
Honda CBX	1979-1982



◀ **cod. HN1022**
Honda Applications
12 Volt Regulator Rectifier Assembly

MAKE / MODEL	YEAR
Honda VT1100C Shadow	1987-1996
Honda VT1100C Shadow Spirit	1987-2003
Honda VT1100C2 Shadow Sabre	2000-2003
Honda VT1100C3 Shadow Aero	1988-2002
Honda VT1100T Shadow ACE Tour	1998-2001



◀ **cod. HN1023**
Honda Applications
12 Volt Regulator Rectifier Assembly

MAKE / MODEL	YEAR
Honda MUV700 Big Red	2009-2013
Honda TRX420FA Rancher AT	2009-2013
Honda TRX420FA1 FourTrax Rancher 4x4 Auto DCT	2014
Honda TRX420FA2 FourTrax Rancher 4x4 Auto DCT with EPS	2014
Honda TRX420FE FourTrax Rancher 4X4 ES	2007-2013
Honda TRX420FM FourTrax Rancher 4X4	2007-2013
Honda TRX420FPA Rancher AT 4x4 w/ Power Steering	2009-2014
Honda TRX420FPE Rancher ES 4x4 w/ Power Steering	2009-2013
Honda TRX420FPM Rancher 4x4 w/ Power Steering	2009-2013
Honda TRX420TE FourTrax Rancher ES	2007-2013
Honda TRX420TM FourTrax Rancher	2007-2013



cod. **KM1000**

KTM Applications

12 Volt Regulator Rectifier Assembly

MAKE / MODEL	YEAR
Beta 250 RR (2 Stroke)	2005-2007
Beta 400 RR	2005-2012
Beta 450 RR	2005-2012
Beta 498 RR	2013
KTM 125 EXC	2005-2013
KTM 200 EXC	2005-2014
KTM 200 XC-W	2008-2015
KTM 250 EXC	2005-2015
KTM 250 EXC-F	2007-2011
KTM 250 XC	2009-2015
KTM 250 XC-F	2007-2010
KTM 250 XCF-W	2006-2011
KTM 250 XC-W	2008-2015
KTM 300 EXC	2005-2015
KTM 300 EXC-E	2007-2010
KTM 300 XC	2009-2015
KTM 300 XC-W	2008-2015
KTM 350 EXC-F	2015
KTM 400 EXC	2005-2011
KTM 400 XC-W	2007-2010
KTM 450 EXC	2005-2011
KTM 450 EXC-R	2008
KTM 450 MXC	2005
KTM 450 XC	2006-2007
KTM 450 XC-W	2007-2011
KTM 525 EXC	2005-2007
KTM 525 MXC	2005
KTM 525 XC	2006-2007
KTM 530 EXC	2008-2011
KTM 530 EXC-R	2008
KTM 530 XCR-W	2008
KTM 530 XC-W	2009-2011
KTM 660 SMC	2004-2006



cod. **KW1000N**

Kawasaki Applications

12 Volt Regulator Rectifier Assembly

MAKE / MODEL	YEAR
Kawasaki ZX600 Ninja ZX6-RR	2003-2004
Kawasaki ZX636 Ninja ZX-6R	2003-2004



cod. **KW1002N**

Kawasaki Applications

12 Volt Regulator Rectifier Assembly

MAKE / MODEL	YEAR
Kawasaki ZX900 Ninja ZX-9R	1998-1999



◀ **cod. KW1006N**
Kawasaki Applications
12 Volt Regulator Rectifier Assembly

MAKE / MODEL	YEAR
Kawasaki ER5	1999-2002



◀ **cod. KW1009N**
Kymco Applications
12 Volt Regulator Rectifier Assembly

MAKE / MODEL	YEAR
Kymco Downtown 300i	2011-2015
Kymco People S 250	2007-2009
Kymco Venox 250	2003-2006
Kymco Xciting 500	2005



◀ **cod. KW1010N**
Kawasaki Applications
12 Volt Regulator Rectifier Assembly

MAKE / MODEL	YEAR
Kawasaki ER-6N	2009-2010
Kawasaki EX650 Ninja 650R	2006-2011
Kawasaki KAF620 Mule 3000	2001-2008
Kawasaki KAF620 Mule 3010 4x4	2001-2008
Kawasaki KAF620 Mule 3010 Trans 4x4	2005-2008
Kawasaki KLE650 Versys	2008-2010
Kawasaki KLF400 Bayou 4x4	1993-1999
Kawasaki KVF400 Prairie 4x4	1997-1998
Kawasaki KVF650 Brute Force 4x4i	2007-2008
Kawasaki KVF750 Brute Force 4x4i	2005-2007
Kawasaki VN900B Vulcan 900 Classic	2006-2014
Kawasaki VN900C Vulcan 900 Custom	2007-2014
Kawasaki VN900D Vulcan 900 Classic LT	2006-2014
Kawasaki Z1000	2003-2013
Kawasaki Z750S	2005-2006
Kawasaki ZX1000 Ninja 1000	2011-2013
Kawasaki ZX1000 Ninja 1000 ABS	2012-2013



◀ **cod. KW1019N**
Kawasaki Applications
12 Volt Regulator Rectifier Assembly

MAKE / MODEL	YEAR
Kawasaki ZX600 Ninja ZX-6R	2000-2002
Kawasaki ZZR 600	2005-2008



◀ cod. **KW1021N**

Kawasaki Applications
12 Volt Regulator Rectifier Assembly

MAKE / MODEL	YEAR
Kawasaki EX500 Ninja 500	1994-1996
Kawasaki KLR650	1987-2001
Kawasaki VN700A Vulcan	1985
Kawasaki VN750A Vulcan 750	1986-2001
Kawasaki VN800A Vulcan 800	1999-2002
Kawasaki ZX600 Ninja 600R	1985-1997
Kawasaki ZX600 Ninja ZX-6R	1995-2001



◀ cod. **PL1011N**

Aprilia Motorcycles
12 Volt Regulator Rectifier Assembly

MAKE / MODEL	YEAR
Aprilia Classic 125	1995-1999
Aprilia Leonardo 125	1996-2004
Aprilia Leonardo 150	1996-2004
Aprilia Pegaso 600	1990-1991
Aprilia Pegaso 650	1992-1995
Aprilia RS 125	1996-2009
Aprilia RS 250	1998-2001
Aprilia Scarabeo 125	1999-2003
Aprilia Scarabeo 150	1999-2003
Aprilia SX 125	2008



◀ cod. **S1002GL**

Honda Applications
12 Volt, Shunt-Type, 14.4 Vset

MAKE / MODEL	YEAR
Honda GL1100 Gold Wing	1980-1983
Honda GL1100A Gold Wing Aspencade	1982-1983
Honda GL1100I Gold Wing Interstate	1980-1983
Honda GL1200 Gold Wing	1984
Honda GL1200A Gold Wing Aspencade	1984-1987
Honda GL1200I Gold Wing Interstate	1984-1987
Honda GL1200L Gold Wing Limited	1985
Honda GL1200SEI Gold Wing Aspencade	1986



◀ cod. **S1002GL-135**

Honda Applications
12 Volt, Shunt-Type, 13.5 Vset

MAKE / MODEL	YEAR
Honda GL1100 Gold Wing	1980-1983
Honda GL1100A Gold Wing Aspencade	1982-1983
Honda GL1100I Gold Wing Interstate	1980-1983
Honda GL1200 Gold Wing	1984
Honda GL1200A Gold Wing Aspencade	1984-1987
Honda GL1200I Gold Wing Interstate	1984-1987
Honda GL1200L Gold Wing Limited	1985
Honda GL1200SEI Gold Wing Aspencade	1986



◀ **cod. S1002L**
Suzuki Applications
12 Volt, Shunt-Type, 14.6 Vset

MAKE / MODEL	YEAR
Suzuki GS1100E	1983
Suzuki GS1100ES	1983
Suzuki GS1100G	1983
Suzuki GS1100GK	1983
Suzuki GS1100GL	1983
Suzuki GS1100S Katana	1983
Suzuki GS550E	1983-1986
Suzuki GS650G	1983
Suzuki GS650GL	1983
Suzuki GS650M Katana	1983
Suzuki GS850G	1982
Suzuki GS850GL	1982



◀ **cod. S1002S**
Suzuki Applications
12 Volt, Shunt-Type, 14.6 Vset

MAKE / MODEL	YEAR
Suzuki GR650 Tempter	1983
Suzuki GS1150E	1984-1986
Suzuki GS1150ES	1985
Suzuki GS300L	1983-1985
Suzuki GS450E	1983
Suzuki GS450GA	1983-1985
Suzuki GS450L	1983-1986
Suzuki GS450TX	1983
Suzuki GS750E	1983
Suzuki GS750ES	1983
Suzuki GS750S Katana	1983
Suzuki GS750T	1983



◀ **cod. S1002U**
Kawasaki, Suzuki, Yamaha
12 Volt, Shunt-Type, 14.6 Vset

MAKE / MODEL	YEAR
Suzuki GR650 Tempter	1983
Suzuki GS1100E	1983
Suzuki GS1100ES	1983
Suzuki GS1100G	1983
Suzuki GS1100GK	1983
Suzuki GS1100GL	1983
Suzuki GS1100S Katana	1983
Suzuki GS1150E	1984-1986
Suzuki GS1150ES	1985
Suzuki GS300L	1983-1985
Suzuki GS450E	1983
Suzuki GS450GA	1983-1985
Suzuki GS450L	1983-1986
Suzuki GS450TX	1983

◀ cod. **S1002U** - continued

MAKE / MODEL	YEAR
Suzuki GS550E	1983-1986
Suzuki GS650G	1983
Suzuki GS650GL	1983
Suzuki GS650M Katana	1983
Suzuki GS750E	1983
Suzuki GS750ES	1983
Suzuki GS750S Katana	1983
Suzuki GS750T	1983
Suzuki GS850G	1982
Suzuki GS850GL	1982



◀ cod. **S1002UH** Honda, Kawasaki, Suzuki 12 Volt, Shunt-Type, 14.6 Vset

MAKE / MODEL	YEAR
Suzuki GR650 Tempter	1983
Suzuki GS1100E	1983
Suzuki GS1100ES	1983
Suzuki GS1100G	1983
Suzuki GS1100GK	1983
Suzuki GS1100GL	1983
Suzuki GS1100S Katana	1983
Suzuki GS1150E	1984-1986
Suzuki GS1150ES	1985
Suzuki GS300L	1983-1985
Suzuki GS450E	1983
Suzuki GS450GA	1983-1985
Suzuki GS450L	1983-1986
Suzuki GS450TX	1983
Suzuki GS550E	1983-1986
Suzuki GS650G	1983
Suzuki GS650GL	1983
Suzuki GS650M Katana	1983
Suzuki GS750E	1983
Suzuki GS750ES	1983
Suzuki GS750S Katana	1983
Suzuki GS750T	1983
Suzuki GS850G	1982
Suzuki GS850GL	1982



◀ cod. **S1003L** Honda Applications 12 Volt, Shunt-Type, 14.7 Vset

MAKE / MODEL	YEAR
Honda CB750C Custom	1980-1982
Honda CB750F Super Sport	1979-1982
Honda CB750K	1979-1982
Honda CB750L	1979
Honda CB750SC Nighthawk	1982
Honda CB900C Custom	1980-1982
Honda CB900F Super Sport	1981-1982
Honda CBX	1981-1982



◀ **cod. S1003S**
Honda Applications
12 Volt, Shunt-Type, 14.7 Vset

MAKE / MODEL	YEAR
Honda CB650	1979-1982
Honda CB650C Custom	1980-1981
Honda CB650SC Nighthawk	1982



◀ **cod. S1003U**
Honda Applications
12 Volt, Shunt-Type, 14.7 Vset

MAKE / MODEL	YEAR
Honda CB650	1979-1982
Honda CB650C Custom	1980-1981
Honda CB650SC Nighthawk	1982
Honda CB750C Custom	1980-1982
Honda CB750F Super Sport	1979-1982
Honda CB750K	1979-1982
Honda CB750L	1979
Honda CB750SC Nighthawk	1982
Honda CB900C Custom	1980-1982
Honda CB900F Super Sport	1981-1982
Honda CBX	1981-1982
Yamaha XS650	1975-1981
Yamaha XS650-2 Special II	1979
Yamaha XS650S Special	1978-1983



◀ **cod. S1003UH**
Honda, Kawasaki, Suzuki, Yamaha
12 Volt, Shunt-Type, 14.7 Vset

MAKE / MODEL	YEAR
Honda CB650	1979-1982
Honda CB650C Custom	1980-1981
Honda CB650SC Nighthawk	1982
Honda CB750C Custom	1980-1982
Honda CB750F Super Sport	1979-1982
Honda CB750K	1979-1982
Honda CB750L	1979
Honda CB750SC Nighthawk	1982
Honda CB900C Custom	1980-1982
Honda CB900F Super Sport	1981-1982
Honda CBX	1981-1982
Yamaha XS650	1975-1981
Yamaha XS650-2 Special II	1979
Yamaha XS650S Special	1978-1983



◀ **cod. S1004B**
Shindengen Applications
0.5k

MAKE / MODEL	YEAR
Yamaha TDM850	1992-1993
Yamaha XJ600S Seca II	1992-1998



◀ **cod. S1006N**

Suzuki Applications
12 Volt Regulator Rectifier Assembly

MAKE / MODEL	YEAR
Suzuki GSX1300BK B-King	2008
Suzuki GSX-R1000	2007-2008
Suzuki GSX-R600	2006-2007



◀ **cod. S1011N**

Suzuki Motorcycles
12 Volt Regulator Rectifier Assembly

MAKE / MODEL	YEAR
Suzuki GSX1300R Hayabusa	1999-2007
Suzuki GSX-R1000	2001-2004
Suzuki GSX-R600	2001-2005
Suzuki GSX-R750	1998-2005



◀ **cod. S1013N**

Suzuki Motorcycles
12 Volt Regulator Rectifier Assembly

MAKE / MODEL	YEAR
Suzuki DR650SES	1992-1995
Suzuki VS1400GL Intruder	1996-2004
Suzuki VS800GL Intruder	1992-2008



◀ **cod. S1014N**

Suzuki Applications
12 Volt Regulator Rectifier Assembly

MAKE / MODEL	YEAR
Suzuki VS1400GL Intruder	1987-1995



cod. TRR6330

Honda Applications
12 Volt, Shunt-Type, 14.4 Vset

MAKE / MODEL	YEAR
Honda CBR600F F2	1991-1994
Honda CBR600F F3	1995-1998
Honda CBR600F F4	1999-2000
Honda CBR900RR	1992-1999
Honda PC800 Pacific Coast	1989-1998
Honda VTR1000 Super Hawk	1998-2000



cod. YM1000N

Yamaha Applications
12 Volt Regulator Rectifier Assembly

MAKE / MODEL	YEAR
Yamaha FJ-09	2015-2016
Yamaha FJR1300	2006
Yamaha FJR1300A	2007-2015
Yamaha FJR1300A ABS	2006
Yamaha FJR1300AE	2007-2009
Yamaha FJR1300ES	2014-2015
Yamaha FZ-09	2014-2016
Yamaha FZ-1	2006-2015
Yamaha FZ8	2011-2013
Yamaha VMX1700 V-Max	2009-2014
Yamaha XTZ1200 Super Tenere	2012-2016
Yamaha XTZ1200 Super Tenere ES	2014-2016
Yamaha XV1700AS Road Star S	2008-2014
Yamaha XV1700AT Road Star Silverado	2008-2010
Yamaha XV1700ATS Road Star Silverado S	2008-2014
Yamaha XV1900 Roadliner	2006-2007
Yamaha XV1900CT Stratoliner	2006-2009
Yamaha XV1900CT Stratoliner Deluxe	2010-2014
Yamaha XV1900CTS Stratoliner S	2006-2014
Yamaha XV1900M Roadliner Midnight	2006-2009
Yamaha XV1900S Roadliner S	2006-2014
Yamaha XV19C Raider	2008-2015
Yamaha XV19C Raider Bullet Cowl	2015
Yamaha XV19CX Raider	2008-2015
Yamaha XV19SCL Raider SCL	2012-2014
Yamaha XVS1300 V Star 1300	2007-2010
Yamaha XVS1300A V Star 1300 Tourer	2007-2010
Yamaha XVS950 V Star 950	2009-2010
Yamaha XVS950CT V Star 950 Tourer	2009-2010
Yamaha XVS95C Bolt	2014-2016
Yamaha XVS95C Bolt C Spec	2015-2016
Yamaha XVS95C Bolt R Spec	2014-2016
Yamaha YFM550 Grizzly FI 4x4 Auto	2009-2014
Yamaha YFM550 Grizzly FI 4x4 Auto EPS	2009-2014
Yamaha YFM700FG Grizzly 700 4WD	2009-2015
Yamaha YFM700FGH Grizzly 700 4WD Hunter	2009-2014
Yamaha YFM700FGHP Grizzly 700 EPS 4WD Hunter	2009-2011
Yamaha YFM700FGP Grizzly 700 Ducks	2007-2008



◀ cod. **YM1000N** - continued

MAKE / MODEL	YEAR
Yamaha YFM700FGP Grizzly 700 EPS 4WD	2009-2014
Yamaha YFM700FGP Grizzly 700 Hunter	2007-2008
Yamaha YFM700R Grizzly	2006-2008
Yamaha YFM7FGPS Grizzly 700 SE	2008
Yamaha YXC700DF Viking VI	2015
Yamaha YXC700PF Viking VI 700 EPS	2015
Yamaha YXM700DF Viking	2015
Yamaha YXM700PH Viking EPS Hunter	2014-2015
Yamaha YXR700F Rhino 700 FI	2008-2012
Yamaha YZF-R1	2007-2014

◀ cod. **YM1001N**

Yamaha Applications
12 Volt Regulator Rectifier Assembly

MAKE / MODEL	YEAR
Yamaha XP500 TMAX	2009-2015

◀ cod. **YM1002N**

Yamaha Motorcycles
12 Volt Regulator Rectifier Assembly

MAKE / MODEL	YEAR
Yamaha FZR400	1988-1990
Yamaha FZR600	1989-1993
Yamaha FZR600R	1990-1994
Yamaha SRX600	1986
Yamaha TW200	1988-2000
Yamaha TZ125	1999-2000
Yamaha TZ250	1999-2001
Yamaha WR200	1992
Yamaha XT225	1992-1995
Yamaha XT600	1990-1995
Yamaha XV250 Route 66	1988-1990

◀ cod. **YM1003N**

Yamaha Applications
12 Volt Regulator Rectifier Assembly

MAKE / MODEL	YEAR
Yamaha FZR600R	1995-1999
Yamaha YZF600R	1995-2007
Yamaha YZF-R1	1998-2001
Yamaha YZF-R6	1999-2002



◀ **cod. YM1005N**
Yamaha Applications
12 Volt Regulator Rectifier Assembly

MAKE / MODEL	YEAR
Yamaha VMX1200 V-Max	1985-1995
Yamaha XV1100 Virago	1986-1995
Yamaha XV535 Virago	1987-1995
Yamaha XV700 Virago	1984-1987
Yamaha XV750 Virago	1989-1995



◀ **cod. YM1006N**
Kawasaki Applications
12 Volt Regulator Rectifier Assembly

MAKE / MODEL	YEAR
Kawasaki EX250F Ninja 250R	2008-2012
Kawasaki KEF300 Lakota Sport	2001-2003
Kawasaki KEF300 Lakota Utility	1995-2000
Kawasaki KLF300 Bayou 2x4	1992-2001
Kawasaki KLF300 Bayou 4x4	1989-2002
Kawasaki KLR650	2008-2014
Kawasaki KLX250S	2009-2014
Kawasaki KLX250SF	2009-2010
Kawasaki VN1500A Vulcan 1500	1996-1999
Kawasaki VN1500A Vulcan 88	1992-1995
Kawasaki VN1500C Vulcan L	1996-1997
Kawasaki VN750A Vulcan 750	1994-2006
Kawasaki ZL600 Eliminator	1996-1997
Kawasaki ZR-7	2000
Kawasaki ZR-7S	2001-2005
Kawasaki ZX600 Ninja 600R	1994-1997
Kawasaki ZX600 Ninja ZX-6	1993-2001
Kawasaki ZX600 Ninja ZX-6R	1995-1997
Kawasaki ZZR 600	2003-2004



◀ **cod. YM1009N**
Yamaha Applications
12 Volt Regulator Rectifier Assembly

MAKE / MODEL	YEAR
Yamaha YW125 Zuma 125	2009-2014



◀ cod. **YM1026N**

Yamaha Motorcycles

12 Volt Regulator Rectifier Assembly

MAKE / MODEL	YEAR
Yamaha FJ600	1984-1985
Yamaha FZ600	1986-1988
Yamaha XJ550 Maxim	1981-1983
Yamaha XJ550R Seca	1981-1983
Yamaha XJ650 Maxim	1980-1983
Yamaha XJ650L Turbo Seca	1981-1983
Yamaha XJ650R Seca	1982
Yamaha XJ700 Maxim	1985-1986
Yamaha XJ700X Maxim X	1985-1986
Yamaha XJ750M Mid-Max	1983
Yamaha XJ750R Seca	1981-1983
Yamaha XJ900 Seca	1983
Yamaha XS400	1982-1983
Yamaha XS400R Seca	1982-1983
Yamaha XS650	1978-1981
Yamaha XS650S Special	1978-1982
Yamaha YX600 Radian	1986-1988



◀ cod. **YM1034N**

Yamaha Applications

12 Volt Regulator Rectifier Assembly

MAKE / MODEL	YEAR
Yamaha XV1600A Road Star	2003
Yamaha XV1600AS Road Star Midnight	2001-2003
Yamaha XVS1100 V Star 1100 Custom	2000-2001
Yamaha XVS1100A V Star 1100 Classic	2000-2002
Yamaha XVS650 V Star Custom	1998-2000
Yamaha XVS650A V Star Classic	1999-2000
Yamaha YFM660F Grizzly 4x4	2001-2008
Yamaha YFM700R Raptor	2006-2014
Yamaha YFZ450R	2009-2014
Yamaha YFZ450R SE	2009-2015
Yamaha YFZ450X	2010-2011
Yamaha YXR45F Rhino 450	2006-2009
Yamaha YXR66F Rhino 660	2004-2007



◀ **cod. RL00001**
Ruota libera motore scooter 50 cc Minarelli/Yamaha

RIFERIMENTO ORIGINALE

Aprilia	AP8206147
Benelli	R16140181A0

Malaguti	74012500
Yamaha	3VL155700000



◀ **cod. RL00002**
Ruota libera scooter Minarelli/Yamaha 125/150 cc

RIFERIMENTO ORIGINALE

Yamaha	5NSE55700000
--------	--------------

Mbk	5NSE55700000
-----	--------------

APPLICABILITÀ

BENELLI VELVET 125 4T 99-01, VELVET 150 4T 99-01
ITALJET JUPITER 125 4T 01-02, MILLENIUM 125 4T 00-02, JUPITER 150 4T 01-02, MILLENIUM 150 4T 00-02
MALAGUTI MADISON 125 4T 99-01, MADISON R RESTYLING 125 4T 02-02, MADISON R RESTYLING EU2 125 4T 03-04, PHANTOM MAX 125 4T 03-03, MADISON T 150 4T 99-01

MBK DOODOO 125 4T 00-00, FLAME T 125 4T 95-99, SKYLINER 125 4T 98-02, THUNDER 125 4T 01-02, DOODOO 150 4T 01-02, SKYLINER 150 4T 00-02, THUNDER 150 4T 01-02
YAMAHA MAJESTY 125 4T 98-00, MAJESTY (SNR1) 125 4T 01-01, MAJESTY (SNR8) 125 4T 02-02, MAXSTER 125 4T 01-02, TEO'S 125 4T 00-00, MAJESTY 150 4T 00-00, MAJESTY (SNS1) 150 4T 01-01, MAJESTY (SNS6) 150 4T 02-02, MAXSTER 150 4T 01-02, TEO'S 150 4T 01-02



◀ **cod. RL00003**
Ruota libera Honda SH-Pantheon 125/150 cc 4T

RIFERIMENTO ORIGINALE

Honda	28125KGF911
-------	-------------

APPLICABILITÀ

HONDA @ [NES] 125 4T 00-06, DYLAN [SES] 125 4T 02-04, PANTHEON IE [FES] 125 4T-2V 03-05, PS I [PES] 125 4T 06-10, SH 125 4T-2V 01-04, SH IE SCOOOPY 125 4T-2V 05-12, SILVER WING [FES] 125 4T-2V 07-12, @ [NES] 150 4T 00-06, DYLAN [SES] 150 4T 02-04, PANTHEON IE [FES] 150 4T-2V 03-05, PS I [PES] 150 4T 06-10, SH 150 4T-2V 01-04, SH IE SCOOOPY 150 4T 05-12, SILVER WING [FES] 150 4T-2V 07-12



◀ **cod. RL00004**
Ruota libera Honda Foresight 250 cc 4T

RIFERIMENTO ORIGINALE

Honda	28120KM1013
-------	-------------

APPLICABILITÀ

HONDA CN SPAZIO/HELIX 250 4T 86-99, FORESIGHT [FES] 250 4T 98-99, FORESIGHT [FES] D.D. 250 4T 00-05, FORZA [NSS] 250 4T-2V 02-07, JAZZ ES REFLEX [NSS] 250 4T-2V 01-04, JAZZ REFLEX [NSS] 250 4T-2V 01-01



◀ **cod. RL00005**
Ruota libera Aprilia Scarabeo 150/200 cc 4T

RIFERIMENTO ORIGINALE

Aprilia	AP0259495
---------	-----------

APPLICABILITÀ

APRILIA LEONARDO 125 4T 96-02, LEONARDO ST 125 4T 03-04, SCARABEO 125 4T 99-03, LEONARDO 150 4T 96-02, SCARABEO 150 4T 99-03, SCARABEO 200 4T 01-03
BMW C1 125 4T 00-03, C1 200 4T 02-03

HONDA @ [NES] 125 4T 00-06, DYLAN [SES] 125 4T 02-04, PANTHEON IE [FES] 125 4T-2V 03-05, PS I [PES] 125 4T 06-10, SH 125 4T-2V 01-04, SH IE SCOOOPY 125 4T-2V 05-12, SILVER WING [FES] 125 4T-2V 07-12, @ [NES] 150 4T 00-06, DYLAN [SES] 150 4T 02-04, PANTHEON IE [FES] 150 4T-2V 03-05, PS I [PES] 150 4T 06-10, SH 150 4T-2V 01-04, SH IE SCOOOPY 150 4T 05-12, SILVER WING [FES] 150 4T-2V 07-12



◀ cod. **RL00013**
Ingranaggio ruota libera Aprilia Scarabeo
150/200 cc 4T

RIFERIMENTO ORIGINALE

Aprilia	AP0259480
---------	-----------

APPLICABILITÀ

APRILIA LEONARDO 125 4T 96-02, LEONARDO ST 125 4T 03-04, SCARABEO 125 4T 99-03, LEONARDO 150 4T 96-02, SCARABEO 150 4T 99-03, SCARABEO 200 4T 01-03

BMW C1 125 4T 00-03, C1 200 4T 02-03



◀ cod. **RL00014**
Flangia ruota libera Aprilia Scarabeo 150/200 cc 4T

RIFERIMENTO ORIGINALE

Aprilia	AP0635150
---------	-----------

APPLICABILITÀ

APRILIA LEONARDO 125 4T 96-02, LEONARDO ST 125 4T 03-04, SCARABEO 125 4T 99-03, LEONARDO 150 4T 96-02, SCARABEO 150 4T 99-03, SCARABEO 200 4T 01-03

BMW C1 125 4T 00-03, C1 200 4T 02-03



◀ cod. **RL00006**
Ruota libera Kymco Grand Dink 150 cc

RIFERIMENTO ORIGINALE

Kymco	00128934
-------	----------

APPLICABILITÀ

KYMCO B&W 125 4T 00-00, B&W EU2 125 4T 03-04, DINK 125 4T 97-98, DINK CLASSIC 125 4T 02-02, DINK CLASSIC EU2 125 4T 03-03, DINK EU3 125 4T 06-07, DINK LX 125 4T 98-00, DOWNTOWN E4 125 4T 16-16, DOWNTOWN I 125 4T 09-16, GRAND DINK 125 4T 01-02, GRAND DINK EU2 125 4T 03-04, K-XCT I 125 4T 12-14, PEOPLE GTI 125 4T 10-10, PEOPLE GTI 125 4T 14-14, X-TOWN CBS 125 4T 4V 16-16, B&W 150 4T 00-00, B&W EU2 150 4T 03-04, DINK 150 4T 97-98, DINK CLASSIC 150 4T 02-02, DINK CLASSIC EU2 150 4T 03-03, DINK LX 150 4T 98-00, GRAND DINK 150 4T 01-02, GRAND DINK EU2 150 4T 03-04



◀ cod. **RL00007**
Ingranaggio ruota libera Kymco Grand Dink 150 cc

RIFERIMENTO ORIGINALE

Kymco	00128929
-------	----------

APPLICABILITÀ

KYMCO B&W 125 4T 00-00, DINK 125 4T 97-98, DINK CLASSIC 125 4T 02-02, DINK CLASSIC EU2 125 4T 03-03, DINK LX 125 4T 98-00, GRAND DINK 125 4T 01-02, B&W 150 4T 00-00, DINK 150 4T 97-98, DINK CLASSIC 150 4T 02-02, DINK CLASSIC EU2 150 4T 03-03, DINK LX 150 4T 98-00, GRAND DINK 150 4T 01-02



◀ cod. **RL00008**
Ruota libera Kymco Grand Dink 250 cc

RIFERIMENTO ORIGINALE

Kymco	00128935
-------	----------

APPLICABILITÀ

KYMCO DINK CLASSIC 200 4T 04-04, DINK IE EU3 200 4T 06-07, B&W 250 4T 00-00, B&W EU2 250 4T 03-03, GRAND DINK 250 4T 01-02, GRAND DINK EU2 250 4T 03-04, KXR 250 4T 03-04, MXU 250 4T 05-05, PEOPLE LC 250 4T 03-04, YUP 250 4T 03-03, MAXXER 300 4T 05-06, MXU 300 4T 05-06



◀ cod. **RL00009**
Ingranaggio ruota libera Kymco Grand Dink 250 cc

RIFERIMENTO ORIGINALE

Kymco	00128933
-------	----------

APPLICABILITÀ

KYMCO B&W 250 4T 00-00, B&W EU2 250 4T 03-03, GRAND DINK 250 4T 01-02, GRAND DINK EU2 250 4T 03-04, KXR 250 4T 03-04, MXU 250 4T 05-05, PEOPLE LC 250 4T 03-04, YUP 250 4T 03-03, MAXXER 300 4T 05-06, MXU 300 4T 05-06



◀ cod. **RL00010**
Ruota libera per scooter Minarelli/Yamaha 250 cc

RIFERIMENTO ORIGINALE

Yamaha	4HC155900200
Mbk	4HC155900200
Benelli	R19040171A0

Malaguti	94000600
Aprilia	AP8122626

APPLICABILITÀ

APRILIA LEONARDO 250 4T 99-04, LEONARDO ST 250 4T 01-01, LEONARDO 300 4T 02-04
BENELLI VELVET 250 4T 99-03
ITALJET JUPITER 250 4T 00-02
MALAGUTI MADISON S 250 4T 99-01, PASSWORD 250 4T 05-06, PASSWORD EU3 250 4T 07-08

MBK SKYLINER 250 4T 00-03, SKYLINER ABS 250 4T 03-03, KILIBRE 300 4T 03-06
YAMAHA MAJESTY 250 4T 96-03, MAJESTY ABS 250 4T 03-03, MAJESTY DX 250 4T 98-99, X-CITY 250 4T 07-15, X-MAX 250 4T 05-16, X-MAX ABS 250 4T 14-15, VERSITY 300 4T 03-06



◀ cod. **RL00011**
Ingranaggio ruota libera Minarelli/Yamaha 250 cc

RIFERIMENTO ORIGINALE

Yamaha	1COE55170000
Benelli	R19040161A0

Malaguti	74018700
Aprilia	AP8122499

APPLICABILITÀ

APRILIA LEONARDO 250 4T 99-04, LEONARDO ST 250 4T 01-01, LEONARDO 300 4T 02-04
BENELLI VELVET 250 4T 99-03
ITALJET JUPITER 250 4T 00-02

MALAGUTI MADISON S 250 4T 99-01, PASSWORD 250 4T 05-06, PASSWORD EU3 250 4T 07-08
MBK SKYLINER 250 4T 00-03, SKYLINER ABS 250 4T 03-03, KILIBRE 300 4T 03-06
YAMAHA MAJESTY 250 4T 96-03, MAJESTY ABS 250 4T 03-03, MAJESTY DX 250 4T 98-99, X-CITY 250 4T 07-15, X-MAX 250 4T 05-16, X-MAX ABS 250 4T 14-15, VERSITY 300 4T 03-06



◀ cod. **RL00012**
Ruota libera con ingranaggio Suzuki Burgman 400 cc

RIFERIMENTO ORIGINALE

Suzuki	12600-15824-000
--------	-----------------

APPLICABILITÀ

SUZUKI AN BURGMAN K3/K6 400 4T 03-06, AN BURGMAN X/K2 400 4T 99-02



◀ cod. **RL00015**
Ruota libera Yamaha T-max 500 cc

RIFERIMENTO ORIGINALE

Yamaha	4NK155900000
--------	--------------

APPLICABILITÀ

YAMAHA T-MAX 4BS 500 4T 09-11, T-MAX 4BS ABS 500 4T 08-11, T-MAX 5GJ 500 4T 01-03, T-MAX 5VU 500 4T 04-08, T-MAX 5VU ABS 500 4T 05-07, T-MAX 5VU BLACK MAX 500 4T 06-06, T-MAX 5VU BLACK MAX - NIGHT MAX 500 4T 07-07, T-MAX 59C 530 4T 12-16, T-MAX 59C ABS 530 4T 12-16, T-MAX 59C SP 530 4T 15-15, T-MAX 59C SP ABS 530 4T 15-16, SCR950 950 4T 17-17, XV950 950 4T 14-14, XV950 RACER 950 4T 15-16, XV950CU 950 4T 14-16, XV950R 950 4T 14-17, XT1200Z SUPER TENERE 1200 4T 10-15, XT1200Z SUPER TENERE 1200 4T 17-17, XT1200ZE SUPER TENERE 1200 4T 14-15, XT1200ZE SUPER TENERE 1200 4T 17-17, FJR1300 1300 4T 01-04, FJR1300A 1300 4T 16-18, FJR1300A ABS 1300 4T 03-08, FJR1300A ABS 1300 4T 10-11, FJR1300A ABS 1300 4T 13-15, FJR1300AE 1300 4T 14-18, FJR1300AS 1300 4T 06-08, FJR1300AS 1300 4T 13-18, XVS1300A MIDNIGHT STAR 1300 4T 07-08, XVS1300A MIDNIGHT STAR 1300 4T 11-16, XVS1300CU CUSTOM 1300 4T 14-16, XVZ ROYAL STAR 1300 4T 96-00, XVZTF ROYAL STAR VENTURE 1300 4T 00-00, V-MAX 1700 4T 09-16



◀ cod. **RL00016**
Ingranaggio ruota libera Yamaha T-max 500 cc

RIFERIMENTO ORIGINALE

Yamaha	5GJ155170000
--------	--------------

APPLICABILITÀ

YAMAHA T-MAX 4BS 500 4T 09-11, T-MAX 4BS ABS 500 4T 08-11, T-MAX 5GJ 500 4T 01-03, T-MAX 5VU 500 4T 04-08, T-MAX 5VU ABS 500 4T 05-07, T-MAX 5VU BLACK MAX 500 4T 06-06, T-MAX 5VU BLACK MAX - NIGHT MAX 500 4T 07-07, T-MAX 59C 530 4T 12-16, T-MAX 59C ABS 530 4T 12-16, T-MAX 59C SP 530 4T 15-15, T-MAX 59C SP ABS 530 4T 15-16, XP530-A T-MAX SX 530 4T 17-19, XP530D-A T-MAX DX 530 4T 17-19, XP530E-A T-MAX 530 4T 17-18



◀ cod. **RL00017**
Ruota libera con Ingranaggio Suzuki Burgman 125/150 cc

RIFERIMENTO ORIGINALE

Suzuki	12600-21822-000
--------	-----------------

APPLICABILITÀ

SUZUKI EPICURO 125 4T 99-01, UH BURGMAN K2/K6 125 4T 02-06, EPICURO 150 4T 99-01, UH BURGMAN K2/K6 150 4T 02-06



◀ cod. **RL00018**
Ruota libera con Ingranaggio Suzuki Burgman 250 cc

RIFERIMENTO ORIGINALE

Suzuki	12600-14810-000
--------	-----------------

APPLICABILITÀ

SUZUKI AN BURGMAN K1/K2 250 4T 01-02, AN BURGMAN K3/K6 250 4T 03-06, AN BURGMAN W/X/Y 250 4T 98-00



◀ **cod. RL00019**
Ruota libera Yamaha Majesty 400 cc

RIFERIMENTO ORIGINALE

Yamaha	5RU15590000
--------	-------------

APPLICABILITÀ

YAMAHA MAJESTY 400 4T 04-11, MAJESTY ABS 400 4T 07-11, X-MAX 400 4T-4V 13-16, X-MAX ABS 400 4T-4V 14-17, X-MAX IRONMAX ABS 400 4T-4V 16-16, X-MAX MOMODESIGN 400 4T-4V 14-14, X-MAX MOMODESIGN ABS 400 4T-4V 14-14, X-MAX RA 400 4T-4V 18-18



◀ **cod. RL00020**
Ingranaggio ruota libera Yamaha Majesty 400 cc

RIFERIMENTO ORIGINALE

Yamaha	5RU155170000
--------	--------------

APPLICABILITÀ

YAMAHA MAJESTY 400 4T 04-11, MAJESTY ABS 400 4T 07-11, X-MAX 400 4T-4V 13-16, X-MAX ABS 400 4T-4V 14-17, X-MAX IRONMAX ABS 400 4T-4V 16-16, X-MAX MOMODESIGN 400 4T-4V 14-14, X-MAX MOMODESIGN ABS 400 4T-4V 14-14, X-MAX RA 400 4T-4V 18-18



◀ **cod. RL00021**
Ruota libera Piaggio 500 cc

RIFERIMENTO ORIGINALE

Piaggio	8494905
Aprilia	8494905
Gilera	8494905

Derbi	8494905
Malaguti	44003600
Peugeot	759737

APPLICABILITÀ

APRILIA ATLANTIC ARRECIFE 200 4T 03-05, ATLANTIC ARRECIFE 250 4T 03-05, ATLANTIC 300 4T 10-11, SCARABEO LIGHT 300 4T 09-10, SPORT CITY CUBE 300 4T 08-10, SPORT CITY STREET 300 4T-4V 12-12, SR MAX 300 4T 11-14, ATLANTIC ARRECIFE 400 4T 05-08, ATLANTIC SPRINT 400 4T 05-08, SCARABEO LIGHT 400 4T 06-08, ATLANTIC 500 4T 01-04, ATLANTIC ARRECIFE 500 4T 05-08, ATLANTIC SPRINT 500 4T 05-08, SCARABEO 500 4T 03-06, SCARABEO LIGHT 500 4T 06-08

DERBI GP1 250 4T 06-07, RAMBLA 300 4T 10-11

GILERA NEXUS EU3 300 4T 08-11, FUOCO IE EU3 500 4T 07-13, NEXUS 500 4T 03-05, NEXUS EU3 500 4T 06-11, NEXUS SP EU3 500 4T 06-07

MALAGUTI MADISON RS 250 4T 04-04, PHANTOM MAX 250 4T 04-04, SPIDER MAX GT 500 4T 04-05, SPIDER MAX GT EU3 500 4T 06-06, SPIDER MAX RS 500 4T 08-08

PEUGEOT GEOPOLIS IE EU3 400 4T-4V 90-02, SATELIS EU3 400 4T 07-12, GEOPOLIS IE EU3 500 4T-4V 90-02, SATELIS EU3 500 4T 90-02

PIAGGIO BEVERLY RST 250 4T 04-05, VESPA GTS ABS 250 4T 05-12, X9 EVOLUTION 250 4T 04-04, X9 EVOLUTION 250 4T 06-06, BEVERLY RST 4T 4V IE EU3 300 4T 10-16, BEVERLY TOURER EU3 300 4T 09-10, CARNABY CRUISER 300 4T 09-12, MP3 4T 4V IE LT IBRIDO 300 4T 10-11, MP3 IE LT 300 4T 10-11, MP3 IE LT TOURING 300 4T 11-13, MP3 IE LT/SPORT 300 4T 11-14, MP3 IE MIC 300 4T 10-11, MP3 IE TOURING 300 4T 11-12, VESPA GTS IE TOURING 300 4T 11-12, VESPA GTS SUPER 300 4T 08-16, VESPA GTS SUPER SPORT 300 4T 10-13, VESPA GTV 4T 4V IE 300 4T 10-13, VESPA GTV VIA MONTENAPOLEONE 300 4T 10-10, X7 EVO IE EU3 300 4T 09-10, BEVERLY 4T 4V IE EU3 350 4T 11-14, BEVERLY 4T ST IE ABS 350 4T 16-16, X10 4T 4V IE EURO3 350 4T 12-15, BEVERLY EU3 400 4T 06-07, BEVERLY TOURER EU3 400 4T 08-10, MP3 400 4T 07-08, MP3 IE LT TOURING 400 4T 11-11, MP3 IE LT/SPORT 400 4T 08-10, MP3 MIC 400 4T 08-10, MP3 RL TOURING 400 4T 11-11, X-EVO 400 4T 07-11, X8 EU3 400 4T 06-08, BEVERLY 500 4T 02-06, BEVERLY CRUISER 500 4T 07-12, BEVERLY IE EU3 500 4T 06-08, MP3 LT SPORT/BUSINESS 500 4T 11-13, MP3 RL SPORT-BUSINESS 500 4T 11-12, X9 500 4T 01-02, X9 EVOLUTION 500 4T 03-07



◀ cod. **RL00023**
Ingranaggio ruota libera Piaggio 500 cc

RIFERIMENTO ORIGINALE

Piaggio	82737R
Malaguti	44001900
Peugeot	758789

Aprilia	82737R
Gilera	82737R
Derbi	82737R

APPLICABILITÀ

APRILIA SR MAX 125 4T 11-14, ATLANTIC 250 4T 03-05, ATLANTIC EU3 250 4T 06-08, SCARABEO 250 4T 04-06, SCARABEO LIGHT 250 4T 06-08, SPORT CITY CUBE 250 4T 08-12, SPORT CITY EU3 250 4T 06-08, ATLANTIC 300 4T 10-11, SCARABEO LIGHT 300 4T 09-10, SPORT CITY CUBE 300 4T 08-10, SPORT CITY STREET 300 4T-4V 12-12, SR MAX 300 4T 11-14, ATLANTIC ARRECIFE 400 4T 05-08, ATLANTIC SPRINT 400 4T 05-08, SCARABEO LIGHT 400 4T 06-08, ATLANTIC 500 4T 01-04, ATLANTIC ARRECIFE 500 4T 05-08, ATLANTIC SPRINT 500 4T 05-08, SCARABEO 500 4T 03-06, SCARABEO LIGHT 500 4T 06-08

DERBI GP1 250 4T 06-07, GP1 LOW SEAT EU3 250 4T 07-08, RAMBLA EU3 2VER 250 4T 08-08, RAMBLA 300 4T 10-11

GILERA NEXUS IE EU3 125 4T 08-10, NEXUS EU3 250 4T 06-07, NEXUS SP EU3 250 4T 06-07, NEXUS EU3 300 4T 08-11, FUOCO IE EU3 500 4T 07-13, NEXUS 500 4T 03-05, NEXUS EU3 500 4T 06-11, NEXUS SP EU3 500 4T 06-07

MALAGUTI MADISON 3 250 4T 06-09, MADISON RS 250 4T 04-04, PHANTOM MAX 250 4T 04-04, SPIDER MAX GT 500 4T 04-05, SPIDER MAX GT EU3 500 4T 06-06, SPIDER MAX RS 500 4T 08-08

PEUGEOT GEOPOLIS IE EU3 400 4T-4V 90-02, SATELIS EU3 400 4T 07-12, GEOPOLIS IE EU3 500 4T-4V 90-02, SATELIS EU3 500 4T 90-02

PIAGGIO MP3 IBRIDO 125 4T 09-10, MP3 IE 125 4T 08-09, MP3 IE TOURING 125 4T 11-12, MP3 YOURBAN ERL 125 4T 11-13, VESPA GTS 4T IE SUPER 125 4T 09-16, X7 EVO IE EU3 125 4T 09-10, BEVERLY 250 4T 05-07, BEVERLY CRUISER 250 4T 07-09, BEVERLY EURO 3 MIC 250 4T 07-07, BEVERLY IE EU3 250 4T 06-08, BEVERLY RST 250 4T 04-05, BEVERLY SPORT 250 4T 06-08, BEVERLY TOURER EU3 250 4T 07-09, CARNABY 250 4T 08-09, MP3 250 4T 06-08, MP3 LT 250 4T 08-09, MP3 MIC 250 4T 08-09, VESPA GT 60 EU3 250 4T 06-07, VESPA GTS 250 4T 05-16, VESPA GTS ABS 250 4T 05-12, VESPA GTV 250 4T 06-09, VESPA GTV 4T NAVY EU3 250 4T 07-07, X-EVO 250 4T 07-16, X7 EU3 250 4T 08-08, X8 EU3 250 4T 05-08, X9 EVOLUTION 250 4T 04-04, X9 EVOLUTION 250 4T 06-06, BEVERLY RST 4T 4V IE EU3 300 4T 10-16, BEVERLY TOURER EU3 300 4T 09-10, MP3 4T 4V IE LT IBRIDO 300 4T 10-11, MP3 IE LT 300 4T 10-11, MP3 IE LT TOURING 300 4T 11-13, MP3 IE LT/SPORT 300 4T 11-14, MP3 IE MIC 300 4T 10-11, MP3 IE TOURING 300 4T 11-12, MP3 YOURBAN ERL 300 4T 11-15, MP3 YOURBAN LT ERL 300 4T 11-12, VESPA GTS IE TOURING 300 4T 11-12, VESPA GTS SUPER 300 4T 08-16, VESPA GTS SUPER SPORT 300 4T 10-13, VESPA GTV 4T 4V IE 300 4T 10-13, VESPA GTV VIA MONTENAPOLIONE 300 4T 10-10, X7 EVO IE EU3 300 4T 09-10, BEVERLY 4T 4V IE EU3 350 4T 11-14, BEVERLY 4T ST IE ABS 350 4T 16-16, X10 4T 4V IE EURO3 350 4T 12-15, BEVERLY EU3 400 4T 06-07, BEVERLY TOURER EU3 400 4T 08-10, MP3 400 4T 07-08, MP3 IE LT TOURING 400 4T 11-11, MP3 IE LT/SPORT 400 4T 08-10, MP3 MIC 400 4T 08-10, MP3 RL TOURING 400 4T 11-11, X-EVO 400 4T 07-11, X8 EU3 400 4T 06-08, BEVERLY 500 4T 02-06, BEVERLY CRUISER 500 4T 07-12, BEVERLY IE EU3 500 4T 06-08, MP3 LT SPORT/BUSINESS 500 4T 11-13, MP3 RL SPORT-BUSINESS 500 4T 11-12, X9 500 4T 01-02, X9 EVOLUTION 500 4T 03-07, X9 EVOLUTION ABS 500 4T 06-07



◀ cod. **RL00024**
Ingranaggio ruota libera Kymco Agility 125 cc

RIFERIMENTO ORIGINALE

Kymco	001228728
-------	-----------

Malaguti	54001200
----------	----------

APPLICABILITÀ

KYMCO AGILITY 125 4T 06-06, AGILITY EU3 125 4T 06-08, HEROISM 125 4T 95-97, MOVIE EU3 125 4T 06-07, PEOPLE 125 4T 99-00, PEOPLE EU3 125 4T 07-08, PEOPLE S 125 4T 05-05, SUPER 8 125 4T 08-09, VIVIO 125 4T 00-00, HEROISM 150 4T 95-97, MOVIE EU3 150 4T 06-07, PEOPLE 150 4T 99-00, VIVIO 150 4T 00-00, PEOPLE S 200 4T 05-05

MALAGUTI CIAK MASTER 125 4T 04-04, CIAK MASTER 150 4T 04-04, CIAK MASTER EURO 2 200 4T 06-06



◀ cod. **RL00025**
Ruota libera Kymco Agility 125 cc

RIFERIMENTO ORIGINALE

Kymco	00128742
-------	----------

Malaguti	54001900
----------	----------

APPLICABILITÀ

KYMCO AGILITY 125 4T 06-06, AGILITY EU3 125 4T 06-08, MOVIE EU3 125 4T 06-07, PEOPLE 125 4T 99-00, PEOPLE EU3 125 4T 07-08, PEOPLE S 125 4T 05-05, SUPER 8 125 4T 08-09, VIVIO 125 4T 00-00, MOVIE EU3 150 4T 06-07, PEOPLE 150 4T 99-00, VIVIO 150 4T 00-00, PEOPLE S 200 4T 05-05

MALAGUTI CIAK MASTER 125 4T 04-04, CIAK MASTER 150 4T 04-04, CIAK MASTER EURO 2 200 4T 06-06



◀ **cod. RL00026**
Ingranaggio ruota libera Kymco Xciting 500 cc

RIFERIMENTO ORIGINALE

Kymco	00128059
-------	----------

APPLICABILITÀ

KYMCO X CITING 500 4T 05-05, X CITING I 500 4T 06-08, X CITING I R 500 4T 07-08, X CITING R 500 4T 09-09



◀ **cod. RL00027**
Ruota libera Kymco Xciting 500 cc

RIFERIMENTO ORIGINALE

Kymco	00128060
-------	----------

APPLICABILITÀ

KYMCO X CITING 500 4T 05-05, X CITING I 500 4T 06-08, X CITING I R 500 4T 07-08, X CITING R 500 4T 09-09



◀ **cod. RL00028**
Ruota libera Kymco Xciting 250 cc

RIFERIMENTO ORIGINALE

Kymco	00126013
-------	----------

APPLICABILITÀ

HONDA @ [NES] 125 4T 00-06, DYLAN [SES] 125 4T 02-04, PANTHEON IE [FES] 125 4T-2V 03-05, PS I [PES] 125 4T 06-10, SH 125 4T-2V 01-04, SH IE SCOOPI 125 4T-2V 05-12, SILVER WING [FES] 125 4T-2V 07-12, @ [NES] 150 4T 00-06, DYLAN [SES] 150 4T 02-04, PANTHEON IE [FES] 150 4T-2V 03-05, PS I [PES] 150 4T 06-10, SH 150 4T-2V 01-04, SH IE SCOOPI 150 4T 05-12, SILVER WING [FES] 150 4T-2V 07-12

KYMCO G-DINK 125 4T 12-12, DINK IE EU3 200 4T 06-07, DOWNTOWN I 200 4T 10-10, PEOPLE GTI 200 4T 10-10, PEOPLE GTI 200 4T 14-14, PEOPLE S 250 4T 06-06, PEOPLE S I 250 4T 07-07, X CITING 250 4T 05-05, X CITING I 250 4T 06-07, DOWNTOWN ABS 300 4T 10-10, DOWNTOWN I 300 4T 09-09, DOWNTOWN I 300 4T 11-11, DOWNTOWN I ABS 300 4T 11-16, G-DINK 300 4T-2V 12-12, K-XCT I 300 4T 12-12, K-XCT I ABS 300 4T 14-14, MAXXER 300 4T 05-06, MXU 300 4T 05-06, MXU R 300 4T 10-10, PEOPLE GTI 300 4T 10-11, PEOPLE GTI 300 4T 14-14, PEOPLE GTI ABS 300 4T 12-12, PEOPLE GTI ABS 300 4T 14-14, PEOPLE GTI ABS E4 300 4T 16-16, PEOPLE S I 300 4T 08-08, X CITING I 300 4T 08-08, X CITING I R 300 4T 08-09, DOWNTOWN ABS E4 350 4T 16-16, DOWNTOWN I ABS 350 4T 15-15



◀ **cod. RL00031**
Ingranaggio ruota libera Kymco Xciting 250 cc

RIFERIMENTO ORIGINALE

Kymco	00126012
-------	----------

APPLICABILITÀ

KYMCO PEOPLE S 250 4T 06-06, PEOPLE S I 250 4T 07-07, X CITING 250 4T 05-05, X CITING I 250 4T 06-07, MXU R 300 4T 10-10, PEOPLE S I 300 4T 08-08, X CITING I 300 4T 08-08, X CITING I R 300 4T 08-09



◀ **cod. RL00029**
Ingranaggio ruota libera Honda SH 300 cc

RIFERIMENTO ORIGINALE

Honda	28110KTW900
-------	-------------

APPLICABILITÀ

HONDA FORZA [NSS A] 250 4T-4V 08-11, FORZA [NSS S] 250 4T-4V 08-11, SH IE SCOOPI 300 4T-4V 07-19

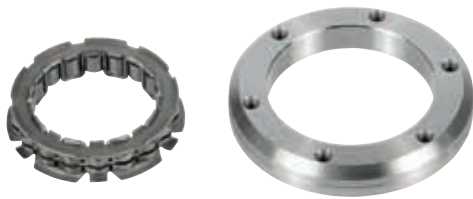

◀ cod. **RL00030**
Ruota libera Honda SH 300 cc

RIFERIMENTO ORIGINALE

Honda	28125HN5671
-------	-------------

APPLICABILITÀ

HONDA FORZA EX [NSS] 250 4T-2V 05-07, FORZA X [NSS] 250 4T-2V 05-07, FORZA [NSS A] 250 4T-4V 08-11, FORZA [NSS S] 250 4T-4V 08-11, SH IE SCOOPY 300 4T-4V 07-19



◀ cod. **RL00032**
Ruota libera completa Yamaha Majesty 125/180 cc (YP) dal '03

RIFERIMENTO ORIGINALE

Yamaha	5XME55700000	Mbk	5XME55700000
--------	--------------	-----	--------------

APPLICABILITÀ

MBK SKYLINER E 125 4T 03-03, SKYLINER E 180 4T 03-03 **YAMAHA** MAJESTY E 125 4T 03-09, MAJESTY E 180 4T 03-06



◀ cod. **RL00033**
Ruota libera Kymco Agility 50 cc

RIFERIMENTO ORIGINALE

Kymco	00107245
-------	----------

APPLICABILITÀ

KYMCO AGILITY 4T CARRY 50 4T 11-11, AGILITY 4T R10 50 4T 06-08, AGILITY 4T R12 50 4T 07-08, AGILITY PLUS 4T 50 4T 14-14, AGILITY R12 50 4T 05-05, AGILITY R12 ECS 50 4T 16-16, AGILITY R16 50 4T 08-09, AGILITY R16 50 4T 12-12, AGILITY R16 2T 50 2T 10-10, AGILITY R16 2T 50 2T 12-12, AGILITY RS 50 4T 09-09, AGILITY RS NAKED 50 2T 10-10, B&W 50 2T 02-02, B&W EU2 50 2T 03-03, DINK AC 50 2T 98-02, DINK LC 50 2T 98-02, DINK 50 4T 50 4T 07-07, DINK CLASSIC EU2 50 2T 03-03, FILLY 50 4T 98-00, FILLY LX 50 4T 01-02, HEROISM 50 2T 95-97, LIKE 50 4T 09-09, PEOPLE 50 2T 99-04, PEOPLE EURO 2 50 2T 03-03, PEOPLE EURO 2 50 2T 08-08, PEOPLE EURO 2 50 2T 11-11, PEOPLE S 50 2T 05-08, PEOPLE S 4T 50 4T 06-08, SENTO 50 4T 08-08, SNIPER 50 2T 93-93, SNIPER DD 50 2T 94-96, SUPER 8 50 2T 09-09, SUPER 8 4T 50 4T 07-07, SUPER 8 4T 50 4T 09-09, SUPER 9 50 2T 00-00, SUPER 9 EU2 50 2T 03-04, TOP BOY 50 2T 97-00, VITALITY 2T 50 2T 04-04, VITALITY 4T 50 4T 04-04, YUP 50 2T 02-02, YUP EU2 50 2T 03-03



◀ cod. **RL00034**
Ruota libera Yamaha X-Max 125 cc

RIFERIMENTO ORIGINALE

Yamaha	1B9E55800000	Mbk	1B9E55800000
--------	--------------	-----	--------------

APPLICABILITÀ

MBK CITYLINER EU3 125 4T-4V 08-10, SKYCRUISER 125 4T-4V 07-07 **YAMAHA** X-CITY EU3 125 4T-4V 08-11, X-MAX R 125 4T-4V 06-16, X-MAX R ABS 125 4T-4V 11-11, X-MAX RA ABS 125 4T-4V 13-16



◀ cod. **RL00035**
Ingranaggio ruota libera Yamaha X-Max 125 cc

RIFERIMENTO ORIGINALE

Yamaha	5YPE55240000	Mbk	5YPE55240000
--------	--------------	-----	--------------

APPLICABILITÀ

MBK CITYLINER EU3 125 4T-4V 08-10, SKYCRUISER 125 4T-4V 07-07 **YAMAHA** X-CITY EU3 125 4T-4V 08-11, X-MAX R 125 4T-4V 06-16, X-MAX R ABS 125 4T-4V 11-11, X-MAX RA ABS 125 4T-4V 13-16



◀ **cod. RL00038**
Ruota libera Yamaha Xenter 125 cc con flangia

RIFERIMENTO ORIGINALE

Yamaha	52SE55700000
--------	--------------

APPLICABILITÀ

YAMAHA XC125R MAJESTY S 125 4T 14-14, XENTER 125 4T 12-17, XENTER 150 4T 12-16



◀ **cod. RL00022**
Ruota Libera Piaggio Liberty 125 cc

RIFERIMENTO ORIGINALE

Piaggio	82612R
---------	--------

APPLICABILITÀ

APRILIA ATLANTIC 125 4T 03-05, ATLANTIC EU3 125 4T 06-08, ATLANTIC EU3 125 4T 10-12, MOJITO 125 4T 03-08, SCARABEO 125 4T 03-06, SCARABEO EU3 125 4T 06-07, SPORT CITY 125 4T 04-06, SPORT CITY CUBE 125 4T 08-10, SPORT CITY EU3 125 4T 06-08, SPORT CITY ONE 4T EU3 125 4T 08-11, SPORT CITY STREET 125 4T 12-12, SR MOTARD 125 4T-2V 12-14, MOJITO 150 4T 03-07, SCARABEO 150 4T 04-06, ATLANTIC 200 4T 03-05, SCARABEO 200 4T 03-03, SCARABEO EU3 200 4T 06-06, SPORT CITY 200 4T 04-06, SPORT CITY CUBE 200 4T 08-10, SPORT CITY EU3 200 4T 06-08

DERBI BOULEVARD 125 4T 02-04, BOULEVARD 4T EU3 125 4T 08-12, BOULEVARD EU2 125 4T 04-07, GP1 EU 2 125 4T 06-06, GP1 LOW SEAT EU3 125 4T 07-08, RAMBLA 125 4T 08-09, RAMBLA EU3 2VER 125 4T 08-08, SONAR 4T 125 4T 09-11, VARIANT SPORT 4T EU3 125 4T 12-12, BOULEVARD 150 4T 02-04, BOULEVARD 4T E3 150 4T 10-10, BOULEVARD EU3 150 4T 04-07, SONAR 4T 150 4T 09-09, BOULEVARD EU2 200 4T 05-06

GILERA DNA 125 4T 01-01, NEXUS EU3 125 4T 07-08, RUNNER 4T ST EU3 125 4T 08-16, RUNNER VX 125 4T 00-06, RUNNER VX 4T EU3 125 4T 06-07, RUNNER VX RACE 125 4T 06-06, RUNNER VX SC 125 4T 06-07, RUNNER VXR RACE 200 125 4T 06-06, DNA 180 4T 01-01, RUNNER VXR 180 4T 00-01, RUNNER VXR 200 4T 02-06, RUNNER VXR 4T ST EU3 200 4T 08-11, RUNNER VXR EU3 200 4T 07-07

PIAGGIO BEVERLY 125 4T 01-03, BEVERLY EU3 125 4T 07-08, BEVERLY EURO 3 MIC 125 4T 07-07, BEVERLY EURO 3 SPORT 125 4T 07-08, BEVERLY RST 125 4T 04-07, BEVERLY TOURER EU3 125 4T 07-10, CARNABY 125 4T 07-10, FLY 125 4T 05-07, FLY EU3 125 4T 07-11, HEXAGON GTX 125 4T 00-00, LIBERTY 125 4T 98-02, LIBERTY 4T 125 4T 06-07, LIBERTY 4T 2V EURO3 125 4T 09-12, LIBERTY 4T EU3 125 4T 06-08, LIBERTY 4T EU3 DELIVERY - TNT 125 4T 08-15, LIBERTY 4T SPORT EU3 125 4T 06-08, LIBERTY RST 125 4T 04-05, LIBERTY RST PTT 125 4T 05-11, LIBERTY SPORT 125 4T 06-06, MP3 125 4T 06-08, SKYPPER 4T 125 4T 00-02, SUPER HEXAGON GTX 12 125 4T 01-02, TYPHOON 4T 2V E3 125 4T 10-11, VESPA ET4 125 4T 96-02, VESPA GRANTURISMO 125 4T 03-07, VESPA GRANTURISMO EU3 125 4T 06-07, VESPA GTS EU3 125 4T 07-12, VESPA GTV 125 4T 06-08, VESPA GTV 4T NAVY EU3 125 4T 08-08, VESPA LX 125 4T 05-06, VESPA LX 4T EU3 TOURING 125 4T 10-11, VESPA LX 4T FL 125 4T 09-09, VESPA LX EU3 125 4T 06-08, VESPA LX EU3 IE 125 4T 09-11, VESPA LXV 4T EU3 125 4T 06-09, VESPA LXV IE 4T 125 4T 10-13, VESPA LXV NAVY EU3 125 4T 07-08, VESPA S 4T EU3 125 4T 07-08, VESPA S 4T IE & COLLEGE 125 4T 09-11, X-EVO 125 4T 07-16, X7 EU3 125 4T 08-08, X8 125 4T 04-06, X8 PREMIUM EU2 125 4T 06-06, X8 PREMIUM EU3 125 4T 06-07, X8 STREET EU2 125 4T 06-07, X9 125 4T 01-02, X9 EVOLUTION 125 4T 03-03, X9 EVOLUTION 125 4T 05-06, X9 EVOLUTION EU3 125 4T 07-07, ZIP 125 4T 00-02, FLY 150 4T 05-07, FLY EU3 150 4T 08-11, LIBERTY 150 4T 01-02, LIBERTY 4T EU3 150 4T 08-08, LIBERTY 4T SPORT EU3 150 4T 08-08, LIBERTY MOC 4T 150 4T 09-13, SKYPPER 4T 150 4T 00-02, VESPA ET4 150 4T 99-02, VESPA LX 150 4T 05-06, VESPA LX 4T FL 150 4T 09-09, VESPA LX EU3 150 4T 06-08, VESPA LX EU3 IE 150 4T 09-11, VESPA LX TOURING 150 4T 10-12, VESPA S 4T 150 4T 08-09, VESPA S 4T IE & COLLEGE 150 4T 09-12, X8 STREET EU2 150 4T 06-08, HEXAGON GTX 180 4T 00-00, SUPER HEXAGON GTX 12 180 4T 01-02, X9 AMALFI 180 4T 00-03, BEVERLY 200 4T 01-03, CARNABY 200 4T 07-08, LIBERTY 200 4T 06-06, LIBERTY 4T EU3 200 4T 06-08, LIBERTY 4T SPORT EU3 200 4T 06-07, LIBERTY RST 200 4T 04-04, LIBERTY SPORT 200 4T 06-06, VESPA GRANTURISMO 200 4T 03-07, X8 200 4T 04-07, X9 200 4T 02-03, X9 EVOLUTION 200 4T 03-03



◀ **cod. RL00039**
Ruota Libera Piaggio Liberty 50 cc 4T

RIFERIMENTO ORIGINALE

Piaggio	289202
---------	--------

APPLICABILITÀ

APRILIA RS 50 2T 06-10, RS4 50 2T 11-13, SCARABEO 4T 50 4T 02-06, SCARABEO 4T 4V 50 4T-4V 10-12, SCARABEO 4T 4V NET 50 4T-4V 09-10, SCARABEO 4T RESTYLING EU3 50 4T 06-09, SCARABEO QUATTRO 50 4T-4V 09-09, SPORT CITY ONE 4T 50 4T 08-10, SR R 50 2T 04-09, SR R FACTORY IE 50 2T 10-14

DERBI ATLANTIS 4T 50 4T 04-06, ATLANTIS 4T EU2 50 4T 07-07, BOULEVARD 4T EU2 25KM/H 50 4T 09-09, GPR 2T EU2 50 2T 09-10, GPR NUDE & GPR NUDE TUNING 50 2T 06-08, GPR NUDE SPORT 50 2T 06-06, GPR RACING EU2 50 2T 06-06, GPR REPLICCA & GPR R EU2 50 2T 06-06, GPR REPLICCA PESEK EU2 50 2T 07-07, SENDA R DRD PRO EU2 50 2T 05-11, SENDA SM DRD PRO EU2 50 2T 05-11

GILERA RUNNER PURE JET 50 2T-IE 02-07, RUNNER PURE JET 50 2T-IE 10-11

MALAGUTI CENTRO EURO 2 50 4T 08-08, CENTRO SL 4T 50 4T 10-10, CIAK MASTER 4T 50 4T 05-06

PIAGGIO FLY 4T 50 4T 05-07, FLY 4T & 25-30 KM/H 50 4T 08-11, FLY 4T MOTORE CHN 50 4T 06-07, LIBERTY 4T 50 4T 00-02, LIBERTY 4T 50 4T 05-08, LIBERTY 4T 3V IE 50 4T-3V 15-17, LIBERTY 4T 3V IE E4 50 4T-3V 17-18, LIBERTY 4T DELIVERY - SINGLE 50 4T 10-14, LIBERTY 4T DELIVERY TNT 50 4T 09-09, LIBERTY 4T PTT - DOUBLE - NEXIVE 50 4T 09-17, LIBERTY 4T RST 50 4T 04-04, LIBERTY 4T SPORT 50 4T 06-08, LIBERTY MOC 2T & ELLE 50 2T 09-13, NRG POWER PUREJET 50 2T-IE 04-11, NRG PUREJET 50 2T-IE 02-04, NRG PUREJET 50 2T-IE 10-10, VESPA ET4 50 4T 00-05, VESPA LX 4T 50 4T 05-09, VESPA LX 4T 4V 50 4T-4V 09-13, VESPA LX 4T 4V TOURING 50 4T-4V 10-13, VESPA S 4T 4V & COLLEGE 50 4T-4V 08-12, ZIP 4T 50 4T 00-13, ZIP RST 50 2T 96-99



◀ **cod. RL00040**
Ruota Libera Piaggio Liberty 50 cc 2T

RIFERIMENTO ORIGINALE

Piaggio	286174
---------	--------

APPLICABILITÀ

- APRILIA** SCARABEO 2T EU2 MOTORE PIAGGIO 50 2T 10-12, SCARABEO 2T NET 50 2T 09-10, SCARABEO STREET 50 2T 05-06, SCARABEO STREET 2T RESTYLING 50 2T 06-09, SPORT CITY ONE 2T 50 2T 08-11, SR MOTARD 50 2T 12-14, SR R FACTORY CARBURATORE 50 2T 10-14, SR STEALTH 50 2T 97-00, SR STREET CARBURATORE 50 2T 03-12
- DERBI** ATLANTIS 2T 50 2T 10-10, ATLANTIS 2T EU2 50 2T 07-09, ATLANTIS O2 50 2T 02-02, ATLANTIS O2 BULLET 50 2T 03-05, ATLANTIS O2 CITY 50 2T 04-06, ATLANTIS O2 RED BULLET 50 2T 03-03, ATLANTIS O2 TWO CHIC 50 2T 05-05, BOULEVARD 2T 50 2T 09-14, GP1 50 2T 01-03, GP1 EU 2 50 2T 05-05, GP1 OPEN EU2 50 2T 06-09, GP1 RACE EU2 50 2T 05-07, SONAR 2T 50 2T 09-09
- GILERA** DNA 50 2T 00-02, DNA 50 2T 05-07, DNA GP EXPERIENCE 50 2T 03-04, EASY MOVING 50 2T 95-96, ICE 50 2T 01-05, RUNNER 50 2T 97-00, RUNNER POGGIALI 50 2T 02-02, RUNNER SP 50 2T 02-07, RUNNER SP 50 2T 10-12, RUNNER SP SPECIAL EDITION 50 2T 07-07, RUNNER SP ST & SIMONCELLI 50 2T 08-09, STALKER 50 2T 97-11, STALKER NAKED 50 2T 08-08, STALKER SPECIAL EDITION 50 2T 07-08, STORM 50 2T 94-95, STORM EURO 2 50 2T 07-07, TYPHOON 50 2T 94-97, TYPHOON X 50 2T 98-99, TYPHOON XR 50 2T 00-00

- KYMCO** AGILITY 4T CARRY 50 4T 11-11, AGILITY 4T R10 50 4T 06-08, AGILITY 4T R12 50 4T 07-08, AGILITY R12 50 4T 05-05, AGILITY R16 50 4T 08-09, AGILITY R16 50 4T 12-12, AGILITY R16 2T 50 2T 10-10, AGILITY R16 2T 50 2T 12-12, AGILITY RS 50 4T 09-09, AGILITY RS NAKED 50 2T 10-10, B&W 50 2T 02-02, B&W EU2 50 2T 03-03, DINK AC 50 2T 98-02, DINK LC 50 2T 98-02, DINK 50 4T 50 4T 07-07, DINK CLASSIC EU2 50 2T 03-03, FILLY 50 4T 98-00, FILLY LX 50 4T 01-02, HEROISM 50 2T 95-97, LIKE 50 4T 09-09, PEOPLE 50 2T 99-04, PEOPLE EURO 2 50 2T 03-03, PEOPLE EURO 2 50 2T 08-08, PEOPLE EURO 2 50 2T 11-11, PEOPLE S 50 2T 05-08, PEOPLE S 4T 50 4T 06-08, SENTO 50 4T 08-08, SNIPER 50 2T 93-93, SNIPER DD 50 2T 94-96, SUPER 8 50 2T 09-09, SUPER 8 4T 50 4T 07-07, SUPER 8 4T 50 4T 09-09, SUPER 9 50 2T 00-00, SUPER 9 EU2 50 2T 03-04, TOP BOY 50 2T 97-00, VITALITY 2T 50 2T 04-04, VITALITY 4T 50 4T 04-04, YUP 50 2T 02-02, YUP EU2 50 2T 03-03

- PIAGGIO** DIESIS 50 2T 01-01, FLY 2T 50 2T 05-07, FLY 2T 50 2T 10-11, FREE 50 2T 92-94, FREE DELIVERY 50 2T 00-01, FREE FL 50 2T 95-02, LIBERTY 50 2T 97-05, LIBERTY 2T 50 2T 06-08, LIBERTY 2T PTT EU2 50 2T 04-05, LIBERTY 2T RST 50 2T 04-04, LIBERTY 2T SPORT 50 2T 06-08, NRG 50 2T 94-96, NRG EXTREME LC 50 2T 99-00, NRG MC3 50 2T 01-04, NRG POWER DD 50 2T 05-17, NRG POWER DD SERIE SPECIALE 50 2T 07-12, NRG POWER DT 50 2T 06-15, NRG POWER DT SERIE SPECIALE 50 2T 07-08, NRG RST MC2 50 2T 96-98, NTT 50 2T 95-96, QUARTZ 50 2T 92-96, SFERA 50 2T 91-93, SFERA MAQUILLAGE 2 50 2T 94-94, SFERA RST 50 2T 95-97, TYPHOON 50 2T 01-11, TYPHOON 2T E2 50 2T 10-12, TYPHOON 2T E3 CH 50 2T 11-11, VESPA ET2 50 2T 97-05, VESPA ET2 INIEZIONE 50 2T 97-00, VESPA LX 2T 50 2T 05-08, VESPA LX 2T TOURING & 30KM 50 2T 10-13, VESPA LXV 2T 50 2T 06-09, VESPA LXV 2T NAVY 50 2T 08-08, VESPA S 2T & COLLEGE 50 2T 07-12, ZIP 50 2T 92-93, ZIP 50 2T 95-96, ZIP 2T 50 2T 08-13, ZIP BIMODALE 50 2T 94-97, ZIP FAST RIDER 50 2T 93-94, ZIP FAST RIDER RST 50 2T 96-97, ZIP LC 50 2T 00-04, ZIP SP 50 2T 96-04, ZIP SP EURO 2 50 2T 06-13



◀ **cod. RL00041**
Ruota Libera Piaggio Beverly 125/250 cc

RIFERIMENTO ORIGINALE

Piaggio	8477975T
---------	----------

APPLICABILITÀ

- APRILIA** ATLANTIC EU3 125 4T 06-08, SPORT CITY EU3 125 4T 06-08, SR MAX 125 4T 11-14, ATLANTIC EU3 250 4T 06-08, SCARABEO LIGHT 250 4T 06-08, SPORT CITY CUBE 250 4T 08-12
- DERBI** RAMBLA 125 4T 08-09, RAMBLA EU3 2VER 125 4T 08-08, GP1 LOW SEAT EU3 250 4T 07-08, RAMBLA 250 4T 08-09, RAMBLA EU3 2VER 250 4T 08-08
- GILERA** NEXUS IE EU3 125 4T 08-10, NEXUS EU3 250 4T 06-07, NEXUS SP EU3 250 4T 06-07

- PIAGGIO** BEVERLY RST 4T 4V IE EU3 125 4T 10-15, MP3 IBRIDO 125 4T 09-10, MP3 IE 125 4T 08-09, MP3 IE TOURING 125 4T 11-12, VESPA GTS 4T IE SUPER 125 4T 09-16, X7 EVO IE EU3 125 4T 09-10, BEVERLY CRUISER 250 4T 07-09, BEVERLY EURO 3 MIC 250 4T 07-07, BEVERLY IE EU3 250 4T 06-08, BEVERLY SPORT 250 4T 06-08, BEVERLY TOURER EU3 250 4T 07-09, CARNABY 250 4T 08-09, MP3 250 4T 06-08, MP3 LT 250 4T 08-09, MP3 MIC 250 4T 08-09, VESPA GT 60 EU3 250 4T 06-07, VESPA GTS 250 4T 05-16, VESPA GTV 250 4T 06-09, VESPA GTV 4T NAVY EU3 250 4T 07-07, X-EVO 250 4T 07-16, X7 EU3 250 4T 08-08, X8 EU3 250 4T 05-08



◀ **cod. RL00043**
Ruota libera Yamaha T-MAX 530/560 cc dal 2015

RIFERIMENTO ORIGINALE

Yamaha	1WS155900000
--------	--------------

APPLICABILITÀ

- YAMAHA** T-MAX 59C 530 4T 15-16, T-MAX 59C ABS 530 4T 15-16, T-MAX 59C SP 530 4T 15-15, T-MAX 59C SP ABS 530 4T 15-16, XPS30-A T-MAX SX 530 4T 17-19, XPS30D-A T-MAX DX 530 4T 17-19, XPS30E-A T-MAX 530 4T 17-18, MT-07 700 4T 14-16, MT-07 MC MOTO CAGE 700 4T 14-14, MT-07A 700 4T 17-17, MT-07A ABS 700 4T 14-16, MT-07A MC MOTO CAGE 700 4T 14-14, MTT690-A TRACER 700 4T 16-16, XSR 700 4T 16-18

NOVITÀ

ALBERI ENTRATA MOTO



- ◀ cod. **C107488**
 Ingranaggio doppio intermedio Z=12/48 motore scooter 50 cc Minarelli/Yamaha orizzontale corto
- ◀ cod. **C107489**
 Ingranaggio doppio intermedio Z=13/52 motore scooter 50 cc Minarelli/Yamaha verticale e orizzontale lungo

ALBERI USCITA MOTO



- ◀ cod. **C107480**
 Albero uscita moto Z=44 motore scooter 50 cc Minarelli/Yamaha verticale e orizzontale lungo
- ◀ cod. **C107481**
 Albero uscita moto Z=43 motore scooter 50 cc Minarelli/Yamaha verticale e orizzontale lungo



- ◀ cod. **C107491**
 Albero uscita moto per motore scooter 50 cc Piaggio/Gilera

RIFERIMENTO ORIGINALE

Piaggio	478155
---------	--------



- ◀ cod. **C107492**
 Albero uscita moto per motore scooter Piaggio/Gilera 125/150 cc

RIFERIMENTO ORIGINALE

Piaggio	478156
---------	--------

ALBERI MESSA IN MOTO



- ◀ cod. **CI07487**
Albero messa in moto motore scooter 50 cc Minarelli/Yamaha verticale e orizzontale lungo



- ◀ cod. **CI07494**
Albero messa in moto per motore scooter 50 cc Piaggio/Gilera

- ◀ cod. **CI07495**
Albero messa in moto per motore scooter 50 cc Peugeot



- ◀ cod. **CI07497**
Albero messa in moto Vespa PX 125-150-200 cc

RIFERIMENTO ORIGINALE

Piaggio	148570
---------	--------



- ◀ cod. **CI07498**
Albero messa in moto Vespa ET3-50PK-Primavera

RIFERIMENTO ORIGINALE

Piaggio	0789766
---------	---------



- ◀ cod. **CI07499**
Ingranaggio doppio intermedio avviamento scooter Minarelli 50 cc

INGRANAGGI AVVIAMENTO



◀ cod. **CI07490**
Ingranaggio scorrevole messa in moto per motore scooter 50 cc Minarelli/Yamaha



◀ cod. **CI07493**
Ingranaggio scorrevole messa in moto per motore scooter Piaggio 50 cc



◀ cod. **CI07496**
Ingranaggio avviamento Vespa PX 125-150-200 cc

RIFERIMENTO ORIGINALE

Piaggio	1135264
---------	---------

GABBIA / MOLLE / SCODELLINO



◀ cod. **AA00767**
Gabbia a rulli per ruota libera 57x61x10 per motore scooter 50 cc Minarelli/Yamaha



◀ cod. **AA00768**
Molla per scorrevole messa in moto per motore scooter 50 cc Minarelli/Yamaha



◀ cod. **AA00800**
Scodellino dentato per motore scooter 50 cc Gilera/Piaggio

GRUPPI INGRANAGGI SECONDARI



◀ cod. **CI07450**
Coppia ingranaggi secondari
Scarabeo '96 - Carosello
Numero denti: 12/44 - Rapporto: 1:3,66

◀ cod. **CI07451**
Coppia ingranaggi secondari Minarelli/Yamaha
Flipper - Why
Numero denti: 13/43 - Rapporto: 1:3,30

◀ cod. **CI07452**
Coppia ingranaggi secondari Minarelli/Yamaha
Booster
Numero denti: 13/42 - Rapporto: 1:3,23

INTERMITTENZE



◀ cod. **ME00001**
Intermittenza frecce Vespa PX125-150-200

RIFERIMENTO ORIGINALE

Piaggio	195703
---------	--------

MAXI SCOOTER



◀ cod. **SG15709**
Serie segmenti tipo originale per Kymco 125 cc

RIFERIMENTO ORIGINALE

Kymco	00123728
-------	----------

APPLICABILITÀ

KYMCO AGILITY R16 125 4T 08-09, B&W 125 4T 00-00, DINK 125 4T 97-98, DINK CLASSIC 125 4T 02-02, DINK CLASSIC EU2 125 4T 03-03, DINK LX 125 4T 98-00, GRAND DINK 125 4T 01-02, HEROISM 125 4T 95-97, LIKE 125 4T 09-09, MOVIE 125 4T 99-00, MOVIE EU3 125 4T 06-07, MOVIE XL 125 4T 01-01, PEOPLE 125 4T 99-00, PEOPLE EU3 125 4T 07-08, SUPER 8 125 4T 08-09, VIVIO 125 4T 00-00

◀ cod. **SG15710**
Serie segmenti tipo originale per Kymco 150 cc

RIFERIMENTO ORIGINALE

Kymco	00123740
-------	----------

APPLICABILITÀ

KYMCO AGILITY R16 150 4T 08-09, B&W 150 4T 00-00, DINK 150 4T 97-98, DINK CLASSIC 150 4T 02-02, DINK CLASSIC EU2 150 4T 03-03, DINK LX 150 4T 98-00, GRAND DINK 150 4T 01-02, HEROISM 150 4T 95-97, MOVIE EU3 150 4T 06-07, PEOPLE 150 4T 99-00, VIVIO 150 4T 00-00

◀ cod. **SG15711**
Serie segmenti tipo originale per Honda Pantheon 150

APPLICABILITÀ

HONDA PANTHEON [FES] 150 2T 98-02

◀ cod. **SG15712**
Serie segmenti tipo originale per Suzuki Burgman 400

RIFERIMENTO ORIGINALE

Suzuki	12140-15F00-000
--------	-----------------

APPLICABILITÀ

SUZUKI AN BURGMAN K3/K6 400 4T 03-06, AN BURGMAN X/K2 400 4T 99-02



- cod. **SD00002**
Statore per 50 cc Minarelli/Yamaha volano **Ducati**



- cod. **SD00010**
Statore per Minarelli AM6 volano **Ducati** (cavo lungo)
- cod. **SD00011**
Statore per Minarelli AM6 volano **Ducati** (cavo corto)



- cod. **ST00002**
Statore completo per motore Minarelli/Yamaha 125 cc

RIFERIMENTO ORIGINALE

Yamaha	5DSH55100000
--------	--------------

Mbk	5DSH55100000
-----	--------------

APPLICABILITÀ

MBK DOODO 125 4T 00-00, SKYLINER 125 4T 98-02, SKYLINER E 125 4T 03-03, THUNDER 125 4T 01-02, DOODO 150 4T 01-02, SKYLINER 150 4T 00-02, THUNDER 150 4T 01-02, SKYLINER E 180 4T 03-03

YAMAHA MAJESTY 125 4T 98-00, MAJESTY (SNR1) 125 4T 01-01, MAJESTY (SNR8) 125 4T 02-02, MAJESTY E 125 4T 03-09, MAXSTER 125 4T 01-02, TEO'S 125 4T 00-00, MAJESTY 150 4T 00-00, MAJESTY (SNS1) 150 4T 01-01, MAJESTY (SNS6) 150 4T 02-02, MAXSTER 150 4T 01-02, TEO'S 150 4T 01-02, MAJESTY E 180 4T 03-06



- cod. **ST00004**
Statore per scooter 50 cc 4T Piaggio/Gilera

RIFERIMENTO ORIGINALE

Piaggio	969228
Aprilia	969228

Derbi	969228
-------	--------

APPLICABILITÀ

APRILIA SCARABEO 4T 50 4T 02-06, SCARABEO 4T RESTYLING EU3 50 4T 06-09, SPORT CITY ONE 4T 50 4T 08-10, SCARABEO 4T 100 4T 01-05, SCARABEO 4T 100 4T 10-12, SCARABEO 4T NET 100 4T 09-09, SCARABEO 4T NET EU3 100 4T 10-10, SCARABEO 4T RESTYLING 100 4T 06-09

DERBI ATLANTIS 4T 50 4T 04-06, ATLANTIS 4T EU2 50 4T 07-07, BOULEVARD 4T EU2 25KM/H 50 4T 09-09, BOULEVARD 4T 100 4T 10-11

PIAGGIO FLY 4T 50 4T 05-07, FLY 4T & 25-30 KM/H 50 4T 08-11, FLY 4T MOTORE CHN 50 4T 06-07, LIBERTY 4T 50 4T 00-02, LIBERTY 4T 50 4T 05-08, LIBERTY 4T 3V IE 50 4T 3V 15-17, LIBERTY 4T 3V IE E4 50 4T 3V 17-18, LIBERTY 4T DELIVERY - SINGLE 50 4T 10-14, LIBERTY 4T DELIVERY TNT 50 4T 09-09, LIBERTY 4T PTT - DOUBLE - NEXIVE 50 4T 09-17, LIBERTY 4T RST 50 4T 04-04, LIBERTY 4T SPORT 50 4T 06-08, LIBERTY MOC 4T & ELLE 50 4T 09-16, VESPA ET4 50 4T 00-05, VESPA LX 4T 50 4T 05-09, ZIP 4T 50 4T 00-13, FLY 100 4T 06-14, FREE 100 4T 02-03, ZIP 4T 100 4T 06-10



◀ **cod. ST00005**
Statore per scooter 500 cc Piaggio

RIFERIMENTO ORIGINALE

Piaggio	58080R
---------	--------

Gilera	58080R
--------	--------

APPLICABILITÀ

APRILIA ATLANTIC SPRINT 400 4T 05-08, SCARABEO LIGHT 400 4T 06-08, ATLANTIC 500 4T 01-04, ATLANTIC SPRINT 500 4T 05-08, SCARABEO 500 4T 03-06, SCARABEO LIGHT 500 4T 06-08
GILERA NEXUS 500 4T 03-05, NEXUS EU3 500 4T 06-11, NEXUS SP EU3 500 4T 06-07

PIAGGIO BEVERLY EU3 400 4T 06-07, X-EVO 400 4T 07-11, X8 EU3 400 4T 06-08, BEVERLY 500 4T 02-06, BEVERLY IE EU3 500 4T 06-08, X9 500 4T 01-02, X9 EVOLUTION 500 4T 03-07, X9 EVOLUTION ABS 500 4T 06-07



◀ **cod. ST00007**
Statore per Derbi Senda 85w (nuovo modello)

RIFERIMENTO ORIGINALE

Derbi	00H03300701
-------	-------------

APPLICABILITÀ

APRILIA RX 50 2T 06-10, SX 50 2T 06-13
DERBI BULTACO LOBITO 50 2T 98-01, SENDA BLACK EDITION 50 2T 03-03, SENDA HYP DRD EVO EU2 50 2T 08-09, SENDA R 50 2T 99-99, SENDA R DRD BLACK DEVIL 2A EDIZIONE 50 2T 03-03, SENDA R DRD EU1 EU1R 50 2T 02-02, SENDA R DRD RACING 50 2T 04-05, SENDA R DRD RACING EU2 50 2T 05-08, SENDA R DRD RACING LTD 50 2T 05-05, SENDA R DRD X-TREME 2T EU2 50 2T 14-15, SENDA R DRD X-TREME 2T EURO2 50 2T 10-12, SENDA R RACER 50 2T 03-03, SENDA R X-RACE 50 2T 04-05, SENDA R X-RACE 2T EU2 50 2T 10-10, SENDA R X-RACE EU2 50 2T 06-09, SENDA R X-TREME 50 2T 05-05, SENDA R X-TREME 2T EU2 50 2T 10-10, SENDA R X-TREME EU2 50 2T 05-08, SENDA SM 50 2T 00-01, SENDA SM DRD EDITION BLACK 50 2T 05-05, SENDA SM DRD EU1 EU1R 50 2T 02-03, SENDA SM DRD RACING 50 2T 04-05, SENDA SM DRD RACING EU2 50 2T 05-08, SENDA SM DRD RACING EU2 50 2T 10-13, SENDA SM DRD RACING LTD 50 2T 05-05, SENDA SM DRD RACING LTD EU2 50 2T 07-07, SENDA SM DRD X-TREME 2T EU2 50 2T 14-15, SENDA SM DRD X-TREME 2T EU2 LIMITED ED 50 2T 14-15, SENDA SM X-RACE 50 2T 04-05, SENDA SM X-RACE 2T EU2 50 2T 10-10, SENDA SM X-RACE EU2 50 2T 06-09, SENDA SM X-RACE EU2 2VER 50 2T 07-09, SENDA SM X-TREME 50 2T 02-03, SENDA SM X-TREME 2T EU2 50 2T 10-10, SENDA SM X-TREME EU2 50 2T 04-08, SENDA SM X-TREME EU2 2A EDIZIONE 50 2T 05-05

GILERA RCR 50 2T 06-07, RCR 50 2T 11-12, RCR (CHE-SYC) 50 2T 13-15, SMT 50 2T 03-03, SMT 50 2T 06-17, SMT RACING 50 2T 11-12



◀ **cod. ST00008**
Statore per Derbi Senda GPR

RIFERIMENTO ORIGINALE

Derbi	00H03360011
-------	-------------

APPLICABILITÀ

APRILIA RS 50 2T 06-10, RS4 50 2T 11-13, RS4 REPLICA 50 2T 14-16, RX 50 2T 14-16, SX 50 2T 14-16, SX LIMITED EDITION 50 2T 14-16

DERBI GPR 2T EU2 50 2T 09-10, GPR NUDE & GPR NUDE TUNING 50 2T 06-08, GPR NUDE SPORT 50 2T 06-06, GPR R EU2 - GPR REPLICA EU2 50 2T 08-08, GPR RACING EU2 50 2T 06-06, GPR REPLICA & GPR R EU2 50 2T 06-06, GPR REPLICA 2T MALOSSÌ 50 2T 07-07, GPR REPLICA PESEK EU2 50 2T 07-07, SENDA HYP DRD EVO LIMITED EDITION EU2 50 2T 08-08, SENDA R DRD PRO EU2 50 2T 05-11, SENDA SM DRD PRO EU2 50 2T 05-11, SENDA SM DRD PRO EU2 2VER 50 2T 05-08

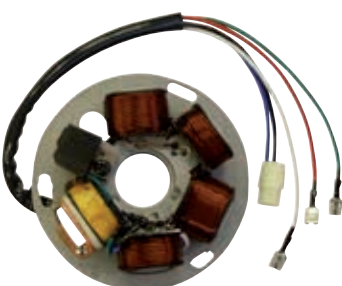

◀ **cod. ST00012**
Statore per Piaggio Vespa PX 125

RIFERIMENTO ORIGINALE

Piaggio	217866
---------	--------

APPLICABILITÀ

PIAGGIO VESPA PX 125 2T 98-01, VESPA PX 125 2T 11-16, VESPA PX 30 ANNI 125 2T 07-08, VESPA PX E ARCOBALENO 125 2T 81-97, VESPA PX EU2 125 2T 01-07, VESPA PX 150 2T 98-01, VESPA PX 150 2T 11-16, VESPA PX E ARCOBALENO 150 2T 81-97, VESPA PX 200 2T 98-01, VESPA PX E ARCOBALENO 200 2T 81-97

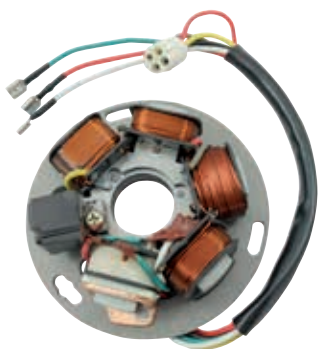

◀ cod. **ST00015**
Statore per Piaggio Vespa 125 Pxe arcobaleno

APPLICABILITÀ

PIAGGIO VESPA PX E ARCOBALENO 125 2T 81-97, VESPA PX E ARCOBALENO 150 2T 81-97, VESPA PX E ARCOBALENO 200 2T 81-97



◀ cod. **ST00019**
Statore Per Yamaha T-Max 500 cc 2004-2007

RIFERIMENTO ORIGINALE

Yamaha	5VU814100000
--------	--------------

APPLICABILITÀ

YAMAHA T-MAX 5VU 500 4T 04-07, T-MAX 5VU ABS 500 4T 05-07, T-MAX 5VU BLACK MAX 500 4T 06-06, T-MAX 5VU BLACK MAX - NIGHT MAX 500 4T 07-07



◀ cod. **ST00020**
Statore Per Yamaha T-Max 530/560 cc

RIFERIMENTO ORIGINALE

Yamaha	59C814100000
--------	--------------

APPLICABILITÀ

YAMAHA T-MAX 59C 530 4T 12-16, T-MAX 59C ABS 530 4T 12-16, T-MAX 59C SP 530 4T 15-15, T-MAX 59C SP ABS 530 4T 15-16, XP530-A T-MAX SX 530 4T 17-19, XP530D-A T-MAX DX 530 4T 17-19, XP530E-A T-MAX 530 4T 17-18



◀ cod. **ST00021**
Statore Per Yamaha T-Max 500 cc 2008-2011

RIFERIMENTO ORIGINALE

Yamaha	4B5814100000
--------	--------------

APPLICABILITÀ

YAMAHA T-MAX 4B5 500 4T 09-11, T-MAX 4B5 ABS 500 4T 08-11, T-MAX 5VU 500 4T 08-08, T-MAX SV 500 4T 11-11, T-MAX SV ABS 500 4T 10-11, T-MAX WHITE MAX 500 4T 10-10



◀ **cod. ST00022**
Statore per Yamaha Majesty 400 cc

APPLICABILITÀ

YAMAHA MAJESTY 400 4T 04-11, MAJESTY ABS 400 4T 07-11, X-MAX 400 4T-4V 13-14, X-MAX ABS 400 4T-4V 14-17, X-MAX IRONMAX ABS 400 4T-4V 16-16, X-MAX MOMO-DESIGN 400 4T-4V 14-14, X-MAX MOMODESIGN ABS 400 4T-4V 14-14, X-MAX RA 400 4T-4V 18-18



◀ **cod. ST00023**
Statore Per Piaggio Beverly 250/300 cc

RIFERIMENTO ORIGINALE

Piaggio	58070R
---------	--------

APPLICABILITÀ

APRILIA ATLANTIC EU3 125 4T 06-08, SPORT CITY EU3 125 4T 06-08, SR MAX 125 4T-4V 11-14, ATLANTIC EU3 250 4T 06-08, SCARABEO LIGHT 250 4T 06-08, SPORT CITY CUBE 250 4T 08-12, SCARABEO LIGHT 300 4T 09-10

DERBI RAMBLA 125 4T 08-09, RAMBLA EU3 2VER 125 4T 08-08, GP1 LOW SEAT EU3 250 4T 07-08, RAMBLA 250 4T 08-09, RAMBLA 300 4T 10-11

GILERA NEXUS IE EU3 125 4T 08-10, NEXUS EU3 250 4T 06-07, NEXUS SP EU3 250 4T 06-07, NEXUS EU3 300 4T 08-11

PIAGGIO MP3 IBRIDO 125 4T 09-10, MP3 IE 125 4T 08-09, BEVERLY CRUISER 250 4T 07-09, BEVERLY EURO 3 MIC 250 4T 07-07, BEVERLY IE EU3 250 4T 06-08, BEVERLY SPORT 250 4T 06-08, BEVERLY TOURER EU3 250 4T 07-09, CARNABY 250 4T 08-09, MP3 250 4T 06-08, MP3 LT 250 4T 08-09, MP3 MIC 250 4T 08-09, VESPA GT 60 EU3 250 4T 06-07, VESPA GTS 250 4T 05-16, VESPA GTS ABS 250 4T 05-12, VESPA GTV 250 4T 06-09, VESPA GTV 4T NAVY EU3 250 4T 07-07, X-EVO 250 4T 07-16, X7 EU3 250 4T 08-08, X8 EU3 250 4T 05-08, BEVERLY TOURER EU3 300 4T 09-10, CARNABY CRUISER 300 4T 09-12, VESPA GTV VIA MONTENAPOLEONE 300 4T 10-10



◀ **cod. ST00024**
Statore Per Honda SH 300 cc 2007-2010

RIFERIMENTO ORIGINALE

Honda	31120-KTW-901
-------	---------------

APPLICABILITÀ

HONDA SH IE SCOOPY 300 4T-4V 07-10



◀ **cod. ST00025**
Statore Kymco Agility 125/150 cc '08-'12

APPLICABILITÀ

KYMCO AGILITY R16 125 4T 08-09, AGILITY R16 125 4T 12-12, AGILITY RS 125 4T 09-09, LIKE 125 4T 09-09, LIKE LX 125 4T 09-09, LIKE LX 125 4T 12-12, AGILITY R16 150 4T 08-09



◀ cod. **ST00026**
Statore Per Honda SH 125 cc le 2005-2012

RIFERIMENTO ORIGINALE

Honda	31120-KTF-640
-------	---------------

APPLICABILITÀ

HONDA SH IE SCOOPY 125 4T-2V 05-12, SH IE SCOOPY 150 4T 05-12



◀ cod. **ST00027**
Statore per Kymco People 125/150 cc

APPLICABILITÀ

KYMCO PEOPLE 125 4T 99-00, PEOPLE EU2 125 4T 03-03, PEOPLE EU3 125 4T 07-08, PEOPLE EU3 125 4T 11-11, PEOPLE 150 4T 99-00, PEOPLE EU2 150 4T 03-03

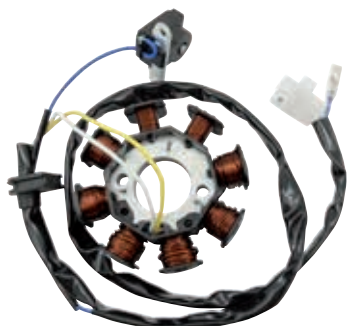

◀ cod. **ST00028**
Statore per Kymco Agility 50 cc 4T '05-'08

APPLICABILITÀ

KYMCO AGILITY 4T R10 50 4T 06-08, AGILITY 4T R12 50 4T 07-08, AGILITY R12 50 4T 05-05, DINK 50 4T 50 4T 07-07, FILLY 125 4T 98-00, FILLY LX 50 4T 01-02, PEOPLE S 4T 50 4T 06-08, SENTO 50 4T 08-08, VITALITY 4T 50 4T 04-04



◀ cod. **ST00029**
Statore per Sym Joyride 125/150/200 cc

APPLICABILITÀ

SYM HD EU2 125 4T-4V 03-04, HD EU3 125 4T-4V 07-08, HD EVO 125 4T-4V 05-06, HD EVO EU3 125 4T-4V 07-08, HD EVO EU3 125 4T-4V 10-11, HD EVO TAMBURO EU3 125 4T-4V 08-09, HD2 125 4T-4V 11-11, HD2 125 4T-4V 14-14, JOYRIDE 125 4T-4V 01-02, JOYRIDE EU2 125 4T-4V 03-06, JOYRIDE EU3 125 4T-4V 07-07, JOYRIDE EVO 125 4T-4V 09-10, JOYRIDE EVO 125 4T-4V 13-14, JOYRIDE 150 4T-4V 01-02, HD EU2 200 4T-4V 03-04, HD EVO EU2 200 4T-4V 05-06, JOYRIDE 200 4T-4V 03-03, JOYRIDE EU2 200 4T-4V 03-06



◀ **cod. 27-7015**

Suzuki Stator Coil
0.5k

MAKE / MODEL	YEAR
Suzuki GSX-R600	2001-2003
Suzuki GSX-R750	2000-2003



◀ **cod. 27-7016**

Yamaha Stator Coil
12 Volt

MAKE / MODEL	YEAR
Yamaha YZF-R6	1999-2002



◀ **cod. 27-7017**

Honda Stator Coil
12 Volt

MAKE / MODEL	YEAR
Honda CBR1000RR	2006-2007
Honda CBR1000RR Repsol Edition	2006-2007



◀ **cod. 27-7033**

Suzuki Stator Coil
12 Volt

MAKE / MODEL	YEAR
Suzuki GSX-R600	2011-2015
Suzuki GSX-R750	2011-2015



cod. **XX01021**

Valvola lamellare per motori scooter 50 cc Minarelli/Yamaha tipo verticale.
Lamella acciaio spess. 0,15 mm

APPLICABILITÀ

APRILIA AMICO 50 2T 94-94, AMICO 50 2T 96-98, AMICO GL/GLE 50 2T 93-95, AMICO LX/SPORT/CAT 50 2T 92-93, SR (VERTICALE) 50 2T 93-93

MBK BOOSTER 50 2T 90-04, BOOSTER 50 2T 90-94, BOOSTER EURO 2 50 2T 04-04, BOOSTER NG 50 2T 95-03, BOOSTER ROCKET 50 2T 97-98, BOOSTER SPIRIT 50 2T 96-00, BOOSTER SPIRIT 50 2T 03-03, BOOSTER SPIRIT EURO2 50 2T 03-03, BOOSTER TRACK 50 2T 96-98, STUNT 50 2T 00-02

YAMAHA BW'S 50 2T 97-16, BW'S BUMP 50 2T 97-98, BW'S EASY 50 2T 13-13, BW'S NAKED 50 2T 03-04, BW'S NAKED 50 2T 09-16, BW'S NEXT GENERATION 50 2T 97-06, BW'S ORIGINAL 50 2T 99-01, BW'S ORIGINAL EURO 2 50 2T 03-03, RS SPY 50 2T 95-98, SLIDER 50 2T 00-02, ZUMA 50 2T 97-10



cod. **XX01022**

Valvola lamellare per motore scooter 50 cc Minarelli/Yamaha tipo orizzontale.
Lamella acciaio spess. 0,15 mm

APPLICABILITÀ

APRILIA AREA 51 50 2T 98-00, GULLIVER 50 2T 95-98, GULLIVER LC 50 2T 96-98, RALLY 50 2T 95-03, RALLY LIQUID COOLED 50 2T 96-99, SCARABEO 50 2T 93-05, SONIC 50 2T 98-07, SONIC GP 50 2T 98-08, SR (ORIZZONTALE) 50 2T 94-96, SR LIQUID COOLED 50 2T 94-96, SR RACING 50 2T 97-99, SR STEALTH 50 2T 97-00, SR WWW 50 2T 97-01

ATALA CAROSELLO 50 2T 99-01

BENELLI 491 GT 50 2T 98-99, 491 NAKED 50 2T 02-02, 491 RACING 50 2T 98-99, 491 RR 50 2T 99-01, 491 SP 50 2T 99-99, 491 SPORT 50 2T 98-99, 491 ST 50 2T 99-01, K2 50 2T 98-01, K2 LIQUID COOLED 50 2T 98-01, PEPE 50 2T 99-01, PEPE LX 50 2T 03-04

BETA ARK 50 2T 96-08, ARK LC 50 2T 96-08, CHRONO 50 2T 95-96, EIKON 50 2T 99-03, QUADRA 50 2T 95-95, QUADRA 50 2T 99-01, TEMPO 50 2T 93-02, TEMPO 50 2T 95-95

ITALJET DRAGSTER 50 2T 98-02

KTM K50 50 2T 96-01

MACAL THUNDER 50 2T 95-96

MALAGUTI CENTRO SL 50 2T 94-98, CIAK 50 2T 99-01, CIAK EURO 2 2,3 50 2T 03-03, CIAK EURO2 50 2T 01-03, CIAK MASTER EURO 2 50 2T 06-06, F10 50 2T 92-00, F10 EURO 2 50 2T 02-06, F10 EURO 2 2,3 50 2T 03-04, F10 RESTYLING EURO 2 50 2T 06-06, F12 PHANTOM 50 2T 94-98, F12 PHANTOM EURO 2 50 2T 02-02, F12 PHANTOM EURO 2 2,3 50 2T 03-04, F12 PHANTOM LC 50 2T 94-98, F12 PHANTOM LC EURO 2 2,3 50 2T 03-04, F12 R PHANTOM LC 50 2T 07-10, F12 RESTYLING EURO 1 50 2T 99-02, F12 RESTYLING EURO 2 50 2T 06-06, F12 RESTYLING LC EURO 2 50 2T 06-06, F15 FIRE FOX 50 2T 96-98, F15 FIRE FOX AIR COOLED 50 2T 05-06, F15 FIRE FOX EURO 2 50 2T 02-06, F15 FIRE FOX EURO 2 2,3 50 2T 03-04, YESTERDAY 50 2T 97-00

MBK EVOLIS 50 2T 92-95, FIZZ 50 2T 94-95, FLIPPER 50 2T 98-04, FLIPPER EURO 2 50 2T 03-03, FORTE 50 2T 94-96, MACH G 50 2T 02-04, MACH G LC 50 2T 02-04, NITRO 50 2T 97-04, NITRO EURO 2 50 2T 03-03, OVETTO 50 2T 97-04, OVETTO EURO 2 50 2T 02-02

MOTRON SYNCRO 50 2T 98-00, THUNDER 50 2T 95-98

RIEJU FIRST 50 2T 95-98, WINDY 50 2T 95-98

YAMAHA AEROX 50 2T 97-02, AEROX 50 2T 04-16, AEROX EURO 2 50 2T 03-03, AEROX NAKED 50 2T 13-16, AEROX R 50 2T 99-00, AXIS 50 2T 95-96, BREEZE 50 2T 94-95, JOG 50 2T 92-01, JOG R 50 2T 02-02, JOG R EURO2 50 2T 02-02, JOG R EURO2 50 2T 06-15, JOG R LC 50 2T 02-15, NEO'S 50 2T 97-02, NEO'S 50 2T 04-16, NEO'S EASY 50 2T 13-13, NEO'S EURO 2 50 2T 02-02, WHY 50 2T 98-05, WHY EURO 2 50 2T 03-05, ZEST 50 2T 95-92







◀ cod. **CF12750**
Cilindretto freno Piaggio Ape posteriore

RIFERIMENTO ORIGINALE

Piaggio	127908
---------	--------

APPLICABILITÀ

PIAGGIO APE CAR P2 (1° SERIE) 220 2T 78-82, APE P 501 220 2T 78-85, APE P 601 220 2T 78-83

◀ cod. **CF12754**
Cilindretto freno Piaggio Ape posteriore

RIFERIMENTO ORIGINALE

Piaggio	245193
---------	--------

APPLICABILITÀ

PIAGGIO APE TM 220 2T 09-16, APETM P 602 220 2T 82-83, APETM P 703 - P 703 V, FL2 220 2T 84-05

◀ cod. **CF12755**
Cilindretto freno Piaggio Ape TM anteriore

RIFERIMENTO ORIGINALE

Piaggio	245194
---------	--------

APPLICABILITÀ

PIAGGIO APETM 220 2T 09-16, APETM P 602 220 2T 82-83, APETM P 703 - P 703 V, FL2 220 2T 84-05

◀ cod. **CF12757**
Cilindretto freno Piaggio Ape posteriore

RIFERIMENTO ORIGINALE

Piaggio	245765
---------	--------

APPLICABILITÀ

PIAGGIO APE 50 2T 09-17, APE FL - FL2 50 2T 89-95, APE FL3 EUROPA 50 2T 96-99, APE MIX 2T 50 2T 98-08, APE RST MIX 50 2T 99-03

FILTRI BENZINA



◀ cod. **FT07500**
Filtro benzina codulo piccolo Ø 6
(24 pezzi)

◀ cod. **FT07501**
Filtro benzina codulo grosso Ø 8
(24 pezzi)



◀ cod. **FZ00301**
Serie dischi frizione vespa 50-90-125 pk
(3 pezzi)

◀ cod. **FZ00302**
Disco frizione singolo vespa 50-90-125 pk
(Conf. da 50 pezzi)



◀ cod. **FZ00313**
Serie dischi frizione
Vespa px 125 - 150 dal '98

RICAMBI
ML06181 SERIE 8 MOLLE RINFORZATE



◀ cod. **FZ00303**
Serie dischi frizione
Vespa 125-150 px (3 pezzi)



◀ cod. **FZ00318**
Serie speciale dischi frizione
Vespa p 200e

RICAMBI
ML00821 SERIE 6 MOLLE RINFORZATE PX 125 -150



◀ cod. **FZ00305**
Serie dischi frizione
Vespa p 200 e (3 pezzi)



◀ cod. **FZ00320**
Massette di trascinamento con molla
per Piaggio - Ciao - Bravo - Si
senza variatore

RIFERIMENTO ORIGINALE
Piaggio 104480



◀ cod. **FZ00306**
Serie speciale dischi frizione
Vespa 50-90-125, 50 -125 pk (7 pezzi)

RICAMBI
ML00820 MOLLA RINFORZATA PER VESPA 50



◀ cod. **FZ00329**
Serie dischi frizione
Vespa 50 - 125 fl-hp con 6 molle



◀ cod. **FZ00307**
Serie speciale dischi frizione
Vespa px 125 - 150 (7 pezzi)

RICAMBI
ML00821 SERIE 6 MOLLE RINFORZATE PX 125 -150



◀ cod. **CP00200**
Coppia ceppi Ø 90 x 18
con molle

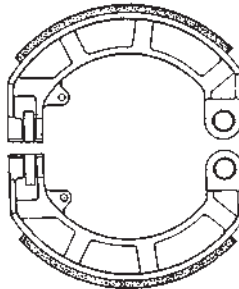

◀ cod. **CP00210**
Coppia ceppi Ø 150x24
Piaggio Vespa

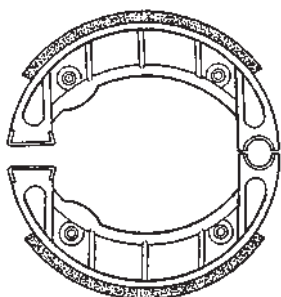

◀ cod. **CP00201**
Coppia ceppi Ø 105 x 20
con molle

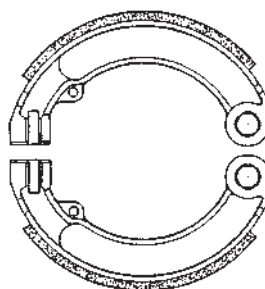

◀ cod. **CP00211**
Coppia ceppi Ø 125x19
Piaggio Vespa

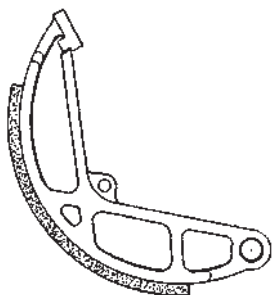

◀ cod. **CP00208**
Ceppo Ciao
Ø 136x17 (serie da 2 pezzi)
posteriore

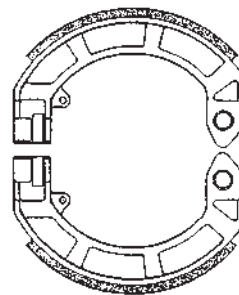

◀ cod. **CP00212**
Coppia ceppi Ø 150 x 24
Piaggio Vespa PX - PK
anteriore e posteriore

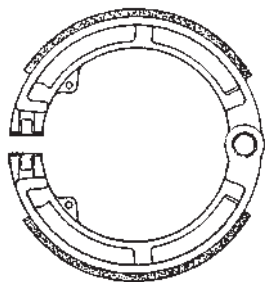

◀ cod. **CP00209**
Coppia ceppi Ø 125x17
Piaggio Vespa

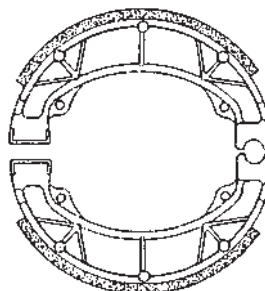

◀ cod. **CP00219**
Coppia ceppi Ø 110 x 25

APPLICABILITÀ

APRILIA Amico, Gulliver, SR post.

MALAGUTI F10, F12, F15 post.

PEUGEOT Geo, Zenith, Buxy, Speedake post.

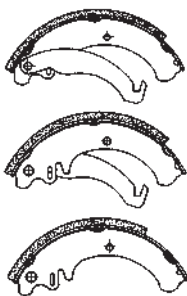

x 2 pezzi

◀ cod. **CP00223**
Serie ceppi Ø 160 x 32
(serie da 4 pezzi)
Piaggio Ape 50
posteriore

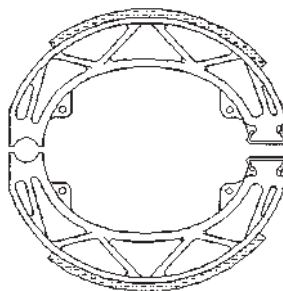

◀ cod. **CP00243**
Coppia ceppi Ø 140 x 25
Piaggio Liberty 50 cc

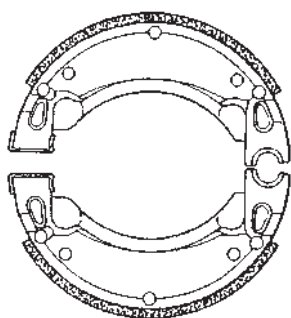

◀ cod. **CP00239**
Coppia ceppi Ø 110 x 25
MBK Booster 50 cc
anteriore e posteriore

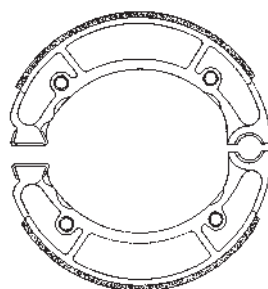

◀ cod. **CP00244**
Coppia ceppi Ø 160 x 30
Yamaha Majesty 250 cc

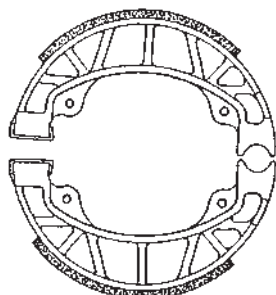

◀ cod. **CP00240**
Coppia ceppi Ø 110 x 25
Piaggio Skipper 50 cc
posteriore

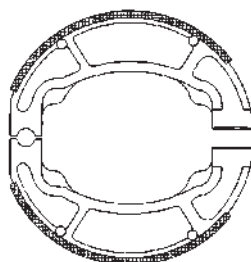

◀ cod. **CP00248**
Coppia ceppi Ø 125 x 25
Honda @ 125/150 cc

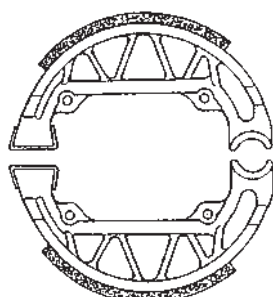

◀ cod. **CP00242**
Coppia ceppi Ø 100 x 20
Sfera 95 (post.)
Quartz-Zip-Typhoon

APPLICABILITÀ

GILERA Typhoon 50 cc (modelli dopo il '95)
PIAGGIO Sfera, Zip, Quartz

CILINDRO IN ALLUMINIO



cod. **KT00135**

Gruppo termico High Performance Ø 57 **Cilindro in alluminio** Piaggio Vespa 125 cc ET3

APPLICABILITÀ

PIAGGIO VESPA ET3 125 2T 76-83, VESPA PRIMAVERA 125 2T 67-83

RICAMBI

GR00748	Serie Guarnizioni
PTA0160	Pistone completo Ø 57 Sel.A
PTB0160	Pistone completo Ø 57 Sel.B

PTC0160	Pistone completo Ø 57 Sel.C
TS00187	Testa

NOVITÀ

CILINDRO IN ALLUMINIO

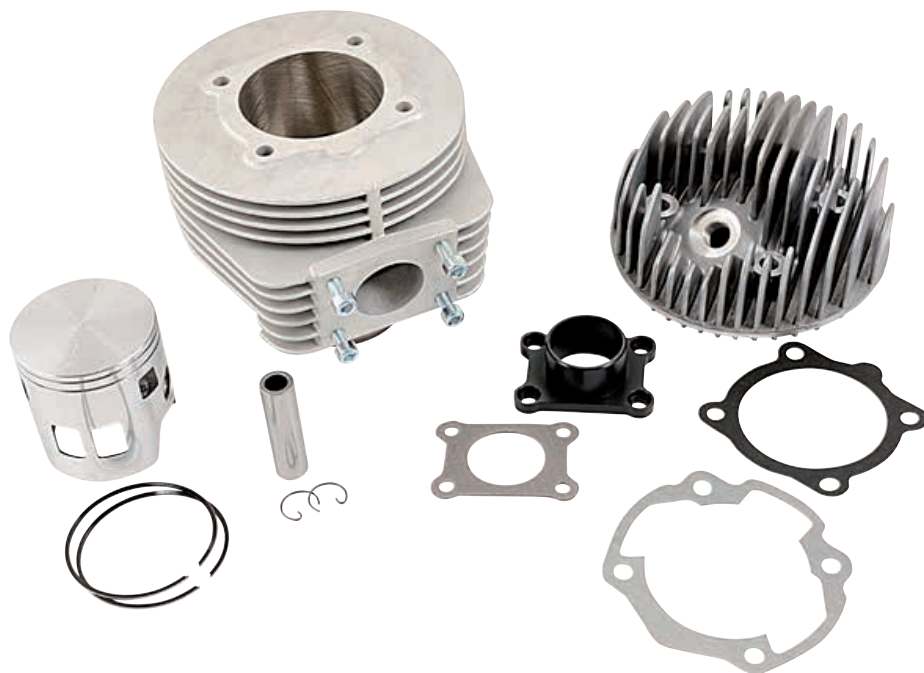

cod. **KT00136**

Gruppo termico High Performance Ø 63 **Cilindro in alluminio** Vespa Px

APPLICABILITÀ

LML STAR DELUXE EU1 125 2T 01-03, STAR DELUXE EU3 125 2T 08-09, STAR DELUXE EU1 150 2T 01-03, STAR DELUXE EU3 150 2T 08-09

PIAGGIO VESPA PX 125 2T 98-01, VESPA PX 125 2T 11-16, VESPA PX 30 ANNI 125 2T 07-08, VESPA PX E ARCOBALENO 125 2T 81-97, VESPA PX EU2 125 2T 01-07, VESPA PX 150 2T 98-01, VESPA PX E ARCOBALENO 150 2T 81-97

RICAMBI

PTA0161	Pistone completo Ø 63 sel. A
PTB0161	Pistone completo Ø 63 sel. B
PTC0161	Pistone completo Ø 63 sel. C
SG15874	Serie Segmenti

GR00752	Serie Guarnizioni
TS00188	Testa
AA00900	Flangia di scarico

ATTENZIONE: QUESTI PRODOTTI SONO DESTINATI ESCLUSIVAMENTE AD USO AGONISTICO. NE È QUINDI VIETATO L'UTILIZZO SU STRADA PUBBLICA.



◀ cod. **KT00004**
Gruppo termico Ø 38,4 Ciao spinotto 12

APPLICABILITÀ

PIAGGIO PIAGGIO: BOSS 50 2T 88-89, BOXER 50 2T 70-83, BRAVO 3 50 2T 87-90, BRAVO ERRE 2 50 2T 75-81, CIAO 50 2T 80-88, CIAO EU1 50 2T 99-01, CIAO EU2 50 2T 02-04, CIAO MIX TEEN 50 2T 96-01, CIAO TRE 50 2T 71-99, GRILLO 50 2T 89-93, SI 50 2T 79-88, SI FL2 50 2T 91-97, SI MIX 50 2T 96-99

RICAMBI

GR06336	Guarnizione Base Ciao	PT00053	Pistone Ø 38,4 Ciao Sp.12
----------------	-----------------------	----------------	---------------------------

◀ cod. **KT00005**
Gruppo termico Ø 38,4 Ciao spinotto 10

APPLICABILITÀ

PIAGGIO BOSS 50 2T 88-89, BOXER 50 2T 70-83, BRAVO 3 50 2T 87-90, BRAVO ERRE 2 50 2T 75-81, CIAO 50 2T 80-88, CIAO EU1 50 2T 99-01, CIAO EU2 50 2T 02-04, CIAO MIX TEEN 50 2T 96-01, CIAO TRE 50 2T 71-99, GRILLO 50 2T 89-93, SI 50 2T 79-88, SI FL2 50 2T 91-97, SI MIX 50 2T 96-99

RICAMBI

GR06336	Guarnizione Base Ciao	PT00054	Pistone Ø 38,4 Ciao Sp.10
----------------	-----------------------	----------------	---------------------------



◀ cod. **KT00010**
Gruppo termico Ø 38,4 per Vespa 50

APPLICABILITÀ

PIAGGIO APE 50 2T 09-17, APE FL - FL2 50 2T 89-95, APE FL3 EUROPA 50 2T 96-99, APE MIX 2T 50 2T 98-08, APE P 50 2T 80-85, APE RST MIX 50 2T 99-03, APE TM P 50 2T 85-89, VESPA FL 50 2T 90-90, VESPA FL2 HP 50 2T 91-97, VESPA N 50 2T 89-90, VESPA PK 50 2T 82-84, VESPA PK XL 50 2T 85-88, VESPA PK XL RUSH 50 2T 88-89, VESPA SPECIAL-L-R 50 2T 67-82

RICAMBI

GR00727	Serie Guarnizioni	SG15002	Serie Segmenti Ø 38,4
PT00057	Pistone completo Ø 38,4		



◀ cod. **KT00113**
Gruppo termico Ø 39 Honda SH-SFX-Bali senza testa

APPLICABILITÀ

HONDA BALI 50 2T 93-99, SFX / SXR 50 2T 95-01, SGX SKY 50 2T 97-04, SH NEW 50 2T 96-01, X8R S 50 2T 98-01, X8R X 50 2T 98-01

RICAMBI

GR00724	Serie Guarnizioni	SG15868	Serie Segmenti Ø 39
PT00105	Pistone completo Ø 39		

ATTENZIONE: QUESTI PRODOTTI SONO DESTINATI ESCLUSIVAMENTE AD USO AGONISTICO. NE È QUINDI VIETATO L'UTILIZZO SU STRADA PUBBLICA.



cod. KT00080

Gruppo termico Ø 40 scooter Piaggio senza testa

APPLICABILITÀ

- APRILIA** MOJITO CUSTOM 2T MOTORE PIAGGIO 50 2T 04-10, SCARABEO 2T EU2 MOTORE PIAGGIO 50 2T 10-12, SCARABEO 2T NET 50 2T 09-10, SCARABEO STREET 50 2T 05-06, SCARABEO STREET 2T RESTYLING 50 2T 06-09, SPORT CITY ONE 2T 50 2T 08-11
- DERBI** ATLANTIS 2T 50 2T 10-10, ATLANTIS 2T EU2 50 2T 07-09, ATLANTIS O2 50 2T 02-02, ATLANTIS O2 BULLET 50 2T 03-05, ATLANTIS O2 CITY 50 2T 04-06, ATLANTIS O2 RED BULLET 50 2T 03-03, ATLANTIS O2 TWO CHIC 50 2T 05-05, BOULEVARD 2T 50 2T 09-14, SONAR 2T 50 2T 09-09
- GILERA** EASY MOVING 50 2T 95-96, ICE 50 2T 01-05, STALKER 50 2T 97-11, STALKER NAKED 50 2T 08-08, STALKER SPECIAL EDITION 50 2T 07-08, STORM 50 2T 94-95, STORM EURO 2 50 2T 07-07, TYPHOON 50 2T 94-97, TYPHOON X 50 2T 98-99, TYPHOON XR 50 2T 00-00
- ITALJET** JET SET 50 2T 02-02, TORPEDO NEW 50 2T 00-01

PIAGGIO

- DIESIS 50 2T 01-01, FLY 2T 50 2T 05-07, FLY 2T 50 2T 10-11, FREE 50 2T 92-94, FREE DELIVERY 50 2T 00-01, FREE FL 50 2T 95-02, LIBERTY 50 2T 97-05, LIBERTY 2T 50 2T 06-08, LIBERTY 2T PTT EU2 50 2T 04-05, LIBERTY 2T RST 50 2T 04-04, LIBERTY 2T SPORT 50 2T 06-08, LIBERTY MOC 2T & ELLE 50 2T 09-13, NRG POWER DT 50 2T 06-15, NRG POWER DT SERIE SPECIALE 50 2T 07-08, SFERA 50 2T 91-93, SFERA MAQUILLAGE 2 50 2T 94-94, SFERA RST 50 2T 95-97, TYPHOON 50 2T 01-11, TYPHOON 2T E2 50 2T 10-12, TYPHOON 2T E3 CH 50 2T 11-11, VESPA ET2 50 2T 97-05, VESPA ET2 INIEZIONE 50 2T 97-00, VESPA LX 2T 50 2T 05-13, VESPA LX 2T TOURING & 30KM 50 2T 10-13, VESPA LXV 2T 50 2T 06-09, VESPA LXV 2T NAVY 50 2T 08-08, VESPA S 2T & COLLEGE 50 2T 07-12, ZIP 50 2T 92-93, ZIP 50 2T 95-96, ZIP BIMODALE 50 2T 94-97, ZIP FAST RIDER 50 2T 93-94, ZIP FAST RIDER RST 50 2T 96-97, ZIP RST 50 2T 96-99

RICAMBI

PT00098	Pistone completo Ø 40
PT98	Pistone completo Ø 40,5
PT0098	Pistone completo Ø 41
SG15682	Serie segmenti Ø 40

SG15683	Serie segmenti Ø 40,5
SG15684	Serie segmenti Ø 41
GR00703	Guarnizione base



cod. KT00094

Gruppo termico Ø 40 per motore scooter 50 cc Minarelli/Yamaha Liquid Cooled senza testa

APPLICABILITÀ

- APRILIA** AREA 51 50 2T 98-00, GULLIVER LC 50 2T 96-98, RALLY LIQUID COOLED 50 2T 96-99, SONIC GP 50 2T 98-08, SR LIQUID COOLED 50 2T 94-96, SR RACING 50 2T 97-99, SR STEALTH 50 2T 97-00
- BENELLI** 491 RACING 50 2T 98-99, 491 RR 50 2T 99-01, 491 SP 50 2T 99-99, 491 SPORT 50 2T 98-99, K2 LIQUID COOLED 50 2T 98-01
- BETA** ARK LC 50 2T 96-08, EIKON 50 2T 99-03
- ITALJET** DRAGSTER 50 2T 98-02

MALAGUTI

- F12 PHANTOM EURO 2 50 2T 02-02, F12 PHANTOM LC 50 2T 94-98, F12 PHANTOM LC EURO 2,3 50 2T 03-04, F12 R PHANTOM LC 50 2T 07-10, F12 RESTYLING EURO 1 50 2T 99-02, F12 RESTYLING LC EURO 2 50 2T 06-06, F15 FIRE FOX 50 2T 96-98, F15 FIRE FOX EURO 2 50 2T 02-06, F15 FIRE FOX EURO 2,3 50 2T 03-04

MBK

- MACH G LC 50 2T 02-04, NITRO 50 2T 97-04, NITRO EURO 2 50 2T 03-03

YAMAHA

- AEROX 50 2T 97-02, AEROX 50 2T 04-16, AEROX EURO 2 50 2T 03-03, AEROX NAKED 50 2T 13-16, AEROX R 50 2T 99-00, AEROX R 50 2T 99-99, JOG R LC 50 2T 02-15

RICAMBI

PT00097	Pistone completo Ø 40
PT97	Pistone completo Ø 40,5
PT0097	Pistone completo Ø 41
SG15682	Serie segmenti Ø 40

SG15683	Serie segmenti Ø 40,5
SG15684	Serie segmenti Ø 41
GR00716	Serie guarnizioni



cod. KT00095

Gruppo termico Ø 40 per motore scooter 50 cc orizzontale aria Minarelli/Yamaha senza testa

APPLICABILITÀ

- APRILIA** GULLIVER 50 2T 95-98, RALLY 50 2T 95-03, SCARABEO 50 2T 93-05, SONIC 50 2T 98-07, SR (ORIZZONTALE) 50 2T 94-96, SR WWW 50 2T 97-01
- ATALA** CAROSELLO 50 2T 99-01
- BENELLI** 491 GT 50 2T 98-99, 491 NAKED 50 2T 02-02, 491 ST 50 2T 99-01, K2 50 2T 98-01, PEPE 50 2T 99-01, PEPE LX 50 2T 03-04
- BETA** ARK 50 2T 96-08, CHRONO 50 2T 95-96, QUADRA 50 2T 95-95, QUADRA 50 2T 99-01, TEMPO 50 2T 93-02, TEMPO 50 2T 95-95
- KTM** K50 50 2T 96-01
- MACAL** THUNDER 50 2T 95-96
- MALAGUTI** CENTRO SL 50 2T 94-98, CIAK 50 2T 99-01, CIAK EURO 2,3 50 2T 03-03, CIAK EURO2 50 2T 01-03, CIAK MASTER EURO 2 50 2T 06-06, F10 50 2T 92-00, F10 EURO 2 50 2T 02-06, F10 EURO 2,3 50 2T 03-04, F10 RESTYLING EURO 2 50 2T 06-06, F12 PHANTOM 50 2T 94-98, F12 PHANTOM EURO 2,3 50 2T 03-04, F12 RESTYLING EURO 2 50 2T 06-06, F15 FIRE FOX AIR COOLED 50 2T 05-06, YESTERDAY 50 2T 97-00

MBK

- EVOLIS 50 2T 92-95, FIZZ 50 2T 94-95, FLIPPER 50 2T 98-04, FLIPPER EURO 2 50 2T 03-03, FORTE 50 2T 94-96, MACH G 50 2T 02-04, OVETTO 50 2T 97-04, OVETTO EURO 2 50 2T 02-02

MOTRON

- SYNCR0 50 2T 98-00, THUNDER 50 2T 95-98

PGO

- BIG MAX 50 2T 95-97

RIEJU

- FIRST 50 2T 95-98, WINDY 50 2T 95-98

YAMAHA

- AXIS 50 2T 95-96, BREEZE 50 2T 94-95, JOG 50 2T 92-01, JOG ER 50 2T 00-02, JOG R 50 2T 02-02, JOG R EURO2 50 2T 02-02, JOG R EURO2 50 2T 06-15, JOG Z 50 2T 95-95, NEO'S 50 2T 97-02, NEO'S 50 2T 04-16, NEO'S EASY 50 2T 13-13, NEO'S EURO 2 50 2T 02-02, WHY 50 2T 98-05, WHY EURO 2 50 2T 03-05, ZEST 50 2T 95-92

RICAMBI

PT00097	Pistone completo Ø 40
PT97	Pistone completo Ø 40,5
PT0097	Pistone completo Ø 41
SG15682	Serie segmenti Ø 40

SG15683	Serie segmenti Ø 40,5
SG15684	Serie segmenti Ø 41
GR00704	Serie guarnizioni

ATTENZIONE: QUESTI PRODOTTI SONO DESTINATI ESCLUSIVAMENTE AD USO AGONISTICO. NE È QUINDI VIETATO L'UTILIZZO SU STRADA PUBBLICA.



cod. **KT00096**

Gruppo termico Ø 40 per motore scooter 50 cc Minarelli/Yamaha verticale aria senza testa

APPLICABILITÀ

APRILIA AMICO 50 2T 94-94, AMICO 50 2T 96-98, AMICO GL/GLE 50 2T 93-95, AMICO LX/SPORT/CAT 50 2T 92-93, SR (VERTICALE) 50 2T 93-93

MBK BOOSTER 50 2T 90-04, BOOSTER 50 2T 90-94, BOOSTER EURO 2 50 2T 04-04, BOOSTER NG 50 2T 95-03, BOOSTER ROCKET 50 2T 97-98, BOOSTER SPIRIT 50 2T 96-00, BOOSTER SPIRIT 50 2T 03-03, BOOSTER SPIRIT EURO2 50 2T 03-03, BOOSTER TRACK 50 2T 96-98, STUNT 50 2T 00-02

YAMAHA BW'S 50 2T 97-16, BW'S BUMP 50 2T 97-98, BW'S EASY 50 2T 13-13, BW'S NAKED 50 2T 03-04, BW'S NAKED 50 2T 09-16, BW'S NEXT GENERATION 50 2T 97-06, BW'S ORIGINAL 50 2T 99-01, BW'S ORIGINAL EURO 2 50 2T 03-03, RS SPY 50 2T 95-98, SLIDER 50 2T 00-02, ZUMA 50 2T 97-01

PT00097	Pistone completo Ø 40
PT97	Pistone completo Ø 40,5
PT0097	Pistone completo Ø 41
SG15682	Serie segmenti Ø 40

SG15683	Serie segmenti Ø 40,5
SG15684	Serie segmenti Ø 41
GR00705	Serie guarnizioni



cod. **KT00112**

Gruppo termico Ø 40 Piaggio H2O con testa

APPLICABILITÀ

APRILIA SR R 50 2T 04-09, SR R FACTORY 50 2T 04-09, SR R FACTORY Carburatore 50 2T 10-12, SR Street 50 2T 03-12

DERBI GP1 50 2T 01-03, GP1 EU2 50 2T 05-05, GP1 Open EU2 50 2T 06-09, GP1 Race EU2 50 2T 05-07

GILERA DNA 50 2T 00-02, DNA 50 2T 05-07, DNA GP Experience 50 2T 03-04, Runner 50 2T 97-00, Runner Poggiali 50 2T 02-02, Runner SP 50 2T 02-07, Runner SP 50 2T 10-12, Runner SP ST & Simoncelli 50 2T 08-09, Runner SP Special Edition 50 2T 07-07

PIAGGIO NRG 50 2T 94-96, NRG Extreme 50 2T 99-00, NRG MC3 50 2T 01-04, NRG Power DD 50 2T 05-11, NRG Power DD Serie Speciale 50 2T 07-11, NRG Power Pure Jet 50 2T-IE 04-05, NRG Power PureJet 50 2T-IE 06-11, NRG PureJet 50 2T-IE 02-04, NRG PureJet 50 2T-IE 10-10, NRG RST MC2 50 2T 96-98, NTT 50 2T 95-96, Quartz 50 2T 92-96, Zip 2T 50 2T 08-12, Zip LC 50 2T 00-04, Zip Sp 50 2T 96-04, Zip Sp Euro 2 50 2T 06-12

RICAMBI

PT00098	Pistone Ø 40
PT98	Pistone Ø 40,5
PT0098	Pistone Ø 41
SG15682	Serie segmenti Ø 40
SG15683	Serie segmenti Ø 40,5

SG15684	Serie segmenti Ø 41
GR00734	Serie guarnizioni
TS00180	Testa Ø 40
AA00769	Raccordo in alluminio per testa



cod. **KT00115**

Gruppo termico Ø 40 per Derbi Senda con testa

APPLICABILITÀ

DERBI BULTACO LOBITO 50 2T 98-01, GPR NUDE 50 2T 04-05, GPR R 50 2T 97-00, GPR RACING 50 2T 04-05, GPR REPLICCA 50 2T 99-01, GPR REPLICCA RACING 50 2T 02-03, GPR REPLICCA RACING EU2 50 2T 05-05, SENDA BLACK EDITION 50 2T 03-03, SENDA R 50 2T 99-01, SENDA R DRD BLACK DEVIL 2A EDIZIONE 50 2T 03-03, SENDA R DRD EU1 EU1R 50 2T 02-02, SENDA R DRD RACING 50 2T 04-05, SENDA R DRD RACING LTD 50 2T 05-05, SENDA R RACER 50 2T 03-03, SENDA R X-RACE 50 2T 04-05, SENDA R X-TREME 50 2T 03-03, SENDA R X-TREME 50 2T 05-05, SENDA R X-TREME EU2 50 2T 04-04, SENDA SM 50 2T 00-01, SENDA SM DRD EDITION BLACK 50 2T 05-05, SENDA SM DRD EU1 EU1R 50 2T 02-03, SENDA SM DRD RACING 50 2T 04-05, SENDA SM DRD RACING LTD 50 2T 05-05, SENDA SM X-RACE 50 2T 04-05, SENDA SM X-TREME 50 2T 02-03, SENDA SM X-TREME EU2 50 2T 04-04, SENDA SM X-TREME EU2 2A EDIZIONE 50 2T 05-05

GILERA GSM 50 2T 01-01, RCR 50 2T 03-03, SMT 50 2T 03-03

RICAMBI

PT00154	Pistone completo Ø 40
PT154	Pistone completo Ø 40,28
SG15852	Serie segmenti Ø 40
SG15854	Serie segmenti Ø 40,28

GR00725	Nuova serie guarnizioni
GR00720	Serie guarnizioni
TS00181	Testa

ATTENZIONE: QUESTI PRODOTTI SONO DESTINATI ESCLUSIVAMENTE AD USO AGONISTICO. NE È QUINDI VIETATO L'UTILIZZO SU STRADA PUBBLICA.



◀ cod. **KT00119**
Gruppo termico Ø 40 per Peugeot H20 con testa

APPLICABILITÀ

PEUGEOT SPEEDFIGHT 50 2T 97-04, SPEEDFIGHT LC 50 2T 97-04, X-FIGHT LC 50 2T 00-02

RICAMBI

PT00155	Pistone Ø 39,88
PT155	Pistone Ø 40,28
SG15853	Serie segmenti Ø 39,88
SG15856	Serie segmenti Ø 40,28

GR00714	Serie guarnizioni
GR00721	Serie guarnizioni Ø 39,88
TS00185	Testa Ø 40



◀ cod. **KT00123**
Gruppo termico Ø 40 Peugeot Buxy EU-2 senza testa

APPLICABILITÀ

PEUGEOT BUXY 50 2T 90-02, BUXY RS 50 2T 90-02, ELYSEO 50 2T 90-02, LOOXOR 50 2T 90-02, METAL X 50 2T 90-02, SPEEDAKE 50 2T 90-02, SPEEDFIGHT 50 2T 97-04, SQUAB 50 2T 90-02, SV GEO 50 2T 90-02, TREKKER 50 2T 90-02, VIVACITY 50 2T 90-02, X-FIGHT 50 2T 00-02, X-FIGHT LC 50 2T 00-02, ZENITH 50 2T 90-02

RICAMBI

PT00099	Pistone Ø 40
PT99	Pistone Ø 40,5
SG15682	Serie segmenti Ø 40

SG15683	Serie segmenti Ø 40,5
SG15684	Serie segmenti Ø 41
GR00718	Serie guarnizioni



◀ cod. **KT00129**
Gruppo termico Ø 40 Keeway Focus senza testa

APPLICABILITÀ

BENELLI PEPE 50 2T 10-10, PEPE LX 50 2T 07-09, PEPE OLD 50 2T 07-09, PEPE OLD 50 2T 11-11, QUATRONEX 50 2T 08-11

CPI ARAGON 50 2T 03-03, HUSSAR 50 2T 03-03, OLIVER 50 2T 03-03, POP CORN 50 2T 03-03

EXPLORER CRACKER 50 2T 03-03

KEEWAY F-ACT 50 2T 07-08, FLASH 50 2T 07-08, FOCUS 50 2T 06-06, GOCCIA 50 2T 09-09, HURRICANE 50 2T 06-08, MATRIX 50 2T 06-08, PIXEL EURO 2 50 2T 09-12, RY8 50 2T 08-08

MALAGUTI F10 AC WAP 50 2T 08-08, F12 R PHANTOM AC 50 2T 07-08

RICAMBI

PT00107	Pistone Ø 40
PT107	Pistone Ø 40,5
SG15682	Serie segmenti Ø 40

SG15683	Serie segmenti Ø 40,5
GR00733	Serie guarnizioni

ATTENZIONE: QUESTI PRODOTTI SONO DESTINATI ESCLUSIVAMENTE AD USO AGONISTICO. NE È QUINDI VIETATO L'UTILIZZO SU STRADA PUBBLICA.



◀ **cod. KT00098**
Gruppo termico Ø 40,3 (AM 345/6) E EU1 con testa

APPLICABILITÀ

APRILIA	CLASSIC 50 2T 92-99, EUROPA 50 2T 91-92, MX 50 2T 04-04, MX MOTARD 50 2T 95-03, PEGASO 50 2T 92-94, RS 50 2T 91-05, RX 50 2T 03-04, RX 3-5 MARCE 50 2T 91-94, RX ENDURO 50 2T 95-03, RX RACING 50 2T 03-06, TUONO 50 2T 03-04
BETA	RR 2T 50 EU4 50 2T 18-20, RR 50 RACING EU4 50 2T 18-20, RR ALU 50 2T 08-12, RR ENDURO 50 2T 06-17, RR MOTARD 50 2T 06-17
CH	SM 50 2T 00-10, WR 50 2T 00-10, WSM 50 2T 00-10
HUSQUARNA	
CMC	ENDURO 50 2T 11-11, MOTARD 50 2T 11-11
FANTIC	CABALLERO MOTARD 50 2T 06-10, CABALLERO REGOLARITÀ 50 2T 06-10, ENDURO COMPETITION EU4 50 2T 18-20, ENDURO PERFORMANCE EU4 50 2T 18-20, MOTARD COMPETITION EU4 50 2T 18-20, MOTARD PERFORMANCE EU4 50 2T 18-20
HM	BAJA, DERAPAGE BASIC 50 2T 10-11, CMC 50 2T 10-11, CRE BAJA RR, DERAPAGE RR 50 2T 07-11, CRE BAJA, DERAPAGE 50 2T 07-11, CRE SIX COMPETITION 50 2T 10-11, CRE SIX, BAJA, DERAPAGE 50 2T 95-06, CRE SIX, DERAPAGE COMPETITION 50 2T 07-09, DERAPAGE COMPETITION 50 2T 10-11
MBK	X LIMIT 50 2T 03-04, X POWER 50 2T 03-04
MALAGUTI	CNK DRAGON 50 2T 05-07, FIFTY EVOLUTION 50 2T 90-93, XSM 50 2T 03-03, XTM 50 2T 03-03

MINARELLI	MOTORE AM 3-4-5 50 2T 91-95, MOTORE AM 6 1° SERIE 50 2T 96-11, MOTORE AM 6 2° SERIE 50 2T 12-18
MOTORHISPANIA	FURIA 50 2T 97-00, FURIA MAX 50 2T 10-12, RX 50 2T 09-12, RX R 50 2T 09-12
PEUGEOT	SUPERMOTARD 50 2T 90-02, XP6 TRAIL S/AVV. ELETTRICO 50 2T 90-02, XR6 RACING CAT. C/AVV.ELETT. 50 2T 90-02
RIEJU	MRT 50 2T 09-12, MRT 50 EU4 50 2T 18-20, MRT PRO 50 2T 09-12, MRT PRO EU4 50 2T 18-20, MRT PRO REPLICA EU4 50 2T 18-20, MRT PRO REPLICA SM EU4 50 2T 18-20, MRT PRO SM 50 2T 09-12, MRT PRO SM EU4 50 2T 18-20, MRT SM 50 2T 09-12, MRT SM EU4 50 2T 18-20, MRT TROPHY EU4 50 2T 18-20, MRX 50 2T 01-04, MRX PRO 50 2T 01-04, RR 50 2T 05-06, RS1 50 2T 98-01, RS2 NAKED 50 2T 04-05, RS2 MATRIX PRO 50 2T 05-06, RS2 MATRIX 50 2T 05-06, RS3 EU4 50 2T 18-20, RS3 NKD EU4 50 2T 18-20, SMX E.S./K.S. 50 2T 01-01, SMX PRO E.S./K.S. 50 2T 03-03, SPIKE 50 2T 98-01
SHERCO	FACTORY SE-R EU4 50 2T 18-20, FACTORY SE-RS EU4 50 2T 18-20, FACTORY SILVER SM-R EU4 50 2T 18-20, FACTORY SILVER SM-RS EU4 50 2T 18-20, FACTORY SM-R EU4 50 2T 18-20, FACTORY SM-RS EU4 50 2T 18-20, HRD ENDURO 50 2T 09-13, HRD MOTARD 50 2T 09-13
VENT	BAJA 50 2T 18-20, BAJA RR 50 2T 18-20, DERAPAGE 50 2T 18-20, DERAPAGE RR 50 2T 18-20
YAMAHA	DT R 50 2T 03-11, DT RSM 50 2T 03-05, DT X 50 2T 06-11, TZR 50 2T 03-08, TZR 50 2T 10-11, TZR RR 50 2T 05-05

RICAMBI

PT00104	Pistone completo Ø 40,3
PT104	Pistone completo Ø 40,6
PT0104	Pistone completo Ø 40,8
SG15706	Serie segmenti Ø 40,3

SG15707	Serie segmenti Ø 40,6
SG15708	Serie segmenti Ø 40,8
GR00715	Serie guarnizioni
TS00179	Testa



◀ **cod. KT00066**
Gruppo termico Ø 43 spinotto 12 Ciao-Si serie Evolution

APPLICABILITÀ

PIAGGIO	BOSS 50 2T 88-89, BOXER 50 2T 70-83, BRAVO 3 50 2T 87-90, BRAVO ERRE 2 50 2T 75-81, CIAO 50 2T 80-88, CIAO EU1 50 2T 99-01, CIAO EU2 50 2T 02-04, CIAO MIX TEEN 50 2T 96-01, CIAO TRE 50 2T 71-99, ECO 50 2T 79-89, GRILLO 50 2T 89-93, SI 50 2T 79-88, SI FL2 50 2T 91-97, SI MIX 50 2T 96-99
----------------	--

RICAMBI

PT00092	Pistone completo Ø 43
SG15585	Serie segmenti Ø 43

GR00698	Guarnizione base
----------------	------------------



◀ **cod. KT00067**
Gruppo termico Ø 43 spinotto 10 Ciao-Si

APPLICABILITÀ

PIAGGIO	BOSS 50 2T 88-89, BOXER 50 2T 70-83, BRAVO 3 50 2T 87-90, BRAVO ERRE 2 50 2T 75-81, CIAO 50 2T 80-88, CIAO EU1 50 2T 99-01, CIAO EU2 50 2T 02-04, CIAO MIX TEEN 50 2T 96-01, CIAO TRE 50 2T 71-99, ECO 50 2T 79-89, GRILLO 50 2T 89-93, SI 50 2T 79-88, SI FL2 50 2T 91-97, SI MIX 50 2T 96-99
----------------	--

RICAMBI

PT00094	Pistone completo Ø 43
SG15585	Serie segmenti Ø 43

GR00698	Guarnizione base
----------------	------------------

ATTENZIONE: QUESTI PRODOTTI SONO DESTINATI ESCLUSIVAMENTE AD USO AGONISTICO. NE È QUINDI VIETATO L'UTILIZZO SU STRADA PUBBLICA.



◀ cod. **KT00048**
Gruppo termico Ø 46 Honda Camino PX

APPLICABILITÀ

HONDA CAMINO PX 50 2T 70-80

RICAMBI

PT00079	Pistone completo Ø 46
SG15031	Serie segmenti Ø 46

GR00683	Serie guarnizioni
---------	-------------------



◀ cod. **KT00057**
Gruppo termico Ø 46 Suzuki Address senza testa

APPLICABILITÀ

APRILIA HABANA-MOJITO CUSTOM 50 2T 99-03, HABANA-MOJITO RETRO' 50 2T 99-03
ATALA HACKER 50 2T 95-00, VAMOS 50 2T 93-95
BENELLI 491 ST MORINI 50 2T 03-03, NAKED MORINI 50 2T 03-04
HYOSUNG SD SENSE EU1 50 2T 00-01, SD SENSE EU2 50 2T 05-05, SF B RALLY 50 2T 04-08, SF FAST 50 2T 00-00, SF FAST EU2 50 2T 01-03, SF R RALLY 50 2T 04-08

ITALJET FORMULA 50 2T 94-97, VELOCIFERO 50 2T 98-02

MALAGUTI CROSSER CR1 50 2T 95-98

SUZUKI AH Address 50 2T 92-95, AJ ZZ 50 2T 95-97, AP 50 2T 94-97, Street Magic 50 2T 98-98

RICAMBI

PT00089	Pistone completo Ø 46
PT89	Pistone completo Ø 46,5
SG15282	Serie segmenti Ø 46

SG15283	Serie segmenti Ø 46,5
GR00731	Serie guarnizioni



◀ cod. **KT00073**
Gruppo termico Ø 46 Wallaroo

APPLICABILITÀ

HONDA WALLAROO 50 2T 90-01

RICAMBI

PT00072	Pistone completo Ø 46
SG15168	Serie segmenti Ø 46

GR06347	Guarnizione base
---------	------------------

ATTENZIONE: QUESTI PRODOTTI SONO DESTINATI ESCLUSIVAMENTE AD USO AGONISTICO. NE È QUINDI VIETATO L'UTILIZZO SU STRADA PUBBLICA.



cod. **KT00011**

Gruppo termico Vespa Ø 47 3 travasi

Cilindro in ghisa Minacrom con 3 travasi | Cilindrata 74,60 cc - Corsa mm 43 - Rapp. Comp. 1:10,7 | Completo di testa

APPLICABILITÀ

PIAGGIO Vespa 50 2T 67-82, Vespa FL 50 2T 90-90, Vespa FL2 AUTOMATICA 50 2T 90-91, Vespa FL2 HP 50 2T 91-97, Vespa N 50 2T 89-90, Vespa PK 50 2T 82-84, Vespa PK AUTOMATICA 50 2T 84-89, Vespa PK XL 50 2T 85-88, Vespa PK XL PLURIMATIC 50 2T 85-90, Vespa PK XL RUSH 50 2T 88-89

RICAMBI

PT00058	Pistone completo Ø 47
PT58	Pistone completo Ø 47,4
SG15036	Serie segmenti Ø 47
SG15038	Serie segmenti Ø 47,4

SG15040	Serie segmenti Ø 47,8
GR00727	Serie guarnizioni
TS00151	Testa



cod. **KT00013**

Gruppo termico Vespa Ø 47 6 travasi

Cilindro in ghisa Minacrom con 6 travasi | Cilindrata 74,60 cc - Corsa mm 43 - Rapp. Comp. 1:10,7 | Completo di testa

APPLICABILITÀ

PIAGGIO APE 50 2T 09-17, APE FL - FL2 50 2T 89-95, APE FL3 EUROPA 50 2T 96-99, APE MIX 2T 50 2T 98-08, APE P 50 2T 80-85, APE RST MIX 50 2T 99-03, APE TM P 50 2T 85-89, VESPA FL 50 2T 90-90, VESPA FL2 HP 50 2T 91-97, VESPA N 50 2T 89-90, VESPA PK 50 2T 82-84, VESPA PK XL 50 2T 85-88, VESPA PK XL RUSH 50 2T 88-89, VESPA SPECIAL-L-R 50 2T 67-82

RICAMBI

PT00061	Pistone completo Ø 47
PT61	Pistone Ø 47,4
SG15036	Serie segmenti Ø 47
SG15038	Serie segmenti Ø 47,4

SG15040	Serie segmenti Ø 47,8
GR00727	Serie guarnizioni
TS00151	Testa



cod. **KT00049**

Gruppo termico Ø 47 10 luci

Cilindro in ghisa Minacrom con 10 travasi | Cilindrata 74,60 cc - Corsa mm 43 - Rapp. Comp. 1:10,7 | Completo di testa

APPLICABILITÀ

PIAGGIO APE 50 2T 09-17, APE FL - FL2 50 2T 89-95, APE FL3 EUROPA 50 2T 96-99, APE MIX 2T 50 2T 98-08, APE P 50 2T 80-85, APE RST MIX 50 2T 99-03, APE TM P 50 2T 85-89, VESPA FL 50 2T 90-90, VESPA FL2 HP 50 2T 91-97, VESPA N 50 2T 89-90, VESPA PK 50 2T 82-84, VESPA PK XL 50 2T 85-88, VESPA PK XL RUSH 50 2T 88-89, VESPA SPECIAL-L-R 50 2T 67-82

RICAMBI

PT00080	Pistone completo Ø 47
PT80	Pistone completo Ø 47,4
PT0080	Pistone completo Ø 47,8
SG15036	Serie segmenti Ø 47

SG15038	Serie segmenti Ø 47,4
SG15040	Serie segmenti Ø 47,8
GR00727	Serie guarnizioni
TS00151	Testa



cod. **KT00058**
Gruppo termico Ø 47 Peugeot SV-Geo

APPLICABILITÀ

PEUGEOT BUXY 50 2T 90-02, BUXY RS 50 2T 90-02, ELYSEO 50 2T 90-02, LOOKOR 50 2T 90-02, METAL X 50 2T 90-02, SPEEDAKE 50 2T 90-02, SPEEDFIGHT 50 2T 97-04, SQUAB 50 2T 90-02, SV GEO 50 2T 90-02, TREKKER 50 2T 90-02, VIVACITY 50 2T 90-02, X-FIGHT 50 2T 00-02, X-FIGHT LC 50 2T 00-02, ZENITH 50 2T 90-02

RICAMBI

PT00090	Pistone completo Ø 47
PT90	Pistone completo Ø 47,4
PT0090	Pistone completo Ø 47,8
SG15036	Serie segmenti Ø 47

SG15038	Serie segmenti Ø 47,4
SG15040	Serie segmenti Ø 47,8
GR00717	Serie guarnizioni



cod. **KT00087**
Gruppo termico Ø 47 per motore scooter 50 cc Minarelli/Yamaha orizzontale Evolution

APPLICABILITÀ

APRILIA GULLIVER 50 2T 95-98, RALLY 50 2T 95-03, SCARABEO 50 2T 93-05, SONIC 50 2T 98-07, SR (ORIZZONTALE) 50 2T 94-96, SR WWW 50 2T 97-01

ATALA CAROSELLO 50 2T 99-01

BENELLI 491 GT 50 2T 98-99, 491 NAKED 50 2T 02-02, 491 ST 50 2T 99-01, K2 50 2T 98-01, PEPE 50 2T 99-01, PEPE LX 50 2T 03-04

BETA ARK 50 2T 96-08, CHRONO 50 2T 95-96, QUADRA 50 2T 95-95, QUADRA 50 2T 99-01, TEMPO 50 2T 93-02, TEMPO 50 2T 95-95

KTM K50 50 2T 96-01

MACAL THUNDER 50 2T 95-96

MALAGUTI CENTRO SL 50 2T 94-98, CIAK 50 2T 99-01, CIAK EURO 2 2,3 50 2T 03-03, CIAK EURO2 50 2T 01-03, CIAK MASTER EURO 2 50 2T 06-06, F10 50 2T 92-00, F10 EURO 2 50 2T 02-06, F10 EURO 2 2,3 50 2T 03-04, F10 RESTYLING EURO 2 50 2T 06-06, F12 PHANTOM 50 2T 94-98, F12 PHANTOM EURO 2 2,3 50 2T 03-04, F12 RESTYLING EURO 2 50 2T 06-06, F15 FIRE FOX AIR COOLED 50 2T 05-06, YESTERDAY 50 2T 97-00

MBK EVOLIS 50 2T 92-95, FIZZ 50 2T 94-95, FLIPPER 50 2T 98-04, FLIPPER EURO 2 50 2T 03-03, FORTE 50 2T 94-96, MACH G 50 2T 02-04, OVETTO 50 2T 97-04, OVETTO EURO 2 50 2T 02-02

MOTRON SYNCRO 50 2T 98-00, THUNDER 50 2T 95-98

PGO BIG MAX 50 2T 95-97

RIEJU FIRST 50 2T 95-98, WINDY 50 2T 95-98

YAMAHA AXIS 50 2T 95-96, BREEZE 50 2T 94-95, JOG 50 2T 92-01, JOG ER 50 2T 00-02, JOG R 50 2T 02-02, JOG R EURO2 50 2T 02-02, JOG R EURO2 50 2T 06-15, JOG Z 50 2T 95-95, NEO'S 50 2T 97-02, NEO'S 50 2T 04-16, NEO'S EASY 50 2T 13-13, NEO'S EURO 2 50 2T 02-02, WHY 50 2T 98-05, WHY EURO 2 50 2T 03-05, ZEST 50 2T 95-92

RICAMBI

PT00102	Pistone completo Ø 47
PT102	Pistone completo Ø 47,4
SG15284	Serie segmenti Ø 47

SG15691	Serie segmenti Ø 47,4
GR00702	Serie guarnizioni
TS00170	Testa



cod. **KT00088**
Gruppo termico Ø 47 per motore scooter 50 cc Minarelli/Yamaha tipo verticale

APPLICABILITÀ

APRILIA AMICO 50 2T 94-94, AMICO 50 2T 96-98, AMICO GL/ GLE 50 2T 93-95, AMICO LX/SPORT/CAT 50 2T 92-93, SR (VERTICALE) 50 2T 93-93

MBK BOOSTER 50 2T 90-04, BOOSTER 50 2T 90-94, BOOSTER EURO 2 50 2T 04-04, BOOSTER NG 50 2T 95-03, BOOSTER ROCKET 50 2T 97-98, BOOSTER SPIRIT 50 2T 96-00, BOOSTER SPIRIT 50 2T 03-03, BOOSTER SPIRIT EURO2 50 2T 03-03, BOOSTER TRACK 50 2T 96-98, STUNT 50 2T 00-02

YAMAHA BW'S 50 2T 97-16, BW'S BUMP 50 2T 97-98, BW'S EASY 50 2T 13-13, BW'S NAKED 50 2T 03-04, BW'S NAKED 50 2T 09-16, BW'S NEXT GENERATION 50 2T 97-00, BW'S NEXT GENERATION 50 2T 99-06, BW'S ORIGINAL 50 2T 99-00, BW'S ORIGINAL 50 2T 99-02, BW'S ORIGINAL EURO 2 50 2T 03-03, RS SPY 50 2T 95-98, SLIDER 50 2T 00-02, ZUMA 50 2T 97-01

RICAMBI

PT00102	Pistone completo Ø 47
PT102	Pistone completo Ø 47,4
SG15284	Serie segmenti Ø 47

SG15691	Serie segmenti Ø 47,4
GR00701	Serie guarnizioni
TS00165	Testa

ATTENZIONE: QUESTI PRODOTTI SONO DESTINATI ESCLUSIVAMENTE AD USO AGONISTICO. NE È QUINDI VIETATO L'UTILIZZO SU STRADA PUBBLICA.



◀ cod. **KT00090**
Gruppo termico Ø 47 per Honda Bali

APPLICABILITÀ

HONDA BALI 50 2T 93-99, SFX / SXR 50 2T 95-01, SGX SKY 50 2T 97-04, SH NEW 50 2T 96-01, X8R S 50 2T 98-01, X8R X 50 2T 98-01

RICAMBI

PT00103	Pistone completo Ø 47
PT103	Pistone completo Ø 47,4
SG15695	Serie segmenti Ø 47

SG15696	Serie segmenti Ø 47,4
GR00709	Serie guarnizioni



◀ cod. **KT00109**
Gruppo termico Ø 47 per motore scooter 50 cc Minarelli/Yamaha Liquid Cooled

APPLICABILITÀ

APRILIA AREA 51 50 2T 98-00, GULLIVER LC 50 2T 96-98, RALLY LIQUID COOLED 50 2T 96-99, SONIC GP 50 2T 98-08, SR LIQUID COOLED 50 2T 94-96, SR RACING 50 2T 97-99, SR STEALTH 50 2T 97-00

BENELLI 491 RACING 50 2T 98-99, 491 RR 50 2T 99-01, 491 SP 50 2T 99-99, 491 SPORT 50 2T 98-99, K2 LIQUID COOLED 50 2T 98-01

BETA ARK LC 50 2T 96-08, EIKON 50 2T 99-03

ITALJET DRAGSTER 50 2T 98-02

MALAGUTI F12 PHANTOM LC 50 2T 94-98, F12 R PHANTOM LC 50 2T 07-10, F15 FIRE FOX 50 2T 96-98, F15 FIRE FOX EURO 2 50 2T 02-06, F15 FIRE FOX EURO 2 2,3 50 2T 03-04

MBK MACH G LC 50 2T 02-04, NITRO 50 2T 97-04, NITRO EURO 2 50 2T 03-03

YAMAHA AEROX 50 2T 97-02, AEROX 50 2T 04-16, AEROX EURO 2 50 2T 03-03, AEROX NAKED 50 2T 13-16, AEROX R 50 2T 99-00, AEROX R 50 2T 99-99, JOG R LC 50 2T 02-15

RICAMBI

PT00102	Pistone Ø 47
PT102	Pistone Ø 47,4
SG15284	Serie segmenti Ø 47
SG15691	Serie segmenti Ø 47,4

GR00711	Rid. ermetica con guarnizione
GR00713	Serie guarnizioni
TS00175	Testa Ø 47



◀ cod. **KT00116**
Gruppo termico Ø 47 Peugeot Liquid Cooled con testa

APPLICABILITÀ

PEUGEOT SPEEDFIGHT 50 2T 97-04, SPEEDFIGHT LC 50 2T 97-04, X-FIGHT LC 50 2T 00-02

RICAMBI

PT00090	Pistone Ø 47
PT90	Pistone Ø 47,4
PT0090	Pistone Ø 47,8
SG15036	Serie segmenti Ø 47
SG15038	Serie segmenti Ø 47,4

SG15040	Serie segmenti Ø 47,8
GR00714	Serie guarnizioni
GR00721	Serie guarnizioni
TS00184	Testa

ATTENZIONE: QUESTI PRODOTTI SONO DESTINATI ESCLUSIVAMENTE AD USO AGONISTICO. NE È QUINDI VIETATO L'UTILIZZO SU STRADA PUBBLICA.

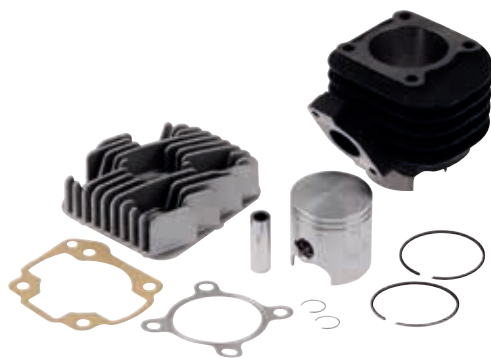

◀ cod. **KT00128**
Gruppo termico Ø 47 Keeway Focus

APPLICABILITÀ

BENELLI	PEPE 50 2T 10-10, PEPE LX 50 2T 07-09, PEPE OLD 50 2T 07-09, PEPE OLD 50 2T 11-11, QUATTRONEX 50 2T 08-11
CPI	ARAGON 50 2T 03-03, HUSSAR 50 2T 03-03, OLIVER 50 2T 03-03, POP CORN 50 2T 03-03
EXPLORER	CRACKER 50 2T 03-03

KEEWAY	F-ACT 50 2T 07-08, FLASH 50 2T 07-08, FOCUS 50 2T 06-06, GOCCIA 50 2T 09-09, HURRICANE 50 2T 06-08, MATRIX 50 2T 06-08, PIXEL EURO 2 50 2T 09-12, RY8 50 2T 08-08
MALAGUTI	F10 AC WAP 50 2T 08-08, F12 R PHANTOM AC 50 2T 07-08

RICAMBI

PT00106	Pistone Ø 47
PT106	Pistone Ø 47,4
SG15284	Serie segmenti Ø 47
SG15691	Serie segmenti Ø 47,4

GR00732	Serie guarnizioni
TS00170	Testa
SP00726	Spinotto



◀ cod. **KT00086**
Gruppo termico Ø 48 Sfera - Zip Evolution

APPLICABILITÀ

APRILIA	MOJITO CUSTOM 2T MOTORE PIAGGIO 50 2T 04-10, SCARABEO 2T EU2 MOTORE PIAGGIO 50 2T 10-12, SCARABEO 2T NET 50 2T 09-10, SCARABEO STREET 50 2T 05-06, SCARABEO STREET 2T RESTYLING 50 2T 06-09, SPORT CITY ONE 2T 50 2T 08-11
DERBI	ATLANTIS 2T 50 2T 10-10, ATLANTIS 2T EU2 50 2T 07-09, ATLANTIS O2 50 2T 02-02, ATLANTIS O2 BULLET 50 2T 03-05, ATLANTIS O2 CITY 50 2T 04-06, ATLANTIS O2 RED BULLET 50 2T 03-03, ATLANTIS O2 TWO CHIC 50 2T 05-05, BOULEVARD 2T 50 2T 09-14, SONAR 2T 50 2T 09-09
GILERA	EASY MOVING 50 2T 95-96, ICE 50 2T 01-05, STALKER 50 2T 97-11, STALKER NAKED 50 2T 08-08, STALKER SPECIAL EDITION 50 2T 07-08, STORM 50 2T 94-95, STORM EURO 2 50 2T 07-07, TYPHOON 50 2T 94-97, TYPHOON X 50 2T 98-99, TYPHOON XR 50 2T 00-00
ITALJET	JET SET 50 2T 02-02, TORPEDO NEW 50 2T 00-01

PIAGGIO	DIESIS 50 2T 01-01, FLY 2T 50 2T 05-07, FLY 2T 50 2T 10-11, FREE 50 2T 92-94, FREE DELIVERY 50 2T 00-01, FREE FL 50 2T 95-02, LIBERTY 50 2T 97-05, LIBERTY 2T 50 2T 06-08, LIBERTY 2T PTT EU2 50 2T 04-05, LIBERTY 2T RST 50 2T 04-04, LIBERTY 2T SPORT 50 2T 06-08, LIBERTY MOC 2T & ELLE 50 2T 09-13, NRG POWER DT 50 2T 06-15, NRG POWER DT SERIE SPECIALE 50 2T 07-08, SFERA 50 2T 91-93, SFERA MAQUILLAGE 2 50 2T 94-94, SFERA RST 50 2T 95-97, TYPHOON 50 2T 01-11, TYPHOON 2T E2 50 2T 10-12, TYPHOON 2T E3 CH 50 2T 11-11, VESPA ET2 50 2T 97-05, VESPA ET2 INIEZIONE 50 2T 97-00, VESPA LX 2T 50 2T 05-13, VESPA LX 2T TOURING & 30KM 50 2T 10-13, VESPA LXV 2T 50 2T 06-09, VESPA LXV 2T NAVY 50 2T 08-08, VESPA S 2T & COLLEGE 50 2T 07-12, ZIP 50 2T 92-93, ZIP 50 2T 95-96, ZIP BIMODALE 50 2T 94-97, ZIP FAST RIDER 50 2T 93-94, ZIP FAST RIDER RST 50 2T 96-97, ZIP RST 50 2T 96-99
----------------	--

RICAMBI

PT00100	Pistone completo Ø 48
PT100	Pistone completo Ø 48,5
PT0100	Pistone completo Ø 49
SG15688	Serie segmenti Ø 48

SG15689	Serie segmenti Ø 48,5
GR06411	Serie guarnizioni
TS00166	Testa



◀ cod. **KT00091**
Gruppo termico Ø 48 Piaggio Liquid Cooled Evolution

APPLICABILITÀ

APRILIA	SR (motore Piaggio) '03 -'05, SR R Factory '04 -'07
GILERA	Runner, Runner SP

PIAGGIO	NRG mc2, NTT, Zip SP
----------------	----------------------

RICAMBI

PT00100	Pistone Ø 48
PT100	Pistone Ø 48,5
PT0100	Pistone Ø 49
SG15688	Serie segmenti Ø 48

SG15689	Serie segmenti Ø 48,5
SG15690	Serie segmenti Ø 49
GR00708	Serie guarnizioni
TS00178	Testa

ATTENZIONE: QUESTI PRODOTTI SONO DESTINATI ESCLUSIVAMENTE AD USO AGONISTICO. NE È QUINDI VIETATO L'UTILIZZO SU STRADA PUBBLICA.

cod. **KT00097** Gruppo termico Ø 48 per Piaggio Liquid Cooled con raccordo



APPLICABILITÀ

APRILIA	SR MOTARD 50 2T 12-14, SR R 50 2T 04-09, SR R FACTORY CARBURATORE 50 2T 10-14, SR R FACTORY IE 50 2T 10-14, SR STREET CARBURATORE 50 2T 03-12
DERBI	GP1 50 2T 01-03, GP1 EU 2 50 2T 05-05, GP1 OPEN EU2 50 2T 06-09, GP1 RACE EU2 50 2T 05-07
GILERA	DNA 50 2T 00-02, DNA 50 2T 05-07, DNA GP EXPERIENCE 50 2T 03-04, RUNNER 50 2T 97-00, RUNNER POGGIALLI 50 2T 02-02, RUNNER SP 50 2T 02-07, RUNNER SP 50 2T 10-12, RUNNER SP SPECIAL EDITION 50 2T 07-07, RUNNER SP ST & SIMONCELLI 50 2T 08-09

PIAGGIO	NRG 50 2T 94-96, NRG EXTREME LC 50 2T 99-00, NRG MC3 50 2T 01-04, NRG POWER DD 50 2T 05-17, NRG POWER DD SERIE SPECIALE 50 2T 07-12, NRG POWER PUREJET 50 2T-IE 04-11, NRG PUREJET 50 2T-IE 02-04, NRG PUREJET 50 2T-IE 10-10, NRG RST MC2 50 2T 96-98, NTT 50 2T 95-96, QUARTZ 50 2T 92-96, ZIP 2T 50 2T 08-13, ZIP LC 50 2T 00-04, ZIP SP 50 2T 96-04, ZIP SP EURO 2 50 2T 06-13
----------------	--

RICAMBI

PT00100	Pistone Ø 48
PT100	Pistone Ø 48,5
PT0100	Pistone Ø 49
SG15688	Serie segmenti Ø 48

SG15689	Serie segmenti Ø 48,5
GR00708	Serie guarnizioni
TS00178	Testa
AA00769	Raccordo per testa

cod. **KT00114** Gruppo termico Ø 49 per motore Minarelli AM con testa



APPLICABILITÀ

APRILIA	CLASSIC 50 2T 92-99, EUROPA 50 2T 91-92, MX 50 2T 04-04, MX MOTARD 50 2T 95-03, PEGASO 50 2T 92-94, RS 50 2T 91-05, RX 50 2T 03-04, RX 3-5 MARCE 50 2T 91-94, RX ENDURO 50 2T 95-03, RX RACING 50 2T 03-06, TUONO 50 2T 03-04
BETA	RR 2T 50 EU4 50 2T 18-20, RR 50 RACING EU4 50 2T 18-20, RR ALU 50 2T 08-12, RR ENDURO 50 2T 06-17, RR MOTARD 50 2T 06-17
CH	SM 50 2T 00-10, WR 50 2T 00-10, WSM 50 2T 00-10
HUSQUARNA	ENDURO 50 2T 11-11, MOTARD 50 2T 11-11
CMC	CABALLERO MOTARD 50 2T 06-10, CABALLERO REGOLARITÀ 50 2T 06-10, ENDURO COMPETITION EU4 50 2T 18-20, ENDURO PERFORMANCE EU4 50 2T 18-20, MOTARD COMPETITION EU4 50 2T 18-20, MOTARD PERFORMANCE EU4 50 2T 18-20
FANTIC	BAJA, DERAPAGE BASIC 50 2T 10-11, CMC 50 2T 10-11, CRE BAJA RR, DERAPAGE RR 50 2T 07-11, CRE BAJA, DERAPAGE 50 2T 07-11, CRE SIX COMPETITION 50 2T 10-11, CRE SIX, BAJA, DERAPAGE 50 2T 95-06, CRE SIX, DERAPAGE COMPETITION 50 2T 07-09, DERAPAGE COMPETITION 50 2T 10-11
HM	BAJA, DERAPAGE BASIC 50 2T 10-11, CMC 50 2T 10-11, CRE BAJA RR, DERAPAGE RR 50 2T 07-11, CRE BAJA, DERAPAGE 50 2T 07-11, CRE SIX COMPETITION 50 2T 10-11, CRE SIX, BAJA, DERAPAGE 50 2T 95-06, CRE SIX, DERAPAGE COMPETITION 50 2T 07-09, DERAPAGE COMPETITION 50 2T 10-11
MBK	X LIMIT 50 2T 03-04, X POWER 50 2T 03-04
MALAGUTI	CNK DRAGON 50 2T 05-07, FIFTY EVOLUTION 50 2T 90-93, XSM 50 2T 03-03, XTM 50 2T 03-03

MINARELLI	MOTORE AM 3-4-5 50 2T 91-95, MOTORE AM 6 1° SERIE 50 2T 96-11, MOTORE AM 6 2° SERIE 50 2T 12-18
MOTORHISPANIA	FURIA 50 2T 97-00, FURIA MAX 50 2T 10-12, RX 50 2T 09-12, RX R 50 2T 09-12
PEUGEOT	SUPERMOTARD 50 2T 90-02, XP6 TRAIL S/AVV. ELETTRICO 50 2T 90-02, XR6 RACING CAT. C/AVV.ELETT. 50 2T 90-02
RIEJU	MRT 50 2T 09-12, MRT 50 EU4 50 2T 18-20, MRT PRO 50 2T 09-12, MRT PRO EU4 50 2T 18-20, MRT PRO REPLICCA EU4 50 2T 18-20, MRT PRO REPLICCA SM EU4 50 2T 18-20, MRT PRO SM 50 2T 09-12, MRT PRO SM EU4 50 2T 18-20, MRT SM 50 2T 09-12, MRT SM EU4 50 2T 18-20, MRT TROPHY EU4 50 2T 18-20, MRX 50 2T 01-04, MRX PRO 50 2T 01-04, RR 50 2T 05-06, RS1 50 2T 98-01, RS2 MATRIX 50 2T 05-06, RS2 MATRIX PRO 50 2T 05-06, RS2 NAKED 50 2T 04-05, RS3 EU4 50 2T 18-20, RS3 NKD EU4 50 2T 18-20, SMX E.S./K.S. 50 2T 01-01, SMX PRO E.S./K.S. 50 2T 03-03, SPIKE 50 2T 98-01
SHERCO	FACTORY SE-R EU4 50 2T 18-20, FACTORY SE-RS EU4 50 2T 18-20, FACTORY SILVER SM-R EU4 50 2T 18-20, FACTORY SILVER SM-RS EU4 50 2T 18-20, FACTORY SM-R EU4 50 2T 18-20, FACTORY SM-RS EU4 50 2T 18-20, HRD ENDURO 50 2T 09-13, HRD MOTARD 50 2T 09-13
VENT	BAJA 50 2T 18-20, BAJA RR 50 2T 18-20, DERAPAGE 50 2T 18-20, DERAPAGE RR 50 2T 18-20
YAMAHA	DT R 50 2T 03-11, DT RSM 50 2T 03-05, DT X 50 2T 06-11, TZR 50 2T 03-08, TZR 50 2T 10-11, TZR RR 50 2T 05-05

RICAMBI

PT00150	Pistone completo Ø 49
PT150	Pistone completo Ø 49,5
SG15679	Serie segmenti Ø 49

SG15698	Serie segmenti Ø 49,5
GR00712	Serie guarnizioni
TS00174	Testa

cod. **KT00133** Gruppo termico Ø 49 Piaggio 4T

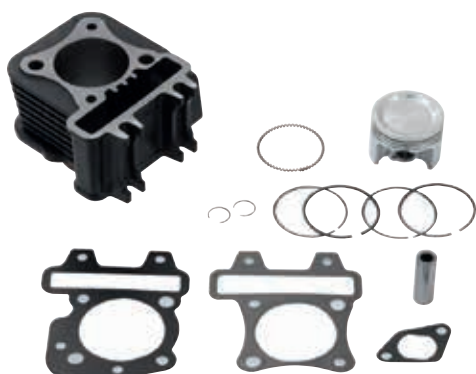

APPLICABILITÀ

APRILIA	SCARABEO 4T 50 4T 02-06, SCARABEO 4T RESTYLING EU3 50 4T 06-09, SPORT CITY ONE 4T 50 4T 08-10
DERBI	ATLANTIS 4T 50 4T 04-06, ATLANTIS 4T EU2 50 4T 07-07, BOULEVARD 4T EU2 25KM/H 50 4T 09-09
ITALJET	TORPEDO 50 4T 97-00
MALAGUTI	CENTRO EURO 2 50 4T 08-08, CENTRO SL 4T 50 4T 10-10, CIAK MASTER 4T 50 4T 05-06, CIAK MASTER EURO 2 50 4T 05-06

PIAGGIO	FLY 4T 50 4T 05-07, FLY 4T & 25-30 KM/H 50 4T 08-11, FLY 4T MOTORE CHN 50 4T 06-07, LIBERTY 4T 50 4T 00-02, LIBERTY 4T 50 4T 05-08, LIBERTY 4T DELIVERY - SINGLE 50 4T 10-14, LIBERTY 4T DELIVERY TNT 50 4T 09-09, LIBERTY 4T PTT - DOUBLE - NEXIVE 50 4T 09-17, LIBERTY 4T RST 50 4T 04-04, LIBERTY 4T SPORT 50 4T 06-08, LIBERTY MOC 4T & ELLE 50 4T 09-16, VESPA ET4 50 4T 00-05, VESPA LX 4T 50 4T 05-09, ZIP 4T 50 4T 00-13
----------------	--

RICAMBI

PT00159	Pistone Ø 49
PT159	Pistone Ø 49,5
SG15715	Serie segmenti Ø 49

SG15716	Serie segmenti Ø 49,5
SP00746	Spinotto + anellini Kymco Ø 50 4T
GR00737	Serie guarnizioni

ATTENZIONE: QUESTI PRODOTTI SONO DESTINATI ESCLUSIVAMENTE AD USO AGONISTICO. NE È QUINDI VIETATO L'UTILIZZO SU STRADA PUBBLICA.



◀ cod. **KT00012**
Gruppo termico Vespa Ø 50 3 travasi

APPLICABILITÀ

PIAGGIO APE 50 2T 09-17, APE FL - FL2 50 2T 89-95, APE FL3 EUROPA 50 2T 96-99, APE MIX 2T 50 2T 98-08, APE P 50 2T 80-85, APE RST MIX 50 2T 99-03, APE TM P 50 2T 85-89, VESPA FL 50 2T 90-90, VESPA FL2 HP 50 2T 91-97, VESPA N 50 2T 89-90, VESPA PK 50 2T 82-84, VESPA PK XL 50 2T 85-88, VESPA PK XL RUSH 50 2T 88-89, VESPA SPECIAL-L-R 50 2T 67-82

RICAMBI

PT00060	Pistone Ø 50
PT60	Pistone Ø 50,4
SG15173	Serie segmenti Ø 50
SG15175	Serie segmenti Ø 50,4

SG15177	Serie segmenti Ø 50,8
GR00727	Serie guarnizioni
TS00151	Testa



◀ cod. **KT00132**
Gruppo termico Ø 50 Kymco 4T

APPLICABILITÀ

BAOTIAN ECO BIKE 50 4T 00-04, REBEL 50 4T 03-06, ROCHY 50 4T 03-06, TANCO 50 4T 03-06
GARELLI CAPRI LX 50 4T 06-08, CICLONE 50 4T 06-08, FLEXI 50 4T 08-11, NEW VIP 50 4T 06-07, TIESSE 4T 50 4T 08-10, VIP 50 4T 06-06
HUPPER MONTECARLO 30 50 4T 11-11
KYMCO AGILITY 4T CARRY 50 4T 11-11, AGILITY 4T R10 50 4T 06-08, AGILITY 4T R12 50 4T 07-08, AGILITY PLUS 4T 50 4T 14-14, AGILITY R12 50 4T 05-05, AGILITY R12 ECS 50 4T 16-16, AGILITY R16 50 4T 08-09, AGILITY R16 50 4T 12-12, AGILITY RS 50 4T 09-09, DINK 50 4T 50 4T 07-07, FILLY 50 4T 98-00, FILLY LX 50 4T 01-02, LIKE 50 4T 09-09, PEOPLE S 4T 50 4T 06-08, SENTO 50 4T 08-08, SUPER 8 4T 50 4T 07-07, SUPER 8 4T 50 4T 09-09, VITALITY 4T 50 4T 04-04

MALAGUTI DVD 50 4T 10-10
PEUGEOT V-CLIC 50 4T 90-02
RIEJU PACIFIC 50 4T 07-08, PASEO 50 4T 07-08, TOREO 50 4T 07-08
SYM SYMPLY EURO 2 50 4T 07-08
WT MOTORS BILBAO 50 4T 11-15

RICAMBI

PT00158	Pistone Ø 50
PT158	Pistone Ø 50,5
SG15713	Serie segmenti Ø 50

SG15714	Serie segmenti Ø 50,5
SP00746	Spinotto + anellini Kymco Ø 50 4T
GR00736	Serie guarnizioni



◀ cod. **KT00014**
Gruppo termico Vespa Ø 55 6 travasi

APPLICABILITÀ

PIAGGIO APE 50 2T 09-17, APE FL - FL2 50 2T 89-95, APE FL3 EUROPA 50 2T 96-99, APE MIX 2T 50 2T 98-08, APE P 50 2T 80-85, APE RST MIX 50 2T 99-03, APE TM P 50 2T 85-89, VESPA FL 50 2T 90-90, VESPA FL2 HP 50 2T 91-97, VESPA N 50 2T 89-90, VESPA PK 50 2T 82-84, VESPA PK XL 50 2T 85-88, VESPA PK XL RUSH 50 2T 88-89, VESPA SPECIAL-L-R 50 2T 67-82

RICAMBI

PT00062	Pistone Ø 55
PT62	Pistone Ø 55,4
SG15178	Serie Segmenti Ø 55

SG15180	Serie Segmenti Ø 55,4
GR00727	Serie guarnizioni
TS00153	Testa



◀ cod. **KT00015**
Gruppo termico Vespa Ø 57 ET3 con testa

APPLICABILITÀ

PIAGGIO VESPA ET3 125 2T 76-83, VESPA PRIMAVERA 125 2T 67-83

RICAMBI

PT00063	Pistone completo Ø 57
PT63	Pistone completo Ø 57,4
SG15186	Serie segmenti Ø 57

SG15187	Serie segmenti Ø 57,4
GR00728	Serie guarnizioni
TS00158	Testa

ATTENZIONE: QUESTI PRODOTTI SONO DESTINATI ESCLUSIVAMENTE AD USO AGONISTICO. NE È QUINDI VIETATO L'UTILIZZO SU STRADA PUBBLICA.



◀ cod. **KT00018**
Gruppo termico Ø 60 PX 80

APPLICABILITÀ
PIAGGIO VESPA PX E (DEU) 80 2T 81-97

RICAMBI

PT00065	Pistone completo Ø 60
PT65	Pistone completo Ø 60,4
SG15582	Serie segmenti Ø 60

SG15583	Serie segmenti Ø 60,4
GR00729	Serie guarnizioni
TS00157	Testa



◀ cod. **KT00017**
Gruppo termico Vespa Ø 63 PX

APPLICABILITÀ
LML STAR DELUXE EU1 125 2T 01-03, STAR DELUXE EU3 125 2T 08-09, STAR DELUXE EU1 150 2T 01-03, STAR DELUXE EU3 150 2T 08-09
PIAGGIO VESPA PX 125 2T 98-01, VESPA PX 125 2T 11-16, VESPA PX 30 ANNI 125 2T 07-08, VESPA PX E ARCOBALENO 125 2T 81-97, VESPA PX EU2 125 2T 01-07, VESPA PX 150 2T 98-01, VESPA PX E ARCOBALENO 150 2T 81-97

RICAMBI

PT00064	Pistone completo Ø 63
PT64	Pistone completo Ø 63,4
SG15194	Serie segmenti Ø 63
SG15196	Serie segmenti Ø 63,4

SG15198	Serie segmenti Ø 63,8
GR00729	Serie guarnizioni
TS00156	Testa



◀ cod. **KT00019**
Gruppo termico Ø 69 per Piaggio Ape P 601 Car spinotto 18

APPLICABILITÀ
PIAGGIO APE CAR P2 (1° SERIE) 220 2T 78-82, APE P 501 220 2T 78-85, APE P 601 220 2T 78-83, APE P 601V 220 2T 78-83

RICAMBI

PT00067	Pistone Ø 69 spinotto 18
PT67	Pistone Ø 69,4 spinotto 18
SG15146	Serie segmenti Ø 69

SG15147	Serie segmenti Ø 69,4
SG15149	Serie segmenti Ø 69,8
GR00730	Serie guarnizioni

◀ cod. **KT00020**
Gruppo termico Ø 69 per Piaggio Ape MP MPV spinotto 16

APPLICABILITÀ
PIAGGIO APE MP 220 2T 78-96, APE MPM 600 220 2T 78-83, APE MPR 500 220 2T 78-83, APE MPV 600 220 2T 78-83

RICAMBI

PT00066	Pistone Ø 69 spinotto 16
SG15147	Serie segmenti Ø 69,4

SG15149	Serie segmenti Ø 69,8
SG15146	Serie segmenti Ø 69

SERIE GUARNIZIONI MOTORE

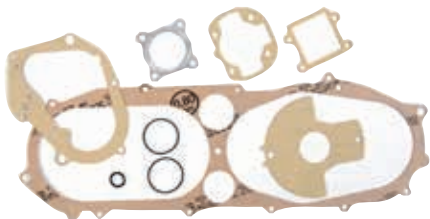

◀ cod. **GR06412**
Serie guarnizioni per motore scooter 50 cc Minarelli/Yamaha tipo verticale

◀ cod. **GR06413**
Serie guarnizioni per motore scooter 50 cc Minarelli/Yamaha orizzontale corto



◀ cod. **GR06414**
Serie guarnizioni motore scooter 50 cc Minarelli/Yamaha orizzontale lungo



◀ cod. **GR06415**
Serie guarnizioni motore scooter 50 cc Minarelli/Yamaha Liquid Cooled



◀ cod. **GR06416**
Serie guarnizioni completa per AM6 EU-1

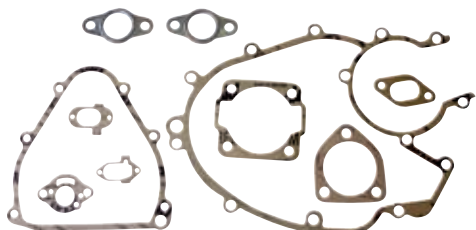

◀ cod. **GR00740**
Serie guarnizioni motore Piaggio Vespa 50 - 50 Special - 90

RIFERIMENTO ORIGINALE

Piaggio	091925
---------	--------

SERIE GUARNIZIONI MOTORE

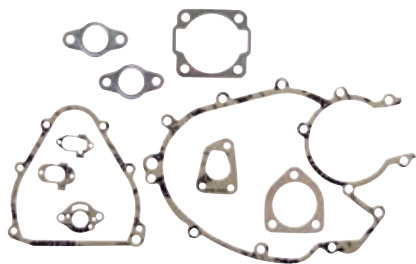

◀ cod. **GR00741**
Serie guarnizioni motore Vespa PK50-XL-FL

RIFERIMENTO ORIGINALE

Piaggio	154616
---------	--------

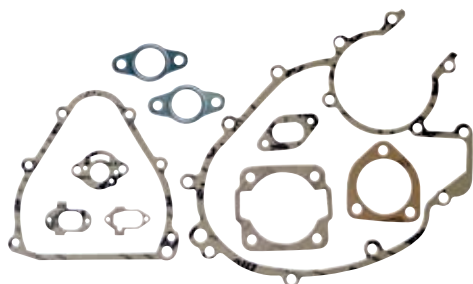

◀ cod. **GR00742**
Serie guarnizioni motore Vespa 125 Primavera

RIFERIMENTO ORIGINALE

Piaggio	153509
---------	--------

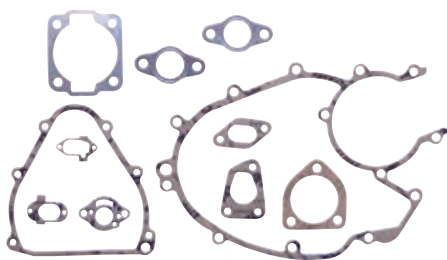

◀ cod. **GR00743**
Serie guarnizioni motore Vespa PK125-XL

RIFERIMENTO ORIGINALE

Piaggio	154630
---------	--------

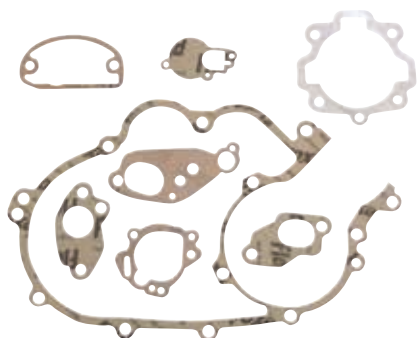

◀ cod. **GR00744**
Serie guarnizioni motore Vespa PX125-150

RIFERIMENTO ORIGINALE

Piaggio	497603
---------	--------



◀ cod. **GR00745**
Serie guarnizioni motore Piaggio Vespa PX 98-01 - PX200

RIFERIMENTO ORIGINALE

Piaggio	155446
---------	--------

GUARNIZIONI BASE CILINDRO

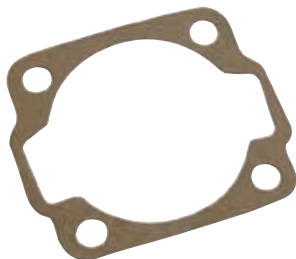

- ◀ cod. **GR06337**
Guarnizione base cilindro
Vespa 50/90 125 Primavera - ET3

GUARNIZIONI ASPIRAZIONE



- ◀ cod. **GR00739**
Guarnizione per raccordo aspirazione con flangia a tre fori Vespa PK50-PK125

RIFERIMENTO ORIGINALE

Piaggio	196931
---------	--------

GUARNIZIONI SCARICO



- ◀ cod. **GR00671**
Guarnizione scarico klingerite fori Ø 6 mm
Vespa PK 50



- ◀ cod. **GR00673**
Guarnizione raccordo scarico klingerite
Vespa PK 125



- ◀ cod. **GR00675**
Guarnizione scarico klingerite fori Ø 8 mm
Vespa 125 PK - ET3 - PX

SCARICHI PROMA



◀ cod. **MT00001**
Marmitta Proma per Vespa 50

APPLICABILITÀ

PIAGGIO VESPA SPECIAL-L-R 50 2T 67-82

RICAMBI

CT00801	Collettore marmitta proma per Vespa 50 cc
ML00830	Molla scarico proma

◀ cod. **MT00002**
Marmitta Proma per Vespa 125

APPLICABILITÀ

PIAGGIO VESPA ET3 125 2T 76-83, VESPA PRIMAVERA 125 2T 67-83

RICAMBI

CT00802	Collettore marmitta proma per Vespa 125 cc
ML00830	Molla scarico proma

SERIE SEGMENTI



◀ cod. **SG15699**
2 segmenti AC 2 x mm 1,5 semitrapezoidali (1 in cromo)
Ø 40 Minarelli/Yamaha

◀ cod. **SG15701**
2 segmenti AC 2 x mm 1,5 semitrapezoidali (1 in cromo)
Ø 40,5 Minarelli/Yamaha

◀ cod. **SG15702**
2 segmenti AC 2 x mm 1,5 semitrapezoidali (1 in cromo)
Ø 41 Minarelli/Yamaha

◀ cod. **SG15703**
2 segmenti AC 4 x mm 1,2 semitrapezoidali (1 in cromo)
Ø 40 Minarelli/Yamaha

◀ cod. **SG15704**
2 segmenti AC 4 x mm 1,2 semitrapezoidali (1 in cromo)
Ø 40,5 Minarelli/Yamaha

◀ cod. **SG15705**
2 segmenti AC 4 x mm 1,2 semitrapezoidali (1 in cromo)
Ø 41 Minarelli/Yamaha

◀ cod. **SG15682**
2 segmenti AC 4 x mm 1,2 (grano interno) Ø 40

◀ cod. **SG15683**
2 segmenti AC 4 x mm 1,2 (grano interno) Ø 40,5

◀ cod. **SG15684**
2 segmenti AC 4 x mm 1,2 (grano interno) Ø 41







◀ cod. **SCS000004**
Coperchio della scatola frizione

APPLICABILITÀ

BMW K LT 1200 4T 97-09

RIFERIMENTO ORIGINALE

BMW	21212333449
BMW	2333449

SACHS	3072000004
-------	------------



◀ cod. **SCS092230**
Coperchio della scatola frizione

APPLICABILITÀ

BMW R 45 450 4T 81-81, R 65 650 4T 81-92, R 65 G/S 650 4T 81-92, R 65 RT 650 4T 82-86, R 80 800 4T 80-80, R 80 /7 800 4T 77-80, R 80 GS 800 4T 80-94, R 80 GS PARIS DAKAR 800 4T 90-93, R 80 GS/2 800 4T 90-98, R 80 RT 800 4T 82-84, R 80 RT/2 800 4T 85-95, R 80 ST 800 4T 82-87, R 100 1000 4T 81-84, R 100 CS 1000 4T 80-85, R 100 GS 1000 4T 86-96, R 100 GS PARIS DAKAR 1000 4T 89-96, R 100 RS 1000 4T 81-92, R 100 RT 1000 4T 81-96

RIFERIMENTO ORIGINALE

BMW	1242355
BMW	1457280
BMW	21211242355

BMW	21211457280
SACHS	3072092230



◀ cod. **SCS130330**
Coperchio della scatola frizione

APPLICABILITÀ

BMW R GS 850 4T 94-00, R R 850 4T 95-01, R RT 850 4T 95-01, R GS 1100 4T 93-99, R R 1100 4T 95-01, R RS 1100 4T 92-01, R RT 1100 4T 96-01

RIFERIMENTO ORIGINALE

BMW	1341322
BMW	1341585
BMW	21211341322
BMW	21211341585

BMW	21212330024
BMW	2330024
SACHS	3072130330



◀ cod. **SCS135132**
Coperchio della scatola frizione

APPLICABILITÀ

BMW R C 850 4T 97-01, R R 850 4T 00-07, R RT 850 4T 01-06, R S 1100 4T 98-05, R GS 1150 4T 99-04, R GS ADVENTURE 1150 4T 02-05, R R 1150 4T 01-06, R RS 1150 4T 01-05, R RT 1150 4T 01-05

RIFERIMENTO ORIGINALE

BMW	21212333023
BMW	2333023

SACHS	3072135132
-------	------------



◀ cod. **SCS135530**
Coperchio della scatola frizione

APPLICABILITÀ

BMW R C AVANTGARDE 1200 4T 98-02, R C INDEPENDENT 1200 4T 00-05, R C MONTAUK 1200 4T 04-05, R CL 1200 4T 03-05

RIFERIMENTO ORIGINALE

BMW	21212332467
BMW	21212333322
BMW	2332467

BMW	2333322
SACHS	3072135530



◀ cod. **SCS136030**
Coperchio della scatola frizione

APPLICABILITÀ

BMW K 1 1000 4T 89-93, K 100 LT 1000 4T 83-92, K 100 RS 1000 4T 83-89, K 100 RS 16V 1000 4T 89-82, K 100 RT 1000 4T 83-89, K 1100 LT 1100 4T 90-98, K 1100 RS 1100 4T 92-96, K GT 1200 4T 01-05, K RS 1200 4T 97-05

RIFERIMENTO ORIGINALE

BMW	1451273
BMW	21211451273
BMW	21212333472

BMW	2333472
SACHS	3072136030



◀ cod. **SDF000122**
Disco frizione

APPLICABILITÀ

BMW K GT 1200 4T 01-05, K LT 1200 4T 97-09, K RS 1200 4T 97-05

RIFERIMENTO ORIGINALE

BMW	21212332090
BMW	21212332973
BMW	21217670455
BMW	2332090

BMW	2332973
BMW	7670455
SACHS	1864000122



◀ cod. **SDF000124**
Disco frizione

APPLICABILITÀ

BMW R C 850 4T 97-01, R R 850 4T 00-07, R RT 850 4T 01-06, R S 1100 4T 98-05, R GS 1150 4T 99-04, R GS ADVENTURE 1150 4T 02-05, R R 1150 4T 01-06, R RS 1150 4T 01-05, R RT 1150 4T 01-05, R C AVANTGARDE 1200 4T 98-02, R C INDEPENDENT 1200 4T 00-05, R C MONTAUK 1200 4T 04-05, R CL 1200 4T 03-05

RIFERIMENTO ORIGINALE

BMW	2121233262
BMW	21217670454
BMW	2333262

BMW	7670454
SACHS	1864000124



◀ cod. **SDF001744**
Disco frizione

APPLICABILITÀ

BMW R 50 /5 500 4T 69-73, R 60 /5 600 4T 69-73, R 60 /6 600 4T 74-76, R 60 /7 600 4T 76-80, R 60 T 600 4T 76-80, R 75 /5 750 4T 69-73, R 75 /6 750 4T 73-76, R 75 /7 750 4T 76-79, R 90 /6 900 4T 73-76, R 90 S 900 4T 73-76, R 100 /7 1000 4T 76-80, R 100 /T, RT 1000 4T 78-80, R 100 RS 1000 4T 76-80, R 100 S 1000 4T 76-80

RIFERIMENTO ORIGINALE

SACHS	1864001744
-------	------------



◀ cod. **SDF373033**
Disco frizione

APPLICABILITÀ

BMW R 45 450 4T 78-80, R 65 650 4T 78-80

RIFERIMENTO ORIGINALE

BMW	1237571
BMW	21211237571

SACHS	1864373033
-------	------------



◀ cod. **SDF378132**

Disco frizione

APPLICABILITÀ

BMW R 45 450 4T 81-81, R 65 650 4T 81-92, R 65 G/S 650 4T 81-92, R 65 RT 650 4T 82-86, R 80 800 4T 80-80, R 80 /7 800 4T 77-80, R 80 GS 800 4T 80-94, R 80 GS PARIS DAKAR 800 4T 90-93, R 80 GS/2 800 4T 90-98, R 80 RT 800 4T 82-84, R 80 RT/2 800 4T 85-95, R 80 ST 800 4T 82-87, R 100 1000 4T 81-84, R 100 CS 1000 4T 80-85, R 100 GS 1000 4T 86-96, R 100 GS PARIS DAKAR 1000 4T 89-96, R 100 RS 1000 4T 81-92, R 100 RT 1000 4T 81-96

RIFERIMENTO ORIGINALE

BMW	1242370
BMW	1451512
BMW	21211242370

BMW	21211451512
SACHS	1864378132



◀ cod. **SDF400031**

Disco frizione

APPLICABILITÀ

BMW K 1 1000 4T 89-93, K 100 LT 1000 4T 83-92, K 100 RS 1000 4T 83-89, K 100 RS 16V 1000 4T 89-82, K 100 RT 1000 4T 83-89, K 1100 LT 1100 4T 90-98, K 1100 RS 1100 4T 92-96

RIFERIMENTO ORIGINALE

BMW	1451271
BMW	1451721
BMW	1464795
BMW	21211451271

BMW	21211451721
BMW	21211464795
SACHS	1864400031



◀ cod. **SDF419032**

Disco frizione

APPLICABILITÀ

BMW R 75 /2 750 4T 89-96, R 75 C 750 4T 85-88, R 75 RT 750 4T 89-95, R 75 S 750 4T 85-94

RIFERIMENTO ORIGINALE

BMW	1450831
BMW	1454607
BMW	1464796
BMW	21211450831

BMW	2121145460
BMW	21211464796
SACHS	1864419032



◀ cod. **SDF523632**

Disco frizione

APPLICABILITÀ

BMW R GS 850 4T 94-00, R R 850 4T 95-01, R RT 850 4T 95-01, R GS 1100 4T 93-99, R R 1100 4T 95-01, R RS 1100 4T 92-01, R RT 1100 4T 96-01

RIFERIMENTO ORIGINALE

BMW	21212325862
BMW	21212325864
BMW	21217670452
BMW	21217670453
BMW	2325862

BMW	2325864
BMW	7670452
BMW	7670453
SACHS	1864523632

KIT FRIZIONE



◀ cod. **SSD951031**
Kit frizione

APPLICABILITÀ

BMW R GS 850 4T 94-00, R R 850 4T 95-01, R RT 850 4T 95-01, R GS 1100 4T 93-99, R R 1100 4T 95-01, R RS 1100 4T 92-01, R RT 1100 4T 96-01

CONTIENE

Molla a diaframma	SMD001031
Spingidisco frizione	SSD098930
Coperchio della scatola	SC5130330
Disco frizione	SDF523632
Grasso	

RIFERIMENTO ORIGINALE

SACHS	3000951031
-------	------------

MOLLE A DIAFRAMMA



◀ cod. **SMD000001**
Molla a diaframma

APPLICABILITÀ

BMW K GT 1200 4T 01-05, K LT 1200 4T 97-09, K RS 1200 4T 97-05

RIFERIMENTO ORIGINALE

BMW	21212332925
BMW	2332925

SACHS	3054000001
-------	------------



◀ cod. **SMD001031**
Molla a diaframma

APPLICABILITÀ

BMW R 45 450 4T 81-81, R 65 650 4T 81-92, R 65 G/5 650 4T 81-92, R 65 RT 650 4T 82-86, R 80 800 4T 80-80, R 80 /7 800 4T 77-80, R 80 GS 800 4T 80-94, R 80 GS PARIS DAKAR 800 4T 90-93, R 80 GS/2 800 4T 90-98, R 80 RT 800 4T 82-84, R 80 RT/2 800 4T 85-95, R 80 ST 800 4T 82-87, R GS 850 4T 94-00, R R 850 4T 95-01, R RT 850 4T 95-01, R 100 1000 4T 81-84, R 100 CS 1000 4T 80-85, R 100 GS 1000 4T 86-96, R 100 GS PARIS DAKAR 1000 4T 89-96, R 100 RS 1000 4T 81-92, R 100 RT 1000 4T 81-96, R GS 1100 4T 93-99, R R 1100 4T 95-01, R RS 1100 4T 92-01, R RT 1100 4T 96-01

RIFERIMENTO ORIGINALE

BMW	1338508
BMW	21211338508

SACHS	3054001031
-------	------------



◀ cod. **SMD003130**
Molla a diaframma

APPLICABILITÀ

BMW R 75 /2 750 4T 89-96, R 75 C 750 4T 85-88, R 75 RT 750 4T 89-95, R 75 S 750 4T 85-94

RIFERIMENTO ORIGINALE

BMW	1454784
BMW	21211454784

SACHS	3054003130
-------	------------



◀ cod. **SMD004030**
Molla a diaframma

APPLICABILITÀ

BMW K 1 1000 4T 89-93, K 100 LT 1000 4T 83-92, K 100 RS 1000 4T 83-89, K 100 RS 16V 1000 4T 89-82, K 100 RT 1000 4T 83-89, K 1100 LT 1100 4T 90-98, K 1100 RS 1100 4T 92-96

RIFERIMENTO ORIGINALE

BMW	1464092
BMW	21211464092

SACHS	3054004030
-------	------------



◀ cod. **SMD005031**
Molla a diaframma

APPLICABILITÀ

BMW R C 850 4T 97-01, R R 850 4T 00-07, R RT 850 4T 01-06, R S 1100 4T 98-05, R GS 1150 4T 99-04, R GS ADVENTURE 1150 4T 02-05, R R 1150 4T 01-06, R RS 1150 4T 01-05, R RT 1150 4T 01-05, R C AVANTGARDE 1200 4T 98-02, R C INDEPENDENT 1200 4T 00-05, R C MONTAUK 1200 4T 04-05, R CL 1200 4T 03-05

RIFERIMENTO ORIGINALE

BMW	21212345597
BMW	2345597

SACHS	3054005031
-------	------------

SCATOLE FRIZIONE



◀ cod. **SSF133030**
Scatola frizione

APPLICABILITÀ

BMW R C AVANTGARDE 1200 4T 98-02, R C INDEPENDENT 1200 4T 00-05, R C MONTAUK 1200 4T 04-05, R CL 1200 4T 03-05

RIFERIMENTO ORIGINALE

BMW	21212331000
BMW	2331000

SACHS	3072133030
-------	------------



◀ cod. **SSF135031**
Scatola frizione

APPLICABILITÀ

BMW CH26 505 10-19, CH26 EVO 505 16-19

BMW ROXSY 440 08-19, XHEOS 442 08-19, ROXSY 523 08-19

RIFERIMENTO ORIGINALE

BMW	21217666246
BMW	7666246

SACHS	3072135031
-------	------------



◀ cod. **SSD000006**

Spingidisco

APPLICABILITÀ

BMW K GT 1200 4T 01-05, K LT 1200 4T 97-09, K RS 1200 4T 97-05

RIFERIMENTO ORIGINALE

BMW	21212332974
BMW	2332974

SACHS	3071000006
-------	------------



◀ cod. **SSD072030**

Spingidisco

APPLICABILITÀ

BMW R 45 450 4T 81-81, R 65 650 4T 81-92, R 65 G/S 650 4T 81-92, R 65 RT 650 4T 82-86, R 80 800 4T 80-80, R 80 /7 800 4T 77-80, R 80 GS 800 4T 80-94, R 80 GS PARIS DAKAR 800 4T 90-93, R 80 GS/2 800 4T 90-98, R 80 RT 800 4T 82-84, R 80 RT/2 800 4T 85-95, R 80 ST 800 4T 82-87, R 100 1000 4T 81-84, R 100 CS 1000 4T 80-85, R 100 GS 1000 4T 86-96, R 100 GS PARIS DAKAR 1000 4T 89-96, R 100 RS 1000 4T 81-92, R 100 RT 1000 4T 81-96

RIFERIMENTO ORIGINALE

BMW	1242354
BMW	21211242354
BMW	21212302200

BMW	2302200
SACHS	3071072030



◀ cod. **SSD086331**

Spingidisco

APPLICABILITÀ

BMW K 1 1000 4T 89-93, K 100 LT 1000 4T 83-92, K 100 RS 1000 4T 83-89, K 100 RS 16V 1000 4T 89-82, K 100 RT 1000 4T 83-89, K 1100 LT 1100 4T 90-98, K 1100 RS 1100 4T 92-96

RIFERIMENTO ORIGINALE

BMW	1451270
BMW	1464320
BMW	1464570
BMW	21211451270

BMW	21211464320
BMW	21211464570
SACHS	3071086331



◀ cod. **SSD088031**
Spingidisco

APPLICABILITÀ

BMW R 75 /2 750 4T 89-96, R 75 C 750 4T 85-88, R 75 RT 750 4T 89-95, R 75 S 750 4T 85-94

RIFERIMENTO ORIGINALE

BMW	1454408
BMW	1457458
BMW	21211454408

BMW	21211457458
SACHS	3071088031



◀ cod. **SSD098930**
Spingidisco

APPLICABILITÀ

BMW R GS 850 4T 94-00, R R 850 4T 95-01, R RT 850 4T 95-01, R GS 1100 4T 93-99, R R 1100 4T 95-01, R RS 1100 4T 92-01, R RT 1100 4T 96-01

RIFERIMENTO ORIGINALE

BMW	21212325863
BMW	21212330023
BMW	2325863

BMW	2330023
SACHS	3071098930



◀ cod. **SSD099531**
Spingidisco

APPLICABILITÀ

BMW R C 850 4T 97-01, R R 850 4T 00-07, R RT 850 4T 01-06, R S 1100 4T 98-05, R GS 1150 4T 99-04, R GS ADVENTURE 1150 4T 02-05, R R 1150 4T 01-06, R RS 1150 4T 01-05, R RT 1150 4T 01-05, R C AVANTGARDE 1200 4T 98-02, R C INDEPENDENT 1200 4T 00-05, R C MONTAUK 1200 4T 04-05, R CL 1200 4T 03-05

RIFERIMENTO ORIGINALE

BMW	21212333022
BMW	2333022

SACHS	3071099531
-------	------------







◀ cod. **Y02CT01XB**

Coppia contrappesi manubrio blu

Contrappesi in alluminio lavorato dal pieno con inserto anodizzato disponibile in vari colori. Disegnati e progettati per migliorare lo stile del tuo Tmax, proteggono il manubrio in caso di urti o cadute.

- LEGGERI ED ELEGANTI
- PROTEGGONO IL MANUBRIO IN CASO DI CADUTA
- MINIMO INGOMBRO LATERALE
- ALLUMINIO 6082 LAVORATO DAL PIENO
- INSERTI ANODIZZATI DISPONIBILE IN VARI COLORI

APPLICABILITÀ

Yamaha MAJESTY 250 4T 96-03, MAJESTY ABS 250 4T 03-03, MAJESTY DX 250 4T 98-99, MAJESTY 400 4T 04-11, MAJESTY ABS 400 4T 07-11, XP530-A-T-MAX SX 530 4T 17-19, XP530D-A-T-MAX DX 530 4T 17-19, XP530E-A-T-MAX 530 4T 17-18, MT-07 700 4T 14-16, MT-07 MC MOTO CAGE 700 4T 14-14, MT-07A 700 4T 17-18, MT-07A ABS 700 4T 14-16, MT-07A MC MOTO CAGE 700 4T 14-14, MT690 XSR700 700 4T 18-18, MT690-U XSR700 700 4T 18-18, MT690-U XSR700 35KW 700 4T 18-18, XSR 700 4T 16-18



◀ cod. **Y02CT01XO**

Coppia contrappesi manubrio oro



◀ cod. **Y02CT01XR**

Coppia contrappesi manubrio rosso



◀ cod. **Y02CT01XT**

Coppia contrappesi manubrio titanio

COVER FORO SPECCHI



◀ cod. **Y02TS01XB**

Coppia cover attacco specchio blu

Con un design semplice ed elegante si integrano con la carenatura originale del Tmax. Queste cover sono studiate per chiudere il foro di fissaggio degli specchi retrovisori, se questi vengono montati sul manubrio.

- LEGGERI ED ELEGANTI
- IN ALLUMINIO 6082 RICAVATO DAL PIENO
- ANODIZZAZIONE IN PIÙ COLORI
- SI MONTANO SULLA GUARNIZIONE ORIGINALE

APPLICABILITÀ

Yamaha XP530-A-T-MAX SX 530 4T 17-19, XP530D-A-T-MAX DX 530 4T 17-19, XP530E-A-T-MAX 530 4T 17-18



◀ cod. **Y02TS01XO**

Coppia cover attacco specchio oro



◀ cod. **Y02TS01XR**

Coppia cover attacco specchio rosso



◀ cod. **Y02TS01XT**

Coppia cover attacco specchio titanio

LEVA FRENO A MANO



◀ cod. **Y02FS01XB**

Leva freno stazionamento blu

Leva freno di stazionamento esclusiva per Yamaha TMAX, leggera e dal design elegante. L'inserto frontale che incornicia il logo Reckless è disponibile in più colori. L'inserto posteriore è di colore rosso e indica che il freno di stazionamento è azionato.

- LEGGERA ED ELEGANTE
- IN ALLUMINIO 6082 LAVORATO DAL PIENO
- INSERTO FRONTALE DISPONIBILE IN PIÙ COLORI
- INSERTO POSTERIORE ROSSO

APPLICABILITÀ

Yamaha MAJESTY 400 4T 04-11, MAJESTY ABS 400 4T 07-11, X-MAX RA 400 4T-4V 18-18, T-MAX 4B5 500 4T 09-11, T-MAX 4B5 ABS 500 4T 08-11, T-MAX 5VU 500 4T 04-08, T-MAX 5VU ABS 500 4T 05-07, T-MAX 5VU BLACK MAX 500 4T 06-06, T-MAX 5VU BLACK MAX - NIGHT MAX 500 4T 07-07, T-MAX SV 500 4T 11-11, T-MAX SV ABS 500 4T 10-11, T-MAX WHITE MAX 500 4T 10-10, T-MAX 59C 530 4T 12-16, T-MAX 59C ABS 530 4T 12-16, T-MAX 59C SP 530 4T 15-15, T-MAX 59C SP ABS 530 4T 15-16, XP530-AT-T-MAX SX 530 4T 17-19, XP530D-A T-MAX DX 530 4T 17-19, XP530E-A T-MAX 530 4T 17-18



◀ cod. **Y02FS01XA**

Leva freno stazionamento alluminio



◀ cod. **Y02FS01XO**

Leva freno stazionamento oro



◀ cod. **Y02FS01XT**

Leva freno stazionamento titanio

PEDALINE PASSEGGERO



◀ cod. **Y02PD01XB**

Coppia pedane passeggero blu

La pedalina Reckless è il frutto di un lungo lavoro di design e tecnologia volto a sviluppare un prodotto che offre elevate caratteristiche meccaniche ed un look esclusivo.

- IN ALLUMINIO 6082 LAVORATO DAL PIENO
- INSERTO DISPONIBILE IN VARI COLORI
- VITERIA PER IL MONTAGGIO INCLUSA

APPLICABILITÀ

Yamaha T-MAX 59C 530 4T 12-16, T-MAX 59C ABS 530 4T 12-16, T-MAX 59C SP 530 4T 15-15, T-MAX 59C SP ABS 530 4T 15-16, XP530-A T-MAX SX 530 4T 17-19, XP530D-A T-MAX DX 530 4T 17-19, XP530E-AT-T-MAX 530 4T 17-18, FZ6 600 4T 04-07, FZ6 FAZER 600 4T 04-07, FZ6 FAZER ABS 600 4T 06-07, FZ6 NS 600 4T 05-06, MT-07 700 4T 14-16, MT-07 MC MOTO CAGE 700 4T 14-14, MT-07A 700 4T 17-18, MT-07A ABS 700 4T 14-16, MT-07A MC MOTO CAGE 700 4T 14-14, FZ8-N 800 4T 11-13, FZ8-N 800 4T 15-15, FZ8-NA 800 4T 11-13, FZ8-NA 800 4T 15-15, FZ8-S 800 4T 11-11, FZ8-S 800 4T 15-15, FZ8-SA 800 4T 11-15, MT-09 850 4T 14-15, MT-09 (MTN850-A) 850 4T 17-18, MT-09 SP (MTN850D) 850 4T 18-18, MT-09A ABS 850 4T 14-16, MT-09A TRACER 850 4T 15-17, XRS900 850 4T 16-18, FZ1 1000 4T 06-09, FZ1 FAZER 1000 4T 06-12, FZ1 FAZER ABS 1000 4T 07-12, FZ1-N 1000 4T 11-11, FZ1-NA 1000 4T 10-11, MT-10 1000 4T 16-18, MT-10D 1000 4T 17-17



◀ cod. **Y02PD01XO**

Coppia pedane passeggero



◀ cod. **Y02PD01XR**

Coppia pedane passeggero rosso



◀ cod. **Y02PD01XT**

Coppia pedane passeggero titanio



◀ **cod. Y02PL01RB**

Protezione leva freno dx blu

Per offrire il massimo al tuo TMax, Reckless ha creato un componente dall'animo racing e dal design unico. Progettato e testato per le competizioni, protegge la leva freno da urti che possono causarne l'azionamento accidentale. Il paraleva Reckless è regolabile e ripara leva freno e mani in caso di caduta.

- DESIGN SPORTIVO ED ELEGANTE
- PROTEGGE LA LEVA FRENO E LE MANI DA URTI ACCIDENTALI O CADUTE
- IN ALLUMINIO 6082 RICAVATO DAL PIENO
- INSERTI DISPONIBILI IN PIÙ COLORI
- REGOLABILE

APPLICABILITÀ

Yamaha MAJESTY 250 4T 96-03, MAJESTY ABS 250 4T 03-03, MAJESTY DX 250 4T 98-99, MAJESTY 400 4T 04-11, MAJESTY ABS 400 4T 07-11, XP530-A T-MAX SX 530 4T 18-19, XP530D-A T-MAX DX 530 4T 18-19, XP530E-A T-MAX 530 4T 18-18, MT-07 700 4T 14-16, MT-07 MC MOTO CAGE 700 4T 14-14, MT-07A 700 4T 17-18, MT-07A ABS 700 4T 14-16, MT-07A MC MOTO CAGE 700 4T 14-14, MT690 XSR700 700 4T 18-18, MT690-U XSR700 700 4T 18-18, MT690-U XSR700 35KW 700 4T 18-18, XSR 700 4T 16-18



◀ **cod. Y02PL01RO**
Protezione leva freno dx oro



◀ **cod. Y02PL01RR**
Protezione leva freno dx rosso



◀ **cod. Y02PL01RT**
Protezione leva freno dx titanio

TAPPO FLUIDO FRENI



◀ **cod. Y02TF01XB**

Coppia coperchi fluido freni blu

Coperchio serbatoio fluido freni in alluminio lavorato dal pieno con inserto colorato personalizzabile. Design elegante e lavorazioni di qualità. Consente l'utilizzo della guarnizione originale, riportando le indicazioni relative al cambio olio.

- INSERTO ANODIZZATO DISPONIBILE IN VARI COLORI
- COMPATIBILE CON LA GUARNIZIONE ORIGINALE
- INDICAZIONE FLUIDO FRENI DOT4

APPLICABILITÀ

Yamaha MAJESTY 400 4T 09-11, MAJESTY ABS 400 4T 09-11, T-MAX 4B5 500 4T 09-11, T-MAX 4B5 ABS 500 4T 08-11, T-MAX 5VU 500 4T 08-08, T-MAX SV 500 4T 11-11, T-MAX SV ABS 500 4T 10-11, T-MAX WHITE MAX 500 4T 10-10, T-MAX 59C 530 4T 12-16, T-MAX 59C ABS 530 4T 12-16, T-MAX 59C SP 530 4T 15-15, T-MAX 59C SP ABS 530 4T 15-16, XP530-A T-MAX SX 530 4T 17-19, XP530D-A T-MAX DX 530 4T 17-19, XP530E-A T-MAX 530 4T 17-18, XV950 950 4T 14-14, XV950CU 950 4T 14-16, XV950R 950 4T 14-17, XVS1300A MIDNIGHT STAR 1300 4T 11-16, XVS1300CU CUSTOM 1300 4T 14-16

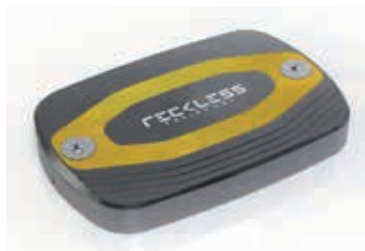

◀ **cod. Y02TF01XO**
Coppia coperchi fluido freni oro



◀ **cod. Y02TF01XR**
Coppia coperchi fluido freni rosso



◀ **cod. Y02TF01XT**
Coppia coperchi fluido freni titanio



◀ cod. **Y02TM01XB**

Tappo carico olio motore blu

Il tappo carico olio motore Reckless è realizzato in alluminio lavorato dal pieno ed è stato progettato per aggiungere stile e colore al Tmax Yamaha.

- LEGGERO ED ELEGANTE
- ALLUMINIO 6082 LAVORATO DAL PIENO
- INSERTO DISPONIBILE IN VARI COLORI
- GUARNIZIONE O-RING INCLUSA

APPLICABILITÀ

Yamaha

T-MAX 4B5 500 4T 09-11, T-MAX 4B5 ABS 500 4T 08-11, T-MAX 5GJ 500 4T 01-03, T-MAX 5VU 500 4T 04-08, T-MAX 5VU ABS 500 4T 05-07, T-MAX 5VU BLACK MAX 500 4T 06-06, T-MAX 5VU BLACK MAX - NIGHT MAX 500 4T 07-07, T-MAX SV 500 4T 11-11, T-MAX SV ABS 500 4T 10-11, T-MAX WHITE MAX 500 4T 10-10, T-MAX 59C 530 4T 12-16, T-MAX 59C ABS 530 4T 12-16, T-MAX 59C SP 530 4T 15-15, T-MAX 59C SP ABS 530 4T 15-16, XP530-A T-MAX SX 530 4T 17-19, XP530D-A T-MAX DX 530 4T 17-19, XP530E-A T-MAX 530 4T 17-18, MT-09 850 4T 14-15, MT-09 (MTN850-A) 850 4T 17-18, MT-09 SP (MTN850D) 850 4T 18-18, MT-09A ABS 850 4T 14-16, MT-09A TRACER 850 4T 15-18, MT-09A TRACER GT (MTT850D) 850 4T 18-18, MXT850 NIKEN 850 4T 18-18, XRS900 850 4T 16-18



◀ cod. **Y02TM01XO**
Tappo carico olio motore oro



◀ cod. **Y02TM01XR**
Tappo carico olio motore rosso



◀ cod. **Y02TM01XT**
Leva freno stazionamento titanio







◀ **cod. XPP1**
OXZT CHAIN LUBE

400 ml

- Lubrificante sintetico trasparente alte prestazioni per trasmissione O-Ring
- Additivi EXTREME PRESSURE e ANTIGOCCIA per forti velocità di rotazione
- Forte resistenza del film lubrificante, resiste all'azione dilavante dell'acqua
- Riduce le temperature d'esercizio

Lubrifica uniformemente, non sporca, alta scorrevolezza, protegge la trasmissione dalla corrosione anche in ambienti salini, garantisce elevata resistenza del film lubrificante e limita la generazione del calore allungando i tempi di manutenzione.

OXZT CHAIN LUBE consente l'applicazione in condizioni umide, asciutte, strada, pista, fuoristrada, è composto da

molecole che si ancorano alla superficie e si distribuiscono in modo ordinato per una lubrificazione omogenea. OXZT CHAIN LUBE non necessita di essere utilizzato in grandi quantità per aderire perfettamente alla catena, un eccesso di prodotto andrebbe a sovrapporsi inutilmente creando uno strato non ancorato alla trasmissione.

Modalità d'uso:

- Pulire la trasmissione con OXZT CLEANER (senza acqua) oppure con LINFA BIO MOTO WASH concentrato.
- Agitare OXZT CHAIN LUBE e applicare una moderata quantità sulla trasmissione
- Rimuovere con un panno pulito l'eccesso di lubrificante
- Attendere 2 ore dall'applicazione solo per forti velocità di rotazione (race)



◀ **cod. XPP2**
OXZT CLEANER

500 ml

- Sgrassante parti meccaniche e trasmissione **o-ring**
- Rapida evaporazione senza residui
- Compatibile con parti in gomma
- Erogazione ad alta pressione
- Senza risciacquo

Formulato per sgrassare a fondo senza acqua parti di motore e trasmissione O-RING da unto, grasso, morchia, incrostazioni e catrame, OXZT CLEANER ha un erogatore ad alta pressione sgrassante decontaminante che prepara ad una corretta lubrificazione la trasmissione O-RING e parti meccaniche.

La corretta decontaminazione della trasmissione è indispensabile per garantire un rendimento efficiente del lubrificante catena.

Compatibile con le parti in gomma e plastica, pulisce a fondo anche pompe freno, carburatori, frizioni, parti di motore, ingranaggi, l'esterno motore, steli forcella, sospensioni.

Modalità d'uso:

- Attendere il raffreddamento del motore.
- Agitare prima dell'uso.
- Spruzzare ad una distanza di 15 cm consecutivamente per almeno 4 secondi.
- Se necessario, aiutarsi con un panno F-CLEAN EVO imbevuto con OXZT CLEANER.
- Applicare OXZT CHAIN LUBE per lubrificare la trasmissione.



◀ **cod. XPP3**
LUXE

400 ml

- Protettivo lucidante con silicone
- Resiste alle alte temperature
- Protegge e rinnova parti in gomma e plastiche
- Film protettivo idrorepellente con azione **distaccante**

Resistendo alle alte temperature, protegge e rende brillante tutto il blocco motore, carbonio, scarico completo in titanio e con finiture in carbonio, telaio, gomma, manicotti motore, fodero forcella e plastiche.

Ripristina le parti in gomma deteriorate formando un film trasparente lucido che protegge da corrosione, umidità, sporco, sole e condizioni saline.

Nelle situazioni estreme del fuoristrada crea un film distaccante che riduce l'attaccamento di fango e sporco su cerchi, raggi, carro, telaio, parafanghi, plastiche, scarico, motore, proteggendo anche le parti elettriche dall'acqua

anche durante l'attraversamento di guadi. Contiene silicone, non utilizzare sui freni.

Modalità d'uso:

- Applicare LUXE dopo la pulizia, agitare prima dell'uso.
- Per ottenere massima protezione e creare il potente film distaccante, spruzzare LUXE in modo uniforme da una distanza di 15 cm.
- Per ottenere media brillantezza e creare il potente film protettivo, spruzzare LUXE in modo uniforme da una distanza di 15 cm e distribuire il prodotto con il panno morbido F-CLEAN.
- Spruzzare LUXE su un panno morbido F-CLEAN, distribuire in modo uniforme per ottenere media brillantezza e un potente film protettivo sottile.
- Non utilizzare i panni imbevuti di LUXE con altri prodotti.



◀ cod. **XPP4**
ACTIVE FOAM

400 ml

- Schiuma attiva igienizzante
- Deterge casco e moto con verniciatura opaca e lucida
- Elimina sporco, incrostazioni, olio, moscerini, aloni, sudore.
- Senza acqua e senza risciacquo

Pulisce a fondo carene e casco con verniciatura opaca e lucida, telaio, parti cromate, steli forcella, scarico, strumentazione TFT e touch, manopole, alluminio, acciaio, carbonio, titanio, plastica non verniciata, specchi, plexiglass, rivestimenti ceramici, parti anodizzate, calotta del casco, visiera anche specchiata e rivestimento interno, pelle naturale e sintetica, stivali, tute in pelle. Non rovina adesivi e grafiche. Non contiene silicone. Non utilizzare su pelle scamosciata e nabuk. Teme il gelo.

Modalità d'uso pulizia moto:

- Attendere il raffreddamento del motore e dello scarico.
- Agitare prima dell'uso.
- Per sporchi pesanti, distribuire ACTIVE FOAM sulla parte da pulire, quando la schiuma inizia a dissolversi, rimuovere con il panno F-CLEAN EVO.
- Per sporchi medi, spruzzare ACTIVE FOAM su un panno morbido F-CLEAN EVO e rimuovere lo sporco.
- Procedi a piccole zone, evitando così che il prodotto si dissolva prima di aver completato la rifinitura con il panno.

Modalità d'uso pulizia rivestimento del casco e pelle:

- Agitare e distribuire direttamente sulla parte da trattare.
- Rimuovere con il panno F-CLEAN (oppure con panno ANTIBATTERICO).



◀ cod. **XPP6**
RF54 WHEEL CLEANER

400 ml

- Pulitore e protettivo per cerchi in lega moto
- Elimina con estrema facilità lo sporco più ostinato
- Formulazione con additivi antiruggine, idrorepellenti, anticorrosione
- Senza acqua e senza risciacquo

Elimina lo sporco più ostinato come morchia, incrostazioni, colla, grasso, sporco stradale, catrame, residui di gomma fusa su moto da corsa.

I suoi additivi antiruggine e idrorepellenti formano un film anticorrosione che proteggono i cerchi in lega degli agenti

atmosferici e salini.

Rimuove macchie e sporco ostinato dalle parti verniciate. Non contiene silicone. Non utilizzare sui freni.

Modalità d'uso:

- Applicare **RF54 WHEEL CLEANER** a zone e rimuovere con il panno morbido F-CLEAN, oppure sullo sporco ostinato, lasciare agire un minuto prima di rimuovere.
- Procedi con la pulizia a piccole zone.
- Non utilizzare su dischi, pastiglie freno, in caso di contatto pulire con **STOP BRAKE CLEANER**.



◀ cod. **XPP7**
STOP BRAKE CLEANER

500 ml

- Pulitore freni alte prestazioni
- Evaporazione rapida senza residui
- Erogatore alta pressione

Per qualsiasi impianto frenante ad alte prestazioni, la combinazione di pinza, dischi e pastiglie perfettamente puliti, è fondamentale per assicurarne il corretto funzionamento ed un'usura controllata.

Sgrassa a fondo ed evapora rapidamente, eliminando qualsiasi tipo di sporco e residui di pastiglie organiche, sinterizzate, fino alle carbon-ceramiche. STOP BRAKE CLEANER non lascia residui oleosi e non intacca le parti in

gomma e plastica.

Offre il massimo delle prestazioni anche nelle competizioni più estreme, soddisfacendo le specifiche esigenze di tutti i tipi di moto: maggior controllo, stabilità dell'impianto, aumento della potenza frenante, modulazione della frenata costante.

Modalità d'uso pulizia moto:

- Attendere il raffreddamento dei freni.
- Agitare prima dell'uso.
- Spruzzare direttamente sulla parte, oppure sul panno F-CLEAN EVO e procedere con la pulizia.



◀ **cod. XPP8**
HYDRO –XMULTY erogatore smart
400 ml

- Sbloccante
- Lubrificante
- Protettivo
- Detergente
- Idrorepellente
- Disossidante
- Anticongelante
- Antiruggine
- Anticorrosione anche per uso marino
- Tasto smart con canola doppia erogazione
- Valvola 360° all-position

Sbloccante per dadi, viti, bulloni e meccanismi inceppati a causa di ruggine o incrostazioni. Disossidante per contatti elettrici ed elettronici. Anticongelante per parti motore e meccanismi di precisione. Deterge, lubrifica, protegge leveraggi, perni ruota, molle, pedane e meccanismi di precisione, elimina l'umidità e lo sporco.

Modalità d'uso:

- Agitare prima dell'uso.
- Spruzzare sulla parte.
- Se necessario aiutarsi con un panno.



◀ **cod. XPP11**
CERAFAST
300 ml

- Per parti verniciate e trasparenti di moto e casco
- Naturale e Idrofobizzante
- Vernice brillante e setosa al tatto
- Protegge dalla penetrazione dello sporco, insetti

Già a bassi dosaggi, ha elevate proprietà di scorrimento che garantiscono la rottura immediata del velo d'acqua con effetto seta sulle parti verniciate.

La sua speciale composizione forma un film protettivo persistente, senza stratificare con l'uso, che protegge le superfici trattate dalla penetrazione di sostanze contaminanti (ad esempio insetti).

Previene l'invecchiamento delle superfici, è performante come rifinitura dopo ogni lavaggio ed impedisce

l'aggrapparsi di sporco e agenti atmosferici sulle parti trattate.

Ridona piena lucentezza, lasciando la carrozzeria setosa al tatto.

Non macchia le parti in plastica e gomma, non contiene solventi e abrasivi.

Modalità d'uso:

- Dopo il lavaggio, nebulizzare in modo uniforme sulle parti verniciate e trasparenti.
- Stendere il prodotto con il panno pulito F-CLEAN, senza asciugare completamente.
- Attendere un minuto e rifinire con il panno F-CLEAN asciutto.



◀ **cod. XPP12**
LINFA BIO MOTO WASH trigger
750 ml

- Shampoo concentrato per sporco aderente, con risciacquo
- Rapido e potente, senza solventi petroliferi
- Ideale per la pulizia di moto con cerchi a raggi
- Biodegradabile
- Elimina fango, olio, morchia e grasso
- Concentrato e con risciacquo per la pulizia della trasmissione o-ring e motore

Biodegradabile con additivi, detersivi e sgrassanti specifici per la pulizia delle moto fuoristrada, stradali e da turismo. Può essere utilizzato sia concentrato che diluito per donare protezione e brillantezza a tutte le superfici della moto ed eliminare fango, olio, unto, morchia e grasso. Ideale per pulire componentistica pregiata come carbonio, alluminio, titanio, parti anodizzate e delicate, non compromette l'azione di freno e sospensioni. LINFA BIO MOTO WASH deterge non solo le superfici verniciate ma anche le parti meccaniche, compresa la trasmissione. Non intacca guarnizioni, plastiche, parti in gomma, o-ring, pneumatici e manicotti motore.

Non corrode, non graffia e non macchia.

Pulizia della trasmissione:

- Attendere il raffreddamento del motore.
- Applicare LINFA BIO MOTO WASH concentrato, aiutandosi con pennello o spazzola.
- Sciacquare, asciugare e lubrificare con OXZT CHAIN LUBE.

Pulizia con risciacquo:

- Attendere il raffreddamento del motore, rimuovere con getto d'acqua polvere, fango, sabbia o sporco pesante. Diluire LINFA BIO MOTO WASH fino a 1:10 in un secchio d'acqua a seconda del grado di sporco e procedere con la pulizia aiutandosi con una spugna. Sciacquare con acqua e asciugare.
- Oppure, bagnare con acqua le superfici, spruzzare in modo omogeneo LINFA BIO MOTO WASH concentrato, attendere 2 minuti e rimuovere con getto d'acqua. Se necessario, aggiungere prodotto e aiutarsi con pennello o spugna. Risciacquare con acqua e asciugare.



◀ cod. XPP10

LIFE4X

200 ml

- Crema protettiva per superfici in pelle
- Ristruttura da secchezza e invecchiamento
- Nutre in profondità.

Crema nutriente microtecnologica che rende la pelle morbida e protetta subito senza ungere. Dalla tuta di pelle racing alla giacca, dagli stivali ai guanti, dona protezione waterproof, migliora l'intensità del colore, esalta la finitura naturale e la sensazione al tatto.

Non usare su pelle scamosciata oppure nabuk.

Modalità d'uso:

- Detergere a fondo con ACTIVE FOAM.
- Applicare 0,5 ml di QUESTIONE DI PELLE sul panno F-CLEAN e distribuire uniformemente.
- Attendere l'assorbimento del prodotto all'interno delle superfici trattate.



◀ cod. XPP30

BUBBLE WASH – TRIGGER

750 ml

- Shampoo concentrato vernici lucide e opache
- Necessita risciacquo
- Formulazione con additivi per la pulizia e protezione di parti delicate e cromate
- Compatibile con la trasmissione a cinghia
- Biodegradabile

Shampoo biodegradabile utilizzabile sia concentrato che diluito, elevato potere pulente. Performante su parti opache, lucide, cromate, diamantate, condizioni miste come cerchi a raggi e moto con componentistica pregiata. Elimina olio, grasso, unto, sporco stradale, non contiene solventi petroliferi, non intacca guarnizioni, cinghie,

plastiche, gomma, pneumatici.

Modalità d'uso:

- Attendere il raffreddamento del motore.
- Diluire BUBBLE WASH fino a 1:10 in un secchio d'acqua a seconda del grado di sporco, procedere con la pulizia delle superfici aiutandosi con una spugna, sciacquare con acqua e passare all'asciugatura.
- In alternativa, bagnare con acqua le parti da pulire, spruzzare BUBBLE WASH concentrato in modo omogeneo, attendere 2 minuti e rimuovere con getto d'acqua. Se necessario, aggiungere prodotto e aiutarsi con pennello o spugna. Risciacquare con acqua e asciugare.



◀ cod. XPP31

DEFENCE

300 ml

- Protettivo naturale per vernice opaca
- Impedisce l'aggrapparsi di sporco e insetti
- Barriera antimacchia
- Protegge la vernice opaca dallo sfregamento

DEFENCE ha elevate proprietà protettive di superfici opache, non stratifica con l'uso e la sua barriera antimacchia mantiene inalterata la finitura, difendendola

dallo sfregamento, dalla penetrazione di sporco, macchie, aloni, insetti e dagli agenti atmosferici.

Modalità d'uso:

- Dopo il lavaggio, nebulizzare in modo uniforme sulle parti opache.
- Stendere con il panno pulito F-CLEAN EVO fino alla completa asciugatura.



◀ cod. XPP32

BUBBLE FIZZ

400 ml

- Schiumogeno detergente
- Per verniciature opaca e lucida
- Parti pregiate anodizzate e cromate
- Elimina lo sporco, incrostazioni, olio, moscerini, aloni
- Non contiene siliconi, oli, cera.
- Senza acqua e senza risciacquo

Priva di silicone, cere, polimeri e solventi, BUBBLE FIZZ pulisce in profondità tutte le parti anodizzate e cromate, le verniciature opache e lucide di moto e casco.

BUBBLE FIZZ è una soluzione schiumogena che si deposita sulle superfici e agisce visibilmente sulle parti sollevando lo sporco che può essere immediatamente asportato dal

panno F-CLEAN EVO, senza abrasioni e sfregamenti.

Modalità d'uso:

- Attendere il raffreddamento del motore e dello scarico.
- Agitare prima dell'uso.
- Per sporchi pesanti, distribuire BUBBLE FIZZ sulla parte, quando la schiuma inizia a dissolversi, rimuovere con il panno F-CLEAN EVO.
- Per sporchi medi, spruzzare BUBBLE FIZZ su un panno morbido F-CLEAN EVO e rimuovere lo sporco.
- Procedi a piccole zone, evitando così che il prodotto si dissolva prima di aver completato la rifinitura con il panno.



◀ **cod. XPP21**
DRYPLUS 5 CHAIN SMART

400 ml

- Lubrificante sintetico con azione detergente e protettiva
- Elimina i rumori
- Mantiene a lungo il corretto accoppiamento della trasmissione

Lubrificante con additivi idroespellenti ultima generazione che mantiene a lungo il corretto accoppiamento della trasmissione, aumenta la scorrevolezza, elimina i rumori, proteggendo le superfici dalla corrosione degli agenti

atmosferici e del sale. Contiene additivi detergenti che agevolano anche la pulizia e la lubrificazione di leveraggi, leva freno, guaine e cavi.

Modalità d'uso:

- Per ripristinare la lubrificazione, applicare DRYPLUS5 su pacco pignoni, catena, cambio deragliatore.
- Non utilizzare su piste freno, dischi freno, pattini, pastiglie freno.



◀ **cod. XPP22**
RESET PRO

500 ml

- Pulitore e sgrassatore per meccanismi di precisione
- Manutenzione impianto frenante
- Senza acqua e senza risciacquo

Sgrassa a fondo i componenti di precisione, cambio, deragliatore, pignoni, corone, catena, dischi e pastiglie freno, pattini, pista frenante (sia in carbonio, che in alluminio).

L'erogazione ad alta pressione toglie istantaneamente grasso, sporcizia e residui di sporco, agevolando tutte le

operazioni di revisione del meccanismo centrale, mozzi, forcelle, impianto frenante idraulico e tutte le parti che necessitano di una pulizia altamente performante. Rimuove macchie di catrame dalle parti delicate e verniciate, è compatibile con parti in gomma e plastica.

Modalità d'uso:

- Dirigere il getto sulla parte da pulire e vaporizzare per qualche secondo.
- Pulire aiutandosi con il panno F-CLEAN EVO



◀ **cod. XPP23**
FILM FRAME

400 ml

- Barriera protettiva ad effetto brillante
- Per telai in carbonio, titanio, alluminio e acciaio
- Protegge dalla corrosione

Crea un film protettivo lucido che mantiene a lungo brillantezza, elimina la penetrazione delle macchie e agevola la pulizia del telaio. Particolarmente indicato per le bici fuoristrada, FILM FRAME impedisce al fango di aderire, assicurando notevoli benefici in termini di peso. Protegge le superfici prevenendo la penetrazione di sporco stradale, macchie di fango, smog, catrame, corrosione, sale e umidità.

Modalità d'uso:

- Pulire il telaio con MTB PERFECT WASH 750 oppure con E-FOAM
- Applicare direttamente sul telaio.
- Stendere con un panno F-CLEAN e rimuovere il prodotto in eccesso.
- Non utilizzare FILM FRAME su dischi, pastiglie freno, pattini, pista frenante, in caso di contatto pulire con RESET PRO oppure con E-FOAM



◀ cod. XPP24

E-FOAM

400 ml

- Schiumogeno per parti pregiate lucide e opache
- Elimina le incrostazioni, rimuove le macchie di fango
- Sgrassa da olio e aloni non penetra fra gli accoppiamenti.
- Senza acqua e senza risciacquo

Priva di solventi, E-FOAM è la schiuma attiva per il lavaggio senza acqua e senza risciacquo di tutta la bici. Non penetra fra gli accoppiamenti dilavando il lubrificante e deterge senza rovinare guaine, forcelle, pneumatici, parti in gomma, grafiche, adesivi, parti cromate e anodizzate, pedali, sella, manubrio e ruote.

La sua innovativa formulazione non lascia residui oleosi

ed è il detergente ideale per superfici pregiate come telai in carbonio, alluminio e titanio, con verniciatura lucida oppure opaca.

Modalità d'uso:

- Agitare E-FOAM prima dell'uso.
- Spruzzare direttamente su piccole superfici, attendere che il prodotto agisca e quando la schiuma inizia a dissolversi, pulire con il panno F-CLEAN EVO.
- Procedi a piccole zone, per evitare che il prodotto si dissolva prima di aver completato la rifinitura con il panno.



◀ cod. XPP25

MTB X-WASH trigger

750 ml

- Shampoo concentrato sporco aderente finiture lucide e opache
- Necessita risciacquo
- Rapido e potente, senza solventi petroliferi
- Biodegradabile
- Elimina fango, olio, morchie e grasso
- Concentrato e con risciacquo per la pulizia della trasmissione

Shampoo biodegradabile con formulazione selettiva specifico per il lavaggio con acqua e risciacquo.

Si utilizza sia concentrato che diluito per la pulizia e la protezione di carbonio, anodizzazioni, titanio, alluminio, verniciature opache e lucide, senza rovinare pneumatici, parti in gomma, sospensioni.

Elimina fango, olio, grasso, unto, sporco, morchia.

Non compromette l'azione del freno.

Non contiene solventi petroliferi.

Pulizia del gruppo trasmissione:

- Rimuovere polvere, fango, sabbia e sporco pesante con getto d'acqua.
- Applicare MTB PERFECT WASH concentrato sul gruppo trasmissione e attendere 3 minuti.
- Sciacquare con un getto d'acqua diretto sulle superfici, asciugare e lubrificare con DRYPLUS5

Pulizia con risciacquo:

- Rimuovere polvere, fango, sabbia e sporco pesante con getto d'acqua, diluire MTB PERFECT WASH 1:5 in un secchio d'acqua, a seconda del grado di sporco e procedere alla pulizia delle superfici aiutandosi con una spugna. Sciacquare con acqua e asciugare.
- In alternativa, bagnare con acqua le parti da pulire, spruzzare MTB PERFECT WASH concentrato in modo omogeneo e sulla trasmissione, attendere 3 minuti e rimuovere con getto d'acqua. Se necessario, aggiungere prodotto e aiutarsi con spazzola o spugna. Risciacquare e asciugare.



◀ Prodotto disponibile a richiesta

La quantità dei prodotti esposti dipende dalla selezione

altezza 1730 mm

larghezza 480 mm

profondità 350 mm



microcar



◀ cod. **SAM0001**
Coppia ammortizzatori anteriori

APPLICABILITÀ

AIXAM 300 276 96-04, 400 400 96-04, 500,4 400 97-05, A721 400 05-08, A741 400 05-08

RIFERIMENTO ORIGINALE

Aixam	4K009
-------	-------



◀ cod. **SAM0002**
Coppia ammortizzatori posteriori

APPLICABILITÀ

AIXAM 400 400 96-04

RIFERIMENTO ORIGINALE

Aixam	5K003
-------	-------



◀ cod. **SAM0003**
Coppia ammortizzatori anteriori

APPLICABILITÀ

LIGIER NOVA 505 99-04, X-T00 505 02-05

RIFERIMENTO ORIGINALE

Ligier	0200072
--------	---------

Ligier	120.0.070
--------	-----------



◀ cod. **SAM0004**
Coppia ammortizzatori anteriori

APPLICABILITÀ

CHATENET BAROODER 505 08-19

RIFERIMENTO ORIGINALE

Chatenet	10.18.015
----------	-----------



◀ cod. **SAM0005**
Coppia ammortizzatori anteriori

APPLICABILITÀ

CHATENET MEDIA 505 98-01

RIFERIMENTO ORIGINALE

Chatenet	107325
----------	--------



◀ cod. **SAM0006**
Coppia ammortizzatori anteriori

APPLICABILITÀ

JDM ABACA MOUNTAIN 523 07-10

RIFERIMENTO ORIGINALE

JDM	603101
-----	--------



◀ cod. **SAM0007**
Coppia ammortizzatori anteriori

APPLICABILITÀ

JDM ABACA 505 05-19

RIFERIMENTO ORIGINALE

JDM	813101
-----	--------



◀ cod. **SAM0008**
Coppia ammortizzatori anteriori

APPLICABILITÀ

CASALINI YDEA 500 00-00

RIFERIMENTO ORIGINALE

Casalini	F2107000027
----------	-------------



◀ cod. **SAM0009**
Coppia ammortizzatori posteriori

APPLICABILITÀ

CASALINI YDEA 500 00-00

RIFERIMENTO ORIGINALE

Casalini	F2107000025
----------	-------------



◀ cod. **SAM0010**
Coppia ammortizzatori anteriori

APPLICABILITÀ

JDM TITANE 523 99-02

RIFERIMENTO ORIGINALE

JDM	901002
-----	--------



◀ cod. **SAM0011**
Coppia ammortizzatori anteriori

APPLICABILITÀ

GREKAV EKE 505 00-10

RIFERIMENTO ORIGINALE

GrecaV	BAF080007837
--------	--------------



◀ cod. **SAM0012**
Coppia ammortizzatori posteriori

APPLICABILITÀ

LIGIER NOVA 505 99-04

RIFERIMENTO ORIGINALE

Ligier	0200063
--------	---------



◀ cod. **SAM0013**
Coppia ammortizzatori anteriori

APPLICABILITÀ

LIGIER X-T00 R 505 00-19

RIFERIMENTO ORIGINALE

Ligier	0200078
--------	---------



◀ cod. **SAM0014**
Coppia ammortizzatori posteriori

APPLICABILITÀ

LIGIER X-T00 MAX 505 02-05, X-T00 R 505 00-19

RIFERIMENTO ORIGINALE

Ligier	0200076
--------	---------



◀ cod. **SAM0015**
Coppia ammortizzatori anteriori

APPLICABILITÀ

LIGIER JS 50 F1 505 09-12

RIFERIMENTO ORIGINALE

Ligier	1403276
--------	---------



◀ cod. **SAM0016**
Coppia ammortizzatori posteriori

APPLICABILITÀ

LIGIER JS 50 F1 505 09-12

RIFERIMENTO ORIGINALE

Ligier	1403277
--------	---------



◀ cod. **SAM0017**
Coppia ammortizzatori anteriori

APPLICABILITÀ

MICROCAR VIRGO II 505 02-04

RIFERIMENTO ORIGINALE

Microcar	0660145
----------	---------



◀ cod. **SAM0018**
Coppia ammortizzatori posteriori

APPLICABILITÀ

MICROCAR VIRGO II 505 02-04

RIFERIMENTO ORIGINALE

Microcar	0660154
----------	---------



◀ cod. **SAM0019**
Coppia ammortizzatori anteriori

APPLICABILITÀ

ITALCAR T2 505 06-07, T3 505 06-07, DOMINO 06-07

RIFERIMENTO ORIGINALE

Italcar	MY019
---------	-------



◀ cod. **SAM0020**
Coppia ammortizzatori anteriori

APPLICABILITÀ

CHATENET CH26 505 10-19

RIFERIMENTO ORIGINALE

Chatenet	01.26.167
----------	-----------



◀ cod. **SAM0021**
Coppia ammortizzatori anteriori

APPLICABILITÀ

LIGIER JS 50 C 505 00-05

RIFERIMENTO ORIGINALE

Ligier	1403276
--------	---------



◀ cod. **SAM0022**
Coppia ammortizzatori anteriori

APPLICABILITÀ

MICROCAR DUÈ 505 14-14

RIFERIMENTO ORIGINALE

Microcar	1404984
----------	---------



◀ cod. **SAM0023**
Coppia ammortizzatori posteriori

APPLICABILITÀ

MICROCAR DUÈ 505 14-14

RIFERIMENTO ORIGINALE

Microcar	1405146
----------	---------



◀ cod. **SAM0024**
Coppia ammortizzatori anteriori

APPLICABILITÀ

AIXAM CITY ELETTRICA 10-12

RIFERIMENTO ORIGINALE

Aixam	4AT009
-------	--------



◀ cod. **SAM0025**
Coppia ammortizzatori posteriori

APPLICABILITÀ

AIXAM CITY ELETTRICA 10-12

RIFERIMENTO ORIGINALE

Aixam	5K003A
-------	--------



◀ cod. **SAM0026**
Coppia ammortizzatori anteriori

APPLICABILITÀ

LIGIER X-TOO MAX 505 02-05

RIFERIMENTO ORIGINALE

Ligier	0200072
--------	---------



◀ cod. **SAM0027**
Coppia ammortizzatori anteriori

APPLICABILITÀ

AIXAM D-TRUCK 478 12-19

RIFERIMENTO ORIGINALE

Aixam	4L009
-------	-------



◀ cod. **SAM0028**
Coppia ammortizzatori posteriori

APPLICABILITÀ

AIXAM D-TRUCK 478 12-19

RIFERIMENTO ORIGINALE

Aixam	5MB003
-------	--------



◀ cod. **SAM0029**
Coppia ammortizzatori anteriori

APPLICABILITÀ

AIXAM MULTI TRUCK 478 12-19

RIFERIMENTO ORIGINALE

Aixam	4L009
-------	-------



◀ cod. **SAM0030**
Coppia ammortizzatori posteriori

APPLICABILITÀ

AIXAM MULTI TRUCK 478 12-19

RIFERIMENTO ORIGINALE

Aixam	5MB003
-------	--------



◀ cod. **SAM0032**
Coppia ammortizzatori anteriori

APPLICABILITÀ

LIGIER S 20 505 10-10

RIFERIMENTO ORIGINALE

Ligier	0200071
--------	---------



◀ cod. **SAM0035**
Coppia ammortizzatori posteriori

APPLICABILITÀ

CHATENET BAROODER 505 08-19

RIFERIMENTO ORIGINALE

Chatenet	01.18.014
----------	-----------



◀ cod. **SAM0038**
Coppia ammortizzatori posteriori

APPLICABILITÀ

CHATENET CH26 505 10-19

RIFERIMENTO ORIGINALE

Chatenet	01.26.168
----------	-----------



◀ cod. **SAM0039**
Coppia ammortizzatori posteriori

APPLICABILITÀ

CHATENET CH26 MEDIA 505 10-10

RIFERIMENTO ORIGINALE

Chatenet	01.16.005
----------	-----------



◀ cod. **SAM0040**
Coppia ammortizzatori posteriori

APPLICABILITÀ

CHATENET CH26 I 505 10-10

RIFERIMENTO ORIGINALE

Chatenet	01.38.018
----------	-----------

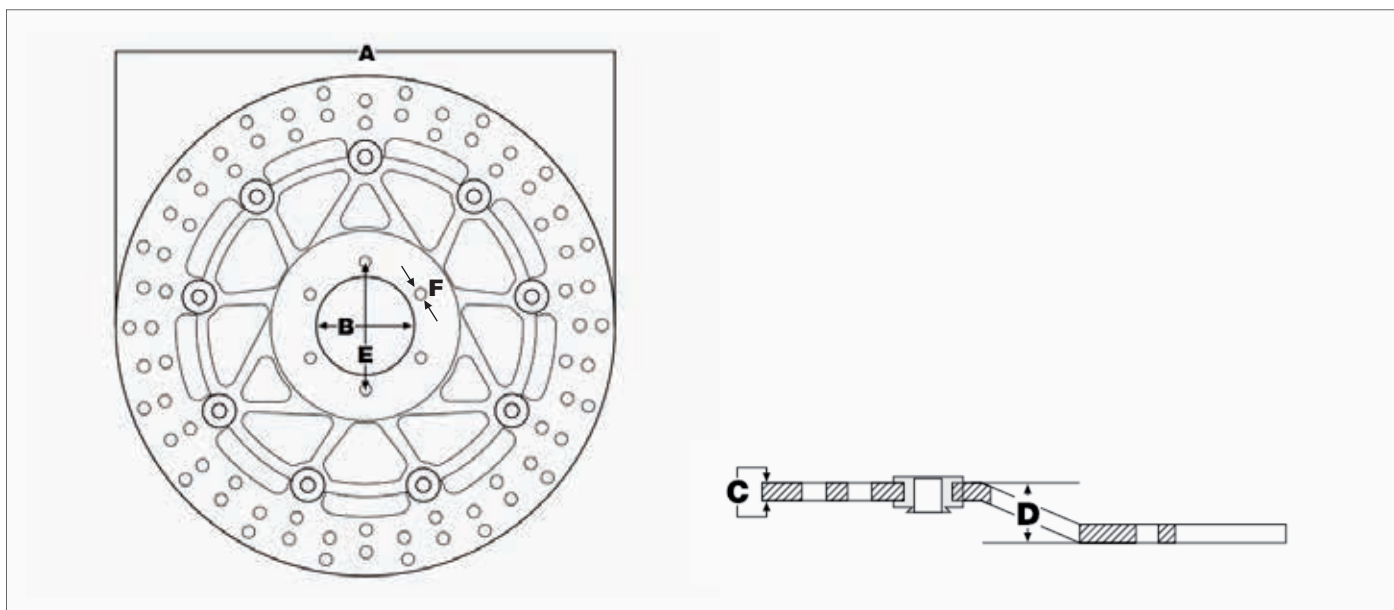

DISCHI FRENO POSTERIORI

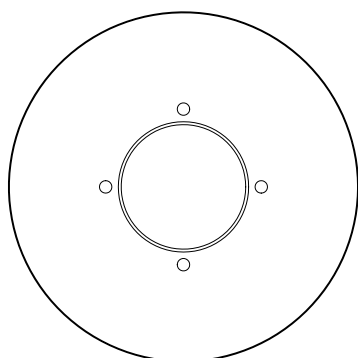

◀ cod. **BDM0004**

Disco freno posteriore

APPLICABILITÀ

LIGIER IXO 505 11-19, JS 36 505 14-19, JS 40 505 11-19, JS RC 505 08-19, OPTIMAX 505 00-19

MICROCAR M8 480 16-19, M8 500 16-19, CARGO 505 07-19, DUÈ F1RST 505 11-19, F8 505 11-19, MGO 2 505 08-13

MISURE

A	180	B	64	C	5	E	80	F	6,4
----------	-----	----------	----	----------	---	----------	----	----------	-----

RIFERIMENTO ORIGINALE

Ligier	1412733
Microcar	1412733

Ligier	1412722
Microcar	1412722

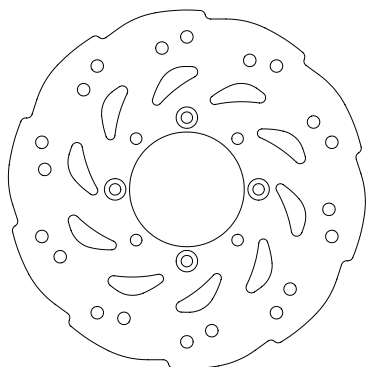

◀ cod. **BDM0006**

Disco freno posteriore

APPLICABILITÀ

CHATENET CH26 505 10-19, CH26 EVO 505 16-19

JDM ROXSY 440 08-19, XHEOS 442 08-19, ROXSY 523 08-19

MISURE

A	220	B	64	C	4	E	80	F	6,4
----------	-----	----------	----	----------	---	----------	----	----------	-----

RIFERIMENTO ORIGINALE

Chatenet	01.17.427
----------	-----------

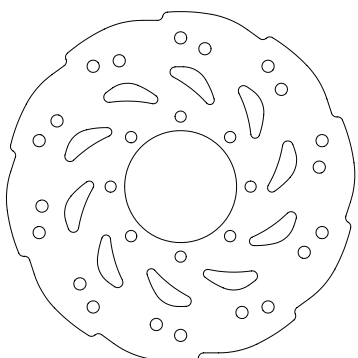

◀ cod. **BDM0007**

Disco freno posteriore

APPLICABILITÀ

CHATENET CH26 505 10-19, CH26 EVO 505 16-19

JDM ROXSY 440 08-19, XHEOS 442 08-19, ROXSY 523 08-19

MISURE

A	200	B	64	C	4	E	80	F	6,4
----------	-----	----------	----	----------	---	----------	----	----------	-----

RIFERIMENTO ORIGINALE

Chatenet	01.17.452
----------	-----------

DISCHI FRENO ANTERIORI

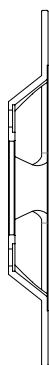
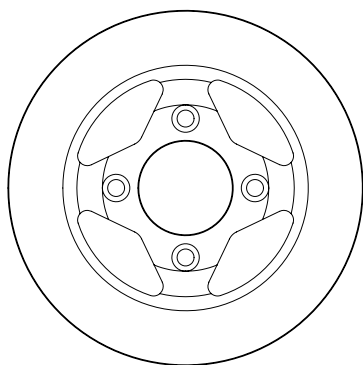

◀ cod. **BDM0001**

Disco freno anteriore

APPLICABILITÀ

LIGIER IXO 505 11-19, JS 36 505 14-19, JS 40 505 11-19, JS RC 505 08-19, OPTIMAX 505 00-19

MICROCAR M8 480 16-19, M8 500 16-19, CARGO 505 07-19, DUÈ F1RST 505 11-19, F8 505 11-19, MGO 2 505 08-13

MISURE

A	220	B	58	C	4	D	24,5	E	86	F	10,5
----------	-----	----------	----	----------	---	----------	------	----------	----	----------	------

RIFERIMENTO ORIGINALE

Ligier	1008471	Microcar	1008471
--------	---------	----------	---------

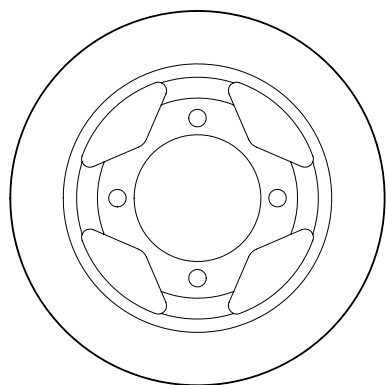

◀ cod. **BDM0005**

Disco freno anteriore

APPLICABILITÀ

CHATENET CH26 505 10-19, CH26 EVO 505 16-19

JDM ROXSY 440 08-19, XHEOS 442 08-19, ROXSY 523 08-19

MISURE

A	225	B	76	C	6	D	18,5	E	96	F	10,5
----------	-----	----------	----	----------	---	----------	------	----------	----	----------	------

RIFERIMENTO ORIGINALE

Chatenet	01.17.367
----------	-----------

DISCHI FRENO POSTERIORI VENTILATI

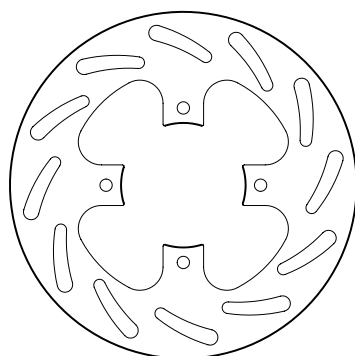

◀ cod. **BDM0002**

Disco freno posteriore ventilato

APPLICABILITÀ

LIGIER IXO 505 11-19, JS 36 505 14-19, JS 40 505 11-19, JS RC 505 08-19, OPTIMAX 505 00-19

MICROCAR M8 480 16-19, M8 500 16-19, CARGO 505 07-19, DUÈ F1RST 505 11-19, F8 505 11-19, MGO 2 505 08-13

MISURE

A	180	B	64	C	4	E	80	F	6,4
----------	-----	----------	----	----------	---	----------	----	----------	-----

RIFERIMENTO ORIGINALE

Ligier	1400353	Microcar	1400353
--------	---------	----------	---------

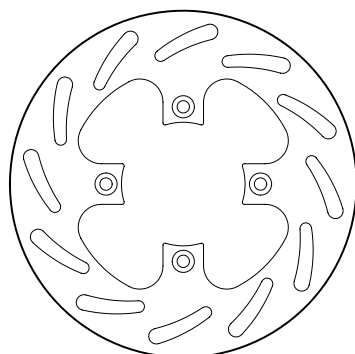

◀ cod. **BDM0003**

Disco freno posteriore ventilato

APPLICABILITÀ

LIGIER IXO 505 11-19, JS 36 505 14-19, JS 40 505 11-19, JS RC 505 08-19, OPTIMAX 505 00-19

MICROCAR M8 480 16-19, M8 500 16-19, CARGO 505 07-19, DUÈ F1RST 505 11-19, F8 505 11-19, MGO 2 505 08-13

MISURE

A	180	B	64	C	4	E	80	F	6,4
----------	-----	----------	----	----------	---	----------	----	----------	-----

RIFERIMENTO ORIGINALE

Ligier	1400352	Microcar	1400352
--------	---------	----------	---------

MICROCAR KIT GIUNTI

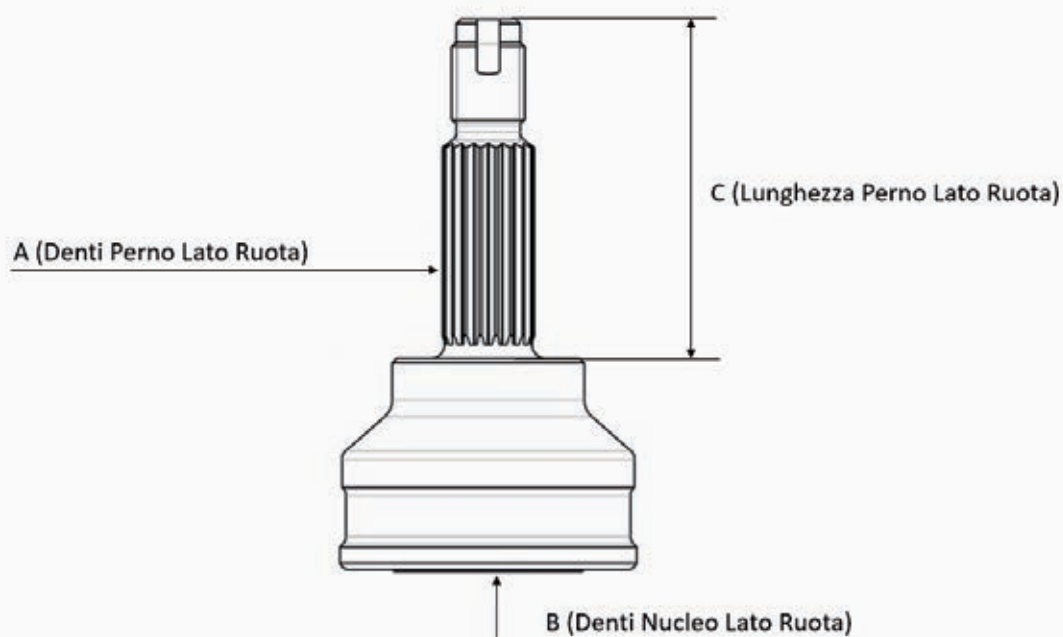

CODICE	APPLICABILITÀ	A (Denti Perno Lato Ruota)	B (Denti Nucleo Lato Cambio)	C (Lunghezza Per- no Lato Ruota)	ABS (Ruota Fonica Z.)
HJM1005K	MICROCAR MGO 1 505 13-15, MGO 2 505 13-15, MGO 3 505 15-19	18	18	74	-
HJM1014K	BELLIER B8 440 15-19, DOCKER 480 16-19, B8 523 15-19, JADE 523 16-19	18	18	80,5	-
	CASALINI M20 480 17-19, KERRY 538 15-19, M14 538 08-14, KERRY 635 15-19, M12 PICKUP 635 15-19				
	CHATENET BAROODER 505 08-19, CH26 EVO 505 16-19, CJF 214 505 95-01, MEDIA 505 98-01, STELLA 505 00-04				
	JDM ROXSY 440 08-19, SIMPA 440 02-19, XHEOS 442 08-19, ABACA 505 05-19, ALBIZIA 505 02-07, ABACA 523 05-19, ALBIZIA 523 02-07, ALOES 523 08-19, ROXSY 523 08-19, TITANE 1/2/3 523 99-02				
	LIGIER JS RC 505 08-19, OPTIMAX 505 00-19, PRIMA 505 00-19, X-TOO 505 02-19, X-TOO MAX 505 02-05, X-TOO R 505 00-19				
MICROCAR MGO 4 498 16-19, CARGO 505 07-19, MGO 1 505 08-13, MGO 2 505 08-13, MGO 3 505 15-19, MGO 4 505 16-19					
HJM1015K	AIXAM 300 276 99-05, 400 400 99-05, 500 400 99-05, 500,4 400 99-05, A721 400 05-08, A741 400 05-08, EVOLUTION 400 400 02-19, A751 500 05-08	18	18	74	-
	LIGIER IXO 505 11-19, JS 36 505 14-19, JS 40 505 11-19, JS 48 (P70) 505 09-19, JS 50 F1 505 09-12, JS 50 F2/F3 505 12-19, JS 50 F4 505 19-19, JS 48 ELETTRICA 11-19, JS58 ELETTRICA 15-19				
	MICROCAR MC1 505 03-07, MC2 505 03-07, MC1 523 03-07				
HJM1017K	CASALINI M14 ABS 635 14-19	18	18	80,5	45
HJM1018K	AIXAM CITY ABS 400 10-12, CROSSLINE ABS 400 10-19, GTO ABS 400 10-19, CITY ABS 500 12-19, CROSSLINE ABS 500 10-19	18	18	69	42
HJM1019K	AIXAM CITY 400 10-12, CROSSLINE 400 10-19, GTO 400 10-19, CITY 500 12-19, COUPÈ 500 12-19, CROSSLINE 500 10-19	18	18	69	-
HJM1020K	CHATENET CH26 EVO 505 16-19	18	18	80,5	-

PASTIGLIE FRENO ANTERIORI

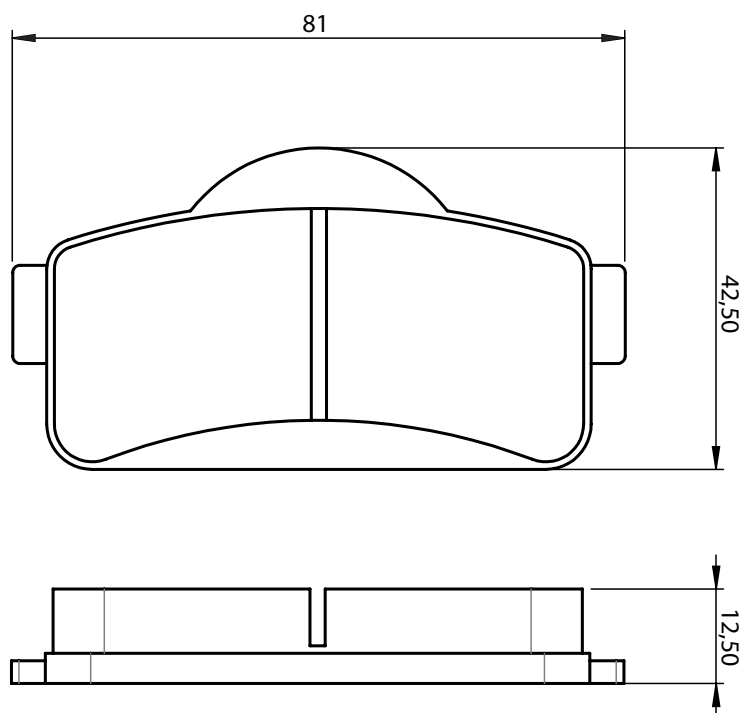

◀ cod. **BPM0001**
Pastiglie freno anteriori

APPLICABILITÀ

LIGIER IXO 505 11-19, JS 36 505 14-19, JS 40 505 11-19, JS RC 505 08-19, OPTIMAX 505 00-19

MICROCAR M8 480 16-19, M8 500 16-19, CARGO 505 07-19, DUË F1RST 505 11-19, F8 505 11-19, MGO 2 505 08-13

RIFERIMENTO ORIGINALE

Ligier	1008464
Microcar	1008464

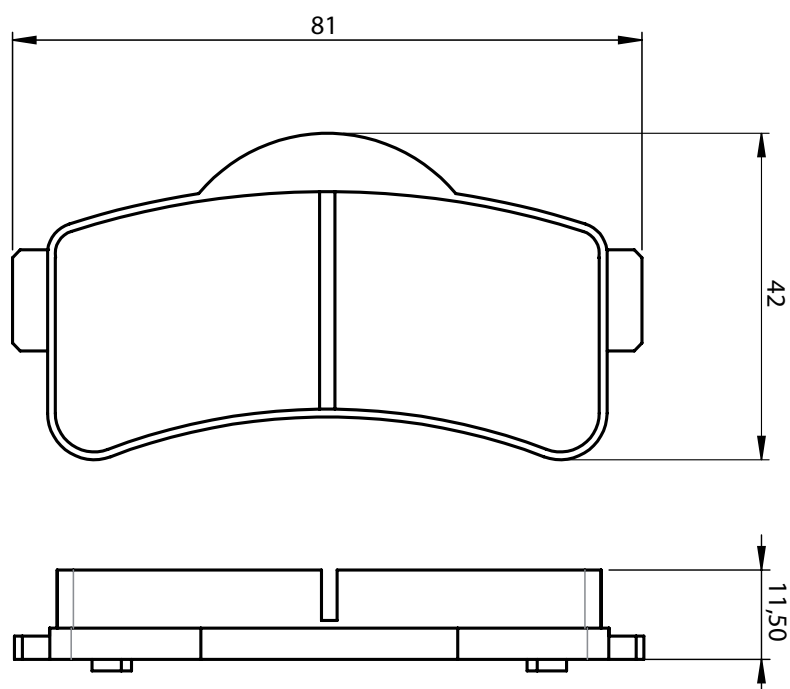

◀ cod. **BPM0003**
Pastiglie freno anteriori

APPLICABILITÀ

CHATENET CH26 505 10-19, CH26 EVO 505 16-19

JDM ROXSY 440 08-19, XHEOS 442 08-19, ROXSY 523 08-19

RIFERIMENTO ORIGINALE

Chatenet	01.17.376
Chatenet	01.17.377

PASTIGLIE FRENO POSTERIORI

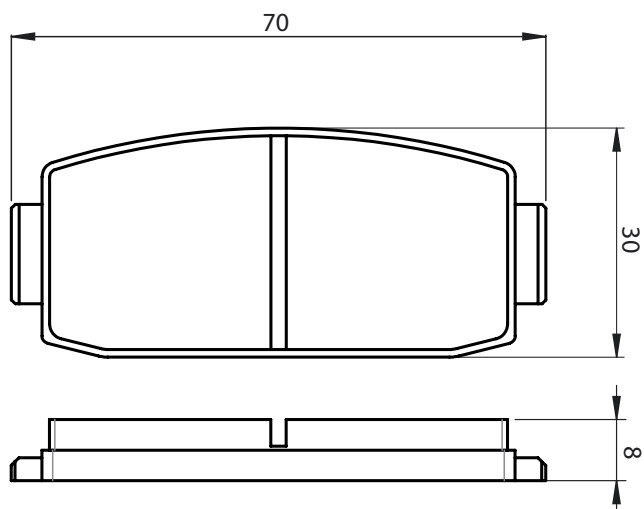

◀ cod. **BPM0002**
Pastiglie freno posteriori

APPLICABILITÀ

LIGIER IXO 505 11-19, JS 36 505 14-19, JS 40 505 11-19, JS RC 505 08-19, OPTIMAX 505 00-19

MICROCAR M8 480 16-19, M8 500 16-19, CARGO 505 07-19, DUÈ F1RST 505 11-19, F8 505 11-19, MGO 2 505 08-13

RIFERIMENTO ORIGINALE

Ligier	1008465
Microcar	1008465

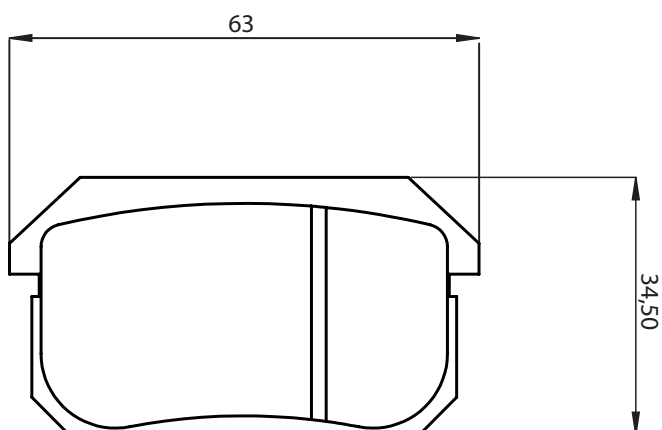

◀ cod. **BPM0004**
Pastiglie freno posteriori

APPLICABILITÀ

CHATENET CH26 505 10-19, CH26 EVO 505 16-19

JDM ROXSY 440 08-19, XHEOS 442 08-19, ROXSY 523 08-19

RIFERIMENTO ORIGINALE

Chatenet	01.17.390
Chatenet	01.17.391
Chatenet	01.17.392

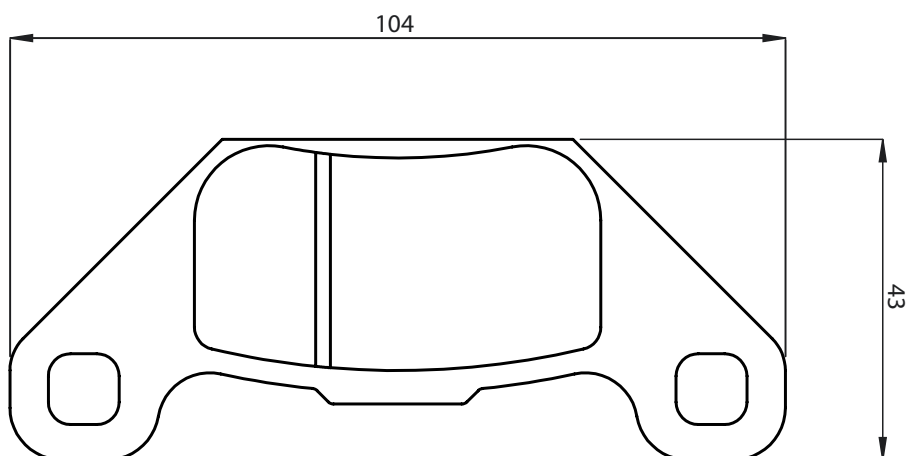

PINZE FRENO ANTERIORI

◀ cod. **BCM6001**
Pinze freno anteriori

APPLICABILITÀ

LIGIER IXO 505 11-19, JS 36 505 14-19, JS 40 505 11-19, JS RC 505 08-19, OPTIMAX 505 00-19

MICROCAR M8 480 16-19, M8 500 16-19, CARGO 505 07-19, DUÈ FIRST 505 11-19, F8 505 11-19, MGO 2 505 08-13

RIFERIMENTO ORIGINALE

Ligier	1008512
Microcar	1008512

◀ cod. **BCM6002**
Pinze freno anteriori

APPLICABILITÀ

LIGIER IXO 505 11-19, JS 36 505 14-19, JS 40 505 11-19, JS RC 505 08-19, OPTIMAX 505 00-19

MICROCAR M8 480 16-19, M8 500 16-19, CARGO 505 07-19, DUÈ FIRST 505 11-19, F8 505 11-19, MGO 2 505 08-13

RIFERIMENTO ORIGINALE

Ligier	1008469
Microcar	1008469

◀ cod. **BCM6009**
Pinze freno anteriori

APPLICABILITÀ

CHATENET CH26 505 10-19, CH26 EVO 505 16-19

JDM ROXSY 440 08-19, XHEOS 442 08-19, ROXSY 523 08-19

RIFERIMENTO ORIGINALE

Chatenet	01.17.449
Chatenet	01.17.318
Chatenet	0203034

◀ cod. **BCM6010**
Pinze freno anteriori

APPLICABILITÀ

CHATENET CH26 505 10-19, CH26 EVO 505 16-19

JDM ROXSY 440 08-19, XHEOS 442 08-19, ROXSY 523 08-19

RIFERIMENTO ORIGINALE

Chatenet	01.17.448
Chatenet	01.17.317

PINZE FRENO POSTERIORI

◀ cod. **BCM6003**
Pinze freno posteriori

APPLICABILITÀ

LIGIER IXO 505 11-19, JS 36 505 14-19, JS 40 505 11-19, JS RC 505 08-19, OPTIMAX 505 00-19

MICROCAR M8 480 16-19, M8 500 16-19, CARGO 505 07-19, DUÈ FIRST 505 11-19, F8 505 11-19, MGO 2 505 08-13

RIFERIMENTO ORIGINALE

Microcar	1009188
Ligier	1403881

◀ cod. **BCM6004**
Pinze freno posteriori

APPLICABILITÀ

LIGIER IXO 505 11-19, JS 36 505 14-19, JS 40 505 11-19, JS RC 505 08-19, OPTIMAX 505 00-19

MICROCAR M8 480 16-19, M8 500 16-19, CARGO 505 07-19, DUÈ FIRST 505 11-19, F8 505 11-19, MGO 2 505 08-13

RIFERIMENTO ORIGINALE

Microcar	1009189
Ligier	1403880
Ligier	1408751

◀ cod. **BCM6011**
Pinze freno posteriori

APPLICABILITÀ

CHATENET CH26 505 10-19, CH26 EVO 505 16-19

JDM ROXSY 440 08-19, XHEOS 442 08-19, ROXSY 523 08-19

RIFERIMENTO ORIGINALE

Chatenet	01.17.451
----------	-----------

◀ cod. **BCM6012**
Pinze freno posteriori

APPLICABILITÀ

CHATENET CH26 505 10-19, CH26 EVO 505 16-19

JDM ROXSY 440 08-19, XHEOS 442 08-19, ROXSY 523 08-19

RIFERIMENTO ORIGINALE

Chatenet	01.17.450
----------	-----------

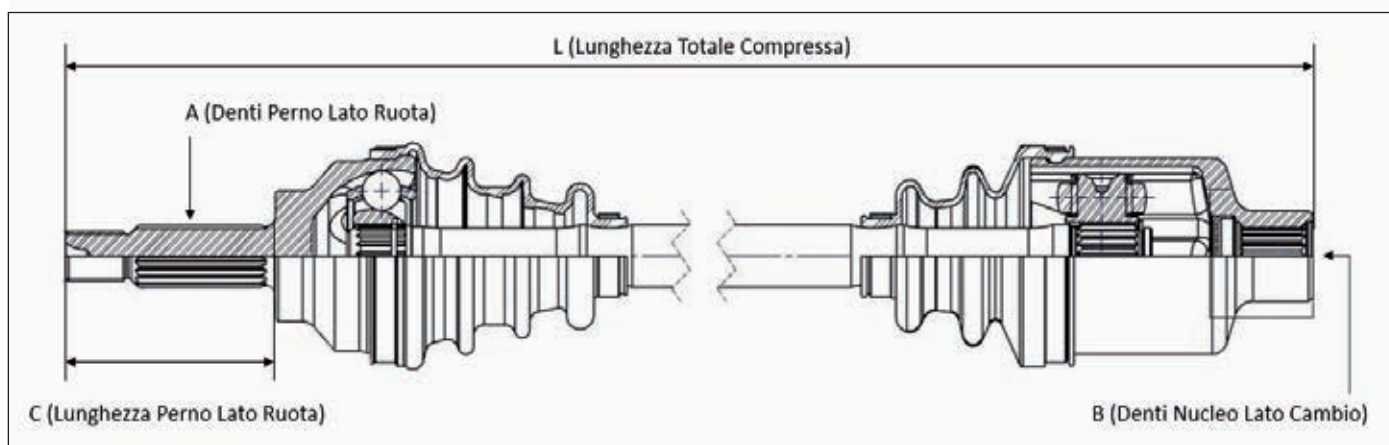

CODICE	MARCA	APPLICABILITÀ	RIFERIMENTO ORIGINALE	A (Denti Perno Lato Ruota)	B (Denti Nucleo Lato Cambio)	C (Lunghezza Perno Lato Ruota)	L (Lunghezza Compresa)	ABS (Ruota Fonica Z.)
DSM03002	BELLIER	B8 440 16-17, B8 523 16-17		18	18	80,5	511,5	-
DSM03003	BELLIER	B8 440 16-17, B8 523 16-17	202800	18	18	80,5	604,5	-
DSM03026	JDM	SIMPA 440 02-19		18	18	80,5	568,5	-
DSM03027	JDM	SIMPA 440 02-19		18	18	80,5	638	-
DSM03048	JDM	ABACA 505 05-19, ALBIZIA 505 02-07, ABACA 523 05-19, ALBIZIA 523 02-07		18	18	80,5	636	-
DSM03066	LIGIER	X-T00 505 05-07	01200005	18	18	80,5	604,5	-
DSM03075	BELLIER	JADE 523 16-19	00202804	18	18	80,5	587,5	-
DSM03086	MICROCAR	MGO 3 505 15-19	1008558	18	18	74	562	-
DSM03091	LIGIER	X-T00 505 07-19	141069	18	18	80,5	658	-
DSM03092	LIGIER	X-T00 505 07-19	141070	18	18	80,5	555	-
DSM03097	MICROCAR	MGO 1 505 13-15, MGO 2 505 13-15	1006226	18	18	74	598	-
DSM03129	LIGIER	JS 50 F1 505 09-10	141074	18	18	74	534	-
DSM03130	LIGIER	JS 50 F1 505 09-10	141073	18	18	74	626	-
DSM03134	CHATENET	CH26 EVO 505 16-19	0126144	18	18	80,5	653	-
DSM03142	LIGIER	JS50F1 10-12	141076 - 1411610/A	18	18	74	565	-
DSM03150	LIGIER	JS 48 (P70) 505 09-19	1401488	18	18	74	613	-
DSM03151	AIXAM	CITY ABS 400 10-12	3AP518A	18	18	69	610,5	42
DSM03153	CASALINI	M14 538 12-14	7857	18	18	80,5	563	-
DSM03154	CASALINI	M14 538 12-14	7858	18	18	80,5	617	-
DSM03156	CASALINI	M14 538 12-14	7856	18	18	80,5	573	-
DSM03157	LIGIER	JS 50 F2/F3 505 12-19	1403279	18	18	74	677,5	-
DSM03158	LIGIER	JS 50 F2/F3 505 12-19	1403278	18	18	74	581	-
DSM03161	AIXAM	CITY 500 12-19, COUPÉ 500 12-19	3AP518	18	18	69	610,5	-
DSM03162	AIXAM	CITY ABS 500 12-19	3MH519A	18	18	69	563	42
DSM03163	AIXAM	CITY ABS 500 12-19	3MH518A	18	18	69	653,5	42
DSM03165	AIXAM	A721 400 05-08, A741 400 05-08, A751 500 05-08						
	LIGIER	IXO 505 11-19		18	18	74	598	-
	MICROCAR	MC1 505 03-07, MC2 505 03-07, MC1 523 03-07	1006226					
DSM03166	AIXAM	400 400 99-05, 500,4 400 99-05, EVOLUTION 400 400 02-19						
	LIGIER	IXO 505 11-19		18	18	74	562	-
	MICROCAR	MC1 505 03-07, MC2 505 03-07, MC1 523 03-07	1008558					
DSM03176	BELLIER	JADE 523 16-19						
	JDM	TITANE 1/2/3 523 99-02		18	18	80,5	598,5	-
	LIGIER	X-T00 505 02-05, X-T00 MAX 505 02-05						



CODICE	MARCA	APPLICABILITÀ	RIFERIMENTO ORIGINALE	A (Denti Perno Lato Ruota)	B (Denti Nucleo Lato Cambio)	C (Lunghezza Perno Lato Ruota)	L (Lunghezza Compresa)	ABS (Ruota Fonica Z.)
DSM03180	CHATENET	BAROODER 505 08-19						
	LIGIER	OPTIMAX 505 00-19, PRIMA 505 00-19, X-T00 R 505 00-19		18	18	80,5	665	-
	MICROCAR	MGO 4 498 16-19, CARGO 505 07-19, MGO 3 505 15-19, MGO 4 505 16-19						
DSM03184	CASALINI	M14 538 08-12	F0040000773					
	CHATENET	BAROODER 505 08-19	0118007					
	JDM	ROXSY 440 08-19, XHEOS 442 08-19, ALOES 523 08-19, ROXSY 523 08-19		18	18	80,5	612	-
	LIGIER	JS RC 505 08-19						
	MICROCAR	MGO 1 505 08-13, MGO 2 505 08-13						
DSM03185	CASALINI	M14 538 08-12	F0040000774	18	18	80,5	653	-
DSM03219	LIGIER	JS 48 ELETTRICA 11-19	1400468	18	18	74	657	-
DSM03220	LIGIER	JS 40 505 11-19	1401231	18	18	74	651,5	-
DSM03233	LIGIER	JS 48 ELETTRICA 11-19	1400469	18	18	74	521	-
DSM03234	LIGIER	JS 40 505 11-19	1401230	18	18	74	548,5	-
DSM03235	CASALINI	KERRY 538 15-19, KERRY 635 15-19, M12 PICKUP 635 15-19						
	CHATENET	CJF 214 505 95-01, MEDIA 505 98-01, STELLA 505 00-04		18	18	80,5	579,5	-
	JDM	ABACA 505 05-19, ALBIZIA 505 02-07, ABACA 523 05-19, ALBIZIA 523 02-07						
DSM03236	CASALINI	KERRY 538 15-19, KERRY 635 15-19, M12 PICKUP 635 15-19	F0040000708 F0040000788 F0040000610	18	18	80,5	619,5	-
DSM03263	LIGIER	JS 36 505 14-19	1405360 - 3AA018	18	18	74	592	-
DSM03264	AIXAM	400 400 99-05	3G018	18	18	74	556,5	-
DSM03265	AIXAM	300 276 99-05, 400 400 99-05, 500 400 99-05	3L018	18	18	74	586	-
DSM03266	AIXAM	400 400 99-05	3MB018	18	18	74	610,5	-
DSM03268	CASALINI	M14 ABS 635 14-19	F0040000773A	18	18	80,5	612	45
DSM03269	CASALINI	M14 ABS 635 14-19	F0040000774A	18	18	80,5	658	45
DSM03271	CHATENET	CH26 EVO 505 16-19	01110095	18	18	80,5	604,5	-
DSM03272	LIGIER	JS 50 F1 505 10-12	1411609-A	18	18	74	665	-
DSM03275	CASALINI	M20 480 17-19	F0040000802	18	18	80,5	592,5	-
DSM03276	CASALINI	M20 480 17-19	F0040000801	18	18	80,5	637	-
DSM03279	BELLIER	DOCKER 480 16-19	00202826	18	18	80,5	511,5	-
DSM03280	BELLIER	B8 440 17-19, B8 523 17-19	00202825	18	18	80,5	569	-
DSM03292	LIGIER	JS58 ELETTRICA 15-19	1414957	18	18	74	667	-
DSM03293	LIGIER	JS58 ELETTRICA 15-19	1414958	18	18	74	567,5	-
DSM03295	BELLIER	B8 440 15-16, B8 523 15-16		18	18	80,5	640,5	-
DSM03296	LIGIER	JS 50 F4 505 19-19	1416343	18	18	74	621,5	-
DSM03298	AIXAM	CITY 400 10-12, CROSSLINE 400 10-19, GTO 400 10-19, CROSSLINE 500 10-19	3AP518	18	18	69	610,5	-

A series of horizontal dotted lines for writing notes, starting from the top of the page and extending to the bottom.



A series of horizontal dotted lines spanning the width of the page, intended for writing notes. The lines are evenly spaced and extend from the left margin to the right margin.



motorparts.it

Seguici su  



Motorparts S.r.l.
Motorparts a LKQ company
Via Aldina, 26
40012 Lippo di Calderara di Reno (BO)
Tel. +39 051 725442 - fax +39 051 725449
info@motor-parts.it