

**BORN
TO BE
MOTO**

2 | 0 | 2 | 0

**BORN
TO BE
MOTO**

2 0 2 0

CATALOGO - CATALOGUE

PEDANE REAR SETS

- A 16 regolabili - adjustable
- A 58 componenti ricambio - spare parts
- A 66 poggiapiedi - footpeg

TENDITORI CATENA CHAIN ADJUSTERS

- A 70 tenditori catena - chain adjusters
- B 74 supporti cavalletto - swing arm spools

LEVE LEVERS

- B 78 kit leve - kit levers
- B 81 leve freno / frizione - brake / clutch levers
- B 88 ricambi leve - levers spare parts

BRACCIALI MANUBRIO CLIP-ONS

- A 90 bracciali manubrio e tubi - Clip-ons and handlebar tubes

PROTEZIONI LEVE LEVERS PROTECTIONS

- B 94 protezioni leve - Levers protections

ACCESSORI MANUBRIO HANDLEBAR ACCESSORIES

- B 100 contrappesi manubrio - handle bar balancers

SPECCHI MIRRORS

- A 108 in alluminio - aluminium mirrors

TAPPI SPECCHIO MIRROR BLOCK-OFF PLATES

- B 112 tappi specchio colorati / coloured mirror block-off plates

PORTA TARGA LICENSE PLATE HOLDERS

- B 116 regolabili - adjustable

LUCI LIGHTS

- A 128 luci - lights

PROTEZIONI IN ALLUMINIO ALUMINIUM PROTECTIONS

- B 138 protezioni in alluminio - aluminium protections

PROTEZIONE PROTECTIONS

- B 144 protezione telaio - frame sliders
- B 147 ricambi protezioni telaio - Frame slider spare parts

PROTEZIONI PERNI RUOTA WHEEL AXLE SLIDERS

- B 150 protezioni perni ruota - wheel axle sliders

VITERIA BOLTS

- B 154 ergal 7075
 C 156 titanio - titanium
 B 158 special ergal 7075 - 7075 ergal special
 B 160 forate - drilled
 B 160 autofilettanti ergal 7075 - ergal7075 self tapping bolts
 B 161 ganci rapidi e ricettacoli - quick fairing and receptacle
 B 162 dadi e rondelle - nuts and washers
 C 164 viti dischi freno in titanio - bolts for brake disk in titanium

KIT VITI BOLTS KIT

- B 166 kit viti - bolts kit

DADI SPECIAL SPECIAL NUTS

- B 170 dadi special - special nuts

TAPPI CAPS

- A 174 tappi serbatoio - fuel tank caps
 B 179 serbatoio olio freno e frizione - fluid tank for brake and clutch
 B 180 tappi olio - oil filler caps
 B 182 coperchi pompe freno e frizione - clutch/brake pump reservoir covers

COMPONENTI IN CARBONIO CARBON PARTS

- C 188 componenti in carbonio - carbons parts

CAVALLETTI STANDS RACING & BOX

- D 198 cavalletti - stands
 A 204 accessori box - box accessories
 A 206 serbatoio rifornimento rapido - fast fuel canister
 B 207 saponette - knee sliders

ADESIVI STICKERS

- B 210 adesivi / stickers
 A 216 telo coprimoto - bike cover

COMMUNICAZIONE E MERCHANDISING WERBEMITTEL UND MERCHANDISING

- 218 comunicazione e merchandising / communication and merchandising

A	B	C	D	E
---	---	---	---	---

LIGHTECH

italian racing components

Nel 1997, Fabrizio Furlan crea LighTech per portare le competenze produttive della sua famiglia e della sua professione di pilota nell'eccitante mondo delle moto da corsa. Collaborare con prestigiosi team nel Campionato Mondiale Superbike, Moto GP, Moto 2GP e 125 GP ha permesso a LighTech di sviluppare e diventare leader nel campo degli accessori per moto. Oggi, LighTech si sviluppa su una superficie di 2.500 metri quadrati, così suddivisi: 1.400 dedicati alla produzione con sofisticati torni e frese a controllo numerico (CNC), 600 all'area magazzino e stoccaggio, 50 al dipartimento Ricerca e Sviluppo in cui gli ingegneri utilizzano programmi di disegno tecnico (CAD) e produzione (CAM) assistiti da computer per progettare. Oltre alla sede principale, LighTech dispone di un altro stabilimento di 1.600 metri quadrati dotato di impianti per la produzione di pedane, leve freno-frizione e portatarga.

In 1997, Fabrizio Furlan created LighTech to bring his family's manufacturing expertise to the exciting world of motorcycle racing. Working closely with elite teams in the World Superbike Championship, Moto GP, 125 GP and Moto 2GP has allowed LighTech to become a leader of technologically advanced motorcycle performance parts and accessories. Today, the LighTech factory houses 2,500 square meters of which 1,400 dedicated to production with sophisticated computer-numeric-control (CNC) machines, 600 to storage area and 50 to research and development department where engineers use state-of-the-art computer-assisted design (CAD) and computer-assisted manufacturing (CAM) programs. In addition to the main factory, LighTech has a subsidiary with a 1,600 square meter facility for producing rearsets, brake and clutch levers and license plate holders.



**BORN
TO BE
MOTO**

www.lightech.it



Il catalogo LighTech contiene più di 7.000 prodotti in Ergal che sono realizzati in diverse colorazioni, 400 prodotti in titanio ed una serie di numerosi altri accessori. LighTech può contare su di una rete vendita strutturata attualmente in oltre 1.500 rivenditori autorizzati in Italia e distributori in 50 altri paesi. Tale rete è in continuo ampliamento.

The scope of LighTech is enormous. The LighTech catalog contains over 7,000 ergal products that are manufactured in seven different colours, over 400 titanium products and a host of other accessories. LighTech has more than 1,500 authorized dealers in Italy and distributors in 50 countries.

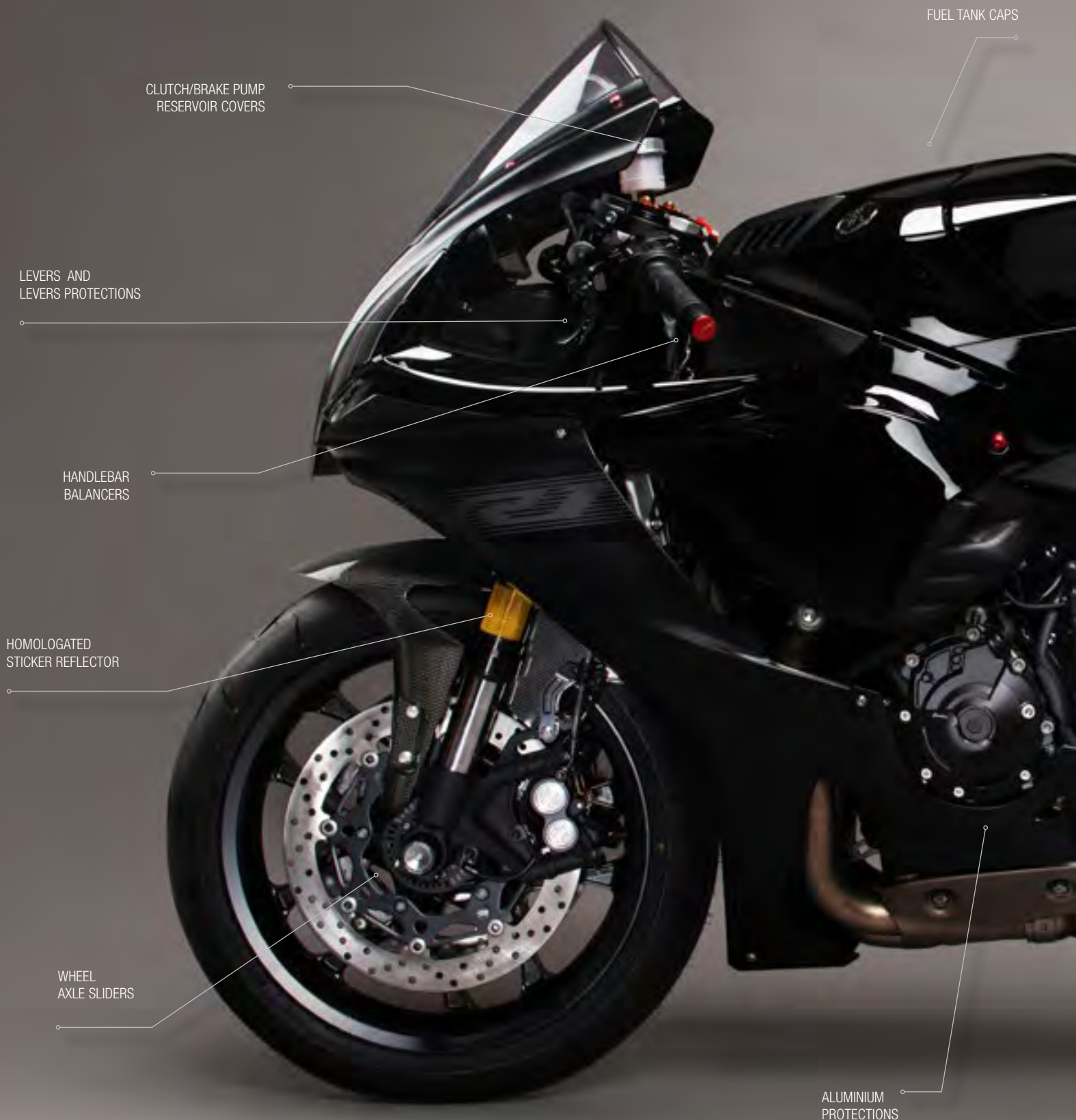

CLUTCH/BRAKE PUMP
RESERVOIR COVERS

FUEL TANK CAPS

LEVERS AND
LEVERS PROTECTIONS

HANDLEBAR
BALANCERS

HOMOLOGATED
STICKER REFLECTOR

WHEEL
AXLE SLIDERS

ALUMINIUM
PROTECTIONS

BORN TO BE MOTO

www.lightech.it



BOLTS

LICENSE PLATE HOLDERS

LIGHTS

CARBON PARTS

CHAIN ADJUSTERS

REAR SETS

STANDS

Anni di sponsorizzazioni tecniche, l'utilizzo di un design e metodi di produzione all'avanguardia e la passione per la moto da corsa, sono le ragioni per cui si trovano qualità e innovazione in ogni prodotto Lightech.

Years of technical sponsorship, the use of cutting edge design and production methods and a passion for motorcycle racing are the reasons why you will find quality and innovation in every LightTech product. You can definitely believe that.



2020 • TECHNICAL SPONSOR

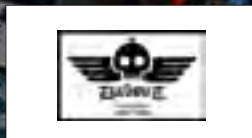

**BORN
TO BE
MOTO**

www.lighttech.it





PEDANE REGOLABILI "R VERSION"
"R VERSION" ADJUSTABLE REAR SETS

100% DESIGN MADE IN ITALY

Per raggiungere la massima qualità in ogni prodotto, sviluppiamo prodotti innovativi caratterizzati da funzionalità e design "Made in Italy" a partire dalla fase di progettazione, sempre nella consapevolezza di un mercato che cambia ogni giorno, per offrire prodotti ad alto valore aggiunto.

To achieve the highest quality in each product, we develop innovative products characterized by functionality and "Made in Italy" design starting from the design phase, always in the awareness of a market that changes every day, to offer products with high added value.

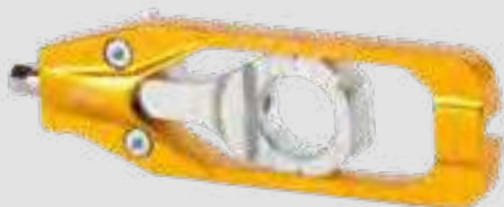

TENDITORI CATENA
CHAIN ADJUSTERS



SUPPORTI PER CAVALLETTI
SWING ARM SPOOLS



LEVE FRIZIONE
CLUTCH LEVERS



PROTEZIONI LEVE
LEVERS GUARDS



CONTRAPPESI MANUBRI
HANDLEBAR BALANCERS



PROTEZIONI PERNI RUOTA
WHEEL AXLE SLIDERS



INDICATORI DI DIREZIONE A LED
LED TURN SIGNALS



INDICATORI DI DIREZIONE A LED
LED TURN SIGNALS



TAPPI SERBATOIO
FUEL TANK CAPS



CAVALLETTI
REAR STANDS

BORN
TO BE
MOTO





PEDANE
REAR SETS

**POGGIA PIEDE FISSO
FIXED FOOTPEG**



silver
silver

nero
black

**POGGIA PIEDE SNODATO
FOLDING FOOTPEG**



silver
silver

cobalto
cobalt

nero
black

rosso
red

oro
gold

**SUPPORTO POGGIPIEDE
FOOTPEG HOLDER**



Colori disponibili
Available colours:



Supporto poggiapiede lato freno
Footpeg holder brake side



Supporto poggiapiede lato cambio
Footpeg holder shift side



Kit supporti poggiapiedi "UP&DOWN"
Supports kit for footpegs "UP&DOWN"



Supporto puntalino
Toe peg holder

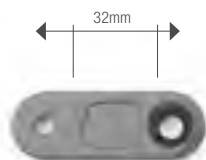

Supporto puntalino
Toe peg holder

Tutte le pedane LighTech sono progettate e realizzate al **100%** nel nostro stabilimento.

All LighTech rear sets are designed and manufactured **100%** in our factory.



Uniball
Mas M6 dx
Mas M6 sx

VAR1036
VAR1077



Uniball
Fem M6 dx
Fem M6 sx

VAR1095
VAR1076



Paratacco in carbonio "White R"
Carbon heel guards "White R"



Paratacco in alluminio
Aluminium heel guards



Paratacco in carbonio
Carbon heel guards



Paratacco in magnesio
Magnesium heel guards



TUV homologated
FTRXXXKBA90967

PUNTALINO SNODATO
FOLDING FRONT TOE PEG
rivestiti in gomma / rubber coated



Millerighe
Gear shift arm



Millerighe
Gear shift arm

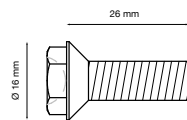

Vite per FTR507 / FTR508
Bolt for FTR507 / FTR508



Vite per FTR507 / FTR508
Bolt for FTR507 / FTR508

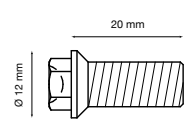

Vite per FTR704 / RFTR244
Bolt for FTR704 / RFTR244

PEDANE REGOLABILI

18 ADJUSTABLE REAR SETS

APRILIA



RSV4 TUONO V4

TRACK
SYSTEM

Anno / Year: 18-20

Cambio / Shifting: standard
(tutte le versioni / all versions)

Poggiapiede fisso
Fixed footpeg

FTRAP005

€ 400,00

Poggiapiede snodato
Fold up footpeg

FTRAP005W

€ 452,00



RSV4 TUONO V4

TRACK
SYSTEM

Anno / Year: 18-20

Cambio / Shifting: standard
(tutte le versioni / all versions)

"R" version

FTRAP005R

€ 614,00





**RSV4
TUONO V4**

TRACK
SYSTEM

Anno / Year: 18-20

Cambio / Shifting: reverse

Poggiapiede fisso
Fixed footpeg FTRAP006 € 415,00

Poggiapiede snodato
Fold up footpeg FTRAP006W € 465,00



**RSV4
TUONO V4**

TRACK
SYSTEM

Anno / Year: 18-20

Cambio / Shifting: reverse
(tutte le versioni / all versions)

"R" version FTRAP006R € 625,00





**RSV4
TUONO V4**



(tutte le versioni / all versions)

Anno / Year: **RSV4** 09-17
Anno / Year: **TUONO V4** 11-17
Cambio / Shifting: standard

PoggiapiEDE fisso
Fixed footpeg FTRAP004 € 385,00

PoggiapiEDE snodato
Fold up footpeg FTRAP004W € 437,00



**RSV4
TUONO V4**



(tutte le versioni / all versions)

Anno / Year: **RSV4** 09-17
Anno / Year: **TUONO V4** 11-17
Cambio / Shifting: standard

"R" version FTRAP004R € 598,00



**RSV4
TUONO V4**



(tutte le versioni / all versions)

Anno / Year: **RSV4** 09-17
Anno / Year: **TUONO V4** 11-17
Cambio / Shifting: standard

"R" version FTRAP004RSIL € 598,00

! FINE SERIE - END STOCK

KIT conversione cambio da standard a rovesciato per modello FTRAP004-W-R
Conversion kit standard to reverse shift for p/n FTRAP004-W-R



RFTR236 € 125,00



S1000RR

TRACK SYSTEM

Anno / Year: 19-20

Cambio / Shifting: standard - reverse

Poggiapiede fisso
Fixed footpeg

FTRBM007 € 465,00

Poggiapiede snodato
Fold up footpeg

FTRBM007W € 515,00

BMW



S1000RR

TRACK SYSTEM

Anno / Year: 19-20

Cambio / Shifting: standard - reverse

"R" version

FTRBM007R € 675,00

Supporto leva cambio per uso racing
Gear shift arm for race use
Anno / Year: 20



FTR840NER € 46,00

BMW



S1000R
S1000RR / HP4



Anno / Year S1000R: 17-19
Anno / Year S1000RR / HP4: 15-18
Cambio / Shifting: standard - reverse

PoggiapiEDE fisso
Fixed footpeg FTRBM004 € 437,00

PoggiapiEDE snodato
Fold up footpeg FTRBM004W € 489,00



S1000R
S1000RR / HP4



Anno / Year S1000R: 17-19
Anno / Year S1000RR / HP4: 15-18
Cambio / Shifting: standard - reverse

"R" version FTRBM004R € 650,00



S1000R
S1000RR / HP4



Anno / Year S1000R: 17-19
Anno / Year S1000RR / HP4: 15-18
Cambio / Shifting: standard - reverse

"R" version FTRBM004RSIL € 650,00

! FINE SERIE - END STOCK



S1000R
S1000RR / HP4

TRACK
SYSTEM

Anno / Year S1000R: 14-16
Anno / Year S1000RR / HP4: 09-14
Cambio / Shifting: standard

PoggiapiEDE fisso
Fixed footpeg FTRBM001 € 414,00

PoggiapiEDE snodato
Fold up footpeg FTRBM001W € 466,00



S1000R
S1000RR / HP4

TRACK
SYSTEM

Anno / Year S1000R: 14-16
Anno / Year S1000RR / HP4: 09-14
Cambio / Shifting: standard

"R" version FTRBM001R € 627,00

KIT conversione cambio da standard a rovesciato per modello FTRBM001-W-R
Conversion kit standard to reverse shift for p/n FTRBM001-W-R



RFTR164 € 172,00



**S1000R
S1000RR / HP4**

TRACK
SYSTEM

Anno / Year S1000R: 14-16
Anno / Year S1000RR / HP4: 09-14
Cambio / Shifting: reverse

Poggiapiede fisso Fixed footpeg	FTRBM002	€ 437,00
------------------------------------	----------	----------

Poggiapiede snodato Fold up footpeg	FTRBM002W	€ 489,00
--	-----------	----------

BMW



**S1000R
S1000RR / HP4**

TRACK
SYSTEM

Anno / Year S1000R: 14-16
Anno / Year S1000RR / HP4: 09-14
Cambio / Shifting: reverse

"R" version	FTRBM002R	€ 650,00
-------------	-----------	----------

KIT conversione cambio da rovesciato a standard per modello FTRBM002-W-R
Conversion kit reverse to standard shift for p/n FTRBM002-W-R

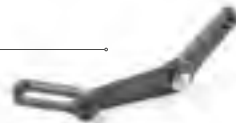

RFTR207	€ 68,00
---------	---------



R1200 GS

Anno / Year: 13-18

Cambio / Shifting: standard

PoggiapiEDE snodato
Fold up footpeg

FTRBM006NERW € 230,00

! FINE SERIE - END STOCK



Cambio / Shifting: standard

PoggiapiEDE snodato
Fold up footpeg

FTRBM006COBW € 230,00

! FINE SERIE - END STOCK



Cambio / Shifting: standard

PoggiapiEDE snodato
Fold up footpeg

FTRBM006ROSW € 230,00

! FINE SERIE - END STOCK



PEDANE REGOLABILI

26 ADJUSTABLE REAR SETS



PANIGALE R PANIGALE V4 / S SPECIALE

TRACK
SYSTEM

Anno / Year: 18-20

Cambio / Shifting: standard - reverse

PoggiapiEDE fisso
Fixed footpeg FTRDU012 € 619,00

PoggiapiEDE snodato
Fold up footpeg FTRDU012W € 671,00

DUCATI



PANIGALE R PANIGALE V4 / S SPECIALE

TRACK
SYSTEM

Anno / Year: 18-20

Cambio / Shifting: standard - reverse

"R" version FTRDU012R € 832,00





**PANIGALE 899 / 959 /
1199 / 1299
PANIGALLE V2**

TRACK
SYSTEM

Anno / Year: 12-17

Cambio / Shifting: standard

Poggiapiede fisso
Fixed footpeg FTRDU010 € 619,00

Poggiapiede snodato
Fold up footpeg FTRDU010W € 671,00

Anno / Year: 12-17

Cambio / Shifting: reverse

Poggiapiede fisso
Fixed footpeg FTRDU011 € 619,00

Poggiapiede snodato
Fold up footpeg FTRDU011W € 671,00



**PANIGALE 899 / 959 /
1199 / 1299
PANIGALLE V2**

TRACK
SYSTEM

Anno / Year: 12-17

Cambio / Shifting: standard

"R" version FTRDU010R € 832,00

Anno / Year: 12-17

Cambio / Shifting: reverse

"R" version FTRDU011R € 832,00

KIT conversione cambio da standard a rovesciato per mod. FTRDU010-W-R
Conversion kit standard to reverse shift for p/n FTRDU010-W-R



RFTR192 € 62,50

KIT conversione cambio da rovesciato a standard per mod. FTRDU011-W-R
Conversion kit reverse to standard shift for p/n FTRDU011-W-R



RFTR191 € 68,00

PEDANE REGOLABILI

28 ADJUSTABLE REAR SETS

DUCATI



848 / 1098 1198 REPLICA SBK

Anno / Year: 07-11

Cambio / Shifting: standard - reverse

Poggiapiede fisso
Fixed footpeg FTRDU005 € 385,00

Poggiapiede snodato
Fold up footpeg FTRDU005W € 437,00

848 / 1098 1198 REPLICA SBK

Anno / Year: 07-11

Cambio / Shifting: standard - reverse

"R" version FTRDU005R € 598,00





CB1000R

TRACK SYSTEM

Anno / Year: 18-19

Cambio / Shifting: standard - reverse

Poggiapiede fisso
Fixed footpeg FTRH0008 € 400,00

Poggiapiede snodato
Fold up footpeg FTRH0008W € 452,00



CB1000R

TRACK SYSTEM

Anno / Year: 18-19

Cambio / Shifting: standard - reverse

"R" version FTRH0008R € 614,00

HONDA



PEDANE REGOLABILI

30 ADJUSTABLE REAR SETS



CBR 600 RR

TRACK
SYSTEM

Anno / Year: 07-16

Cambio / Shifting: standard - reverse

Poggiapiede fisso
Fixed footpeg

FTRH0005

€ 400,00

Poggiapiede snodato
Fold up footpeg

FTRH0005W

€ 452,00

HONDA



CBR 600 RR

TRACK
SYSTEM

Anno / Year: 07-16

Cambio / Shifting: standard - reverse

"R" version

FTRH0005R

€ 614,00



CBR 1000 RR

TRACK
SYSTEM

Anno / Year: 08 19

Cambio / Shifting: standard - reverse

PoggiapiEDE fisso Fixed footpeg	FTRH0006	€ 411,00
------------------------------------	----------	----------

PoggiapiEDE snodato Fold up footpeg	FTRH0006W	€ 463,00
--	-----------	----------



CBR 1000 RR

TRACK
SYSTEM

Anno / Year: 08 19

Cambio / Shifting: standard - reverse

"R" version	FTRH0006R	€ 623,00
-------------	-----------	----------

PEDANE REGOLABILI

32 ADJUSTABLE REAR SETS

NEW DESIGN
100% Made in Italy



X-ADV

Anno / Year: 17-20

Poggiapiède snodato
Fold up footpeg FTRH0009NER € 315,00

Poggiapiède snodato
Fold up footpeg FTRH0009COB € 315,00



Poggiapiède snodato
Fold up footpeg FTRH0009ROS € 315,00



HONDA

AFRICA TWIN

Anno / Year: 18-20

Poggiapiède snodato
Fold up footpeg FTRH0010NER € 160,00



Poggiapiède snodato
Fold up footpeg FTRH0010COB € 160,00



Poggiapiède snodato
Fold up footpeg FTRH0010ROS € 160,00





Z 900

TRACK SYSTEM

Anno / Year: 17-20

Cambio / Shifting: standard - reverse

Poggiapiede fisso
Fixed footpeg FTRKA010 € 385,00

Poggiapiede snodato
Fold up footpeg FTRKA010W € 437,00



Z 900

TRACK SYSTEM

Anno / Year: 17-20

Cambio / Shifting: standard - reverse

"R" version FTRKA010R € 598,00

KAWASAKI



PEDANE REGOLABILI

34 ADJUSTABLE REAR SETS



Z400 / Z250 NINJA 400 / NINJA 250

TRACK
SYSTEM

Anno / Year: 18-20

Cambio / Shifting: standard - reverse

Poggiapiede fisso
Fixed footpeg

FTRKA007

€ 330,00

Poggiapiede snodato
Fold up footpeg

FTRKA007W

€ 380,00

KAWASAKI



Z400 / Z250 NINJA 400 / NINJA 250

TRACK
SYSTEM

Anno / Year: 18-20

Cambio / Shifting: standard - reverse

"R" version

FTRKA007R

€ 535,00





ZX6R- 636 *

TRACK
SYSTEM

Anno / Year: 05-20

Cambio / Shifting: standard

Poggiapiede fisso
Fixed footpeg FTRKA008 € 385,00

Poggiapiede snodato
Fold up footpeg FTRKA008W € 437,00



ZX6R- 636 *

TRACK
SYSTEM

Anno / Year: 05-20

Cambio / Shifting: standard

"R" version FTRKA008R € 598,00

PEDANE REGOLABILI

36 ADJUSTABLE REAR SETS



ZX6R- 636

TRACK
SYSTEM

Anno / Year: 05-20

Cambio / Shifting: reverse

Poggiapiede fisso
Fixed footpeg

FTRKA009

€ 400,00

Poggiapiede snodato
Fold up footpeg

FTRKA009W

€ 452,00

KAWASAKI



ZX6R- 636

TRACK
SYSTEM

Anno / Year: 05-20

Cambio / Shifting: reverse

"R" version

FTRKA009R

€ 614,00



ZX10R

TRACK SYSTEM

Anno / Year: 16-20

Cambio / Shifting: standard

Poggiapiede fisso
Fixed footpeg FTRKA006 € 400,00

Poggiapiede snodato
Fold up footpeg FTRKA006W € 452,00



ZX10R

TRACK SYSTEM

Anno / Year: 16-20

Cambio / Shifting: standard

"R" version FTRKA006R € 614,00



ZX10R

TRACK SYSTEM

Anno / Year: 16-20

Cambio / Shifting: standard

"R" version FTRKA006RSIL € 614,00

! FINE SERIE - END STOCK

KIT conversione cambio da standard a rovesciato per modello FTRKA006-W-R
Conversion kit standard to reverse shift for p/n FTRKA006-W-R



RFTR232 € 125,00

PEDANE REGOLABILI

38 ADJUSTABLE REAR SETS



ZX10R

TRACK
SYSTEM

Anno / Year: 11-15

Cambio / Shifting: standard - reverse

PoggiapiEDE fisso
Fixed footpeg

FTRKA003

€ 385,00

PoggiapiEDE snodato
Fold up footpeg

FTRKA003W

€ 437,00

KAWASAKI



ZX10R

TRACK
SYSTEM

Anno / Year: 11-15

Cambio / Shifting: standard - reverse

"R" version

FTRKA003R

€ 598,00



DUKE 790

TRACK SYSTEM

Anno / Year: 18-20

Cambio / Shifting: standard - reverse

Poggiapiede fisso
Fixed footpeg FTRKT002 € 411,00

Poggiapiede snodato
Fold up footpeg FTRKT002W € 463,00



DUKE 790

TRACK SYSTEM

Anno / Year: 18-20

Cambio / Shifting: standard - reverse

"R" version FTRKT002R € 623,00

KTM



PEDANE REGOLABILI

40 ADJUSTABLE REAR SETS



RC 125 / RC 200 / RC 390

TRACK
SYSTEM

Anno / Year: 17-20

Cambio / Shifting: standard - reverse

PoggiapiEDE fisso
Fixed footpeg FTRKT001 € 590,00

PoggiapiEDE snodato
Fold up footpeg FTRKT001W € 642,00

FOR RACING USE ONLY

Non omologata TUV
No TUV approved

KTM



KTM 1290 SUPER ADVENTURE

Anno / Year: 17-20

PoggiapiEDE snodato
Fold up footpeg FTRKT003NER € 160,00

PoggiapiEDE snodato
Fold up footpeg FTRKT003ARA € 160,00





F3 675
F3 800

TRACK
SYSTEM

Anno / Year F3 675: 11-16
Anno / Year F3 800: 13-16
Cambio / Shifting: standard - reverse

Poggiapiede fisso
Fixed footpeg **FTRMV002** € 411,00
! FINE SERIE - END STOCK

Poggiapiede snodato
Fold up footpeg **FTRMV002W** € 463,00

Not compatible with EURO4 models ! FINE SERIE - END STOCK



F3 675
F3 800

TRACK
SYSTEM

Anno / Year F3 675: 11-18
Anno / Year F3 800: 13-18
Cambio / Shifting: standard - reverse

"R" version **FTRMV002R** € 623,00

Not compatible with EURO4 models ! FINE SERIE - END STOCK

PEDANE REGOLABILI

42 ADJUSTABLE REAR SETS

SUZUKI



GSX-R 600 GSX-R 750

TRACK
SYSTEM

Anno / Year: 11-17

Cambio / Shifting: standard - reverse

PoggiapiEDE fisso
Fixed footpeg FTRSU002 € 385,00

PoggiapiEDE snodato
Fold up footpeg FTRSU002W € 437,00

GSX-R 600 GSX-R 750

TRACK
SYSTEM

Anno / Year: 11-17

Cambio / Shifting: standard - reverse

"R" version FTRSU002R € 598,00





GSX-R 1000
GSX-R 1000 R

TRACK
SYSTEM

Anno / Year: 17-20

Cambio / Shifting: standard - reverse

Poggiapiede fisso
Fixed footpeg FTRSU004 € 411,00

Poggiapiede snodato
Fold up footpeg FTRSU004W € 463,00



GSX-R 1000
GSX-R 1000 R

TRACK
SYSTEM

Anno / Year: 17-20

Cambio / Shifting: standard - reverse

"R" version FTRSU004R € 623,00



GSX-R 1000
GSX-R 1000 R

TRACK
SYSTEM

Anno / Year: 17-18

Cambio / Shifting: standard - reverse

"R" version FTRSU004RSIL € 623,00

! FINE SERIE - END STOCK

PEDANE REGOLABILI

44 ADJUSTABLE REAR SETS

SUZUKI



GSX-S 1000

TRACK SYSTEM

Anno / Year: 15-20

Cambio / Shifting: standard - reverse

Poggiapiede fisso
Fixed footpeg

FTRS003

€ 385,00

Poggiapiede snodato
Fold up footpeg

FTRS003W

€ 437,00



GSX-S 1000

TRACK SYSTEM

Anno / Year: 15-20

Cambio / Shifting: standard - reverse

"R" version

FTRS003R

€ 598,00





**SPEED TRIPLE 1050
SPEED TRIPLE 1050 R**

Anno / Year: 11-18

Cambio / Shifting: standard

Poggiapiede fisso
Fixed footpeg

FTRTR003 € 385,00

! FINE SERIE - END STOCK

Poggiapiede snodato
Fold up footpeg

FTRTR003W € 437,00

! FINE SERIE - END STOCK



**SPEED TRIPLE 1050
SPEED TRIPLE 1050 R**

Anno / Year: 11-18

Cambio / Shifting: standard

"R" version

FTRTR003R € 598,00

! FINE SERIE - END STOCK



DAYTONA 675 / 675 R
STREET TRIPLE 675 / 675 R
STREET TRIPLE 765 / R / RS

TRACK
SYSTEM

Anno / Year DAYTONA 675 / 675 R: 13-16
 Anno / Year STREET TRIPLE 675 / 675 R: 13-16
 Anno / Year STREET TRIPLE 765 / R / RS: 17-18
 Cambio / Shifting: standard

Poggiapiede fisso
 Fixed footpeg FTRTR004 € 385,00

Poggiapiede snodato
 Fold up footpeg FTRTR004W € 437,00



DAYTONA 675 / 675 R
STREET TRIPLE 675 / 675 R
STREET TRIPLE 765 / R / RS

TRACK
SYSTEM

Anno / Year DAYTONA 675 / 675 R: 13-16
 Anno / Year STREET TRIPLE 675 / 675 R: 13-16
 Anno / Year STREET TRIPLE 765 / R / RS: 17-18
 Cambio / Shifting: standard

"R" version FTRTR004R € 598,00



MT-07
MT-07 TRACER

Anno / Year: 14-20

Cambio / Shifting: standard

Poggiapiede fisso		
Fixed footpeg	FTRYA008	€ 385,00

Poggiapiede snodato		
Fold up footpeg	FTRYA008W	€ 437,00



MT-07
MT-07 TRACER

Anno / Year: 14-20

Cambio / Shifting: standard

"R" version	FTRYA008R	€ 598,00
-------------	-----------	----------



**MT-09
MT-09 TRACER
XSR900**

Anno / Year: 13-20

Cambio / Shifting: standard

Poggiapiede fisso Fixed footpeg	FTRYA007	€ 385,00
------------------------------------	----------	----------

Poggiapiede snodato Fold up footpeg	FTRYA007W	€ 437,00
--	-----------	----------



**MT-09
MT-09 TRACER
XSR900**

Anno / Year: 13-20

Cambio / Shifting: standard

"R" version	FTRYA007R	€ 598,00
-------------	-----------	----------



MT-10

TRACK SYSTEM

Anno / Year: 16-20

Cambio / Shifting: standard - reverse

Poggiapiede fisso
Fixed footpeg

FTRYA011 € 447,00

Poggiapiede snodato
Fold up footpeg

FTRYA011W € 499,00



MT-10

TRACK SYSTEM

Anno / Year: 16-20

Cambio / Shifting: standard - reverse

"R" version

FTRYA011R € 660,00

YAMAHA



PEDANE REGOLABILI

50 ADJUSTABLE REAR SETS

YAMAHA



**R1
R1M**

TRACK
SYSTEM

Anno / Year: 15-20

Cambio / Shifting: standard - reverse

PoggiapiEDE fisso
Fixed footpeg

FTRYA016

€ 415,00

PoggiapiEDE snodato
Fold up footpeg

FTRYA016W

€ 465,00



**R1
R1M**

TRACK
SYSTEM

Anno / Year: 15-20

Cambio / Shifting: standard - reverse

"R" version

FTRYA016R

€ 625,00



Staffa di supporto per leva cambio e catalizzatore per R1 dal 2020.
Permette rimozione cavalletto laterale.

Support bracket for gear lever and catalyst for R1 from 2020.
It allows the removal of side stand.

Anno / Year: 20

FTR862

€ 52,00



Staffa di supporto per leva cambio per R1 dal 2015-2019. Permette rimozione cavalletto laterale.
Support bracket for gear lever for R1 from 2015 to 2019. It allows the removal of side stand.

Anno / Year: 15-19

FTR632

€ 46,00



R1

Anno / Year: 09-14

Cambio / Shifting: standard - reverse

Poggiapiede fisso
Fixed footpeg FTRYA001 € 385,00

Poggiapiede snodato
Fold up footpeg FTRYA001W € 437,00



R1

Anno / Year: 09-14

Cambio / Shifting: standard - reverse

"R" version FTRYA001R € 598,00

PEDANE REGOLABILI

52 ADJUSTABLE REAR SETS



R3

TRACK
SYSTEM

Anno / Year: 15-20

Cambio / Shifting: standard

PoggiapiEDE fisso Fixed footpeg	FTRYA013	€ 385,00
------------------------------------	----------	----------

PoggiapiEDE snodato Fold up footpeg	FTRYA013W	€ 437,00
--	-----------	----------

Cambio / Shifting: reverse

PoggiapiEDE fisso Fixed footpeg	FTRYA014	€ 411,00
------------------------------------	----------	----------

PoggiapiEDE snodato Fold up footpeg	FTRYA014W	€ 463,00
--	-----------	----------



R3

TRACK
SYSTEM

Anno / Year: 15-20

Cambio / Shifting: standard

"R" version	FTRYA013R	€ 598,00
-------------	-----------	----------

Cambio / Shifting: reverse

"R" version	FTRYA014R	€ 623,00
-------------	-----------	----------

YAMAHA





R6

TRACK SYSTEM

Anno / Year: 17-20

Cambio / Shifting: standard - reverse

Poggiapiede fisso
Fixed footpeg

FTRYA012

€ 411,00

Poggiapiede snodato
Fold up footpeg

FTRYA012W

€ 463,00



R6

TRACK SYSTEM

Anno / Year: 17-20

Cambio / Shifting: standard - reverse

"R" version

FTRYA012R

€ 623,00

PEDANE REGOLABILI

54 ADJUSTABLE REAR SETS



R6

Anno / Year: 08 -16

Cambio / Shifting: standard - reverse

Poggiapiede fisso Fixed footpeg	FTRYA002	€ 385,00
------------------------------------	----------	----------

Poggiapiede snodato Fold up footpeg	FTRYA002W	€ 437,00
--	-----------	----------

YAMAHA



R6

Anno / Year: 08-16

Cambio / Shifting: standard - reverse

"R" version	FTRYA002R	€ 598,00
-------------	-----------	----------

NEW!

TENERE

Anno / Year: 19-20



Poggiapiede fisso
Fixed footpeg

FTRYA015NER € 160,00



Poggiapiede fisso
Fixed footpeg

FTRYA015COB € 160,00



Poggiapiede fisso
Fixed footpeg

FTRYA015ROS € 160,00

YAMAHA



BORN
TO BE
MOTO





**COMPONENTI
RICAMBIO PER PEDANE
REAR SET SPARE PARTS**

17
189.01

2115-12





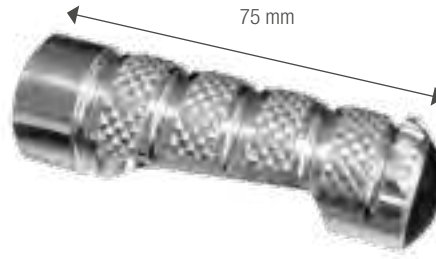

Uortech

Colori disponibili - Available colours:



silver
silver

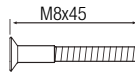

Poggia piede fisso Fixed footpeg		Codice - Code	a pezzo - for piece
Poggia piede fisso + vite M8x20 Fixed footpeg + bolt M8x20	 +  =	RFTR245	€ 28,00
Poggia piede fisso + vite M8x25 Fixed footpeg + bolt M8x25	 +  =	RFTR246	€ 28,00
Poggia piede fisso + vite M8x45 Fixed footpeg + bolt M8x45	 +  =	RFTR247	€ 28,00
Poggia piede fisso + vite testa cilindrica M8x20 Fixed footpeg + vite testa cilindrica M8x20	 +  =	RFTR248	€ 28,00

Colori disponibili - Available colours:



silver
silver





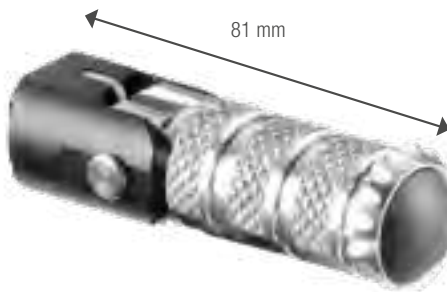

cobalto
cobalt

nero
black

rosso
red

oro
gold

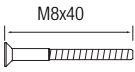







Poggia piede snodato Folding footpeg		Codice - Code	a pezzo - for piece
Poggia piede snodato + vite M8x20 Folding footpeg + vite M8x20	 +  =	RFTR249	€ 43,00
Poggia piede snodato + vite M8x25 Folding footpeg + vite M8x25	 +  =	RFTR250	€ 43,00
Poggia piede snodato + vite M8x40 Folding footpeg + vite M8x40	 +  =	RFTR251	€ 43,00
Poggia piede snodato + vite testa cilindrica M8x20 Folding footpeg + vite testa cilindrica M8x20	 +  =	RFTR252	€ 43,00



Colori disponibili - Available colours:

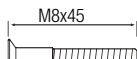

FINE SERIE - END STOCK

Poggia piede fisso Fixed footpeg				Codice - Code	a pezzo - for piece
Poggia piede fisso + vite M8x20 Fixed footpeg + bolt M8x20		+		RFTR189	€ 19,00
Poggia piede fisso + vite M8x25 Fixed footpeg + bolt M8x25		+		RFTR45	€ 19,00
Poggia piede fisso + vite M8x45 Fixed footpeg + bolt M8x45		+		RFTR32	€ 19,00
Poggia piede fisso + vite testa cilindrica M8x20 Fixed footpeg + vite testa cilindrica M8x20		+		RFTR178	€ 19,00



HIGH
GRIP

COMPONENTI RICAMBIO PER PEDANE

60 REAR SET SPARE PARTS



cobalto / cobalt



rosso / red



silver / silver



nero / black



verde / green

Supporto poggiatesta
Footpeg holder

FTR704 € 26,00

a pezzo - for piece



rosso / red



silver / silver



nero / black

Supporto poggiatesta lato freno
Footpeg holder brake side

FTR507 € 26,00

a pezzo - for piece



rosso / red



silver / silver



nero / black

Supporto poggiatesta lato cambio
Footpeg holder shift side

FTR508 € 26,00

a pezzo - for piece



cobalto / cobalt



silver / silver



nero / black



rosso / red



cobalto / cobalt



silver / silver



nero / black



rosso / red

Kit supporti poggiatesta "UP&DOWN" per avere più combinazioni di regolazione (escluse viti di fissaggio)
Supports kit for footpegs "UP&DOWN" to allow multiple combinations (fitting bolts not included)

RFTR244* € 52,00

* Verificare compatibilità / Always check compatibility

a kit - for kit



Esempi di possibili configurazioni / Examples of possible configurations:

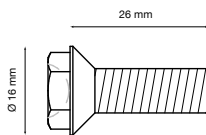
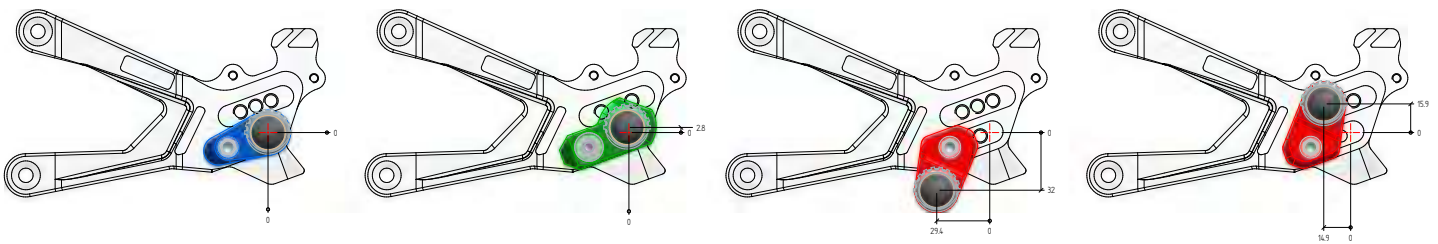

Vite per FTR507 / FTR508
Bolt for FTR507 / FTR508

FTR760 € 5,50



Vite per FTR507 / FTR508
Bolt for FTR507 / FTR508

V005M8020ZB € 0,50

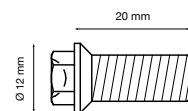

Vite per FTR704 / RFTR244
Bolt for FTR704 / RFTR244

FTR690 € 5,00

COMPONENTI RICAMBIO PER PEDANE

62 REAR SET SPARE PARTS



Paratacco in carbonio "White R"
Carbon heel guards "White R"

FTR796 € 43,70



Paratacco in carbonio "White R"
Carbon heel guards "White R"

FTR795 € 43,70



Paratacco in alluminio
Aluminium heel guards

FTR419SIL € 42,00



Paratacco in alluminio
Aluminium heel guards

FTR418SIL € 42,00



Paratacco in carbonio
Carbon heel guards

FTR470 € 39,50



Paratacco in carbonio
Carbon heel guards

FTR471 € 39,50



Paratacco in magnesio
Magnesium heel guards

FTR468NER € 23,00



Paratacco in magnesio
Magnesium heel guards

FTR469NER € 23,00



Puntalino snodato
Folding front toe peg
RFTR154 € 34,00



Puntalino snodato
Folding front toe peg
RFTR156 € 34,00



Puntalino
Front toe peg
RFTR52 € 15,00

Aluminium



Puntalino snodato
Folding front toe peg
RFTR213SIL € 36,00

Aluminium



Puntalino snodato
Folding front toe peg
RFTR214SIL € 36,00



Supporto puntalino
Toe peg holder
FTR290 € 9,00

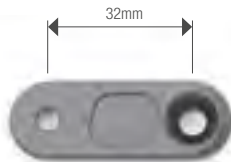

Supporto puntalino
Toe peg holder
FTR799 € 15,00



Millerighe
Gear shift arm
FTR236 € 29,00



Millerighe
Gear shift arm
FTR429 € 29,00



Uniball
Mas M6 dx
Mas M6 sx
VAR1036
VAR1077 € 8,50



Uniball
Fem M6 dx
Fem M6 sx
VAR1095
VAR1076 € 8,50

COMPONENTI RICAMBIO PER PEDANE

64 REAR SET SPARE PARTS



Interruttore stop idraulico (M10 x 1,25)
Hydraulic stop switch (M10 x 1,25)

RFTR93 € 14,50



Interruttore stop idraulico (M10 x 1)
Hydraulic stop switch (M10 x 1)

RFTR128 € 14,50

Alluminio - Aluminium

€ 16,00

- mm 100 FTR741
- mm 110 FTR734
- mm 120 FTR742
- mm 130 FTR495
- mm 140 FTR518
- mm 155 FTR 75
- mm 165 FTR 252
- mm 180 FTR 184
- mm 190 FTR 62
- mm 197 FTR 97
- mm 205 FTR 163
- mm 220 FTR 238
- mm 240 FTR 32



Inox - Stainless Steel

€ 16,00

- mm 85 FTR 669
- mm 100 FTR 666
- mm 130 FTR 644
- mm 145 FTR 546
- mm 165 FTR 329
- mm 175 FTR 228
- mm 190 FTR 56



**POGGIAPIEDI PER
PEDANE ORIGINALI**
FOOTPEGS FOR
ORIGINAL REAR SETS



POGGIAPIEDI PER PEDANE ORIGINALI

66 FOOTPEGS FOR ORIGINAL REAR SETS



- rosso
red
- cobalto
cobalt
- nero
black
- oro
gold

Poggiapiedi per pedane originali Footpegs for original rear sets	FTP001	a coppia - for pair € 50,00
---	--------	---------------------------------------

Necessitano di adattatori specifici
Specific adaptors required

Modello - Model	Anno - Year	Codice - Code	Codice - Code	€
				
		anteriore - front	posteriore - rear	a coppia - for pair

BMW					
R Nine-T /Scrambler/Pure/Urban/Racer	16	18	-	FTP029	29,00
S1000RR	15	18	FTP025	FTP026	29,00

HONDA					
CB 125R	18	20	FTP012	FTP007	29,00
CB 600 HORNET	07	13	FTP012	FTP007	29,00
CB 650 F	14	18	FTP012	FTP007	29,00
CB1000R/ABS	08	17	FTP002	FTP007	29,00
CB1000R	18	18	FTP012	FTP007	29,00
CBR600F	11	14	FTP012	FTP007	29,00
CBR600RR/ABS	03	16	FTP002	FTP007	29,00
CBR1000RR	04	13	FTP002	FTP007	29,00
INTEGRA	15	17	-	FTP007	29,00

Modello - Model	Anno - Year		Codice - Code		€
			anteriore - front	posteriore - rear	
KAWASAKI					
ER6 F/N	06	08	FTP003	FTP009	29,00
Z650	17	20	FTP031	FTP009	29,00
Z750/R	04	12	FTP003	FTP009	29,00
Z800	13	16	FTP003	FTP009	29,00
Z900	17	20	FTP031	FTP009	29,00
Z1000	03	09	FTP003	FTP009	29,00
Z1000	10	19	FTP004	FTP009	29,00
Z1000SX	11	17	FTP003	FTP009	29,00
ZX6-R	05	06	FTP003	FTP009	29,00
ZX6-R	07	20	FTP004	FTP009	29,00
ZX10R	08	10	FTP004	FTP009	29,00
ZX10R	11	20	-	FTP009	29,00
MV					
BRUTALE 675/800	12	16	FTP014	FTP015	29,00
BRUTALE 920	10	11	FTP014	FTP015	29,00
BRUTALE 1090-R/RR/CORSA	12	13	FTP014	FTP015	29,00
DRAGSTER	14	16	FTP014	FTP015	29,00
F3 675/800/AGO	12	18	FTP014	FTP015	29,00
F4-S/R/RR	13	18	FTP014	FTP015	29,00
RIVALE	14	16	FTP014	FTP015	29,00
STRADALE	15	16	FTP014	FTP015	29,00
SUZUKI					
B-KING	08	10	FTP005	FTP008	29,00
GSR600	06	10	FTP005	FTP008	29,00
GSR750	11	16	FTP005	FTP008	29,00
GSZ1300 HAYABUSA	08	14	FTP005	FTP008	29,00
GSX- R600	08	17	FTP005	FTP008	29,00
GSX- R750	08	17	FTP005	FTP008	29,00
GSX- R1000	09	20	FTP005	FTP008	29,00
GSX- S125	17	20	FTP005	FTP008	29,00
GSX-S 750	17	20	FTP005	FTP008	29,00
GSX-S 1000	15	20	FTP005	FTP008	29,00
SFV 650 Gladius	09	14	FTP005	FTP008	29,00
TRIUMPH					
SPEED TRIPLE/R	11	19	FTP010	FTP030	29,00
STREET TRIPLE/R / DAYTONA	11	19	FTP010	FTP030	29,00
YAMAHA					
FZ1/Fazer	06	12	-	FTP022	29,00
FZ8/Fazer	11	13	-	FTP022	29,00
MT03	16	17	FTP019	-	29,00
MT-07	14	20	FTP019	FTP022	29,00
MT09	14	20	FTP019	FTP022	29,00
MT10	16	20	FTP019	FTP022	29,00
T-MAX	03	20	-	FTP022	29,00
YZF-R1	09	14	-	FTP021	29,00
YZF-R1	15	20	FTP027	FTP028	29,00
YZF-R3	15	20	-	FTP022	29,00
YZF-R6	06	20	FTP016	FTP021	29,00

**BORN
TO BE
MOTO**



TENDICATENA
CHAIN ADJUSTER



RAPIDO E PRECISO / FAST AND ACCURATE

Permette uno spostamento di 0,25mm ad ogni click
To adjust simply turn the small adjuster by hand:
1 click = 0.25mm

Regolazione esterna a vite per una regolazione veloce e precisa
External bolt allows precise adjustment first time every time

Scala graduata incisa al laser
Metric scale is stamped into the alloy



Realizzati in ergal 7075
CNC machined from billet Ergal 7075

Forchetta disponibile come optional per l'utilizzo di cavalletti a rulli
Lifters (supplied as option) allows you to use spool-type rear stands for a more secure lift



COLORI DISPONIBILI / AVAILABLE COLOURS



oro
gold

cobalto
cobalt

nero
black

rosso
red

verde
green

Modello - Model	Anno - Year	Codice - Code	€
a coppia - for pair			
APRILIA			
RSV4 R / factory / APRC	09 14	TEAP001	191,00
RSV4 R / RF	15 20	TEAP002	206,00
RSV4 1100 Factory	19 20	TEAP002	206,00
TUONO V4	11 14	TEAP001	191,00
TUONO V4	15 20	TEAP002	206,00
BMW			
S1000 R	14 19	TEBM002	206,00
S1000 RR	09 18	TEBM002	206,00
S1000 RR	19 20	TEBM003	206,00
HONDA			
CBR 600RR	07 17	TEH0002	206,00
CBR 1000RR	08 16	TEH0002	206,00
XADV	17 20	TEH0003	206,00
KAWASAKI			
Z900	17 20	TEKA004	206,00
ZX6R / 636	09 20	TEKA005	206,00
ZX10R	11 15	TEKA003	206,00
ZX10R	16 20	TEKA002	206,00
SUZUKI			
GSX-R 600 / 750	11 17	TESU004	206,00
GSX-R 1000	09 16	TESU006	206,00
GSX-R 1000 / R	17 20	TESU002	206,00
GSX-S 1000	15 20	TESU005	206,00

FORCHETTE TENDITORI CATENA

72 LIFTERS FOR CHAIN ADJUSTERS

Modello - Model		Anno - Year		Codice - Code	€	
					a coppia - for pair	
YAMAHA						
MT-09		■ ■	13	16	TEYA002	191,00
MT09 Tracer / XSR900		■ ■	13	20	TEYA002	191,00
MT-10		■ ■ ■ ■	16	20	TEYA003	206,00
R1		■ ■ ■ ■	09	14	TEYA004	206,00
R1		■ ■ ■ ■	15	19	TEYA003	206,00
R1		■ ■ ■ ■	20	20	TEYA005	206,00
R6		■ ■ ■ ■	06	16	TEY608	161,00
R6		■ ■ ■ ■	17	20	TEYA006	206,00
R6	Con supporto pinza integrato Brake caliper support integrated	■ ■	17	20	TEYA008	250,00
T-MAX 530 - 560		■ ■ ■ ■	12	20	TEYA001	186,00

NEW!

TENDICATENA CON SUPPORTO PINZA FRENO CHAIN ADJUSTER WITH BRAKE CALIPER SUPPORT

FOR RACING USE ONLY

YAMAHA R6 (2017-2020)

NEW!

TEYA008

€ 250,00

Supporto pinza freno
Brake caliper support



YAMAHA R6 (2006-2016)

TEY608

€ 161,00





I VANTAGGI DELLA FORCHETTA RACING

1. Innesto rapido del cavalletto
2. Evita rotture del forcellone in caso di scivolate
3. Impiegando il cavalletto a rulli, si evitano graffi accidentali

THE ADVANTAGES OF RACING LIFTER

1. Quick lift for rear stand use.
2. Avoid damage for swingarm in case of slide.
3. Avoid scratches if used with rear stand with rollers

Modello Model	Colore Colors	Anno Year		Codice Code	€	Compatibile con Compatible with
a coppia - for pair						
APRILIA						
RSV4 R / FACTORY / APRC	■	09	14	FTEAP001	37,00	TEAP001
RSV4 R / RF	■	15	20	FTEAP002	61,00	TEAP002
TUONO V4	■	11	14	FTEAP001	37,00	TEAP001
BMW						
S1000 RR / S1000R	■	09	18	FTEBM002	50,00	TEBM002
BMW S1000 RR	■	19	20	FTEBM003	61,00	TEBM003
HONDA						
CBR 600 RR	■	07	17	FTEH002	50,00	TEH002
CBR 1000 RR	■	06	16	FTEH002	50,00	TEH002
KAWASAKI						
ZX6R	■	09	20	FTEKA005	50,00	TEKA005
ZX10R	■	11	15	FTEKA003	61,00	TEKA003
ZX10R	■	16	20	FTEKA007	61,00	TEKA002
SUZUKI						
GSXR 1000	■	17	20	FTESU002	61,00	TESU002
YAMAHA						
R1	■	09	14	FTEYA004	50,00	TEYA004
R1	■	15	19	FTEYA003	50,00	TEYA003
R1	■	20	20	FTEYA005	61,00	TEYA005
R6	■	17	20	FTEYA006	61,00	TEYA006

NEW!



NEW DESIGN, SMART PLUG

- Nuovi supporti cavalletto
- Disponibili in tutte le combinazioni colore
- Ottimizzazione degli stock grazie all'intercambiabilità del CAP001 tra SCV001-002 e KTM serie 400 (vedi pag. 100)
- New swing arm spoils
- Available in all color combinations
- Stock optimization thanks to the interchangeability of the CAP001 between SCV001-002 and KTM 400 series (see page 100)

Compatibile con nuova serie **KTM 400**
Interchangeable cap with the new **KTM400** series

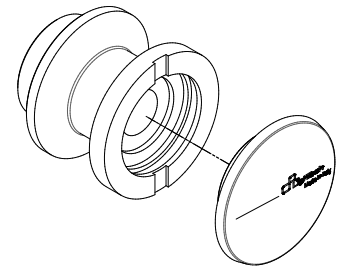

Misura - Measure	Modello - Model		Codice - Code	€
				a coppia - for pair
M6	Yamaha, Aprilia, Triumph, Panigale 899-959	■	SCV001	12,00
M8	Suzuki, Honda, Bmw, Kawasaki, Triumph 675-765	■	SCV002	12,00

* Verificare compatibilità / Always check compatibility



- rosso red
- cobalto cobalt
- nero black
- oro gold
- silver plata
- green verde
- arancione orange

		Codice - Code	€
			a coppia - for pair
Tappo per SCV Cap for SCV	■ ■ ■ ■ ■ ■ ■	CAP001	11,00

rosso
redverde
greennero
blackoro
goldcobalto
cobaltsilver
silver

Misura - Measure	Codice - Code	€
		a coppia - for pair
M6	CAVM6 (Aprilia* / Ducati Panigale 899 / Triumph* / Yamaha*)	17,00
M8	CAVM8 (BMW* / Honda* / Kawasaki* / Suzuki* /Triumph 675/13)	17,00
M10 X 1,50	CAVM1015 (KTM*)	19,00
M10 x 1,25	CAVM10 (Kawasaki*)	19,00

*Verificare compatibilità / Always check compatibility



SUPPORTI PER CAVALLETTI

76 SWING ARM SPOOLS



FINE SERIE - END STOCK

Misura - Measure	Codice - Code	€
		a coppia - for pair
M6	CAVM6W (Aprilia* / Triumph* / Yamaha*)	24,00
M8	CAVM8W (BMW* / Honda* / Kawasaki* / Suzuki*)	24,00
M10 X 1,25	CAVM10W (Kawasaki*)	24,00

*Verificare compatibilità / Always check compatibility



■ silver
silver

a coppia - for pair

	Codice - Code	€
Forchetta per Kawasaki ZX10R (2016→)	FTEKA006	46,00
Paddock stand fork for Kawasaki ZX10R (2016→)		



■ nero black
■ cobalto cobalt
■ rosso red

a coppia - for pair

	Codice - Code	€
Forchetta per Yamaha R1 (2015→) / MT10 (2016→) / R6 (2017→)	FTEYA007	59,00
Paddock stand fork for Yamaha R1 (2015→) / MT10 (2016→) / R6 (2017→)		





DUCATI

FINALE V4

LEVE
LEVERS

KIT LEVA - LEVER KIT

- Realizzate in magnesio per ridurre il peso
- Versione "Alien" per un miglior grip
- 100% Made in Italy
- Magnesium levers to reduce weight
- "Alien" version for better grip
- 100% Made in Italy

GRIP INNOVATION

ALIEN
GRIP



con inserti in gomma
with rubber inserts



Extra grip
100% Made in Italy
Final Code: ___K

Extra light
100% Made in Italy
Final Code: ___J



Colori disponibili: nero. Available colours: black

Modello - Model	Anno - Year		Codice - Code	€	Codice - Code	€
						
APRILIA						
RSV1000	04	09	KLEV100J	177,00	KLEV100K	192,00
RSV4 R / Factory /APRC	09	20	KLEV101J	166,00	KLEV101K	181,00
RSV4 1100 Factory	19	20	KLEV101J	166,00	KLEV101K	181,00
BMW						
S1000 R	14	19	KLEV102J	166,00	KLEV102K	181,00
S1000 RR	09	14	KLEV103J	166,00	KLEV103K	181,00
S1000 RR	15	18	KLEV102J	166,00	KLEV102K	181,00
S1000 RR	19	20	KLEV120J	177,00	KLEV120K	192,00
DUCATI						
749-999	02	06	KLEV104J	177,00	KLEV104K	192,00
848-1098-1198	07	11	KLEV104J	177,00	KLEV104K	192,00
Diavel	11	18	KLEV104J	177,00	KLEV104K	192,00
Monster 1100	10	13	KLEV104J	177,00	KLEV104K	192,00
Monster 1200 / R	14	20	KLEV104J	177,00	KLEV104K	192,00
Panigale 899 / 959 / 1199 / 1299 / V4 / V2	12	20	KLEV104J	177,00	KLEV104K	192,00
Streetfighter 848 / 1100	09	16	KLEV104J	177,00	KLEV104K	192,00
Streetfighter V4	20	20	KLEV104J	177,00	KLEV104K	192,00
HONDA						
CB 1000 R	08	17	KLEV110J	177,00	KLEV110K	192,00
CB 1000 R	18	20	KLEV109J	166,00	KLEV109K	181,00
CBR 600 RR	07	17	KLEV109J	166,00	KLEV109K	181,00
CBR 1000 RR	04	07	KLEV110J	177,00	KLEV110K	192,00
CBR 1000 RR	08	19	KLEV109J	166,00	KLEV109K	181,00
KAWASAKI						
Ninja 250	08	13	KLEV117J	160,00	KLEV117K	175,00
Ninja 300	14	17	KLEV117J	160,00	KLEV117K	175,00
Ninja 400	18	20	KLEV117J	160,00	KLEV117K	175,00
Z650	17	20	KLEV046J	160,00	KLEV046K	175,00
Z750	07	12	KLEV027J	160,00	KLEV027K	175,00
Z750 R	11	12	KLEV029J	160,00	KLEV029K	175,00
Z800	13	16	KLEV027J	160,00	KLEV027K	175,00
Z900	17	20	KLEV046J	160,00	KLEV046K	175,00
Z1000	07	16	KLEV029J	160,00	KLEV029K	175,00
Z1000	17	19	KLEV119J	160,00	KLEV119K	175,00
Z1000 SX	11	16	KLEV029J	160,00	KLEV029K	175,00
Z1000 SX	17	19	KLEV119J	166,00	KLEV119K	181,00
ZX6R / ZX636	05	18	KLEV105J	166,00	KLEV105K	181,00
ZX636	19	20	KLEV119J	166,00	KLEV119K	181,00
ZX10R	06	15	KLEV105J	166,00	KLEV105K	181,00
ZX10R	16	19	KLEV108J	166,00	KLEV108K	181,00
KTM						
DUKE 790	18	20	KLEV118J	177,00	KLEV118K	192,00
MV						
F3 675	12	20	KLEV114J	166,00	KLEV114K	181,00
F3 800	13	20	KLEV114J	166,00	KLEV114K	181,00

Modello - Model	Anno - Year		Codice - Code	€	Codice - Code	€
			 J		 K	
SUZUKI						
GSXR 600 / 750	06	17	KLEV113J	166,00	KLEV113K	181,00
GSXR 1000	05	06	KLEV113J	166,00	KLEV113K	181,00
GSXR 1000	09	20	KLEV113J	166,00	KLEV113K	181,00
GSXS 1000	15	20	KLEV113J	166,00	KLEV113K	181,00
TRIUMPH						
Daytona 675	06	12	KLEV032J	160,00	KLEV032K	175,00
Daytona 675 R	11	16	KLEV111J	166,00	KLEV111K	181,00
Street Triple 675 R	08	16	KLEV032J	160,00	KLEV032K	175,00
Street Triple 765 RS	17	19	KLEV111J	166,00	KLEV111K	181,00
Speed Triple 1050 / 1050 R	08	10	KLEV032J	160,00	KLEV032K	175,00
Speed Triple 1050 / 1050 R	11	16	KLEV111J	166,00	KLEV111K	181,00
YAMAHA						
FZ6 / Fazer	04	12	KLEV115J	160,00	KLEV115K	175,00
FZ8	10	16	KLEV115J	160,00	KLEV115K	175,00
FZ1 / Fazer	06	16	KLEV115J	160,00	KLEV115K	175,00
MT-07	14	20	KLEV115J	160,00	KLEV115K	175,00
MT-09	13	20	KLEV115J	160,00	KLEV115K	175,00
MT-10	16	20	KLEV115J	160,00	KLEV115K	175,00
R3	15	20	KLEV121J	160,00	KLEV121K	175,00
R6	05	16	KLEV107J	166,00	KLEV107K	181,00
R6	17	20	KLEV045J	166,00	KLEV045K	181,00
R1	04	14	KLEV107J	166,00	KLEV107K	181,00
R1 / R1-M	15	20	KLEV045J	166,00	KLEV045K	181,00
T-MAX 500 – 530 – 50	08	20	KLEV116	166,00	KLEV116K	181,00
XJ6	09	16	KLEV115J	160,00	KLEV115K	175,00



YAMAHA R1 (2020)



Molla di ritorno
Recovery spring

Bussola in ERGAL anodizzata rossa
CNC aluminium bush red-anodized

Colori disponibili: nero. Available colours: black

Modello - Model	Anno - Year	Codice - Code	€	Codice - Code	€
-----------------	-------------	---------------	---	---------------	---



BREMBO

* BREMBO (16 x 18) (19 x 18)			LEVD502J	74,00	LEVD502K	81,50
* BREMBO (19 x 20)			LEVD503J	74,00	LEVD503K	81,50

APRILIA

RSV1000	04	09	LEVD121J	98,00	LEVD121K	105,50
RSV4 R / factory /APRC	09	20	LEVD121J	98,00	LEVD121K	105,50
RSV4 1100 Factory	19	20	LEVD121J	98,00	LEVD121K	105,50

BMW

S1000 R	14	19	LEVD126J	98,00	LEVD126K	105,50
S1000 RR	09	20	LEVD126J	98,00	LEVD126K	105,50

DUCATI

749-999	02	06	LEVD110J	98,00	LEVD110K	105,50
848-1098-1198	07	11	LEVD110J	98,00	LEVD110K	105,50
Diavel	11	18	LEVD110J	98,00	LEVD110K	105,50
Monster 1100	10	13	LEVD110J	98,00	LEVD110K	105,50
Monster 1200	14	20	LEVD110J	98,00	LEVD110K	105,50
Panigale 899 / 959	13	20	LEVD110J	98,00	LEVD110K	105,50
Panigale 1199 / 1299 / V4 / V2	12	20	LEVD110J	98,00	LEVD110K	105,50
Streetfighter 848 / 1100	09	16	LEVD110J	98,00	LEVD110K	105,50
Streetfighter V4	20	20	LEVD110J	98,00	LEVD110K	105,50





ONLY FOR BREMBO MODELS

* LEV502



* LEV503



Per il montaggio sono necessari i componenti originali della leva Brembo
For the fitment, OEM Brembo components required

Modello - Model	Anno - Year		Codice - Code	€	Codice - Code	€
			 J		 K	
HONDA						
CB 1000 R	08	20	LEVD128J	98,00	LEVD128K	105,50
CBR 600 RR	07	17	LEVD128J	98,00	LEVD128K	105,50
CBR 1000 RR	04	19	LEVD128J	98,00	LEVD128K	105,50
KAWASAKI						
NINJA 250	08	13	LEVD125J	98,00	LEVD125K	105,50
Ninja 300	14	17	LEVD125J	98,00	LEVD125K	105,50
Ninja 400	18	20	LEVD125J	98,00	LEVD125K	105,50
Z 650	17	20	LEVD011J	98,00	LEVD011K	105,50
Z750	07	12	LEVD011J	98,00	LEVD011K	105,50
Z750 R	11	12	LEVD009J	98,00	LEVD009K	105,50
Z 800	13	16	LEVD011J	98,00	LEVD011K	105,50
Z 900	17	20	LEVD011J	98,00	LEVD011K	105,50
Z1000	07	16	LEVD009J	98,00	LEVD009K	105,50
Z1000 SX	11	16	LEVD009J	98,00	LEVD009K	105,50
Z1000 SX	17	20	LEVD124J	98,00	LEVD124K	105,50
ZX6R / ZX 636	05	20	LEVD124J	98,00	LEVD124K	105,50
ZX10R	06	15	LEVD124J	98,00	LEVD124K	105,50
ZX10R	16	20	LEVD127J	98,00	LEVD127K	105,50
KTM						
DUKE 790	18	20	LEVD132J	98,00	LEVD132K	105,50
MV						
F3 675	12	20	LEVD123J	98,00	LEVD123K	105,50
F3 800	13	20	LEVD123J	98,00	LEVD123K	105,50
SUZUKI						
GSXR 600 / 750	04	17	LEVD123J	98,00	LEVD123K	105,50
GSXR 1000	05	20	LEVD123J	98,00	LEVD123K	105,50
GSXS 1000	15	20	LEVD123J	98,00	LEVD123K	105,50
TRIUMPH						
Daytona 675	06	12	LEVD009J	98,00	LEVD009K	105,50
Daytona 675 R	09	16	LEVD121J	98,00	LEVD121K	105,50
Street Triple 675 R	08	16	LEVD009J	98,00	LEVD009K	105,50
Street Triple 765 R	17	19	LEVD121J	98,00	LEVD121K	105,50
Speed Triple 1050 S	08	10	LEVD009J	98,00	LEVD009K	105,50
Speed Triple 1050 S/ 1050 R	11	16	LEVD121J	98,00	LEVD121K	105,50
YAMAHA						
FZ6 / Fazer	04	16	LEVD130J	98,00	LEVD130K	105,50
FZ1 / Fazer	06	16	LEVD130J	98,00	LEVD130K	105,50
FZ8	10	16	LEVD130J	98,00	LEVD130K	105,50
MT-07	14	20	LEVD130J	98,00	LEVD130K	105,50
MT-09	13	20	LEVD130J	98,00	LEVD130K	105,50
MT-10	16	20	LEVD130J	98,00	LEVD130K	105,50
R6	05	16	LEVD122J	98,00	LEVD122K	105,50
R6	17	20	LEVD118J	98,00	LEVD118K	105,50
R1	04	14	LEVD122J	98,00	LEVD122K	105,50
R1 / R1-M	15	20	LEVD118J	98,00	LEVD118K	105,50
R3	15	20	LEVD120J	98,00	LEVD120K	105,50
XJ6	09	16	LEVD130J	98,00	LEVD130K	105,50
T-MAX 500 - 530 - 560 (lato DX)	08	20	LEVD133J	90,00	LEVD133K	97,50
T-MAX 500 - 530 - 560 (lato SX)	08	20	LEVD134J	90,00	LEVD134K	97,50



Colori disponibili: nero. Available colours: black

Modello - Model	Anno - Year		Codice - Code	€	Codice - Code	€
					 J	 K
APRILIA						
RSV1000	04	09	LEVXF107J	86,00	LEVXF107K	93,50
RSV4 R / factory /APRC	09	20	LEVXF001J	75,00	LEVXF001K	82,50
RSV4 1100 Factory	19	20	LEVXF001J	75,00	LEVXF001K	82,50
TUONO V4	11	20	LEVXF001J	75,00	LEVXF001K	82,50
BMW						
BMW S1000 R	14	19	LEVXF015J	75,00	LEVXF015K	82,50
BMW S1000 RR	09	14	LEVXF008J	75,00	LEVXF008K	82,50
BMW S1000 RR	15	18	LEVXF015J	75,00	LEVXF015K	82,50
BMW S1000 RR	19	20	LEVXF020J	86,00	LEVXF020K	93,50
DUCATI						
749-999	02	06	LEVXF107J	86,00	LEVXF107K	93,50
848-1098-1198	07	11	LEVXF107J	86,00	LEVXF107K	93,50
Diavel	11	16	LEVXF107J	86,00	LEVXF107K	93,50
Monster S4R	07	07	LEVXF107J	86,00	LEVXF107K	93,50
Monster 1100	10	13	LEVXF107J	86,00	LEVXF107K	93,50
Monster 1200	14	20	LEVXF107J	86,00	LEVXF107K	93,50
Panigale 899 / 959	13	20	LEVXF107J	86,00	LEVXF107K	93,50
Panigale 1199 / 1299 / V4 / V2	12	20	LEVXF107J	86,00	LEVXF107K	93,50
Streetfighter 848 / 1100	09	16	LEVXF107J	86,00	LEVXF107K	93,50
Streetfighter V4	20	20	LEVXF107J	86,00	LEVXF107K	93,50
HONDA						
CB 1000 R	08	17	LEVXF003J	86,00	LEVXF003K	93,50
CB 1000 R	18	20	LEVXF002J	75,00	LEVXF002K	82,50
CBR 600 RR	03	17	LEVXF002J	75,00	LEVXF002K	82,50
CBR 1000 RR	04	07	LEVXF003J	86,00	LEVXF003K	93,50
CBR 1000 RR	08	20	LEVXF002J	75,00	LEVXF002K	82,50

Modello - Model	Anno - Year	Codice - Code	€	Codice - Code	€
			 J	 K	
KAWASAKI					
Ninja 250	08	13	LEVXF019J	75,00	LEVXF019K 82,50
Ninja 300	14	17	LEVXF019J	75,00	LEVXF019K 82,50
Ninja 400	18	20	LEVXF019J	75,00	LEVXF019K 82,50
Z650	17	20	LEVXF005J	75,00	LEVXF005K 82,50
Z750	07	12	LEVXF004J	75,00	LEVXF004K 82,50
Z800	13	16	LEVXF004J	75,00	LEVXF004K 82,50
Z900	17	20	LEVXF005J	75,00	LEVXF005K 82,50
Z1000	07	16	LEVXF004J	75,00	LEVXF004K 82,50
Z1000 SX	11	16	LEVXF004J	75,00	LEVXF004K 82,50
ZX6R – 636	05	20	LEVXF004J	75,00	LEVXF004K 82,50
ZX636	18	20	LEVXF005J	75,00	LEVXF005K 82,50
ZX10R	06	20	LEVXF004J	75,00	LEVXF004K 82,50
KTM					
DUKE 790	18	20	LEVXF109J	86,00	LEVXF109K 93,50
MV					
F3 675	12	20	LEVXF012J	75,00	LEVXF012K 82,50
F3 800	13	20	LEVXF012J	75,00	LEVXF012K 82,50
SUZUKI					
GSXR 600 / 750	06	17	LEVXF001J	75,00	LEVXF001K 82,50
GSXR 1000	05	06	LEVXF001J	75,00	LEVXF001K 82,50
GSXR 1000	09	20	LEVXF001J	75,00	LEVXF001K 82,50
GSXS 1000	15	20	LEVXF001J	75,00	LEVXF001K 82,50
TRIUMPH					
Daytona 675	06	14	LEVXF018J	75,00	LEVXF018K 82,50
Daytona 675R	11	16	LEVXF018J	75,00	LEVXF018K 82,50
Street Triple 675 R	08	19	LEVXF018J	75,00	LEVXF018K 82,50
Speed Triple 1050 S/ 1050R	11	16	LEVXF018J	75,00	LEVXF018K 82,50
YAMAHA					
FZ6 / Fazer	04	16	LEVXF001J	75,00	LEVXF001K 82,50
FZ8	10	16	LEVXF001J	75,00	LEVXF001K 82,50
FZ1 / Fazer	06	16	LEVXF001J	75,00	LEVXF001K 82,50
MT-07	14	20	LEVXF001J	75,00	LEVXF001K 82,50
MT-09	13	20	LEVXF001J	75,00	LEVXF001K 82,50
MT-10	16	20	LEVXF001J	75,00	LEVXF001K 82,50
R3	15	20	LEVXF021J	75,00	LEVXF021K 82,50
R6	00	20	LEVXF001J	75,00	LEVXF001K 82,50
R1 / R1-M	00	20	LEVXF001J	75,00	LEVXF001K 82,50
XJ6	09	16	LEVXF001J	75,00	LEVXF001K 82,50



Interassi da 30 / 32 / 34 mm.
Il sistema di chiusura del bracciale è ancor più veloce, grazie alla fascetta di chiusura con il sistema a cerniera.

Wheelbases from 30 / 32 / 34 mm, the closing system of the joint is even faster thanks to the closing strap with the hinge system.



NEW LOOK, BEST COMFORT

Nuova leva frizione ad interasse variabile con leva reclinabile. Nata per un uso prettamente racing consente di variare l'interasse di azionamento.

Questa particolarità consente al pilota di poter gestire lo stacco della frizione. Il pilota può perfezionare le partenze, e personalizzare la corsa della leva.

New folding clutch lever with variable wheelbase. Born for a race use, it allows you to vary the drive wheelbase.



With this updating, the driver can manage the clutch release, that means that the driver can perfect the starts and customize the lever stroke.



Colori disponibili: nero. Available colours: black

Modello - Model	Codice - Code	€	Codice - Code	€
FOR RACING USE ONLY				
	LEVXF100J	152,00	LEVXF100K	159,50
Leva frizione a cavo completa di bracciale ad interasse variabile Cable clutch lever with variable wheelbase				



Colori disponibili: nero. Available colours: black

Modello - Model	Anno - Year		Codice - Code	€	Codice - Code	€
			 J		 K	
BREMBO						
* BREMBO (16 x 18) (19 x 18)			LEVS502J	130,00	LEVS502K	137,50
* BREMBO (19 x 20)			LEVS503J	130,00	LEVS503K	137,50
APRILIA						
RSV1000	04	09	LEVS121J	178,00	LEVS121K	185,50
RSV4 R / Factory /APRC	09	20	LEVS121J	178,00	LEVS121K	185,50
RSV4 1100 Factory	19	20	LEVS121J	178,00	LEVS121K	185,50
BMW						
S1000 RR	09	20	LEVS126J	178,00	LEVS126K	185,50
DUCATI						
749-999	02	06	LEVS110J	178,00	LEVS110K	185,50
848-1098-1198	07	12	LEVS110J	178,00	LEVS110K	185,50
Panigale 1199	12	15	LEVS110J	178,00	LEVS110K	185,50
Panigale 1299	15	17	LEVS110J	178,00	LEVS110K	185,50
Panigale V4 / V2	18	20	LEVS110J	178,00	LEVS110K	185,50
HONDA						
CBR 600 RR	07	16	LEVS128J	178,00	LEVS128K	185,50
CBR 1000 RR	04	19	LEVS128J	178,00	LEVS128K	185,50
KAWASAKI						
ZX6R	05	20	LEVS124J	178,00	LEVS124K	185,50
ZX10R	06	15	LEVS124J	178,00	LEVS124K	185,50
ZX10R	16	20	LEVS127J	178,00	LEVS127K	185,50
MV						
F3 675	12	20	LEVS123J	178,00	LEVS123K	185,50
F3 800	13	20	LEVS123J	178,00	LEVS123K	185,50

Modello - Model	Anno - Year		Codice - Code	€	Codice - Code	€
			 J		 K	
SUZUKI						
GSXR 600 / 750	04	17	LEVS123J	178,00	LEVS123K	185,50
GSXR 1000	05	20	LEVS123J	178,00	LEVS123K	185,50
TRIUMPH						
Daytona 675	06	12	LEVS009J	178,00	LEVS009K	185,50
Daytona 675 R	09	16	LEVS121J	178,00	LEVS121K	185,50
YAMAHA						
R6	05	16	LEVS122J	178,00	LEVS122K	185,50
R6	17	20	LEVS118J	178,00	LEVS118K	185,50
R1	04	14	LEVS122J	178,00	LEVS122K	185,50
R1 / R1-M	15	20	LEVS118J	178,00	LEVS118K	185,50

KIT INSERTI IN GOMMA PER LEVA "ALIEN"

RUBBER INSERTS KIT FOR "ALIEN" LEVER



- rosso / red
- blu / blue
- nero / black
- bianco / white
- green / verde
- arancione / orange

Modello - Model	Codice - Code	Codice - Code	Codice - Code	Codice - Code	Codice - Code	Codice - Code	€
							
Kit inserti in gomma per leva "Alien" (una striscia) Rubber inserts kit for "Alien" lever (one strip)	GM001ROS	GM001VER	GM001BLU	GM001NER	GM001BIA	GM001ARA	4,00



LEVA IN MAGNESIO
MAGNESIUM LEVER

RLEV001J € 47,00

Colori disponibili: nero. Available colours: black



LEVA IN MAGNESIO
MAGNESIUM LEVER

RLEV001K € 54,50

Colori disponibili: nero. Available colours: black



REGISTRO LEVA FRENO · con supporto
REMOTE BRAKE ADJUSTER · with mounting clamp

RLEV015 € 88,00



CAVI DI REGOLAZIONE
CABLES FOR REMOTE ADJUSTER

A (M7)	RLEV008	€ 17,00
B	RLEV014	€ 17,00
C	RLEV009	€ 17,00
D (M6)	RLEV017	€ 17,00





**BRACCIALI MANUBRIO
CLIP-ONS**

BRACCIALI MANUBRIO

90 CLIP-ONS

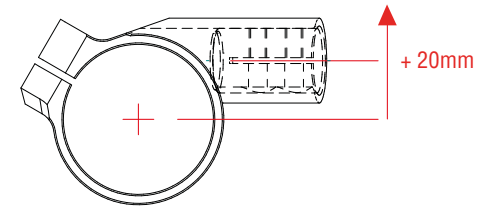

Bracciali manubrio con offset +20mm
Clip-ons with +20mm offset

Colori disponibili: nero. Available colours: black

Ø	Altezza - Height	° Inclinazione gradi - ° Inclination grade	Offset - Offset	Codice - Code	€
					a coppia - for pair
NEW! Ø 41	+/- 0mm	10°	+ 20mm	MOZ4101	140,00
Ø 47	+/- 0mm	10°	+ 20mm	MOZ4701	140,00
Ø 50	+/- 0mm	10°	+ 20mm	MOZ5001	140,00
Ø 51	+/- 0mm	10°	+ 20mm	MOZ5101	140,00
Ø 52	+/- 0mm	10°	+ 20mm	MOZ5201	140,00
NEW! Ø 53	+/- 0mm	10°	+ 20mm	MOZ5301	140,00
Ø 54,5	+/- 0mm	10°	+ 20mm	MOZ5401	140,00
Ø 55	+/- 0mm	10°	+ 20mm	MOZ5501	140,00

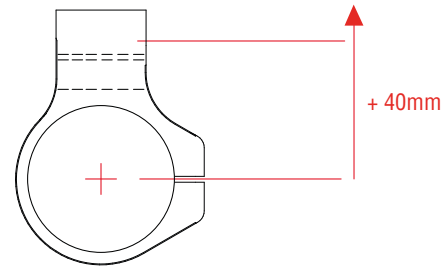

Bracciali manubrio con offset +40mm
Clip-ons with +40mm offset

Colori disponibili: nero. Available colours: black

Ø	Altezza - Height	° Inclinazione gradi - ° Inclination grade	Offset - Offset	Codice - Code	€
					a coppia - for pair
NEW! Ø 47	+/- 0mm	10°	+ 40mm	MOZ4710	172,00
Ø 48	+/- 0mm	10°	+ 40mm	MOZ4810	172,00
Ø 50	+/- 0mm	10°	+ 40mm	MOZ5010	172,00
Ø 51	+/- 0mm	5°	+ 40mm	MOZ5110	172,00
Ø 52	+/- 0mm	5°	+ 40mm	MOZ5210	172,00
NEW! Ø 53	+/- 0mm	10°	+ 40mm	MOZ5310	172,00
Ø 54,5	+/- 0mm	10°	+ 40mm	MOZ5410	172,00
Ø 55	+/- 0mm	5°	+ 40mm	MOZ5510	172,00

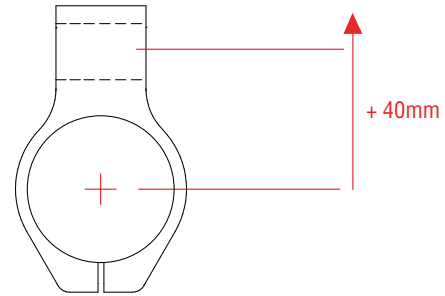

Bracciali manubrio con offset +40mm
Clip-ons with +40mm offset

Colori disponibili: nero. Available colours: black

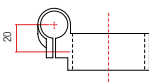
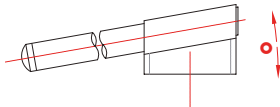
Ø	Altezza - Height	° Inclinazione gradi - ° Inclination grade	Offset - Offset	Codice - Code	€
					
					a coppia - for pair
Ø 47	+20mm	10°	+ 40mm	MOZ4720	182,00
Ø 48	+20mm	10°	+ 40mm	MOZ4820	182,00
Ø 50	+20mm	10°	+ 40mm	MOZ5020	182,00
Ø 55	+20mm	5°	+ 40mm	MOZ5520	182,00

NEW!

APPLICAZIONI MOZZETTI - CLIP-ONS APPLICATION LIST

Anno - Years

diametro - diameter

Model	Year	Year	Diameter	
APRILIA	RSV 1000	00	05	51
	RSV 1000 / Factory	06	09	50
	RSV4 R / RR	09	19	50
	RSV4 Factory / APRC / RF	09	18	51
	RSV4 1100 Factory	19	19	51
BMW	S 1000 RR	09	19	55
DUCATI	748-749-916-998-999	94	06	53
	848 / 1098 / 1198	07	11	53
	PANIGALE V4	18	19	53
HONDA	CBR 600 RR	07	16	48
	CBR 1000 RR	04	19	50
KAWASAKI	ZX 400	18	19	41
	ZX 6 R	03	08	50
	ZX 6 R	09	17	51
	ZX 636	09	20	50
	ZX 10 R	04	19	50
MV AGUSTA	F3 675 / 800	12	16	50
SUZUKI	GSXR 600 / 750	06	07	48
	GSXR 600 / 750	08	17	50
	GSXR 1000	05	19	50
TRIUMPH	DAYTONA 675 / 675 R	07	18	50
YAMAHA	R3	19	19	47
	R6	06	19	50
	R1	04	20	50

BRACCIALI MANUBRIO

92 CLIP-ONS



SEMIMANUBRIO - HANDLEBAR TUBES	Codice - Code	€
lunghezza 270 mm - length 270 mm	HBT004	a coppia - for pair 44,00



Bracciali per piastra di sterzo BMW S1000RR 2019

TCB001NER

€ 64,00

Triple clamp bracelets for BMW S1000RR



PROTEZIONI LEVE
LEVERS
GUARDS





ATTENZIONE!

• Ricorda che l'adattatore è assolutamente necessario per poter applicare la protezione leva.

WARNING!

• The adaptor is absolutely necessary to install the lever protection.

NEW!

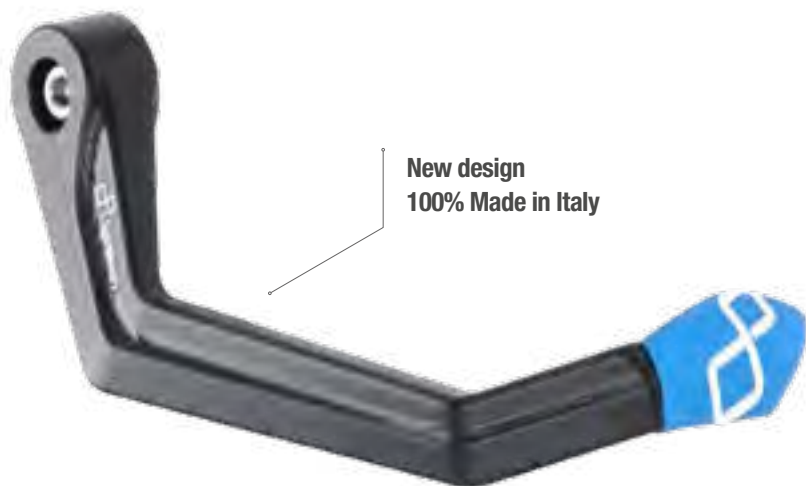

New design
100% Made in Italy

Protezione leva
Lever guard

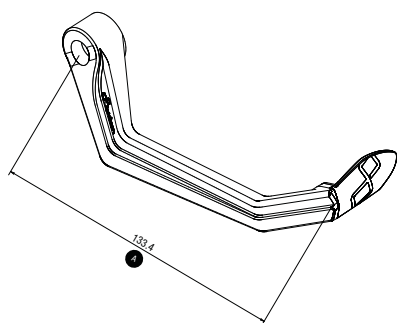

A Verifica sempre la misura
Always check the measurement

Colori disponibili - Available colours:



verde
green

oro
gold

rosso
red

nero
black

silver
silver

cobalto
cobalt

arancione
orange

Descrizione - Description	Codice - Code	€
		a pezzo - for piece
Terminale R / Guard end R	ISS117	39,50
Terminale L / Guard end L	ISS118	39,50

Descrizione - Description	A	Codice - Code	€
			a pezzo - for piece
PROTEZIONI LEVE in alluminio (corpo + terminale, escluso adattatore) / Aluminium lever guards kit (adaptor not included)			
Protezione leva freno / Brake lever guard	132 mm	ISS113RA	106,00
Protezione leva frizione / Clutch lever guard	148 mm	ISS114LA	106,00



Descrizione - Description	A	Codice - Code	€
PROTEZIONI LEVE in carbonio (corpo + terminale, escluso adattatore) / Carbon lever guards kit (adaptor not included)			a pezzo - for piece
Protezione leva freno / brake lever guard	132 mm	ISS115RC	153,00
Protezione leva frizione / clutch lever guard	132 mm	ISS116LC	153,00



ADATTATORI PROTEZIONI LEVE

96 ADAPTORS KITS FOR LEVER GUARDS

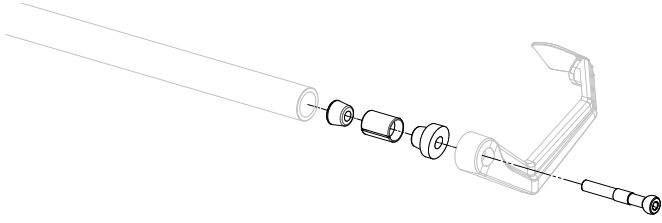

Attenzione! L'adattatore è assolutamente necessario per poter applicare la protezione leva.
Warning! The adaptor is absolutely necessary in order to apply the lever guard.

Descrizione - Description	Anno - Year		Ø	Codice - Code	€
					a pezzo - for piece
diametro interno / Internal diameter: Ø 14 → 15,5 mm				KPL329	24,00
diametro interno / Internal diameter: Ø 16 → 17,5 mm				KPL302	24,00
diametro interno / Internal diameter: Ø 18 → 19,5 mm				KPL319	24,00
APRILIA					
RSV4 (all version)	09	19		KPL303	24,00
RSV1000	04	08		KPL313	24,00
Shiver 750	07	15		KPL313	24,00
Tuono	06	09		KPL313	24,00
Tuono V4	11	19		KPL313	24,00
BMW					
R NINE-T Scrambler / Urban / Racer / Pure	16	16		KPL325	24,00
S1000R	14	18		KPL325	24,00
S1000RR	09	18		KPL325	24,00
S1000RR	19	20		KPL330	24,00
DUCATI					
1098 / 1198	07	11	16/17,5	KPL302	24,00
Monster S4 - ST2	07	07		KPL304	24,00
Monster 821	14	16	17	KPL302	24,00
Monster 1100	11	13	14,5	KPL322	24,00
Panigale 899 / 959 / 1199 / 1299	12	19		KPL318	24,00
Panigale V4	18	19	18	KPL319	24,00
Panigale V2	20	20	18		24,00
Streetfighter 848 / 1100	08	16	14,5	KPL322	24,00
Streetfighter V4	20	20	14,5		24,00
HONDA					
tutte / all		KPL306	24,00
KAWASAKI					
ER-6N	12	15		KPL304	24,00
Ninja 250 / Ninja 400	18	19		KPL304	24,00
Z750	04	12		KPL304	24,00
Z650	17	19		KPL319	24,00
Z800	13	16		KPL304	24,00
Z900	17	19		KPL304	24,00
Z1000	03	16		KPL304	24,00
Z1000 SX	11	16		KPL304	24,00
ZX250R	09	12		KPL304	24,00
ZX6R	03	19		KPL304	24,00
ZX10R	11	19		KPL304	24,00

Descrizione - Description	Anno - Year		Ø	Codice - Code	€
					a pezzo - for piece
KTM					
Duke 125 / 390	17	19		KPL311	24,00
Duke 790	18	19		KPL329	24,00
MV					
BRUTALE 4 cilindri (all version)	10	17	d.16/17,5	KPL302	24,00
B3 675 / 800	12	17		KPL320	24,00
F3 675 / 800	11	17	d.18/19,5	KPL319	24,00
F4 (all version)	10	17	d.18/19,5	KPL323	24,00
SUZUKI					
Gladius 650	09	15		KPL309	24,00
GSR 600	06	11		KPL305	24,00
GSR 750	11	16		KPL305	24,00
GSXR 600 / 750	00	05		KPL305	24,00
GSXR 600 / 750	06	17		KPL309	24,00
GSXR 1000	03	04		KPL305	24,00
GSXR 1000	05	16		KPL309	24,00
GSXR 1000	17	19		KPL327	24,00
GSXS 750	17	19		KPL328	24,00
GSXS 1000	15	19		KPL302	24,00
TRIUMPH					
STREET TRIPLE 675 R	07	12		KPL302	24,00
STREET TRIPLE 675 R	13	17		KPL311	24,00
YAMAHA					
Fazer 600 - FZ6	04	06		KPL310	24,00
Fazer 1000	01	12		KPL310	24,00
MT-07	14	19		KPL310	24,00
MT-09	13	19		KPL310	24,00
MT-10	16	19		KPL310	24,00
R 125	08	17		KPL310	24,00
R1	98	19		KPL311	24,00
R3	15	19		KPL311	24,00
R6	06	19		KPL311	24,00
T Max 500 - 530	02	20		KPL310	24,00
TDM 900	02	08		KPL310	24,00
T-MAX 400	13	19		KPL310	24,00



HONDA X-ADV

Copricatena / Chain cover
cod. CHP001

LightTech

Tendicatena / Chain adjuster
cod. TEH0003

BORN
TO BE
MOTO



**CONTRAPPESI
MANUBRI
HANDLEBAR
BALANCERS**

CONTRAPPESI MANUBRI

HANDLEBAR BALANCERS

NEW DESIGN, SMART PLUG

Ottimizzazione degli stock grazie all'intercambiabilità del CAP001 tra KTM serie 400 e SCV001-002 (vedi pag. 74).

Stock optimization thanks to the interchangeability of the CAP001 between KTM 400 series and SCV001-002 (see page 74).

Nuovi contrappesi manubrio
New handlebar balancers
KTM 400 series



Disponibili in tutte le combinazioni colore
Available in all color combinations
CAP001

NEW!



Kit tappi colorati
Colored caps kit



a kit - for kit

CAP001

€ 11,00

KTM 400 series

Colori disponibili: nero/ Available colours: black

Descrizione - Description	Anno - Year		Misura - measure	Codice - Code	€
	dal - from	al - to			
Universali / Universal			d.12/13/17	KTM400	27,00
APRILIA					
RSV4	09	20		KTM403	24,00
BMW					
R Nine-T / Scrambler / Pure / Urban / Racer	16	19		KTM425	24,00
S1000R	14	19		KTM425	24,00
S1000RR	09	18		KTM425	24,00
S1000RR	19	20		KTM430	24,00
DUCATI					
Diavel	11	18	d.12	KTM400	27,00
Monster 821	14	20	d.17	KTM400	27,00
Monster 1200 / R	17	20		KTM400	27,00
Multistrada	03	09		KTM405	24,00
Panigale 899 / 959 / 1199 / 1299	12	18		KTM418	24,00
Panigale V2	20	20		KTM418	24,00
Panigale V4	18	20		KTM429	24,00
848	08	11	d.12	KTM400	27,00
1098 / 1198	07	11	d.17	KTM400	27,00

Descrizione - Description	Anno - Year		Misura - measure	Codice - Code	€
	dal - from	al - to			
HONDA					
tutte / all		KTM406	24,00
KAWASAKI					
ER-6N	12	16		KTM404	24,00
Ninja 250 / Ninja 400	18	20		KTM404	24,00
Z650	17	20		KTM426	24,00
Z750	04	12		KTM404	24,00
Z800	13	16		KTM407	24,00
Z900	17	20		KTM404	24,00
Z1000	03	16		KTM404	24,00
Z1000 SX	11	16		KTM404	24,00
ZX250R	09	12		KTM407	24,00
ZX6R	03	20		KTM404	24,00
ZX10R	11	15		KTM404	24,00
ZX10R	16	20		KTM407	24,00
KTM					
Duke 390	17	20		KTM411	24,00
Duke 790	18	20		KTM400	27,00
SUZUKI					
Gladius 650	09	15		KTM409	24,00
GSR 600	06	11		KTM405	24,00
GSR 750	11	16		KTM405	24,00
GSXR 600 / 750	00	05		KTM405	24,00
GSXR 600 / 750	06	16		KTM409	24,00
GSXR 1000	03	04		KTM405	24,00
GSXR 1000	05	16		KTM409	24,00
GSXR 1000	17	20		KTM427	28,00
GSXR 750	17	20		KTM428	24,00
GSXR 1000	15	20		KTM400	24,00
TRIUMPH					
STREET TRIPLE 675	07	12		KTM400	27,00
STREET TRIPLE 675 R	13	18		KTM411	24,00
YAMAHA					
Fazer 600 - FZ6	04	06		KTM410	24,00
Fazer 1000	01	12		KTM410	24,00
MT-07 / XSR-700	14	20		KTM410	24,00
MT-09	13	20		KTM410	24,00
MT-10	16	20		KTM410	24,00
R 125	08	13		KTM410	24,00
R1	98	20		KTM411	24,00
R3	15	20		KTM411	24,00
R6	06	20		KTM411	24,00
X-MAX 400	13	20		KTM410	24,00
T Max 500 - 530 - 560	02	20		KTM410	24,00

Colori disponibili - Available colours:



CONTRAPPESI MANUBRI

102 HANDLEBAR BALANCERS

NEW!

NUOVE COMBINAZIONI COLORI / NEW COLOR COMBINATIONS



cobalto
cobalt



rosso
red

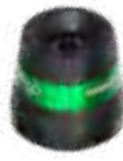

verde
green



oro
gold



nero
black

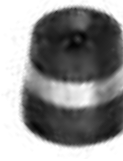





























silver
silver



arancione
orange

Modello - Model	Anno - Year		Misura - measure	Combinazione colore - Color combinations	Codice - Code	€
	dal - from	al - to				a coppia - for pair
Universali / Universal			d.12/13/17	■ ■ ■ ■ ■ ■ ■ ■	KTM300	38,00
APRILIA						
RSV4	09	20		■ ■ ■	KTM303	36,50
RSV1000	04	08		■ ■ ■	KTM313	36,50
Shiver 750	07	16		■ ■ ■	KTM313	36,50
Tuono	06	09		■ ■ ■	KTM313	36,50
Tuono V4	11	20		■ ■ ■	KTM313	36,50
BMW						
R Nine-T /Scrambler/Pure/Urban/Racer	16	19		■ ■ ■	KTM325	36,50
S1000R	14	19		■ ■ ■	KTM325	36,50
S1000RR	09	18		■ ■ ■	KTM325	36,50
S1000RR	19	20		■ ■ ■	KTM330	36,50
DUCATI						
Diavel	11	18	d.12	■ ■ ■ ■ ■ ■ ■ ■	KTM300	38,00
Monster 821	14	20	d.17	■ ■ ■ ■ ■ ■ ■ ■	KTM300	38,00
Monster 1100	11	13	d.14,5	■ ■ ■	KTM322	36,50
Monster 1200 / R	17	20		■ ■ ■ ■ ■ ■ ■ ■	KTM300	38,00
Multistrada	03	09		■ ■ ■	KTM305	36,50
Panigale 899 / 959 / 1199 / 1299	12	18		■ ■ ■	KTM318	36,50
Panigale V2	20	20		■ ■ ■	KTM318	36,50
Panigale V4	18	20		■ ■ ■	KTM329	36,50
Streetfighter 848 / 1100	08	16	d.14,5	■ ■ ■	KTM322	36,50
848	08	11	d.12	■ ■ ■ ■ ■ ■ ■ ■	KTM300	38,00
1098 / 1198	07	11	d.17	■ ■ ■ ■ ■ ■ ■ ■	KTM300	38,00
HONDA						
tutte / all		■ ■ ■ ■ ■	KTM306	36,50
KAWASAKI						
ER-6N	12	16		■ ■ ■	KTM304	36,50
Ninja 250 / Ninja 400	18	20		■ ■ ■	KTM304	36,50
Z650	17	20		■ ■ ■	KTM326	38,00
Z750	04	12		■ ■ ■	KTM304	36,50
Z800	13	16		■ ■ ■	KTM307	36,50
Z900	17	20		■ ■ ■	KTM304	36,50
Z1000	03	16		■ ■ ■	KTM304	36,50
Z1000 SX	11	16		■ ■ ■	KTM304	36,50
ZX250R	09	12		■ ■ ■	KTM307	36,50
ZX6R	03	17		■ ■ ■	KTM304	36,50
ZX10R	11	15		■ ■ ■	KTM304	36,50
ZX10R	16	20		■ ■ ■	KTM307	36,50

Modello - Model	Anno - Year		Misura - measure	Combinazione colore - Color combination	Codice - Code	€
	dal - from	al - to				a coppia - for pair
KTM						
Duke 390	17	20			KTM311	36,50
Duke 790	18	20			KTM300	38,00
MV						
BRUTALE – 4 cilindri (tutte le cilindrata)	01	17			KTM320	36,50
Brutale B3 - 3 cilindri 675 / 800	12	17			KTM320	36,50
F3 675 / 800	11	17			KTM319	36,50
F4 tutte	10	17			KTM323	36,50
SUZUKI						
Gladius 650	09	15			KTM309	36,50
GSR 600	06	11			KTM305	36,50
GSR 750	11	16			KTM305	36,50
GSXR 600 / 750	00	05			KTM305	36,50
GSXR 600 / 750	06	16			KTM309	36,50
GSXR 1000	03	04			KTM305	36,50
GSXR 1000	05	16			KTM309	36,50
GSXR 1000	17	20			KTM327	40,50
GSXS 750	17	20			KTM328	38,00
GSXS 1000	15	20			KTM300	38,00
TRIUMPH						
STREET TRIPLE 675	07	12			KTM300	38,00
STREET TRIPLE 675 R	13	17			KTM311	36,50
YAMAHA						
Fazer 600 - FZ6	04	06			KTM310	36,50
Fazer 1000	01	12			KTM310	36,50
MT-07 / XSR-700	14	20			KTM310	36,50
MT-09	13	20			KTM310	36,50
MT-10	16	20			KTM310	36,50
R 125	08	13			KTM310	36,50
R1	98	20			KTM311	36,50
R3	15	20			KTM311	36,50
R6	06	20			KTM311	36,50
X-MAX 400	13	20			KTM310	36,50
T Max 500 - 530 - 560	02	20			KTM310	36,50

 Anelli colorati per **KTM 300**
 Colored rings **KTM 300**

a coppia - for pair

RKT300

€ 10,30

CONTRAPPESI MANUBRI

HANDLEBAR BALANCERS



NEW LOOK, BEST COMFORT

Riduce le vibrazioni del manubrio rispetto ai contrappesi in alluminio

Reduces the vibrations of the handlebar compared to aluminum handlebar balancers

Descrizione - Description	Anno - Year		Misura - measure	Codice - Code	€
	dal - from	al - to			
Universali / Universal			d.12/13/17	KTM200	35,00
APRILIA					
RSV4	09	20		KTM203	33,00
BMW					
R Nine-T /Scrambler/Pure/Urban/Racer	16	19		KTM225	33,00
S1000R	14	19		KTM225	33,00
S1000RR	09	18		KTM225	33,00
S1000RR	19	20		KTM230	33,00
DUCATI					
Diavel	11	18	d.12	KTM200	35,00
Monster 821	14	20	d.17	KTM200	35,00
Monster 1200 / R	17	20		KTM200	35,00
Multistrada	03	09		KTM205	33,00
Panigale 899 / 959 / 1199 / 1299	12	18		KTM218	33,00
Panigale V2	20	20		KTM218	33,00
Panigale V4	18	20		KTM229	33,00
848	08	11	d.12	KTM200	35,00
1098 / 1198	07	11	d.17	KTM200	35,00
HONDA					
tutte / all		KTM206	33,00
KAWASAKI					
ER-6N	12	16		KTM204	33,00
Ninja 250 /Ninja 300 / Ninja 400	18	20		KTM204	33,00
Z650	17	20		KTM226	35,00
Z750	04	12		KTM204	33,00
Z 800	13	16		KTM207	33,00
Z900	17	20		KTM204	33,00
Z1000	03	16		KTM204	33,00
Z1000 SX	11	16		KTM204	33,00
ZX250R	09	12		KTM207	33,00
ZX6R	03	20		KTM204	33,00
ZX10R	11	15		KTM204	33,00
ZX10R	16	20		KTM207	33,00
KTM					
DUKE 390	17	20		KTM211	33,00
DUKE 790	18	20		KTM200	35,00

Colori disponibili - Available colours:



Descrizione - Description	Anno - Year		Misura - measure	Codice - Code	€
	dal - from	al - to			
MV					
BRUTALE – 4 cilindri (tutte le cilindrata)	01	15		KTM220	33,00
Brutale B3 - 3 cilindri 675 / 800	12	17		KTM220	33,00
F3 675 / 800	11	17		KTM219	33,00
F4 tutte	10	15		KTM223	33,00
SUZUKI					
Gladius 650	09	15		KTM209	33,00
GSR 600	06	11		KTM205	33,00
GSR 750	11	16		KTM205	33,00
GSXR 600 / 750	00	05		KTM205	33,00
GSXR 600 / 750	06	17		KTM209	33,00
GSXR 1000	03	04		KTM205	33,00
GSXR 1000	05	16		KTM209	33,00
GSXR 1000	17	20		KTM227	38,00
GSXS 750	17	20		KTM228	35,00
GSXS 1000	15	20		KTM200	35,00
TRIUMPH					
STREET TRIPLE 675	07	12		KTM200	35,00
STREET TRIPLE 675 R	13	16		KTM211	33,00
YAMAHA					
Fazer 600 - FZ6	04	06		KTM210	33,00
Fazer 1000	01	12		KTM210	33,00
MT-07 / XSR-700	14	20		KTM210	33,00
MT-09	13	20		KTM210	33,00
MT-10	16	20		KTM210	33,00
R 125	08	13		KTM210	33,00
R1	98	20		KTM211	33,00
R3	15	20		KTM211	33,00
R6	06	20		KTM211	33,00
X-MAX 400	13	19		KTM210	33,00
T Max 500 - 530 - 560	02	20		KTM210	33,00

**BORN
TO BE
MOTO**



Jorge Navarro
Sepang 2019

SPECCHIETTI
MIRRORS



SPECCHIETTI IN ALLUMINIO PER NAKED

108 ALUMINIUM MIRRORS FOR NAKED

HOMOLOGATED



Omologato
Homologated

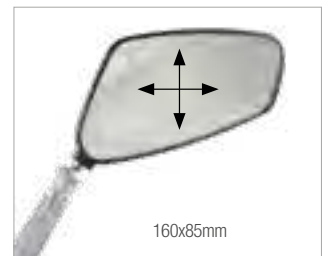

Coppia specchi alluminio (filetto 2xM10x1,25 Right + 1xM10x1,25 Left)
Aluminium mirrors couple (thread 2xM10x1,25 Right + 1xM10x1,25 Left)

■ SPEAL031NER

a coppia - for pair
€ 218,00

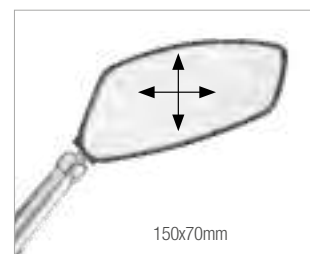

Coppia specchi alluminio (filetto 2xM10x1,25 Right + 1xM10x1,25 Left)
 Aluminium mirrors couple (thread 2xM10x1,25 Right + 1xM10x1,25 Left)

■ SPEAL027NER

a coppia - for pair
€ 207,00

SPECCHIETTI IN ALLUMINIO PER NAKED

110 ALUMINIUM MIRRORS FOR NAKED



Coppia specchi alluminio (filetto 2xM10x1,25 Right + 1xM10x1,25 Left) Aluminium mirrors couple (thread 2xM10x1,25 Right + 1xM10x1,25 Left)	<input type="checkbox"/> SPEAL014BIA <input checked="" type="checkbox"/> SPEAL014NER <input checked="" type="checkbox"/> SPEAL014ROS	a coppia - for pair € 207,00
Coppia specchi per T-MAX fissaggio a manubrio Pair of mirrors for T-MAX, fixing on handlebar	<input type="checkbox"/> SPEAL015BIA <input checked="" type="checkbox"/> SPEAL015NER <input checked="" type="checkbox"/> SPEAL015ROS	€ 207,00
Coppia specchi per T-MAX fissaggio su carena, completo di adattatori Pair of mirrors for T-MAX, fixing on fairing, adaptors included	<input type="checkbox"/> SPEAL019BIA <input checked="" type="checkbox"/> SPEAL019NER <input checked="" type="checkbox"/> SPEAL019ROS	€ 277,00



SPEY10



SPEY12

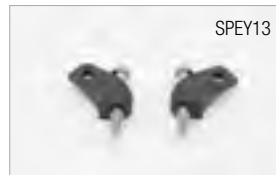

SPEY13

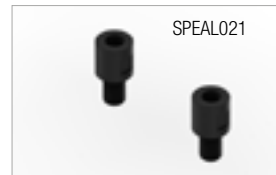

SPEAL021

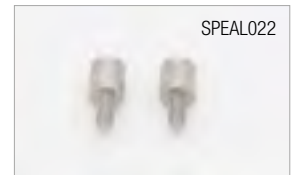

SPEAL022



SPEAL025

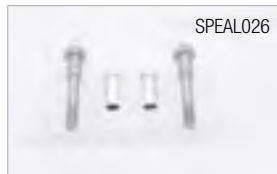

SPEAL026



SPEAL030



SPEAL032

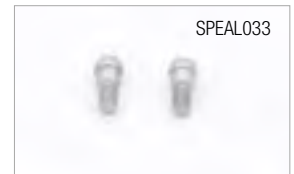

SPEAL033





Kit conversione attacchi specchio SPEAL015 T-Max (da manubrio a carena) in abbinamento con SPEY09 Conversion kit for T-Max mirrors SPEAL015 fitment (from handlebar to fairing) in combination with SPEY09	<input checked="" type="checkbox"/> SPEY10	a coppia - for pair € 36,50
Kit conversione attacchi specchio (SPEAL015) per T-Max (da carena a manubrio) con leve originali Conversion kit mirror fitment (SPEAL015) for T-Max (from fairing to handlebar) with OEM levers	<input checked="" type="checkbox"/> SPEY12	€ 36,50
Kit conversione attacchi specchio (SPEAL015) per T-Max (da carena a manubrio) con leve Lightech Conversion kit mirror fitment (SPEAL015) for T-Max (from fairing to handlebar) with Lightech levers	<input checked="" type="checkbox"/> SPEY13	€ 36,50
Coppia adattatori specchio con filetto (da M10x1,25 femmina a M10 maschio DX + SX) Pair of mirror adaptors with thread (female M10x1.25 to male M10 left+right)	<input checked="" type="checkbox"/> SPEAL021NER	€ 12,00
Coppia adattatori specchio con filetto (da M10x1,25 femmina a M8 maschio DX + SX) Pair of mirror adaptors with thread (female M10x1.25 to male M8 left+right)	<input checked="" type="checkbox"/> SPEAL022	€ 12,00
Coppia adattatori specchio per BMW con filetto (da M10x1,5 a M8 / DX + SX) Pair of mirrors adaptors with thread (from M10x1,5 to M8 / R + L) for BMW Models	<input checked="" type="checkbox"/> SPEAL025	€ 12,00
Kit viti per montaggio specchi SPEAL015 su T-Max (con leve originali) Bolts kit for fitting SPEAL015 mirrors on T-Max (with OEM levers)	<input checked="" type="checkbox"/> SPEAL026	€ 12,00
Coppia adattatori specchio per conversione da M8 DX a M8 (DX + SX) Pair of mirrors adaptors for conversion from M8 right to M8 right + M8 left	<input checked="" type="checkbox"/> SPEAL030	€ 12,00
Coppia adattatori specchio per MV Agusta BRUTALE 4 CILINDRI Pair of mirror adaptors for MV Agusta Brutale 4 pistons	<input checked="" type="checkbox"/> SPEAL032	€ 18,00
Kit viti per specchi SPEAL014 con filetto M8 DX + SX Bolts kit for mirrors SPEAL014 with thread M8 left + right	<input checked="" type="checkbox"/> SPEAL033	€ 12,00







TAPPI SPECCHIO
MIRROR
BLOCK-OFF PLATES

TAPPI SPECCHIO









112 MIRROR BLOCK-OFF PLATES

Articolo - Article		Anno - Years		Codice - Code		€	
a coppia - for pair							
APRILIA	RSV4 R / Factory / APRC	09	14	■ ■	SPE111	33,00	 SPE111  SPE116
	RSV4 R / R	15	17	■ ■	SPE116	43,00	
	APRILIA RSV4 RR / 1100 Factory	18	20	■ ■	SPE111	33,00	
BMW	S1000 RR	09	18	■ ■ ■ ■	SPE101	29,00	 SPE101  SPE122
	S1000 RR	19	20	■ ■ ■ ■	SPE122	48,00	



DUCATI	PANIGALE 899/1199	12	15	■ ■	SPE113	57,00	 SPE113  SPE117  SPE121  SPE123
	PANIGALE 959/1299	15	17	■ ■	SPE117	48,00	
	PANIGALE V4 / S	18	20	■ ■	SPE121	48,00	
	PANIGALE V4 R	19	20	■ ■	SPE123	48,00	









Articolo - Article		Anno - Years		Codice - Code		€	
							a coppia - for pair
HONDA	CBR 600 RR	04	16	■ ■	SPE105	29,00	 SPE105  SPE106
	CBR 1000 RR	04	07	■ ■	SPE105	29,00	
	CBR 1000 RR	08	19	■ ■	SPE106	33,00	
KAWASAKI	Ninja 400	18	20	■ ■	SPE118	33,00	 SPE102  SPE110  SPE112  SPE118
	ZX6R	05	08	■ ■	SPE102	29,00	
	ZX6R	09	12	■ ■	SPE110	29,00	
	ZX10R	04	07	■ ■	SPE102	29,00	
	ZX10R	11	15	■ ■	SPE112	33,00	
	ZX10R	16	20	■ ■	SPE118	33,00	
MV AGUSTA	F3 675 / F3 800	12	18	■ ■	SPE114	43,00	 SPE114
SUZUKI	GSXR 600 / 750 / 1000	05	16	■ ■ ■	SPE103	29,00	 SPE103  SPE119
	GSXR 1000	17	20	■ ■ ■ ■	SPE119	48,00	



TAPPI SPECCHIO

114 MIRROR BLOCK-OFF PLATES

Articolo - Article		Anno - Years		Codice - Code	€	
a coppia - for pair						
YAMAHA	R6	99	07		SPE104	29,00
	R6	17	20		SPE120	48,00
	R1	98	06		SPE104	29,00
	R1	07	14		SPE101	29,00
	R1	15	19		SPE115	48,00
	R1	20	20		SPE124	48,00
	TMAX 530-560	12	20		SPEY08	49,00



SPE104



SPE120



SPE101



SPE115



SPEY08



SPE124





PORTA TARGA
LICENSE PLATE HOLDER

PORTA TARGA REGOLABILI

116 ADJUSTABLE LICENSE PLATE HOLDERS

FACILE E VELOCE

EASY AND FAST

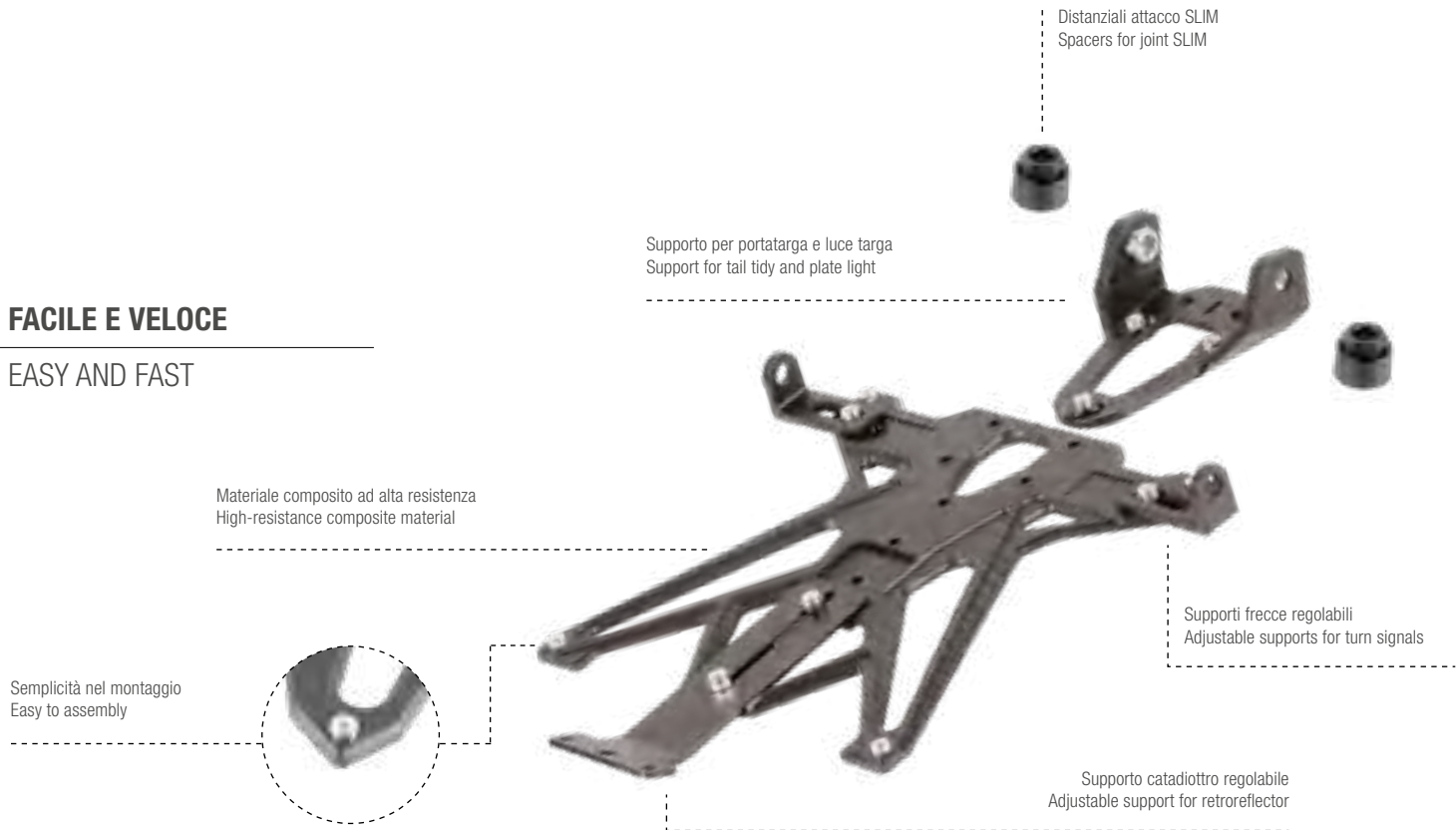

NEL PIENO RISPETTO DEL CODICE DELLA STRADA

FOR LEGAL STREET USE





KIT PORTATARGA COMPLETO DI CATADIOTTRO E LUCE TARGA OMOLOGATI
LICENSE PLATE KIT COMPLETE WITH APPROVED RETROREFLECTOR AND LICENSE PLATE LIGHT



PORTA TARGA REGOLABILI

118 ADJUSTABLE LICENSE PLATE HOLDERS

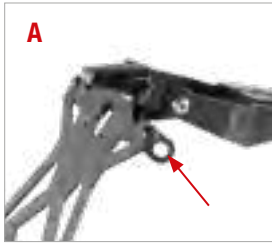

attacco per freccia Ø 8 /
hole for Ø 8 turn signal

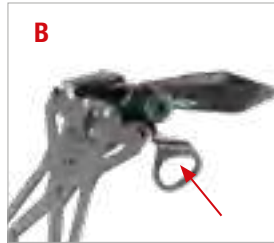

attacco per freccia originale / with hole
for original turn signals



luce in dotazione /
light supplied



comprensivo di catadiottero /
retroreflector included

IMPORTANTE: aggiungere il codice della sigla dello stato (vedi esempio pag 125)

IMPORTANT: add the code of the country (see example page 125)

Modello - Model	Anno - Year		foro per frecce hole for turn signals		luce light	catadiottero retroreflector	certificazione certification	Codice - Code	€	
	dal - from	al - to	racing	original						
Universal vedi pagina 126 / see page 126			✓					TAR013	54,00	
APRILIA										
Dorsoduro 900	18	20	✓	✓	LT009	✓		KTARAP108**	95,00	kit
			✓	✓				TARAP108**	70,00	
Dorsoduro 1200	11	15	✓	✓	LT009	✓		KTARAP104**	95,00	kit
			✓	✓				TARAP104**	70,00	
RSV4 (1000cc) + (1100cc) R / Factory / APRC / RF	09	20	✓	✓	LT009	✓		KTARAP107**	92,00	kit
			✓	✓				TARAP107**	66,50	
Tuono V4 / Factory / APRC	11	20	✓	✓	LT009	✓		KTARAP107**	92,00	kit
			✓	✓				TARAP107**	66,50	
BMW										
C600 sport	12	15	✓	✓	LT009	✓		KTARBM104**	124,00	kit
			✓	✓				TARBM104**	98,00	
R 1200 GS	13	17		✓	LT009	✓		KTARBM108**	92,00	kit
								TARBM108**	66,50	
R NINE-T Scrambler / Urban / Racer / Pure vedi pagina 124 / see page 124	16	19	✓	✓	LT009	✓		KTARBM109**	320,00	kit
			✓	✓	LT009	✓		TARBM110**	320,00	
S1000R	14	19	✓	✓	LT009	✓		KTARBM105**	107,00	kit
			✓	✓				TARBM105**	82,00	
S1000RR / HP4	09	18	✓	✓	LT009	✓		KTARBM105**	107,00	kit
			✓	✓				TARBM105**	82,00	
S1000RR	19	20	✓	✓	LT009	✓		KTARBM111**	107,00	kit
			✓	✓				TARBM111**	82,00	
DUCATI										
848 - 1098 - 1198	07	11	✓	✓	LT009	✓		KTARDU104**	95,00	kit
			✓	✓				TARDU104**	70,00	
Hypermotard 796 - 1100	07	12	✓		LT009	✓		KTARDU105**	92,00	kit
			✓					TARDU105**	66,50	
Hypermotard 821 / 939	13	18	✓		LT009	✓		KTARDU110**	95,00	kit
			✓					TARDU110**	70,00	
Hypermotard 950	19	20	✓	✓	LT009	✓		KTARDU114**	143,50	kit
			✓	✓				TARDU114**	140,00	

Modello - Model	Anno - Year		A		B	C	D	certificazione certification	Codice - Code	€	
			foro per frecce hole for turn signals		luci light	catadiottro retroreflector					
	dal - from	al - to	racing	original							
DUCATI											
Monster 797	17	19	✓	✓	LT009	✓		KTARDU112**	100,00	kit	
			✓	✓				TARDU112**	74,00		
Monster 821	14	17	✓	✓	LT009	✓		KTARDU111**	285,00	kit	
			✓	✓				TARDU111**	260,00		
Monster 1200	14	16	✓	✓	LT009	✓		KTARDU111**	285,00	kit	
			✓	✓				TARDU111**	260,00		
Monster 1200 / S / R	17	19	✓	✓	LT009	✓		KTARDU112**	100,00	kit	
			✓	✓				TARDU112**	74,00		
Panigale 899 / 1199 / 1299	12	17	✓	✓	LT009	✓		KTARDU109**	207,00	kit	
			✓	✓				TARDU109**	182,00		
Panigale 959	18	19	✓	✓	LT009	✓		KTARDU109**	207,00	kit	
			✓	✓				TARDU109**	182,00		
Panigale V2 955	20	20	✓	✓	LT009	✓		KTARDU113**	207,00	kit	
			✓	✓				TARDU113**	182,00		
Panigale V4 / S	18	19	✓	✓	LT009	✓		KTARDU113**	207,00	kit	
			✓	✓				TARDU113**	182,00		
Supersport 939 / S	17	20	✓	✓	LT009	✓		KTARDU112**	100,00	kit	
			✓	✓				TARDU112	74,00		
Streetfighter 1100 + 848	09	17	✓	✓	LT009	✓		KTARDU106**	95,00	kit	
			✓	✓				TARDU106**	70,00		
Streetfighter V4	20	20	✓	✓	LT009	✓		KTARDU113**	207,00	kit	
			✓	✓				TARDU113**	182,00		
FANTIC											
Caballero	19	20	✓	✓	LT009	✓		KTARFA101**	92,00	kit	
			✓	✓				TARFA101**	66,50		
GUZZI											
GRISO 850 + 1100 + 1150	06	16	✓	✓	LT009	✓		KTARGU101**	92,00	kit	
			✓	✓				TARGU101**	66,50		
HONDA											
CB 125R / CB300R	18	20	✓	✓	LT009	✓		KTARHO117**	92,00	kit	
			✓	✓				TARHO117**	66,50		
CB 650 F	14	19	✓		LT009	✓		KTARHO111**	92,00	kit	
			✓					TARHO111**	66,50		
CB 650 R	19	19	✓	✓	LT009	✓		KTARHO118**	92,00	kit	
			✓	✓				TARHO118**	66,50		
CB 1000R	08	17	✓		LT009	✓		KTARHO107**	100,00	kit	
			✓					TARHO107**	74,00		
CB 1000R	18	20	✓	✓	LT009	✓		KTARHO116**	100,00	kit	
			✓	✓				TARHO116**	74,00		
CBR 600 F	11	13	✓		LT009	✓		KTARHO108**	92,00	kit	
			✓					TARHO108**	66,50		
CBR 650 F	14	18	✓		LT009	✓		KTARHO111**	92,00	kit	
			✓					TARHO111**	66,50		
CBR 650 R	19	19	✓	✓	LT009	✓		KTARHO118**	92,00	kit	
			✓	✓				TARHO118**	66,50		

PORTA TARGA REGOLABILI

120 ADJUSTABLE LICENSE PLATE HOLDERS

Modello - Model	Anno - Year		A	B	C	D	certificazione certification	Codice - Code	€	
	dal - from	al - to	foro per frecce hole for turn signals		luci light	catadiottro retroreflector				
			racings	original						
HONDA										
CBR 600 RR	13	16	✓		LT009	✓		KTARHO112**	107,00	kit
			✓					TARHO112**	81,00	
CBR 1000 RR	10	16	✓		LT009	✓		KTARHO109**	92,00	kit
			✓					TARHO109**	66,50	
CBR 1000 RR	17	19	✓		LT009	✓		KTARHO114**	92,00	kit
			✓					TARHO114**	66,50	
HORNET 600	11	13	✓		LT009	✓		KTARHO108**	92,00	kit
			✓					TARHO108**	66,50	
INTEGRA 700 / 750	12	15	✓		LT008	✓		KTARHO110**	91,50	kit
			✓		LT008			TARHO110**	88,00	
INTEGRA 750	16	18	✓		LT009	✓		KTARHO113**	92,00	kit
			✓					TARHO113**	66,50	
NC 700 / NC 700 X	12	15	✓		LT008	✓		KTARHO110**	91,50	kit
			✓		LT008			TARHO110**	88,00	
X-ADV 750	17	20		✓	LT009	✓		KTARHO115**	181,00	kit
				✓				TARHO115**	156,00	
HUSQVARNA										
NUDA 900	11	13	✓	✓	LT009	✓		KTARHU101**	113,00	kit
			✓	✓				TARHU101**	87,00	
VITPILEN 701	18	19	✓	✓	LT009	✓		KTARHU102**	127,00	kit
			✓	✓				TARHU102**	101,50	
KAWASAKI										
ER - 6N	12	16	✓	✓	LT009	✓		KTARKA116**	113,00	kit
			✓	✓				TARKA116**	87,00	
Ninja 300 / Z300	13	18	✓		LT009	✓		KTARKA118**	92,00	kit
			✓					TARKA118**	66,50	
Ninja 250 / Ninja 400 / Z400	17	20	✓	✓	LT009	✓		KTARKA124**	92,00	kit
			✓	✓				TARKA124**	66,50	
Z 125 / Ninja 125	19	19	✓	✓	LT009	✓		KTARKA125**	92,00	kit
			✓	✓				TARKA125**	66,50	
Z 650 / Ninja 650	16	20	✓	✓	LT009	✓		KTARKA122**	95,00	kit
			✓	✓				TARKA122**	70,00	
Z 750	07	12	✓		LT009	✓		KTARKA109**	92,00	kit
			✓					TARKA109**	66,50	
Z 800	13	16	✓		LT009	✓		KTARKA117**	92,00	kit
			✓					TARKA117**	66,50	
Z 900	17	20	✓	✓	LT009	✓		KTARKA123**	95,00	kit
			✓	✓				TARKA123**	70,00	
Z 1000	07	09	✓		LT009	✓		KTARKA109**	92,00	kit
			✓					TARKA109**	66,50	
Z 1000	10	13	✓		LT009	✓		KTARKA115**	92,00	kit
			✓					TARKA115**	66,50	
Z 1000	14	19	✓		LT009	✓		KTARKA119**	92,00	kit
			✓					TARKA119**	66,50	

Modello - Model	Anno - Year		foro per frecce hole for turn signals		C luci light	D catadiottro retroreflector	certificazione certification	Codice - Code	€	
	dal - from	al - to	racing	original						
KAWASAKI										
Z 1000 SX	11	18	✓		LT009	✓		KTARKA115**	92,00	kit
			✓					TARKA115**	66,50	
ZX6R - ZX636	13	18	✓		LT009	✓		KTARKA120**	92,00	kit
			✓					TARKA120**	66,50	
ZX6R (636cc)	19	20	✓	✓	LT009	✓		KTARKA126**	92,00	kit
			✓	✓				TARKA126**	66,50	
ZX10 R	08	10	✓		LT009	✓		KTARKA120**	92,00	kit
			✓					TARKA120**	66,50	
ZX10 R	11	15			LT009	✓		KTARKA113**	92,00	kit
								TARKA113**	66,50	
ZX10 R	16	20	✓		LT009	✓		KTARKA121**	92,00	kit
			✓					TARKA121**	66,50	
KTM										
DUKE 125 / 390	17	19	✓	✓		✓		KTARKT105**	113,00	kit
			✓	✓				TARKT105**	87,00	
DUKE 690	12	16	✓		LT003	✓		KTARKT103**	84,00	kit
			✓		LT003			TARKT103**	80,00	
DUKE 790	18	19	✓	✓	LT008	✓		KTARKT106**	113,00	kit
			✓	✓	LT008			TARKT106**	109,50	
DUKE 890 R	20	20	✓	✓	LT008	✓		KTARKT108**	xxxx	kit
			✓	✓	LT008			TARKT108**	xxxx	
RC 125 / 200 / 390	17	19	✓	✓	LT009	✓		KTARKT107**	113,00	kit
			✓	✓				TARKT107**	87,00	
Super Duke 1290 - R	14	19		✓	LT009	✓		KTARKT104**	102,00	kit
				✓				TARKT104**	77,00	
MV AGUSTA										
BRUTALE 750 / 910 / 990 / 1090	01	14	✓		LT009	✓		KTARMV101**	92,00	kit
			✓					TARMV101**	66,50	
BRUTALE 675 / 800	12	16	✓		LT009	✓		KTARMV105**	92,00	kit
			✓					TARMV105**	66,50	
F3 675 / F3 800	12	18	✓		LT009	✓		KTARMV104**	92,00	kit
			✓					TARMV104**	66,50	
F4	10	12	✓	✓	LT009	✓		KTARMV103**	95,00	kit
			✓	✓				TARMV103**	70,00	
F4	13	16	✓		LT009	✓		KTARMV106**	95,00	kit
			✓					TARMV106**	70,00	
SUZUKI										
GSR 750	11	16	✓		LT009	✓		KTARSU110**	92,00	kit
			✓					TARSU110**	66,50	
GSX-R 125 / GSX-S 125	17	19	✓		LT009	✓		KTARSU115**	92,00	kit
			✓					TARSU115**	66,50	
GSX 250 R	17	19	✓		LT009	✓		KTARSU114**	92,00	kit
			✓					TARSU114**	66,50	
GSXR 600 / 750	08	10			LT009	✓		KTARSU104**	92,00	kit
								TARSU104**	66,50	

PORTA TARGA REGOLABILI

122 ADJUSTABLE LICENSE PLATE HOLDERS

Modello - Model	Anno - Year		foro per frecce hole for turn signals		luci light	catadiottro retroreflector	certificazione certification	Codice - Code	€	
	dal - from	al - to	racings	original						
SUZUKI										
GSXR 600 / 750	11	17			LT009	✓		KTARSU109**	92,00	kit
								TARSU109**	66,50	
GSXR 1000	05	08			LT009	✓		KTARSU101**	92,00	kit
								TARSU101**	66,50	
GSXR 1000	09	16			LT009	✓		KTARSU102**	92,00	kit
								TARSU102**	66,50	
GSXR 1000 / R	17	20		✓	LT009	✓		KTARSU113**	100,0	kit
				✓				TARSU113**	74,00	
GSX S 750	17	20	✓		LT009	✓		KTARSU111**	92,00	kit
			✓					TARSU111**	66,50	
GSX S 1000	15	20	✓		LT009	✓		KTARSU111**	92,00	kit
			✓					TARSU111**	66,50	
SV 650	16	18	✓		LT009	✓		KTARSU112**	92,00	kit
			✓					TARSU112**	66,50	
TRIUMPH										
DAYTONA 675 / 675R	13	18	✓	✓	LT009	✓		KTARTR106**	95,00	kit
			✓	✓				TARTR106**	70,00	
Speed Triple 1050 / 1050R	11	15	✓		LT009	✓		KTARTR105**	92,00	kit
			✓					TARTR105**	66,50	
Speed Triple 1050 / R / RS <small>Utilizzare solo frecce corte. Si consiglia modello FRE928 Use only short indicators. FRE928NER is recommended</small>	16	19	✓	✓	LT009	✓		KTARTR107**	95,00	kit
			✓	✓				TARTR107**	70,00	
Street Triple 675 / 675R	07	12	✓		LT009	✓		KTARTR103**	95,00	kit
			✓					TARTR103**	70,00	
Street Triple 675 / 675R	13	16	✓	✓	LT009	✓		KTARTR106**	95,00	kit
			✓	✓				TARTR106**	70,00	
Street Triple 765 / 765R / 765RS	17	19	✓	✓	LT009	✓		KTARTR106**	95,00	kit
			✓	✓				TARTR106**	70,00	
YAMAHA										
FAZER 600 / FZ6	04	12	✓	✓	LT009	✓		KTARYA106**	92,00	kit
			✓	✓				TARYA106**	66,50	
FZ8	10	15	✓	✓	LT009	✓		KTARYA109**	92,00	kit
			✓	✓				TARYA109**	66,50	
FAZER 1000 / FZ1	06	15	✓	✓	LT009	✓		KTARYA109**	92,00	kit
			✓	✓				TARYA109**	66,50	
MT-3	15	20	✓		LT009	✓		KTARYA120**	92,00	kit
			✓					TARYA120**	66,50	
MT-07	14	19	✓	✓	LT009	✓		KTARYA125**	97,00	kit
			✓	✓				TARYA125**	71,50	
MT-09	13	16	✓	✓	LT009	✓		KTARYA116**	92,00	kit
			✓	✓				TARYA116**	66,50	
MT-09 Tracer / Tracer GT	15	19	✓	✓	LT009	✓		KTARYA119**	98,00	kit
			✓	✓				TARYA119**	73,00	
MT-09	17	19	✓	✓	LT009	✓		KTARYA123**	187,0	kit
			✓	✓				TARYA123**	162,0	

Modello - Model	Anno - Year		A		B		C		D		FINE SERIE - END STOCK	Certificazione certification	Codice - Code	€
			foro per frecce hole for turn signals		luci light		catadiottro retroreflector							
	dal - from	al - to	racings	original										
YAMAHA														
MT-10	16	20	✓	✓	LT009	✓						KTARYA121**	98,00	kit
			✓	✓								TARYA121**	73,00	
R 125	14	18	✓	✓	LT009	✓						KTARYA126**	92,00	kit
			✓	✓								TARYA126**	66,50	
R3	15	20	✓	✓	LT009	✓						KTARYA120**	92,00	kit
			✓	✓								TARYA120**	66,50	
R6	06	16	✓	✓	LT009	✓						KTARYA103**	92,00	kit
			✓	✓								TARYA103**	66,50	
R6	17	20	✓	✓	LT009	✓						KTARYA122**	92,00	kit
			✓	✓								TARYA122**	66,50	
R1	04	08	✓	✓	LT009	✓						KTARYA103**	92,00	kit
			✓	✓								TARYA103**	66,50	
R1	09	14	✓	✓	LT009	✓						KTARYA104**	92,00	kit
			✓	✓								TARYA104**	66,50	
R1	15	20	✓	✓	LT009	✓						KTARYA118**	180,50	kit
			✓	✓								TARYA118**	155,00	
TENERE 700	19	20	✓	✓	LT009	✓						KTARYA127**	xxxx	kit
			✓	✓								TARYA127**	xxxx	
XJ6	08	15	✓	✓	LT009	✓						KTARYA108**	92,00	kit
			✓	✓								TARYA108**	66,50	
T - MAX 500 (con sottocodone / with undertail)	08	11			LT009	✓						KTARYA112**	117,00	kit
												TARYA112**	91,50	
T - MAX 500 (senza sottocodone / without undertail)	08	11			LT009	✓						KTARYA113**	92,00	kit
												TARYA113**	66,50	
T - MAX 530	12	16			LT009	✓						KTARYA114**	92,00	kit
												TARYA114**	66,50	
T - MAX 530 - 560	17	20	✓	✓	LT009	✓						KTARYA124**	92,00	kit
			✓	✓								TARYA124**	66,50	



PORTA TARGA REGOLABILI

124 ADJUSTABLE LICENSE PLATE HOLDERS

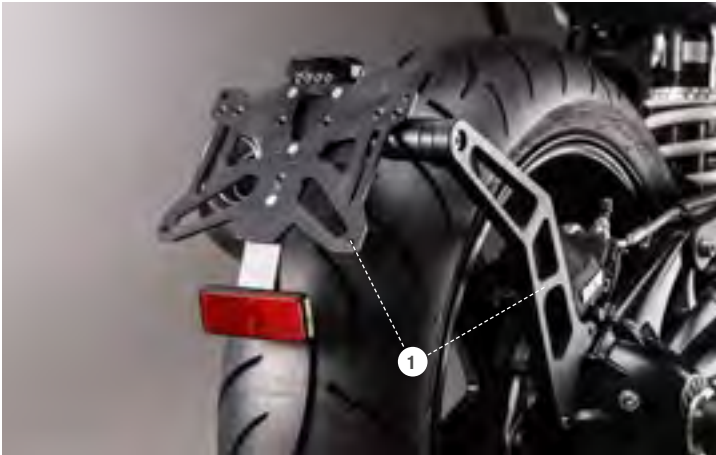

KTARBM109 = (1) Kit Portatarga + (2) portafaro **nero**
 KTARBM110 = (1) Kit Portatarga + (2) portafaro **silver**

KTARBM109 = (1) Adjustable license plate holder KIT + (2) **Black** light support
 KTARBM110 = (1) Adjustable license plate holder KIT + (2) **Silver** light support

COME PERSONALIZZARE IL PORTATARGA LIGHTECH

HOW TO CUSTOMISE LIGHTECH TAIL TIDY



a kit - for kit			
KIT VITI / BOLT KIT	005M8x25 + RCM8	TAR 009	€ 8,00
KIT VITI / BOLT KIT	005M8x30 + RCM8	TAR 029	€ 8,00
KIT VITI / BOLT KIT	005M8x35 + RCM8	TAR 008	€ 8,00
KIT VITI / BOLT KIT	005M8x40 + RCM8	TAR 025	€ 8,00

COME COMPORRE IL CODICE (esempio per BMW S1000RR con supporto A2) = KTABRM105**A2**
HOW TO FULFILL THE P/N (example for BMW S1000RR with A2 support plate)

A1

-  IT = Italia
-  DE = Deutschland
-  SLO = Slovenija

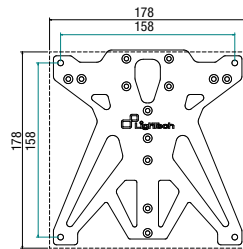

MATERIAL

Composit Nylon PA12 + Carbon Fiber

A2

-  F = France
-  CH = Schweiz

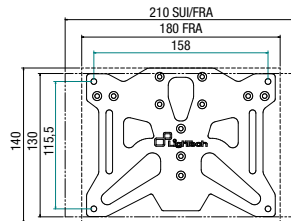

MATERIAL

Composit Nylon PA12 + Carbon Fiber

A3

-  E = España

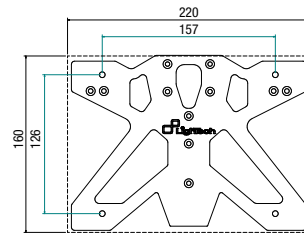

MATERIAL

Composit Nylon PA12 + Carbon Fiber

B1

-  CA = Canada
-  USA = United S.
-  P = Portugal

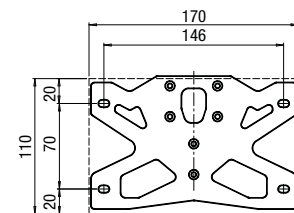

MATERIAL

Aluminium

B2

-  KOR = Korea

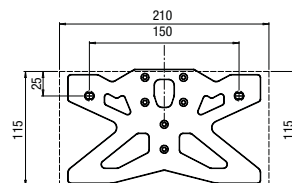

MATERIAL

Aluminium

B3

-  JAP = Japan

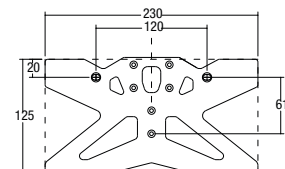

MATERIAL

Aluminium

PORTA TARGA UNIVERSALE

126 GENERIC TAIL TIDY TO ADAPT



Porta targa universale con kit di applicazione
Generic tail tidy to adapt with application kit

colore - color



TAR013**

€ 54,00

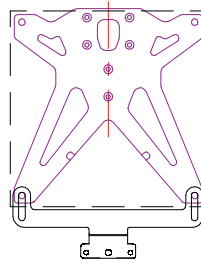
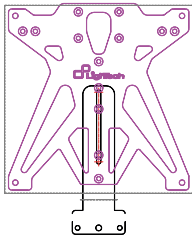

HOMOLOGATED



KAT04

€ 12,00

HOMOLOGATED



KAT01

€ 12,00

HOMOLOGATED



TAR024

€ 6,50

Compatibile con tutti i portatarga Lightech dal 2019 →
Compatible with LightTech tail tidy version 2019 →

KAWASAKI Z900





LUCI
LIGHTS

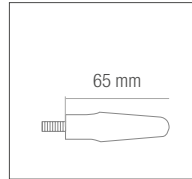

Coppia frecce a led / Pair of led turn signals

Materiale / Material: ABS
Omologato / Homologated: E8

- Nuovi indicatori di direzione / New indicators
- Lightech patented / Lightech patented
- Tecnologia innovativa MULTI-PIXEL
Innovative MULTI-PIXEL technology

Indicatore di direzione / Indicators

a coppia - for pair

FRE931NER

€ 49,00

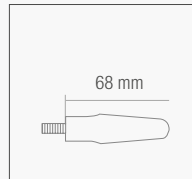

Coppia frecce a led / Pair of led turn signals

Materiale / Material: ABS
Omologato / Homologated: E8

- Nuovi indicatori di direzione / New indicators
- Lightech patented / Lightech patented
- Tecnologia innovativa MULTI-PIXEL
Innovative MULTI-PIXEL technology

Indicatore di direzione / Indicators

a coppia - for pair

FRE932NER

€ 49,00





Coppia frecce a led / Pair of led turn signals

Materiale / Material: ABS
Omologato / Homologated: E8

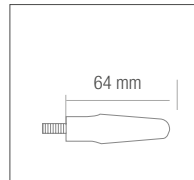

■ **Indicatore di direzione / Indicators**

FRE929NER a coppia - for pair
€ 49,00



Coppia frecce a led / Pair of led turn signals

Materiale / Material: aluminum
Omologato / Homologated: E8

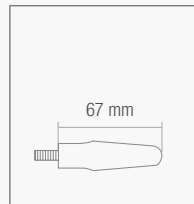

■ **Indicatore di direzione / Indicators**

FRE930NER ■ a coppia - for pair
€ 54,00
FRE930COB ■
FRE930ROS ■



FRE929

INDICATORI DI DIREZIONE A LED

130 LED TURN SIGNALS

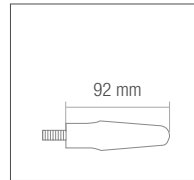

LUCE SEQUENZIALE / SEQUENTIAL LIGHT

Coppia frecce a led / Pair of led turn signals

Materiale / Material: ABS
Omologato / Homologated: E8

- Indicatore di direzione / Indicators
- Posizione posteriore / Red sidelight
- Stop / Brakelight

FRE923NER

a coppia - for pair

€ 48,00

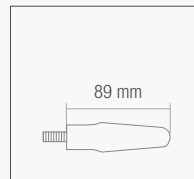

Coppia frecce a led / Pair of led turn signals

Materiale / Material: ABS
Omologato / Homologated: E8

- Indicatore di direzione / Indicators

FRE924NER

a coppia - for pair

€ 38,00

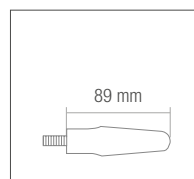

LUCE SEQUENZIALE / SEQUENTIAL LIGHT

Coppia frecce a led / Led turn signals in pair

Materiale / Material: ABS
Omologato / Homologated: E8

- Indicatore di direzione / Indicators

FRE925NER

a coppia - for pair

€ 49,00

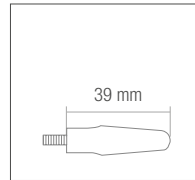

Coppia frecce a led / Pair of led turn signals

Materiale / Material: ABS
Omologato / Homologated: E8

■ Indicatore di direzione / Indicators

FRE928NER a coppia - for pair
€ 39,00

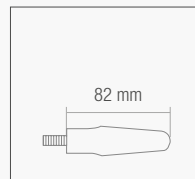

Coppia frecce a led / Pair of led turn signals

Materiale / Material: ABS
Omologato / Homologated: E8

■ Indicatore di direzione / Indicators

FRE926NER a coppia - for pair
€ 38,00

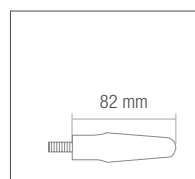

Coppia frecce a led / Led turn signals in pair

Materiale / Material: ABS
Omologato / Homologated: E8

■ Indicatore di direzione / Indicators

FRE922NER a coppia - for pair
€ 39,00



Piastrine frecce
Plate for direction indicators PFY € 12,50
per 4 pezzi
for 4 pieces



Piastrine frecce
Plate for direction indicators PFK € 12,50
per 4 pezzi
for 4 pieces



Piastrine frecce
Plate for direction indicators PFH2 € 12,50
per 4 pezzi
for 4 pieces



Piastrine frecce
Plate for direction indicators PFS € 12,50
per 4 pezzi
for 4 pieces

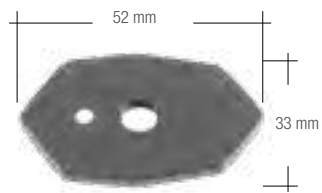

Piastrine frecce
Plate for direction indicators PFK2 € 14,50
per 4 pezzi
for 4 pieces





Nuovo espositore per indicatori di direzione /
New display for turn signals EXP009

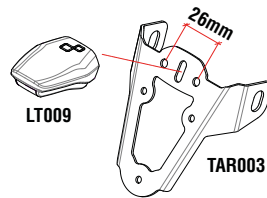

100% MADE IN ITALY
PATENTED DESIGN®
HOMOLOGATED 



Luce targa Python
Python license plate light

- LT009BIA
- LT009NER
- LT009ROS
- LT009BLU

€ 30,70

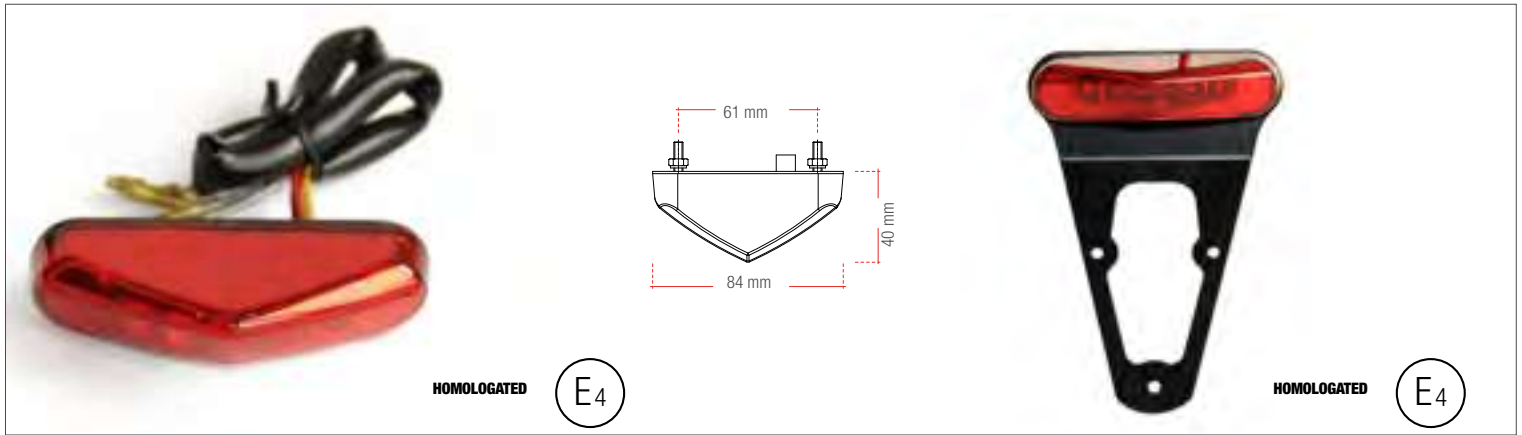

Luce targa License plate light	LT007	€ 36,40
-----------------------------------	-------	---------

Fanalino targa License plate light	LT008	€ 46,30
---------------------------------------	-------	---------

con supporto - with holder

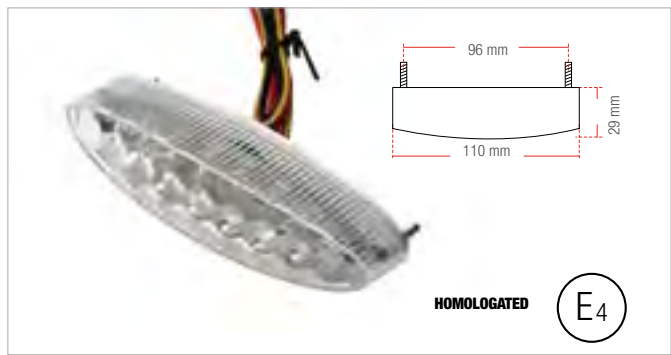

Fanalino targa License plate light	LT003	€ 33,30
---------------------------------------	-------	---------

senza copri faro - without cover



Faro posteriore "RAIN" Rear light "RAIN"	LT 010	€ 0,00
---	--------	--------

FOR RACING USE ONLY

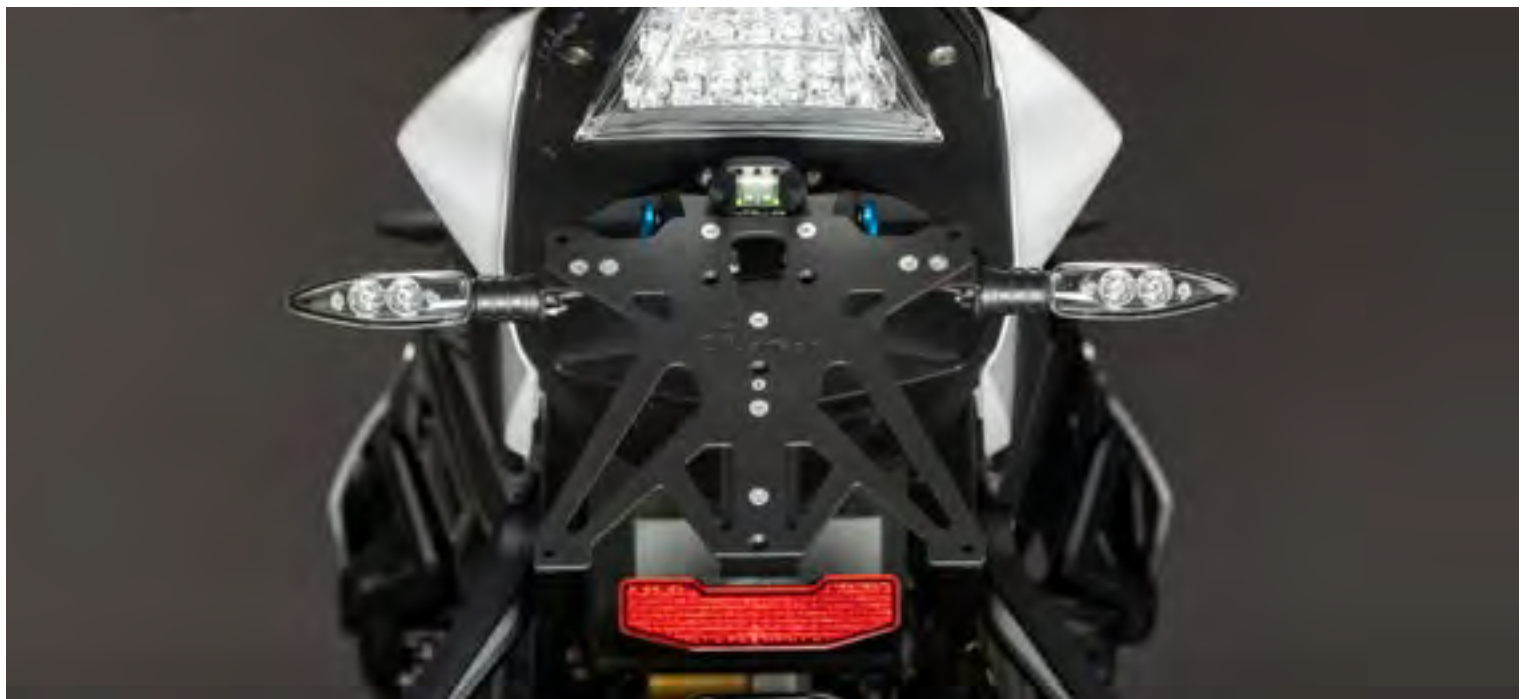



Kit resistenza - Resistors kit
10W / 6 ohm
FRE001 € 6,50



Kit resistenza - Resistors kit
25W / 10 ohm
FRE002 € 10,00



Kit resistenza - Resistors kit
5W / 22 ohm
FRE003 € 7,00
FRE004 € 7,00
FRE005 € 7,00



Kit resistenza - Resistors kit
10w - 27 ohm
21w - 8 ohm
21 w- 10 ohm
FRE003 € 7,00
FRE004 € 7,00
FRE005 € 7,00



Kit connettori per indicatori di direzione
(verificare sempre compatibilità) /
Plugs kit for turn signals (always check
compatibility)
Honda FRE006 € 7,50
Yamaha FRE007 € 7,50
Suzuki FRE008 € 7,50
Kawasaki FRE009 € 7,50



Relè elettronico / Electronic relé
FRE010 € 14,50
Intermittenza fissa /
Fix intermittent signal
12v -180w - 15A



Relè elettronico / Electronic relé
FRE011 € 22,00
Intermittenza regolabile /
Adjustable intermittent signal
12,8v - (1-> 100w) - 15A



Kit resistenza - Resistors kit
FRE012 € 19,50
Intermittenza fissa /
Fix intermittent signal
12,8v - (1-> 100w) - 15A



Relè elettronico / Electronic relé
FRE013 € 17,00
Intermittenza fissa / Fix intermittent signal
Specifico per / Specific for: Honda



Relè elettronico / Electronic relé
FRE014 € 12,00
Intermittenza fissa / Fix intermittent signal
Specifico per / Specific for: Honda Honda, Kawasaki, Yamaha
12v - 120w - 10A



Kit resistenza - Resistors kit
FRE015 € 25,00
Intermittenza fissa / Fix intermittent signal
Specifico per / Specific for: Suzuki
(12->13,8v) 1->100w

BORN
TO BE
MOTO



A close-up photograph of a motorcycle engine's timing cover. The cover is primarily a dark, metallic color, likely aluminum, with a black protective plate mounted on top. The plate features a textured surface and a logo that reads "Ducati". The engine components are visible through various openings and are secured with several screws. The lighting is dramatic, highlighting the metallic textures and the protective plate.

**PROTEZIONI
IN ALLUMINIO**
ALUMINIUM
PROTECTIONS

FINE SERIE - END STOCK

Modello - Model	Anno - Year		Articolo - Article	Codice - Code	€
	dal - from	al - to			
APRILIA					
RSV4 R + FACTORY + APRC	09	20	Copri Alternatore lato L / Electric Cover L Side	ECPAP001	102,00
			Copri Frizione lato R / Clutch Cover R Side	ECPAP002	206,00
BMW					
S 1000 RR / S1000 R	09	18	Copri Alternatore lato L / Electric Cover L Side	ECPBM001	156,00
			Copri Pick Up lato R / Pick Up Cover R Side	ECPBM003	71,00
S 1000 RR	19	20	Copri Alternatore / Electric Cover	ECPBM002	90,00
			Copri Frizione - Pick Up / Pick Up - Clutch Cover	ECPBM004	192,00
DUCATI					
848 / 1098 / 1198 SBK	07	11	Copri Pompa Acqua / Water Pump Cover	WPPDU002	88,50
			Coperchio ispezione fase / Engine timing cover	ECPDU003	30,00
Diavel	11	17	Copri Pompa Acqua / Water Pump Cover	WPPDU001	88,50
Hypermotard 796 / 1100	07	12	Copri Pompa Acqua / Water Pump Cover	WPPDU002	88,50
Hypermotard 821 / Hyperstrada 821	13	16	Coperchio ispezione fase / Engine timing cover	ECPDU003	30,00
			Copri Pignone / Front sprocket cover	ECPDU004	78,00
			Copri Pompa Acqua / Water Pump Cover	WPPDU002	88,50
Hypermotard 939 - 950	17	20	Copri Pompa Acqua / Water Pump Cover	WPPDU003	88,50
Monster 821	14	20	Copri Pompa Acqua / Water Pump Cover	WPPDU003	88,50
Monster 1200	13	16	Copri Pompa Acqua / Water Pump Cover	WPPDU002	88,50
	17	20	Copri Pompa Acqua / Water Pump Cover	WPPDU003	88,50
Multistrada 1200	07	14	Coperchio ispezione fase / Engine timing cover	ECPDU003	30,00
			Copri Pompa Acqua / Water Pump Cover	WPPDU002	88,50
	15	19	Copri Pompa Acqua / Water Pump Cover	WPPDU003	88,50
Panigale 1199	12	15	Copri Alternatore lato L / Electric Cover L Side	ECPDU001	172,00
			Copri Frizione lato R / Clutch Cover R Side	ECPDU002	156,00
Panigale V4	18	20	Copri Alternatore lato L / Electric Cover L Side	ECPDU007	172,00
			Copri Frizione lato R / Clutch Cover R Side	ECPDU006	156,00
Streetfighter 848 / 1100	09	16	Copri Pompa Acqua / Water Pump Cover	WPPDU002	88,50
			Coperchio ispezione fase / Engine timing cover	ECPDU003	30,00



ECPAP001



ECPAP002



ECPBM002



ECPBM004



ECPBM001



ECPBM003



ECPDU006



ECPDU007



WPPDU003

ECPBM004



PROTEZIONE CARTER



ECPKA001



ECPKA002



ECPMV002

Modello - Model	Anno - Year		Articolo - Article	Codice - Code	€
	dal - from	al - to			
KAWASAKI					
Ninja 300	13	17	Copri Alternatore lato L / Electric Cover L Side	ECPKA004	97,00
			Copri Frizione lato R / Clutch Cover R Side	ECPKA003	128,00
ZX 10R	11	20	Copri Pick Up lato Dx / Pick Up Cover R Side	ECPKA001	102,00
			Copri Alternatore lato L / Electric Cover L Side	ECPKA002	133,00
MV AGUSTA					
B3 675 / 800	12	17	Copri Alternatore lato L / Electric Cover L Side	ECPMV003	120,00
			Copri Frizione lato R / Clutch Cover R Side	ECPMV004	151,00
F3 675 / 800	12	17	Copri Alternatore lato L / Electric Cover L Side	ECPMV003	120,00
			Copri Frizione lato R / Clutch Cover R Side	ECPMV004	151,00
Dragster 800	14	17	Copri Alternatore lato L / Electric Cover L Side	ECPMV003	120,00
			Copri Frizione lato R / Clutch Cover R Side	ECPMV004	151,00
RIVALE 800	14	17	Copri Alternatore lato L / Electric Cover L Side	ECPMV003	120,00
			Copri Frizione lato R / Clutch Cover R Side	ECPMV004	151,00
SUZUKI					
GSXR 1000	17	20	Copri Alternatore lato L / Electric Cover L Side	ECPSU006	182,00



ECPSU006



ECPYA008



ECPYA009



ECPYA004



ECPYA005



ECPYA006

Modello - Model	Anno - Year		Articolo - Article	Codice - Code	€
	dal - from	al - to			
YAMAHA					
MT10	16	20	Copri Frizione lato R / Clutch Cover R Side	ECPYA005	151,0
			Copri Pick Up lato R / Pick Up Cover R Side	ECPYA006	99,00
R1	15	20	Copri Alternatore lato L / Electric Cover L Side	ECPYA004	140,0
			Copri Frizione lato R / Clutch Cover R Side	ECPYA005	151,0
			Copri Pick Up lato R / Pick Up Cover R Side	ECPYA006	99,00
R6	06	20	Copri Alternatore lato L / Electric Cover L Side	ECPYA001	146,0
			Copri Frizione lato R / Clutch Cover R Side	ECPYA009	170,0
			Copri Pick Up lato R / Pick Up Cover R Side	ECPYA008	120,0
T-MAX 500 - 530	06	16	Kit copri carter / Carter cover kit	STEYA002	125,0
T-MAX 530 - 560	17	20	Kit copri carter / Carter cover kit	ECPYA010	xxx



BORN
TO BE
MOTO



PROTEZIONI
PROTECTIONS

 **LightTech**
made in Italy





Colori disponibili: nero. Available colours: black

Right = destro / right Left = sinistra / left ø = foro interno boccola / internal bush hole

Modello - Model	foro carena - drill fairing	Anno - Year		ø mm	Codice - Code	€
		dal - from	al - to			
APRILIA						
DORSODURO 750/1200	/	08	17	10	STEAP201	77,00
DORSODURO 900	/	18	20	10	STEAP201	77,00
RSV4 / Factory / APRC vedi pagina 148 / see page 148	/	09	14	-	STEAP104	138,0
RSV4 / Factory / APRC vedi pagina 148 / see page 148	/	09	14	-	STEAP105	138,0
RSV4 / APRC / RF / 1100 factory vedi pagina 148 / see page 148	/	15	20	-	STEAP107	138,0
SHIVER 750	/	07	16	10	STEAP201	77,00
SHIVER 900	/	18	20	10	STEAP201	77,00
TUONO V4	/	11	20	10	STEAP203	88,00
TUONO V4 FORO CENTRATO vedi pagina 148 / see page 148	/	11	20	-	STEAP106	138,0
BENELLI						
LEONCINO	/	18	20	10	STEBN201	77,00
BMW						
R nine-T Scrambler	/	16	19	-	STEBM207	38,00
S1000RR	/	09	11	10	STEBM201	75,00
S1000RR / HP4	/	12	14	10	STEBM205	95,00
S1000RR	/	15	18	10	STEBM206	95,00
S1000RR	/	19	20	10	STEBM208	160,00
DUCATI						
HYPERMOTARD 796	/	09	12	10	STEDU205	77,00
HYPERMOTARD 821 / HYPERSTRADA 821	/	13	16	10	STEDU206	77,00
MONSTER 696 - 796 - 1100	/	08	14	10	STEDU202	77,00
SCRAMBLER	/	14	16	10	STEDU207	85,00
STREETFIGHTER 848	/	11	16	10	STEDU205	77,00
STREETFIGHTER 1100	/	09	15	10	STEDU203	77,00



FINE SERIE - END STOCK

Modello - Model	foro carena - drill fairing	Anno - Year		ø mm	Codice - Code	€
		dal - from	al - to			
HONDA						
CB 500 F	/	13	18	10	STEH0213	75,00
CB 650 F	/	17	18	-	STEH0215	75,00
CB 650 R	/	19	20	-	STEH0215	75,00
CB 1000 R	/	08	20	12	STEH0211	75,00
CBF 1000	/	06	12	12	STEH0211	75,00
CBR 600 F	right / left	11	13	12	STEH0201	75,00
CBR 600 RR	right / left	03	06	12	STEH0201	75,00
CBR 600 RR	right / left	09	13	12	STEH0203	75,00
CBR 1000 RR	/	06	07	10	STEH0208	101,00
CBR 1000 RR	right / left	08	16	12	STEH0209	75,00
HORNET 600	/	03	06	10	STEH0204	77,00
HORNET 600	/	07	13	12	STEH0205	75,00

HUSQVARNA						
NUDA 900	/	12	15	12	STEHU201	75,00

KAWASAKI						
ER - 6N	/	12	16	10	STEKA211	103,0
Z125	/	19	19	10	STEKA216	75,00
Z650	/	17	20	10	STEKA214	75,00
Z750	/	04	06	10	STEKA205	75,00
Z750	/	07	12	10	STEKA206	75,00
Z800	/	13	16	-	STEKA112NER	124,0
Z800	/	13	16	-	STEKA112SIL	124,0
Z800	/	13	16	-	STEKA112ROS	124,0
Z900	/	17	20	10	STEKA215	75,00
Z1000	/	03	06	10	STEKA205	75,00
Z1000	/	07	09	10	STEKA206	75,00
Z1000	/	10	18	10	STEKA207	75,00
ZX6R	right / left	05	06	10	STEKA202	75,00
ZX6R	/	07	08	10	STEKA203	88,00
ZX6R / 636	/	13	20	10	STEKA213	88,00
ZX10R	left	08	10	10	STEKA204	75,00
ZX10R	/	11	20	10	STEKA210	77,00



Modello - Model	foro carena - drill fairing	Anno - Year		ø mm	Codice - Code	€
		dal - from	al - to			
KTM						
DUKE 125 / 390	/	17	19	10	STEKT203	108,00
DUKE 790	/	18	19	10	STEKT204	108,00
DUKE 890R	/	20	20	10	STEKT205	xxxx
MV						
BRUTALE 675 / 800	/	12	16	10	STEMV202	77,00
BRUTALE 800	/	17	18	12	STEMV203	77,00
BRUTALE 750 / 910 / 1000 / 1090??	/	01	12	13	STEMV201	82,00
DRAGSTER 800	/	13	16	10	STEMV202	77,00
DRAGSTER 800	/	17	18	12	STEMV203	77,00
RIVALE 800	/	13	16	10	STEMV202	77,00
SUZUKI						
Gladius 650	/	09	15	10	STESU209	85,00
GSR 600	/	06	11	10	STESU208	75,00
GSR 750	/	11	16	10	STESU211	75,00
GSXR 600 / 750	/	08	10	10	STESU202	90,00
GSXR 600 / 750	/	11	17	10	STESU210	103,0
GSXR 1000	/	05	06	10	STESU204	75,00
GSXR 1000	/	07	08	10	STESU205	75,00
GSXR 1000	/	09	16	10	STESU206	103,0
GSXR 1000	/	17	20	10	STESU215	134,0
GSX-S 750	/	17	20	10	STESU214	75,00
GSX-S 1000	/	15	20	10	STESU212	75,00
SV 650	/	16	17	10	STESU213	75,00
TRIUMPH						
Speed Triple 1050	/	08	10	12	STETR202	75,00
Speed Triple 1050	/	11	16	12	STETR204	75,00
Street Triple 675 / 675R	/	07	10	10	STETR203	75,00
Street Triple 675 / 675R	/	11	16	10	STETR205	75,00
Street Triple 765 / 765R	/	17	17	10	STETR205	75,00
YAMAHA						
FAZER 600 / FZ6	/	04	12	10	STEYA205	75,00
FZ1	/	06	15	10	STEYA206	75,00
FZ8	/	10	15	10	STEYA206	75,00
MT-03	/	06	14	10	STEYA208	101,00
MT-03 (cc 300)	/	15	18	10	STEYA217	75,00
MT-07	/	14	20	10	STEYA212	75,00
MT-09	/	13	16	10	STEYA211	75,00
MT-09 / SP	/	17	20	10	STEYA215	75,00
MT-09 Tracer / XSR 900	/	13	20	10	STEYA211	75,00
MT-10	/	16	20	12	STEYA213	75,00
R1 / R1-M	/	15	20	12	STEYA213	75,00
R3	/	15	18	10	STEYA214	75,00
R6	/	06	07	10	STEYA203	85,00
R6	/	08	16	10	STEYA204	85,00
R6	/	17	20	10	STEYA216	175,00
XJ6	/	09	15	10	STEYA207	101,00



ANELLI IN ALLUMINIO IN 6 COLORI
 ALUMINIUM RINGS AVAILABLE IN 6 COLORS



RSTE102ARA

RSTE102ROS

RSTE102ORO

RSTE102VER

RSTE102COB

RSTE102NER

RSTE102SIL

€ 9,20

a coppia - for pair

GOMMINO SHOCK ABSORBER
 SHOCK ABSORBER RUBBER

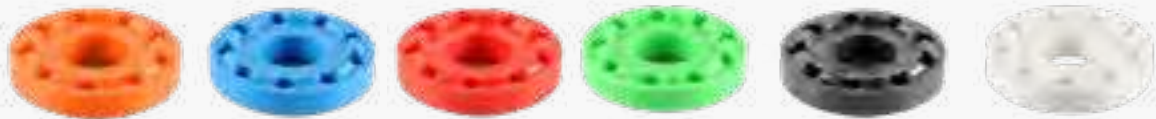

RSTE101ARA

RSTE101BLU

RSTE101ROS

RSTE101VER

RSTE101NER

RSTE101BIA

€ 10,40

a coppia - for pair



RICAMBIO PER NUOVA "SERIE 200"
 SPARE PARTS FOR NEW VERSION "200"

a pezzo - for piece

Ricambio protezione - Slider spare part	ø10	RSTE210	€ 24,50
Ricambio protezione - Slider spare part	ø12	RSTE212	€ 24,50
Ricambio protezione - Slider spare part	ø13	RSTE213	€ 24,50



* Controllare posizione vite / Check bolt position



APRILIA RSV4

Code: STEAP104

• Posizione: alto
Upper position



Code: STEAP105

• Posizione: centrale
Central position



Code: STEAP107

• Posizione: basso
Lower position



APRILIA TUONO V4

Code: STEAP106

• Posizione: centrale
Central position



APRILIA RSV4



**PROTEZIONI
PERNI RUOTA**
WHEEL AXLE SLIDERS

PROTEZIONI PERNI RUOTA

150 WHEEL AXLE SLIDERS

NEW LOOK

- Insetto smart plug
Smart plug insert
- Combinazioni colori dedicate
Dedicated color combinations

Maggior protezione agli urti
Greater impact protection



Evoluzione delle linee
Evolution of the lines



Colori disponibili - Available colours:



cobalto
cobalt



rosso
red



verde
green



oro
gold



nero
black



































silver
silver













arancione
orange

Modello - Model	Anno - Year	Codice - Code	€	Front / Rear	a kit - for kit	
					dal - from	al - to
APRILIA						
DORSODURO 750 / 1200	08 - 17	WAPAP401	58,00	F+R		
DORSODURO 900	18 - 20	WAPAP401	58,00	F+R		
RSV4 R+ Factory + APRC	09 - 20	WAPAP401	58,00	F+R		
SHIVER 750	07 - 16	WAPAP401	58,00	F+R		
TUONO V4	11 - 20	WAPAP401	58,00	F+R		
BMW						
S1000R	14 - 19	WAPBM401	58,00	F+R		
S1000RR	09 - 20	WAPBM401	58,00	F+R		
DUCATI						
DIAVEL	11 - 17	WAPDU401	47,50	F		
HYPERMOTARD 821 / HYPERSTRADA 821	13 - 16	WAPDU403	33,50	F		
MONSTER 821	14 - 16	WAPDU405	58,00	F+R		
MONSTER 1100	11 - 13	WAPDU402	33,50	F		
MONSTER 1200 / R	14 - 17	WAPDU403	33,50	F		
PANIGALE 959	15 - 19	WAPDU408	58,00	F+R		
PANIGALE 1199	12 - 14	WAPDU401	47,50	F		
		ARDU110	89,00	R		
PANIGALE 1299	15 - 17	WAPDU409	47,50	F		
		ARDU110	89,00	R		
PANIGALE V4	18 - 20	WAPDU409	47,50	F		
		ARDU110	89,00	R		
STREETFIGHTER 848	11 - 16	WAPDU402	33,50	F		
STREETFIGHTER 1100	09 - 15	WAPDU403	33,50	F		

Modello - Model	Anno - Year	Codice - Code	€	Front / Rear		
	dal - from	al - to	a kit - for kit			
HONDA						
CB 650 F		14	15	WAPHO404	33,5	F
CB 1000 R		18	18	WAPHO407	33,5	F
CBR 600 RR		07	12	WAPHO401	68,00	F+R
CBR 600 RR		13	13	WAPHO403	68,00	F+R
CBR 600 RR		14	16	WAPHO401	68,00	F+R
CBR 1000 RR		08	16	WAPHO402	68,00	F+R
CBR 1000 RR		17	18	WAPHO405	68,00	F+R
XADV		17	18	WAPHO406	68,00	F+R
KAWASAKI						
ZX6R		07	12	WAPKA401	58,00	F+R
ZX6R / 636		13	20	WAPKA405	58,00	F+R
ZX10R		06	20	WAPKA401	58,00	F+R
Z650		17	20	WAPKA407	58,00	F+R
Z 800		13	16	WAPKA406	33,50	F
Z900		17	20	WAPKA408	58,00	F+R
Z 1000 - SX		14	19	WAPKA406	33,50	F
KTM						
DUKE 790		18	20	WAPKT402	58,00	F+R
SUPER DUKE 1290		17	19	WAPKT401	33,50	F
SUPER DUKE 1290		17	19	WAPKT403	89,00	R
MV AGUSTA						
BRUTALE		10	16	WAPMV401	33,50	F
				ARMV102	89,00	R
B3 675 / B3 800		12	16	WAPMV401	33,50	F
				ARMV102	89,00	R
F3 675 / F3 800		12	16	WAPMV401	33,50	F
				ARMV102	89,00	R
F4		10	16	WAPMV401	33,50	F
				ARMV102	89,00	R
RIVALE 800		14	16	WAPMV401	33,50	F
				ARMV102	89,00	R
SUZUKI						
GSXR 600 / 750		06	10	WAPSU401	68,00	F+R
GSXR 600 / 750		11	17	WAPSU402	58,00	F+R
GSXR 1000		07	11	WAPSU401	68,00	F+R
GSXR 1000		12	16	WAPSU403	58,00	F+R
GSXR 1000		17	20	WAPSU405	58,00	F+R
GSX-S 750		17	20	WAPSU406	58,00	F+R
GSX-S 1000		15	20	WAPSU404	58,00	F+R
TRIUMPH						
DAYTONA 675 / 675R		13	13	WAPTR401	58,00	F+R
STREET TRIPLE 675 / 675R		13	13	WAPTR401	58,00	F+R
STREET TRIPLE 765 / 765R		17	19	WAPTR402	33,50	F

PROTEZIONI PERNI RUOTA

152 WHEEL AXLE SLIDERS

Modello - Model		Anno - Year		Codice - Code	€	Front / Rear
		dal - from	al - to			
YAMAHA						
MT-07		14	20	WAPYA403	33,50	F
				ARYA104	68,00	R
MT-09 + MT09 TRACER + XSR900		13	16	WAPYA402	58,00	F+R
MT-09 + MT09 TRACER GT		17	20	WAPYA410	58,00	F+R
MT-10		16	20	WAPYA411	58,00	F+R
R6		06	16	WAPYA401	68,00	F+R
R6		17	20	WAPYA411	58,00	F+R
R1		07	14	WAPYA401	68,00	F+R
R1 / R1M		15	20	WAPYA411	58,00	F+R
T-Max 500		08	11	WAPYA412	33,50	F
T-Max 530		12	14	WAPYA405	58,00	F+R
T-Max 530 - 560		15	20	WAPYA409	68,00	F+R

RICAMBIO INTERNO PER PROTEZIONI PERNO RUOTA LIGHTTECH

REPLACEMENT INTERNAL PART FOR LIGHTTECH'S WHEEL AXLE SLIDERS



KWAP001COB

KWAP001ROS

KWAP001VER

KWAP001ORO

KWAP001NER

KWAP001SIL

KWAP001ARA

€ 9,20

a coppia - for pair



VITERIA
BOLTS





VITI SPECIAL IN ERGAL 7075

7075 ERGAL SPECIAL BOLTS

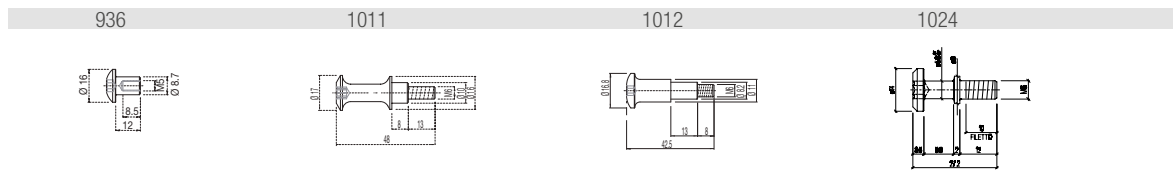
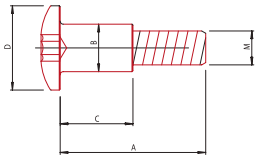



M	A	B	C	D	Codice - Code	€
8	38,5	12,4	19	22	930	4,90
10	49	12,4	18,5	22	931	4,90
10	38	12,4	19	22	931B	4,90
4	12	-	-	9	932	1,90
6	19,5	7,5	3,5	14	933	3,10
10	56,5	11,9	22,5	19	934	7,30
8	38,5	11,9	22,5	19	935	6,10
5	12	8,7	12	16	936	5,60
6	17,4	7,9	8,4	17	940	3,10
5	15	7,4	7,5	12	941	2,80
6	20	-	-	10	950	3,10
8	31	10	6	17	951	3,70
8	41	9,9	6	16	952	4,30
8	20	9,9	5	17	953	4,30
6	30	6	9	10	954	3,10
6	23,5	9,9	11	20	955	4,30
6	15	-	-	10	956	3,10
8	33	9,9	11	15	960	3,70
10	25	9,9	4	15	961	3,70
5	16,5	8,1	3,7	14	962	2,80
6	20	7,9	9,5	18	963	3,10
7	17,5	10,9	5,5	24	964	3,10
6	15	7,9	3	14	965	3,10
4	21,5	4	5,5	10	970	2,50
4	7	-	-	10	971	2,20

M	A	B	C	D	Codice - Code	€
6	11,5	8,2	3,75	14	972	2,80
6	15	9,85	5	22	974	3,10
6	19	7,9	8	14	976	3,10
6	30,5	8	23,5	14	977	3,70
6	15	7,9	6	14	978	3,10
6	13	6,9	4,4	14	979	2,50
6	14	7,9	3,8	14	980	3,10
5	15,6	7,9	2,6	14	981	2,80
6	16	8,4	3,5	14	982	3,10
6	15	7,9	6	17	983	3,10
6	15	8,9	4	14	984	3,10
6	30	6	11	12	991	3,10
6	11	9,9	3,5	17	992	2,80
5	10	8,9	3	14	993	2,60
6	14,5	9,4	6	17	994	3,10
6	14,5	11,9	3,5	17	995	3,10
6	15	8,9	5	14	997	3,10
6	15	9,9	3,5	17	998	2,80
5	15	7	2,5	11,5	999	3,10
6	15	9	2	14	1000	3,10
5	20,5	7	13,5	12	1001	3,10
5	20,5	6,9	2,5	12	1002	3,10
6	11	8,2	4	14	1003	3,10
6	14	7,9	5,5	14	1004	5,70
6	15	9,8	5,5	22	1005	2,90
10	40	10	5	16	1006	3,70
6	20	6	1,5	30	1007	4,90
6	25,5	8	13,5	17	1008	3,70
5	25	-	-	9	1009	3,10
6	21	10	8	17	1011	4,70
6	21	8,25	13	17	1012	4,70
6	25,5	8	10,5	24	1013	4,70
5	16	8,2	8	14	1015	3,10
6	16,5	8,5	3,5	17	1016	3,20
6	16,5	8,2	5	12	1018	3,20
6	20	9,8	8,6	17	1019	3,70
5	17	8,2	5,8	14	1020	3,20
6	20	8,7	9,2	14	1021	3,70
5	12,8	8,1	3,7	14	1022	2,80
5	11	8	2,6	14	1023	3,10
6	-	-	-	-	1024	3,80
					1025	6,10
					1027	2,80
					1028	2,80
5	-	-	-	10	1030	2,60
5	17	7,4	5,5	12	1031	2,80
5	20	7,4	9,5	12	1032	2,80
8	25	11,9	10	19	1033	4,30
6	16,5	8,6	3,5	17	1034	3,70
6	20	8,5	10	17	1035	3,70
5	13	8	-	12	1036	2,80
5	17	8,5	6	12	1037	2,80

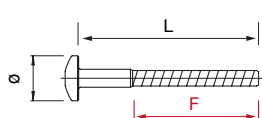

Viti forate - Drilled bolts		lunghezza - length	ø testa - head	Codice - Code	€
		M5 15	12	FORM515	4,90
		M5 20	12	FORM520	5,00
		M6 15	17	FORM615	5,70
		M6 20	17	FORM620	5,80
		M6 25	17	FORM625	5,90
		M6 30	17	FORM630	6,00
		M8 20	22	FORM820	6,10
		M8 30	22	FORM830	6,40
		M8 40	22	FORM840	6,60
		M8 45	22	FORM845	6,70

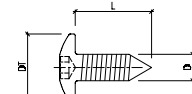

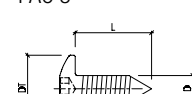
Ergal 7075 / Autofilettanti - Self tapping bolts		Ø	lunghezza - length	ø testa - head	Codice - Code	€
		4,5	13	10	PAC24513	3,40
		4,5	16	10	PAC24516	3,60
		4,9	13	10	PAC24913	3,40
		4,9	16	10	PAC24916	3,60
		5,5	16	10	PAC25516	3,60
		5,5	19	10	PAC25519	3,80
		4,5	13	14	PAC34513	3,40
		4,5	16	14	PAC34516	3,60
		4,9	13	14	PAC34913	3,40
		4,9	16	14	PAC34916	3,60
		5,5	16	14	PAC35516	3,60
		5,5	19	14	PAC35519	3,80

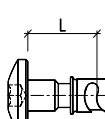

Ergal 7075 / Ganci rapidi - Quick fairing fasteners		misura - measure	Codice - Code	€
		11 mm	GR11	5,60
		12 mm	GR12	5,60
		14 mm	GR14	5,90
		16 mm	GR16	6,50
		22 mm	GR22	7,40

Ganci rapidi in acciaio - Steel quick fairing fasteners

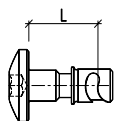

misura - measure	Codice - Code	€
11 mm	GRSTTB11	4,90
12 mm	GRSTTB12	4,90
14 mm	GRSTTB14	4,90

Ganci rapidi in ferro - Iron quick fairing fasteners

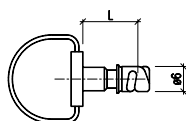

misura - measure	Codice - Code	€
11 mm	GRFE11	4,90
12 mm	GRFE12	4,90
14 mm	GRFE14	4,90

Ricettacoli - Receptacle



Codice - Code	€
RIC	1,80



Cappelletto valvola ruota - Wheel valve cap



Codice - Code	€
VAL	3,00

Viteria ergal 7075 - 7075 ergal bolts



Nm

Ergal 7075

M3	M4	M5	M6	M8	M10	M12	M14	M16
0,75	1,50	3,00	5,20	12,30	25,00	42,40	67,50	102,5



0011	M4	M5	M6	M8	M10 x 1,25	M10 x 1,5	M12 x 1,25
€	2,80	2,90	3,30	4,30	5,30	5,30	6,10
0012					M10 x 1		
€					5,30		
0013							M12 x 1,5
€							6,10



0015	M4	M5	M6	M8
€	2,80	2,90	3,30	4,30



0016	M5	M6	M8
€	2,90	3,30	4,30



Standard

misura - measure	ø est. ø ext.	spessore - thickness	Codice - Code	€
M4	9	0,8	RM4	0,72
M5	10	1,5	RM5	0,72
M6	12	1,6	RM6	0,72
M8	17	1,6	RM8	0,95
M10	21	2	RM10	1,05



Special

misura - measure	ø est. ø ext.	spessore - thickness	Codice - Code	€
M5	17	1,6	RSM5A	0,93
M5	21	1,6	RSM5B	0,93
M6	17	1,6	RSM6A	0,93
M6	21	1,6	RSM6B	1,05
M8	21	2	RSM8A	1,05
M10	30	2	RSM10	1,60



misura - measure	ø est. ø ext.	spessore - thickness	Codice - Code	€
M5	15	5	RCM5	1,20
M6	22	4	RCM6	1,50
M8	25	5,5	RCM8	2,10

Viti in titanium grado 5 - 5th degree titanium bolts



Nm

TIT. 6AV4V G5

M3	M4	M5	M6	M8	M10	M12	M14	M16
1,73	3,57	6,90	11,10	28,30	57,60	97,50	155,20	235,70



T0015	M4	M5	M6	M8	M10 x 1,25	M10 x 1,5	M12 x 1,25
€	5,70	6,6	7,3	10,00	13,00	13,00	17,60



Standard

misura - measure	Ø est. Ø ext.	spessore - thickness	Codice - Code	€
M4	9	0,8	RM4T	1,80
M5	10	1,5	RM5T	2,00
M6	12	1,6	RM6T	2,20
M8	17	1,6	RM8T	2,80
M10	21	2	RM10T	3,30



Special

misura - measure	Ø est. Ø ext.	spessore - thickness	Codice - Code	€
M5	17	1,6	RSM5AT	2,80
M6	17	1,6	RSM6AT	2,80
M6	21	1,6	RSM6BT	3,30
M8	21	2	RSM8AT	3,30
M10	30	2	RSM10T	5,90

RONDELLE IN NYLON - NYLON WASHERS



misura - measure	Ø est. Ø ext.	spessore - thickness	Codice - Code	€
M4	10	0,5	RPM4	0,32
M5	12	0,5	RPM5	0,32
M6	14	0,5	RPM6	0,32
M8	16	0,5	RPM8	0,32

VITI DISCHI FRENO IN TITANIO GRADO 5

164 BOLTS FOR BRAKE DISK IN TITANIUM 5 DEGREE

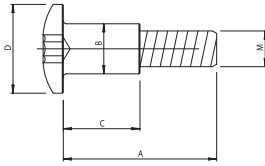
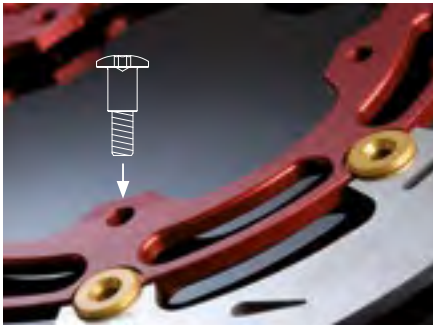

I Modelli di moto citati sono indicativi, pertanto si consiglia di verificare le misure delle viti.

The motorbikes mentioned can be not correct, please control the measures.

FINE SERIE - END STOCK

moto - bike	M	A	B	C	D	Codice - Code	€
							a pezzo - for piece
KAWASAKI	8	31	10	5	18	VIT K	18,20
SUZUKI	8	33	10	10	16	VIT S	17,20
SUZUKI	8	21	9,9	6	16	VIT S2	17,20
DUCATI	8	15	-	-	13	VIT D1	10,90
HONDA ANT. / front	6	20	-	-	15	VIT H1	14,60
HONDA POST. / rear	8	23	10	5	16	VIT H2	14,60
HONDA CR. ANT. / front	8	20	-	-	12	VIT H3	12,00
YAMAHA ANT. / front	6	21	8	6	14	VIT Y	17,20
YAMAHA POST. / rear	8	20	9,8	4,5	16	VIT Y2	17,20

RACCORDERIA FRENO BRAKE PARTS

FINE SERIE - END STOCK



Modello - Model	misura - measure	Codice - Code	€
Bullone singolo Single banjo bolt	M 10 X 1	VF11	4,60
	M 10 X 1,25	VF1251	4,60



Modello - Model	misura - measure	Codice - Code	€
Bullone doppio Double banjo bolt	M 10 X 1	VF12	6,25
	M 10 X 1,25	VF1252	6,25



Modello - Model	misura - measure	Codice - Code	€
Bullone singolo con spurgo Single banjo bolt with bleeder	M 10 X 1	VF11SP	5,60
	M 10 X 1,25	VF1251SP	5,60



Modello - Model	misura - measure	Codice - Code	€
Bullone doppio con spurgo Double banjo bolt with bleeder	M 10 X 1	VF12SP	7,30
	M 10 X 1,25	VF1252SP	7,30



Modello - Model	misura - measure	Codice - Code	€
Spurgo Bleeder	M6	SPM6	3,15
	M7	SPM7	3,50
	M8	SPM8	3,70
	M 10 x 1	SPM10	4,70

A close-up, front-facing view of a motorcycle's front fairing. The central focus is a large, black, vertically-oriented mesh screen. This screen is held in place by four bright green bolts, two on each side. Below the mesh is a prominent, bright green V-shaped fairing element. At the very bottom, a clear, multi-faceted headlight is visible. The surrounding motorcycle bodywork is primarily black with silver accents. On the left side, a green component with the text 'L50R' is partially visible. The background is a dark, neutral grey.

KIT VITI
BOLT KIT



Modello Model	Anno Years		MOTORE / ENGINE			TELAIO / FRAME			CARENA / FAIRING		
	dal - from	al - to	Quantità Pieces	Codice Code	€	Quantità Pieces	Codice Code	€	Quantità Pieces	Codice Code	€

APRILIA											
DORSODURO 750	08	16	24	9AD M	40,50	29	9AD T	72,10	31	9AD C	76,00
DORSODURO 1200	11	16	26	1AD M	61,40	25	1AD T	70,10	36	1AD C	90,40
RSV 1000 R	05	08	56	5A1 M	116,6	33	5A1 T	88,20	67	5A1 C	130,90
RSV 4 R+ Factory + APRC+RF	09	20	30	9A4 M	67,10	22	9A4 T	65,60	44	9A4 C	94,60
SHIVER	07	12	38	7A7 M	93,50	27	7A7 T	68,40	42	7A7 C	102,40
TUONO V4	11	20	34	1AT M	73,30	28	1AT T	87,60	42	1AT C	96,90

BMW											
S 1000 R	14	14	38	4BS M	93,40	25	4BS T	76,10	50	4BS C	118,10
S 1000 RR	09	14	38	0B1 M	93,40	23	0B1 T	51,20	66	0B1 C	134,80
S 1000 RR	15	18	34	5B1 M	83,30	19	5B1 T	58,30	63	5B1 C	196,80
S 1000 RR	19	20	19	9B1 M	47,30	14	9B1 T	50,80	23	9B1 C	65,00

DUCATI											
848	08	12	24	8D8 M	43,40	16	8D8 T	38,40	77	8D8 C	176,20
1098 - 1198	07	11	26	7D1M	45,10	20	7D1 T	45,90	73	7D1 C	165,70
DIAVEL	11	16	35	2DD M	85,70	23	2DD T	67,40	42	2DD C	88,80
DS 1200 MULTISTRADA	10	12	34	0D1 M	58,60	23	0D1 T	61,80	76	0D1 C	158,90
HYPERMOTARD 1100	07	12	34	7DM M	58,50	24	7DM T	50,90	31	7DM C	79,20
HYPERMOTARD 821	13	15	44	3DH M	75,60	21	3DH T	64,50	54	3DH C	129,80
MONSTER 696	08	13	42	8D6 M	81,50	14	8D6 T	52,10	47	8D6 C	95,40
MONSTER 821	14	17	48	4D8 M	84,60	12	4D8 T	42,80	41	4D8 C	86,50
MONSTER 1100	11	13	39	1DM M	68,10	20	1DM T	58,00	38	1DM C	70,60
MONSTER 1200 / R	17	20	41	1D7 M	91,85	12	1D7 T	42,70	42	1D7 C	87,35
PANIGALE 1199 / 1199 R	12	14	24	2DP M	44,60	24	2DP T	64,10	62	2DP C	137,40
PANIGALE 1299 / 1299 R	15	17	16	6D1 M	36,60	20	6D1 T	56,20	73	6D1 C	156,70
STREETFIGHTER 848	11	14	42	1D8 M	76,40	17	1D8 T	65,70	73	1D8 C	143,60
STREETFIGHTER 1100	09	14	47	9DS M	82,00	13	9DS T	38,80	70	9DS C	135,50

HONDA											
CB500 F	13	15	34	3H5 M	81,50	21	3H5 T	67,40	41	3H5 C	101,10
CB650 F	14	17	25	4H6 M	61,00	39	4H6 T	110,00	36	4H6 C	89,50
CB 1000 R	08	17	25	8HB M	60,90	32	8HB T	96,10	31	8HB C	71,70
CB 1000 R	18	20	30	1H8 M	73,6	24	1H8 T	77,55	29	1H8 C	59,45
CBR 600 F	11	14	21	1H6 M	51,30	25	1H6 T	85,60	35	1H6 C	81,80
CBR 250 RR	11	14	24	2H5 M	59,10	20	2H5 T	53,60	34	2H5 C	78,00
CBR 600 RR	07	08	25	7H6 M	60,60	27	7H6 T	85,30	59	7H6 C	129,80
CBR 600 RR	09	12	-	-	-	30	9HC T	92,20	63	9HC C	140,00
CBR 600 RR	13	16	12	6H6 M	30,00	32	6H6 T	94,70	63	6H6 C	144,00
CBR 1000 RR	06	07	30	6H1 M	76,60	24	6H1 T	78,10	68	6H1 C	159,00
CBR 1000 RR	08	11	26	8H1 M	63,10	26	8H1 T	79,30	43	8H1 C	96,70
CBR 1000 RR	12	14	17	2HB M	42,70	27	2HB T	86,00	48	2HB C	113,20
CBR 1000 RR	17	19	24	1H7 M	58,60	28	1H7 T	93,20	36	1H7 C	80,50
CRF 450	08	09	37	8H4 M	90,40	17	8H4 T	36,10	27	8H4 C	62,70
CRF 450	10	11	39	0H4 M	96,50	6	0H4T	16,10	38	0H4C	88,20
HORNET 600	07	10	26	7HH M	63,20	27	7HH T	88,50	34	7HH C	84,90
HORNET 600	11	13	26	1HH M	63,20	25	1HH T	82,40	30	1HH C	68,40
INTEGRA 700	12	13	-	-	-	11	2H1T	45,70	29	2H1C	66,60
NC 700 X	12	13	35	3H7 M	83,20	19	3H7 T	68,00	28	3H7 C	77,60
XADV 750	17	20	-	-	-	18	7H7 T	65,40	24	7H7 C	79,20



Only for some Kawasaki models

Modello Model	MOTORE / ENGINE				TELAIO / FRAME			CARENA / FAIRING			
	Anno Years	Quantità Pieces	Codice Code	€	Quantità Pieces	Codice Code	€	Quantità Pieces	Codice Code	€	
	dal - from	al - to									
HUSQVARNA											
NUDA 900	12	14	45	1Q9 M	103,00	18	1Q9 T	58,20	37	1Q9 C	78,50
KAWASAKI											
ER-6N	09	11	33	9KR M	78,20	18	9KR T	52,40	40	9KR C	91,70
ER-6N	12	14	33	2KR M	78,20	14	2KR T	51,40	46	2KR C	95,20
Ninja 250R	09	12	12	9K2 M	28,80	19	9K2 T	81,90	52	9K2 C	111,70
* Ninja 300	13	17	26	3K3 M	62,60	27	3K3 T	101,00	45	3K3C	99,50
* Ninja 400	18	20	27	4K8 M	64,4	36	4K8 T	122,35	32	4K8 C	66,25
* Z 650	17	20	33	6K7 M	78,00	17	6K7 T	69,30	40	6K7 C	82,40
Z 750	07	12	32	7K7 M	79,20	43	7K7 T	142,00	38	7K7 C	86,10
Z 800	13	16	31	3K8 M	76,40	22	3K8 T	75,40	41	3K8 C	88,90
* Z 900	17	20	25	9K7 M	61,20	19	9K7 T	63,40	24	9K7 C	54,50
Z1000	07	08	42	7K1 M	93,60	46	7K1 T	142,70	44	7K1 C	97,50
Z1000	09	09	42	9K1 M	93,60	45	9K1 T	144,20	50	9K1 C	110,50
Z1000	10	13	25	0KZ M	60,50	41	0KZ T	128,30	47	0KZ C	107,20
Z1000	14	14	26	4KZ M	63,40	31	4KZ T	107,30	54	4KZ C	108,40
Z1000 SX	11	13	21	1KS M	51,10	46	1KS T	139,80	50	1KS C	112,60
ZX6R	07	08	37	7K6 M	93,30	26	7K6 T	93,40	64	7K6 C	140,90
ZX6R	09	12	37	9K6 M	92,90	26	9K6 T	91,30	58	9K6 C	119,40
ZX6R	13	16	40	6K6 M	99,90	23	6K6 T	88,40	62	6K6 C	128,10
ZX10 R	04	05	32	4K1 M	74,70	28	4K1 T	98,90	58	4K1 C	122,40
ZX10 R	06	07	36	6K1 M	85,20	35	6K1 T	113,10	57	6K1 C	122,50
ZX10 R	08	10	26	8K1 M	84,60	32	8K1 T	105,40	54	8K1 C	115,50
* ZX10 R	11	15	33	1K1 M	77,90	33	1K1 T	111,90	47	1K1 C	95,00
* ZX10 R	16	20	25	1K6 M	57,60	25	1K6 T	93,30	56	1K6 C	118,60
KTM											
DUKE 125 / 390	17	19	31	8M1 M	74,75	23	8M1 T	68,25	31	8M1 C	74,75
690	07	10	28	7M6 M	67,90	23	7M6 T	55,30	26	7M6 C	63,80
DUKE 690	12	14	27	2M6 M	66,20	22	2M6 T	62,10	43	2M6 C	76,90
SUPER DUKE 990	07	10	29	7M9 M	74,30	30	7M9 T	71,60	21	7M9 C	33,10
MOTO GUZZI											
GRISO	06	15	35	5GG M	59,20	26	5GG T	58,40	47	5GG C	110,30
MV AGUSTA											
BRUTALE 910	04	10	35	MV5 M	75,60	15	MV5 T	27,60	47	MV5 C	90,10
B3 675	12	16	30	4V6 M	63,10	20	4V6 T	48,80	37	4V6 C	69,40
B3 800	13	16	30	4V6 M	63,10	20	4V6 T	48,80	37	4V6 C	69,40
F3 675	12	14	20	MV3 M	46,00	23	MV3 T	55,30	59	MV3 C	125,10
F3 800	13	16	22	MV8 M	49,10	20	MV8 T	50,20	70	MV8 C	146,20
F4 1000	14	14	12	4V1 M	29,80	22	4V1 T	63,80	37	4V1 C	95,20
RIVALE 800	14	17	28	5M8 M	63,90	26	5M8 T	48,70	73	5M8 C	150,40
SUZUKI											
GLADIUS	09	13	30	9SG M	77,10	20	9SG T	61,70	37	9SG C	97,10
GSR 600	06	11	39	6SR M	99,60	26	6SR T	75,50	28	6SR C	71,90
GSR 750	11	13	34	1SR M	85,90	27	1SR T	81,60	42	1SR C	108,70
GSXR 600/750	06	07	30	6S6 M	76,90	28	6S6 T	79,40	47	6S6 C	117,60
GSXR 600/750	08	10	33	8S6 M	82,60	26	8S6 T	71,00	48	8S6 C	113,70
GSXR 600/750	11	16	31	1SX M	79,30	38	1SX T	106,90	48	1SX C	123,20
GSXR 1000	05	06	38	5S1 M	92,10	38	5S1 T	122,40	46	5S1 C	120,20
GSXR 1000	07	08	32	7S1 M	80,80	39	7S1 T	111,00	48	7S1 C	134,30
GSXR 1000	09	16	25	9S1 M	61,50	22	9S1 T	69,50	49	9S1 C	134,70
GSXR 1000	17	20	25	1X7 M	61,20	-	1X7 T	95,20	33	1X7 C	80,80
GSX-S 750	17	20	31	7S7 M	81,10	-	7S7 T	67,30	31	7S7 C	79,80
GSX-S 1000	15	20	32	5SS M	82,70	26	5SS T	82,00	39	5SS C	104,10

■ rosso red
 ■ cobalto cobalt
 ■ nero black
 ■ oro gold
 ■ silver silver
 ■* verde green
 Only for some Kawasaki models

Modello Model	MOTORE / ENGINE				TELAIO / FRAME			CARENA / FAIRING			
	Anno Years	Quantità Pieces	Codice Code	€	Quantità Pieces	Codice Code	€	Quantità Pieces	Codice Code	€	
dal - from al - to											
TRIUMPH											
DAYTONA 675	07	12	33	7TD M	76,50	34	7TD T	98,10	46	7TD C	102,80
SPEED TRIPLE 1050	08	10	55	8TT M	128,80	24	8TT T	71,00	37	8TT C	88,30
SPEED TRIPLE 1050	11	15	52	0TT M	122,20	33	0TT T	134,60	48	0TT C	118,50
SPEED TRIPLE 1050	16	16	57	6T1 M	132,00	24	6T1 T	66,10	47	6T1 C	97,00
STREET TRIPLE 675 / 675R	07	12	36	7T6 M	83,10	29	7T6 T	86,20	33	7T6 C	81,50
STREET TRIPLE 675 / 675R	13	16	38	3T6 M	87,40	33	3T6 T	95,20	40	3T6 C	91,40
STREET TRIPLE 765 / 765 R	17	18	39	7T7M	90,50	28	7T7T	81,40	34	7T7C	70,00
YAMAHA											
FAZER 600 + FZ6 600	04	12	40	4Y6 M	69,50	24	4Y6 T	76,80	38	4Y6 C	83,50
FZ1	06	15	35	6Y1 M	77,40	22	6Y1 T	71,30	58	6Y1 C	131,90
FZ8	10	15	28	0Y8 M	62,10	28	0Y8 T	82,80	51	0Y8 C	110,20
MT-03	06	13	30	6YM M	64,50	25	6YM T	75,90	44	6YM C	94,80
MT-07	14	20	31	4Y7 M	72,10	22	4Y7 T	71,20	51	4Y7 C	108,50
MT-09	13	16	40	3YM M	93,20	18	3YM T	58,50	44	3YM C	89,30
MT-09 Tracer	15	16	41	5Y9 M	98,30	27	5Y9 T	83,70	50	5Y9 C	149,50
MT-09	17	20	39	9Y7 M	92,80	18	9Y7 T	70,40	33	9Y7 C	85,70
MT-10	16	20	32	6Y0 M	75,70	27	6Y0 T	84,00	42	6Y0 C	86,60
R1	04	06	26	4Y1 M	46,20	28	4Y1 T	93,50	62	4Y1 C	146,10
R1	07	08	33	7Y1 M	58,60	33	7Y1 T	102,80	52	7Y1 C	121,00
R1	09	14	33	9Y1 M	75,80	23	9Y1 T	68,10	52	9Y1 C	119,50
R1	15	19	28	5Y1 M	65,95	27	5Y1 T	77,75	53	5Y1 C	118,90
R1	20	20	28	5Y1 M	65,95	27	5Y1 T	77,75	53	0Y1 C	71,30
R3	15	17	27	5Y3 M	62,60	23	5Y3 T	78,80	45	5Y3 C	92,50
R6	06	07	32	6Y6 M	54,70	28	6Y6 T	90,90	60	6Y6 C	139,60
R6	08	16	32	8Y6 M	54,70	22	8Y6 T	78,10	54	8Y6 C	123,90
R6	17	20	29	6Y7 M	68,50	16	6Y7 T	51,10	31	6Y7 C	73,30
T MAX 500	08	11	17	8YT M	42,40	-	-	-	43	8YT C	108,60
T MAX 530	12	16	-	-	-	16	2YXT	45,10	34	2YX C	82,00
XJ6	08	13	28	8YJ M	65,20	18	8YJ T	61,30	48	8YJ C	104,80
X-MAX 400	13	14	15	3YX M	33,50	-	-	-	39	3YX C	103,70





DADI SPECIALI
SPECIAL NUTS

DADI SPECIALI ERGAL 7075

170 7075 ERGAL SPECIAL NUTS

Nm = coppia MASSIMA di chiusura / Maximum tightening torque



D001
M 25 X 1,5 30
Ø 39 · h 13 Nm 350



D002
M 25 X 1 32
ø 39,5 · h 14 Nm 300



D003
M 24 X 1,5 32
ø 39 · h 17,5 Nm 330



D004
M 18 X 1,5 22
ø 29 · h 14 Nm 140



D005
M 22 x 1 32
ø 39,5 · h 16,5 Nm 250



D006
M 24 x 1 30
ø 37 · h 16,5 Nm 300



D007
M 14 x 1,5 22
ø 29,5 · h 13 Nm 67



D008
38 x 1,5 46
ø 63,5 · h 28,5 Nm 1240



D009
33 x 1,5 41
ø 49,5 · h 14 Nm 900



D010
20 x 1,5 27
ø 34,8 · h 15 Nm 200

POSIZIONE - POSITION

- 1 Perno ruota anteriore / Front wheel axle
- 2 Canotto sterzo / Steering stem head
- 3 Perno forcellone / Swing arm pivot shaft
- 4 Perno ruota posteriore / Rear wheel axle

■ rosso red	■ cobalto cobalt	■ nero black	■ oro gold	■ silver silver
---	---	--	---	--



Modello - Model	Anno - Year	posizione - position 1		posizione - position 2		posizione - position 3		posizione - position 4			
		dal - from	al - to	Codice - Code	€	Codice - Code	€	Codice - Code	€	Codice - Code	€
APRILIA											
Dorsoduro 750		08	13	D001	18,70			D010	18,70	D001	18,70
Dorsoduro 1200		11	13	D001	18,70			D010	18,70	D001	18,70
RSV 1000		04	05	D001	18,70			D010	18,70	D001	18,70
RSV4 / Factory / APRC		09	20	D001	18,70			D010	18,70	D001	18,70
SHIVER 750		07	13	D001	18,70			D010	18,70	D001	18,70
Tuono		06	09					D010	18,70	D001	18,70
Tuono V4		11	20	D001	18,70			D010	18,70	D001	18,70
BMW											
F800R		10	10							D011	18,70
S1000R		14	19					D004	19,30	D003	20,80
S1000RR		09	20			D014	20,30	D004	19,30	D003	20,80



D011
16 x 1,5  22
ø 25,8 · h 14,5 Nm 100



D013
24 x 1,5  32
ø 39,8 · h 14,5 Nm 330



D014
28 x 1  34
ø 42,3 · h 19,7 Nm 520



D018
22 x 1,5  32
ø 38,4 · h 19,5 Nm 270



D019
25 x 1,25  28
ø 33,3 · h 10 Nm 250



D020
38 x 1,5  46
ø 55 · h 19 Nm 1240



D021
35 x 1,5  46
ø 55 · h 18 Nm 960



D022
33 x 1  41
ø 46 · h 16 Nm 850



D023
35 x 1,5  46
ø 55 · h 21 Nm 970

Modello - Model	Anno - Year	posizione - position 1	posizione - position 2	posizione - position 3	posizione - position 4
-----------------	-------------	------------------------	------------------------	------------------------	------------------------

	dal - from	al - to	Codice - Code	€	Codice - Code	€	Codice - Code	€	Codice - Code	€
DUCATI										
748 / 916 / 996 / 998	96	01	D019	19,80					D008 (right side)	52,00
									D009 (left side)	36,40
848	08	11							D020 (right side)	46,80
									D009 (left side)	36,40
HYPERMOTARD 821	13	14							D020 (right side)	46,80
									D009 (left side)	36,40
Hypermotard 1100	07	12	D019	19,80					D008 (right side)	52,00
									D009 (left side)	36,40
Monster / 610 ie	03	07	D019	19,80						

HONDA										
CB 500 F	13	13							D011	18,70
CB 650 F	14	15					D004	19,30	D004	19,30
CB 1000 R	08	17			D006	18,70	D004	19,30	D023	36,40
CBR 250 RR	11	12							D011	18,70
CBR 600 F	11	13			D006	18,70	D004	19,30	D004	19,30
CBR 600 RR	05	06			D006	18,70			D018	20,80
CBR 600 RR	07	16			D006	18,70	D004	19,30	D018	20,80
CBR 1000 RR	04	07					D018	20,80	D018	20,80
CBR 1000 RR	08	16			D022	23,90	D018	20,80	D018	20,80
HORNET 600	03	06			D006	18,70	D007	18,70	D011	18,70
HORNET 600	07	13			D006	18,70	D004	19,30	D004	19,30
HORNET 900	02	08			D006	18,70			D004	19,30
INTEGRA	12	14							D004	19,30
NC700X	12	14							D004	19,30
XADV	17	20							D004	19,30

HUSQVARNA										
NUDA 900	12	15					D007	18,70	D011	18,70

DADI SPECIALI ERGAL 7075

172 7075 ERGAL SPECIAL NUTS

Modello - Model	Anno - Year		posizione - position 1		posizione - position 2		posizione - position 3		posizione - position 4	
	dal - from	al - to	Codice - Code	€	Codice - Code	€	Codice - Code	€	Codice - Code	€
KAWASAKI										
Ninja 250 R	09	12	D007	18,70					D011	18,70
Ninja 300 R	13	16								
ZX6R	03	04			D002	18,70	D010	18,70	D003	20,80
ER - 6N	06	08							D004	19,30
ER - 6N	09	11					D010	18,70	D004	19,30
ER - 6N	12	13							D004	19,30
Z 650	17	20							D004	19,30
Z 750	07	12					D010	18,70	D004	19,30
Z 800	12	16							D004	19,30
Z 900	17	20							D004	19,30
Z 1000	03	06					D010	18,70	D003	20,80
Z 1000	07	09					D010	18,70	D003	20,80
Z 1000 / Z1000 SX	10	16					D010	18,70		
ZX6R	05	06			D014	20,30	D010	18,70	D003	20,80
ZX6R	07	08			D014	20,30	D010	18,70	D003	20,80
ZX6R	09	12			D014	20,30	D010	18,70	D003	20,80
ZX10R	04	05			D014	20,30	D010	18,70	D004	19,30
ZX10 R	06	07			D014	20,30	D010	18,70	D004	19,30
ZX10 R	08	10					D010	18,70	D004	19,30
ZX10 R	11	20			D014	20,30	D010	18,70	D003	20,80
MV										
BRUTALE 675 / BRUTALE 800	12	17	D019	19,80						
F3 675 / F3 800	12	17	D019	19,80						
RIVALE 800	14	17	D019	19,80						
SUZUKI										
GLADIUS	09	13			D005	18,70			D010	18,70
GSR 600	06	11			D013	18,70	D010	18,70	D018	20,80
GSR 750	11	16							D018	20,80
GSXR 1000	05	16			D014	20,30	D010	18,70	D001	18,70
GSXR 600 / 750	06	10			D014	20,30	D010	18,70	D001	18,70
GSXR 600 / 750	11	17	D010	18,70	D014	20,30	D010	18,70	D018	20,80
GSXR 1000	15	19	D010	18,70			D010	18,70	D001	18,70
SV 650 / 650S	03	08			D013	18,70	D004	19,30	D004	19,30
TRIUMPH										
DAYTONA 675 / 675R	07	16			D002	18,70	D011	18,70	D004	19,30
Speed Triple 1050 / 1050R	08	16							D020 (right side)	46,80
									D021 (left side)	36,40
Street Triple 675 / 675R	07	16			D002	18,70	D011	18,70	D004	19,30
YAMAHA										
MT-03 (660cc) monocilindrico	06	14			D005	18,70	D011	18,70	D011	18,70
MT-03 (321cc) bicilindrico	16	18							D011	18,70
MT-07	13	20							D004	19,30
MT-09 / MT - 09 Tracer	13	20							D004	19,30
Fazer 600 / FZ6	04	12			D005	18,70	D004	19,30	D003	20,80
FZ8	10	16			D014	20,30	D004	19,30	D003	20,80
FZ1 / FAZER 1000	06	12			D014	20,30	D004	19,30	D003	20,80
R6	06	20			D014	20,30	D018	20,80	D003	20,80
R1	04	06			D014	20,30	D004	19,30	D003	20,80
R1	07	14			D014	20,30	D010	18,70	D003	20,80
R1	15	20							D003	20,80
R3	15	18							D011	18,70
T-MAX 530	12	20							D013	18,70
XJ6	08	12			D005	18,70	D007	18,70	D011	18,70



**TAPPI
CAPS**

TAPPI SERBATOIO

174 FUEL TANK CAPS



- Style
- New Design
- 100% Lightech
- 100% Made in Italy

- rosso
red
- cobalto
cobalt
- nero
black
- oro
gold
- silver
silver
- verde
green

FILETTATO SPIN LOCKING	SATINATO SATIN
---------------------------	-------------------

Modello - Model	Anno - Year			Codice - Code	€	Codice - Code	€
							

APRILIA							
RSV 1000	04	08	■ ■ ■	TFN210	110,00	TFS110 ■	135,00
RSV4 R / Factory / APRC	09	20	■ ■ ■	TFN210	110,00	TFS110 ■	135,00
TUONO V4	11	20	■ ■ ■	TFN210	110,00	TFS110 ■	135,00

BMW							
S 1000 R	14	19	■ ■ ■	TFN211	110,00		
S 1000 RR	09	20	■ ■ ■	TFN211	110,00		

DUCATI							
Monster 821	14	17	■ ■ ■ ■ ■	TFN226	95,00	TFS126 ■	120,00
Monster 1200 / R	17	20	■ ■ ■ ■ ■	TFN226	95,00	TFS112 ■	120,00
Panigale 899 / 959 / 1199 / 1299 / V4	12	20	■ ■ ■	TFN212	110,00	TFS110 ■	135,00
Streetfighter 848 / 1100	09	16	■ ■ ■	TFN210	110,00	TFS123 ■	135,00

HONDA							
CB 125 R	18	20	■ ■	TFN224	95,00		
CB 1000 R	18	20	■ ■	TFN224	95,00		
CBR 1000 RR	17	19	■ ■	TFN224	95,00		



Modello - Model	Anno - Year		Codice - Code	€	Codice - Code	€
KAWASAKI						
ER - 6N	12	16	■ ■ ■	TFN215	95,00	
Ninja 400	18	20	■ ■ ■	TFN223	110,00	
Z 650	17	20	■ ■ ■	TFN223	110,00	
Z 750 - Z750 R	07	12	■ ■ ■	TFN215	95,00	
Z 800	13	16	■ ■ ■	TFN215	95,00	
Z 900	17	20	■ ■ ■	TFN223	110,00	
Z 1000 / Z 1000SX	10	16	■ ■ ■	TFN215	95,00	
ZX 6 R / ZX636	07	20	■ ■ ■	TFN215	95,00	
ZX636	19	20	■ ■ ■	TFN215	110,00	
ZX 10 R	06	20	■ ■ ■	TFN215	95,00	

MV AGUSTA						
BRUTALE	01	12	■ ■ ■ ■ ■	TFN226	95,00	TFS126 ■ 120,00
F4	97	09	■ ■ ■ ■ ■	TFN226	95,00	TFS126 ■ 120,00

SUZUKI						
GSR 600	06	11	■ ■ ■	TFN220	95,00	
GSR 750	11	16	■ ■ ■	TFN220	95,00	
GSRX 1000	03	16	■ ■ ■	TFN220	95,00	
GSXR 1000	17	20	■ ■ ■	TFN220	95,00	
GSXR 600 / 750	04	17	■ ■ ■	TFN220	95,00	
GSXS 750	17	20	■ ■ ■	TFN220	95,00	
GSXS 1000	15	20	■ ■ ■	TFN220	95,00	



YAMAHA						
MT-07	14	20	■ ■ ■ ■ ■	TFN226	95,00	TFS126 ■ 120,00
MT-09 / MT- 09 Tracer	13	20	■ ■ ■ ■ ■	TFN226	95,00	TFS126 ■ 120,00
MT-10	16	20	■ ■ ■ ■ ■	TFN226	95,00	TFS126 ■ 120,00
R1	04	20	■ ■ ■ ■ ■	TFN226	95,00	TFS126 ■ 120,00
R3	15	20	■ ■ ■ ■ ■	TFN226	95,00	TFS126 ■ 120,00
R6	17	20	■ ■ ■ ■ ■	TFN226	95,00	TFS126 ■ 120,00
XSR700	17	20	■ ■ ■ ■ ■	TFN226	95,00	TFS126 ■ 120,00





- rosso / red
- cobalto / cobalt
- nero / black
- oro / gold
- silver / silver
- verde / green

SGANCIO RAPIDO RAPID LOCKING	FILETTATO SPIN LOCKING
---------------------------------	---------------------------

Modello - Model	Anno - Year	Codice - Code	€	Codice - Code	€
					

APRILIA					
RSV 1000	04	08	TR10	124,00	
RSV4 R / Factory / APRC	09	20	TR10	124,00	
TUONO V4	11	20	TR10	124,00	

BMW					
S 1000 R	14	19	TR11	124,00	
S 1000 RR	09	20	TR11	124,00	

DUCATI					
Diavel	11	17			TF13 ■ ■ 95,00
Monster 821	14	17	TR26	108,00	
Monster 1200 / R	17	20	TR26	108,00	
Panigale 899 / 959 / 1199 / 1299 / V4	12	20	TR12	124,00	
Streetfighter 848 / 1100	09	16	TR10	124,00	

GUZZI					
Universal	-	-	TR5	107,00	TF5 ■ ■ 84,00

HONDA					
CB 125 R	18	20	TR24	124,00	
CB 1000 R	18	20	TR24	124,00	
CBR 600 RR	13	16	TR22	124,00	TF22 ■ ■ 95,00
CBR 1000 RR	12	20	TR18	124,00	TF18 ■ ■ 95,00
CBR 1000 RR	17	20	TR24	124,00	

■ rosso red
■ cobalto cobalt
■ nero black
■ oro gold
■ silver silver
■ verde green

SGANCIO RAPIDO
RAPID LOCKING

FILETTATO
SPIN LOCKING

Modello - Model	Anno - Year	Codice - Code	€	Codice - Code	€
					

KAWASAKI						
ER - 6N	12	16	TR15	107,00		
Ninja 300	13	17	TR21	107,00	TF21	■ ■
Ninja 400	18	20	TR23	124,00		
Z 650	17	20	TR23	124,00		
Z 750 - Z750 R	07	12	TR15	107,00		
Z 800	13	16	TR15	107,00		
Z 900	17	20	TR23	124,00		
Z 1000 / Z 1000SX	10	16	TR15	107,00		
ZX 6 R / ZX636	07	18	TR15	107,00		
ZX636	19	20	TR23	124,00		
ZX 10 R	06	20	TR15	107,00		

KTM						
DUKE 790	18	20	TR25	107,00	TF25	

MV AGUSTA						
BRUTALE B3 675/800	12	17	TR16	112,00	TF16	■ ■
F3 675 / 800	12	17	TR16	112,00	TF16	■ ■
BRUTALE	01	12	TR1	107,00		
F4	97	09	TR1	107,00		
RIVALE	14	17	TR16	112,00	TF16	■ ■

SUZUKI						
GSR 600	06	11	TR6	107,00		
GSR 750	11	16	TR6	107,00		
GSXR 1000	03	16	TR6	107,00		
GSXR 1000	17	20	TR20	107,00		
GSXR 600 / 750	04	17	TR6	107,00		
GSXS 750	17	20	TR20	107,00		
GSXS 1000	15	20	TR20	107,00		

TRIUMPH						
Daytona 675 / 675 R	11	18	TR14	107,00	TF14	■ ■
Speed Triple 1050	11	18	TR14	107,00	TF14	■ ■
Street Triple 675 / 675 R	11	18	TR14	107,00	TF14	■ ■
Street Triple 765 / 765 R	17	18	TR14	107,00	TF14	■ ■

YAMAHA						
MT-07	14	20	TR26	108,00		
MT-09 / MT- 09 Tracer	13	20	TR26	108,00		
MT-10	16	20	TR26	108,00		
R1	04	20	TR26	108,00		
R3	15	20	TR26	108,00		
R6	17	20	TR26	108,00		
XSR700	17	20	TR26	108,00		

TAPPI SERBATOIO

178 FUEL TANK CAPS

NEW!



Model FCF

Ricambio Flangia interna - Internal spare part

FCF € 56,00

Colori disponibili - Available colours:



a pezzo - for piece



Model TFC

Ricambio Flangia interna - Internal spare part

TFC € 26,00

Colori disponibili: nero
Available colours: black

a pezzo - for piece



Model TRF

Ricambio Flangia interna - Internal spare part

TRF € 54,00

Colori disponibili: nero
Available colours: black

a pezzo - for piece



Chiave racing universale per tappo serbatoio e tappo olio
Universal racing key for fuel tank cap and oil filler cap

TFT € 28,00

a pezzo - for piece





cm³ 16

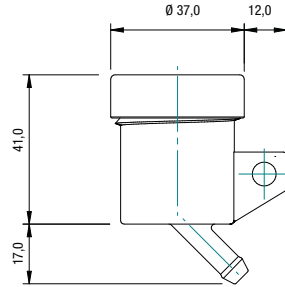

Bocchetta olio trasparente fumè con tappo in alluminio / Fluid reservoir fumè with aluminium cap.

OBT004 € 38,00

a pezzo - for piece

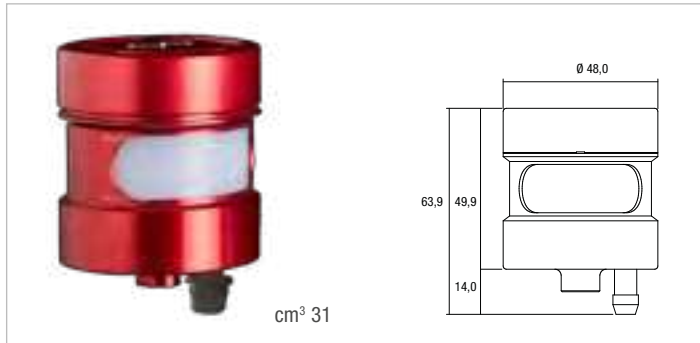

cm³ 31

Bocchetta olio con involucro in alluminio / Fluid reservoir with aluminium case

OBT001 € 46,80

a pezzo - for piece

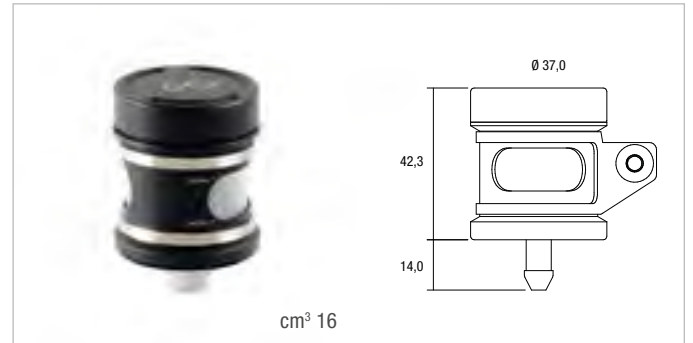

cm³ 16

Bocchetta olio con involucro in alluminio / Fluid reservoir with aluminium case

OBT002 € 57,20

a pezzo - for piece



nero
black

assembled on: OBT001



nero
black

assembled on: OBT002

Supporto per OBT001 / OBT002 - Holder for OBT001 / OBT002

OBT003 € 32,20

a pezzo - for piece

TAPPI OLIO

180 OIL FILLER CAPS

silver
silver



cobalto
cobalt



nero
black

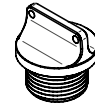

Modello - Model	Anno - Year		filetto - thread	Codice - Code	€	Codice - Code	€
APRILIA							
DORSODURO 750	08	13	M 25 X 1,5	OIL 002	21,10	OILA	21,10
DORSODURO 750	14	16	M 20 X 1,5	OIL 001	21,10	OILS	20,00
DORSODURO 1200	11	16	M 20 X 1,5	OIL 001	21,10	OILS	20,00
RSV 4 + factory APRC	09	20	M 25 X 1,5	OIL 002	21,10	OILA	21,10
SHIVER 750	07	15	M 20 X 1,5	OIL 001	21,10	OILS	20,00
TUONO	06	09	M 20 X 1,5	OIL 001	21,10	OILS	20,00
TUONO V4	11	20	M 25 X 1,5	OIL 002	21,10	OILA	21,10
BMW							
R Nine-T / Scrambler / Pure / Urban / Racer	16	19	M 34 x 1,5	OIL 008	23,40		
R 1200 GS	08	12	M 34 x 1,5	OIL 008	23,40		
S1000 R	14	19	M 24 X 2	OIL 007	21,10	OILBM01	21,10
S1000 RR	09	20	M 24 X 2	OIL 007	21,10	OILBM01	21,10
DUCATI							
848 – 1098 – 1198	07	11	M 19,5 X 2,5	OIL 004	20,00	OILH	20,00
HYPERMOTARD 796	09	12	M 20 X 2,5	OIL 011	21,10		
HYPERMOTARD 821 / HYPERSTRADA 821	13	15	M 20 X 2,5	OIL 011	21,10		
HYPERMOTARD 939	16	18	M 20 X 2,5	OIL 011	21,10		
HYPERMOTARD 950	19	20	M 20 X 2,5	OIL 011	21,10		
MONSTER 696	08	15	M 19,5 X 2,5	OIL 004	20,00	OILH	20,00
MONSTER 821	14	19	M 20 X 2,5	OIL 011	21,10		
MONSTER 1100	11	13	M 20 X 2,5	OIL 011	21,10		
MONSTER 1200 / 1200S	14	20	M 20 X 2,5	OIL 011	21,10		
MULTISTRADA 1200	10	13	M 19,5 X 2,5	OIL 004	20,00	OILH	20,00
PANIGALE 1199 - 899	12	15	M 19,5 X 2,5	OIL 004	20,00	OILH	20,00
PANIGALE 1299/ V4	15	20	M 20 X 2,5	OIL 011	21,10		
STREETFIGHTER 848	11	16	M 20 X 2,5	OIL 011	21,10		
STREETFIGHTER 1100	09	15	M 22 X 1,5	OIL 003	20,00	OILD	20,00
GUZZI							
GRISO 850 – 1100 – 1150	06	15	M 20 X 1,5	OIL 001	21,10	OILS	20,00
HONDA							
tutte / all			M 19,5 X 2,5	OIL 004	20,00	OILH	20,00
XADV	17	20	M 20 X 2,5	OIL 011	21,10		
KAWASAKI							
* ER 6N	06	15	M 19,5 X 2,5	OIL 004	20,00	OILH	20,00
* Ninja 400	18	20	M 20 X 2,5	OIL 011	21,10		
* Z 650	17	20	M 20 X 2,5	OIL 011	21,10		
* Z 800	13	16	M 20 X 2,5	OIL 011	21,10		
* Z 900	17	20	M 20 X 2,5	OIL 011	21,10		
* Z 1000	03	09	M 30 X 1,5	OIL 005	23,40	OILK2	21,30
* Z 1000	10	19	M 20 X 2,5	OIL 011	21,10		
* Z 1000 SX	11	19	M 20 X 2,5	OIL 011	21,10		
* ZX6R / 636	05	20	M 30 X 1,5	OIL 005	23,40	OILK2	21,30
* ZX10R	04	20	M 30 X 1,5	OIL 005	23,40	OILK2	21,30



oro
gold



rosso
red



verde
green



arancione
orange



Only: OIL004 / OIL005 / OIL011

Only: OIL013

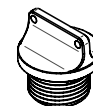

Modello - Model	Anno - Year	filetto - thread	Codice - Code	€	Codice - Code	€
-----------------	-------------	------------------	---------------	---	---------------	---

KTM						
* DUKE 790	18	20	M 24 X 3	OIL 013	20,00	

MV AGUSTA						
BRUTALE 750 – 910 – 990 – 1090	00	17	M 25 X 1,5	OIL 002	21,10	
B3 675 / 800	12	17	M 24 X 3	OIL 013	20,00	
F3 675 / 800	12	17	M 24 X 3	OIL 013	20,00	
F4 750 – 910 – 990 – 1090	00	17	M 25 X 1,5	OIL 002	21,10	
RIVALE 800	13	17	M 24 X 3	OIL 013	20,00	

SUZUKI						
GSXR 600 / 750	06	10	M 20 X 1,5	OIL 001	21,10	OILS 20,00
GSXR 600 / 750	11	17	M 20 X 1,5	OIL 001	21,10	OILS 20,00
GSXR 1000	07	11	M 20 X 1,5	OIL 001	21,10	OILS 20,00
GSXR 1000	12	16	M 20 X 1,5	OIL 001	21,10	OILS 20,00
GSXR 1000	17	20	M 20 X 1,5	OIL 001	21,10	OILS 20,00
GSX-S 750	17	20	M 20 X 1,5	OIL 001	21,10	OILS 20,00
GSX-S 1000	15	20	M 20 X 1,5	OIL 001	21,10	OILS 20,00

TRIUMPH						
tutte / all	-	-	M 19,5 X 2,5	OIL 004	20,00	OILH 20,0

YAMAHA						
MT 03 (660CC) monocilindrico	06	14	M 19,5 X 2,5	OIL 004	20,00	OILH 20,00
MT03 (321CC) bicilindrico	16	20	M 26 X 3	OIL 006	21,10	OILY 21,10
MT-07 / XMT-07	14	20	M 26 X 3	OIL 006	21,10	OILY 21,10
MT-09 / MT - 09 Tracer	13	20	M 20 X 2,5	OIL 011	21,10	
MT-10	16	20	M 26 X 3	OIL 006	21,10	OILY 21,10
R1 / R1M	15	20	M 26 X 3	OIL 006	21,10	OILY 21,10
R3	15	20	M 26 X 3	OIL 006	21,10	OILY 21,10
R6	06	20	M 26 X 3	OIL 006	21,10	OILY 21,10
T-MAX 500 / 530	08	20	M 19,5 X 2,5	OIL 004	20,00	OILH 20,00



COPERCHI POMPE FRENO E FRIZIONE

182 CLUTCH/BRAKE PUMP RESERVOIR COVERS



Modello - Model	Anno - Year	Articolo - Article	Codice - Code	€
APRILIA				
	dal - from	al - to		
DORSODURO 750	09	16	freno ant / front brake	FBC17 29,00
			freno post / rear brake	FFC05 21,30
			frizione / clutch	FFC06 29,00
DORSODURO 900	18	20	freno ant / front brake	FBC17 29,00
			freno post / rear brake	FFC05 21,30
			frizione / clutch	FFC06 29,00
RSV 4 / Factory / APRC	09	20	freno ant / front brake	FBC04 22,30
SHIVER 750	07	16	freno post / rear brake	FFC05 21,30
TUONO V4	11	20	freno ant / front brake	FBC04 22,30
BMW				
R Nine-T / Scrambler / Pure / Urban / Racer	16	19	freno ant / front brake	FBC25 46,80
			frizione / clutch	FFC11 46,80
S 1000 R	14	19	freno ant / front brake	FBC06 22,30
S 1000 RR	09	20	freno ant / front brake	FBC06 22,30
DUCATI				
848 - 1098 - 1198	07	11	freno ant / front brake	FBC04 22,30
			freno post / rear brake	FFC03 19,20
			frizione / clutch	FFC03 19,20
HYPERMOTARD 821 / 939	12	17	freno ant / front brake	FBC07 29,00
			frizione / clutch	FFC03 19,20
HYPERMOTARD 1100	07	10	freno ant / front brake	FBC04 22,30
			freno post / rear brake	FFC03 19,20
			freno ant / front brake	FFC03 19,20
MONSTER 696-796	08	15	freno post / rear brake	FBC07 29,00
			frizione / clutch	FFC03 19,20
			freno ant / front brake	FFC04 27,00
MONSTER 821	14	17	freno post / rear brake	FBC07 29,00
			frizione / clutch	FFC03 19,20
MONSTER 1100	11	13	freno ant / front brake	FFC03 19,20
MONSTER 1200 / 1200S	14	20	freno post / rear brake	FBC04 22,30
			freno post / rear brake	FFC03 19,20
			freno ant / front brake	FBC27 19,20
MULTISTRADA 1200	10	12	freno post / rear brake	FBC04 22,30
			frizione / clutch	FFC03 19,20
			freno ant / front brake	FFC03 19,20
PANIGALE 1199 / 1299	12	17	freno post / rear brake	FBC04 22,30
			frizione / clutch	FFC03 19,20
			freno ant / front brake	FFC03 19,20
PANIGALE V4	18	20	freno post / rear brake	FBC04 22,30
			frizione / clutch	FFC03 19,20
			freno ant / front brake	FBC27 19,20
STREETFIGHTER 848 / 1100	09	16	freno post / rear brake	FBC18 29,00
			frizione / clutch	FFC03 19,20
			freno ant / front brake	FFC07 29,00



FBC21



FFC06



FBC19



FBC18

Modello - Model	Anno- Year	Articolo - Article	Codice - Code	€
HONDA				
	dal - from	al - to		
CB 650F	14	15	freno ant / front brake	FBC01 31,20
CB 1000 R	08	17	freno ant / front brake	FBC06 22,30
			freno post / rear brake	FBC06 22,30
			frizione / clutch	FFC05 21,30
CB 1000 R	18	20	freno ant / front brake	FBC29 35,00
			freno post / rear brake	FBC28 22,30
CBR 600 RR	03	06	freno ant / front brake	FBC01 31,20
CBR 600 RR	07	16	freno ant / front brake	FBC06 22,30
CBR 1000 RR	08	17	freno ant / front brake	FBC06 22,30
			freno post / rear brake	FFC05 21,30
HORNET 600	11	13	freno ant / front brake	FBC01 31,20
X ADV	17	20	freno destro / right brake	FBC01 31,20
			freno sinistro / left brake	FBC01 31,20
HUSQVARNA				
900 NUDA	12	15	freno ant / front brake	FBC04* 22,30

* necessita di due viti 005-M5x45 / two bolts 005-M5x45 required



COPERCHI POMPE FRENO E FRIZIONE

184 CLUTCH/BRAKE PUMP RESERVOIR COVERS



Modello - Model	Anno - Year	Articolo - Article	Codice - Code	€
KAWASAKI				
ER - 6N	06 - 08	freno ant / front brake	FBC02	29,00
ER - 6N	09 - 15	freno ant / front brake	FBC16	22,30
NINJA 250R	09 - 12	freno post / rear brake	FBC06	22,30
NINJA 250 / 400	18 - 20	freno ant / front brake	FBC26	29,00
		freno post / rear brake	FFC05	21,30
Z650	17 - 20	freno ant / front brake	FBC16	22,30
Z750 / Z1000	03 - 06	freno ant / front brake	FBC02	29,00
Z750	07 - 12	freno ant / front brake	FBC06	22,30
Z750 R	11 - 12	freno ant / front brake	FBC19	29,00
Z800	13 - 16	freno ant / front brake	FBC16	22,30
		freno post / rear brake	FFC05	21,30
Z900	17 - 20	freno ant / front brake	FBC16	22,30
Z1000	07 - 09	freno ant / front brake	FBC06	22,30
	10 - 18	freno ant / front brake	FBC19	29,00
Z1000SX	11 - 18	freno ant / front brake	FBC06	22,30
		freno post / rear brake	FFC05	21,30
ZX6R	07 - 20	freno ant / front brake	FBC06	22,30
		freno post / rear brake	FFC05	21,30
ZX10R	08 - 15	freno ant / front brake	FBC06	22,30
		freno post / rear brake	FFC05	21,30
ZX10R	16 - 20	freno ant / front brake	FBC04	22,30
		freno post / rear brake	FFC05	21,30
KTM				
DUKE 790	18 - 20	freno ant / front brake	FBC30	38,50
RC8 1190	08 - 12	freno ant / front brake	FBC06	22,30
990 SUPER DUKE	07 - 12	freno ant / front brake	FBC04	22,30
		freno post / rear brake	FFC03	19,20
690 SM / SMR	07 - 12	freno ant / front brake	FFC04	27,00
		freno post / rear brake	FFC03	22,30
MV AGUSTA				
B3 675 / 800	12 - 17	freno ant / front brake	FBC03	31,20
DRAGSTER	15 - 17	freno ant / front brake	FBC03	31,20
F3 675 / 800	12 - 17	freno ant / front brake	FBC06	22,30
BRUTALE	05 - 17	freno ant / front brake	FBC03	31,20
		frizione / clutch	FFC01	31,20
F4	00 - 09	freno ant / front brake	FBC03	31,20
		frizione / clutch	FFC01	31,20
F4	14 - 17	freno ant / front brake	FBC04	22,30
		frizione / clutch	FFC03	19,20
RIVALE 800	14 - 17	freno ant / front brake	FBC03	31,20



FBC17



FBC06



FFC03



FBC07



FBC27

Modello - Model	Anno - Year	Articolo - Article	Codice - Code	€
SUZUKI				
GLADIUS 650	09 - 15	freno ant / front brake	FBC13	29,00
GSR 600	06 - 12	freno ant / front brake	FBC13	29,00
GSR 750	11 - 16	freno ant / front brake	FBC13	29,00
GSXR 600 / 750	04 - 10	freno ant / front brake	FBC06	22,30
GSXR 1000	05 - 06	freno ant / front brake	FBC06	22,30
GSXR 1000	07 - 08	freno ant / front brake	FBC06	22,30
		frizione / clutch	FFC05	21,30
GSXR 1000	09 - 20	freno ant / front brake	FBC06	22,30
GSX-S 750	17 - 20	freno ant / front brake	FBC13	29,00
GSX-S 1000	15 - 20	freno ant / front brake	FBC24	22,30
TRIUMPH				
DAYTONA 675 / 675 R	07 - 16	freno ant / front brake	FBC06	22,30
		freno post / rear brake	FFC05	21,30
STREET TRIPLE 675 / 675 R	07 - 16	freno post / rear brake	FFC05	21,30
TRIUMPH SPEED TRIPLE 1050	12 - 18	freno ant / front brake	FBC04	22,30
		freno post / rear brake	FFC05	21,30
YAMAHA				
FAZER 1000	01 - 05	freno ant / front brake	FBC02	29,00
FZ1	06 - 15	freno ant / front brake	FBC11	31,20
FZ6	04 - 06	freno ant / front brake	FBC11	31,20
FZ8	10 - 15	freno ant / front brake	FBC11	31,20
MT-03	06 - 13	freno ant / front brake	FBC11	31,20
		freno post / rear brake	FFC05	21,30
MT-07 / TRACER	14 - 20	freno ant / front brake	FBC02	29,00
		freno post / rear brake	FFC05	21,30
MT-09 / TRACER	13 - 20	freno ant / front brake	FBC11	31,20
		freno post / rear brake	FFC05	21,30
R6	03 - 05	freno ant / front brake	FBC06	22,30
R6	06 - 20	freno ant / front brake	FBC06	22,30
		freno post / rear brake	FFC05	21,30
R1	04 - 20	freno ant / front brake	FBC06	22,30
R1	15 - 20	freno post / rear brake	FBC23	21,30
T - MAX	04 - 20	freno ant / front brake	FBC15	29,00
		freno post / rear brake	FBC15	29,00
XJ6	08 - 15	freno ant / front brake	FBC11	31,20



FBC01



FBC02



FBC04



FBC11



FBC18



FBC25



FBC26



FBC29

**BORN
TO BE
MOTO**



Team RenziCorse



RossoCorse



PANIGALE V4S

CARBONIO
CARBON

Ducati

Brembo

SHIMANO

PIRELLI
SUPERCORSA SP

PIRELLI
SUPERCORSA SP

COMPONENTI IN CARBONIO

188 CARBON PARTS

APRILIA

Modello - Model	Anno - Year		Codice - Code	€	Codice - Code		€
	dal - from	al - to	LUCIDO-SHINE		OPACO-MATT		
RSV4 (all model)							
parafango ant. / front mudguard	09	20	CARA3010	180,00			
parafango post. / rear mudguard	09	20	CARA3020	129,60			
coperchio frizione / clutch cover	09	20	CARA3030	129,60			
coperchio alternatore / electric cover	09	20	CARA3040	103,20			
protezioni telaio / frame protector	09	14	CARA3050	216,00			
protezioni telaio / frame protector	15	20	CARA4050	216,00			
protezioni forcellone / swingarm protector	09	14	CARA3060	180,00			
protezioni forcellone / swingarm protector	15	20	CARA4060	180,00			
tubi airbox / racing airducts	09	19	CARA3019	288,0			
copri catena / chain cover	09	20	CARA3012	84,00			
para catena inferiore / inferior chain protection	09	20	CARA3013	76,80			
fianchetti laterali sotto serbatoio / under tank panels	09	20	CARA3080	288,00			
TUONO V4							
parafango ant. / front mudguard	11	20	CARA3010	180,00			
parafango post. / rear mudguard	11	20	CARA3020	129,60			
coperchio frizione / clutch cover	11	20	CARA3030	129,60			
coperchio alternatore / electric cover	11	20	CARA3040	103,20			
protezioni forcellone / swingarm protector	11	20	CARA3060	180,00			
copri catena / chain cover	11	20	CARA3012	84,00			
para catena inferiore / inferior chain protection	11	20	CARA3013	76,80			



Modello - Model	Anno - Year		Codice - Code	€	Codice - Code	€
	dal - from	al - to	LUCIDO-SHINE		OPACO-MATT	
R-nine T Scrambler						
Protezioni teste motore - Engine covers	16	19	CARB2000	240,00	CARB2000M	240,0
Parafango anteriore con fissaggio laterale / front mudguard (side fitment)	17	19	CARB2010	228,00	CARB2010M	228,0
Parafango anteriore con fissaggio superiore / front mudguard (upper fitment)	16	19	CARB2210	228,00	CARB2210M	228,0

S 1000 R						
parafango ant. / front mudguard	13	19	CARB1010	180,00		
parafango post.con copri catena / rear mudguard with chain protector	13	19	CARB1020	163,20		
coperchio frizione / clutch cover	13	14	CARB1030	129,60		
coperchio frizione / clutch cover	15	18	CARB1031	129,60		
coperchio alternatore / electric cover	13	19	CARB1040	108,00		
coperchio pick up / pick up cover	13	16	CARB1018	81,60		
protezioni telaio / frame protector	13	16	CARB1050	204,00		
protezioni telaio / frame protector	17	19	CARB1051	216,00		
protezioni forcellone / swingarm protector	13	16	CARB1060	192,00		
protezioni forcellone / swingarm protector	17	19	CARB1061	204,00		

S 1000 RR						
parafango ant. / front mudguard	09	18	CARB1010	180,00		
parafango post.con copri catena / rear mudguard with chain protector	09	18	CARB1020	163,20		
coperchio frizione / clutch cover	09	14	CARB1030	129,60		
coperchio frizione / clutch cover	15	18	CARB1031	129,60		
coperchio alternatore / electric cover	09	18	CARB1040	108,00		
coperchio pick up / pick up cover	09	16	CARB1018	81,60		
protezioni telaio / frame protector	09	14	CARB1050	204,00		
protezioni telaio / frame protector	15	18	CARB1051	216,00		
protezioni forcellone / swingarm protector	09	14	CARB1060	192,00		
protezioni forcellone / swingarm protector	15	18	CARB1061	204,00		
tubi airbox / racing airducts	09	11	CARB1019	132,00		

S 1000 RR						
parafango ant. / front mudguard	19	20	CARB1910	286,00		
parafango post.con copri catena / rear mudguard with chain protector	19	20	CARB1920	334,00		
coperchio frizione / clutch cover	19	20	CARB1930	132,00		
coperchio alternatore / electric cover	19	20	CARB1940	120,00		
protezioni telaio / frame protector)	19	20	CARB1950	355,00		
protezioni forcellone / swingarm protector	19	20	CARB1960	326,00		
copri serbatoio / tank cover	19	20	CARB1929	324,00		



COMPONENTI IN CARBONIO

190 CARBON PARTS

FINE SERIE - END STOCK

Modello - Model	Anno - Year		Codice - Code	€	Codice - Code	€
	dal - from	al - to	LUCIDO-SHINE		OPACO-MATT	
PANIGALE 899						
parafango ant. / front mudguard	13	15	CARD1010	192,00		
coperchio alternatore / electric cover	13	15	CARD1040	144,00		
protezione molla mono / rear shock absorber protector	13	15	CARD1039	84,00		
PANIGALE 1199 / 1299						
parafango ant. / front mudguard	12	17	CARD1010	192,00		
parafango post. / rear mudguard	12	17	CARD1020	168,00		
coperchio frizione / clutch cover	12	17	CARD1030	120,00		
coperchio alternatore / electric cover	12	17	CARD1040	144,00		
protezioni forcellone / swingarm protector	12	17	CARD1060	192,00		
copri catena / chain protector	12	17	CARD1012	72,00		
protezione corona / sprocket cover	12	17	CARD1013	84,00		
protezione mono / rear shock absorber protector	12	17	CARD1039	84,00		
PANIGALE V4						
parafango ant. / front mudguard	18	20	CARD0810	288,00	CARD0810M	276,00
parafango post. / rear mudguard	18	20	CARD0820	234,00	CARD0820M	234,00
coperchio frizione / clutch cover	18	20	CARD0830	138,20	CARD0830M	138,20
coperchio alternatore / electric cover	18	20	CARD0840	151,20	CARD0840M	151,20
cover teste L+R / head cover L+R	18	20	CARD0841	264,00	CARD0841M	264,00
protezioni telaio / frame protection	18	20	CARD0850	276,00	CARD0850M	276,00
protezioni forcellone / swingarm protector	18	20	CARD0860	271,20	CARD0860M	271,20
slider in alluminio per protezione forcellone / alu-slider for carbon swingarm protection	18	20	CARD0861-01sil	48,00		
copri serbatoio totale / total tank cover	18	20	CARD0827	444,00	CARD0827M	444,00
copri serbatoio con cover chiave integrato / tank cover with key cover	18	20	CARD0828	293,00	CARD0828M	293,00
copri serbatoio / tank cover	18	20	CARD0829	220,80	CARD0829M	220,80
fianchetti sotto serbatoio / sides under tank panels	18	20	CARD0880	240,00	CARD0880M	240,00
codone / tail	18	20	CARD0890	355,20	CARD0890M	355,20
coppia di ali / pair of wings	18	20	CARD0815			

DUCATI



FINE SERIE - END STOCK

Modello - Model	Anno - Year		Codice - Code	€	Codice - Code		€
	dal - from	al - to	LUCIDO-SHINE		OPACO-MATT		
HONDA CB 1000 R							
parafango ant. / front mudguard	18	20	CARH7710	276,00			
copri catena / chain cover	18	20	CARH7712	96,00			
protezione corona / sprocket protector	18	20	CARH7713	72,00			
parafango post. / rear mudguard	18	20	CARH7720	180,00			
coperchio frizione-pick up / clutch cover - pick up	18	20	CARH7730	129,60			
coperchio alternatore / electric cover	18	20	CARH7740	108,00			
protezioni forcellone / swingarm protector	18	20	CARH7760	108,00			
frontalino copri strumenti / tachometer support cover	18	20	CARH7770	91,20			

HONDA CBR 600 RR							
parafango ant. / front mudguard	07	16	CARH6510	180,00			
parafango post. / rear mudguard	07	16	CARH8920	132,00			
coperchio frizione / clutch cover	07	16	CARH6530	129,60			
coperchio alternatore / electric cover	07	16	CARH6540	96,00			
protezioni telaio / frame protector	07	16	CARH6550	204,00			
protezioni forcellone / swingarm protector	07	16	CARH6560	180,00			

HONDA CBR 1000 RR							
parafango ant. / front mudguard	08	16	CARH1710	180,00			
copri catena / chain cover	08	16	CARH1712	108,00			
parafango post. / rear mudguard	08	11	CARH7620	132,00			
parafango post. / rear mudguard	12	16	CARH1720	168,00			
coperchio alternatore / electric cover	08	16	CARH7640	108,00			
coperchio frizione / clutch cover	08	16	CARH7630	129,60			
protezioni telaio / frame protector	08	16	CARH7650	216,00			
protezioni forcellone / swingarm protector	08	16	CARH7660	184,80			

HONDA CBR 1000 RR							
parafango ant. / front mudguard	17	19	CARH1710	180,00			
copri catena / chain cover	17	19	CARH1712	108,00			
parafango post. / rear mudguard	17	19	CARH1720	168,00			
coperchio frizione / clutch cover	17	19	CARH1730	129,60			
coperchio alternatore / electric cover	17	19	CARH1740	108,00			
protezioni telaio / frame protector	17	19	CARH1750	220,80			
protezioni forcellone / swingarm protector	17	19	CARH1760	196,80			

HONDA



PANIGALE V4
CARD0827

NEW!

PANIGALE V4
CARD0841



NEW!



HONDA CB 1000 R
CARH7710



HONDA CB 1000 R
CARH7720

COMPONENTI IN CARBONIO

192 CARBON PARTS

Modello - Model	Anno - Year		Codice - Code	€	Codice - Code		€
	dal - from	al - to	LUCIDO-SHINE		OPACO-MATT		
KAWASAKI ZX6R - 636							
parafango ant. / front mudguard	09	18	CARK9610	180,00			
parafango post. / rear mudguard	09	20	CARK9520	144,00			
coperchio frizione / clutch cover	09	20	CARK9530	120,00			
coperchio alternatore / electric cover	09	20	CARK9540	96,00			
coperchio pick up / pick up cover	09	20	CARK9518	120,00			
protezioni telaio / frame protectors	09	20	CARK9550	192,00			
protezioni forcellone / swingarm protector	09	20	CARK9560	180,00			
copri catena / chain protector	09	20	CARK9512	108,00			

KAWASAKI ZX10R							
parafango ant. / front mudguard	11	15	CARK9610	180,00			
parafango ant. / front mudguard	16	20	CARK9810	192,00			
parafango post. / rear mudguard	11	20	CARK9620	144,00			
copri catena / chain protector	11	20	CARK9612	108,00			
coperchio frizione / clutch cover	11	20	CARK9630	120,00			
coperchio alternatore / electric cover	11	20	CARK9640	108,00			
coperchio pick up / pick up cover	11	20	CARK9618	108,00			
protezioni telaio / frame protector	11	15	CARK9650	211,20			
protezioni telaio / frame protector	16	20	CARK9850	220,80			
protezioni forcellone / swingarm protector	11	15	CARK9660	187,20			
protezioni forcellone / swingarm protector	16	20	CARK9860	196,80			

KAWASAKI Z900							
parafango ant. / front mudguard	17	20	CARK8010	276,00			
parafango post. / rear mudguard	17	20	CARK8020	246,00			
coperchio frizione / clutch cover	17	20	CARK8030	124,80			
coperchio alternatore / electric cover	17	20	CARK8040	108,00			
coperchio pick up / pick up cover	17	20	CARK8018	91,20			
frontalino copri strumenti / tachometer support cover	17	20	CARK8070	144,00			



KAWASAKI

FINE SERIE - END STOCK

Modello - Model	Anno - Year		Codice - Code	€	Codice - Code	€
	dal - from	al - to	LUCIDO-SHINE		OPACO-MATT	
B3 - F3 - RIVALE						
parafango ant. / front mudguard	12	19	CARM1010	204,00	CARM1010M	204,00
parafango post. / rear mudguard	12	19	CARM1020	156,00	CARM1020M	168,00
copri catena/ chain cover	12	19	CARM1012	84,00	CARM1012M	96,00



NEW!

KAWASAKI Z900
CARK8010



NEW!

KAWASAKI Z900
CARK8020

MV AGUSTA



COMPONENTI IN CARBONIO

FINE SERIE - END STOCK

Modello - Model	Anno - Year		Codice - Code	€	Codice - Code		€
	dal - from	al - to	LUCIDO-SHINE		OPACO-MATT		
GSX-R 600 / 750							
parafango ant. / front mudguard	11	17	CARS6110	180,00			
parafango post. / rear mudguard	11	17	CARS6120	148,80			
coperchio frizione / clutch cover	11	17	CARS8030	132,00			
coperchio alternatore / electric cover	11	17	CARS6040	120,00			
protezioni telaio / frame protection	11	17	CARS6150	216,00			
protezioni forcellone / swingarm protector	11	17	CARS6160	180,00			
GSX-R 1000							
parafango ant. / front mudguard	09	16	CARS6410	180,00			
parafango post. / rear mudguard	09	16	CARS6420	148,80			
coperchio frizione / clutch cover	09	16	CARS6430	132,00			
coperchio alternatore / electric cover	09	16	CARS6440	108,00			
protezioni telaio / frame protector	09	16	CARS6450	216,00			
protezioni forcellone / swingarm protector	09	16	CARS6460	180,00			
GSX-R 1000 / R							
parafango ant. / front mudguard	17	20	CARS6510	276,00	CARS6510M		276,00
parafango post. / rear mudguard	17	20	CARS6521	172,80	CARS6521M		180,00
coperchio frizione / clutch cover	17	20	CARS6530	129,60	CARS6530M		144,00
coperchio alternatore / electric cover	17	20	CARS6540	108,00	CARS6540M		120,00
protezioni telaio / frame protector	17	20	CARS6550	220,80	CARS6550M		244,80
protezioni forcellone / swingarm protector	17	20	CARS6560	196,80	CARS6560M		220,80
copri catena / chain cover	17	20	CARS6512	115,20	CARS6512M		127,20
copri serbatoio / tank cover	17	20	CARS6529	288,00	CARS6529M		312,00
tubi air box racing / racing airducts	17	20	CARS6519	334,00			

SUZUKI



Modello - Model	Anno - Year		Codice - Code	€	Codice - Code	€
	dal - from	al - to	LUCIDO-SHINE		OPACO-MATT	
MT - 09 / MT 09 - Tracer						
parafango ant. / front mudguard	13	20	CARY8910	252,00		
parafango post. / rear mudguard	13	20	CARY8920	144,00		
MT-10						
parafango ant. / front mudguard	16	20	CARY5010	288,00		
parafango posteriore / rear mudguard	16	20	CARY5020	156,00		
copri catena/ chain cover	16	20	CARY5012	84,00		
coperchio frizione / clutch cover	16	20	CARY5030	148,80		
coperchio alternatore / electric cover	16	20	CARY5140	108,00		
coperchio pick up / pick up cover	16	20	CARY5018	91,20		
protezioni telaio / frame protector	16	20	CARY5050	220,80		
protezioni forcellone / swingarm protector	16	20	CARY5060	196,80		
YZF R6						
parafango ant. / front mudguard	06	16	CARY9910	168,0		
parafango post. / rear mudguard	06	16	CARY9920	120,0		
coperchio frizione / clutch cover	06	16	CARY9930	120,0		
coperchio alternatore / electric cover	06	16	CARY9940	108,0		
coperchio pick up / pick up cover	06	16	CARY9918	91,2		
protezioni telaio / frame protection	06	16	CARY9950	192,0		
protezioni forcellone / swingarm protector	06	16	CARY9960	180,0		
YZF R6						
parafango ant. / front mudguard	17	20	CARY5010	288,00		
copri catena/ chain cover	17	20	CARY9912	100,80		
parafango post. / rear mudguard	17	20	CARY9920	120,00		
coperchio frizione / clutch cover	17	20	CARY9930	120,00		
coperchio alternatore / electric cover	17	20	CARY9940	108,00		
coperchio pick up / pick up cover	17	20	CARY9918	91,20		
protezioni telaio / frame protection	17	20	CARY9951	216,00		
protezioni forcellone / swingarm protector	17	20	CARY9961	180,00		
coperchio serbatoio / tank cover	17	20	CARY9929	288,00		
protezioni serbatoio / tank protector	17	20	CARY9990			



COMPONENTI IN CARBONIO

196 CARBON PARTS

FINE SERIE - END STOCK

Modello - Model	Anno - Year		Codice - Code	€	Codice - Code		€
	dal - from	al - to	LUCIDO-SHINE		OPACO-MATT		
R1							
parafango ant. / front mudguard	15	20	CARY5010	288,00			
parafango posteriore / rear mudguard	15	20	CARY5020	156,00			
copri catena/ chain cover	15	20	CARY5012	84,00			
coperchio frizione / clutch cover	15	20	CARY5030	148,80			
coperchio alternatore / electric cover	15	20	CARY5040	124,80			
coperchio pick up / pick up cover	15	20	CARY5018	91,20			
protezioni telaio / frame protector	15	20	CARY5050	220,80			
protezioni forcellone / swingarm protector	15	20	CARY5060	196,80			
fianchetti laterali sotto serbatoio / side under tank panel	15	19	CARY5080	192,00			
coperchio serbatoio / tank cover	15	19	CARY5029	288,00			
T-MAX 500 / 530							
parafango ant. / front mudguard	08	14	CARY4610	168,00	CARY4610M		180,00
parafango ant. / front mudguard	15	16	CARY4710	168,00	CARY4710M		184,80
protezioni forcellone / swingarm protector	12	16	CARY4660	144,00	CARY4660M		156,00
copri cinghia / belt protector	12	16	CARY4612	108,00	CARY4612M		120,00
T-MAX 530 / 560							
parafango ant. / front mudguard	17	20	CARY4910		CARY4910M		
copri cinghia / belt protector	17	20	CARY4912	29,400	CARY4912M		29,400
protezioni forcellone / swingarm protector	17	20	CARY4960		CARY4960M		
SOLO PER USO RACING / ONLY FOR RACING USE							
PINNA PROTEZIONE CATENA UNIVERSALE / UNIVERSAL CHAIN PROTECTION			CAR001	55,20			

YAMAHA





**CAVALLETTI
STANDS**

RACING & BOX



kg 2,1

Colori disponibili: nero
Available colours: black

Cavallo posteriore in carbonio con forchette
Carbon rear stand with forks

RSC001F € 540,00

Cavallo posteriore in carbonio con rulli
Carbon rear stand with rollers

RSC001R € 540,00

Cavallo anteriore in carbonio sotto piastra
Carbon front stand under plate

RSC002 € xxxx



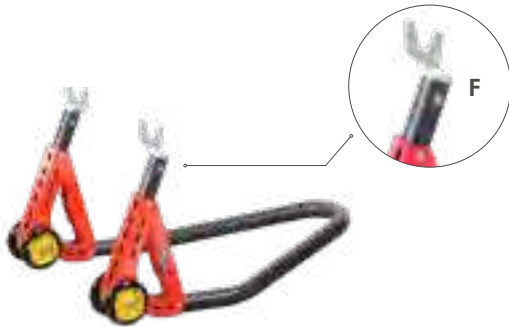

kg 2,7

Colori disponibili: nero, rosso, blu, verde
Available colours: black, red, blu, greenCavalletto posteriore in alluminio con forchette
Aluminium rear stand with forks

RSA23F € 198,00

Cavalletto posteriore in alluminio con rulli
Aluminium rear stand with rollers

RSA23R € 198,00



kg 4,5

Cavalletto anteriore centrale in alluminio
Aluminium front triple tree lift

RSA20 € 247,00



kg 6,3

Perno inox per cavalletto / Stainless steel pin for stand

Modello - Model	Ø	Codice - Code	€
PERNO INOX PER RSA20	12,7	PIN001	6,90
PERNO INOX PER RSA20 (BMW S1000RR)	15,7	PIN002	6,90
PERNO INOX PER RSA20 (YAMAHA R1/R6)	16,5	PIN007	6,90
PERNO INOX PER RSA20 (APRILIA RSV4) 1	19,8	PIN003	6,90
PERNO INOX PER RSA20 (KAWASAKI NINJA 400)	22,0	PIN004	6,90
PERNO INOX PER RSA20	24,0	PIN005	6,90
PERNO INOX PER RSA20 (KAWASAKI ZX10R/ZX6R/Z900)	27,7	PIN006	6,90
PERNO INOX PER RSA20 (YAMAHA R3)	17,2	PIN008	6,90
PERNO INOX PER RSA20 (SUZUKI GSXR1000)	15,9	PIN009	6,90





 kg 2,3

Cavalletto anteriore in ferro
Iron front stand

RSF008 € 54,00



 kg 3,2

Cavalletto anteriore in ferro con attacco sotto pinze freno
Iron front stand with attachment under brake calipers

RSF042 € 98,00



RSA23F

RSF042



 **kg 3,0**

Cavalletto posteriore in ferro a 2 ruote con forchette
Iron rear stand with 2 wheels and forks

RSF036 € 43,50



 **kg 3,1**

Cavalletto posteriore in ferro a 2 ruote con forchette
Iron rear stand with 2 wheels and forks



RSF037F € 54,00

Cavalletto posteriore in ferro a 2 ruote con pattini
Iron rear stand with 2 wheels and sliding blocks



RSF037P € 64,00

Cavalletto posteriore in ferro a 2 ruote con rulli
Iron rear stand with 2 wheels and rollers



RSF037R € 75,00



 **kg 2,9**

Cavalletto anteriore in ferro
Iron front stand

RSF22 € 95,50



 **kg 4,5**

Cavalletto posteriore in ferro con forchette
Iron rear stand with forks



RSF21F € 109,00

Cavalletto posteriore in ferro con pattini
Iron rear stand with sliding blocks



RSF21P € 120,00

Cavalletto posteriore in ferro con rulli
Iron rear stand with rollers



RSF21R € 131,00



kg 6,3

Cavalletto posteriore monobraccio in ferro / Iron one armed rear stand

Modello - Model	∅	Codice - Code	€
BMW R 1200 GS (2003 -2012) pin. DX	53,5	RSF011	202,00
BMW R 1200 GS (2013-2017) pin. SX	53,5	RSF043	202,00
BMW R nine T	53,5	RSF011	202,00
DUCATI 848 -848 EVO - 748	25,7	RSF005	175,00
DUCATI 1098+1198	40,6	RSF004	175,00
DUCATI Panigale 1199 / 1299 / V4	40,6	RSF004	175,00
DUCATI 996 - 998	25,7	RSF005	175,00
DUCATI S2R - S4R	25,7	RSF005	175,00
DUCATI MONSTER 796	25,7	RSF005	175,00
DUCATI MONSTER 1100	25,7	RSF005	175,00
DUCATI MONSTER 1200 / 1200R	40,6	RSF004	175,00
DUCATI MULTISTRADA 1100	25,7	RSF005	175,00
DUCATI MULTISTRADA 1200	40,6	RSF004	175,00
DUCATI HYPERMOTARD 796 / 1100 / 821	25,7	RSF005	175,00
DUCATI STREETFIGHTER 848 / 1100	25,7	RSF005	175,00
DUCATI STREETFIGHTER 1098 S	40,6	RSF004	175,00
DUCATI DIAVEL	40,6	RSF004	175,00
HONDA CB 1000 R 2008/2017	28,4	RSF002	175,00
HONDA CB 1000 R 2018	18,0	RSF012	175,00
HONDA VFR 800	28,4	RSF002	175,00
MV BRUTALE	42,7	RSF001	175,00
MV F4 / F3	42,7	RSF001	175,00
TRIUMPH SPEED TRIPLE 1050	26,8	RSF003	175,00



kg 6,3

Perno per cavalletto monobraccio in ferro / Pin for iron one armed rear stand

∅ perno - ∅ pin	Codice - Code	€
42,7	RSF26	25,50
28,4	RSF27	25,50
26,8	RSF28	25,50
40,6	RSF29	25,50
25,7	RSF30	25,50
53,5	RSF37	25,50
18,0	RSF38	25,50

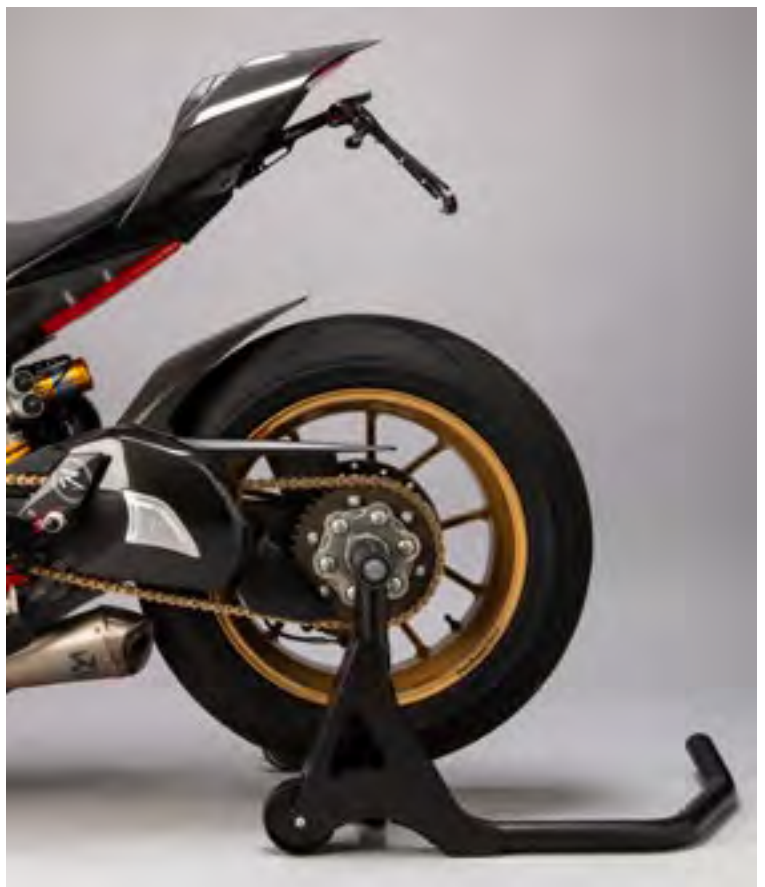



 **kg 3,5**

Cavalletto componibile posteriore in ferro a 4 ruote
Modular iron rear stand with 4 wheels

RSF038 **€ 66,50**



 **kg 3,6**

Cavalletto componibile posteriore in ferro a 4 ruote con forchette
Modular iron rear stand with 4 wheels and forks



RSF039F **€ 73,00**

Cavalletto componibile posteriore in ferro a 4 ruote con pattini
Modular iron rear stand with 4 wheels and sliding blocks



RSF039P **€ 83,00**

Cavalletto componibile posteriore in ferro a 4 ruote con rulli
Modular iron rear stand with 4 wheels and rollers



RSF039R **€ 94,00**



 **kg 2,2**

Coppia cavalletti sfilabili h 380 / 560 in alluminio
Pair of aluminium extensible stands h 380 / 560

RSA002 **€ 161,00**

 **kg 2,8**

Coppia cavalletti sfilabili h 670 / 940 in alluminio
Pair of aluminium extensible stands h 670 / 940

RSA003 **€ 165,00**

RICAMBI PER CAVALLETTI
STANDS SPARE PARTS



Forchette
Forks
RSF23 **€ 15,50**
a coppia
for pair



Pattini
Sliding blocks
RSF24 **€ 21,00**
a coppia
for pair



Rulli
Rollers
RSF25 **€ 26,00**
a coppia
for pair



Ruote
Wheels
RW001 **€ 15,50**
a coppia
for pair



kg 18,00 - Dimension: L1340 x P450 H 1400

Carrello porta cerchi in alluminio
Aluminium rims carrier

RSA13 € 455,00



kg 14,00 - Dimension: L1440 x P500 H 1300

Rastrelliera porta cerchi in alluminio con 10 postazioni
Aluminium rims rack with 10 positions

RSA14 € 446,00



kg 16,00 - Dimension: L2100 x P630 H 450

Banco portamoto in carbonio
Carbon bench table

RSA001 € 1.200,00

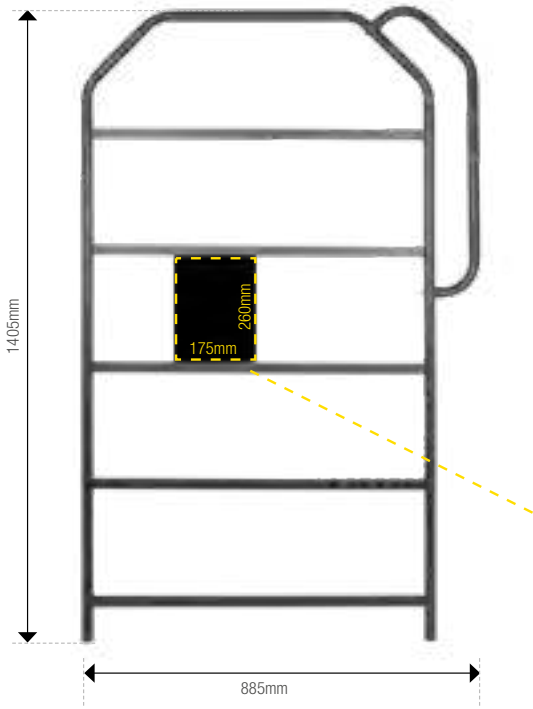

kg 2,2

Pitboard in alluminio verniciato nero
Aluminium pitboard - black painted

TTG004 € 280,00

completa di 50 tabelle senza lettere e cifre
with 50 tables without letters and numbers

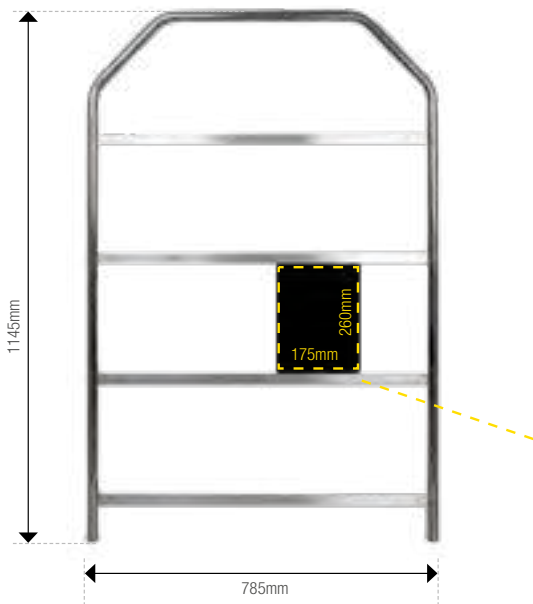

kg 1,5

Pitboard in alluminio NON verniciato
Aluminium pitboard - uncoated aluminium

TTG005 € 172,00

completa di 36 tabelle senza lettere e cifre
with 36 tables without letters and numbers



Tabella in PVC (minimo ordinabile 10 pz.)
PVC time table (minimum required 10 pcs)

TTG004-08 € 2,60

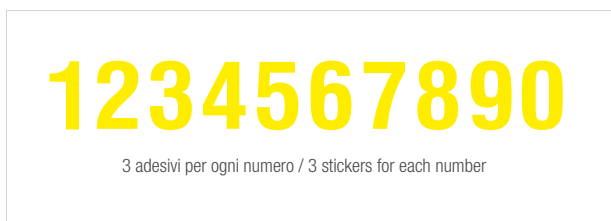

+



SERBATOIO RIFORMIMENTO RAPIDO

206 FAST FUEL CANISTER



Colori disponibili: nero + rosso.
Available colours: black + red.

Modello - Model	Codice - Code	colore serbatoio - fuel canister colour	€
5 LITRI / litres	SER01	nero / black	502,00
10 LITRI / litres	SER02	nero / black	502,00

CON FORO CENTRATO - WITH CENTRAL HOLE :



Colori disponibili: nero + rosso.
Available colours: black + red.

Modello - Model	Codice - Code	colore serbatoio - fuel canister colour	€
5 LITRI / litres	SER04	nero / black	502,00
10 LITRI / litres	SER05	nero / black	502,00

CON FORO DECENTRATO - WITH NOT CENTRAL HOLE :





Rain

SAPR001 € 36,50

Colori disponibili: rosso / Available colours: red

a coppia - for pair



Ricambio / Spare part

RSAPR001 € 7,90

a pezzo - for piece



Filler

SAPF € 21,00

Colori disponibili: rosso, blu, bianco, nero, giallo
Available colours: red, blue, white, yellow, black

a coppia - for pair



Nuke

SAPN € 27,00

Colori disponibili: nero
Available colours: black

a coppia - for pair



Dropper

SAPDR0 € 21,00

Colori disponibili: rosso, blu, bianco, nero, giallo
Available colours: red, blue, white, yellow, black

a coppia - for pair



Leather

SAPL € 41,60

Cuoio - Leather

a coppia - for pair



PICCOLI GRANDI EROI DELLA MOTO TERAPIA LITTLE BIG HEROES OF MOTORBIKE THERAPY

La moto è libertà, coraggio, adrenalina. Una scossa vitale che i nostri amici Vanni Odera e Massimo Bianconcini, con la loro "mototerapia", fanno provare anche ai più sfortunati, esibendosi con le loro due ruote addirittura tra i reparti di oncologia infantile... vi siamo vicini, siete straordinari!

Motorbike is freedom, brave, adrenalin. A life pulse that Vanni Odera and Massimo Bianconcini, with their "MotoTherapy", want to donate to pediatric oncology departments. We are with you, you are amazing.





ADESIVI
STICKERS

ADESIVO PER SERBATOIO

210 TANK PAD



L130 x H190 | STK123 | € 13,70
a pezzo
for piece



L130 x H190 | STK124 | € 13,70
a pezzo
for piece



L130 x H190 | STK126 | € 13,70
a pezzo
for piece



L130 x H190 | STK089 | € 16,30
a pezzo
for piece



L130 x H190 | STK090 | € 13,70
a pezzo
for piece



L130 x H190 | STK091 | € 13,70
a pezzo
for piece



L130 x H190 | STK092 | € 13,70
a pezzo
for piece



L130 x H190 | STK093 | € 13,70
a pezzo
for piece



L130 x H190 | STK113 | € 13,70
a pezzo
for piece



ADESIVO PER SERBATOIO

212 TANK PAD



L115 x H210 | STK094 | € 12,20
a pezzo
for piece



L115 x H210 | STK095 | € 12,20
a pezzo
for piece



L115 x H210 | STK96 | € 12,20
a pezzo
for piece



L115 x H215 | STK097 | € 7,40
a pezzo
for piece



L130 x H185 | STK098 | € 19,90
a pezzo
for piece



L105 x H175 | STK121 | € 50,70
a pezzo
for piece
Protezione serbatoio in fibra di carbonio / Carbon fiber tank protection

NEW!



L115 x H210 | STK125 | € 13,70
a pezzo
for piece





L85 x H146 | STK099 | € 12,20
a pezzo
for piece



L85 x H146 | STK100 | € 12,20
a pezzo
for piece



L85 x H146 | STK101 | € 12,20
a pezzo
for piece



L110 x H205 | STK102 | € 12,30
a pezzo
for piece



L110 x H205 | STK103 | € 12,30
a pezzo
for piece



L110 x H205 | STK104 | € 12,30
a pezzo
for piece



L115 x H165 | STK105 | € 12,20
a pezzo
for piece



L115 x H165 | STK106 | € 12,20
a pezzo
for piece



L115 x H165 | STK107 | € 12,20
a pezzo
for piece



L135 x H170 | STK112 | € 7,40
a pezzo
for piece



L135 x H170 | STK111 | € 7,40
a pezzo
for piece

ADESIVO PER SERBATOIO

214 TANK PAD

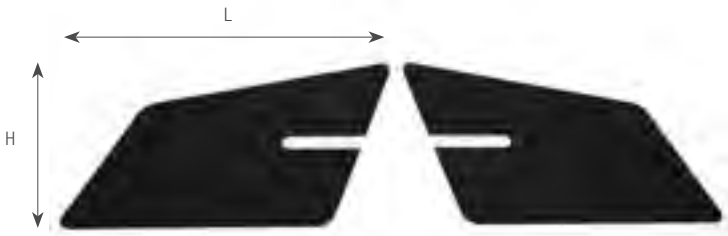

L210 x H114

STK114

€ 22,20

Kit adesivi protezioni serbatoio (laterali) spessore 0.3mm
Tank protection stickers kit (sides) 0.3mm thickness

a kit - for kit



L210 x H114

STK115

€ 22,20

a kit - for kit



25 x 60 mm

STK116

€ 6,30

Velcro biadesivo 3M
3M velcro double-side

a kit - for kit



20 x 60 mm

STK117

€ 10,80

Velcro biadesivo 3M
3M velcro double-side

a kit - for kit

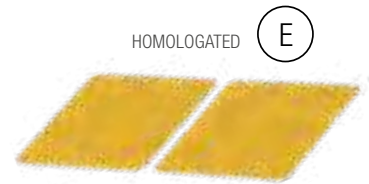

50 x 50 mm

STK120

€ 7,00

a kit - for kit

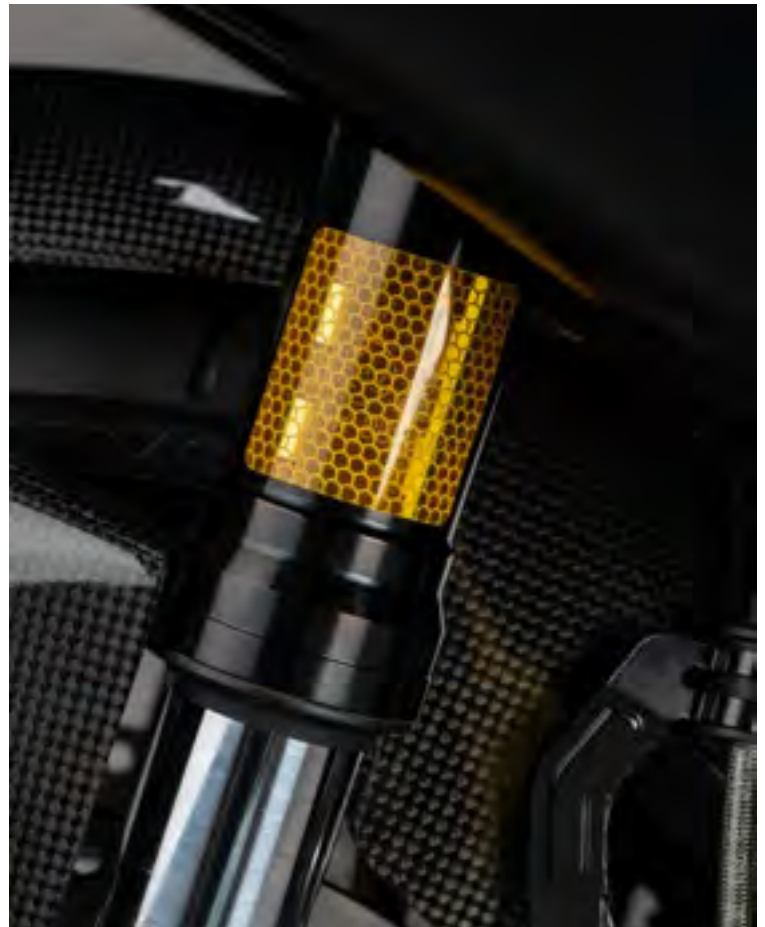



L 7000x7mm



white race



blue race



yellow race



red race



green race



orange race



orange ktm

Adesivi per profili ruota - Wheel stickers			a pezzo for piece
Adesivi per profili ruota - Wheel stickers	white race	STK047	€ 9,80
Adesivi per profili ruota - Wheel stickers	blue race	STK048	€ 9,80
Adesivi per profili ruota - Wheel stickers	yellow race	STK049	€ 9,80
Adesivi per profili ruota - Wheel stickers	red race	STK050	€ 9,80
Adesivi per profili ruota - Wheel stickers	green race	STK051	€ 9,80
Adesivi per profili ruota - Wheel stickers	orange race	STK052	€ 9,80
Adesivi per profili ruota - Wheel stickers	orange ktm	STK088	€ 9,80



STK118 € 21,50

Adesivi per profili ruota - Wheel stickers

a pezzo
for piece

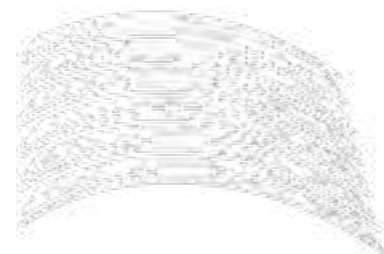

STK119 € 21,50

Adesivi per profili ruota - Wheel stickers

a pezzo
for piece

ADESIVI

216 STICKERS



L330 x H480

STK108

€ 10,5

Pellicola protettiva trasparente
Transparent skin protection

a pezzo
for piece



L350 x H500

STK109

€ 16,30

Protezione per alte temperature (con adesivo)
High-temperature protection (with sticker)

a pezzo
for piece



L350 x H500

STK110

€ 11,70

Pellicola carbon texture
Carbon skin texture

a pezzo
for piece



mm 330 x 330 x 15

NSR01 € 14,00

Neoprene per sella
Neoprene for racing seat

a pezzo - for piece

TELO COPRIMOTO

BIKE COVER



Telo coprimoto per interni
Bike cover for indoor

STF001 € 87,00

**BORN
TO BE
MOTO**



Max Bianconcini
Ph: Matteo Cannizzaro



Vanni Oddera
Ph: Lorenzo Refriferi



Espositore da terra · 65x200 cm
Floor display stand · 65x200 cm

EXP008

€ 166,00



Power Bank

PWB001

€ 35,5

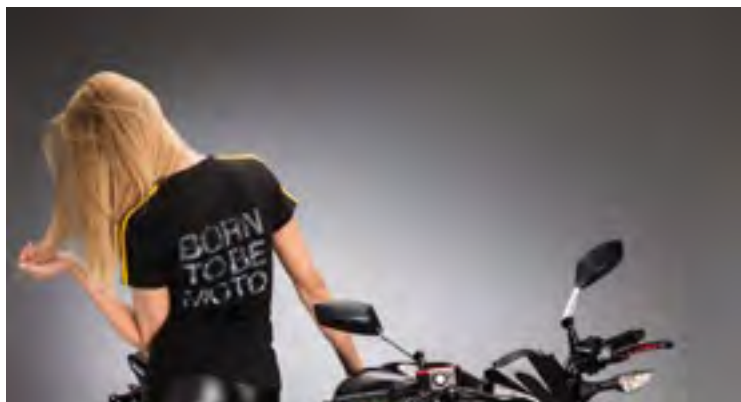

T-Shirt | T-Shirt Man : S - M - L - XL - XXL - XXXL
 T-Shirt Woman : XS - S - M - L € 30,00

NEW COLLECTION
 by LighTech



T-Shirt | Man : S - M - L - XL - XXL - XXXL
 Woman : XS - S - M - L € 30,00



Felpa con cappuccio | Man : S - M - L - XL - XXL - XXXL
 Woman : XS - S - M - L € 60,00
 Hoodies



Capellino da paddock | Paddock cap € 28,00

Condizioni generali di vendita

PREZZI

I prezzi indicati nel catalogo sono tasse escluse.

TRASPORTO

Il trasporto dei nostri prodotti avviene tramite corriere e le spese di trasporto sono addebitate in fattura.

TEMPI E MODALITÀ DI CONSEGNA

La consegna dei prodotti viene normalmente assicurata entro 2/3 giorni dal ricevimento dell'ordine per l'Italia e pianificata nel resto del Mondo in base alla disponibilità del prodotto ed alle esigenze del Cliente/Distributore in accordo con LighTech.

LighTech® viene distribuita in tutto in tutto il Mondo tramite la propria rete vendita.

RESO MERCE

Nella remota eventualità che il cliente riceva un prodotto che presenti difettosità o anomalie rispetto a quanto ordinato, il cliente dovrà entro 5 gg. lavorativi dalla data di ricezione merce informare il Servizio Clienti LighTech all'indirizzo mail sales@lightech.it per ricevere istruzioni dettagliate sulla modalità dell'eventuale reso prodotto e relativa sostituzione/nota di accredito.

MINIMO D'ORDINE

L'importo minimo del singolo ordine deve essere (uguale / o maggiore) di € 100 al netto degli sconti e spese accessorie per ordini ricevuti dall'Italia.

Per il resto d'Europa e paesi extra UE attenersi a quanto concordato con LighTech al momento della stipula del contratto / accordo commerciale.

MARCHI

I seguenti marchi registrati con i nomi: Aprilia®, BMW®, Ducati®, Honda®, Kawasaki®, Mv Agusta®, Suzuki®, Triumph®, Yamaha® sono di proprietà delle rispettive Case e vengono qui utilizzati a solo titolo descrittivo.

AGGIORNAMENTI AL CATALOGO

LighTech si riserva la facoltà di apportare aggiornamenti migliorativi ai prodotti ed al loro aggiornamento applicativo in qualsiasi momento e senza preavviso.

AVVERTENZE

I prodotti LighTech® sono stati progettati e realizzati per l'utilizzazione in ambiti agonistici. LighTech® non si assume pertanto alcuna responsabilità per un eventuale uso non corretto e responsabile dei propri prodotti.

INFORMAZIONE SUI PRODOTTI

Tutti gli articoli inseriti nel catalogo realizzati in leghe leggere vengono prodotti in Italia presso gli stabilimenti della LighTech.

Tutte le fotografie, le informazioni e le schede tecniche che illustrano i prodotti e le loro caratteristiche tecniche, sono di proprietà esclusiva della LighTech srl.

CONTROVERSIE E RESPONSABILITÀ

Le presenti condizioni generali di vendita sono regolate dalle leggi Italiane. Per qualsiasi controversia relativa alla validità, interpretazione o esecuzione delle medesime, la competenza territoriale è quella della città di Treviso in Italia.

Sales conditions

PRICES

The prices on the catalogue are in € currency, VAT excluded.

TRANSPORT

The transport is by express courier and shipping costs are charged in the invoice.

DELIVERY TIMES AND TERMS

Normally delivery times are within 2/3 working days from the receipt of the order for Italy. For the rest of the World, delivery times are planned based on product availability and the needs of Dealer / Distributor in agreement with LighTech.

LighTech® is distributed worldwide through its own sales network.

RETURNS GOODS

In the event that the customer receives a product that has defects or anomalies with respect to what was ordered, the customer must inform LighTech Customer Service within 5 working days by writing to sales@lightech.it providing details on the goods ordered, invoice number and reasons for complaint, along with pictures whenever possible.

The customer will receive detailed information on terms and conditions for the possible return of the product and for its replacement or credit note.

MINIMUM ORDER

For orders received from Italy, the minimum order amount must be equal to or greater than € 100 net of discounts, taxes and shipping costs.

For the rest of Europe and Non-Eu countries, comply with what was agreed with LighTech at the time of the conclusion of the commercial agreement / contract.

TRADEMARK

Aprilia®, BMW®, Ducati®, Honda®, Kawasaki®, Mv Agusta®, Suzuki®, Triumph®, Yamaha® are registered Trademarks, here used only as a reference.

CATALOG UPDATES

LighTech® reserves the right to make improvements to the products and their applications at any time and without notice.

WARNINGS

LighTech® products have been designed and manufactured for agonistic use. LighTech® is therefore not responsible for any unproper use of its products.

PRODUCT INFORMATION

All LighTech products included in the catalog are made of light alloys and are produced in Italy at LighTech factories.

Each photos and information present in the catalog are owned by LighTech srl. All rights reserved.

DISPUTES AND LIABILITY

These general sales conditions are governed by Italian laws. For any dispute relating to the validity, interpretation or execution of the same, the territorial jurisdiction is that of the city of Treviso in Italy.



Lighttech in EICMA





Ligtech srl
Via Serenissima, 11
31025 S. Lucia di Piave (TV)

Tel. +39 0438 453010
Fax +39 0438 655919

info@lightech.it
www.lightech.it



LighTech Racing



Ligtech_official



@LighTech_Racing