

FORBIKES

S.R.L.

COMPONENTI PER MOTOCICLI

A-SIBER
ACCIDENTS FOR ALL MOTORCYCLISTS

Barkbusters
HANDGUARDS

CLICK'N'RIDE
QUICK RELEASE MOTORCYCLE TURN INDICATORS

DAYTONA

EAZI-GRIP
TANK GRIP PERFORMANCE



FK VISORS
THE VISORS SPECIALISTS



nonoise
HEARING PROTECTORS MOTORSPORT

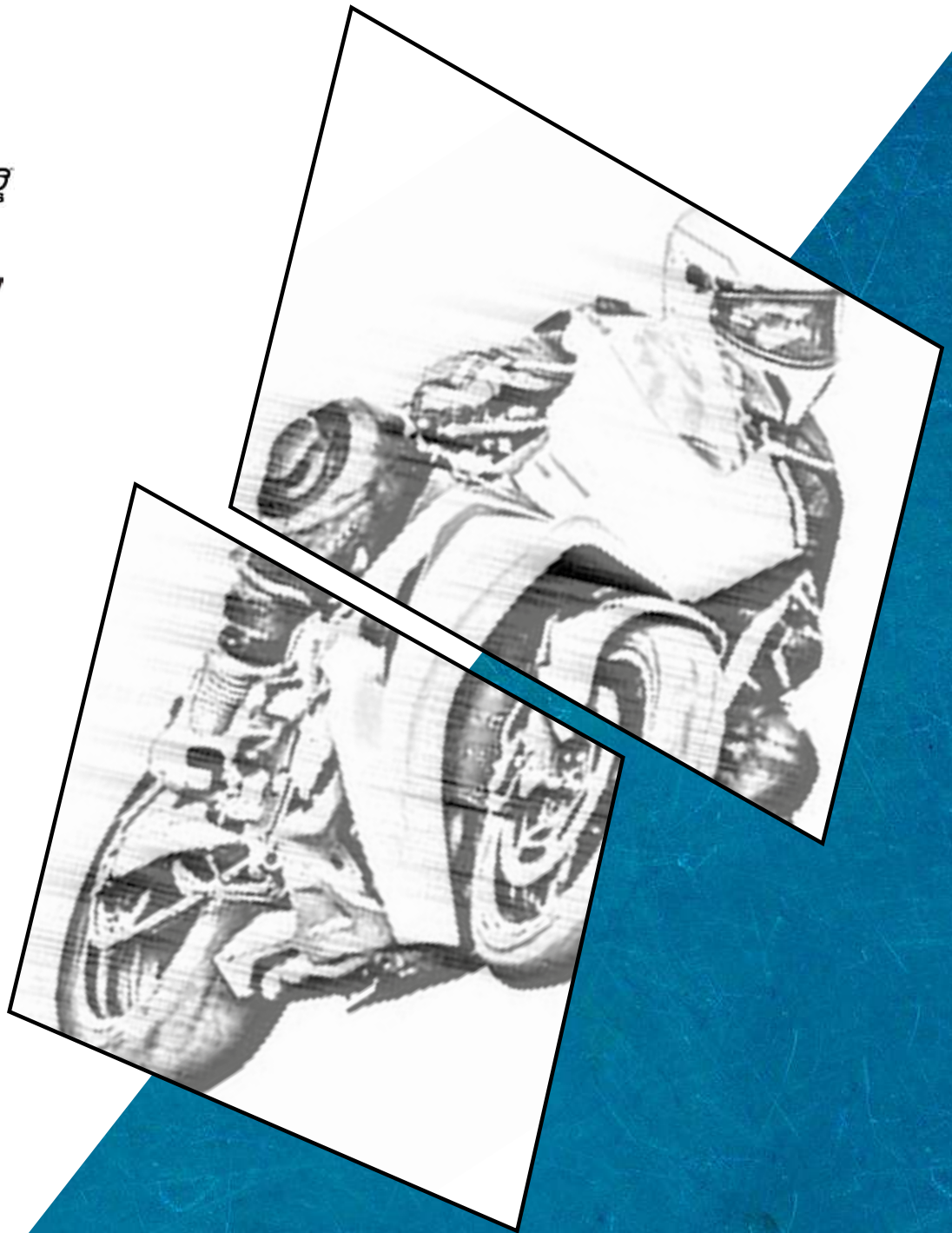

CATALOGO 2020



CONDIZIONI GENERALI DI VENDITA	pag. 2
FORBIKES	pag. 5
ACCESSORI	pag. 6
MANUBRI E AFFINI	pag. 13
LEVE	pag. 16
MANOPOLE	pag. 31
STABILIZZATORI	pag. 37
SPECCHI	pag. 40
INTERRUTTORI	pag. 42
FANALERIA	pag. 48
FRECCE	pag. 52
LAMPADE	pag. 60
RICAMBI	pag. 61
ATTREZZATURA	pag. 70
ADESIVI	pag. 73
CAVALLETTI	pag. 76
ABBIGLIAMENTO	pag. 83
GUANTI	pag. 86
A-SIDER	pag. 89
BARKBUSTERS	pag. 95
CLICK N' RIDE	pag. 99
DAYTONA	pag. 103
EAZI-GRIP	pag. 111
FK VISORS	pag. 125
HEL PERFORMANCE	pag. 133
KAOKO	pag. 187
NONOISE	pag. 205
R&G RACING	pag. 209

CONDIZIONI GENERALI DI VENDITA

PRODOTTI:

FORBIKES non si assume nessuna responsabilità in merito alla completezza, correttezza ed aggiornamento del catalogo. Le caratteristiche e i dati tecnici relativi ai prodotti presenti in questo catalogo non sono impegnativi e possono essere modificati senza alcun preavviso.

MARCHI:

I seguenti marchi registrati con i nomi: Aprilia, Ducati, Honda, Kawasaki, Suzuki, Triumph, MV Agusta, Yamaha e altri sono di proprietà delle rispettive Case e vengono qui utilizzati solo a titolo descrittivo.

INOLTRO ORDINI:

Verranno accettati ed evasi secondo la disponibilità del momento.

Si accettano ordini a mezzo fax, e-mail, tramite il ns. sito web aziendale o tramite agente di zona.

Gli ordini o le variazioni di ordini già inviati non verranno accettati telefonicamente.

Per ordini inferiori a € 100,00 I.V.A. esclusa, verrà applicato pagamento in contrassegno con addebito di spese incasso contrassegno e spese di trasporto.

GESTIONE INEVASI (BACK-ORDER):

FORBIKES gestisce i back-order (inevasi); gli articoli ordinati ma rimasti in back-order verranno quindi spediti SEMPRE non appena disponibili a magazzino, con il prossimo ordine o singolarmente.

Il cliente potrà comunque fare espressa richiesta di annullamento back-order via fax o e-mail o semplicemente indicando la dicitura "annullare inevasi precedenti" al momento dell'invio di un ordine successivo.

CONSEGNA & TRASPORTO:

La merce viene spedita a mezzo ns. corriere convenzionato in Porto Franco Destino, senza alcun tipo di copertura assicurativa e con addebito in fattura, per tutte le spedizioni salvo casi particolari da concordare tra le parti.

Resta inteso che la merce viaggia comunque a rischio e pericolo del committente.

FORBIKES non è responsabile per ritardi nelle consegne rispetto a quanto stabilito, e non riconoscerà in alcun modo eventuali danni conseguenti.

ARTICOLI DIFETTOSI:

FORBIKES si impegna a sostituire gli articoli difettosi o danneggiati durante il trasporto.

In quest'ultimo caso sarà necessario firmare la ricevuta del corriere con "riserva di verifica" se gli imballi risultano esteriormente e visibilmente danneggiati.

PREZZI:

Tutti i prezzi indicati sono in EURO e da intendersi I.V.A. esclusa. Gli stessi sono da FORBIKES consigliati al pubblico.

PAGAMENTI:

Sono da effettuarsi esclusivamente al ns. domicilio di Reggio Emilia, senza sconti o arrotondamenti.

Pagamenti al ns. personale non espressamente autorizzato sono a rischio e pericolo del Cliente.

Salvo accordi contrattuali diversi, i pagamenti accettati sono: bonifico anticipato, contrassegno (assegno bancario non trasferibile intestato al mittente o contanti) o RIBA e gli stessi devono essere concordati direttamente con il ns. agente di zona.

Le spese per i pagamenti a mezzo RIBA verranno addebitate su fattura a carico del Cliente.

Per pagamenti ritardati oltre i limiti previsti dalla fattura, verranno addebitati interessi nella misura pari agli interessi legali maggiorati di tre punti percentuali e relative spese.

FORBIKES si riserva la possibilità di sospendere le eventuali forniture in corso e/o successive in caso di mancato pagamento di forniture precedenti. La merce resta di proprietà della FORBIKES fino ad estinzione del pagamento.

SCONTI:

Da concordare con agente di zona e comunque da FORBIKES autorizzati.

RESI MERCE - GARANZIE:

Non si accettano resi merce se prima non autorizzati dal ns. Ufficio Commerciale e comunque dovranno essere comunicati entro 10gg. lavorativi dal ricevimento della merce. La richiesta di autorizzazione al reso dovrà essere inviata a FORBIKES tramite la compilazione dell'apposito modulo allegato al catalogo e successivamente confermata da FORBIKES con l'invio al cliente dello stesso modulo "RIENTRO MERCE AUTORIZZATO".

Tutti i resi dovranno essere comunque spediti Franco ns. magazzino di Reggio Emilia a spese del cliente, salvo diversa disposizione. La responsabilità di FORBIKES resta limitata alla sostituzione o al rimborso del prezzo dell'articolo in questione, tramite nota di credito. FORBIKES declina ogni responsabilità per danni arrecati a terzi e/o a parti complementari, dalla merce fornita, danni derivanti alle operazioni di montaggio/smontaggio della medesima.

Resta inteso che non si provvederà a rimborso alcuno di spese relative alta manodopera per assemblaggio, lavorazione o altro (fermo tecnico ecc..).

CONTESTAZIONI:

Per qualsiasi controversia il Foro competente è quello di Reggio Emilia.

TRATTAMENTO DATI:

FORBIKES è responsabile del trattamento dei dati ai sensi della tutela della PRIVACY.

Consultare www.forbikes.it > sezione Informativa sulla Privacy. Una copia informativa completa è disponibile su richiesta.

Per presa visione di quanto sopra il cliente accetta ogni condizione di vendita





FORBIKES

FORBIKES S.R.L.
— COMPONENTI PER MOTOCICLI —



BORSA DA SELLA "HENLYBEGINS" DH-722/A4		FASCIA E
97241	7-12 LT - NERO	€ 72,95



BORSA DA SELLA "HENLYBEGINS" DH-708		FASCIA E
95734	4 LT - NERO CARBON	€ 64,75
95735	4 LT - ROSSO CARBON	€ 64,75
95736	4 LT - BLU CARBON	€ 64,75
95741	4 LT - NERO	€ 64,75



BORSA DA SELLA "HENLYBEGINS" DH-723		FASCIA E
97087	6 LT - NERO	€ 64,75



BORSA DA SELLA "HENLYBEGINS" DH-710		FASCIA E
96043	7 LT - NERO	€ 72,95



BORSA DA SELLA "HENLYBEGINS" DH-731		FASCIA E
98661	7-12 LT - NERO	NEW € 113,93



BORSA DA SERBATOIO "HENLYBEGINS" DH-727		FASCIA E
98657	5 LT - NERO (INCLUSA CUSTODIA IMPERMEABILE)	NEW € 77,87



BORSA DA SERBATOIO "HENLYBEGINS" (INCLUSA CUSTODIA IMPERMEABILE E TASCA PER SMARTPHONE)		FASCIA E
95603	TG.M, 4-5 LT - NERO	NEW € 110,66
95604	TG.L, 6-8 LT - NERO	NEW € 127,05





BORSA DA SELLA "HENLYBEGINS"

FASCIA
E

96719	DH-717, 20-26 LT - NERO	NEW	€ 151,64
96720	DH-718, 33-42 LT - NERO	NEW	€ 188,52
96721	DH-719, 44-60 LT - NERO	NEW	€ 200,82
97980	DH-724, 53-70 LT - NERO	NEW	€ 221,31

**BORSETTA PORTA-ATTREZZI
A PARAFANGO NERA**

FASCIA
A

00-0040	€ 9,50
---------	--------



BORSA DA SELLA "HENLYBEGINS"

FASCIA
E

98878	DH-732, 20 LT - NERO	NEW	€ 229,51
98879	DH-733, 40 LT - NERO	NEW	€ 278,69
98880	DH-734, 55 LT - NERO	NEW	€ 307,38

**BORSE LATERALI "HENLYBEGINS"
DH-725**

FASCIA
E

98655	32LT - NERO	NEW	€ 143,44
-------	-------------	-----	----------



**RETINA PORTA OGGETTI UNIVERSALE
SOTTOSELLA PER SCOOTERS**

FASCIA
A

00-0481	100CC - TIPO GRANDE 25x32x15 cm	€ 14,00
00-0491	50CC - TIPO PICCOLO 23x27x13 cm	€ 14,00

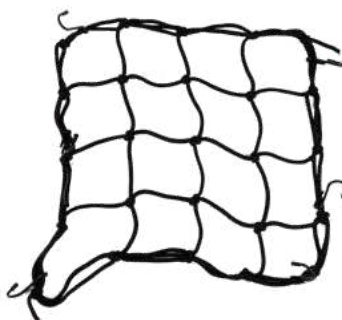

**RETE ELASTICA FERMA CARICO
RINFORZATA**

FASCIA
A

00-0230	NERO - 38x38	€ 4,90
00-0233	BLU - 38x38	€ 4,90
00-0234	ROSSO - 38x38	€ 4,90
00-0771	NERO - 40x40	NEW € 4,90

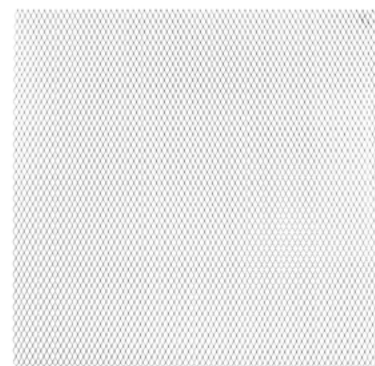

**RETINA DECORATIVA ALLUMINIO
30x30cm**

FASCIA
A

12-0200	ARGENTO	€ 9,90
12-0201	NERO	€ 9,90

SEGGIOLINO BIMBO MAXI-SCOOTER/MOTO CERTIFICATO TÜV

Fondamentale per il trasporto dei bambini da 14 Kg a 30 Kg, è dotato di 6 cinghie per un montaggio rapido e sicuro alla sella del motoveicolo e di staffe poggia piedi regolabili. Comodo, sicuro, estremamente resistente. Certificato TÜV.



SEGGIOLINO BIMBO MAXI-SCOOTER/MOTO

00-0281

FASCIA
E

€ 155,80

SELLA IN NEOPRENE

TIPO A

lunghezza max 17 cm



lunghezza max 30 cm

altezza max 29 cm

TIPO B

lunghezza max 20,5 cm



lunghezza max 27 cm

altezza max 34,5 cm

TIPO C

lunghezza max 29 cm



lunghezza max 28 cm

altezza max 32,5 cm

SELLA IN NEOPRENE ADESIVO PER CARENE IN VTR

00-0391 TIPO A

00-0401 TIPO B

00-0411 TIPO C

FASCIA
E

€ 27,00

€ 27,00

€ 27,00

CUSCINO MEMORY FOAM IN GEL "SALVACHIAPPE"

Cuscinetto dal nome provocante, senza fronzoli o termini incomprensibili, dopo infiniti tentativi, dopo reali KM di test effettuati direttamente dai nostri più fedeli clienti, abbiamo affinato un prodotto decisamente performante: dall'unione di una particolare **MEMORY FOAM** (prodotta per nostra esclusiva ad alta portanza) con il ben più noto gel, nasce il prorompente **SALVACHIAPPE!!** Del quale il nome non vuole solo essere una trovata commerciale ma una concretezza!!

Pratico da installare, viene fornito in tre formati principali, adattabili alla maggior parte di moto in circolazione, il montaggio richiede davvero pochi minuti, ideale per chi non vuole intervenire sulla struttura originale della sella, perfetto per chi non vuole storpiare l'estetica affusolata di una seduta sportiva. Migliorerà notevolmente il comfort senza avere la fastidiosa sensazione di galleggiamento causata da altri noti cuscini ad aria. Grazie al suo particolare rivestimento antiscivolo, l'aderenza non sarà compromessa e di conseguenza nemmeno il vostro stile di guida.

Provatelo....



TIPO A	TIPO B	TIPO C
lungh. max 23 cm	lungh. max 23,5 cm	lungh. max 27 cm
		
FASCIA G	FASCIA G	FASCIA G
00-0591 NERO, SPESSORE 3CM € 68,00	00-0601 NERO, SPESSORE 3 CM € 75,00	00-0611 NERO, SPESSORE 3 cm € 82,00

ISTRUZIONI DI MONTAGGIO IN TRE SEMPLICI FASI



1. Rimuovete la sella dalla propria sede sulla motocicletta;
2. Una volta appoggiato il cuscinetto nella posizione più corretta da voi individuata fate aderire tra loro i velcri appositamente fissati agli elastici nella parte sottostante alla struttura in plastica (n.b. nel caso gli elastici risultassero lunghi potete incrociarli tra loro per ottenere un miglior tiraggio vedi foto);
3. Reinstallate nel proprio alloggio la sella facendo attenzione che gli elastici non intralcino i relativi sistemi di fissaggio.

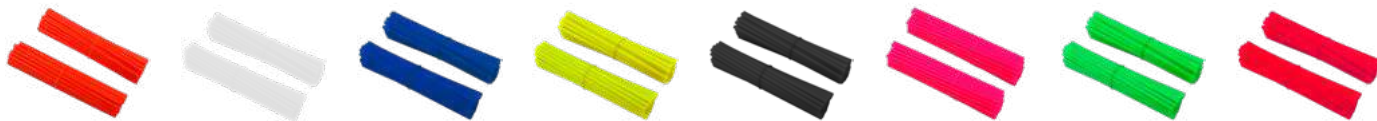

KIT COVER RAGGI CERCHI - RUOTA 18"-21"
(ANT.38PZ 8,5" + POST.38 PZ 8,5")

	FASCIA A
00-0690 BIANCO	NEW € 16,20
00-0691 NERO	NEW € 16,20
00-0693 BLU	NEW € 16,20
00-0694 ROSSO	NEW € 16,20
00-0695 GIALLO FLUO	NEW € 16,20
00-0696 ROSA SCURO	NEW € 16,20
00-0697 ARANCIO	NEW € 16,20
00-0698 VERDE FLUO	NEW € 16,20



PROTEZIONE SILENZIATORE 5"
(12,7cm), SILENZIATORI 102-127mm

	FASCIA C
00-0711 NERO	NEW € 29,00
00-0712 BIANCO	NEW € 29,00
00-0713 BLU	NEW € 29,00
00-0714 ROSSO	NEW € 29,00
00-0715 GIALLO	NEW € 29,00
00-0717 ARANCIO	NEW € 29,00
00-0718 VERDE	NEW € 29,00

PROTEZIONE SILENZIATORE 6"
(15cm), SILENZIATORI 127-152mm

	FASCIA C
00-0701 NERO	NEW € 29,00
00-0702 BIANCO	NEW € 29,00
00-0703 BLU	NEW € 29,00
00-0704 ROSSO	NEW € 29,00
00-0705 GIALLO	NEW € 29,00
00-0707 ARANCIO	NEW € 29,00
00-0708 VERDE	NEW € 29,00



LUNGHEZZA MAX
128 cm



CAVETTO "MEMORY"
PER BLOCCADISCO

	FASCIA A
00-0150	€ 3,90



TAPPO PER MARMITTA 2T

	FASCIA C
00-0564 35 mm - ROSSO	€ 3,50
00-0575 55 MM - GIALLO	€ 4,50



TAPPO VALVOLA "HEXAGONE"

	FASCIA A
12-0010 ARGENTO	€ 3,50
12-0013 BLU	€ 3,50
12-0014 ROSSO	€ 3,50
12-0015 ORO	€ 3,50



TAPPINO IN GOMMA COLORATO - SPURGO PINZA/POMPA

FASCIA
C

00-0581	NERO	€ 1,47
00-0583	BLU	€ 1,47
00-0584	ROSSO	€ 1,47
00-0585	GIALLO	€ 1,47
00-0587	ARANCIO	€ 1,47
00-0588	VERDE	€ 1,47



SET PEDANE

FASCIA
E

96557	SET PEDANE PILOTA TKM - HONDA / SUZUKI	€ 163,89
96558	SET PEDANE PILOTA TKM - YAMAHA	€ 163,89
96559	SET PEDANE PILOTA TKM - KAWASAKI	€ 163,89
96574	SET PEDANE PASSEGGERO TKM - HONDA	€ 163,89
96575	SET PEDANE PASSEGGERO TKM - YAMAHA	€ 163,89
96576	SET PEDANE PASSEGGERO TKM - SUZUKI	€ 163,89
96660	SET PEDANE PASSEGGERO TKM - KAWASAKI TIPO 1	€ 163,89
96661	SET PEDANE PASSEGGERO TKM - KAWASAKI TIPO 2	€ 163,89
97202	SET PEDANE PILOTA TKM - KAWASAKI NINJA 250/400 2018	NEW € 163,89

TELO COPRIMOTO OUTDOOR FORBIKES



**TELO COPRIMOTO IMPERMEABILE
FORBIKES - INTERNO RIVESTITO
IN COTONE**

FASCIA
A

00-0640	TG.S - 198x98 cm	€ 37,80
00-0650	TG.M - 223x121 cm	€ 37,80
00-0660	TG.L - 229x125 cm	€ 37,80
00-0670	TG.XL - 247x142 cm	€ 37,80

TELO COPRIMOTO INDOOR FORBIKES



TELO COPRIMOTO INDOOR FORBIKES

FASCIA
C

00-0721L	TG.L - ELASTICIZZATO SU 4 LATI - NERO	NEW	€ 64,00
00-0721XL	TG.XL - ELASTICIZZATO SU 4 LATI - NERO	NEW	€ 64,00
00-0723L	TG.L - ELASTICIZZATO SU 4 LATI - BLU	NEW	€ 64,00
00-0723XL	TG.XL - ELASTICIZZATO SU 4 LATI - BLU	NEW	€ 64,00
00-0724L	TG.L - ELASTICIZZATO SU 4 LATI - ROSSO	NEW	€ 64,00
00-0724XL	TG.XL - ELASTICIZZATO SU 4 LATI - ROSSO	NEW	€ 64,00



MANUBRI "ALLUMINIO BICOLOR"

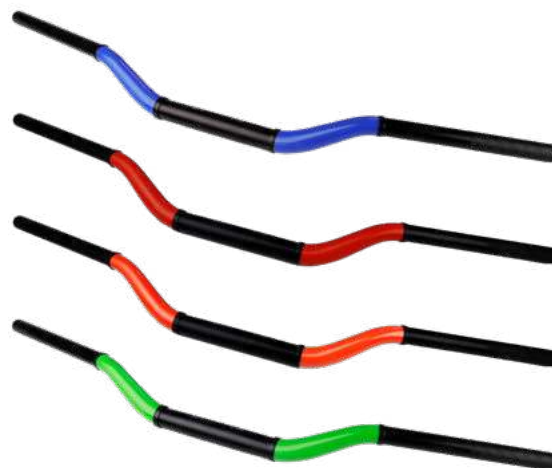

MANUBRIO "ALUMINIUM BICOLOR" DIAM.28,6 mm ANODIZZATO		FASCIA C
12-0743	NERO INSERTI BLU	NEW € 75,00
12-0744	NERO INSERTI ROSSO	NEW € 75,00
12-0747	NERO INSERTI ARANCIO	NEW € 75,00
12-0748	NERO INSERTI VERDE	NEW € 75,00

MANUBRIO AL6061 ANODIZZATO

		FASCIA C
DIAMETRO 22,2 mm		
12-0370	MEDIO - ARGENTO	€ 32,90
12-0371	MEDIO - NERO	€ 32,90
12-0373	MEDIO - BLU	€ 32,90
12-0374	MEDIO - ROSSO	€ 32,90
12-0375	MEDIO - ORO	€ 32,90
12-0380	BASSO - ARGENTO	€ 32,90
12-0381	BASSO - NERO	€ 32,90
12-0383	BASSO - BLU	€ 32,90
12-0384	BASSO - ROSSO	€ 32,90
12-0385	BASSO - ORO	€ 32,90
12-0390	EXTRABASSO - ARGENTO	€ 32,90
12-0391	EXTRABASSO - NERO	€ 32,90
12-0393	EXTRABASSO - BLU	€ 32,90
12-0394	EXTRABASSO - ROSSO	€ 32,90
12-0395	EXTRABASSO - ORO	€ 32,90
DIAMETRO 28,6 mm		
12-0400	MEDIO - ARGENTO	€ 66,00
12-0401	MEDIO - NERO	€ 66,00
12-0410	EXTRA BASSO - ARGENTO	€ 66,00
12-0411	EXTRA BASSO - NERO	€ 66,00

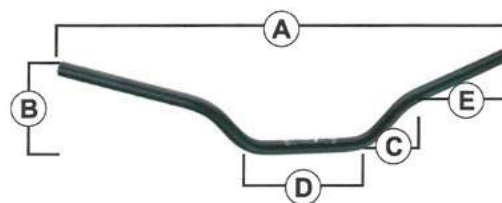

MANUBRI DIAMETRO 28,6 mm

	A	B	C	D	E
MEDIO	725	115	85	185	105
EXTRA BASSO	725	75	50	185	95

MANUBRI DIAMETRO 22,2 mm

	A	B	C	D	E
MEDIO	725	115	85	185	105
BASSO	755	100	60	195	80
EXTRA BASSO	725	75	50	185	95

CP.SEMIMANUBRI RACING INCLINAZIONE 7° E DIAMETRO 22,2 mm		FASCIA C
12-0430	DIAM.41mm. ALLUMINIO	€ 115,00
12-0431	DIAM.41mm. NERO	€ 115,00
12-0440	DIAM.43mm. ALLUMINIO	€ 115,00
12-0441	DIAM.43mm. NERO	€ 115,00
12-0450	DIAM.45mm. ALLUMINIO	€ 115,00
12-0451	DIAM.45mm. NERO	€ 115,00
12-0460	DIAM.48mm. ALLUMINIO	€ 115,00
12-0461	DIAM.48mm. NERO	€ 115,00
12-0470	DIAM.50mm. ALLUMINIO	€ 115,00
12-0471	DIAM.50mm. NERO	€ 115,00
12-0480	DIAM.52mm. ALLUMINIO	€ 115,00
12-0481	DIAM.52mm. NERO	€ 115,00
12-0490	DIAM.54mm. ALLUMINIO	€ 115,00
12-0491	DIAM.54mm - NERO	€ 115,00



CP.SEMIMANUBRI RIALZATI 45mm, INCLINAZIONE REGOLABILE		FASCIA C
12-0510	DIAM.41 - ALLUMINIO	€ 159,00
12-0511	DIAM.41 - NERO	€ 159,00
12-0520	DIAM.43 - ALLUMINIO	€ 159,00
12-0521	DIAM.43 - NERO	€ 159,00
12-0530	DIAM.45 - ALLUMINIO	€ 159,00
12-0531	DIAM.45 - NERO	€ 159,00
12-0540	DIAM.48 - ALLUMINIO	€ 159,00
12-0541	DIAM.48 - NERO	€ 159,00
12-0550	DIAM.50 - ALLUMINIO	€ 159,00
12-0551	DIAM.50 - NERO	€ 159,00
12-0560	DIAM.52 - ALLUMINIO	€ 159,00
12-0561	DIAM.52 - NERO	€ 159,00
12-0570	DIAM.54 - ALLUMINIO	€ 159,00
12-0571	DIAM.54 - NERO	€ 159,00



CP. BARRE DI RICAMBIO PER SEMIMANUBRI RACING DIAM. 22,2 - LUNGHEZZA 28,5 mm	FASCIA C
12-0500	ALLUMINIO € 19,90
12-0501	NERO € 19,90



CP. BARRE DI RICAMBIO PER SEMIMANUBRI RIALZATI-REGOLABILI DIAM. 22,2 - LUNGHEZZA 28,5 mm	FASCIA C
12-0580	ALLUMINIO € 29,00
12-0581	NERO € 29,00



**KIT ALTEZZA VARIABILE RISER
MANUBRIO 22,2 mm**

12-0240

FASCIA
C

€ 39,90



**KIT ALTEZZA VARIABILE RISER
MANUBRIO 28,6 mm**

12-0680

FASCIA
C

€ 52,00

**CP.RISER MANUBRIO 28,6 mm
FISSAGGIO SILENT BLOCK CONICI**

12-0251

FASCIA
C

€ 49,90



**CP.RISER MODIFICA MANUBRIO
DA 22,2 A 28,6 mm**

12-0611

FASCIA
C

€ 49,00

**CP.RISER ALLUMINIO LUCIDO AL6061
PER MANUBRIO 22,2 mm
AVANZATI E RIALZATI**

12-0620

FASCIA
C

€ 72,00

KIT RIALZO MANUBRIO BASCULANTE

12-0591 22,2 MM

12-0601 28,6 MM

FASCIA
C

€ 80,00

€ 80,00



**PREZZO
RIBASSATO**

LEVA CAMBIO ALLUMINIO HONDA CRF	FASCIA A
01-0014 ROSSO	€ 28,00



**PREZZO
RIBASSATO**

LEVA CAMBIO ALLUMINIO YAMAHA YZ/YZF	FASCIA A
01-0023 BLU	€ 28,00



**PREZZO
RIBASSATO**

LEVA CAMBIO ALLUMINIO YAMAHA YZ/YZF/WR	FASCIA A
01-0033 BLU	€ 28,00



**PREZZO
RIBASSATO**

LEVA CAMBIO ALLUMINIO KTM	FASCIA A
01-0047 4 TEMPI ARANCIO	€ 28,00
01-0057 2 TEMPI ARANCIO	€ 28,00



**PREZZO
RIBASSATO**

LEVA CAMBIO ALLUMINIO KTM LC4	FASCIA A
01-0067 ARANCIO	€ 28,00



**PREZZO
RIBASSATO**

LEVA CAMBIO ALLUMINIO KAWASAKI/SUZUKI 250 4T	FASCIA A
01-0070 LUCIDO	€ 28,00



**PREZZO
RIBASSATO**

LEVA CAMBIO ALLUMINIO KAWASAKI KX 2T	FASCIA A
01-0080 LUCIDO	€ 28,00



**PREZZO
RIBASSATO**

LEVA CAMBIO ALLUMINIO SUZUKI RM	FASCIA A
01-0095 RM 125 ORO	€ 28,00
01-0105 RM 250 ORO	€ 28,00



**PREZZO
RIBASSATO**

LEVA CAMBIO ALLUMINIO SUZUKI 450Z	FASCIA A
01-0145 ORO	€ 28,00

LEVE FRENO / FRIZIONE "SYNCRO"

DISPONIBILI SOLO IN COLORE NERO

FASCIA
C

€ 54,90



REGOLABILI IN LUNGHEZZA / DISTANZA E RECLINABILI

NOTA IMPORTANTE: il prezzo della leva comprende già il pezzo finale colorato

Le tabelle delle quattro pagine successive contengono l'applicativo delle leve Syncro.

SPECIFICARE SEMPRE IL COLORE DEL PEZZO FINALE:

EZZO PARTE FINALE A RICAMBIO LEVA "SYNCRO"	FASCIA C
01-END00 ALLUMINIO	€ 9,92
01-END07 GRIGIO TITANIO	€ 9,92
01-END01 NERO	€ 9,92
01-END03 BLU	€ 9,92
01-END04 ROSSO	€ 9,92
01-END05 ORO	€ 9,92
01-END07 ARANCIO	€ 9,92
01-END08 VERDE	NEW € 9,92



POSSIBILITÀ DI ACQUISTARE A PARTE ANCHE SOLAMENTE LA PARTE FINALE COLORATA A RICAMBIO.

APPLICATIVO LEVE "SYNCRO"

COD. FRENO	COD. FRIZIONE	MODELLI MOTO
APRILIA		
01-F111	01-V41	RSV4/RSV4 FACTORY 2009-2015
01-F111	01-H111	RSV MILLE / R 2004-2008
01-DB801	01-DC801	RSV MILLE / R 1999-2003
01-DB801	01-DC801	TUONO / R 2003-2009
01-DB801	01-V41	TUONO V4R 2011-2015
01-DB801	01-DC801	FALCO / SL1000 2000-2004
01-F161	01-DC801	CAPONORD / ETV1000 2002-2007
01-DB801	01-DC801	CAPONORD 1200 2014
01-F161	01-DC801	RST1000 FUTURA 2001-2004
01-F231	01-C231	SHIVER / GT 2007-2015
01-F231	01-C231	DORSODURO 750 2008-2015
01-DB801	01-DC801	DORSODURO 1200 2011-2015
01-F231	NON DISP.	MANA 2007-2012
BENELLI		
01-F111	01-H111	TNT R160 2010-
BIMOTA		
01-F161	01-DC801	DB5S 2008
01-F111	01-H111	DB6R 2008
01-F111	01-H111	TESI 3D 2008
BMW		
01-B11	01-B81	F650GS 2008-2012
01-B11	01-B81	F700GS 2013-2016
01-B11	01-B81	F800S 2006-2013
01-B11	01-B81	F800ST 2006-2015
01-B11	01-B81	F800GS 2008-2016
01-B11	01-B81	F800R 2009-2015
01-B11	01-B81	F800GT 2013-2015
01-F221	01-B221	S1000RR 2010-2014
01-F221	01-B221	S1000R 2014
01-B11	01-B21	K1200R 2005-2008
01-B11	01-B21	K1200R SPORT 2006-2008
01-B11	01-B21	K1200S 2004-2008
01-B11	01-B21	R1200R 2006-2014
01-B11	01-B21	R1200RT/SE 2010-2013
01-B11	01-B21	R1200S 2006-2008
01-B11	01-B21	R1200ST 2005-2008
01-B11	01-B21	R1200GS 2004-2012
01-B11	01-B21	R1200GS ADVENTURE 2006-2013
01-B11	01-B21	K1300 S/R/GT 2009-2015
01-B11	01-B21	K1600 GT/GTL 2011-2015
01-M11	01-M111	HP2 SPORT 2008-2011
BUELL		
01-F141	01-C7771	1125R 2008-2009

COD. FRENO	COD. FRIZIONE	MODELLI MOTO
01-F141	01-C7771	1125CR 2009
01-D801	01-HLC1	1130 2005-2007
01-F141	01-B551	XB12R 2009
01-F141	01-B551	XB12SS 2009
01-F141	01-B551	XB12SCG 2009
01-F201	01-B551	ULYSSES XB12XT 2009
01-F201	01-B551	ULYSSES XB12X 2009
01-F201	01-B551	XB12 ALL MODELS UP TO 08 ONLY 2004-2008
01-F201	01-B551	XB9 ALL MODELS 2003-2009
01-F141	01-B551	X1 LIGHTNING 1998-2002
01-F141	01-B551	S1 LIGHTNING 1997-1998
01-F141	01-B551	M2 CYCLONE 1997-2002
DUCATI		
01-F111	01-H111	DIAVEL/CARBON 2011-2015
01-F111	01-H111	749/S/R 2003-2006
01-DB121	01-D221	HYPERMOTARD 796 2010-2012
01-D011	01-D821	HYPERMOTARD 821 SP 2013-2015
01-DB121	01-D821	HYPERMOTARD 821/STRADA 2013-2015
01-DB121	01-D821	MONSTER 821 2014-2015
01-F111	01-H111	848/EVO 2007-2013
01-F111	01-H111	STREETFIGHTER /S 2009-2013
01-F111	01-H111	STREETFIGHTER 848 2012-2015
01-F991	01-H111	899 PANIGALE 2014-2015
01-F111	01-H111	999/S/R 2003-2006
01-F111	01-H111	1098/S/TRICOLOR 2007-2008
01-DB801	01-DC801	MTS1100/S 2007-2009
01-F111	01-H111	M1100/S/EVO MONSTER 2009-2013
01-D011	01-H111	HYPERMOTARD 1100/S/EVO SP 2007-2012
01-F111	01-H111	1198/S/R 2009-2011
01-F991	01-H111	1199 PANIGALE/S/TRICOLOR 2012-2015
01-F111	01-H111	MULTISTRADA 1200/S 2010-2015
01-F991	01-H111	MONSTER 1200/S 2014-2015
01-F111	01-H111	MONSTER 1200 2014-2015
01-F111	01-H111	S4RS 2006-2008
01-DB801	01-DC801	MS4/MS4R 2001-2006
01-DB801	01-DC801	M900/M1000 2000-2005
01-DB801	01-DC801	900SS/1000SS 1998-2006
01-DB801	01-DC801	996/998/B/S/R 1999-2003
01-DB801	01-DC801	748/750SS 1999-2002
01-DB801	01-DC801	MTS1000SDS/DS 2004-2006
01-DB121	01-D221	ST4S 2003
01-DB801	01-DC801	ST4/S/ABS 2004-2006
01-DB801	01-DC801	ST3/S/ABS 2003-2007
01-DB801	01-DC801	SPORT 1000 2006-2009

APPLICATIVO LEVE "SYNCRO"

COD. FRENO	COD. FRIZIONE	MODELLI MOTO
01-DB801	01-DC801	GT 1000 2006-2010
01-DB801	01-DC801	DUCATI PAUL SMART LE 2006
01-DB801	01-DC801	S2R 1000 2006-2008
01-DB121	01-D221	400 MONSTER 2004-2007
01-DB121	01-D221	620 MONSTER / 620 MTS 2003-2006
01-DB121	01-D221	695 MONSTER 2007-2008
01-DB121	01-D221	696 MONSTER 2009-2014
01-DB121	01-D221	796 MONSTER 2011-2014
01-DB121	01-D221	MONSTER S2R 800 2005-2007
01-DB121	01-DC121	748 FINO AL 1998
01-DB121	01-DC121	916/916SPS FINO AL 1998
01-DB121	01-DC121	900SS 1991-1997
01-DB121	01-DC121	MONSTER M400 1999-2003
01-DB121	01-DC121	MONSTER M600 1994-2001
01-DB121	01-DC121	MONSTER M620 2002
01-DB121	01-DC121	MONSTER M750/M750IE 1994-2002
01-DB121	01-DC121	MONSTER M900 1994-1999
01-DB121	01-DC121	ST2 1998-2003
01-DB121	01-DC121	ST4/4S/ST4S ABS 1999-2002
HONDA		
01-FX121	01-H6061	CBR250 2010-2012
01-F251	01-H2501	CBR250R 2011-2013
01-F251	01-RS100L1	CBR300R 2011
01-F251	01-H2501	CBR300R 2014-2015
01-F251	01-H2501	CBR500R/CB500F/X 2013-2015
01-F181	01-H6261	CB599 / CB600 HORNET 1998-2006
01-F181	01-H6071	CB600F HORNET 2007-2016
01-F181	01-H6071	CBR 600F 2011-2013
01-F181	01-H651	CBR650F / CB650F 2014-2015
01-F181	01-H6261	CBR 600 F2,F3,F4,F4I 1991-2007
01-F291	01-Y688H1	CBR600RR 2003-2006
01-F331	01-Y688H1	CBR600RR 2007-2016
01-F181	01-H6071	CBF600/SA 2010-2013
01-F181	01-H6261	NC700 S/X 2012-2013
01-F181	solo freno	NC700 S/X 2014-2015
01-F181	01-V001	VF750S SABRE 1982-1986
01-F181	01-V001	VFR750 1991-1997
01-FXX1	01-V001	VFR800 1998-2001
01-F181	01-V001	VFR800/F 2002-2016
01-F181	01-H6261	CB919 2002-2007
01-F181	01-H6261	CBR900RR 1993-1999
01-F291	01-H6261	CBR929RR 2000-2001
01-F291	01-Y688H1	CBR954RR 2002-2003
01-F331	01-H331	CB1000R 2008-2015

COD. FRENO	COD. FRIZIONE	MODELLI MOTO
01-F331	01-H331	CBR1000RR / FIREBLADE 2004-2007
01-F331	01-Y688H1	CBR1000RR / FIREBLADE/SP 2008-2016
01-F291	01-H331	RC51 / RVT1000 SP-1/SP-2 2000-2006
01-F181	01-V001	VTR1000F / FIRESTORM 1998-2005
01-F181	01-V001	CBF1000 2006-2009
01-F181	01-H331	CBF1000/A 2010-2013
01-F181	01-H331	CB1100/GIO SPECIAL 2013-2015
01-FXX1	01-V001	CBR1100XX / BLACKBIRD 1997-2007
01-F121	01-H331	VFR 1200/F 2010-2014
01-F121	solo freno	VFR 1200/F 2014-2015
01-F181	01-H331	CB1300 X4 2003-2010
01-FXX1	01-V001	ST1300/ST1300A 2003-2008
01-F121	01-V001	ST1300 2008-2012
01-F181	01-H6261	VTX1300 2003-2008
01-FXX1	01-H6261	X-11 1999-2002
01-F181	01-H2501	BLACK SPIRIT 2014-2015
KAWASAKI		
01-F251	01-K251	NINJA 250R 2008-2012
01-F251	01-K251	NINJA 300R 2013-2016
01-F141	01-K7501	ZXR400 TUTTI GLI ANNI
01-F441	01-K7501	NINJA 400R 2011-2012
01-F141	01-K7501	GPZ500S/EX500R NINJA 1990-2009
01-F141	01-K7501	ER-5 2004-2005
01-F141	01-K7501	ZX-6 / ZZR600 1990-2004
01-F141	01-K7501	ZZR600 1990-2004
01-F141	01-K8281	ZZR600 2005-2009
01-F141	01-K8281	ZX6R / ZX636R / ZX6RR 2000-2004
01-F351	01-K8281	ZX636R / ZX6RR 2005-2006
01-F881	01-K8281	ZX6R/636 2007-2016
01-F441	01-K7501	ER-6N/F 2009-2016
01-F141	01-K7501	VERSYS 650 2006-2008
01-F201	01-K7501	VERSYS 650 2015-2019
01-F201	01-K7501	VULCAN S 650
01-F441	01-K7501	VERSYS 650 2009-2014
01-F141	01-K7501	NINJA 650R/ER-6F/ER-6N 2006-2008
01-F201	01-K7501	NINJA 650 2017-2019
01-F441	01-K7501	NINJA 650R/ER-6F 2009-2015
01-F141	01-C7771	ZX7R / ZX7RR 1989-2003
01-F141	01-K7501	ZR750 ZEPHYR 1991-1993
01-F201	01-K8281	Z750 (NOT Z750S MODEL) 2007-2012
01-F141	01-K7501	Z750 2004-2006
01-F141	01-K7501	Z750S (NOT Z750 MODEL) 2006-2008
01-F881	01-K8281	Z750R 2011-2012
01-F201	01-K8281	Z800/E VERSION 2013-2015

APPLICATIVO LEVE "SYNCRO"

COD. FRENO	COD. FRIZIONE	MODELLI MOTO
01-F141	01-K7501	W800/SE 2012-2014
01-F201	01-K7501	Z900 2017-2019
01-F141	01-C7771	ZX9 1994-1997
01-F141	01-K7501	ZX9R 1998-1999
01-F141	01-K8281	ZX9R 2000-2003
01-F141	01-C7771	ZG1000 CONCOURS 1992-2006
01-F881	01-K8281	Z1000SX/NINJA 1000 2011-2015
01-F141	01-K8281	VERSYS 1000 2012-2014
01-F141	01-K8281	ZX10R 2004-2005
01-F991	01-H111	ZX10R 2016-2019
01-F881	01-K8281	ZX10R 2006-2015
01-F991	01-H111	NINJA H2 /H2R
01-F141	01-K8281	Z1000 2003-2006
01-F881	01-K8281	Z1000 2007-2016
01-F881	01-K8281	Z1000 R 2017-2019
01-F881	01-K8281	Z1000 ABS 2017-2019
01-F201	01-K7501	VERSYS 1000 2015-2018
01-F141	01-C7771	ZX1100 / ZX-11 1990-2001
01-F141	01-C7771	ZRX1100 / 1200 1999-2007
01-F141	01-K8281	ZX12R 2000-2005
01-F141	01-C7771	ZZR1200 2002-2005
01-F881	01-H881	ZX1400 / ZX14R / ZZR1400 2006-2015
01-F881	01-H881	GTR1400 / CONCOURS 2007-2015
KTM		
01-FK121	01-DK121	200 DUKE 2013-2016
01-FK121	01-DK121	390 DUKE 2013-2016
01-FK121	01-DK121	RC 390 2013-2018
01-DB121	01-A901	690 ENDURO R 2014-2018
01-F111	01-A901	690 DUKE R 2014-2015
01-DB121	01-A901	690 DUKE/SMC/SMC-R 2014-2015
01-F111	01-M111	990 SUPERDUKE 2005-2012
01-F111	01-M111	RC8/R 2009-2015
01-DB121	01-A901	1090 ADVENTURE / R 2017-2018
01-D011	01-A901	1190 ADVENTURE / R 2013-2016
01-D011	01-A901	1190 SUPERADVENTURE 2015
01-F111	01-M111	1290 SUPERDUKE R 2014-2015
01-D011	01-A901	1290 SUPERADVENTURE R/S 2017-2019
MOTOGUZZI		
01-F161	01-DC801	GRISO 2006-2015
01-F161	01-D371	BREVA 2004-2009
01-F161	01-DC801	BREVA 1100 2006-2012
01-F161	01-DC801	NORGE 1200/GT8V 2006-2015
01-F161	01-DC801	1200 SPORT 2007-2013
01-F161	01-DC801	STELVIO 2008-2015

COD. FRENO	COD. FRIZIONE	MODELLI MOTO
01-F231	01-C231	CALIFORNIA CUSTOM/TOURING/CLASSIC 2014-2015
01-F231	01-C231	ELDORADO 2015
01-F231	01-C231	AUDACE 2015
01-F161	01-D371	V7 RACER 2011-2015
01-F161	01-D371	V7 CLASSIC 2008-2015
01-F161	01-D371	V7 STONE/SPECIAL 2013-2015
MV AGUSTA		
01-F111	01-H111	F4RR 2011-2016
MZ		
01-F141	01-S141	1000 S 2004-2008
01-F141	01-C7771	1000 SF 2005-2008
01-F141	01-C7771	1000 ST 2006-2008
SUZUKI		
01-F141	01-S6501	RGV 250 GAMMA
01-F141	01-S2481	GSR600 2006-2011
01-F141	01-S2481	GSXR600 1997-2003
01-F351	01-S2481	GSXR600 2004-2005
01-F351	01-S351	GSXR600 2006-2010
01-F351	01-S351	GSXR600 2011-2018
01-F141	01-S141	GSF650 BANDIT -2007
01-F141	01-S6501	SV650/S 1999-2009
01-F141	01-S2481	SVF650 GLADIUS 2009-2015
01-F141	01-S6501	DL650/V-STROM 2004-2010
01-F141	01-S2481	DL650/V-STROM 2011-2012
01-F141	01-S2481	SV 650 XA/A 2018-2019
01-F141	01-S141	GSX650F 2008-2015
01-F141	01-S141	BANDIT 650S 2015
01-F141	01-S6501	600/750 KATANA 1998-2006
01-F141	01-S2481	GSR750 2011-2015
01-F141	01-S2481	GSXR750 1996-2003
01-F351	01-S2481	GSXR750 2004-2005
01-F351	01-S351	GSXR750 2006-2010
01-F351	01-S351	GSXR750 2011-2018
01-F141	01-S2481	GSX S 750 2018-2019
01-F351	01-S351	GSX-S 1000/F/ABS 2017-2019
01-F141	01-S2481	GSXR1000 2001-2004
01-F351	01-S351	GSXR1000 2005-2006
01-F351	01-S141	GSXR1000 2007-2008
01-F351	01-S351	GSXR1000 2009-2015
01-F351	01-S351	GSXR1000 2017-2019
01-F351	01-S351	GSX-S 1000/F/ABS 2015
01-F141	01-S141	DL1000/V-STROM 2002-2016
01-F141	01-S2481	TL1000S 1997-2001

APPLICATIVO LEVE "SYNCRO"

COD. FRENO	COD. FRIZIONE	MODELLI MOTO
01-F141	01-S141	TL1000R 1998-2003
01-F141	01-S141	SV1000/S 2003-2007
01-F141	01-S141	GSF1200 BANDIT 2001-2006
01-F141	01-S141	GSF1250 BANDIT 2007-2015
01-F141	01-S141	GSX1250 F/SA/ABS 2010-2015
01-F141	01-S141	HAYABUSA/GSXR1300 1999-2007
01-F401	01-S141	HAYABUSA/GSXR1300 2008-2015
01-F351	01-S311	B-KING 2008-2011
01-F141	01-S141	GSX1400 2001-2007
TRIUMPH		
01-F141	01-T9551	TT 600 2000-2003
01-F141	01-T3331	DAYTONA 600/650 2004-2005
01-F141	01-T3331	675 STREET TRIPLE 2008-2015
01-F351	01-T3331	675 STREET TRIPLE / R/RX 2009-2016
01-F351	01-T3331	DAYTONA 675 2006-2015
01-F011	01-T3331	DAYTONA 675 R 2011-2016
01-F141	01-T9551	DAYTONA 955I 1997-2003
01-F141	01-T3331	DAYTONA 955I 2004-2006
01-F141	01-T9551	SPRINT ST 1997-2003
01-F141	01-T9551	SPRINT RS 1999-2003
01-F141	01-T9551	SPEED FOUR 2003-2004
01-F141	01-T3331	SPEED FOUR 2005-2006
01-F141	01-T9551	SPEED TRIPLE 1997-2003
01-F141	01-T3331	SPEED TRIPLE 2004-2007
01-F351	01-T3331	SPEED TRIPLE 2008-2010
01-F011	01-T3331	SPEED TRIPLE 1050 2011-2015
01-F011	01-T3331	SPEED TRIPLE R 2012-2015
01-F141	01-T3331	SPRINT ST/RS 2004-2009
01-F141	01-T3331	SPRINT GT 2011-2015
01-F141	01-T3331	THRUXTON 2004-2015
01-F141	01-T3331	THRUXTON STEVE MCQUEEN SE 2012
01-F141	01-T3331	BONNEVILLE /SE/T100 2006-2015
01-F141	01-T3331	TIGER 800/XC 2011-2014
01-F141	01-T3331	TIGER 1050/SPORT 2007-2015
01-F141	01-C7771	TIGER 1200 EXPLORER 2012-2015
01-F141	01-T3331	ROCKET III 2004-2007
01-F141	01-T3331	ROCKET III CLASSIC 2007-2010
01-F141	01-T3331	ROCKET III ROADSTER 2010-2015
01-F141	01-T3331	SCRAMBLER 2006-2015
01-F141	01-T3331	SPEEDMASTER 2006-2015
01-F141	01-C7771	TROPHY/SE 2013-2015
01-F141	01-T3331	AMERICA/LT 2006-2015
YAMAHA		
01-H531R	01-H531L	T-MAX 530 2012-2016

COD. FRENO	COD. FRIZIONE	MODELLI MOTO
01-R1041	01-C7771	V-MAX 2009-2015
01-F141	01-Y6881	YZF R6 1999-2004
01-R1041	01-Y6881	YZF R6 2005-2016
01-F141	01-Y6881	R6S (USA VERSION) 2006-2009
01-R1041	01-Y6881	R6S (CANADIAN VERSION) -2006
01-F141	01-Y6881	R6S (CANADIAN VERSION) 2007-2009
01-R1041	01-Y6881	R6S (EUROPEAN VERSION) 2006-2007
01-F161	01-Y6881	FZ6 FAZER 2004-2010
01-F161	01-Y6881	FZ6R 2009-2015
01-F161	01-Y6881	MT-07/FZ-07 2014-2016
01-F161	01-Y6881	MT07 TRACER 2016-2019
01-F161	01-Y6881	XSR 700 2016-2019
01-F161	01-Y6881	FZ 8 2011-2015
01-F161	01-Y6881	MT-09/SR/FZ-9 2014-2015
01-F161	01-Y6881	MT09 TRACER 2015-2017
01-F161	01-Y6881	MT09 TRACER/GT/ABS 2018-2019
01-F161	01-S351	FJ-09 2015
01-F161	01-Y6951	TDM 900 2012-2014
01-F201	01-Y6881	YZF R1 1999-2001
01-F141	01-Y6881	YZF R1 2002-2003
01-R1041	01-Y6881	YZF R1 2004-2008
01-R191	01-Y6881	YZF R1 2009-2014
01-R151	01-Y6881	YZF R1 / R1M 2015
01-F141	01-Y6881	FZ1 FAZER 2001-2005
01-F161	01-Y6881	FZ1 FAZER 2006-2013
01-F141	01-C7771	FJR 1300 2003
01-F161	01-C7771	FJR 1300 2004-2015
01-F161	01-C7771	XJR 1300 2004-2015
01-R1041	01-C7771	MT-01 2004-2009
01-F161	01-Y6881	XJ6 DIVERSION 2009-2015
01-F161	01-C7771	SUPERTENERE/XT1200ZE 2012-2015

LEVE "OFF-ROAD" A RICAMBIO



LEVA FRIZIONE HONDA CR125R/CR250RT/V	FASCIA A
01-C0010 ALLUMINIO LUCIDO	€ 5,95



LEVA FRIZIONE HONDA CR250/CRF250/450	FASCIA A
01-C0020 ALLUMINIO LUCIDO	€ 6,40



LEVA FRIZIONE HONDA CRF250/450F 2007-2009	FASCIA A
01-C0030 ALLUMINIO LUCIDO	€ 6,80



LEVA FRIZIONE KAWASAKI KX	FASCIA A
01-C0040 ALLUMINIO LUCIDO	€ 5,65



LEVA FRIZIONE KAWASAKI KX 250 2005-2006	FASCIA A
01-C0050 ALLUMINIO LUCIDO	€ 6,50



LEVA FRIZIONE KTM 2 STROKE	FASCIA A
01-C0060 ALLUMINIO LUCIDO	€ 13,80



LEVA FRIZIONE KTM SX65 2002-2003	FASCIA A
01-C0070 ALLUMINIO LUCIDO	€ 13,90



FORGIATA

LEVA FRIZIONE KTM EXC 2T/450SX 2009	FASCIA A
01-C0080 ALLUMINIO LUCIDO	€ 38,15



LEVA FRIZIONE KTM 250EXC/300EXC 2006/2007	FASCIA A
01-C0090 ALLUMINIO LUCIDO	€ 15,60

LEVE "OFF-ROAD" A RICAMBIO



LEVA FRIZIONE SUZUKI RM125

FASCIA
A

01-C0100 ALLUMINIO LUCIDO

€ 5,80



LEVA FRIZIONE YAMAHA
YZ125/250/RM SUZUKI

FASCIA
A

01-C0110 ALLUMINIO LUCIDO

€ 5,80



LEVA FRIZIONE 2000 YAMAHA LUNGA

FASCIA
A

01-C0120 ALLUMINIO LUCIDO

€ 6,65



LEVA FRIZIONE YAMAHA YZ/WR
2001-2002

FASCIA
A

01-C0130 ALLUMINIO LUCIDO

€ 6,65



LEVA FRIZIONE YAMAHA
YZF250/450 2009

FASCIA
A

01-C0140 ALLUMINIO LUCIDO

€ 6,65



LEVA FRIZIONE YAMAHA WR250
2008-2009

FASCIA
A

01-C0150 ALLUMINIO LUCIDO

€ 6,45



LEVA FRIZIONE YAMAHA
WR450/250 2003

FASCIA
A

01-C0160 ALLUMINIO LUCIDO

€ 6,50



LEVA FRIZIONE KAWASAKI
KDX200 1983-2008

FASCIA
A

01-C0170 ALLUMINIO LUCIDO

€ 5,80



LEVA FRENO HON KAW
CR125/250/500 KX125/250 1993-1994

FASCIA
A

01-B0010 ALLUMINIO LUCIDO

€ 7,20

LEVE "OFF-ROAD" A RICAMBIO



LEVA FRENO HONDA
CRF250/450F 2007-2009

FASCIA
A

01-B0020 ALLUMINIO LUCIDO € 17,00



LEVA FRENO KAWASAKI KX125

FASCIA
A

01-B0030 ALLUMINIO LUCIDO € 7,15



LEVA FRENO KAWASAKI
XR125/250 1997

FASCIA
A

01-B0040 ALLUMINIO LUCIDO € 7,45



LEVA FRENO KAWASAKI
KX85/125/250 2000, YZ 2001

FASCIA
A

01-B0050 ALLUMINIO LUCIDO € 10,20



LEVA FRENO YAMAHA YZF250 2007

FASCIA
A

01-B0070 ALLUMINIO LUCIDO € 10,70



LEVA FRENO KTM CORTA

FASCIA
A

01-B0080 ALLUMINIO LUCIDO € 7,40



LEVA FRENO KTM 65/85 2004/2012

FASCIA
A

01-B0090 ALLUMINIO LUCIDO € 17,55



LEVA FRENO KTM

FASCIA
A

01-B0100 ALLUMINIO LUCIDO € 7,05



LEVA FRENO KTM
125/250/400 SX250 EXC 30/38

FASCIA
A

01-B0110 ALLUMINIO LUCIDO € 7,35

LEVE "OFF-ROAD" A RICAMBIO

FORGIATA



LEVA FRENO KTM SXF250/450 2014 FASCIA A
01-B0120 ALLUMINIO LUCIDO € 17,55



LEVA FRENO SUZUKI RM 1985-1995 FASCIA A
01-B0130 ALLUMINIO LUCIDO € 7,15



LEVA FRENO SUZUKI RM125 FASCIA A
01-B0141 ALLUMINIO NERO NEW € 8,30



LEVA FRENO YAMAHA YZ 1990-1995 FASCIA A
01-B0150 ALLUMINIO LUCIDO € 7,15



LEVA FRENO YAMAHA YZ125/250 1996 FASCIA A
01-B0160 ALLUMINIO LUCIDO € 7,15



LEVA FRENO YAMAHA WRF450 2012 FASCIA A
01-B0180 ALLUMINIO LUCIDO € 12,45



LEVA FRENO YAMAHA YZ85/125/250/450 FASCIA A
01-B0190 ALLUMINIO LUCIDO € 10,20



COLLARINO E LEVA RIBALTABILE C/HOT STARTER UNIVERSALE FASCIA C
01-0151 ALLUMINIO € 108,00

LEVE "OFF-ROAD" A RICAMBIO



BRACCIALE FRIZIONE HONDA CR

FASCIA
A

01-H0010

€ 11,00



BRACCIALE FRIZIONE HONDA CRF 150
4T CON LEVETTA DECOMPRESSORE

FASCIA
A

01-H0020

€ 38,00



BRACCIALE FRIZIONE HONDA
CR125-250 2004-2014, C/CUFFIA
PARAPOLVERE E REGISTRO RAPIDO

FASCIA
A

01-H0030

€ 28,00



BRACCIALE FRIZIONE 4T HONDA
CRF 250/450 CON LEVETTA
DECOMPRESSORE

FASCIA
A

01-H0040

€ 38,00



BRACCIALE FRIZIONE KAWASAKI
KX125/250

FASCIA
A

01-H0050 ALLUMINIO LUCIDO

€ 11,00



BRACCIALE FRIZIONE KAWASAKI
KX250 2005-2009 C/CUFFIA
PARAPOLVERE E REGISTRO RAPIDO

FASCIA
A

01-H0060 ALLUMINIO LUCIDO

€ 28,00



BRACCIALE FRIZIONE 4T KAWASAKI
KX250F 2005-2009
CON LEVETTA DECOMPRESSORE

FASCIA
A

01-H0070

€ 38,00



BRACCIALE FRIZIONE SUZUKI

FASCIA
A

01-H0080 ALLUMINIO LUCIDO

€ 11,00



BRACCIALE FRIZIONE SUZUKI

FASCIA
A

01-H0090 ALLUMINIO LUCIDO

€ 11,00

LEVE "OFF-ROAD" A RICAMBIO



BRACCIALE FRIZIONE 4T SUZUKI RMZ450 2005-2006
CON LEVETTA DECOMPRESSORE

01-H0100

FASCIA
A

€ 38,00



BRACCIALE FRIZIONE YZ E RM

01-H0110

ALLUMINIO LUCIDO

FASCIA
A

€ 11,00



BRACCIALE FRIZIONE YAMAHA YZ 2000-03

01-H0120

ALLUMINIO LUCIDO

FASCIA
A

€ 11,00



BRACCIALE FRIZIONE YAMAHA WRF250/450 2008-2009
CON LEVETTA DECOMPRESSORE

01-H0130

FASCIA
A

€ 38,00



BRACCIALE FRIZIONE YAMAHA YZF250/450 2009 CON LEVETTA
DECOMPRESSORE E CUFFIA PARAPOLVERE/REGISTRO RAPIDO

01-H0140

ALLUMINIO LUCIDO

FASCIA
A

€ 38,00



BRACCIALE FRIZIONE 4T KAWASAKI KX250F 2004
CON LEVETTA DECOMPRESSORE

01-H0150

ALLUMINIO LUCIDO

FASCIA
A

€ 11,00

APPLICATIVO LEVE "OFF-ROAD" A RICAMBIO

CILINDRATA	MODELLO	ANNO	LEVA FRIZIONE	LEVA FRENO	BRACCIALE FRIZIONE
HONDA					
80	CR	1996-1997	01-C0010	01-B0010	01-H0010
85	CR	2003-2007	01-C0010	01-B0010	01-H0010
125	CR	1992-2003	01-C0010	01-B0010	01-H0010
125	CR	2004-2014	01-C0020	01-B0010	01-H0030
150	CRF	2007-2018	01-C0010	01-B0010	01-H0020
250	CR	1992-2003	01-C0010	01-B0010	01-H0010
250	CR	2004-2014	01-C0020	01-B0010	01-H0030
450	CRF	2002-2003	01-C0010	01-B0010	01-H0020
450	CRF	2004-2006	01-C0020	01-B0010	01-H0040
500	CR	1992-2002	01-C0010	01-B0010	01-H0010
250R	CRF	2004-2006	01-C0020	01-B0010	01-H0040
250R	CRF	2007-2017	01-C0030	01-B0020	01-H0040
450R	CRF	2007-2018	01-C0030	01-B0020	01-H0040
KAWASAKI					
80	KX	1994-1996	01-C0170	01-B0030	01-H0050
80	KX	1997	01-C0170	01-B0040	01-H0050
80	KX	1998-2000	01-C0040	01-B0040	
85	KX	2001-2018	01-C0040	01-B0050	01-H0050
125	KX	1993-1996	01-C0040	01-B0030	01-H0050
125	KX	1997-1999	01-C0040	01-B0040	01-H0050
125	KX	2000-2005	01-C0040	01-B0050	01-H0050
125	KX	2006-2009	01-C0050	01-B0050	
250	KX	1993-1996	01-C0040	01-B0030	01-H0050
250	KX	1997-1999	01-C0040	01-B0040	01-H0050
250	KX	2000-2004	01-C0040	01-B0050	01-H0050
250	KX	2005-2009	01-C0050	01-B0050	01-H0050
250	KXF	2004	01-C0040	01-B0050	01-H0060
250	KXF	2005-2012	01-C0050	01-B0050	01-H0070
250	KXF	2013-2018	01-C0050	01-B0070	01-H0070
450	KXF	2006-2012	01-C0050	01-B0050	01-H0070
450	KXF	2013-2018	01-C0050	01-B0070	01-H0060
500	KX	1993-1996	01-C0040	01-B0030	01-H0050
500	KX	1997-1999	01-C0040	01-B0040	01-H0050
500	KX	2000-2008	01-C0040	01-B0050	01-H0050
KTM					
65	SX	2002-2003	01-C0070	01-B0080	
65	SX	2004-2011	01-C0060	01-B0090	
65	SX	2012-2013	01-C0060		
85	SX	2004-2012	01-C0060	01-B0090	
125	EXC	1998-1999	01-C0070	01-B0100	
125	EXC	2000-2003	01-C0070	01-B0080	
125	EXC	2004	01-C0060	01-B0080	
125	EXC	2005-2008	01-C0060	01-B0110	
125	SX	1998-1999	01-C0070	01-B0100	
125	SX	2000-2003	01-C0070	01-B0080	
125	SX	2004	01-C0060	01-B0080	
125	SX	2005-2008	01-C0060	01-B0110	

APPLICATIVO LEVE "OFF-ROAD" A RICAMBIO

CILINDRATA	MODELLO	ANNO	LEVA FRIZIONE	LEVA FRENO	BRACCIALE FRIZIONE
125	SX	2009-2013	01-C0080	01-B0110	
125	SX	2014-2018	01-C0080	01-B0120	
144	SX	2008	01-C0060	01-B0110	
150	SX	2009-2013	01-C0080	01-B0110	
150	SX	2014-2018	01-C0080	01-B0120	
200	EXC	2005-2008	01-C0060	01-B0110	
250	EXC	2000-2002	01-C0070	01-B0080	
250	EXC	2003-2004	01-C0060	01-B0080	
250	EXC	2005	01-C0060	01-B0110	
250	EXC	2006-2008	01-C0090	01-B0110	
250	EXC	2009-2018	01-C0090	01-B0110	
250	EXC-F	2006-2018	01-C0090	01-B0110	
250	SX	2000-2002	01-C0070	01-B0080	
250	SX	2003-2004	01-C0060	01-B0080	
250	SX	2005	01-C0060	01-B0110	
250	SX	2006-2008	01-C0090	01-B0110	
250	SX	2009-2013	01-C0090	01-B0110	
250	SX	2014-2018	01-C0090	01-B0120	
250	SX-F	2006	01-C0060	01-B0110	
250	SX-F	2007-2013	01-C0090	01-B0110	
250	SX-F	2014-2018	01-C0090	01-B0120	
300	EXC	2005	01-C0060	01-B0110	
300	EXC	2006-2018	01-C0090	01-B0110	
350	EXC-F	2012-2018	01-C0090	01-B0110	
350	SX-F	2011-2013	01-C0090	01-B0110	
350	SX-F	2014-2018	01-C0090	01-B0120	
380	EXC	2000-2002	01-C0070	01-B0080	
450	EXC-F	2003-2004	01-C0060	01-B0080	
450	EXC-F	2005-2007	01-C0060	01-B0110	
450	EXC-F	2008-2013	01-C0090	01-B0110	
450	SX-F	2003-2004	01-C0060	01-B0080	
450	SX-F	2005-2008	01-C0060	01-B0110	
450	SX-F	2009-2013	01-C0080	01-B0110	
450	SX-F	2014-2018	01-C0090	01-B0120	
520	EXC-F	2000-2002	01-C0070	01-B0080	
520	SX-F	2000-2002	01-C0070	01-B0080	
525	EXC-F	2003-2004	01-C0060	01-B0080	
525	EXC-F	2005-2007	01-C0060	01-B0110	
525	SX-F	2003-2004	01-C0060	01-B0080	
530	EXC-F	2008-2013	01-C0090	01-B0110	
SUZUKI					
125	RM	1987-1995	01-C0100	01-B0130	01-H0080
125	RM	1996-2003	01-C0100	01-B0140	01-H0080
125	RM	2004-2009	01-C0100	01-B0050	01-H0090
250	RM	1987-1995	01-C0100	01-B0130	01-H0080
250	RM	1996-2003	01-C0100	01-B0140	01-H0080
250	RM	2004-2009	01-C0100	01-B0050	01-H0090
250	RMZ	2004	01-C0040	01-B0050	01-H0150

APPLICATIVO LEVE "OFF-ROAD" A RICAMBIO

CILINDRATA	MODELLO	ANNO	LEVA FRIZIONE	LEVA FRENO	BRACCIALE FRIZIONE
250	RMZ	2005-2006	01-C0050	01-B0050	01-H0070
250	RMZ	2007-2017	01-C0040	01-B0050	01-H0100
450	RMZ	2005-2017	01-C0040	01-B0050	01-H0100
YAMAHA					
85	YZ	2002-2014	01-C0110	01-B0190	01-H0110
85	YZ	2015-2018	01-C0140	01-B0070	
125	YZ	1992-1995	01-C0110	01-B0150	01-H0110
125	YZ	1996-1999	01-C0110	01-B0160	01-H0110
125	YZ	2000	01-C0120	01-B0160	01-H0120
125	YZ	2001-2007	01-C0120	01-B0190	01-H0120
125	YZ	2008-2014	01-C0120	01-B0070	01-H0120
125	YZ	2015-2018	01-C0140	01-B0070	
250	WRF	2003-2006	01-C0160	01-B0190	
250	WRF	2007	01-C0120	01-B0190	01-H0130
250	WRF	2008-2018	01-C0150	01-B0190	01-H0130
250	YZ	1992-1995	01-C0110	01-B0150	01-H0110
250	YZ	1996-1999	01-C0110	01-B0160	01-H0110
250	YZ	2000	01-C0120	01-B0160	01-H0120
250	YZ	2001-2007	01-C0120	01-B0190	01-H0120
250	YZ	2008-2014	01-C0120	01-B0070	01-H0120
250	YZF	2001-2006	01-C0120	01-B0190	01-H0120
250	YZF	2007-2008	01-C0120	01-B0070	01-H0120
250	YZF	2009-2018	01-C0140	01-B0070	01-H0140
400	WRF	1998-1999	01-C0110	01-B0160	01-H0110
400	YZF	1998-1999	01-C0110	01-B0160	01-H0110
426	WRF	2000-2002	01-C0110	01-B0160	01-H0120
426	YZF	2000-2002	01-C0110	01-B0160	01-H0120
450	WRF	2003-2006	01-C0160	01-B0190	
450	WRF	2008-2011	01-C0150	01-B0190	01-H0130
450	WRF	2012-2018	01-C0150	01-B0180	01-H0130
450	YZF	2003-2007	01-C0120	01-B0190	01-H0120
450	YZF	2008	01-C0120	01-B0070	01-H0120
450	YZF	2009-2018	01-C0140	01-B0070	01-H0140



AIUTO COMANDO GAS

00-0060

FASCIA
A

€ 7,50



CP.MANOPOLE "CROSS" L.115 mm

FASCIA
A

09-0081	NERO	€ 5,50
09-0083	BLU	€ 5,50
09-0084	ROSSO	€ 5,50
09-0088	VERDE	€ 5,50



CP.MANOPOLE SPORT L.115 mm

09-0101 NERO

FASCIA
A

€ 5,50



CP.MANOPOLE OFF-ROAD "GUM"

FASCIA
A

09-0131	NERO-GRIGIO	€ 9,60
09-0134	ROSSO-GRIGIO	€ 9,60
09-0135	GIALLO-GRIGIO	€ 9,60
09-0137	ARANCIO-GRIGIO	€ 9,60
09-0138	VERDE-GRIGIO	€ 9,60

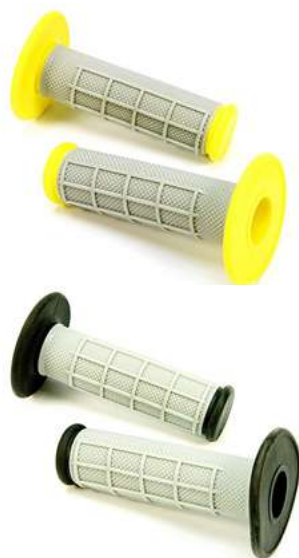

DAYTONA



CP.MANOPOLE GRIPPY GRIP
GGD-BASE

FASCIA
E

88217	NERO, FINALE APERTO	€ 12,25
88218	GRIGIO, FINALE APERTO	€ 12,25
88219	MARRONE, FINALE APERTO	€ 12,25



CP.MANOPOLE GRIPPY GRIP - GGD-NAMI

88561	NERO, FINALE APERTO	€ 12,25
88562	MARRONE, FINALE APERTO	€ 12,25
88563	ROSSO SCURO, FINALE APERTO	€ 12,25



FASCIA
E



CP.MANOPOLE GRIPPY GRIP - GGD-DELTA

	FASCIA E
88565 NERO, FINALE APERTO	€ 12,25
88566 MARRONE, FINALE APERTO	€ 12,25
88567 ROSSO SCURO, FINALE APERTO	€ 12,25
88568 TIPO GOMMA, FINALE APERTO	€ 12,25



CP.MANOPOLE GRIPPY GRIP - GGD-AMI

	FASCIA E
88569 NERO, FINALE APERTO	€ 12,25
88570 MARRONE, FINALE APERTO	€ 12,25
88571 ROSSO SCURO, FINALE APERTO	€ 12,25
88613 GRIGIO, FINALE APERTO	€ 12,25
88614 BLU SCURO, FINALE APERTO	€ 12,25
88615 VERDE SCURO, FINALE APERTO	€ 12,25





CP.MANOPOLE GRIPPY GRIP GGD-KATANA

		FASCIA E
88573	ROSSO, FINALE APERTO	€ 14,71
88574	BLU, FINALE APERTO	€ 14,71
88575	VERDE, FINALE APERTO	€ 14,71
88576	GRIGIO, FINALE APERTO	€ 14,71
88579	BIANCO, FINALE APERTO	€ 14,71



CP.MANOPOLE GRIPPY GRIP - GGD-NINJA

		FASCIA E
88663	NERO, FINALE APERTO	€ 12,25
88664	GRIGIO, FINALE APERTO	€ 12,25
88665	MARRONE, FINALE APERTO	€ 12,25
88666	ROSSO SCURO, FINALE APERTO	€ 12,25



CP.MANOPOLE GRIPPY GRIP GGD-LINE

		FASCIA E
88658	ROSSO, FINALE APERTO	€ 14,71
88659	BLU, FINALE APERTO	€ 14,71
88660	VERDE, FINALE APERTO	€ 14,71
88661	GIALLO, FINALE APERTO	€ 14,71
88769	GRIGIO, FINALE APERTO	€ 14,71



DAYTONA

CP.MANOPOLE GRIPPY GRIP
GGDI-ARC I - NERO, FINALE CHIUSO

FASCIA
E

88667 MANUBRI 25,4mm € 12,25



DAYTONA

CP.MANOPOLE GRIPPY GRIP
GGDI-OCTA - NERO, FINALE CHIUSO

FASCIA
E

88674 MANUBRI 25,4mm € 12,25



DAYTONA

CP.MANOPOLE GRIPPY GRIP
GGDI-ARC III - NERO, FINALE CHIUSO

FASCIA
E

88675 MANUBRI 25,4mm € 12,25



DAYTONA

CP.MANOPOLE GRIPPY GRIP GGD-CELL

FASCIA
E

88669 ROSSO, FINALE APERTO

€ 14,71

88670 BLU, FINALE APERTO

€ 14,71

88671 VERDE, FINALE APERTO

€ 14,71

88672 GRIGIO, FINALE APERTO

€ 14,71

88673 VERDE SCURO, FINALE APERTO

€ 14,71





DAYTONA



CP.MANOPOLE GRIPPY GRIP GGD-KANI

		FASCIA E
88937	NERO, FINALE APERTO	€ 12,25
88938	GRIGIO, FINALE APERTO	€ 12,25
88939	MARRONE, FINALE APERTO	€ 12,25
88940	CARAMELLO, FINALE APERTO	€ 12,25
88941	BIANCO, FINALE APERTO	€ 12,25



DAYTONA



CP.MANOPOLE GRIPPY GRIP GGD-SAKURA

		FASCIA E
88942	NERO, FINALE APERTO	€ 12,25
88943	GRIGIO, FINALE APERTO	€ 12,25
88944	CARAMELLO, FINALE APERTO	€ 12,25
88945	ROSA, FINALE APERTO	€ 12,25
88946	BIANCO, FINALE APERTO	€ 12,25



MANOPOLE RISCALDATE



KIT MANOPOLE RISCALDATE MOTO MANUBRI 22,2mm TERMINALE APERTO/CONTROLLO MECC. - CON SPIE

FASCIA
E

88640

€ 81,97



86607
87408



86610



87407



87478
88462



88019



88020

KIT MANOPOLE RISCALDATE MOTO

FASCIA
E

86607	MANUBRI 22,2MM TERMINALE CHIUSO/CONTROLLO ELETTRICO	€ 57,34
86608	ATV TERMINALE CHIUSO/CONTROLLO ELETTRICO	€ 57,34
86610	CUSTOM - MANUBRI 25,4MM - TERMINALE CHIUSO/CONTROLLO ELETTRICO	€ 57,34
87407	MANUBRI 22,2MM TERMINALE APERTO/CONTROLLO MECC. - CON INTERRUTTORE	€ 73,73
87478	MANUBRI 22,2MM TERMINALE APERTO/CONTROLLO ELETTRICO	€ 57,34
88019	MANUBRI 25,4MM TERMINALE CHIUSO/CONTROLLO MECC. - CON INTERRUTTORE	€ 73,73
88020	HARLEY DAVIDSON (96UP, 08UP) TERMINALE CHIUSO/CONTROLLO MECC. - CON INTERRUTTORE	€ 73,73
88462	ATV TERMINALE APERTO/CONTROLLO ELETTRICO	€ 57,34



CP.STABILIZZATORI MANUBRIO LISCIO ALLUMINIO 17 mm

FASCIA
A

12-0020	LUCIDI	€ 7,00
12-0021	NERO	€ 7,00
12-0023	BLU	€ 7,00
12-0024	ROSSO	€ 7,00
12-0025	ORO	€ 7,00
12-0029	CARBON	€ 8,00



CP.STABILIZZATORI MANUBRIO ZIGRINATI ALLUMINIO 17 mm

FASCIA
A

12-0050	LUCIDI	€ 7,00
12-0051	NERO	€ 7,00
12-0053	BLU	€ 7,00
12-0054	ROSSO	€ 7,00
12-0055	ORO	€ 7,00
12-0059	CARBON	€ 8,00



CP.STABILIZZATORI MANUBRIO ZIGRINATI ALLUMINIO 13 mm

FASCIA
A

12-0060	LUCIDI	€ 7,00
12-0061	NERO	€ 7,00
12-0063	BLU	€ 7,00
12-0064	ROSSO	€ 7,00
12-0065	ORO	€ 7,00
12-0069	CARBON	€ 8,00



DAYTONA



CP.STABILIZZATORI FINALI MANUBRIO ANODIZZATI "TKM-2"

	FASCIA E
87331 NERO-ROSSO	€ 49,14
87332 NERO-BLU	€ 49,14
87333 NERO-ORO	€ 49,14
87334 NERO-VERDE	€ 49,14
87335 NERO-SILVER	€ 49,14
87336 NERO-NERO	€ 49,14



DAYTONA



CP.STABILIZZATORI MANUBRIO CNC "CANARD"

	FASCIA E
99914 ROSSO	NEW € 28,65
99915 BLU	NEW € 28,65
99916 CHAMPAGNE	NEW € 28,65
99917 VERDE	NEW € 28,65
99918 ARGENTO	NEW € 28,65
99919 NERO	NEW € 28,65



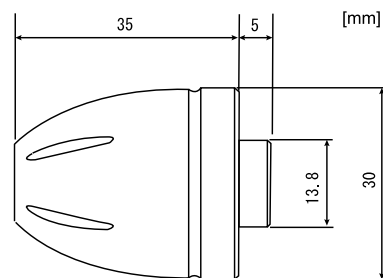

CP.STABILIZZATORI MANUBRIO CNC "BULLET"

		FASCIA E
98369	ROSSO	NEW € 20,45
98370	BLU	NEW € 20,45
98371	ORO	NEW € 20,45
98372	VERDE	NEW € 20,45
98373	ARGENTO	NEW € 20,45
98374	NERO	NEW € 20,45



CP.STABILIZZATORI MANUBRIO - CNC "AERO"

		FASCIA E
99920	ROSSO	NEW € 28,65
99921	BLU	NEW € 28,65
99922	CHAMPAGNE	NEW € 28,65
99923	VERDE	NEW € 28,65
99924	ARGENTO	NEW € 28,65
99925	NERO	NEW € 28,65

E-MARKED



SPECCHIETTO "D-MIRROR-2"

		FASCIA E
88610	NERO, LATO SINISTRO	€ 57,34
88611	NERO, LATO DESTRO	€ 57,34
88968	CROMATO, LATO DESTRO	€ 57,34
88969	CROMATO, LATO SINISTRO	€ 57,34

E-MARKED

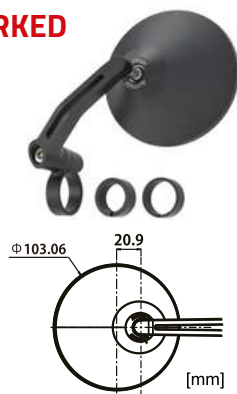

89428



89474



89430

SPECCHIETTO BAR-END A MANUBRIO IN ALLUMINIO "D-MIRROR"

		FASCIA E
89428		NEW € 53,24
89430		NEW € 53,24
89474		NEW € 53,24

E-MARKED



DAYTONA

SPECCHIETTO "D-MIRROR-1"

		FASCIA E
88979	NERO, LATO DESTRO	€ 57,34
88980	NERO, LATO SINISTRO	€ 57,34
88981	CROMATO, LATO DESTRO	€ 57,34
88982	CROMATO, LATO SINISTRO	€ 57,34

E-MARKED



SPECCHIETTO IN ALLUMINIO ROD

	FASCIA E
89429	NEW € 53,24
89431	NEW € 53,24
89475	NEW € 53,24



SUPPORTO SPECCHIO A MANUBRIO ALLUMINIO FILETTO 10 mm

	FASCIA A
05-0080 CROMATO	€ 7,50
05-0081 NERO	€ 7,50

ESTENSIONE PER SPECCHIETTO RETROVISORE 10 mm

	FASCIA C
05-0181 SX, NERO	€ 13,00
05-0191 DX, NERO	€ 13,00

BRACIALETTA PORTA SPECCHIO A MANUBRIO, AVANZATO FILETTO 10 mm

	FASCIA C
05-0200 CROMATO	€ 14,50
05-0201 NERO	€ 14,50



89440



89441



89442



89443



89444

ADATTATORI SPECCHIETTI BAR-END A MANUBRIO

	FASCIA E
89440 UNIVERSALI	€ 16,35
89441 YAMAHA 1	€ 16,35
89442 YAMAHA 2	€ 16,35
89443 SUZUKI	€ 16,35
89444 KAWASAKI	€ 16,35



INTERRUTTORE SPEGNIMENTO
MOTORE KAWASAKI CROSS

13-0010

FASCIA
A

€ 16,00



INTERRUTTORE SPEGNIMENTO
MOTORE YAMAHA CROSS/ENDURO

13-0020

FASCIA
A

€ 12,50



INTERRUTTORE A MANUBRIO
UNIVERSALE ON-OFF

13-0030

FASCIA
A

€ 19,00



INTERRUTTORE A MANUBRIO
UNIVERSALE ACCENSIONE LUCI
SUPPLEMENTARI

13-0040

FASCIA
A

€ 19,00



INTERRUTTORE A MANUBRIO
UNIVERSALE RUN / OFF
+ AVVIAMENTO MOTORE

13-0050

FASCIA
A

€ 22,00



INTERRUTTORE DI SICUREZZA A
STRAPPO FISSAGGIO A MANUBRIO

13-0060

FASCIA
C

€ 17,50



INTERRUTTORE DI SICUREZZA A
STRAPPO FISSAGGIO A TELAIO

13-0070

FASCIA
C

€ 17,50



ADATTATORE DOPPIA PRESA USB
PER PRESA 12V FORO PICCOLO
(ATTACCO DIRETTO BMW)

13-0110

FASCIA
C

€ 14,90



INTERRUTTORE SPEGNIMENTO
SUZUKI CROSS

13-0120

FASCIA
A

€ 13,80



PRESA 5V/2A DOPPIA PORTA USB, A MANUBRIO, IMPERMEABILE, CAVO 120 cm FASCIA C
13-0180 € 24,50



INTERRUTTORE A MANUBRIO UNIV. ACCENSIONE LUCI, INDICATORI DIREZIONE, CLACSON FASCIA C
13-0190 € 39,90



CONTAORE MOTORE ELETTRONICO RESETTABILE - WIRELESS FASCIA C
13-0210 € 29,90



INTERRUTTORE A MANUBRIO AVVIAMENTO TIPO HONDA CRF250/450 FASCIA A
13-0220 **NEW** € 15,00



STRUMENTO COMPATTO INDICATORI LED MOD.BETA, ALLUM.CNC FASCIA E

87467	NERO	€ 57,34
87468	CROMATO	€ 57,34
87624	ARGENTO	€ 57,34



DAYTONA

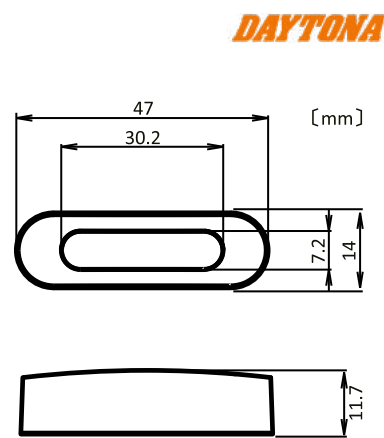

STRUMENTO COMPATTO INDICATORI LED MOD.ALPHA, ALLUM.CNC FASCIA E

86531	NERO	€ 53,24
86532	CROMATO	€ 53,24

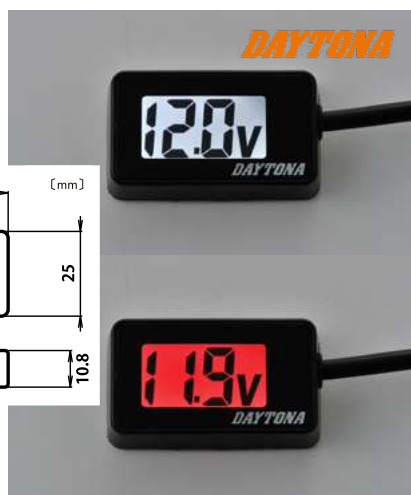
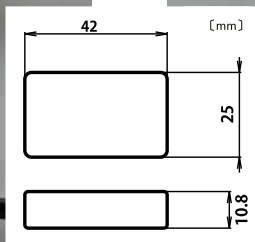

STRUMENTO COMPATTO RILEVAMENTO TEMPERATURA OLIO -9°C - 150°C FASCIA E
89278 **NEW** € 36,89

VOLTMETRO COMPATTO 7.5 - 18 V FASCIA E
89279 **NEW** € 32,75

RETTIFICATORE DI IMPULSO SEGNALE RPM FASCIA E
92333 € 44,22



SUPPORTO SMARTPHONE CON CUSTODIA FASCIA E
94805 TG.XL - TIPO FISSO CON MONTAGGIO A VITE € 49,14
94806 TG.XL - TIPO REMOVIBILE CON SGANCIO RAPIDO € 49,14
94944 TG.M - TIPO FISSO CON MONTAGGIO A VITE € 49,14
94945 TG.M - TIPO REMOVIBILE CON SGANCIO RAPIDO € 49,14

FASCIA E
€ 49,14
€ 49,14
€ 49,14
€ 49,14



SUPPORTO SMARTPHONE TIPO FISSO CON MONTAGGIO A VITE FASCIA E
87963 € 45,04

SUPPORTO SMARTPHONE - TIPO REMOVIBILE CON SGANCIO RAPIDO FASCIA E
87964 € 45,04

INTERRUTTORE UNIVERSALE CNC PER STRUMENTI SERIE VELONA FASCIA E
87047 NERO € 40,94
87082 CROMATO € 40,94



KIT PRESA USB A MANUBRIO

		FASCIA E
87237	1 PORTA	€ 28,65
87238	2 PORTE	€ 32,75
87239	1 PORTA CON ACCENDISIGARO	€ 30,29
87406	2 PORTE CON ACCENDISIGARO	€ 36,84
99502	1 PORTA - CONNESSIONE ACC	€ 29,47
99503	2 PORTE - CONNESSIONE ACC	€ 36,84

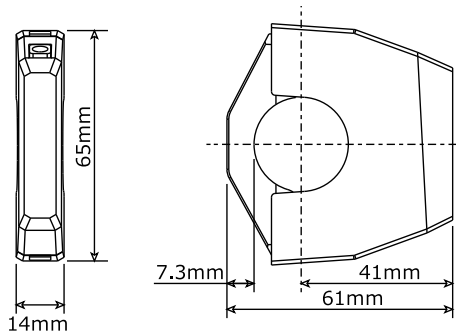

		FASCIA E
89371	KIT PRESA USB A MANUBRIO SOTTILE, 1 PORTA	NEW € 32,79

		FASCIA E
89372	KIT PRESA USB A MANUBRIO SOTTILE, 2 PORTE	NEW € 40,98



CONVERTITORE SEGNALE VELOCITÀ

		FASCIA E
87041	INSERTO DIAM.18, 1280 mm	€ 38,48
87143	G2 - INSERTO DIAM.15, 1800 mm	€ 36,84
87429	A2 - INSERTO DIAM.12, 1200 mm	€ 38,48
87430	DA MECCANICO A ELETTRICO, 650 mm	€ 40,94
87755	INSERTO DIAM.10	€ 44,22
88457	PER BMW	€ 46,68



FILO SPIRALE AD INDUZIONE PER CAVO CANDELA + FILO COLLEGAMENTO A BOBINA

	FASCIA E
87170	€ 8,16



KIT SENSORE DI VELOCITÀ E SUPPORTO, PROXIMITY TYPE

	FASCIA E
87038	€ 28,65



BARRA MULTIFUNZIONE + PRESA USB

		FASCIA E
93380	SU POMPA FRENO MANUBRIO - LUNGHEZZA 100 mm	€ 57,34
93381	SU RISER MANUBRIO - LUNGHEZZA 100 mm	€ 57,34
93382	SU STELO - LUNGHEZZA 100 mm	€ 57,34
93385	SU POMPA FRENO MANUBRIO - LUNGHEZZA 155 mm	€ 57,34
93386	SU RISER MANUBRIO- LUNGHEZZA 155 mm	€ 57,34
93387	SU STELO- LUNGHEZZA 155 mm	€ 57,34



INTERRUTTORE ON-OFF

		FASCIA E
88158	A BILANCIERE "SLIM SWITCH" TASTI TONDI, IN NYLON	€ 36,84
88159	A BILANCIERE "SLIM SWITCH", IN NYLON	€ 36,84
88160	LEVETTA PIATTA "SLIM SWITCH", IN NYLON	€ 36,84
88161	LEVETTA CILINDRICA "SLIM SWITCH", IN NYLON	€ 36,84
88162	A BILANCIERE PER FANALE H4	€ 49,14

OMOLOGATO



CATADIOTTO POSTERIORE
RETTANGOLARE PER PORTATARGA
9x3,2 cm

00-0334

FASCIA
A

€ 2,50



CP.STAFFE A FORCELLA PER FANALE
TIPO ECONOMICO

- 00-0210 CROMATO
- 00-0211 NERO
- 00-0219 CARBON

FASCIA
A

€ 15,00
€ 15,00
€ 17,00



FANALE ANTERIORE UNIVERSALE
CROMATO DIAM. 200

- 02-0390 CROMATO
- 02-0391 NERO

FASCIA
A

€ 89,00
€ 89,00



FANALINO POSTERIORE A LED
UNIVERSALE TRASPARENTE "MACAO"
LUCE TARGA INTEGRATA

02-0320

FASCIA
A

€ 25,90



FANALINO POSTERIORE TRASPARENTE
A LED UNIVERSALE "DAYTONA"

02-0270

FASCIA
A

€ 15,00



LUCE TARGA A LED RIVESTIMENTO
IN PLASTICA

02-0591

FASCIA
A

€ 9,90



LUCE TARGA LED BIANCA "ANT"

02-0030

FASCIA
A

€ 12,50



RELAY CON CONNETTORE 0.1-100W /
DC12V PER LUCI POSIZIONE / DIREZIONE

89460

FASCIA
E

NEW € 32,75

E-MARKED DAYTONA



LUCE TARGA UNIVERSALE IN ABS
M4XP0.7

88857

FASCIA
E

€ 16,35

OMOLOGATO



PORTATARGA OFF ROAD C/FANALINO A LED, "VYPER"	FASCIA A
02-0310	€ 26,00

PORTATARGA OFF-ROAD C/FANALINO A LED, FRECCHE INTEGRATE "PYTHON"	FASCIA C
02-0731	€ 33,00

KIT 2PZ. SUPPORTO PER FARETTO A LED	FASCIA E
02-0761	DIAMETRO 22-26 mm € 18,00
02-0771	DIAMETRO 26-35 mm € 18,00

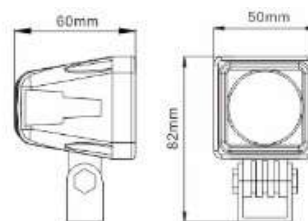

KIT 2PZ. FARETTO LED + CABLAGGIO

02-0741	PROFONDITÀ NERO
02-0751	ANTINEBBIA NERO

FASCIA E

€ 89,00
€ 89,00



CP.STAFFE A FORCELLA PER FANALE

		FASCIA E
86941	DIA.39 mm, ACCIAIO NERO	€ 81,93
86942	DIA.41 mm, ACCIAIO NERO	€ 81,93
86909	DIA.39 mm, INOX LUCIDO	€ 81,93
86910	DIA.41 mm, INOX LUCIDO	€ 81,93
86981	DIA.35 mm, ACCIAIO NERO	€ 81,93

CP.STAFFE SUPPORTO FANALI IN CNC

		FASCIA E
88617	DIAM.35MM LUNGA 101,5 mm	€ 90,12
88618	DIAM.39MM LUNGA 101,5 mm	€ 90,12
88619	DIAM.41MM LUNGA 101,5 mm	€ 90,12
88620	DIAM.43MM LUNGA 101,5 mm	€ 90,12
88621	DIAM.49MM LUNGA 101,5 mm	€ 90,12
88622	DIAM.35MM LUNGA 55 mm	€ 90,12
88623	DIAM.39MM LUNGA 55 mm	€ 90,12
88624	DIAM.41MM LUNGA 55 mm	€ 90,12
88625	DIAM.43MM LUNGA 55 mm	€ 90,12
88626	DIAM.49MM LUNGA 55 mm	€ 90,12

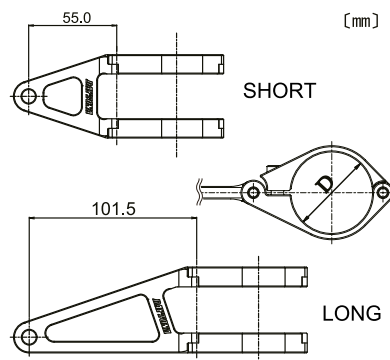

FANALE ANTERIORE OLD STYLE
LED "NEO VINTAGE", 5-3/4"

		FASCIA E
88431	NERO	€ 245,86
88432	CROMATO	€ 245,86



DAYTONA
E-MARKED

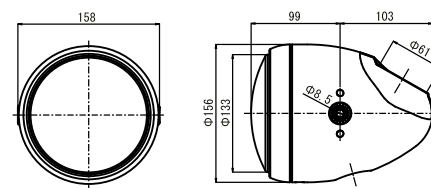

FANALE ANTERIORE OLD STYLE "VINTAGE"

FASCIA
E

86903	NERO, DESTRO	€ 163,89
86904	CROMATO, DESTRO	€ 163,89
86906	NERO, SINISTRO	€ 163,89
86907	CROMATO, SINISTRO	€ 163,89
87357	NERO, CORNICE NERA, DESTRO	€ 163,89
87800	NERO, CORNICE NERA, SINISTRO	€ 163,89



DAYTONA
E-MARKED

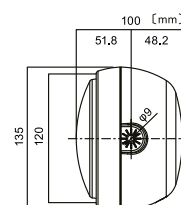

MONTAGGIO
LATERALE

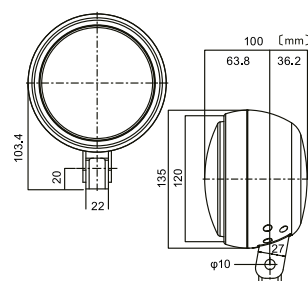

MONTAGGIO
INFERIORE

FANALE ANTERIORE A LED
"CAPSULE120"

FASCIA
E

88633	MONTAGGIO LATERALE, NERO	NEW	€ 245,86
88634	MONTAGGIO LATERALE, CROMATO	NEW	€ 245,86
88635	MONTAGGIO INFERIORE, NERO	NEW	€ 245,86
88636	MONTAGGIO INFERIORE, CROMATO	NEW	€ 245,86



OMOLOGATE

CP.MINI FRECCE A LAMPADINA "DOUBLE ARROW"	FASCIA A
03-0021 NERO	€ 19,80
03-0029 CARBON	€ 19,80
03-0031 NERO GAMBO LUNGO	€ 20,40
03-0039 CARBON GAMBO LUNGO	€ 20,40



OMOLOGATE

CP.MINI FRECCE A LAMPADINA "FUEGO" DOPPIA LENTE	FASCIA A
03-0081 NERO	€ 19,80
03-0089 CARBON	€ 19,80
03-0091 NERO GAMBO LUNGO	€ 20,40
03-0099 CARBON GAMBO LUNGO	€ 20,40



OMOLOGATE
PREZZO RIBASSATO

CP.MINI FRECCE A LED "MICROPIP"	FASCIA A
03-0150 ALLUMINIO	€ 28,00
03-0151 NERO	€ 28,00



OMOLOGATE

CP.FRECCE A LED "DIRK" CON LUCE, LENTE CHIARA	FASCIA C
03-0211 POSIZIONE ANTERIORE	€ 45,00
03-0221 TARGA POSTERIORE	€ 45,00



OMOLOGATE
PREZZO RIBASSATO

CP.FRECCE A LED "VISION" UNIVERSALI	FASCIA C
03-0231	€ 30,00

OMOLOGATE



CP.MINI FRECCHE A LED		FASCIA A
03-0251	"PILL" VETRO FUMÈ	NEW € 30,00

OMOLOGATE
LUCE SEQUENZIALE



CP.MINI FRECCHE A LED		FASCIA A
03-0261	"RUNNER"	NEW € 42,00

OMOLOGATE



CP.MINI FRECCHE A LED		FASCIA A
03-0271	"SIOUX" TRE FUNZIONI FRECCIA - STOP - POSIZIONE	NEW € 38,00

E-MARKED



86681
86682



89232



86683
86684

DAYTONA

CP.INDICATORI DIREZIONE ALLUM. LED "D-LIGHT"

CP.INDICATORI DIREZIONE ALLUM. LED "D-LIGHT"		FASCIA E
86681	CORPO CROMATO, LENTE CHIARA	€ 73,73
86682	CORPO CROMATO, LENTE FUMÉ	€ 73,73
86683	CORPO SILVER, LENTE CHIARA	€ 73,73
86684	CORPO SILVER, LENTE FUMÉ	€ 73,73
89232	CORPO NERO, LENTE FUMÉ	NEW € 81,97

E-MARKED
LUCE SEQUENZIALE



DAYTONA
[mm]

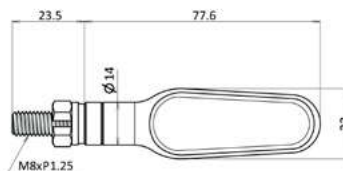

CP.INDICATORI DIREZIONE ALLUM.LED "STELLAR" LUCE SEQUENZIALE, CORPO NERO

88266

FASCIA E

€ 114,71

E-MARKED
LUCE
SEQUENZIALE



CP.INDICATORI DIREZIONE ALLUMINIO LED "RAY" LUCE SEQUENZIALE, ANTERIORE/POSTERIORE

FASCIA
E

89273

NEW € 114,71

E-MARKED

DAYTONA



CP.INDICATORI DI DIREZIONE IN ALLUMINIO D-LIGHT SOL-W, INDICATORE E FRENO/TARGA POSTERIORE - LENTE ARANCIO

FASCIA
E

89274 LENTE ARANCIO

NEW € 106,52

89275 LENTE FUMÈ

NEW € 106,52

E-MARKED

DAYTONA



CP.INDICATORI DI DIREZIONE IN ALLUMINIO D-LIGHT SOL

FASCIA
E

88703 LENTE ARANCIO

€ 90,12

88731 LENTE FUMÈ

€ 90,12



ADATTATORI MINIFRECCHE

00-0080 UNIVERSALI

FASCIA
A

€ 5,90



ADATTATORI MINIFRECCHE

00-0090 HONDA

FASCIA
A

€ 6,50

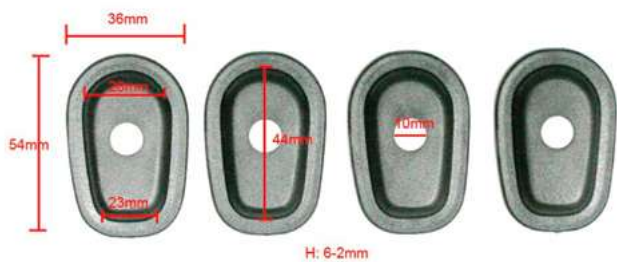

ADATTATORI MINIFRECCHE

00-0100 KAWASAKI

FASCIA
A

€ 6,50

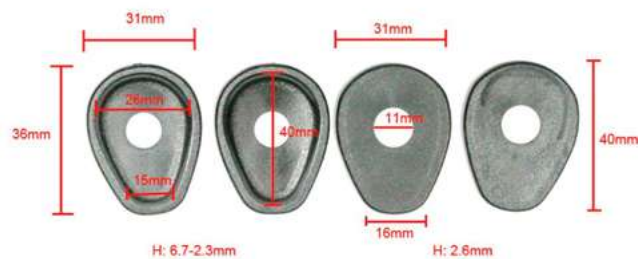

ADATTATORI MINIFRECCHE

00-0110 SUZUKI

FASCIA
A

€ 6,50

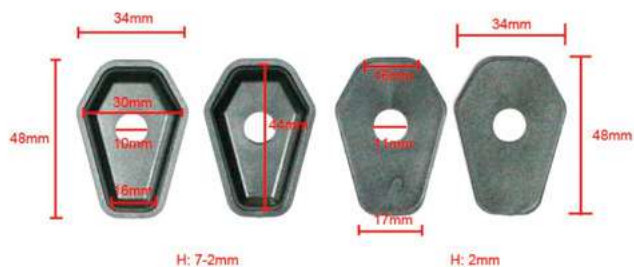

ADATTATORI MINIFRECCHE

00-0120 SUZUKI

FASCIA
A

€ 6,50



ADATTATORI MINIFRECCHE

00-0130 YAMAHA

FASCIA
A

€ 6,50



ADATTATORI MINIFRECCHE

FASCIA
A

00-0140 YAMAHA

€ 6,50

ADATTATORI MINIFRECCHE

FASCIA
A

00-0160 HONDA NEW MODEL

€ 6,50



03-0180

03-0190



03-0160

03-0170

KIT 2 PZ.CONNETTORI DEDICATI PER MINIFRECCHE

FASCIA
A

03-0180 HONDA-KAWASAKI

€ 7,90

03-0190 HONDA

€ 7,90

KIT 2 PZ.CONNETTORI DEDICATI PER MINIFRECCHE

FASCIA
A

03-0160 SUZUKI

€ 7,90

03-0170 YAMAHA

€ 7,90



ADATTATORE PER INTERMITTENZA
MINI FRECCHE A LED

FASCIA
A

04-0040

€ 15,00



KIT 2 PZ.RESISTENZA IN ALLUMINIO
MINIFRECCHE LED 8.2 OHM

FASCIA
A

04-0060

€ 12,50



RELAY CON CONNETTORE CONVERTIBILE
0.1-100W / DC12V PER MINIFRECCHE A
LAMPADINA O LED

FASCIA
E

88985

€ 16,35



ADATTATORI COLLARI M10

FASCIA
E

86994

€ 7,38



CNC

DAYTONA

ADATTATORI MINIFRECCHE

FASCIA
E

97235 KAWASAKI

€ 16,35



CNC

DAYTONA

ADATTATORI MINIFRECCHE

FASCIA
E

97238 HONDA

€ 16,35



CNC

DAYTONA

ADATTATORI MINIFRECCHE

FASCIA
E

97398 SUZUKI

€ 16,35



CNC

DAYTONA

ADATTATORI MINIFRECCHE

FASCIA
E

97399 SUZUKI

€ 16,35



CNC

DAYTONA

ADATTATORI MINIFRECCHE

FASCIA
E

97420 YAMAHA, KAWASAKI

€ 16,35







FORBIKES S.R.L.
COMPONENTI PER MOTOCICLI

Forbikes ha sponsorizzato
il team Kawasaki Puccetti Racing
nel campionato Superbike 2018.

Toprak Razgatlioglu era il pilota
che correva per il team.



KIT TRASFORMAZIONE A LED PER LAMPADA

FASCIA
C

04-0070 H4

€ 46,00



KIT TRASFORMAZIONE A LED PER LAMPADA

FASCIA
C

04-0080 H1

€ 46,00



KIT TRASFORMAZIONE A LED PER LAMPADA

FASCIA
C

04-0090 H7

€ 46,00



KIT 10 PZ. LAMPADINA ALOGENA
12V21W BAY9S PER MINI FRECCHE

FASCIA
A

04-0010 TRASPARENTE € 29,00

04-0017 ARANCIO € 29,00



CP.SFIATI FORCELLA M5 P.0,8

FASCIA
C

00-0261	NERO	€ 20,00
00-0263	BLU	€ 20,00
00-0264	ROSSO	€ 20,00
00-0265	ORO	€ 20,00



CP.SFIATI FORCELLA M4 P.0,7

FASCIA
C

00-0271	NERO	€ 20,00
00-0273	BLU	€ 20,00
00-0274	ROSSO	€ 20,00
00-0275	ORO	€ 20,00



CALZE IN NEOPRENE PER FORCELLE

FASCIA
C

00-0301	€ 18,00
---------	---------



CP.SOFFIETTI COPERTURA SNODO
PEDANE MX

FASCIA
C

00-0531	€ 14,92
---------	---------



KIT PROTEZIONE TUBO SCARICO

FASCIA
C

00-0551	€ 23,35
---------	---------



CINGHIA SINGOLA ANCORAGGIO A
CRICCHETTO

FASCIA
A

08-0540	€ 17,50
---------	---------



KIT CINGHIE ANCORAGGIO A STRAPPO

FASCIA
A

08-0067	ARANCIO	€ 18,00
---------	---------	---------



KIT CINGHIE ANCORAGGIO A STRAPPO

FASCIA
A

08-0071	EXTRA NERO 40 mm	€ 25,00
---------	------------------	---------



STRISCIA A MANUBRIO ANCORAGGIO
CINGHIE

FASCIA
A

08-0080	€ 19,00
---------	---------

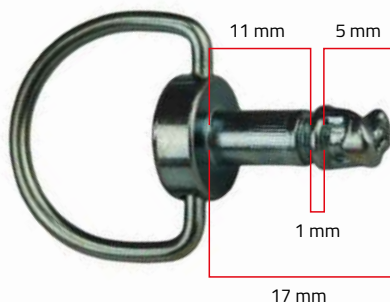

**KIT 10 PZ. PERNO SGANCIO RAPIDO
CON ANELLO E RONDELLE**

08-0230

FASCIA
C

€ 45,00



KIT 50 PZ. RONDELLA TEFLON PER VITI

FASCIA
C

08-0260	M5	€ 7,00
08-0270	M6	€ 7,00



KIT 10PZ. RICETTACOLO PER ART. 08-0230

08-0240 A RIVETTO

08-0250 A MOLLETTA

FASCIA
C

€ 13,00

€ 13,00



**KIT 10 PZ. GOMMINI CON INSERTO
FILETTATO**

FASCIA
C

08-0630	DIAM. 4	€ 10,50
	DIAM. 5	
08-0220	DIAM. EST. 9,2 mm - L 13,6 mm	€ 10,50
08-0221	DIAM. 6	€ 11,90



**FERMACOPERTONE ANTERIORE CON
BATTUTA IN ALLUMINIO 1.40-1.60**

08-0180

FASCIA
A

€ 11,50

**FERMACOPERTONE POSTERIORE
CON BATTUTA IN ALLUMINIO**

08-0190	1.85	€ 11,50
08-0200	2.15	€ 11,50
08-0210	2.50	€ 11,50

FASCIA
A

€ 11,50

€ 11,50

€ 11,50



**KIT 2 PZ. MOLLA MARMITTA UNCINO
GIREVOLE**

FASCIA
C

08-0340	DIMENSIONI 57 mm	€ 3,50
08-0350	DIMENSIONI 75 mm	€ 3,50
08-0360	DIMENSIONI 83 mm	€ 4,00
08-0370	DIMENSIONI 90 mm	€ 4,00

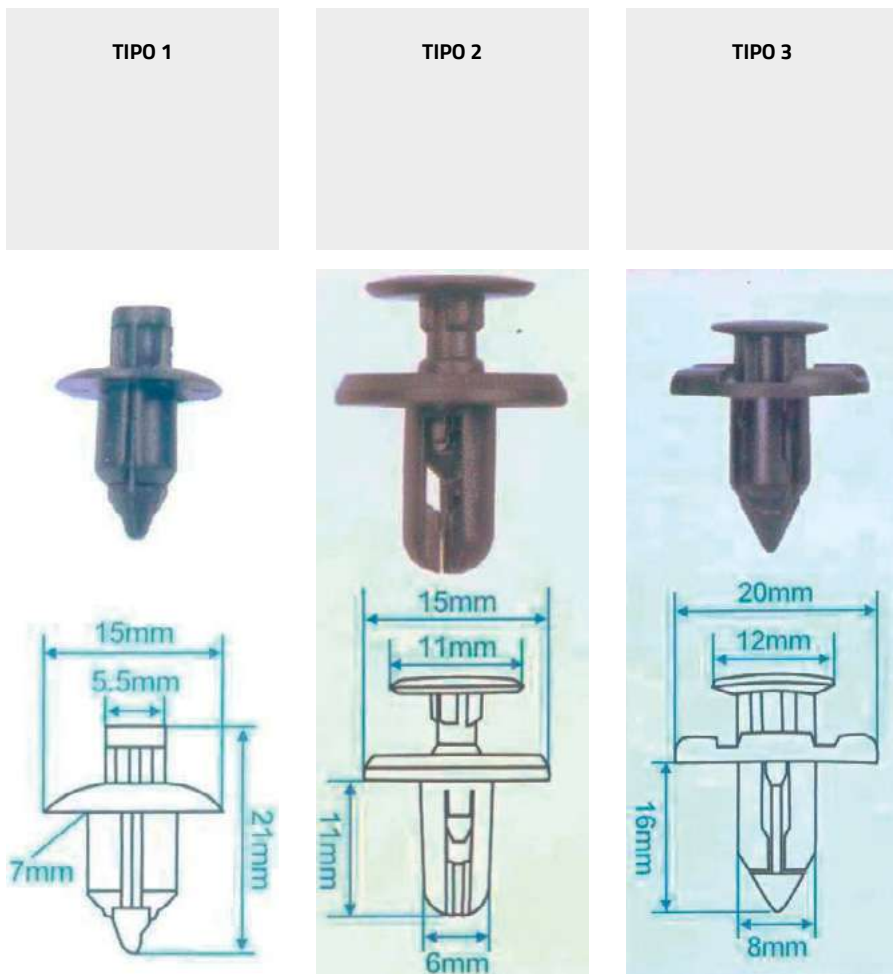

KIT 10PZ. RIVETTO A CLIP JAPAN STYLE PER CARENE

FASCIA
C

08-0500 15X21X7X5,5 - TIPO 1

€ 9,90

08-0510 15X11X11X6 - TIPO 2

€ 9,90

08-0520 20X12X16X8 - TIPO 3

€ 9,90



**CP.SPINE FERMA-PASTIGLIE
PER PINZE L. 50 mm**

FASCIA
C

08-0410

€ 11,00



**TAPPO RADIATORE ACQUA 1.8
CON TERMOMETRO INTEGRATO**

FASCIA
D

(MOTO EUROPEE - KTM
HUSQVARNA, APRILIA,
DUCATI...)

00-0620

€ 33,00

(MOTO JAPAN - KAWA,
YAMAHA, HONDA SUZUKI)

00-0630

€ 33,00



**KIT RIPARAZIONE PNEUMATICI
TUBELESS IN BORSETTA**

FASCIA
A

08-0650 CHIAVE A T

€ 25,00



**CONFEZIONE 30 PZ.CARTUCCE CO2
A RICAMBIO**

FASCIA
A

08-0420

€ 69,90



BLOCCALEVA FRENO ANTERIORE

FASCIA
C

08-0580

€ 6,80

**CP.TERMOCOPERTE "RACE ITALY" 200/120 mm TRIPLO STADIO
CON TERMOSTATO 60°/80°/95°C**FASCIA
C

08-0640 € 277,80

Le termocoperte RACE ITALY consentono agli pneumatici di raggiungere la temperatura ottimale in poco tempo garantendo, di conseguenza, un miglior rendimento della miscela nella sua tenuta.

Il termostato digitale permette la regolazione su tre livelli 60°C /80°C /95°C e consente il loro utilizzo su pneumatici di tutte le marche sia a livello professionale che amatoriale, a differenza delle termocoperte impostate su un'unica temperatura fissa e non selezionabile.

Adatte per pneumatici con misura sul posteriore fino a 200/60, sono contraddistinte dal tessuto tricolore che richiama la bandiera italiana e sono dotate di un termometro digitale applicabile per il controllo della temperatura in aggiunta al led spia a raggiungimento della temperatura selezionata.



SPUGNA ANTI-SCUOTIMENTO PER SERBATOIO CARBURANTE
ANTIDEFILAGRAZIONE - ANTISBATTIMENTO - ANTISCIACQUO

Cubetti antiscuotimento in spugna reticolata per uso racing e offroad: stabilizzano la moto, evitano la formazione di vapori e i rischi connessi.



SPUGNA RACING ANTI-SBATTIMENTO
PER SERBATOIO - MISURA 5X5X5
VOLUME 3,8 LITRI

FASCIA
C

00-0685

23,90

**PREZZO
RIBASSATO**



BENDA TERMICA RIVESTIM.MARMITTA
LARGA 50 mm, SP.2MM, ROTOLO 15
METRI LINEARI

FASCIA
C

08-0460

€ 49,00



CP.VALVOLE RACING 97° ALLUM. 6061 DIAM.10 MOTO JAPAN - ANODIZZATE

FASCIA
C

12-0260 ARGENTO

€ 19,90

12-0261 NERO

€ 19,90

12-0263 BLU

€ 19,90

12-0264 ROSSO

€ 19,90

12-0265 ORO

€ 19,90

12-0268 VERDE

€ 19,90

CP.VALVOLE RACING 97° ALLUM. 6061 DIAM. 8,3 MOTO EU - ANODIZZATE

FASCIA
C

12-0720 ARGENTO

€ 19,90

12-0721 NERO

€ 19,90



KIT 6 PZ.BULLONI CONICI FISSAGGIO
CORONA M8 X 34 mm

FASCIA
C

08-0330

€ 13,90



SFIATO PER TAPPO OFF-ROAD

	FASCIA C
12-0630 ARGENTO	€ 8,30
12-0631 NERO	€ 8,30
12-0633 BLU	€ 8,30
12-0634 ROSSO	€ 8,30
12-0635 ORO	€ 8,30
12-0637 ARANCIO	€ 8,30
12-0638 VERDE	€ 8,30



TUBO PVC CON VALVOLA SFIATO, UNIDIREZIONALE

	FASCIA C
12-0641 NERO	€ 9,75
12-0643 BLU	€ 9,75
12-0644 ROSSO	€ 9,75
12-0647 ARANCIO	€ 9,75



RULLINO CATENA DIAM. 32 H.23,5 mm

	FASCIA C
14-0021	€ 11,60



KIT 4 PEZZI ELASTICI FISSAGGIO MASCHERINA OFF-ROAD

	FASCIA C
14-0131	€ 11,80

TAPPO SCARICO OLIO MAGNETICO

	FASCIA C
12-0651 M12X1,5X14,5	€ 18,90
12-0661 M12X1,25X10	€ 18,90
12-0671 M12X1,25X20	€ 18,90



MINI SERBATOIO LIQUIDO FRENI

	FASCIA C
14-0141 USCITA LATERALE	€ 13,50
14-0151 USCITA CENTRALE	€ 15,00

ADATTATORE PORTATARGA
LEGGERO E RESISTENTE

Supporto universale per targhe italiane per l'installazione su portatarga aftermarket.



SUPPORTO TARGA ITALIA ALLUMINIO 6082 T6 ANODIZZATO NERO		FASCIA C
12-0731	NEW	€ 14,00



CORNICE TARGA TIPO VECCHIO		FASCIA C
00-0730	METALLO CROMATA	NEW € 6,50
00-0731	METALLO NERO	NEW € 6,50



PIATTO SUPPORTO TARGA TIPO VECCHIO		FASCIA C
00-0740	INOX CROMATO	NEW € 8,00
00-0741	INOX NERO	NEW € 7,00

CORNICE TARGA TIPO NUOVO		FASCIA C
00-0750	INOX CROMATA	NEW € 6,50
00-0751	INOX NERO	NEW € 6,50

PIATTO SUPPORTO TARGA TIPO NUOVO		FASCIA C
00-0760	INOX CROMATO	NEW € 8,00
00-0761	INOX NERO	NEW € 7,00



DAYTONA

VEDERE APPLICATIVO MOTO
SU WWW.FORBIKES.IT
> AREA DOWNLOAD

TAPPO CARICO OLIO MOTORE DOPPIA ANODIZZAZIONE

FASCIA
E

91885	M20 X 1,5 - ROSSO	€ 49,14	91894	M20 X 2,5 - ARGENTO	€ 49,14	91911	M30 X 1,5 - BLU	€ 49,14
91886	M20 X 1,5 - BLU	€ 49,14	91895	M24 X 3 - ROSSO	€ 49,14	91912	M30 X 1,5 - ORO	€ 49,14
91887	M20 X 1,5 - ORO	€ 49,14	91896	M24 X 3 - BLU	€ 49,14	91913	M30 X 1,5 - VERDE	€ 49,14
91890	M20 X 1,5 - ROSSO	€ 49,14	91897	M24 X 3 - ORO	€ 49,14	91914	M30 X 1,5 - ARGENTO	€ 49,14
91891	M20 X 2,5 - BLU	€ 49,14	91898	M24 X 3 - VERDE	€ 49,14			
91892	M20 X 2,5 - ORO	€ 49,14	91899	M24 X 3 - ARGENTO	€ 49,14			
91893	M20 X 2,5 - VERDE	€ 49,14	91910	M30 X 1,5 - ROSSO	€ 49,14			



DAYTONA

VEDERE APPLICATIVO MOTO
SU WWW.FORBIKES.IT
> AREA DOWNLOAD

TAPPO SERBATOIO OLIO FRENI DOPPIA ANODIZZAZIONE

FASCIA
E

92727	NISSIN, DIAM. 59 - ROSSO	€ 49,14	92735	NISSIN, DIAM. 42 - VERDE	€ 49,14	92743	BREMBO, S30 / S35 - BLU	€ 49,14
92728	NISSIN, DIAM. 59 - BLU	€ 49,14	92736	NISSIN, DIAM. 42 - ARGENTO	€ 49,14	92744	BREMBO, S30 / S35 - ORO	€ 49,14
92729	NISSIN, DIAM. 59 - ORO	€ 49,14	92737	NISSIN, DIAM. 38 - ROSSO	€ 49,14	92751	BREMBO, S30 / S35 - VERDE	€ 49,14
92730	NISSIN, DIAM. 59 - VERDE	€ 49,14	92738	NISSIN, DIAM. 38 - BLU	€ 49,14	92752	BREMBO, S30 / S35 - ARGENTO	€ 49,14
92731	NISSIN, DIAM. 59 - ARGENTO	€ 49,14	92739	NISSIN, DIAM. 38 - ORO	€ 49,14			
92732	NISSIN, DIAM. 42 - ROSSO	€ 49,14	92740	NISSIN, DIAM. 38 - VERDE	€ 49,14			
92733	NISSIN, DIAM. 42 - BLU	€ 49,14	92741	NISSIN, DIAM. 38 - ARGENTO	€ 49,14			
92734	NISSIN, DIAM. 42 - ORO	€ 49,14	92742	BREMBO, S30 / S35 - ROSSO	€ 49,14			



TAPPO SERBATOIO OLIO FRENI DOPPIA ANODIZZAZIONE RETTANGOLARE C/VITI

FASCIA E

98270	HONDA TIPO A - ROSSO	€ 49,14	99279	HONDA TIPO H - ROSSO	NEW € 49,14	98290	KAWASAKI TIPO F - ROSSO	€ 49,14
98271	HONDA TIPO A - BLU	€ 49,14	99280	HONDA TIPO H - BLU	NEW € 49,14	98291	KAWASAKI TIPO F - ORO	€ 49,14
98272	HONDA TIPO A - ORO	€ 49,14	99281	HONDA TIPO H - ORO	NEW € 49,14	98292	KAWASAKI TIPO F - VERDE	€ 49,14
98273	HONDA TIPO A - ARGENTO	€ 49,14	99282	HONDA TIPO H - ARGENTO	NEW € 49,14	98293	KAWASAKI TIPO F - ARGENTO	€ 49,14
98274	HONDA TIPO B - ROSSO	€ 49,14	98278	YAMAHA TIPO C - ROSSO	€ 49,14	98294	KAWASAKI TIPO G - ROSSO	€ 49,14
98275	HONDA TIPO B - BLU	€ 49,14	98279	YAMAHA TIPO C - BLU	€ 49,14	98295	KAWASAKI TIPO G - ORO	€ 49,14
98276	HONDA TIPO B - ORO	€ 49,14	98280	YAMAHA TIPO C - ORO	€ 49,14	98296	KAWASAKI TIPO G - VERDE	€ 49,14
98277	HONDA TIPO B - ARGENTO	€ 49,14	98281	YAMAHA TIPO C - ARGENTO	€ 49,14	98297	KAWASAKI TIPO G - ARGENTO	€ 49,14
98282	HONDA TIPO D - ROSSO	€ 49,14	98286	SUZUKI TIPO E - ROSSO	€ 49,14	99706	KAWASAKI TIPO I - ROSSO	NEW € 49,14
98283	HONDA TIPO D - BLU	€ 49,14	98287	SUZUKI TIPO E - BLU	€ 49,14	99707	KAWASAKI TIPO I - ORO	NEW € 49,14
98284	HONDA TIPO D - ORO	€ 49,14	98288	SUZUKI TIPO E - ORO	€ 49,14	99708	KAWASAKI TIPO I - VERDE	NEW € 49,14
98285	HONDA TIPO D - ARGENTO	€ 49,14	98289	SUZUKI TIPO E - ARGENTO	€ 49,14	99709	KAWASAKI TIPO I - ARGENTO	NEW € 49,14



STAFFA SUPPORTO SERBATOIO FRENI NISSIN (RADIAL/AXIAL BRAKE MASTER CYLINDER)

FASCIA E

92662	ROSSO	€ 8,16
92663	BLU	€ 8,16
92668	ORO	€ 8,16
92669	VERDE	€ 8,16
92676	ARGENTO	€ 8,16
92677	NERO	€ 8,16



STAFFA SUPPORTO SERBATOIO FRENI NISSIN (RADIAL CLUTCH MASTER CYLINDER)

FASCIA E

92678	ROSSO	€ 8,16
92679	BLU	€ 8,16
92680	ORO	€ 8,16
92681	VERDE	€ 8,16
92684	ARGENTO	€ 8,16
92701	NERO	€ 8,16



STAFFA SUPPORTO SERBATOIO FRENI NISSIN (AXIAL CLUTCH MASTER CYLINDER)

FASCIA E

92704	ROSSO	€ 8,16
92705	BLU	€ 8,16
92706	ORO	€ 8,16
92707	VERDE	€ 8,16
92708	ARGENTO	€ 8,16
92709	NERO	€ 8,16



LEVA SMONTA GOMME

FASCIA
A

08-0020	L. 240 MM	€ 6,50
08-0030	L. 400 MM	€ 11,60
08-0040	CURVATA L. 380 MM	€ 13,80



CHIAVE FILTRO OLIO

FASCIA
A

08-0090	65 MM HONDA/YAMAHA/ KAWASAKI	€ 7,90
08-0100	68 MM SUZUKI	€ 7,90
08-0120	76 MM HARLEY	€ 7,90
08-0130	80 MM HONDA OLD MODELS	€ 7,90
08-0320	BMW (NEW 1200) / PIAGGIO CON INTAGLI	€ 7,90



CHIAVE A "T" 8/10/12 mm

FASCIA
A

08-0150	€ 7,20
---------	--------



KIT TAGLIO E RIBATTITURA CATENA
TRASMISSIONE

FASCIA
A

08-0310	€ 69,00
---------	---------



PERNO A RICAMBIO PER KIT TAGLIO
RIBATTITURA ART. 08-0310

FASCIA
A

08-0310A	€ 9,00
----------	--------



TESSUTO ALLUM.TERMORIFRANGENTE
ADESIVO 250X200 mm

FASCIA
A

08-0380	€ 7,90
---------	--------



TESSUTO FONOASSORBENTE FILOMAT
A5800 1000x500x6 mm

FASCIA
A

08-0390	€ 9,50
---------	--------



PANNO FONOASSORBENTE PROFESS.
ALTO SPESSORE CON SUPERFICIE
IGNIFUGA 41SIK 1000X500 mm

FASCIA
A

08-0400	€ 24,50
---------	---------



PINZA GIRAFILO (CONFEZIONATA)

FASCIA
C

08-0430	€ 29,30
---------	---------

**PREZZO
RIBASSATO**



BOBINA FILO INOX PER PINZA GIRAFILO FASCIA C
08-0440 € 24,00



SET ESTRATTORI VOLANTINO VARIE MISURE FASCIA C
08-0450 € 59,00



KIT CRICCHETTO, CHIAVE CANDELA mm 16, 18, 21 FASCIA A
08-0470 € 18,00



SET 9PZ. CHIAVI A BRUGOLA MULTICOLOR FASCIA C
08-0490 € 17,00



SET ATTREZZI RIMOZIONE CUSCINETTI FASCIA C
08-0530 € 68,00

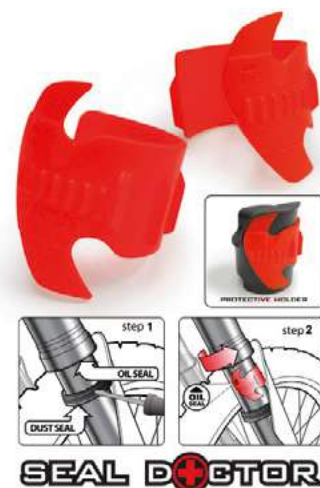

PULITORE PARAOLI FORCELLA E SEDI FASCIA C
08-0590 € 10,00



MANOMETRO DI PRECISIONE PRESSIONE PNEUMATICI FASCIA C
08-0550 € 35,00



KIT LEVE SMONTAGOMME CON CHIAVE ESAGONALE INTEGRATA FASCIA C
08-0560 MOTO EUROPEE € 38,00
08-0570 MOTO JAPAN € 38,00



SPINE STOPPA FLUIDO OLIO E CARBURANTE (3 MISURE) FASCIA C
08-0600 € 4,80



CHIAVE ESAGONALE UNIV.PER PERNO
RUOTA ANTERIORE (4 MISURE)

08-0610

FASCIA
C

€ 7,50



ATTREZZO RIEMPIMENTO BATTERIA

08-0620

FASCIA
C

€ 19,00



NASTRO TELATO 48 mm X 25 m

FASCIA
A

08-0280	ARGENTO	€ 10,50
08-0281	NERO	€ 10,50
08-0283	BLU	€ 10,50
08-0284	ROSSO	€ 10,50
08-0285	GIALLO	€ 10,50
08-0288	VERDE	€ 10,50



PROTEZIONE SERBATOIO RESINATA - NERO



GRAFICA FULL DAKAR FASCIA A
07-0301 **NEW** € 18,00



GRAFICA GS FASCIA A
07-0311 **NEW** € 18,00



GRAFICA AFRICA TWIN FASCIA A
07-0321 **NEW** € 18,00



GRAFICA HONDA FASCIA A
07-0331 **NEW** € 18,00



GRAFICA SUZUKI FASCIA A
07-0341 **NEW** € 18,00



GRAFICA YAMAHA FASCIA A
07-0351 **NEW** € 18,00



GRAFICA APRILIA FASCIA A
07-0361 **NEW** € 18,00



GRAFICA MV FASCIA A
07-0371 **NEW** € 18,00



GRAFICA KTM FASCIA A
07-0381 **NEW** € 18,00



GRAFICA DUCATI FASCIA A
07-0391 **NEW** € 18,00

TIPO 1



TIPO 2



TIPO 3



PROTEZIONE SERBATOIO RESINATA

FASCIA
A

07-0011	TIPO 1 NERO	€ 9,90
07-0019	TIPO 1 SIMILCARBONIO	€ 9,90
07-0021	TIPO 2 NERO	€ 9,90
07-0029	TIPO 2 SIMILCARBONIO	€ 9,90
07-0031	TIPO 3 MODULARE NERO	€ 9,90
07-0039	TIPO 3 MODULARE SIMILCARBONIO	€ 9,90



STRISCE PER CERCHI 7 mm

FASCIA
A

07-0040	EFFETTO ALLUMINIO	€ 7,50	07-0044	ROSSO RIFRANGENTE	€ 7,50
07-0041	NERO	€ 7,50	07-0045	GIALLO FLUO	€ 7,50
07-0042	BIANCO RIFRANGENTE	€ 7,50	07-0047	ARANCIO FLUO	€ 7,50
07-0043	BLU RIFRANGENTE	€ 7,50	07-0048	VERDE FLUO	€ 7,50



APPLICATORE STRISCE PER CERCHI

FASCIA
A

07-0050	€ 2,91
---------	--------

CENTRE TANK PADS

Con le nuove protezioni centrali EAZI-GRIP è possibile allestire la propria moto sia sulle parti laterali, che sulla parte centrale del serbatoio, con la stessa tipologia di materiale (EVO o PRO o SILICONE), disponibili nei diversi design

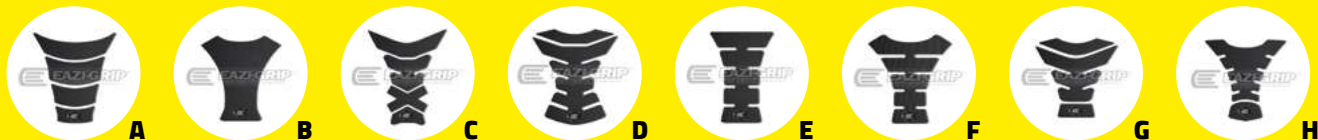

DESIGN	MODELLO	CODICE PRODOTTO	Prezzo al pubblico IVA ESCLUSA	FASCIA
A	EVO CLEAR	EVOCENTREPADACL	€ 14,50	E
A	EVO BLACK	EVOCENTREPADABL	€ 14,50	E
A	PRO CLEAR	PROCENTREPADACL	€ 14,50	E
A	PRO BLACK	PROCENTREPADABL	€ 14,50	E
A	SILICONE	SILCENTREPADABL	€ 17,30	E
B	EVO CLEAR	EVOCENTREPADBCL	€ 14,50	E
B	EVO BLACK	EVOCENTREPADDBL	€ 14,50	E
B	PRO CLEAR	PROCENTREPADBCL	€ 14,50	E
B	PRO BLACK	PROCENTREPADDBL	€ 14,50	E
B	SILICONE	SILCENTREPADDBL	€ 17,30	E
C	EVO CLEAR	EVOCENTREPADCCL	€ 14,50	E
C	EVO BLACK	EVOCENTREPADCBL	€ 14,50	E
C	PRO CLEAR	PROCENTREPADCCL	€ 14,50	E
C	PRO BLACK	PROCENTREPADCBL	€ 14,50	E
C	SILICONE	SILCENTREPADCBL	€ 17,30	E
D	EVO CLEAR	EVOCENTREPADDCL	€ 14,50	E
D	EVO BLACK	EVOCENTREPADDBL	€ 14,50	E
D	PRO CLEAR	PROCENTREPADDCL	€ 14,50	E
D	PRO BLACK	PROCENTREPADDBL	€ 14,50	E
D	SILICONE	SILCENTREPADDBL	€ 17,30	E
E	EVO CLEAR	EVOCENTREPADECL	€ 14,50	E
E	EVO BLACK	EVOCENTREPADEBL	€ 14,50	E
E	PRO CLEAR	PROCENTREPADECL	€ 14,50	E
E	PRO BLACK	PROCENTREPADEBL	€ 14,50	E
E	SILICONE	SILCENTREPADEBL	€ 17,30	E
F	EVO CLEAR	EVOCENTREPADFCL	€ 14,50	E
F	EVO BLACK	EVOCENTREPADFBL	€ 14,50	E
F	PRO CLEAR	PROCENTREPADFCL	€ 14,50	E
F	PRO BLACK	PROCENTREPADFBL	€ 14,50	E
F	SILICONE	SILCENTREPADFBL	€ 17,30	E
G	EVO CLEAR	EVOCENTREPADGCL	€ 14,50	E
G	EVO BLACK	EVOCENTREPADGBL	€ 14,50	E
G	PRO CLEAR	PROCENTREPADGCL	€ 14,50	E
G	PRO BLACK	PROCENTREPADGBL	€ 14,50	E
G	SILICONE	SILCENTREPADGBL	€ 17,30	E
H	EVO CLEAR	EVOCENTREPADHCL	€ 14,50	E
H	EVO BLACK	EVOCENTREPADHBL	€ 14,50	E
H	PRO CLEAR	PROCENTREPADHCL	€ 14,50	E
H	PRO BLACK	PROCENTREPADHBL	€ 14,50	E
H	SILICONE	SILCENTREPADHBL	€ 17,30	E

SMONTABILE



CAVALLETTO ALZAMOTO POSTERIORE	FASCIA A
06-0140 C/FORCHETTE	€ 57,10
06-0150 C/TAMPONI	€ 57,10



CAVALLETTO SERIE LUX	FASCIA C
CAVALLETTO POSTERIORE C/DOPPIA RUOTA SENZA CURSORI	
06-0261	€ 45,00



CAVALLETTO SERIE LUX	FASCIA C
CAVALLETTO ANTERIORE SOTTOFORK C/DOPPIA RUOTA SENZA CURSORI	
06-0271	€ 44,00



CAVALLETTO SERIE LUX	FASCIA C
CAVALLETTO POSTERIORE TRIUMPH BONNEVILLE - COLORE BLU	
06-0283	€ 72,00



CAVALLETTO SERIE LUX	FASCIA C
CAVALLETTO POSTERIORE DUCATI SCRAMBLER	
06-0291	€ 79,00



CAVALLETTO ANTERIORE BLOCCAGGIO AUTOMATICO - COLORE NERO	FASCIA D
06-0241	€ 78,00

SMONTABILE



CAVALLETTO ALZAMOTO ANTERIORE SOTTOFORCELLA C/CURSORI	FASCIA A
06-0160	€ 57,10

SMONTABILE



CAVALLETTO ALZAMOTO OFF-ROAD A LEVA	FASCIA A
06-0187 COLORE ARANCIO	€ 59,00

SMONTABILE



CAVALLETTO MONOBRACCIO "ECO" SMONTABILE CON PERNO INCLUSO	FASCIA A
06-0200A TRIUMPH DIAM.27,4mm	€ 90,00
06-0200B BMW DIAM.53,00/53,6mm	€ 90,00
06-0200D DUCATI 1098/MV DIAM.40,7mm	€ 90,00
06-0200G HONDA DIAM.30,5mm	€ 90,00
06-0200H DUCATI DIAM.25,8/21,7mm	€ 90,00
06-0200I HONDA DIAM.28,4mm	€ 90,00

FOTO DIMOSTRATIVA



CAVALLETTO ALZAMOTO FISSAGGIO A TELAIO

06-0210 ALTEZZA MASSIMA DA TERRA/RUOTE 25cm.

FASCIA
D

€ 179,00



PERNO PER CAVALLETTO ALZAMOTO FISSAGGIO A TELAIO

FASCIA
D

€ 45,00

APPLICATIVO PERNO PER CAVALLETTO ALZAMOTO FISSAGGIO A TELAIO

MODELLO	CODICE	PREZZO
APRILIA FASCIA D		
APRILIA RSV4 '09-'14	06-0210R	€ 45,00
APRILIA MILLE '98-'03 / TUONO	06-0210R1	€ 45,00
APRILIA DORSODURO 750 '08-'16 1200 '11-'16	06-0210R2	€ 45,00
BMW FASCIA D		
S1000RR '09-'14	06-0210A	€ 45,00
S1000RR '15-'18	06-0210A1	€ 45,00
R NINET '14-'18	06-0210A2	€ 45,00
F 700 / 800 GS '08-'13	06-0210A3	€ 45,00
R 1200 R '06-'14	06-0210A4	€ 45,00
R 1200 R/RS '15-'17	06-0210A5	€ 45,00
R 1200 GS '13-'17 / ADVENTURE '14-'17	06-0210AB	€ 45,00
DUCATI FASCIA D		
848 '08-'10 / 848 EVO '11-'12 / STREETFIGHTER 848 '11-'12 / STREETFIGHTER S '09-'12 / 1098 '07-'08 / 1198 '09-'11	06-0210C	€ 45,00
DIAVEL TUTTI GLI ANNI	06-0210C1	€ 45,00
MONSTER 696/796/1100	06-0210C2	€ 45,00
MONSTER 1200 / S '15-'17	06-0210C3	€ 45,00
MONSTER S2R 1000 '06-'08 / S4R '03-'08	06-0210C4	€ 45,00
748 '95-'04 / 916 '94-'98 / 996 '99-'01 / 998 '02-'04	06-0210C5	€ 45,00
899 '14-'15 / 1199 PANIGALE '12-'14	06-0210C6	€ 45,00
MULTISTRADA 1200 10-14	06-0210C7	€ 45,00
HYPERMOTARD 821 '13-'15 / HYPERSTRADA 821 '13-'15 / HYPERSTRADA 939 '16	06-0210AE	€ 45,00
MONSTER 821 2014-2018	06-0210C8	€ 45,00
MULTISTRADA 1200 2011-2016	06-0210C9	€ 45,00
HONDA FASCIA D		
CBR600 '07-'16	06-0210H	€ 45,00
CBR1000 '08-'16	06-0210N	€ 45,00
CBR 600 F '11-'13 / HORNET 600 '07-'13	06-0210H1	€ 45,00
CBR1000 '04-'06	06-0210M	€ 45,00
HONDA CB1000R '08-'13	06-0210W	€ 45,00
HONDA VFR 1200	06-0210V	€ 45,00
KAWASAKI FASCIA D		
ZZR 1400 '06-'17	06-0210ZD	€ 45,00
Z 1000 '10-'17 / SX '11-'17	06-0210AC	€ 45,00
Z 800 / E '13-'16	06-0210AD	€ 45,00
ZX10R '11-'14	06-0210T	€ 45,00
ZX6R '09-'15	06-0210ZA	€ 45,00

MODELLO	CODICE	PREZZO
Z 750 '07-'12 / Z 1000 '07-'09	06-0210ZB	€ 45,00
Z 1000 '03-'06	06-0210ZC	€ 45,00
Z 1000 SX '11-'12	06-0210Q	€ 45,00
NINJA 250-300	06-0210ZE	€ 45,00
ZX10-R 08-10	06-0210J	€ 45,00
KTM FASCIA D		
RC8	06-0210S	€ 45,00
DUKE 3+4(ALL SMALL BIKES)	06-0210S1	€ 45,00
690 SMC	06-0210S2	€ 45,00
SUPERDUKE 1290	06-0210S3	€ 45,00
990/950 ADV	06-0210S4	€ 45,00
MV FASCIA D		
MV AGUSTA 800 DRAGSTAR / RIVALE 800	06-0210Z	€ 45,00
MV AGUSTA F3 AND 800 BRUTALE	06-0210M	€ 45,00
MV AGUSTA F4 & BRUTALE 1078	06-0210F	€ 45,00
SUZUKI FASCIA D		
GSXR1000 '09-'12	06-0210B	€ 45,00
GSXR1000 '03-'04	06-0210B1	€ 45,00
GSXR1000 '05-'08	06-0210B2	€ 45,00
GSX-S1000 / F '15-'17	06-0210B3	€ 45,00
GSX-R 600 '01-'03 / 750 '00-'03 / 1000 '01-'02	06-0210B4	€ 45,00
GSXR 600/750 '06-'10	06-02100	€ 45,00
GSXR 600/750 11-16	06-021001	€ 45,00
GSR 600/750 '11-'14	06-0210U	€ 45,00
HAYABUSA '08-'14	06-0210Y	€ 45,00
SV650 1999-2015	06-0210B5	€ 45,00
TRIUMPH FASCIA D		
675 DAYTONA / STREET TRIPLE '06-'16	06-0210P	€ 45,00
SPEED TRIPLE '11-'14	06-0210P1	€ 45,00
SPEED TRIPLE '05-'10	06-0210P2	€ 45,00
YAMAHA FASCIA D		
YZF-R6 '06-'16	06-0210E	€ 45,00
YZF-R1 '99-'03	06-0210IB	€ 45,00
YZF-R1 '04-'06	06-0210I	€ 45,00
YZF-R1 '07-'08	06-0210L	€ 45,00
YZF-R1 '09-'14	06-0210D	€ 45,00
YZF-R1/R1M '15-'19	06-0210IA	NEW € 45,00
YAMAHA MT 07 '14-(FZ 07)	06-0210X1	€ 45,00
YAMAHA MT 09 '14-(FZ-09)	06-0210X2	€ 45,00
YAMAHA FZ1 '09-'15	06-0210X3	€ 45,00

RAMPA CARICO MOTO 2250x280x50mm KG.500 MAX

Realizzata in alluminio e dotata di piedini di rinforzo, si caratterizza per essere leggera, robusta e pieghevole, permettendoti di caricare agevolmente moto e quad fino a 500 Kg.



RAMPA CARICO MOTO - QUAD IN ALLUMINIO C/PIEDINI DI RINFORZO KG.500 MAX

FASCIA
C

06-0250 DIMENSIONI: 2250x280x50mm

122,00





COPPIA TAMPONI IN GOMMA PER CAVALLETTO ALZAMOTO POSTERIORE

FASCIA C

(MONTANO ANCHE SU 06-0261)

06-0100 PERNO QUADRATO € 17,00

06-0490 PERNO ARROTONDATO **NEW** € 17,00



COPPIA FORCHETTE PER CAVALLETTO ALZAMOTO POSTERIORE

FASCIA A

06-0090 PERNO QUADRATO € 13,50

06-0220 PERNO ARROTONDATO € 13,50



CP.CURSORI SOTTOFORK PER CAVALLETTO ANTERIORE 06-0271

FASCIA C

06-0340 € 17,00



CP.CURSORI CONICI SOTTOFORK PER CAVALLETTO ANTERIORE 06-0271

FASCIA C

06-0350 € 17,00



CP.CURSORI UNIV.A RULLI PER CAVALLETTO ANTERIORE 06-0271

FASCIA C

06-0360 € 17,00



CP.CURSORI RULLO PINZE PER FRENI RADIALI PER CAVALLETTO ANTERIORE 06-0271

FASCIA C

06-0470 € 17,00





CAVALLETTO SERIE LUX

FASCIA
C

CAVALLETTO POSTERIORE MONOBRACCIO SX SENZA
PERNO
06-0301 € 99,00

CAVALLETTO SERIE LUX

FASCIA
C

CAVALLETTO POSTERIORE MONOBRACCIO DX SENZA
PERNO
06-0311 € 99,00

PERNI CAVALLETTO MONOBRACCIO 06-0301 - 06-0311

FASCIA
C



06-0370 DUCATI DIAM.40,5 MM (PANIGALE, 1098 STREETFIGHTER, 1198, MULTISTRADA 1200) € 35,00



06-0380 HONDA DIAM.28,7 mm € 22,00



06-0390 DUCATI DIAM.29,8 mm € 22,00



06-0400 BMW F650GS / F800-S/ST DIAM.30mm € 22,00



06-0410 BMW R1200GS DIAM.51mm € 35,00



06-0420 BMW DIAM.53mm € 40,00



06-0430 DUCATI DIAM.21,8 / 25,9mm € 22,00



06-0440 HONDA CB1000R DIAM.25,25mm € 22,00



06-0450 MV AGUSTA / DUCATI 1098/STREETFIGHTER/1198 DIAM.42,50mm € 35,00



06-0460 TRIUMPH / KTM SUPERDUKE DIAM.27,5mm € 22,00



PEDANA ACCOSTA-MOTO C/FRENO
COLORE NERO

FASCIA
D

06-0231

€ 79,80



PEDANA ACCOSTA-MOTO
PORTATA 400KG

FASCIA
C

06-0324 COLORE ROSSO

€ 136,00



CAVALLETTO OFF-ROAD IDRAULICO A
PANTOGRAFO PORTATA 140 KG. - NERO

FASCIA
C

06-0501

NEW € 200,00



CAVALLETTO IDRAULICO SOTTO
MOTORE MAXI CRUISER / CUSTOM
PORTATA 500 KG

FASCIA
C

06-0511 NERO

NEW € 190,00



PEDANA ACCOSTA-MOTO C/APPENDICE
PER STAMPELLA LATERALE PORTATA
500 KG

FASCIA
C

06-0521 NERO

NEW € 195,00



CAVALLETTO ANTERIORE
SOTTOCANOTTO C/ 8 PERNI INCLUSI

FASCIA
C

06-0531

NEW € 115,00



STAMPELLA LATERALE 400mm BLU HUSQVARNA FE/FX/TE
2009-2016

FASCIA
C

06-0483

NEW € 79,00



STAMPELLA LATERALE 400mm ARANCIO - KTM EXC/EXC-F/XC/XC-F/
XC-W 2008-2016

FASCIA
C

06-0487

NEW € 79,00



CP.NOTTOLINI CAVALLETTO ANODIZZATO M5/M8/M10

		FASCIA A
12-0690	VITE M6 - ARGENTO	€ 12,50
12-0691	VITE M6 - NERO	€ 12,50
12-0693	VITE M6 - BLU	€ 12,50
12-0694	VITE M6 - ROSSO	€ 12,50
12-0695	VITE M6 - GIALLO	€ 12,50
12-0700	VITE M8 - ARGENTO	€ 12,50
12-0701	VITE M8 - NERO	€ 12,50
12-0703	VITE M8 -BLU	€ 12,50
12-0704	VITE M8 -ROSSO	€ 12,50
12-0705	VITE M8 -GIALLO	€ 12,50
12-0710	VITE M10 - ARGENTO	€ 12,50
12-0711	VITE M10 -NERO	€ 12,50
12-0713	VITE M10 -BLU	€ 12,50
12-0714	VITE M10 -ROSSO	€ 12,50
12-0715	VITE M10 -GIALLO	€ 12,50





TUTA ANTIACQUA DIVISIBILE CON RIFRANGENTE - IMPERMEABILE 3000mm - COLORE NERO

		FASCIA C
50-0111M	TG.M	NEW € 34,50
50-0111L	TG.L	NEW € 34,50
50-0111XL	TG.XL	NEW € 34,50



TUTA ANTIACQUA DIVISIBILE VENTILATA, REGOLABILE - IMPERMEABILE 10.000mm, COLORE GIALLO FLUO/NERO

		FASCIA C
50-0121S	TG.S	NEW € 68,00
50-0121M	TG.M	NEW € 75,00
50-0121L	TG.L	NEW € 75,00
50-0121XL	TG.XL	NEW € 75,00
50-0121XXL	TG.XXL	NEW € 75,00



GIACCA SAFETY SENZA MANICHE CON RIFRANGENTE, REGOLABILE, VENTILATO - COLORE GIALLO FLUO

		FASCIA C
50-0135L	M/L	NEW € 28,00
50-0135XXL	XL/XXL	NEW € 28,00



COPRIGAMBE IMPERMEABILE 5000MM CON RIFRANGENTI, FODERA INTERNA, REGOLABILE

		FASCIA C
50-0141	NERO - TG.UNICA	NEW € 42,00



SCALDACOLLO IN COTONE

50-0061 NERO

FASCIA
C

€ 4,90



CINTURA LOMBARE STRADA

52-0071M TG.S-M-L

52-0071XL TG.L-XL-XXL

FASCIA
C

€ 19,00

€ 19,00

ESTIVO



SOTTOCASCO 100% COTONE, TESSUTO LEGGERO E TRASPIRANTE, ADATTO PER PERIODO ESTIVO

50-0151 TG.UNICA

FASCIA
C

NEW € 7,40



INVERNALE



SOTTOCASCO 100% MICROFIBRA, PROTEGGE DAL FREDDO E DAL VENTO, ADATTO PER IL PERIODO INVERNALE

50-0161 TG.UNICA

FASCIA
C

NEW € 8,20



CP.SAPONETTE "SLIDY"

51-0061 NERO

51-0063 BLU

51-0064 ROSSO

51-0065 GIALLO

51-0068 VERDE

FASCIA
C

€ 16,00

€ 16,00

€ 16,00

€ 16,00

€ 16,00



GUANTO ESTIVO PELLE/MESH MOD."ARIOSO" GRIGIO

		FASCIA C
53-0120S	TAGLIA S	€ 39,00
53-0120M	TAGLIA M	€ 39,00
53-0120L	TAGLIA L	€ 39,00
53-0120XL	TAGLIA XL	€ 39,00
53-0120XXL	TAGLIA XXL	€ 39,00



GUANTO ESTIVO PELLE/MESH MOD."ARIOSO" NERO

		FASCIA C
53-0121S	TAGLIA S	€ 39,00
53-0121M	TAGLIA M	€ 39,00
53-0121L	TAGLIA L	€ 39,00
53-0121XL	TAGLIA XL	€ 39,00
53-0121XXL	TAGLIA XXL	€ 39,00



GUANTO SPORTIVO PELLE MOD."GRINTOSO" NERO

		FASCIA C
53-0131S	TAGLIA S	€ 54,90
53-0131M	TAGLIA M	€ 54,90
53-0131L	TAGLIA L	€ 54,90
53-0131XL	TAGLIA XL	€ 54,90
53-0131XXL	TAGLIA XXL	€ 54,90



GUANTO ESTIVO PELLE MOD."STILOSO" NERO

		FASCIA C
53-0141S	TAGLIA S	€ 28,00
53-0141M	TAGLIA M	€ 28,00
53-0141L	TAGLIA L	€ 28,00
53-0141XL	TAGLIA XL	€ 28,00
53-0141XXL	TAGLIA XXL	€ 28,00







ASIDER
ASIDEROS PARA MOTOS DEPORTIVAS



L'ESIGENZA DI VIAGGIARE IN PIENA SICUREZZA ANCHE CON IL PASSEGGERO SULLE MOTO SPORTIVE TROVA ORA UNA DEFINITIVA RISPOSTA TECNICA NELLE MANIGLIE A-SIDER.

Costruite in pregiato alluminio, leggero ma allo stesso tempo molto resistente, inossidabile e insensibile agli agenti atmosferici, le maniglie A-SIDER si montano in un attimo sfruttando gli attacchi originali del tappo del serbatoio; garantiscono una salda presa del passeggero che non va più così a gravare con il suo peso sul pilota in frenata e non scompone l'assetto in accelerazione, quando per effetto dell'inerzia del corpo rispetto alla spinta poderosa della moto tende inevitabilmente a scivolare all'indietro, modificando la delicata distribuzione dei pesi, fondamentale nella guida sportiva.

Con un design altamente ergonomico, si integrano esteticamente alla linea della moto e costituiscono un completamento ottimale per l'uso sportivo in coppia del mezzo, oltre che un contributo sensibile anche alla sicurezza attiva e passiva: la pressione sul corpo del pilota si azzerà, la guida diventa più fluida e meglio bilanciata, il passeggero diventa parte integrante della moto, restando sempre in assetto ottimale.

La conformazione del profilo della sagoma, smussata e ben arrotondata su ogni angolo, garantisce infine l'assoluta sicurezza nella prevenzione di lesioni al motociclista e alla sua compagna.

MODELLI	ANNO	NEW	COLORE NERO	COLORE SILVER	PREZZO AL PUBBLICO IVA ESCLUSA	FASCIA	NUMERO VITI
APRILIA							
RSV4			DAR011	DAR010	€ 169,90	F	SENZA VITI
TUONO RSV4			DAF011	DAF010	€ 169,90	F	SENZA VITI
TUONO V4 1100	2019		DAF011	DAF010	€ 169,90	F	SENZA VITI
RSV4 RR/RF 1100	2019		DAF011	DAF010	€ 169,90	F	SENZA VITI
BMW							
S1000RR			BR021	BR020	€ 169,90	F	SENZA VITI
S1000R			BR021	BR020	€ 169,90	F	SENZA VITI
R850R, R1100R,	fino 2006		BR011	BR010	€ 105,00	F	6 VITI
R1150R, R1200R	fino 2006		BR011	BR010	€ 105,00	F	6 VITI
R1250R / R1250RS	2019		BR011	BR010	€ 105,00	F	6 VITI
CAGIVA							
MITO 125			DR011	DR010	€ 85,30	F	5 VITI
DUCATI							
1000SS			DR011	DR010	€ 85,30	F	5 VITI
1000DS			DR011	DR010	€ 85,30	F	5 VITI
748			DR011	DR010	€ 85,30	F	5 VITI
916			DR011	DR010	€ 85,30	F	5 VITI
996			DR011	DR010	€ 85,30	F	5 VITI
998			DR011	DR010	€ 85,30	F	5 VITI
900 - ST3			DR011	DR010	€ 85,30	F	5 VITI
1098 - 1198	2007-2012		DF011	DF010	€ 85,30	F	5 VITI
848	2008-2013		DF011	DF010	€ 85,30	F	5 VITI
MONSTER 600-1000			DF011	DF010	€ 85,30	F	5 VITI
620 - 695 - S2R - S4R/S			DF011	DF010	€ 85,30	F	5 VITI
MONSTER 821-1200			DF011	DF010	€ 85,30	F	5 VITI
MONSTER 797			DF011	DF010	€ 85,30	F	5 VITI
SUPER SPORT	2017-2019		DF011	DF010	€ 85,30	F	5 VITI
PANIGALE 1199-1299			DAF011	DAF010	€ 169,90	F	SENZA VITI
PANIGALE 959			DAF011	DAF010	€ 169,90	F	SENZA VITI
PANIGALE V4	2019		DAF011	DAF010	€ 169,90	F	SENZA VITI
HONDA							
CBR600F	1991-2008		HRF011	HRF010	€ 85,30	F	7 VITI
CBR600RR	fino 2013		HRF011	HRF010	€ 85,30	F	7 VITI
CBR1100XX	fino 2011		HRF011	HRF010	€ 85,30	F	7 VITI
CBR1000RR	fino 2014		HRF011	HRF010	€ 85,30	F	7 VITI
CBR900	fino 2003		HRF011	HRF010	€ 85,30	F	7 VITI
VTR(S)(SP)	fino 2008		HRF011	HRF010	€ 85,30	F	7 VITI
VFR 750-800	fino 2013		HRF011	HRF010	€ 85,30	F	7 VITI
NTV 650	fino 2015		HRF011	HRF010	€ 85,30	F	7 VITI
VFR 1200F	fino 2018		HRF011	HRF010	€ 85,30	F	7 VITI
CBR650R	2019		HRF021	HRF020	€ 105,00	F	5 VITI
CBR500R (F)	2016-2019		HRF021	HRF020	€ 105,00	F	5 VITI
CBR1000RR	2016-2019		HRF021	HRF020	€ 105,00	F	5 VITI
VFR800F	2015-2018		HRF021	HRF020	€ 105,00	F	5 VITI
CB500F / CBR500R	2019		HRF021	HRF020	€ 105,00	F	5 VITI
CBR1000RR	2019		HRF021	HRF020	€ 105,00	F	5 VITI

MODELLI	ANNO	NEW	COLORE NERO	COLORE SILVER	PREZZO AL PUBBLICO IVA ESCLUSA	FASCIA	NUMERO VITI
KAWASAKI							
ZX636R	2003-2017		KR011	KR010	€ 85,30	F	5 VITI
ZX6R	2000-2017		KR011	KR010	€ 85,30	F	5 VITI
ZX10R	2003-2019		KR011	KR010	€ 85,30	F	5 VITI
Z1000SX	2016-2019		KR011	KR010	€ 85,30	F	5 VITI
Z1000	2003-2013		KR011	KR010	€ 85,30	F	5 VITI
Z1000	2014-2019	NEW	KR041	KR040	€ 85,30	F	5 VITI
Z750R	2013		KR011	KR010	€ 85,30	F	5 VITI
Z750	2003-2013		KR011	KR010	€ 85,30	F	5 VITI
Z800	2016		KR011	KR010	€ 85,30	F	5 VITI
ZZR1400	2016-2019		KR011	KR010	€ 85,30	F	5 VITI
ER6N-6F	2006-2016		KR011	KR010	€ 85,30	F	5 VITI
NINJA, Z, 250R, SL			KR021	KR020	€ 105,00	F	6 VITI
NINJA 300	fino 2016		KR021	KR020	€ 105,00	F	6 VITI
1400 GTR			KR011	KR010	€ 85,30	F	5 VITI
Z, Ninja 400,650,900, ZX6R	2019	NEW	KR051	KR050	€ 122,96	F	SENZA VITI
KTM							
*RC8R			DAR011	DAR010	€ 169,90	F	SENZA VITI
SUPERDUKE 1290			BR011	BR010	€ 105,00	F	6 VITI
1290 SUPERDUKE GT / R	2019		BR011	BR010	€ 105,00	F	6 VITI
MV AUGUSTA							
F4 750-1000	fino 2009		DR011	DR010	€ 85,30	F	5 VITI
BRUTALE	fino 2009*		DR011	DR010	€ 85,30	F	5 VITI
F4 1000	2016-2018		DAF011	DAF010	€ 169,90	F	SENZA VITI
BRUTALE 1090 RR			DAF011	DAF010	€ 169,90	F	SENZA VITI
BRUTALE 675 / 800	2018		TR011	TR010	€ 105,00	F	6 VITI
RIVALE 800			TR011	TR010	€ 105,00	F	6 VITI
DRAGSTER 800	fino 2019		TR011	TR010	€ 105,00	F	6 VITI
F3 800	2016-2019		TR011	TR010	€ 105,00	F	6 VITI
F3 675			TR011	TR010	€ 105,00	F	6 VITI
SUZUKI							
GSXR600/750	2004-2017		SR011	SR010	€ 85,30	F	5 VITI
GSXR 1000	2004-2018		SR011	SR010	€ 85,30	F	5 VITI
SV 650	2004-2012		SR011	SR010	€ 85,30	F	5 VITI
SV 1000	2004-2012		SR011	SR010	€ 85,30	F	5 VITI
GSXR 150	2018		SR011	SR010	€ 85,30	F	5 VITI
Katana	2019		SF011	SF010	€ 85,30	F	5 VITI
GSX-R 1000	2019		SF011	SF010	€ 85,30	F	5 VITI
INAZUMA			SF011	SF010	€ 85,30	F	5 VITI
GSXR 1000	2003-2004		SF011	SF010	€ 85,30	F	5 VITI
GSF, GSX 650	2005-2017		SF011	SF010	€ 85,30	F	5 VITI
SV 650	2004-2012		SF011	SF010	€ 85,30	F	5 VITI
SV 650X	2018		SF011	SF010	€ 85,30	F	5 VITI
GSR 600	2005-2013		SF011	SF010	€ 85,30	F	5 VITI
GLADIUS	2009-2017		SF011	SF010	€ 85,30	F	5 VITI
HAYABUSA 5 viti			SF011	SF010	€ 85,30	F	5 VITI
GSR 750(Z)	fino 2017		SF011	SF010	€ 85,30	F	5 VITI

MODELLI	ANNO	NEW	COLORE NERO	COLORE SILVER	PREZZO AL PUBBLICO IVA ESCLUSA	FASCIA	NUMERO VITI
GSX-S 750	2017-2019		SF011	SF010	€ 85,30	F	5 VITI
GSX-S 1000 F	2016-2019		SF011	SF010	€ 85,30	F	5 VITI
GSX, BANDIT, 1250 F	2017		SF011	SF010	€ 85,30	F	5 VITI
GSX-S 150			SF011	SF010	€ 85,30	F	5 VITI
GSX 250/300 R	2017-2019		SF011	SF010	€ 85,30	F	5 VITI
GSXR 600/750/1000			SF021	SF020	€ 85,30	F	7 VITI
SV 650/1000			SF021	SF020	€ 85,30	F	7 VITI
BANDIT 650/750			SF021	SF020	€ 85,30	F	7 VITI
HAYABUSA 7 viti			SF021	SF020	€ 85,30	F	7 VITI
B-KING			SK011	SK010	€ 105,00	F	3 VITI
TRIUMPH							FASCIA F
DAYTONA 675	2006-2018		TR011	TR010	€ 105,00	F	6 VITI
STREET TRIPLE	2008-2019		TR011	TR010	€ 105,00	F	6 VITI
SPEED TRIPLE 1050	2008-2019		TR011	TR010	€ 105,00	F	6 VITI
SPRINT ST- GT	2008-2015		TR011	TR010	€ 105,00	F	6 VITI
SPEED FOUR 600	2000-2006		TR011	TR010	€ 105,00	F	6 VITI
DAYTONA 955i	1998-2006		TR011	TR010	€ 105,00	F	6 VITI
YAMAHA							
R1	1998-2014		YR011	YR010	€ 85,30	F	5 VITI
R6	1999-2015		YR011	YR010	€ 85,30	F	5 VITI
R6R	fino 2016		YR011	YR010	€ 85,30	F	5 VITI
YZF-R3	2018	NEW	YR011	YR010	€ 85,30	F	5 VITI
YZF-R3	2019		YR021	YR020	€ 85,30	F	3 VITI
R1	1998-2001		YR021	YR020	€ 85,30	F	7 VITI
R6	1999-2003		YR021	YR020	€ 85,30	F	7 VITI
R1-R1M	2015 - 2018		YR021	YR020	€ 85,30	F	3 VITI
R6	2017-2018		YR021	YR020	€ 85,30	F	3 VITI
FZ6	1998-2011		YF011	YF010	€ 85,30	F	5 VITI
FZ8	2010-2016		YF011	YF010	€ 85,30	F	5 VITI
FZ1	1998-2013		YF011	YF010	€ 85,30	F	5 VITI
MT01	2010		YF011	YF010	€ 85,30	F	5 VITI
MT03	2010		YF011	YF010	€ 85,30	F	5 VITI
MT09 / SP			YF011	YF010	€ 85,30	F	5 VITI
XJ6	2009-2016		YF011	YF010	€ 85,30	F	5 VITI
Niken	2019		YF011	YF010	€ 85,30	F	5 VITI
FZR600,750,1000			YF021	YF020	€ 85,30	F	7 VITI
DIVERSION 600-1000			YF021	YF020	€ 85,30	F	7 VITI
THUNDERACE 1000			YF021	YF020	€ 85,30	F	7 VITI
THUNDERCAT 600			YF021	YF020	€ 85,30	F	7 VITI
MT010	2016-2019		YF021	YF020	€ 85,30	F	3 VITI

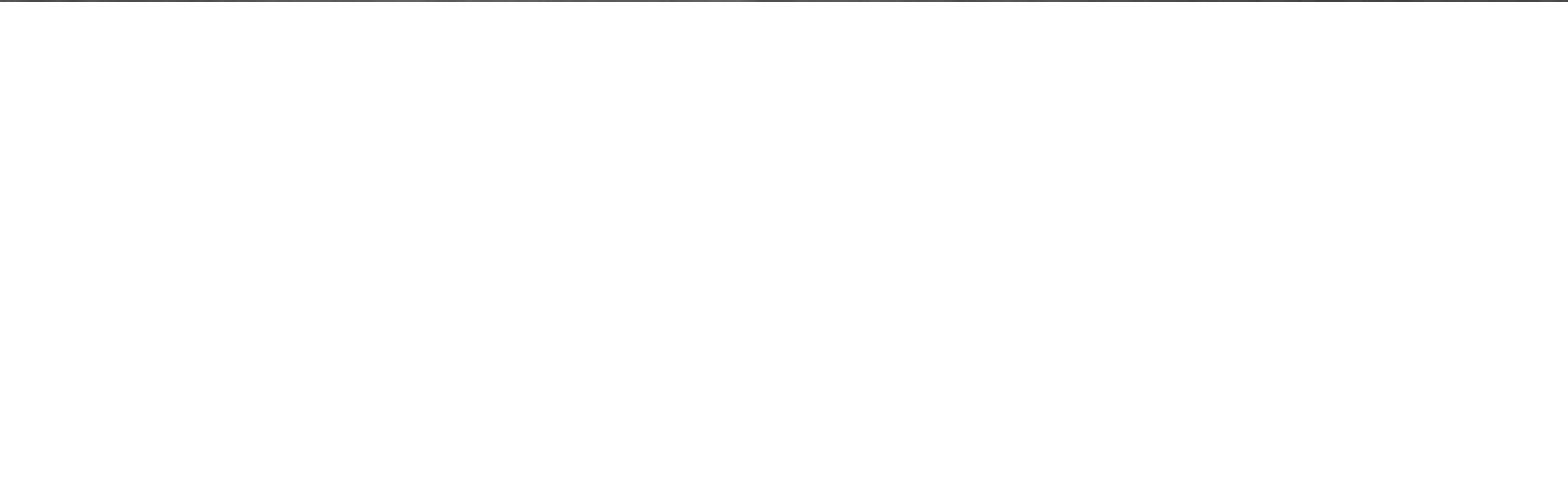



 ***Barkbusters***
HANDGUARDS



EGO



JET



CARBON



STORM



BBZ



VPS

La protezione delle mani negli sport d'azione come il motociclismo è faccenda seria e importante, e non solo per eventuali urti o nel motocross dove le mani sarebbero presto una insensibile massa di terra o fango perdendo la sensibilità sui comandi, ma anche contro il freddo o le condizioni meteo avverse.



Barkbusters è un'azienda australiana focalizzata solo nella produzione di questi componenti: quindi non un accessorio inserito magari all'interno di un catalogo di ricambi ma una vera e propria gamma di protezioni per leve e manopole di tutti i tipi e per tutte le discipline del motociclismo, oltre ovviamente ad un consistente range di accessori specifici.

Varie le forme e diversi i modelli, con una conformazione delle plastiche ben studiata e calibrata per il tipo di servizio cui sono destinate: snelle, agili e coloratissime le **JET** e le **EGO**, destinate ai settori off-road; con linee più grandi e tese e sempre in molti colori le **VPS** e **VPS MX** che proteggono le adventure e maxi enduro; più ampie le **Storm** destinate a coprire dagli agenti atmosferici moto stradali e scooter; intriganti le **Carbon** riservate alle street naked, ovviamente costruite in fibra di carbonio rivestita di strato lucido trasparente; a prova di nubifragio le **BBZ**, dotate di tasca con membrana impermeabile, destinate ai grandi viaggi o all'uso in zone particolarmente piovose o fredde.

RICHIEDI IL CATALOGO CARTACEO O SCARICA IL FILE COMPLETO ALLA SEZIONE DOWNLOAD DEL SITO WWW.FORBIKES.IT

AERO-GP

FASCIA
€ 99,90 E

Barkbusters presenta le protezioni leva Aero-GP: robuste, aerodinamiche e progettate sia per moto stradali che da pista. Concepite pensando alla sicurezza e, allo stesso tempo, create per completare l'estetica delle moto.

Le protezioni leva sono pensate per fornire la necessaria protezione per prevenire l'attivazione accidentale della leva del freno o della frizione durante le corse ravvicinate in pista. La stessa sicurezza che è essenziale su una moto da strada, per chi guida in grandi gruppi, spazi ristretti e durante il cambio della corsia su strade urbane congestionate.

L'Aero-GP è compatibile con la maggior parte delle marche e modelli, comprese le moto sportive, touring e gli scooter.

Caratteristiche principali:

- design innovativo con struttura in nylon ad alta tecnologia
- comprende un componente elegante e funzionale che può essere montato per una maggior protezione dal vento o rimosso velocemente per uno stile sportivo e compatto
- regolabile per adattarsi perfettamente alla moto
- include coppia sinistra/destra







CLICK'N'RIDE[®]
QUICK RELEASE MOTORCYCLE TURN INDICATORS



Paura dei ladri in agguato?
Le frecce CLICK N' RIDE sono
inutilizzabili senza la loro specifica presa!
Mai più frecce distrutte!



**INDICATORI DI DIREZIONE RIMOVIBILI:
UN SEMPLICE CLICK PER MONTARLE E UN SEMPLICE CLICK PER SMONTARLE!**

Forbikes porta in Italia gli indicatori di direzione rimovibili CLICK N' RIDE: una vera e propria innovazione per gli amanti dell'off-road e dei giri in pista!

Grazie al sistema di sgancio rapido è possibile montare e smontare le frecce all'occorrenza con un semplice click. Quando le frecce vengono rimosse possono essere riposte nella comodissima confezione Roll Up per il trasporto, mentre la parte di attacco è protetta da polvere, fango e acqua grazie al nuovo sistema Moisture Guard.

Gli indicatori di direzione CLICK N' RIDE sono realizzati con materiali di alta qualità per una durata estrema. I LED Philips garantiscono un'alta luminosità, un colore dell'ambra stabile e una durata fino a 50.000 ore. Ogni parte è fissata saldamente per reggere gli ambienti più ostili e non hanno parti mobili o che possano deteriorarsi. In più per assicurarne l'omologazione su strada sono stati sottoposti a rigidi test secondo la normativa UNECE R50.

Mai più frecce distrutte!



KIT 2PZ.FRECCHE ATTACCO/SGANCIO RAPIDO CLICK N'RIDE	FASCIA D
CNR-4202	€ 57,34



KIT 4PZ.FRECCHE ATTACCO/SGANCIO RAPIDO CLICK N'RIDE	FASCIA D
CNR-4204	€ 113,89



FRECCIA A RICAMBIO	FASCIA D
CNR-4205-L SINISTRA POSTERIORE / DESTRA ANTERIORE	€ 18,81
CNR-4205-R DESTRA POSTERIORE / SINISTRA ANTERIORE	€ 18,81



PRESA UNIVERSALE A RICAMBIO	FASCIA D
CNR-4206	€ 12,25



CP.RESISTENZE A LED	FASCIA D
CNR-4207	€ 7,34



CONFEZIONE ROLL UP PER TRASPORTO	FASCIA D
CNR-4208	€ 9,75

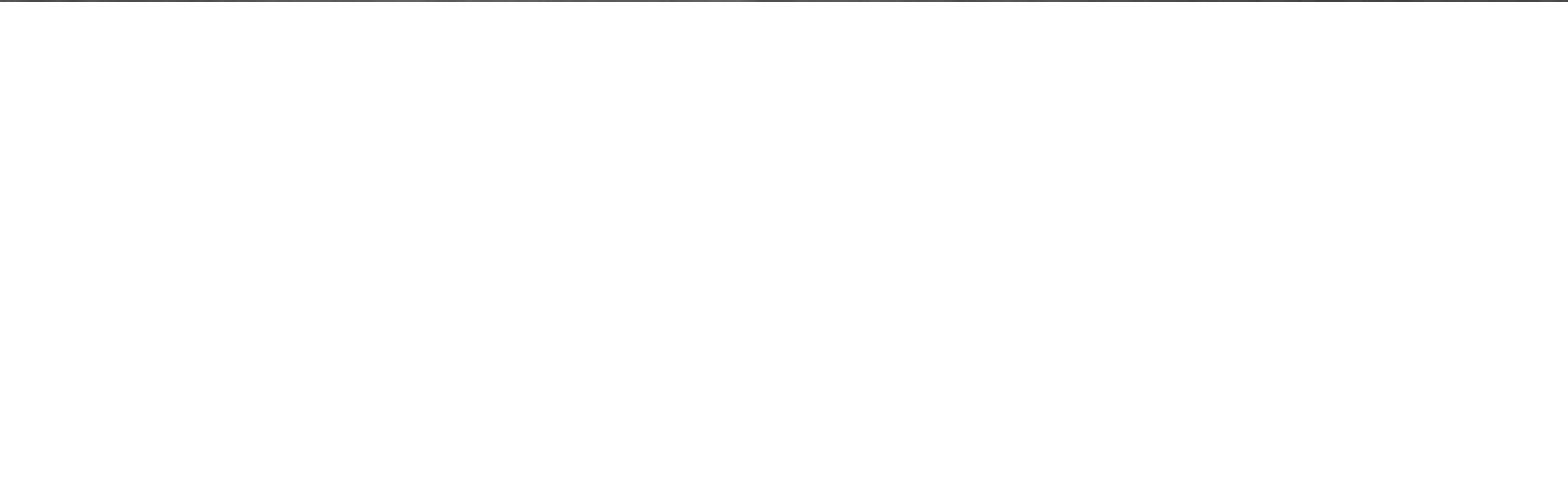



DAYTONA



LE PROPOSTE DELLA CASA GIAPPONESE PER EQUIPAGGIARE AL MEGLIO LA MOTO

DAYTONA JAPAN è stata fondata nel 1972 e da sempre si è prefissata come obiettivo di realizzare prodotti particolari seguendo le richieste dei motociclisti e soprattutto cercando di soddisfare al meglio le loro necessità.

Il team di ricerca e sviluppo di DAYTONA è un gruppo di ragazzi entusiasti che cerca sempre di creare articoli di alta qualità e sempre alla ricerca di novità da realizzare.

La gamma di articoli DAYTONA a catalogo comprende diverse categorie di prodotti, in particolare strumentazioni di alto livello e finiture, fanaleria, indicatori di direzione, specchi di ottima qualità e veramente unici per il loro design, accessori di utilizzo universale che sono di supporto nell'ordinario utilizzo del motociclo come pure articoli in CNC con finiture, doppie anodizzazioni e colorazioni mozzafiato.

**RICHIEDI IL CATALOGO CARTACEO O SCARICA IL FILE COMPLETO
ALLA SEZIONE DOWNLOAD DEL SITO WWW.FORBIKES.IT**



87383



87386



E-MARKED

87389

TACHIMETRO ANALOGICO ELETTRONICO VELONA NERO, SFONDO 3 COLORI INTERCAMBIABILI (BLU-BIANCO-ARANCIO), CON STAFFA

FASCIA E

87383	DIAMETRO 48 mm, 140 KMH	€ 98,32
87386	DIAMETRO 48 mm, 200 KMH	€ 98,32
87389	DIAMETRO 48 mm, 260 KMH	€ 98,32



87395

87392

CONTAGIRI ANALOGICO ELETTRONICO VELONA, SFONDO 3 COLORI INTERCAMBIABILI (BLU-BIANCO-ARANCIO), CON STAFFA

FASCIA E

87392	DIAMETRO 48 mm, 9000 RPM	€ 98,32
87395	DIAMETRO 48 mm, 15000 RPM	€ 98,32



87768

87785

STAFFA PER SUPPORTO STRUMENTO VELONA E MICRO LED INDICATOR

FASCIA E

87768	DIAMETRO 48 mm, NERO	€ 20,45
87785	DIAMETRO 48 mm, DOPPIO NERO	€ 20,45



88644



88645



88677

CONTAGIRI ANALOGICO ELETTRONICO VELONA, CON INDICATORE DI CAMBIO MARCIA E STAFFA

FASCIA E

88644	DIAMETRO 60 mm, 9000 RPM	€ 114,71
88645	DIAMETRO 60 mm, 15000 RPM	€ 114,71
88677	DIAMETRO 60 mm, 15000 RPM	€ 114,71



85835



86864



87527



85834



86862

CONTAGIRI ANALOGICO ELETTRONICO VELONA, CON STAFFA

FASCIA
E

85835	DIAMETRO 60 mm, 8000 RPM	€ 90,12
86864	DIAMETRO 60 mm, 8000 RPM, NERO	€ 90,12
87527	DIAMETRO 60 mm, 15000 RPM, NERO	€ 90,12
85834	DIAMETRO 60 mm, 18000 RPM	€ 90,12
86862	DIAMETRO 60 mm, 18000 RPM, NERO	€ 90,12



85833



86863



86267



86861

E-MARKED

TACHIMETRO ANALOGICO ELETTRONICO VELONA CON STAFFA

FASCIA
E

85833	DIAMETRO 60 mm, 200 KM/H	€ 90,12
86863	DIAMETRO 60 mm, 200 KM/H, NERO	€ 90,12
86267	DIAMETRO 60 mm, 260 KM/H	€ 90,12
86861	DIAMETRO 60 mm, 260 KM/H, NERO	€ 90,12



88641



88642



88643

E-MARKED

TACHIMETRO ANALOGICO ELETTRONICO VELONA CON SPIE E STAFFA

FASCIA
E

88641	DIAMETRO 60 mm, 140 KMH	€ 131,11
88642	DIAMETRO 60 mm, 200 KMH	€ 131,11
88643	DIAMETRO 60 mm, 260 KMH	€ 131,11



E-MARKED

STRUMENTO ROUND DIGITAL VELONA CON STAFFA, NERO

FASCIA
E

85836	DIAMETRO 60 mm	€ 106,52
-------	----------------	----------



87403



87404

STAFFA PER SUPPORTO STRUMENTO VELONA E MICRO LED INDICATOR

FASCIA
E

87403	DIA.60 mm, LUCIDO	€ 20,45
87404	DIA.60 mm, NERO	€ 20,45



61197

63526

63528

63527

63529

SUPPORTO ANTI-VIBRAZIONE PER VELONA 60

FASCIA
E

61197	CENTRALE/PIEGATO 10°	€ 16,35
63526	CENTRALE	€ 16,35
63527	SINISTRO OFFSET/PIEGATO 10°	€ 16,35
63528	DESTRO OFFSET/PIEGATO 10°	€ 16,35
63529	DESTRO OFSSET	€ 16,35



KIT CORNICE ALLUMINIO CNC PER STRUMENTI SERIE VELONA

FASCIA E

85819 CROMATO € 28,65



87792

CONTAGIRI ANALOGICO ELETTRONICO VELONA + SPD IN LCD, CON STAFFA

87793



87792 DIAMETRO 80 mm, 9000 RPM

FASCIA E

€ 154,06

87793 DIAMETRO 80 mm, 15000 RPM

€ 154,06



87789



87790

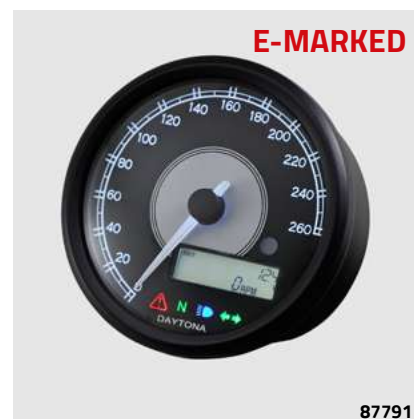

87791

TACHIMETRO ANALOGICO ELETTRONICO VELONA + RPM IN LCD, CON STAFFA

FASCIA E

87789 DIAMETRO 80 mm, 140 KMH

€ 154,06

87790 DIAMETRO 80 mm, 200 KMH

€ 154,06

87791 DIAMETRO 80 mm, 260 KMH

€ 154,06



TACHIMETRO ANALOGICO ELETTRONICO VELONA C/INDICATORE VELOCITÀ ELETTRICO CON STAFFA

FASCIA E

89364 DIAMETRO 80 mm, 200 KMH € 188,48



CONTAGIRI DIGITALE COMPATTO NANO2 TACH

FASCIA E

86719 20000 RPM € 90,12



CONTAGIRI DIGITALE COMPATTO NANO TACH

FASCIA E

85996 20000 RPM € 40,94



**CONTAMARCE DIGITALE
NANO2 GEAR**

FASCIA
E

86553

€ 90,12



**TACHIMETRO DIGITALE COMPATTO
NANO2 SPD**

FASCIA
E

86596 399 KM/H

€ 90,12



**TACHIMETRO DIGITALE COMPATTO
NANO-SPD**

FASCIA
E

85998 300 KM/H

€ 40,94



**TERMOMETRO DIGITALE
OIL/AIR COMPATTO NANO TEMP**

FASCIA
E

85995 NANO TEMP

€ 40,94



STRUMENTAZIONE MULTI-FUNZIONE MOD.ASURA

FASCIA
E

84787 NERO

€ 114,71

84580 SILVER

€ 114,71

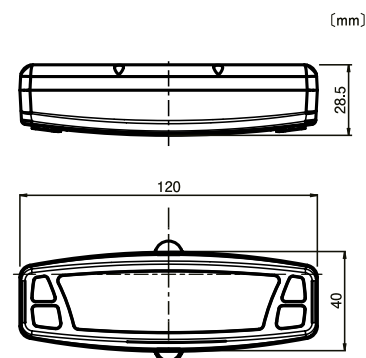

STRUMENTAZIONE MULTIFUNZIONE DIGITALE DEVA

FASCIA
E

89363 132x58x25 mm.

€ 204,88



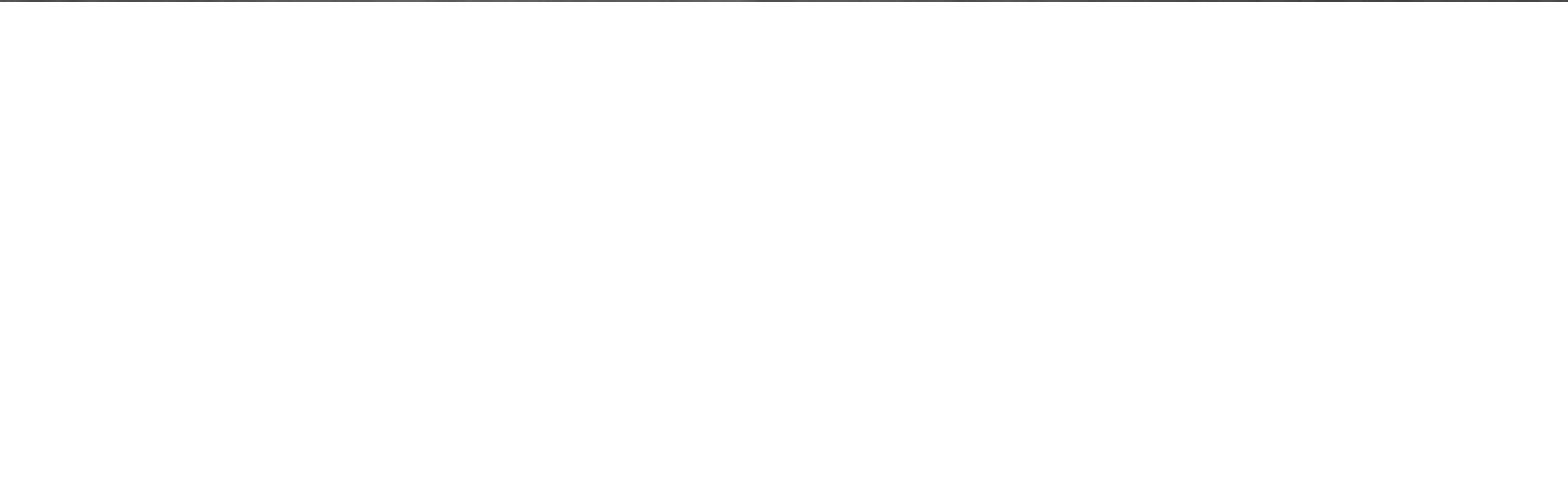



E EAZI-GRIP™
TANK GRIP PERFORMANCE



**PROTEZIONI LATERALI SERBATOIO,
GIÀ UTILIZZATE DA DIVERSI TEAM
IN BSB E SUPERSPORT**





EVO SERIES
bolle grandi e distanziate



PRO SERIES
bolle piccole e ravvicinate



SILICONE SERIES
nessuna bolla, silicone colore nero

MODELLO	ANNO	EVO SERIES			PRO SERIES			SILICONE SERIES	
		COD. COLORE TRASPARENTE	COD. COLORE NERO	PREZZO IVA ESCLUSA	COD. COLORE TRASPARENTE	CODICE NERO	PREZZO IVA ESCLUSA	COD. SILICONE NERO	PREZZO IVA ESCLUSA
APRILIA									
FASCIA E									
RSV1000	2004-2010	EVO001CL	EVO001BL	€ 28,50	PRO001CL	PRO001BL	€ 28,50	SIL001BL	€ 32,00
RSV4	2008-	EVO002CL	EVO002BL	€ 33,00	PRO002CL	PRO002BL	€ 33,00	SIL002BL	€ 36,70
TUONO	2006-2010	EVO003CL	EVO003BL	€ 28,50	PRO003CL	PRO003BL	€ 28,50	SIL003BL	€ 32,00
TUONO V4	2011-	EVO004CL	EVO004BL	€ 33,00	PRO004CL	PRO004BL	€ 33,00	SIL004BL	€ 36,70
RS4 125 / TUONO 125	2011-	EVO005CL	EVO005BL	€ 28,50	PRO005CL	PRO005BL	€ 28,50	SIL005BL	€ 32,00
CAPONORD 1200 / 1200 RALLY	2013-	EVO007CL	EVO007BL	€ 33,00	PRO007CL	PRO007BL	€ 33,00	SIL007BL	€ 36,70
SHIVER	2017	EVO008CL	EVO008BL	€ 28,50	PRO008CL	PRO008BL	€ 28,50	SIL008BL	€ 32,00
BMW									
FASCIA E									
K1200S/K1300S	2005-2016	EVO100CL	EVO100BL	€ 28,50	PRO100CL	PRO100BL	€ 28,50	SIL100BL	€ 32,00
K1200R/K1300R	2005-2015	EVO102CL	EVO102BL	€ 28,50	PRO102CL	PRO102BL	€ 28,50	SIL102BL	€ 32,00
S1000R/RR	2009-2013	EVO104CL	EVO104BL	€ 33,00	PRO104CL	PRO104BL	€ 33,00	SIL104BL	€ 36,70
S1000R/RR	2014	EVO105CL	EVO105BL	€ 28,50	PRO105CL	PRO105BL	€ 28,50	SIL105BL	€ 32,00
F800ST	2006-2013	EVO106CL	EVO106BL	€ 28,50	PRO106CL	PRO106BL	€ 28,50	SIL106BL	€ 32,00
R1200GS/ R1300GS	2004-2012	EVO107CL	EVO107BL	€ 28,50	PRO107CL	PRO107BL	€ 28,50	SIL107BL	€ 32,00
S1000R/RR NEW	2015-2018	EVO108CL	EVO108BL	€ 28,50	PRO108CL	PRO108BL	€ 28,50	SIL108BL	€ 32,00
R1200RS	2015-	EVO109CL	EVO109BL	€ 28,50	PRO109CL	PRO109BL	€ 28,50	SIL109BL	€ 32,00
S1000XR	2015-	EVO110CL	EVO110BL	€ 47,50	PRO110CL	PRO110BL	€ 47,50	SIL110BL	€ 45,82
F800GS	2015-2017	EVO111CL	EVO111BL	€ 28,50	PRO111CL	PRO111BL	€ 28,50	SIL111BL	€ 32,00
1600GTLE	2011-2016	EVO112CL	EVO112BL	€ 28,50	PRO112CL	PRO112BL	€ 28,50	SIL112BL	€ 32,00
R9T	2014-	EVO113CL	EVO113BL	€ 28,50	PRO113CL	PRO113BL	€ 28,50	SIL113BL	€ 32,00
R1200RT	2014-	EVO114CL	EVO114BL	€ 33,00	PRO114CL	PRO114BL	€ 33,00	SIL114BL	€ 36,70
F800R	2009-	EVO115CL	EVO115BL	€ 28,50	PRO115CL	PRO115BL	€ 28,50	SIL115BL	€ 32,00
R1200GS RALLYE	2017-	EVO116CL	EVO116BL	€ 33,00	PRO116CL	PRO116BL	€ 33,00	SIL116BL	€ 36,70
R1200GS ADVENTURE	2014-	EVO117CL	EVO117BL	€ 33,00	PRO117CL	PRO117BL	€ 33,00	SIL117BL	€ 36,70
R1200R/SPORT	2015-	EVO118CL	EVO118BL	€ 28,50	PRO118CL	PRO118BL	€ 28,50	SIL118BL	€ 32,00
R1200GS	2013-	EVO119CL	EVO119BL	€ 47,50	PRO119CL	PRO119BL	€ 47,50	SIL119BL	€ 45,82
G 310R	2016-	EVO120CL	EVO120BL	€ 33,00	PRO120CL	PRO120BL	€ 33,00	SIL120BL	€ 36,70
F750/850GS	2018	EVO121CL	EVO121BL	€ 28,50	PRO121CL	PRO121BL	€ 28,50	SIL121BL	€ 32,00
G310GS	2018	EVO122CL	EVO122BL	€ 28,50	PRO122CL	PRO122BL	€ 28,50	SIL122BL	€ 32,00
S1000RR NEW	2019	EVO123CL	EVO123BL	€ 28,50	PRO123CL	PRO123BL	€ 28,50	SIL123BL	€ 32,00

MODELLO	ANNO	EVO SERIES			PRO SERIES			SILICONE SERIES	
		COD. COLORE TRASPARENTE	COD. COLORE NERO	PREZZO IVA ESCLUSA	COD. COLORE TRASPARENTE	CODICE NERO	PREZZO IVA ESCLUSA	COD. SILICONE NERO	PREZZO IVA ESCLUSA
DUCATI									FASCIA E
748/916/996/998	1994-2004	EVO200CL	EVO200BL	€ 28,50	PRO200CL	PRO200BL	€ 28,50	SIL200BL	€ 32,00
848EVO/ 848SF/1098/1198	2007-2016	EVO204CL	EVO204BL	€ 33,00	PRO204CL	PRO204BL	€ 33,00	SIL204BL	€ 36,70
899/959/1199/1299 PANIGALE	2011-2017	EVO206CL	EVO206BL	€ 33,00	PRO206CL	PRO206BL	€ 33,00	SIL206BL	€ 36,70
749/999	2003-2006	EVO209CL	EVO209BL	€ 28,50	PRO209CL	PRO209BL	€ 28,50	SIL209BL	€ 32,00
1200S/ST MULTI- STRADA	2010-2014	EVO211CL	EVO211BL	€ 28,50	PRO211CL	PRO211BL	€ 28,50	SIL211BL	€ 32,00
695/696/796/ 1100EVO MONSTER	2010-2014	EVO213CL	EVO213BL	€ 28,50	PRO213CL	PRO213BL	€ 28,50	SIL213BL	€ 32,00
821/1200/1200S MONSTER	2014-	EVO216CL	EVO216BL	€ 33,00	PRO216CL	PRO216BL	€ 33,00	SIL216BL	€ 36,70
HYPERSTRADA/ HYPERMOTARD SP	2013-	EVO217CL	EVO217BL	€ 28,50	PRO217CL	PRO217BL	€ 28,50	SIL217BL	€ 32,00
DIAVEL	2011-	EVO219CL	EVO219BL	€ 28,50	PRO219CL	PRO219BL	€ 28,50	SIL219BL	€ 32,00
1200S/1260S MULTISTRADA	2015-	EVO220CL	EVO220BL	€ 33,00	PRO220CL	PRO220BL	€ 33,00	SIL220BL	€ 36,70
SUPERSPORT	2017-	EVO221CL	EVO221BL	€ 28,50	PRO221CL	PRO221BL	€ 28,50	SIL221BL	€ 32,00
950 MULTISTRADA	2017-	EVO222CL	EVO222BL	€ 33,00	PRO222CL	PRO222BL	€ 33,00	SIL222BL	€ 36,70
PANIGALE V4	2018	EVO223CL	EVO223BL	€ 33,00	PRO223CL	PRO223BL	€ 33,00	SIL223BL	€ 36,70
HONDA									FASCIA E
CBR250R (MC41)	2011-2013	EVO300CL	EVO300BL	€ 28,50	PRO300CL	PRO300BL	€ 28,50	SIL300BL	€ 32,00
CBR600RR STEEL FRAMED	1987-1998	EVO301CL	EVO301BL	€ 28,50	PRO301CL	PRO301BL	€ 28,50	SIL301BL	€ 32,00
CBR600 F4i	2001-2006	EVO302CL	EVO302BL	€ 28,50	PRO302CL	PRO302BL	€ 28,50	SIL302BL	€ 32,00
CBR600F new design	2011-2016	EVO303CL	EVO303BL	€ 28,50	PRO303CL	PRO303BL	€ 28,50	SIL303BL	€ 32,00
CBR600RR	2003-2006	EVO304CL	EVO304BL	€ 28,50	PRO304CL	PRO304BL	€ 28,50	SIL304BL	€ 32,00
CBR600RR	2007-2012	EVO305CL	EVO305BL	€ 28,50	PRO305CL	PRO305BL	€ 28,50	SIL305BL	€ 32,00
CBR600RR	2013-2017	EVO306CL	EVO306BL	€ 28,50	PRO306CL	PRO306BL	€ 28,50	SIL306BL	€ 32,00
CBR1000RR	2004-2007	EVO307CL	EVO307BL	€ 28,50	PRO307CL	PRO307BL	€ 28,50	SIL307BL	€ 32,00
CBR1000RR - ROAD	2008-2011	EVO308CL	EVO308BL	€ 28,50	PRO308CL	PRO308BL	€ 28,50	SIL308BL	€ 32,00
CBR1000RR - RACE	2008-2011	EVO309CL	EVO309BL	€ 33,00	PRO309CL	PRO309BL	€ 33,00	SIL309BL	€ 36,70
CBR1000RR - ROAD	2012-2016	EVO310CL	EVO310BL	€ 28,50	PRO310CL	PRO310BL	€ 28,50	SIL310BL	€ 32,00
CBR1000RR - RACE	2012-2016	EVO311CL	EVO311BL	€ 33,00	PRO311CL	PRO311BL	€ 33,00	SIL311BL	€ 36,70
VTR1000	2001-2006	EVO312CL	EVO312BL	€ 28,50	PRO312CL	PRO312BL	€ 28,50	SIL312BL	€ 32,00
VFR800	2002-2013	EVO313CL	EVO313BL	€ 28,50	PRO313CL	PRO313BL	€ 28,50	SIL313BL	€ 32,00
VFR800	2014-	EVO314CL	EVO314BL	€ 28,50	PRO314CL	PRO314BL	€ 28,50	SIL314BL	€ 32,00
PAN EUROPEAN (ST1300)	2002-	EVO315CL	EVO315BL	€ 28,50	PRO315CL	PRO315BL	€ 28,50	SIL315BL	€ 32,00
CBR1100xx (BLACKBIRD)	1997-2007	EVO316CL	EVO316BL	€ 28,50	PRO316CL	PRO316BL	€ 28,50	SIL316BL	€ 32,00
NC700X	2013-2016	EVO317CL	EVO317BL	€ 28,50	PRO317CL	PRO317BL	€ 28,50	SIL317BL	€ 32,00
NC700S	2013-2016	EVO318CL	EVO318BL	€ 28,50	PRO318CL	PRO318BL	€ 28,50	SIL318BL	€ 32,00
CBR500R	2013-	EVO319CL	EVO319BL	€ 28,50	PRO319CL	PRO319BL	€ 28,50	SIL319BL	€ 32,00
CB500F	2013-	EVO320CL	EVO320BL	€ 28,50	PRO320CL	PRO320BL	€ 28,50	SIL320BL	€ 32,00
CBR900	1992-1999	EVO321CL	EVO321BL	€ 28,50	PRO321CL	PRO321BL	€ 28,50	SIL321BL	€ 32,00
CBR900	2000-2001	EVO322CL	EVO322BL	€ 28,50	PRO322CL	PRO322BL	€ 28,50	SIL322BL	€ 32,00
CB900 HORNET	2002-2007	EVO323CL	EVO323BL	€ 28,50	PRO323CL	PRO323BL	€ 28,50	SIL323BL	€ 32,00
CBR300	2014-2016	EVO324CL	EVO324BL	€ 33,00	PRO324CL	PRO324BL	€ 33,00	SIL324BL	€ 36,70
CBR650RR/F	2015-	EVO325CL	EVO325BL	€ 28,50	PRO325CL	PRO325BL	€ 28,50	SIL325BL	€ 32,00
NC750X	2016-2017	EVO327CL	EVO327BL	€ 33,00	PRO327CL	PRO327BL	€ 33,00	SIL327BL	€ 36,70
VFR800X CROSSRUN- NER	2015-2017	EVO328CL	EVO328BL	€ 28,50	PRO328CL	PRO328BL	€ 28,50	SIL328BL	€ 32,00
CRF1000L AFRICA TWIN	2015-2017	EVO329CL	EVO329BL	€ 33,00	PRO329CL	PRO329BL	€ 33,00	SIL329BL	€ 36,70
CBR1000RR	2017-	EVO330CL	EVO330BL	€ 33,00	PRO330CL	PRO330BL	€ 33,00	SIL330BL	€ 36,70

MODELLO	ANNO	EVO SERIES			PRO SERIES			SILICONE SERIES	
		COD. COLORE TRASPARENTE	COD. COLORE NERO	PREZZO IVA ESCLUSA	COD. COLORE TRASPARENTE	CODICE NERO	PREZZO IVA ESCLUSA	COD. SILICONE NERO	PREZZO IVA ESCLUSA
CBR250RR	2017-	EVO331CL	EVO331BL	€ 28,50	PRO331CL	PRO331BL	€ 28,50	SIL331BL	€ 32,00
CRF1000L AFRICA TWIN ADVENTURE SPORT	2018	EVO332CL	EVO332BL	€ 33,00	PRO332CL	PRO332BL	€ 33,00	SIL332BL	€ 36,70
CB125R	2018	EVO333CL	EVO333BL	€ 33,00	PRO333CL	PRO333BL	€ 33,00	SIL333BL	€ 36,70
CBR125R	2011-	EVO334CL	EVO334BL	€ 28,50	PRO334CL	PRO334BL	€ 28,50	SIL334BL	€ 32,00
CB1100EX	2017-	EVO335CL	EVO335BL	€ 33,00	PRO335CL	PRO335BL	€ 33,00	SIL335BL	€ 36,70
CB1000R	2018	EVO336CL	EVO336BL	€ 28,50	PRO336CL	PRO336BL	€ 28,50	SIL336BL	€ 32,00
CB125F	2018	EVO337CL	EVO337BL	€ 33,00	PRO337CL	PRO337BL	€ 33,00	SIL337BL	€ 36,70
CB1100S	2013-2016	EVO338CL	EVO338BL	€ 33,00	PRO338CL	PRO338BL	€ 33,00	SIL338BL	€ 36,70
MONKEY NEW	2018	EVO339CL	EVO339BL	€ 28,50	PRO339CL	PRO339BL	€ 28,50	SIL339BL	€ 32,00
CB300R	2018	EVO340CL	EVO340BL	€ 33,00	PRO340CL	PRO340BL	€ 33,00	SIL340BL	€ 36,70
CB650R	2019	EVO341CL	EVO341BL	€ 28,50	PRO341CL	PRO341BL	€ 28,50	SIL341BL	€ 32,00
CBR500RR	2019	EVO342CL	EVO342BL	€ 28,50	PRO342CL	PRO342BL	€ 28,50	SIL342BL	€ 32,00
HUSQVARNA									FASCIA E
FS450	2015-2016	EVOHUS001CL	EVOHUS001BL	€ 28,50	PROHUS001CL	PROHUS001BL	€ 28,50	SILHUS001BL	€ 32,00
KAWASAKI									FASCIA E
NINJA 250	2008-2012	EVO400CL	EVO400BL	€ 33,00	PRO400CL	PRO400BL	€ 33,00	SIL400BL	€ 36,70
NINJA 250SL/Z250SL new design	2014-	EVO401CL	EVO401BL	€ 33,00	PRO401CL	PRO401BL	€ 33,00	SIL401BL	€ 36,70
NINJA300	2013-	EVO402CL	EVO402BL	€ 28,50	PRO402CL	PRO402BL	€ 28,50	SIL402BL	€ 32,00
ZX6R	1995-1997	EVO403CL	EVO403BL	€ 28,50	PRO403CL	PRO403BL	€ 28,50	SIL403BL	€ 32,00
ZX6R	2000-2002	EVO404CL	EVO404BL	€ 28,50	PRO404CL	PRO404BL	€ 28,50	SIL404BL	€ 32,00
ZX6R(636)	2003-2004	EVO405CL	EVO405BL	€ 28,50	PRO405CL	PRO405BL	€ 28,50	SIL405BL	€ 32,00
ZX6R	2007-2008	EVO406CL	EVO406BL	€ 33,00	PRO406CL	PRO406BL	€ 33,00	SIL406BL	€ 36,70
ZX6R	2009-2012	EVO407CL	EVO407BL	€ 28,50	PRO407CL	PRO407BL	€ 28,50	SIL407BL	€ 32,00
ZX6R(636)	2013-2016	EVO408CL	EVO408BL	€ 33,00	PRO408CL	PRO408BL	€ 33,00	SIL408BL	€ 36,70
ZX10R	2004-2005	EVO409CL	EVO409BL	€ 28,50	PRO409CL	PRO409BL	€ 28,50	SIL409BL	€ 32,00
ZX10R	2008-2010	EVO410CL	EVO410BL	€ 33,00	PRO410CL	PRO410BL	€ 33,00	SIL410BL	€ 36,70
ZX10R	2011-2015	EVO411CL	EVO411BL	€ 33,00	PRO411CL	PRO411BL	€ 33,00	SIL411BL	€ 36,70
ZX12R	2000-2006	EVO412CL	EVO412BL	€ 28,50	PRO412CL	PRO412BL	€ 28,50	SIL412BL	€ 32,00
Z750	2007-2012	EVO413CL	EVO413BL	€ 28,50	PRO413CL	PRO413BL	€ 28,50	SIL413BL	€ 32,00
Z800	2013-2016	EVO414CL	EVO414BL	€ 28,50	PRO414CL	PRO414BL	€ 28,50	SIL414BL	€ 32,00
ER650F/N	2006-2011	EVO415CL	EVO415BL	€ 33,00	PRO415CL	PRO415BL	€ 33,00	SIL415BL	€ 36,70
Z1000	2003-2006	EVO416CL	EVO416BL	€ 28,50	PRO416CL	PRO416BL	€ 28,50	SIL416BL	€ 32,00
Z1000	2010-2013	EVO417CL	EVO417BL	€ 33,00	PRO417CL	PRO417BL	€ 33,00	SIL417BL	€ 36,70
Z1000SX	2012-	EVO418CL	EVO418BL	€ 28,50	PRO418CL	PRO418BL	€ 28,50	SIL418BL	€ 32,00
Z1000	2014-	EVO419CL	EVO419BL	€ 33,00	PRO419CL	PRO419BL	€ 33,00	SIL419BL	€ 36,70
NINJA H2/H2R	2015-	EVO420CL	EVO420BL	€ 28,50	PRO420CL	PRO420BL	€ 28,50	SIL420BL	€ 32,00
ZZR1400	2012-	EVO421CL	EVO421BL	€ 33,00	PRO421CL	PRO421BL	€ 33,00	SIL421BL	€ 36,70
VERSYS 650	2015-	EVO422CL	EVO422BL	€ 33,00	PRO422CL	PRO422BL	€ 33,00	SIL422BL	€ 36,70
VERSYS 1000	2015-	EVO423CL	EVO423BL	€ 33,00	PRO423CL	PRO423BL	€ 33,00	SIL423BL	€ 36,70
ZX10R	2016-	EVO424CL	EVO424BL	€ 33,00	PRO424CL	PRO424BL	€ 33,00	SIL424BL	€ 36,70
Z125	2016-	EVO425CL	EVO425BL	€ 28,50	PRO425CL	PRO425BL	€ 28,50	SIL425BL	€ 32,00
Z650/NINJA 650	2017-	EVO426CL	EVO426BL	€ 28,50	PRO426CL	PRO426BL	€ 28,50	SIL426BL	€ 32,00
Z1000	2007-2009	EVO427CL	EVO427BL	€ 28,50	PRO427CL	PRO427BL	€ 28,50	SIL427BL	€ 32,00
Z900	2017-	EVO428CL	EVO428BL	€ 28,50	PRO428CL	PRO428BL	€ 28,50	SIL428BL	€ 32,00
ER-6F/N	2012-2016	EVO429CL	EVO429BL	€ 28,50	PRO429CL	PRO429BL	€ 28,50	SIL429BL	€ 32,00
ZX6R	2005-2006	EVO430CL	EVO430BL	€ 28,50	PRO430CL	PRO430BL	€ 28,50	SIL430BL	€ 32,00
VERSYS-X 300	2017-	EVO431CL	EVO431BL	€ 28,50	PRO431CL	PRO431BL	€ 28,50	SIL431BL	€ 32,00
NINJA 400	2018	EVO432CL	EVO432BL	€ 28,50	PRO432CL	PRO432BL	€ 28,50	SIL432BL	€ 32,00
Z900RS	2018	EVO433CL	EVO433BL	€ 28,50	PRO433CL	PRO433BL	€ 28,50	SIL433BL	€ 32,00

MODELLO	ANNO	EVO SERIES			PRO SERIES			SILICONE SERIES	
		COD. COLORE TRASPARENTE	COD. COLORE NERO	PREZZO IVA ESCLUSA	COD. COLORE TRASPARENTE	CODICE NERO	PREZZO IVA ESCLUSA	COD. SILICONE NERO	PREZZO IVA ESCLUSA
H2 SX / SX SE	2018	EVO434CL	EVO434BL	€ 28,50	PRO434CL	PRO434BL	€ 28,50	SIL434BL	€ 32,00
VERSYS 1000	2019	EVO435CL	EVO435BL	€ 33,00	PRO435CL	PRO435BL	€ 33,00	SIL435BL	€ 36,70
Z125	2019	EVO436CL	EVO436BL	€ 28,50	PRO436CL	PRO436BL	€ 28,50	SIL436BL	€ 32,00
ZX6R 636	2019	EVO437CL	EVO437BL	€ 33,00	PRO437CL	PRO437BL	€ 33,00	SIL437BL	€ 36,70
KTM									FASCIA E
1090/1190/1290 ADVENTURE	2013-	EVO500CL	EVO500BL	€ 33,00	PRO500CL	PRO500BL	€ 33,00	SIL500BL	€ 36,70
125/200/390 DUKE	2011-2016	EVO501CL	EVO501BL	€ 33,00	PRO501CL	PRO501BL	€ 33,00	SIL501BL	€ 36,70
690 DUKE	2012-	EVO504CL	EVO504BL	€ 28,50	PRO504CL	PRO504BL	€ 28,50	SIL504BL	€ 32,00
990 SUPER DUKE R	2005-2013	EVO505CL	EVO505BL	€ 33,00	PRO505CL	PRO505BL	€ 33,00	SIL505BL	€ 36,70
RC8	2009-2016	EVO506CL	EVO506BL	€ 28,50	PRO506CL	PRO506BL	€ 28,50	SIL506BL	€ 32,00
1290 SUPER DUKE R	2014-2016	EVO507CL	EVO507BL	€ 28,50	PRO507CL	PRO507BL	€ 28,50	SIL507BL	€ 32,00
RC125/200/390	2014-	EVO508CL	EVO508BL	€ 28,50	PRO508CL	PRO508BL	€ 28,50	SIL508BL	€ 32,00
1290 SUPER DUKE R	2017-	EVO509CL	EVO509BL	€ 28,50	PRO509CL	PRO509BL	€ 28,50	SIL509BL	€ 32,00
1289 SUPER DUKE GT	2016-	EVO510CL	EVO510BL	€ 28,50	PRO510CL	PRO510BL	€ 28,50	SIL510BL	€ 32,00
DUKE 125 / 390	2017-	EVO511CL	EVO511BL	€ 28,50	PRO511CL	PRO511BL	€ 28,50	SIL511BL	€ 32,00
790 DUKE	2018	EVO512CL	EVO512BL	€ 33,00	PRO512CL	PRO512BL	€ 33,00	SIL512BL	€ 36,70
MV AGUSTA									FASCIA E
F3 675/800	2013-	EVO600CL	EVO600BL	€ 28,50	PRO600CL	PRO600BL	€ 28,50	SIL600BL	€ 32,00
990R/1090RR BRUTALE	2010-	EVO601CL	EVO601BL	€ 33,00	PRO601CL	PRO601BL	€ 33,00	SIL601BL	€ 36,70
F4 1000R	2010-	EVO602CL	EVO602BL	€ 33,00	PRO602CL	PRO602BL	€ 33,00	SIL602BL	€ 36,70
675/800 BRUTALE	2012-2017	EVO603CL	EVO603BL	€ 33,00	PRO603CL	PRO603BL	€ 33,00	SIL603BL	€ 36,70
DRAGSTER 800	2014-2017	EVO604CL	EVO604BL	€ 33,00	PRO604CL	PRO604BL	€ 33,00	SIL604BL	€ 36,70
STRADALE 800	2015-2017	EVO605CL	EVO605BL	€ 33,00	PRO605CL	PRO605BL	€ 33,00	SIL605BL	€ 36,70
BRUTALE 800RR	2018	EVO606CL	EVO606BL	€ 28,50	PRO606CL	PRO606BL	€ 28,50	SIL606BL	€ 32,00
SUZUKI									FASCIA E
GSXR600/750	1996-2000	EVO700CL	EVO700BL	€ 28,50	PRO700CL	PRO700BL	€ 28,50	SIL700BL	€ 32,00
GSXR600/750 new design	2001-2003	EVO701CL	EVO701BL	€ 28,50	PRO701CL	PRO701BL	€ 28,50	SIL701BL	€ 32,00
GSXR600/750	2004-2005	EVO702CL	EVO702BL	€ 33,00	PRO702CL	PRO702BL	€ 33,00	SIL702BL	€ 36,70
GSXR600/750	2006-2007	EVO703CL	EVO703BL	€ 28,50	PRO703CL	PRO703BL	€ 28,50	SIL703BL	€ 32,00
GSXR600/750	2008-2010	EVO704CL	EVO704BL	€ 33,00	PRO704CL	PRO704BL	€ 33,00	SIL704BL	€ 36,70
GSXR600/750	2011-	EVO705CL	EVO705BL	€ 28,50	PRO705CL	PRO705BL	€ 28,50	SIL705BL	€ 32,00
GSXR1000	2001-2004	EVO712CL	EVO712BL	€ 28,50	PRO712CL	PRO712BL	€ 28,50	SIL712BL	€ 32,00
GSXR1000	2005-2006	EVO713CL	EVO713BL	€ 28,50	PRO713CL	PRO713BL	€ 28,50	SIL713BL	€ 32,00
GSXR1000 new design	2007-2008	EVO714CL	EVO714BL	€ 28,50	PRO714CL	PRO714BL	€ 28,50	SIL714BL	€ 32,00
GSXR1000 new design	2009-2016	EVO715CL	EVO715BL	€ 33,00	PRO715CL	PRO715BL	€ 33,00	SIL715BL	€ 36,70
GSX1300R HAYABUSA	1999-	EVO716CL	EVO716BL	€ 28,50	PRO716CL	PRO716BL	€ 28,50	SIL716BL	€ 32,00
BANDIT GSF650	2005-2009	EVO717CL	EVO717BL	€ 28,50	PRO717CL	PRO717BL	€ 28,50	SIL717BL	€ 32,00
GSF1250S/GT BANDIT	2007-2016	EVO718CL	EVO718BL	€ 28,50	PRO718CL	PRO718BL	€ 28,50	SIL718BL	€ 32,00
SV1000	2003-2007	EVO719CL	EVO719BL	€ 28,50	PRO719CL	PRO719BL	€ 28,50	SIL719BL	€ 32,00
SV650	2007-2015	EVO720CL	EVO720BL	€ 28,50	PRO720CL	PRO720BL	€ 28,50	SIL720BL	€ 32,00
VSTROM 600	2012-2016	EVO721CL	EVO721BL	€ 28,50	PRO721CL	PRO721BL	€ 28,50	SIL721BL	€ 32,00
VSTROM 1000	2013-	EVO722CL	EVO722BL	€ 33,00	PRO722CL	PRO722BL	€ 33,00	SIL722BL	€ 36,70
GSR750	2011-2016	EVO723CL	EVO723BL	€ 28,50	PRO723CL	PRO723BL	€ 28,50	SIL723BL	€ 32,00
SFV650 GLADIUS	2010-2016	EVO724CL	EVO724BL	€ 28,50	PRO724CL	PRO724BL	€ 28,50	SIL724BL	€ 32,00
GSX650F	2009-2016	EVO725CL	EVO725BL	€ 28,50	PRO725CL	PRO725BL	€ 28,50	SIL725BL	€ 32,00
GSX S1000	2015-	EVO726CL	EVO726BL	€ 33,00	PRO726CL	PRO726BL	€ 33,00	SIL726BL	€ 36,70
SV650	2016-	EVO727CL	EVO727BL	€ 28,50	PRO727CL	PRO727BL	€ 28,50	SIL727BL	€ 32,00
SV650	1999-2002	EVO728CL	EVO728BL	€ 28,50	PRO728CL	PRO728BL	€ 28,50	SIL728BL	€ 32,00
GSXR1000	2017-	EVO729CL	EVO729BL	€ 28,50	PRO729CL	PRO729BL	€ 28,50	SIL729BL	€ 32,00

MODELLO	ANNO	EVO SERIES			PRO SERIES			SILICONE SERIES	
		COD. COLORE TRASPARENTE	COD. COLORE NERO	PREZZO IVA ESCLUSA	COD. COLORE TRASPARENTE	CODICE NERO	PREZZO IVA ESCLUSA	COD. SILICONE NERO	PREZZO IVA ESCLUSA
GSX-S750	2017-	EVO730CL	EVO730BL	€ 28,50	PRO730CL	PRO730BL	€ 28,50	SIL730BL	€ 32,00
V-STROM 650	2017-	EVO731CL	EVO731BL	€ 28,50	PRO731CL	PRO731BL	€ 28,50	SIL731BL	€ 32,00
GSX-R125/S125	2017-	EVO732CL	EVO732BL	€ 28,50	PRO732CL	PRO732BL	€ 28,50	SIL732BL	€ 32,00
GSXR250	2018	EVO733CL	EVO733BL	€ 28,50	PRO733CL	PRO733BL	€ 28,50	SIL733BL	€ 32,00
TRIUMPH									FASCIA E
DAYTONA 675/ STREET TRIPLE	2006-2012	EVO800CL	EVO800BL	€ 28,50	PRO800CL	PRO800BL	€ 28,50	SIL800BL	€ 32,00
DAYTONA 675/765 STREET TRIPLE	2013-	EVO801CL	EVO801BL	€ 28,50	PRO801CL	PRO801BL	€ 28,50	SIL801BL	€ 32,00
SPEED TRIPLE 1050	2011-2015	EVO804CL	EVO804BL	€ 33,00	PRO804CL	PRO804BL	€ 33,00	SIL804BL	€ 36,70
SPRINT ST/GT	2005-2016	EVO805CL	EVO805BL	€ 28,50	PRO805CL	PRO805BL	€ 28,50	SIL805BL	€ 32,00
DAYTONA 955i	2002-2006	EVO807CL	EVO807BL	€ 28,50	PRO807CL	PRO807BL	€ 28,50	SIL807BL	€ 32,00
TIGER 800	2015-2016	EVO808CL	EVO808BL	€ 28,50	PRO808CL	PRO808BL	€ 28,50	SIL808BL	€ 32,00
TIGER EXPLORER 1200	2012-	EVO809CL	EVO809BL	€ 28,50	PRO809CL	PRO809BL	€ 28,50	SIL809BL	€ 32,00
SPEED TRIPLE	2005-2010	EVO810CL	EVO810BL	€ 28,50	PRO810CL	PRO810BL	€ 28,50	SIL810BL	€ 32,00
SPEED TRIPLE	2016-	EVO811CL	EVO811BL	€ 28,50	PRO811CL	PRO811BL	€ 28,50	SIL811BL	€ 32,00
UNIVERSAL									FASCIA E
2X FOGLI	305X155	EVOSHEETSCL	EVOSHEETSBL	€ 26,00	PROSHEETSCL	PROSHEETSBL	€ 26,00	SILSHEETSBL	€ 27,08
RIDGED	-	EVORIDGEDUNICL	EVORIDGEDUNIBL	€ 20,00	PRORIDGEDCL	PRORIDGEDBL	€ 20,00	SILRIDGEDUNIBL	€ 20,41
YAMAHA									FASCIA E
YZF-R125	2008-	EVO900CL	EVO900BL	€ 28,50	PRO900CL	PRO900BL	€ 28,50	SIL900BL	€ 32,00
YZF- R1	2002-2003	EVO901CL	EVO901BL	€ 33,00	PRO901CL	PRO901BL	€ 33,00	SIL901BL	€ 36,70
YZF-R1	2004-2006	EVO902CL	EVO902BL	€ 33,00	PRO902CL	PRO902BL	€ 33,00	SIL902BL	€ 36,70
YZF-R1	2007-2008	EVO903CL	EVO903BL	€ 33,00	PRO903CL	PRO903BL	€ 33,00	SIL903BL	€ 36,70
YZF-R1	2009-2014	EVO904CL	EVO904BL	€ 33,00	PRO904CL	PRO904BL	€ 33,00	SIL904BL	€ 36,70
YZF-R6	1999-2002	EVO905CL	EVO905BL	€ 28,50	PRO905CL	PRO905BL	€ 28,50	SIL905BL	€ 32,00
YZF-R6	2003-2005	EVO906CL	EVO906BL	€ 28,50	PRO906CL	PRO906BL	€ 28,50	SIL906BL	€ 32,00
YZF-R6 new design	2006-2007	EVO907CL	EVO907BL	€ 28,50	PRO907CL	PRO907BL	€ 28,50	SIL907BL	€ 32,00
YZF-R6	2008-2016	EVO909CL	EVO909BL	€ 33,00	PRO909CL	PRO909BL	€ 33,00	SIL909BL	€ 36,70
FZS 1000 FAZER	2001-2005	EVO910CL	EVO910BL	€ 28,50	PRO910CL	PRO910BL	€ 28,50	SIL910BL	€ 32,00
FZ1 FAZER	2006-2016	EVO911CL	EVO911BL	€ 33,00	PRO911CL	PRO911BL	€ 33,00	SIL911BL	€ 36,70
FZ6 FAZER	2004-2009	EVO912CL	EVO912BL	€ 28,50	PRO912CL	PRO912BL	€ 28,50	SIL912BL	€ 32,00
FZ8 FAZER	2010-2015	EVO913CL	EVO913BL	€ 33,00	PRO913CL	PRO913BL	€ 33,00	SIL913BL	€ 36,70
MT-07	2014-2017	EVO914CL	EVO914BL	€ 28,50	PRO914CL	PRO914BL	€ 28,50	SIL914BL	€ 32,00
MT-09	2013-	EVO915CL	EVO915BL	€ 28,50	PRO915CL	PRO915BL	€ 28,50	SIL915BL	€ 32,00
XJ6	2010-2016	EVO916CL	EVO916BL	€ 33,00	PRO916CL	PRO916BL	€ 33,00	SIL916BL	€ 36,70
MT-125	2014-	EVO917CL	EVO917BL	€ 28,50	PRO917CL	PRO917BL	€ 28,50	SIL917BL	€ 32,00
YZF-R25/R3	2014-	EVO918CL	EVO918BL	€ 28,50	PRO918CL	PRO918BL	€ 28,50	SIL918BL	€ 32,00
YZF-R1	2015-	EVO919CL	EVO919BL	€ 33,00	PRO919CL	PRO919BL	€ 33,00	SIL919BL	€ 36,70
MT-03	2006-2015	EVO920CL	EVO920BL	€ 33,00	PRO920CL	PRO920BL	€ 33,00	SIL920BL	€ 36,70
MT-09 TRACER	2015-2017	EVO921CL	EVO921BL	€ 33,00	PRO921CL	PRO921BL	€ 33,00	SIL921BL	€ 36,70
SUPER TENERE	2011-	EVO922CL	EVO922BL	€ 33,00	PRO922CL	PRO922BL	€ 33,00	SIL922BL	€ 36,70
FJR 1300	2013-	EVO923CL	EVO923BL	€ 33,00	PRO923CL	PRO923BL	€ 33,00	SIL923BL	€ 36,70
XSR 900	2016-	EVO925CL	EVO925BL	€ 33,00	PRO925CL	PRO925BL	€ 33,00	SIL925BL	€ 36,70
XJR 1300	2015-2017	EVO926CL	EVO926BL	€ 28,50	PRO926CL	PRO926BL	€ 28,50	SIL926BL	€ 32,00
MT-10	2016-	EVO927CL	EVO927BL	€ 33,00	PRO927CL	PRO927BL	€ 33,00	SIL927BL	€ 36,70
YZF-R6	2017-	EVO928CL	EVO928BL	€ 33,00	PRO928CL	PRO928BL	€ 33,00	SIL928BL	€ 36,70
TRACER 700	2017-	EVO929CL	EVO929BL	€ 28,50	PRO929CL	PRO929BL	€ 28,50	SIL929BL	€ 32,00
MT-03	2016-	EVO930CL	EVO930BL	€ 28,50	PRO930CL	PRO930BL	€ 28,50	SIL930BL	€ 32,00
XSR 700	2015-	EVO931CL	EVO931BL	€ 33,00	PRO931CL	PRO931BL	€ 33,00	SIL931BL	€ 36,70
NIKEN	2018	EVO932CL	EVO932BL	€ 28,50	PRO932CL	PRO932BL	€ 28,50	SIL932BL	€ 32,00
MT-07	2018	EVO933CL	EVO933BL	€ 28,50	PRO933CL	PRO933BL	€ 28,50	SIL933BL	€ 32,00

CENTRE TANK PADS

Con le nuove protezioni centrali EAZI-GRIP è possibile allestire la propria moto sia sulle parti laterali, che sulla parte centrale del serbatoio, con la stessa tipologia di materiale (EVO o PRO o SILICONE), disponibili nei diversi design



DESIGN	MODELLO	CODICE PRODOTTO	PREZZO AL PUBBLICO IVA ESCLUSA	FASCIA
A	EVO TRASPARENTE	EVOCENTREPADA CL	€ 14,50	E
A	EVO NERO	EVOCENTREPADA BL	€ 14,50	E
A	PRO TRASPARENTE	PROCENTREPADA CL	€ 14,50	E
A	PRO NERO	PROCENTREPADA BL	€ 14,50	E
A	SILICONE	SILCENTREPADA BL	€ 17,30	E
B	EVO TRASPARENTE	EVOCENTREPAD BCL	€ 14,50	E
B	EVO NERO	EVOCENTREPAD BBL	€ 14,50	E
B	PRO TRASPARENTE	PROCENTREPAD BCL	€ 14,50	E
B	PRO NERO	PROCENTREPAD BBL	€ 14,50	E
B	SILICONE	SILCENTREPAD BBL	€ 17,30	E
C	EVO TRASPARENTE	EVOCENTREPAD CCL	€ 14,50	E
C	EVO NERO	EVOCENTREPAD CBL	€ 14,50	E
C	PRO TRASPARENTE	PROCENTREPAD CCL	€ 14,50	E
C	PRO NERO	PROCENTREPAD CBL	€ 14,50	E
C	SILICONE	SILCENTREPAD CBL	€ 17,30	E
D	EVO TRASPARENTE	EVOCENTREPAD DCL	€ 14,50	E
D	EVO NERO	EVOCENTREPAD DBL	€ 14,50	E
D	PRO TRASPARENTE	PROCENTREPAD DCL	€ 14,50	E
D	PRO NERO	PROCENTREPAD DBL	€ 14,50	E
D	SILICONE	SILCENTREPAD DBL	€ 17,30	E
E	EVO TRASPARENTE	EVOCENTREPA DECL	€ 14,50	E
E	EVO NERO	EVOCENTREPA DEBL	€ 14,50	E
E	PRO TRASPARENTE	PROCENTREPA DECL	€ 14,50	E
E	PRO NERO	PROCENTREPA DEBL	€ 14,50	E
E	SILICONE	SILCENTREPA DEBL	€ 17,30	E
F	EVO TRASPARENTE	EVOCENTREPA DFCL	€ 14,50	E
F	EVO NERO	EVOCENTREPA DFBL	€ 14,50	E
F	PRO TRASPARENTE	PROCENTREPA DFCL	€ 14,50	E
F	PRO NERO	PROCENTREPA DFBL	€ 14,50	E
F	SILICONE	SILCENTREPA DFBL	€ 17,30	E
G	EVO TRASPARENTE	EVOCENTREPA DGCL	€ 14,50	E
G	EVO NERO	EVOCENTREPA DGBL	€ 14,50	E
G	PRO TRASPARENTE	PROCENTREPA DGCL	€ 14,50	E
G	PRO NERO	PROCENTREPA DGBL	€ 14,50	E
G	SILICONE	SILCENTREPA DGBL	€ 17,30	E
H	EVO TRASPARENTE	EVOCENTREPA DHCL	€ 14,50	E
H	EVO NERO	EVOCENTREPA DHBL	€ 14,50	E
H	PRO TRASPARENTE	PROCENTREPA DHCL	€ 14,50	E
H	PRO NERO	PROCENTREPA DHBL	€ 14,50	E
H	SILICONE	SILCENTREPA DHBL	€ 17,30	E

EAZI-GRIP SILICONE HOSE KITS

MODELLO	ANNO	CODICE PRODOTTO	PREZZO IVA ESCLUSA	FASCIA
BMW				
S1000RR KIT TUBI SILICONE	2009-	HOSEBMW001	€ 62,30	E
S1000RR KIT MORSETTI	2009-	CLAMPBMW001	€ 14,75	E
DUCATI				
899/959/1199/1299 PANIGALE KIT TUBI SILICONE	2012-2017	HOSEDOC001	€ 91,80	E
899/959/1199/1299 PANIGALE KIT MORSETTI	2012-2017	CLAMPDOC001	€ 20,49	E
1098 R/S KIT TUBI SILICONE	2007-2009	HOSEDOC002	€ 101,64	E
1098 R/S KIT MORSETTI	2007-2009	CLAMPDOC002	€ 24,59	E
V4 PANIGALE KIT TUBI SILICONE	NEW 2018-	HOSEDOC003	€ 85,25	E
V4 PANIGALE KIT MORSETTI	NEW 2018-	CLAMPDOC003	€ 20,49	E
CBR 600RR KIT TUBI SILICONE				
CBR 600RR KIT TUBI SILICONE	NEW 2007-2019	HOSEHON001	€ 139,34	E
CBR 600RR KIT MORSETTI	NEW 2007-2019	CLAMPHON001	€ 18,85	E
KAWASAKI				
ER6N KIT TUBI SILICONE	2006-2017	HOSEKAW001	€ 29,51	E
ER6N KIT MORSETTI	2006-2017	CLAMPKAW001	€ 7,38	E
ZX6R (636) KIT TUBI SILICONE	2009-	HOSEKAW003	€ 92,62	E
ZX6R (636) KIT MORSETTI	2009-	CLAMPKAW003	€ 20,49	E
ZX10R KIT TUBI SILICONE	2016-	HOSEKAW005	€ 89,34	E
ZX10R KIT MORSETTI	2016-	CLAMPKAW005	€ 20,49	E
Z750 KIT TUBI SILICONE	2007-2012	HOSEKAW002	€ 59,84	E
Z750 KIT MORSETTI	2007-2012	CLAMPKAW002	€ 20,49	E
Z1000 KIT TUBI SILICONE	2010-2014	HOSEKAW004	€ 131,15	E
Z1000 KIT MORSETTI	2010-2014	CLAMPKAW004	€ 33,61	E
KTM				
KTM 990 SUPERDUKE R KIT TUBI SILICONE	2008-2014	HOSEKTM001	€ 78,69	E
KTM 990 SUPERDUKE R KIT MORSETTI	2008-2014	CLAMPKTM001	€ 20,49	E
SUZUKI				
GSR750 KIT TUBI SILICONE	NEW 2011-2017	HOSESUZ004	€ 92,62	E
GSR750 KIT MORSETTI	NEW 2011-2017	CLAMPSTUZ004	€ 20,49	E
GSXR600/750 KIT TUBI SILICONE	2011-	HOSESUZ003	€ 122,95	E
GSXR600/750 KIT MORSETTI	2011-	CLAMPSTUZ003	€ 33,61	E
GSXR1000 KIT TUBI SILICONE	2009-2016	HOSESUZ002	€ 114,75	E
GSXR1000 KIT MORSETTI	2009-2016	CLAMPSTUZ002	€ 20,49	E
GSXR1000 KIT TUBI SILICONE	2017-	HOSESUZ005	€ 89,34	E
GSXR1000 KIT MORSETTI	2017-	CLAMPSTUZ005	€ 20,49	E
SV650 KIT TUBI SILICONE	2003-2015	HOSESUZ001	€ 68,03	E
SV650 KIT MORSETTI	2003-2015	CLAMPSTUZ001	€ 9,84	E
TRIUMPH				
1050 SPEED TRIPLE KIT TUBI SILICONE	2011-2015	HOSETRI001	€ 109,02	E
1050 SPEED TRIPLE KIT MORSETTI	2011-2015	CLAMPTRI001	€ 14,75	E
YAMAHA				
YZF-R1 KIT TUBI SILICONE	2015-	HOSEYAM002	€ 33,61	E
YZF-R1 KIT MORSETTI	2015-	CLAMPYAM002	€ 8,20	E
YZF-R6 KIT TUBI SILICONE	2016-	HOSEYAM003	€ 97,54	E
YZF-R6 KIT MORSETTI	2016-	CLAMPYAM003	€ 33,61	E

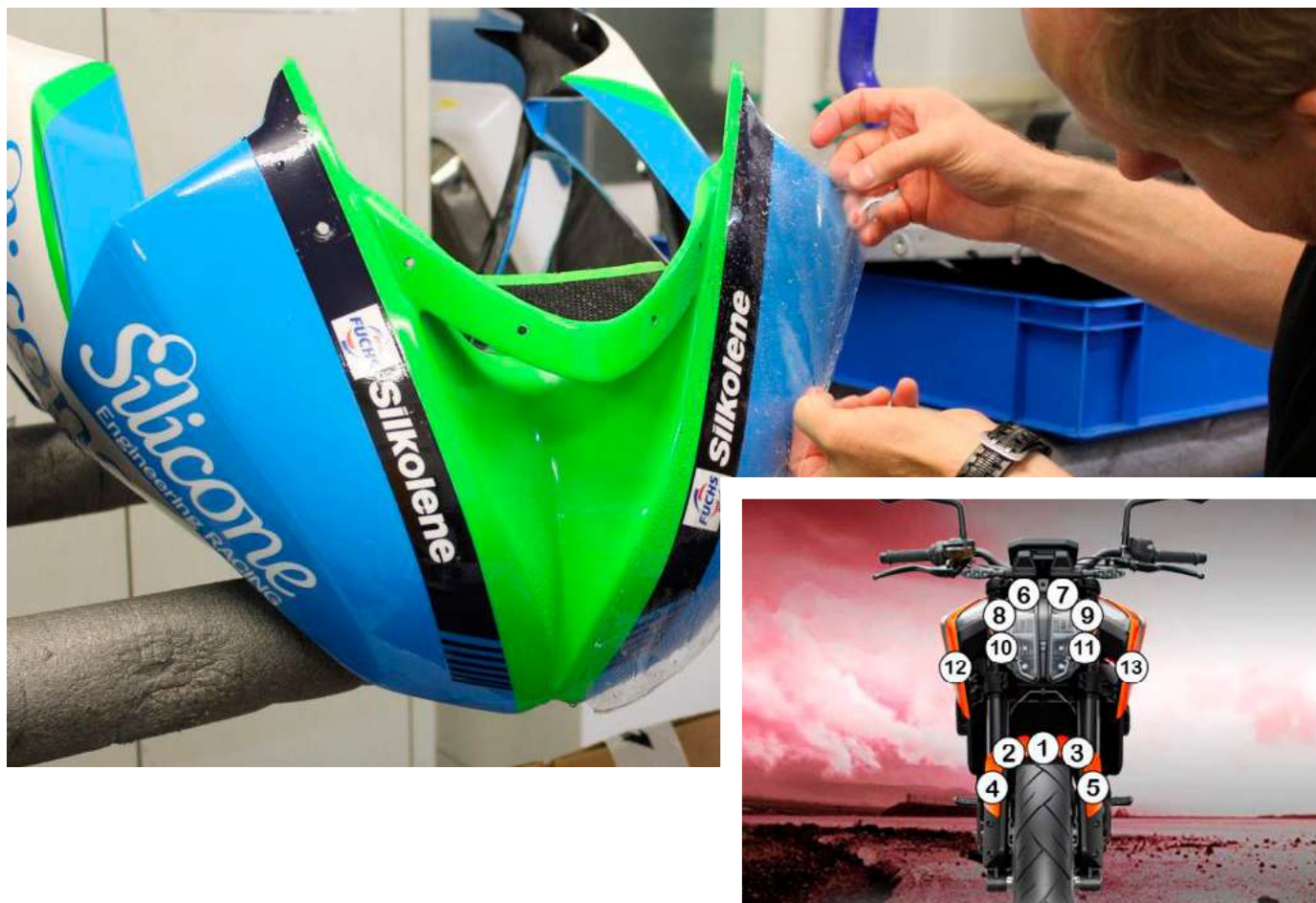

IN TEMPI DI CRISI È DIVENTATO QUANTO MAI IMPORTANTE PROTEGGERE IL VALORE DELLA MOTO PER POTER SPUNTARE IL MIGLIOR PREZZO AL MOMENTO DI RIVENDERLA.

Pietrisco, ghiaia, graffi, abrasioni, il sale nella stagione invernale, possono deteriorare notevolmente la verniciatura o, peggio, le costose decal grafiche, i loghi e l'aspetto generale della moto.

Per questi motivi, **per evitare l'usura dovuta agli agenti esterni e mantenere un aspetto brillante di carenature, cupolini e parafanghi**, viene in aiuto del motociclista la pellicola protettiva Eazi Guard, prodotta dalla stessa azienda inglese che già ha in catalogo le protezioni Eazi Grip per serbatoio e altre parti soggette a sfregamento della moto.

La innovativa **Eazi Guard è una speciale protezione in poliuretano trasparente molto flessibile**, realizzata sotto forma di pellicola e prodotta sia in kit specifici per tanti modelli di moto che in rotoli di varie misure o in fogli da tagliare e sagomare. Per particolari necessità, la Eazi Guard può anche essere richiesta in formati su richiesta grazie alla lavorazione con plotter a controllo numerico.

Facile da posizionare, specie per i kit già pronti e pre-tagliati, mantiene una notevole elasticità che può essere ovviamente aiutata, al momento dell'applicazione, scaldando con la pistola termica o un semplice asciugacapelli il film di poliuretano per consentire la perfetta aderenza anche sulle curve della carenatura e sugli spigoli più difficili, rendendo agevole il posizionamento.

La pellicola, ultra sottile ma al tempo stesso ultra resistente, grazie all'uso di speciali polimeri e isocianati, è garantita contro l'ingiallimento precoce, la rottura, la fessurazione, lo spellicolamento e in genere da tutti i danni causati dagli agenti atmosferici o dal pietrisco stradale.

MODELLO	ANNI	LUCIDO/OPACO	CODICE PRODOTTO	PREZZO AL PUBBLICO IVA ESCLUSA	FASCIA
APRILIA					
TUONO V4	2011-2014	LUCIDO OPACO	GUARDAPR002 GUARDAPR002M	€ 51,33 € 75,98	E
RSV4	2015-2017	LUCIDO OPACO	GUARDAPR003 GUARDAPR003M	€ 82,14 € 123,48	E
TUONO V4	2015-2017	LUCIDO OPACO	GUARDAPR004 GUARDAPR004M	€ 82,14 € 123,48	E
BMW					
R1200GS	2014-2016	LUCIDO OPACO	GUARDBMW001 GUARDBMW001M	€ 51,33 € 75,98	E
S1000RR	2009-2014	LUCIDO OPACO	GUARDBMW002 GUARDBMW002M	€ 82,14 € 123,48	E
S1000RR	2015-2018	LUCIDO OPACO	GUARDBMW003 GUARDBMW003M	€ 82,14 € 123,48	E
HP4	2009-2014	LUCIDO OPACO	GUARDBMW004 GUARDBMW004M	€ 82,14 € 123,48	E
HP4	2015-2018	LUCIDO OPACO	GUARDBMW005 GUARDBMW005M	€ 82,14 € 123,48	E
S1000XR	2015-	LUCIDO OPACO	GUARDBMW006 GUARDBMW006M	€ 82,14 € 123,48	E
R1200RT	2014-	LUCIDO OPACO	GUARDBMW007 GUARDBMW007M	€ 107,82 € 151,98	E
S1000RR	NEW 2019	LUCIDO OPACO	GUARDBMW008 GUARDBMW008M	€ 107,82 € 151,98	E
DUCATI					
1299 PANIGALE	2015-2017	LUCIDO OPACO	GUARDDUC001 GUARDDUC001M	€ 82,14 € 123,48	E
DIAVEL	2011-	LUCIDO OPACO	GUARDDUC002 GUARDDUC002M	€ 51,33 € 75,98	E
MULTISTRADA	2015-	LUCIDO OPACO	GUARDDUC003 GUARDDUC003M	€ 82,14 € 123,48	E
1199 PANIGALE	2012-2017	LUCIDO OPACO	GUARDDUC004 GUARDDUC004M	€ 82,14 € 123,48	E
899 PANIGALE	2013-2017	LUCIDO OPACO	GUARDDUC005 GUARDDUC005M	€ 82,14 € 123,48	E
959 PANIGALE	2016-2017	LUCIDO OPACO	GUARDDUC006 GUARDDUC006M	€ 82,14 € 123,48	E
SUPERSPORT	2017-	LUCIDO OPACO	GUARDDUC007 GUARDDUC007M	€ 82,14 € 123,48	E
V4 PANIGALE	2018	LUCIDO OPACO	GUARDDUC008 GUARDDUC008M	€ 107,82 € 151,98	E
MULTISTRADA 950	2017-	LUCIDO OPACO	GUARDDUC009 GUARDDUC009M	€ 82,14 € 123,48	E
MULTISTRADA 1260/1260S	2018	LUCIDO OPACO	GUARDDUC010 GUARDDUC010M	€ 82,14 € 123,48	E
MULTISTRADA 1260 PIKES PEAK	2018	LUCIDO OPACO	GUARDDUC011 GUARDDUC011M	€ 82,14 € 123,48	E
HONDA					
CBR1000RR	2012-2016	LUCIDO OPACO	GUARDHON002 GUARDHON002M	€ 82,14 € 123,48	E
CBR650RR/F	2014-	LUCIDO OPACO	GUARDHON004 GUARDHON004M	€ 82,14 € 123,48	E
CBR1000RR	2008-2011	LUCIDO OPACO	GUARDHON005 GUARDHON005M	€ 82,14 € 123,48	E
CBR1000RR	2017-	LUCIDO OPACO	GUARDHON006 GUARDHON006M	€ 107,82 € 151,98	E
CBR600	2013-2017	LUCIDO OPACO	GUARDHON007 GUARDHON007M	€ 82,14 € 123,48	E
VFR800	2014-2017	LUCIDO OPACO	GUARDHON008 GUARDHON008M	€ 82,14 € 123,48	E
CRF1000L AFRICA TWIN	2016-	LUCIDO OPACO	GUARDHON009 GUARDHON009M	€ 107,82 € 151,98	E
CRF1000L AFRICA TWIN ADVENTURE SPORT	2018	LUCIDO OPACO	GUARDHON010 GUARDHON010M	€ 107,82 € 151,98	E

MODELLO	ANNI	LUCIDO/OPACO	CODICE PRODOTTO	PREZZO AL PUBBLICO IVA ESCLUSA	FASCIA
KAWASAKI					
ER6F	2012-2016	LUCIDO OPACO	GUARDKAW001 GUARDKAW001M	€ 51,33 € 75,98	E
GTR1400	2010-2016	LUCIDO OPACO	GUARDKAW002 GUARDKAW002M	€ 107,82 € 151,98	E
Z800	2013-2016	LUCIDO OPACO	GUARDKAW003 GUARDKAW003M	€ 82,14 € 123,48	E
Z1000	2014-2017	LUCIDO OPACO	GUARDKAW004 GUARDKAW004M	€ 82,14 € 123,48	E
Z1000SX	2014-2016	LUCIDO OPACO	GUARDKAW005 GUARDKAW005M	€ 107,82 € 123,48	E
ZX6R (636)	2013-2016	LUCIDO OPACO	GUARDKAW006 GUARDKAW006M	€ 82,14 € 123,48	E
ZX10R	2011-2015	LUCIDO OPACO	GUARDKAW007 GUARDKAW007M	€ 51,33 € 75,98	E
ZZR1400	2012-	LUCIDO OPACO	GUARDKAW008 GUARDKAW008M	€ 107,82 € 151,98	E
VERSYS 650	2015-	LUCIDO OPACO	GUARDKAW009 GUARDKAW009M	€ 82,14 € 123,48	E
ZX10R	2016-	LUCIDO OPACO	GUARDKAW010 GUARDKAW010M	€ 82,14 € 123,48	E
NINJA H2	2015-	LUCIDO OPACO	GUARDKAW011 GUARDKAW011M	€ 107,82 € 151,98	E
Z1000SX	2017-	LUCIDO OPACO	GUARDKAW012 GUARDKAW012M	€ 82,14 € 123,48	E
NINJA 650	2017-	LUCIDO OPACO	GUARDKAW013 GUARDKAW013M	€ 82,14 € 123,48	E
Z900	2017-	LUCIDO OPACO	GUARDKAW014 GUARDKAW014M	€ 82,14 € 123,48	E
VERSYS 1000	2015-	LUCIDO OPACO	GUARDKAW015 GUARDKAW015M	€ 82,14 € 123,48	E
NINJA H2 SX	2018	LUCIDO OPACO	GUARDKAW016 GUARDKAW016M	€ 107,82 € 151,98	E
NINJA 250/400	2018	LUCIDO OPACO	GUARDKAW017 GUARDKAW017M	€ 107,82 € 151,98	E
Z900RS CAFÉ	2017	LUCIDO OPACO	GUARDKAW018 GUARDKAW018M	€ 51,33 € 75,98	E
Z900RS	2017	LUCIDO OPACO	GUARDKAW019 GUARDKAW019M	€ 28,48 € 41,31	E
VERSYS 1000/SE	2019	LUCIDO OPACO	GUARDKAW020 GUARDKAW020M	€ 82,14 € 123,48	E
ZX6R (636)	2019	LUCIDO OPACO	GUARDKAW021 GUARDKAW021M	€ 107,82 € 151,98	E
KTM					
1290 SUPERDUKE	2014-2016	LUCIDO OPACO	GUARDKTM001 GUARDKTM001M	€ 82,14 € 123,48	E
125 DUKE	2011-2016	LUCIDO OPACO	GUARDKTM002 GUARDKTM002M	€ 51,33 € 75,98	E
390 DUKE	2013-2016	LUCIDO OPACO	GUARDKTM003 GUARDKTM003M	€ 51,33 € 75,98	E
1290 SUPERDUKE GT	2016-	LUCIDO OPACO	GUARDKTM004 GUARDKTM004M	€ 107,82 € 151,98	E
KTM 790 DUKE	2018	LUCIDO OPACO	GUARDKTM005 GUARDKTM005M	€ 51,33 € 75,98	E
SUZUKI					
GSXR600/750	2011-	LUCIDO OPACO	GUARDSUZ001 GUARDSUZ001M	€ 82,14 € 123,48	E
GSXR1000	2009-2016	LUCIDO OPACO	GUARDSUZ002 GUARDSUZ002M	€ 82,14 € 123,48	E
GSX-S1000F	2015-	LUCIDO OPACO	GUARDSUZ003 GUARDSUZ003M	€ 82,14 € 123,48	E
GSXR1000	2017-	LUCIDO OPACO	GUARDSUZ004 GUARDSUZ004M	€ 107,82 € 151,98	E
TRIUMPH					
1050 SPEED TRIPLE	2011-2015	LUCIDO OPACO	GUARDTRIO01 GUARDTRIO01M	€ 51,33 € 75,98	E

MODELLO	ANNI	LUCIDO/OPACO	CODICE PRODOTTO	PREZZO AL PUBBLICO IVA ESCLUSA	FASCIA
SPRINT GT	2010-2017	LUCIDO OPACO	GUARDTRI002 GUARDTRI002M	€ 107,82 € 151,98	E
675 STREET TRIPLE	2013-2016	LUCIDO OPACO	GUARDTRI003 GUARDTRI003M	€ 51,33 € 75,98	E
675 DAYTONA	2013-2016	LUCIDO OPACO	GUARDTRI004 GUARDTRI004M	€ 82,14 € 123,48	E
1050 SPEED TRIPLE RS	2018-	LUCIDO OPACO	GUARDTRI005 GUARDTRI005M	€ 82,14 € 123,48	E
1050 SPEED TRIPLE	2016-2017	LUCIDO OPACO	GUARDTRI006 GUARDTRI006M	€ 82,14 € 123,48	E
UNIVERSAL					
STANDARD		LUCIDO OPACO	GUARDUNI001 GUARDUNI001M	€ 49,28 € 68,86	E
LARGE		LUCIDO OPACO	GUARDUNI002 GUARDUNI002M	€ 92,40 € 109,23	E
YAMAHA					
YZF-R1	2015-	LUCIDO OPACO	GUARDYAM001 GUARDYAM001M	€ 82,14 € 123,48	E
YZF- R3/R25	2015-	LUCIDO OPACO	GUARDYAM002 GUARDYAM002M	€ 82,14 € 123,48	E
YZF-R6	2008-2016	LUCIDO OPACO	GUARDYAM003 GUARDYAM003M	€ 82,14 € 123,48	E
YZF-R125	2014-	LUCIDO OPACO	GUARDYAM004 GUARDYAM004M	€ 82,14 € 123,48	E
YZF-R1 M	2015-	LUCIDO OPACO	GUARDYAM005 GUARDYAM005M	€ 107,82 € 151,98	E
FJR1300A	2014-	LUCIDO OPACO	GUARDYAM006 GUARDYAM006M	€ 82,14 € 123,48	E
FJR1300AE/AS	2014-	LUCIDO OPACO	GUARDYAM007 GUARDYAM007M	€ 82,14 € 123,48	E
R6	2017-	LUCIDO OPACO	GUARDYAM008 GUARDYAM008M	€ 82,14 € 123,48	E
YZF-R3	NEW 2019	LUCIDO OPACO	GUARDYAM009 GUARDYAM009M	€ 82,14 € 123,48	E







FK VISORS
THE VISORS SPECIALISTS



FK VISORS

**PRODUZIONE VISIERE
MADE IN ITALY**



FK Visors nasce come brand di Forbikes Srl, dedicato alla produzione di visiere per caschi ed altre applicazioni.

La proficua attività di FK Visors, ad oggi una delle prime aziende italiane produttrici di visiere, è stata resa possibile dalla grande esperienza di Armando Bigliardi, tecnico professionista nella realizzazione di nuovi modelli di visiere e prototipi. Grazie al suo contributo, FK Visors ha potuto espandere la sua produzione anche al settore dei caschi per lo sci e per gli sport invernali, per auto/kart, per il paracadutismo, il ciclo e molti altri.

Garanzia dell'ottima qualità di produzione e controllo, la termoformatura garantisce **ottimi risultati anche e soprattutto per piccole quantità a discapito della lavorazione ad iniezione che risulta ideale unicamente per grandi lotti produttivi.**

FKVisors è a disposizione delle aziende produttrici di caschi di qualsiasi tipo/settore non solo per la produzione finale della visiera ma anche per lo studio e realizzazione dei modelli.

Per qualsiasi informazioni o per ricevere una prima consulenza gratuita, potete contattarci e saremo lieti di mettere la nostra professionalità ed esperienza al vostro servizio.

VISITA IL SITO WWW.FKVISORS.IT PER MAGGIORI DETTAGLI

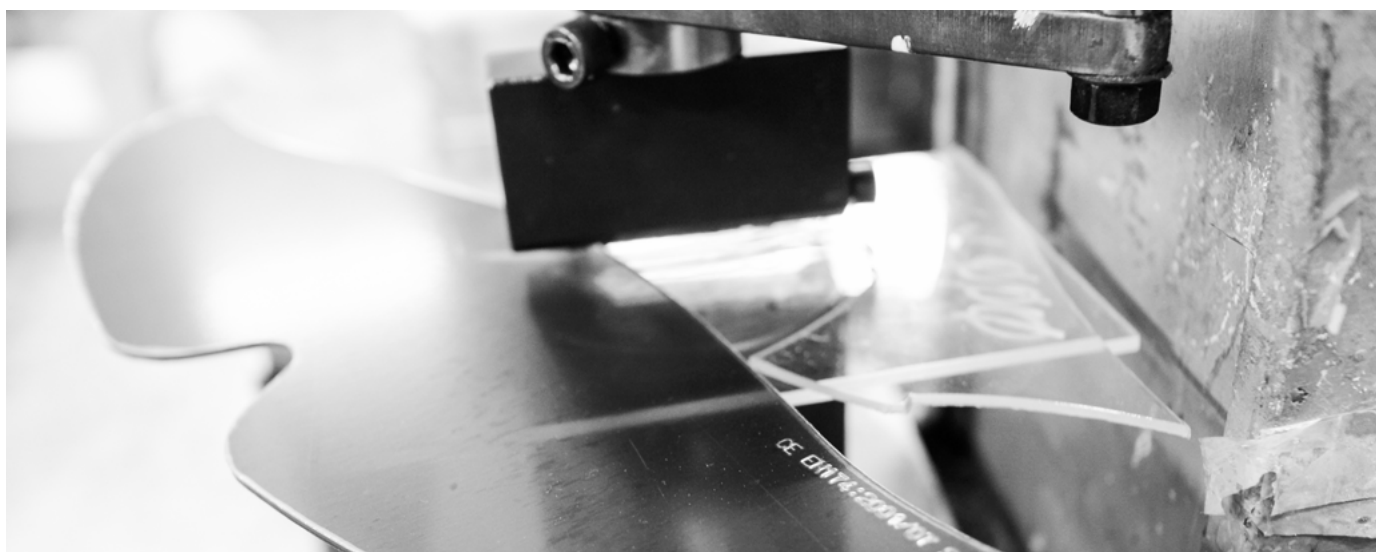

VISIERA ANTIGRAFFIO TRE BOTTONI (INTERASSE REGOLABILE) PER CASCO JET - BOTTONI INCLUSI

FASCIA
C

70-0010TR	TRASPARENTE	€ 24,50
70-0010OR	ARANCIO	€ 29,50
70-0010FC	FUMÈ CHIARO	€ 26,50
70-0010FS	FUMÈ SCURO	€ 26,50
70-0010MA	MARRONE	€ 26,50



FRONTINO ALZA-VISIERA 3 BOTTONI CROMATI

FASCIA
*

70-0030

* Se sei un rivenditore, contattaci per conoscere i prezzi a te riservati.

TRATTAMENTO ANTIFOG
INTERNO

SPESSORE 3 mm

SPECCHIATURA FK
WATER REPELLENT

TRATTAMENTO ANTIGRAFFIO
ESTERNO

COMPLETE DI ECCENTRICI PER
TEAR-OFF

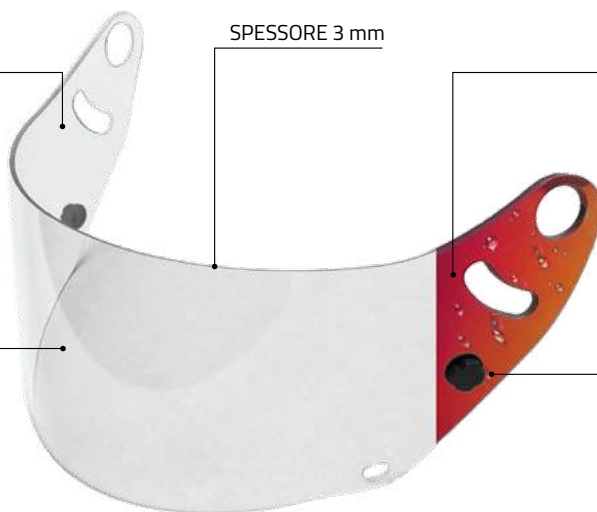

70-0040

70-00407

70-0042

70-0043

70-0044

70-0045

70-0046

70-0047

70-0048

70-004150

70-004170

70-004180

VISIERA COMPATIBILE CON CASCHI ARAI GP-6, GP-6 RC, GP-6K, GP-6S, SK-6 ANTIGRAFFIO ANTIFOG 3mm

PREZZO
IVA ESCLUSA

FASCIA
*

70-0040	TRASPARENTE	€ 35,20	*
70-00407	TRASPARENTE CON INSERTO ANTIFOG/RAIN ARANCIO	€ 38,00	*
70-004150	FUMÈ CHIARO 50%	€ 40,20	*
70-004170	FUMÈ MARRONE 70%	€ 40,20	*
70-004180	FUMÈ SCURO 80%	€ 40,20	*
70-0042	SPECCHIATA ARGENTO	€ 56,00	*
70-0043	SPECCHIATA BLU	€ 56,00	*
70-0044	SPECCHIATA INFRARED	€ 56,00	*
70-0045	SPECCHIATA BRONZO COPPER	€ 56,00	*
70-0046	SPECCHIATA ROSA	€ 56,00	*
70-0047	ARANCIO	€ 40,20	*
70-0048	SPECCHIATA VERDE SMERALDO	€ 56,00	*

* Se sei un rivenditore, contattaci per conoscere i prezzi a te riservati.

TRATTAMENTO ANTIFOG
INTERNO

SPESSORE 2 mm

SPECCHIATURA FK
WATER REPELLENT

TRATTAMENTO ANTIGRAFFIO
ESTERNO

COMPLETE DI ECCENTRICI PER
TEAR-OFF



70-0050



70-00507



70-0052



70-0053



70-0054



70-0055



70-0056



70-0057



70-0058



70-005150



70-005170



70-005180

VISIERA COMPATIBILE CON CASCHI ARAI CK-6 ANTIGRAFFIO ANTIFOG 2mm		PREZZO IVA ESCLUSA	FASCIA *
70-0050	TRASPARENTE	€ 32,00	*
70-00507	TRASPARENTE CON INSERTO ANTIFOG/RAIN ARANCIO	€ 35,00	*
70-005180	FUMÈ SCURO 80%	€ 36,00	*
70-005170	FUMÈ MARRONE 70%	€ 36,00	*
70-005150	FUMÈ CHIARO 50%	€ 36,00	*
70-0052	SPECCHIATA ARGENTO	€ 50,00	*
70-0053	SPECCHIATA BLU	€ 50,00	*
70-0054	SPECCHIATA INFRARED	€ 50,00	*
70-0055	SPECCHIATA BRONZO COPPER	€ 50,00	*
70-0056	SPECCHIATA ROSA	€ 50,00	*
70-0057	ARANCIO	€ 36,00	*
70-0058	SPECCHIATA VERDE SMERALDO	€ 50,00	*

* Se sei un rivenditore, contattaci per conoscere i prezzi a te riservati.

NEW



70-006180



70-0060

VISIERA COMPATIBILE CON CASCHI MOMO DESIGN ANTIGRAFFIO 1,5mm		PREZZO IVA ESCLUSA	FASCIA
70-0060	TRASPARENTE	€ 34,00	C
70-006180	FUMÈ SCURO 80%	€ 37,00	C
70-0062	FUMÈ SCURO 80% SPECCHIATA ARGENTO	€ 59,00	C
70-0063	FUMÈ SCURO 80% SPECCHIATA BLU	€ 59,00	C
70-0064	FUMÈ SCURO 80% SPECCHIATA ROSSO	€ 59,00	C
70-0065	FUMÈ SCURO 80% SPECCHIATA ORO	€ 59,00	C
70-0066	FUMÈ SCURO 80% SPECCHIATA ROSA	€ 59,00	C
70-0068	FUMÈ SCURO 80% SPECCHIATA VERDE	€ 59,00	C



**VISIERA
DENTISTA**



TEAR-OFFS



SCI



PARACADUTISMO

...E TANTO ALTRO!









HEL PERFORMANCE

Prima azienda al mondo ad applicare un rivestimento in PVC alla guaina per proteggere il tubo

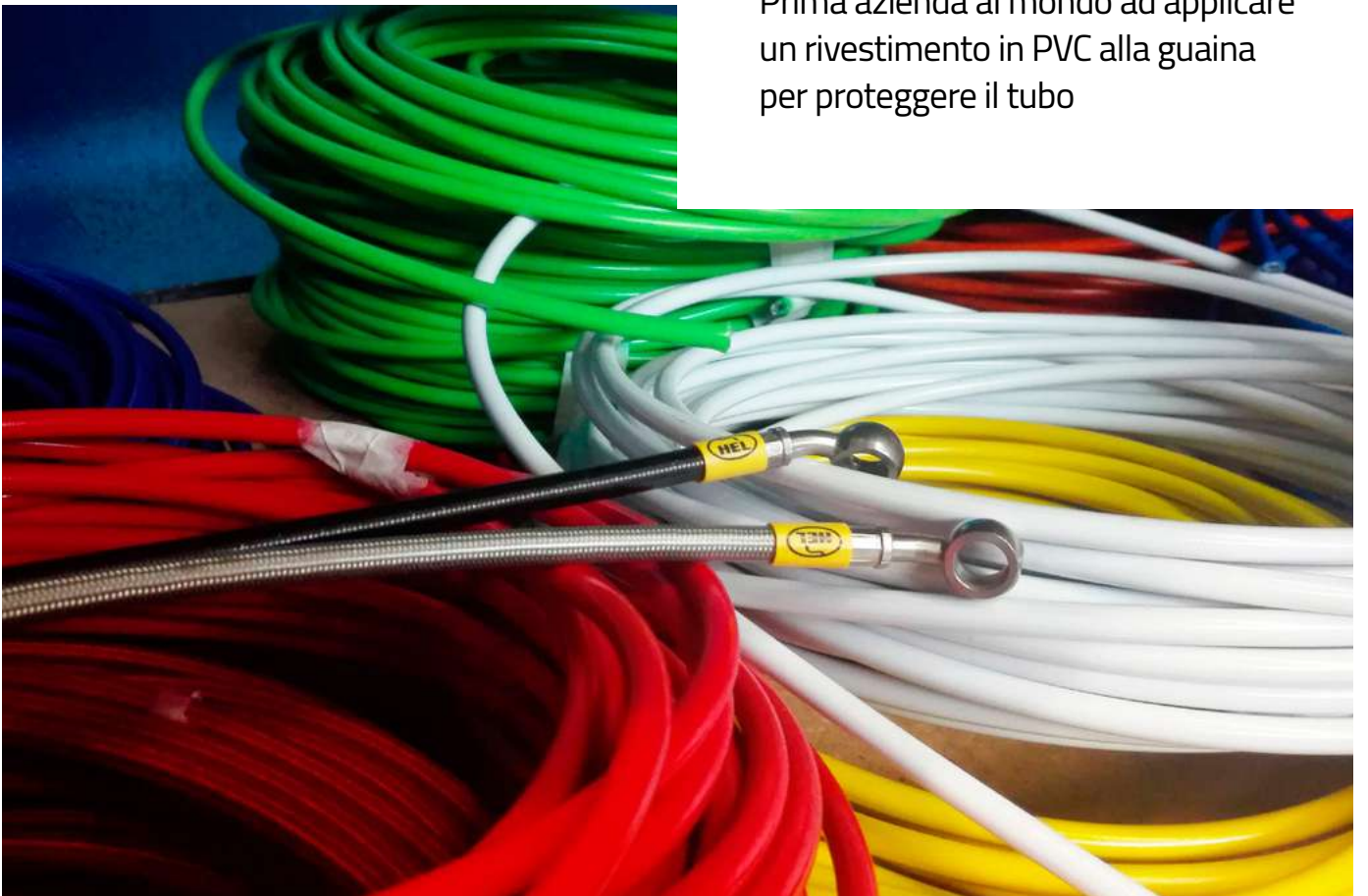

Azienda inglese specializzata nella realizzazione di **tubi freno e frizione in treccia ad alta performance**.

Prima azienda al mondo ad applicare un **rivestimento in PVC** alla guaina per **proteggere il tubo** rendendolo al contempo estremamente resistente, realizza i suoi prodotti in ben **9 colorazioni differenti** grazie alla procedura di rivestimento che avviene contestualmente alla produzione del tubo.

Da sempre **HEL** si propone di realizzare esclusivamente **prodotti al altissima qualità**, rifiutando l'uso di materiali scadenti ed utilizzando invece unicamente leghe e metalli raffinati quali il **titanio** e l'**acciaio Inox**, garantendo un prodotto di **qualità superiore per durata e prestazioni**.

HEL è partner di diversi team racing e fornisce **GARANZIA A VITA** per i suoi kit nonché tutte le **CERTIFICAZIONI** che garantiscono l'utilizzo dei tubi freno HEL in qualsiasi parte del mondo, su strada ed in circuito.

Possibilità di tubi personalizzati su richiesta. Richiedere la modulistica via mail a commerciale@forbikes.it.

LEGENDA CODICI:

HBK = KIT COMPLETO
(linee anteriori + linea posteriore)
numero tubi > a 1

HBF = SOLO LINEA ANTERIORE

HBR = SOLO LINEA POSTERIORE

HBC = SOLO LINEA FRIZIONE

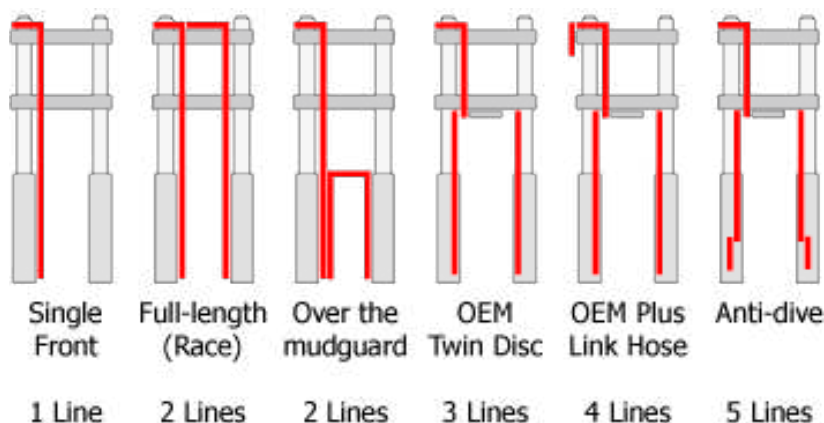



BULLONE ACCIAIO INOX PER RACCORDO SINGOLO		FASCIA C
FB-H16031C	M10X1.00	€ 3,60
FB-H16032C	M10X1.25	€ 3,60



BULLONE ACCIAIO INOX PER RACCORDO DOPPIO		FASCIA C
FB-H16131C	M10X1.00	€ 4,50
FB-H16132C	M10X1.25	€ 4,50



ADATTATORE PER POMPA FRENO RADIALE/ASSIALE	FASCIA E
FB-CFA-1	€ 18,00



BOCCOLA ACCIAIO INOX M10 PER CHIUSURA IMPIANTI ABS	FASCIA C
FB-SPACER	€ 2,30



VITE SPURGO ACCIAIO INOX PER PINZE M7X1.00	FASCIA C
FB-BNM7X100	€ 6,00



VITE SPURGO ACCIAIO INOX PER PINZE M8X1.25	FASCIA C
FB-BNM8x125	€ 6,00



VITE SPURGO ACCIAIO INOX PER PINZE M10X1.00	FASCIA C
FB-BNM10X100	€ 6,00



BULLONE ACCIAIO INOX TUBO FRENO SINGOLO CON VITE SPURGO	FASCIA E
FB-H160-31BNC	M10X1.00 € 20,00
FB-H160-32BNC	M10X1.25 € 20,00



BULLONE ACCIAIO INOX TUBO FRENO DOPPIO CON VITE SPURGO	FASCIA E
FB-H161-31BNC	M10X1.00 € 25,00
FB-H161-32BNC	M10X1.25 € 25,00



**FASCETTA STRINGITUBO
CON GOMMA DIAM. 9MM**

FASCIA
C

FB-HPC

€ 2,50

GOMMINO PASSACAVO DIAM. 9 MM

FASCIA
C

FB-GROMMET

€ 1,00

**KIT 10 PZ. RONDELLA IN RAME
DIAM. 10 MM**

FASCIA
C

FB-CCW-10

€ 4,00



CILIND.	MODELLO	ANNI	CODICE	CONFIGURAZIONE	ANT. SUP	ANT. INF	AGG	POST	FRIZ.	TOT. TUBI	PREZZO PUBBLICO IVA ESCL.	FASCIA
APRILIA												
50	50 SX Motard	2008-2010	HBK0086	SET UP OEM ANTERIORE	1			1		2	€ 56,00	E
50	RS50	1993-1998	HBK0025	SET UP OEM ANTERIORE	1			1		2	€ 56,00	E
50	RS50	1999-2006	HBK0024	SET UP OEM ANTERIORE	1			1		2	€ 56,00	E
50	RS50	2004-2010	HBK0085	SET UP OEM ANTERIORE	1			1		2	€ 56,00	E
50	RX50	1999-2007	HBK0058	SET UP OEM ANTERIORE	1			1		2	€ 56,00	E
50	SR50	1999-2006	HBK0068	SET UP OEM ANTERIORE	1			1		2	€ 56,00	E
125	125 Red Rose Custom	1988-1994	HBK0080	SET UP OEM ANTERIORE	1			1		2	€ 56,00	E
125	AF1 125 Sintesi	1986-1992	HBK0090	SET UP OEM ANTERIORE	1			1		2	€ 56,00	E
125	MX125	2006-2008	HBK0084	SET UP OEM ANTERIORE	1			1		2	€ 56,00	E
125	Pegaso 125	1992-1995	HBK0001	SET UP OEM ANTERIORE	1			1		2	€ 56,00	E
125	RS125	1999-2005	HBK0006	SET UP OEM ANTERIORE	1			1		2	€ 56,00	E
125	RS125	2006-2010	HBK0087	SET UP OEM ANTERIORE	1			1		2	€ 56,00	E
125	RS125 AF1-125	1991-1993	HBK0005	SET UP OEM ANTERIORE	1			1		2	€ 56,00	E
125	RS125 Extrema	1993-1998	HBK0012	SET UP OEM ANTERIORE	1			1		2	€ 56,00	E
125	Tuono 125	2001-2004	HBF0072	SET UP RACE	1					1	€ 28,00	E
125	SR125	2000-2003	HBF0096	SET UP OEM ANTERIORE	1					1	€ 28,00	E
125	SX125	2008-2011	HBK0097	SET UP OEM ANTERIORE	1			1		2	€ 56,00	E
250	RS250	1994-1997	HBK0015	SET UP RACE / OEM ANTERIORE	1	1		1		3	€ 84,00	E
250	RS250	1994-1997	HBK0014	SET UP OEM ANTERIORE	1	2		1		4	€ 112,00	E
250	RS250	1998-2004	HBK0073	SET UP RACE	1	1		1		3	€ 84,00	E
250	RS250	1998-2004	HBK0023	SET UP OEM ANTERIORE	1	1	1	1		4	€ 112,00	E
450	SXV450 / SXV550 Super Moto	2005-2007	HBK0074	SET UP RACE	1			1		2	€ 56,00	E
650	Moto 6.5	1995-1997	HBK0069	SET UP OEM ANTERIORE	1			1		2	€ 56,00	E
650	Pegaso 650	1995-1996	HBK0083	SET UP OEM ANTERIORE	1			1		2	€ 56,00	E
650	Pegaso 650 Rotax	1999-2005	HBK0075	SET UP OEM ANTERIORE	1			1		2	€ 56,00	E
650	Pegaso 650 Strada	2006-2010	HBK0076	SET UP OEM ANTERIORE	1			1		2	€ 56,00	E
650	Pegaso 650 Trail	2005-2009	HBK0063	SET UP OEM ANTERIORE	1			1		2	€ 56,00	E
750	Shiver SL750	2009-2011	HBK0017	SET UP RACE	1	1		1		3	€ 84,00	E
750	Shiver SL750	2009-2011	HBK0016	SET UP OEM ANTERIORE	1	1	1	1		4	€ 112,00	E
1000	ETV1000 Caponord	2001-2004	HBC0081	LINEA FRIZIONE					1	1	€ 28,00	E
1000	ETV1000 Caponord	2001-2004	HBK0082	SET UP RACE	1	1		1		3	€ 84,00	E
1000	ETV1000 Caponord	2001-2004	HBK0081	SET UP OEM ANTERIORE	1	1	1	1		4	€ 112,00	E
1000	Futura RST 1000	2001-2004	HBC0070	LINEA FRIZIONE					1	1	€ 28,00	E
1000	Futura RST 1000	2001-2004	HBK0071	SET UP RACE	1	1		1		3	€ 84,00	E
1000	Futura RST 1000	2001-2004	HBK0070	SET UP OEM ANTERIORE	1	1	1	1		4	€ 112,00	E
1000	RSV Mille 1000	1998-2000	HBK0033	SET UP RACE	1	1		1		3	€ 84,00	E
1000	RSV Mille 1000	1998-2000	HBK0032	SET UP OEM ANTERIORE	1	1	1	1		4	€ 112,00	E
1000	RSV Mille 1000	2001-2005	HBK0056	SET UP RACE	1	1		1		3	€ 84,00	E
1000	RSV Mille 1000	2001-2005	HBK0057	SET UP OEM ANTERIORE	1	1	1	1		4	€ 112,00	E
1000	RSV Mille 1000	2005-2010	HBK0079	SET UP RACE	1	1		1		3	€ 84,00	E
1000	RSV Mille 1000	2005-2010	HBK0078	SET UP OEM ANTERIORE	1	1	1	1		4	€ 112,00	E
1000	RSV4	2008-2010	HBK0089	SET UP RACE	1	1		1		3	€ 84,00	E
1000	RSV4	2008-2010	HBK0088	SET UP OEM ANTERIORE	1	1	2	1		5	€ 140,00	E
1000	RSV-R Mille 1000	1999-2000	HBK0039	SET UP RACE	1	1		1		3	€ 84,00	E
1000	RSV-R Mille 1000	1999-2000	HBK0038	SET UP OEM ANTERIORE	1	1	1	1		4	€ 112,00	E
1000	RSV-R Mille 1000	2001-2005	HBK0064	SET UP RACE	1	1		1		3	€ 84,00	E
1000	RSV-R Mille 1000	2001-2005	HBK0065	SET UP OEM ANTERIORE	1	1	1	1		4	€ 112,00	E
1000	RSV-SP Mille 1000	1999-2000	HBK0043	SET UP RACE	1	1		1		3	€ 84,00	E
1000	RSV-SP Mille 1000	1999-2000	HBK0042	SET UP OEM ANTERIORE	1	1	1	1		4	€ 112,00	E
1000	SL1000 Falco	1999-2005	HBK0047	SET UP RACE	1	1		1		3	€ 84,00	E
1000	SL1000 Falco	1999-2005	HBK0046	SET UP OEM ANTERIORE	1	1	1	1		4	€ 112,00	E
1000	Tuono 1000	2002-2005	HBC0066	LINEA FRIZIONE					1	1	€ 28,00	E
1000	Tuono 1000	2002-2005	HBK0067	SET UP RACE	1	1		1		3	€ 84,00	E

CILIND.	MODELLO	ANNI	CODICE	CONFIGURAZIONE	ANT. SUP	ANT. INF	AGG	POST	FRIZ.	TOT. TUBI	PREZZO PUBBLICO IVA ESCL.	FASCIA
1000	Tuono 1000	2002-2006	HBK0066	SET UP OEM ANTERIORE	1	1	1	1		4	€ 112,00	E
1000	Tuono 1000	2006-2010	HBC0092	LINEA FRIZIONE					1	1	€ 28,00	E
1000	Tuono 1000	2006-2010	HBK0092	SET UP RACE	1	1		1		3	€ 84,00	E
1000	Tuono 1000	2006-2010	HBK0093	SET UP OEM ANTERIORE	1	1	1			3	€ 84,00	E
1000	Tuono 1000 Factory R	2007-2009	HBK0091	SET UP RACE	1	1				2	€ 56,00	E
1000	Tuono 1000 V4 APRC	2011-2013	HBK0094	SET UP OEM ANTERIORE	1	1		1		3	€ 84,00	E
1000	Tuono 1000 V4 APRC	2011-2013	HBK0095	SET UP RACE	1	1		1		3	€ 84,00	E
1000	RSV 1000 Mille	1999-2002	HBC0032	LINEA FRIZIONE					1	1	€ 28,00	E
1000	RSV 1000 Mille	2004-2007	HBC0078	LINEA FRIZIONE					1	1	€ 28,00	E
1000	SL1000 Falco	1999-2005	HBC0046	LINEA FRIZIONE					1	1	€ 28,00	E
BENELLI												
125	Adiva 125	2000-2003	HBFO101	SET UP OEM ANTERIORE	1					1	€ 28,00	E
354	354 Sport	1979	HBK0110	SET UP OEM ANTERIORE	1	1	1	1		4	€ 112,00	E
504	504 Sport	1979-1981	HBK0100	SET UP OEM ANTERIORE	1	1	1	1		4	€ 112,00	E
750	750 Sei	1972-1978	HBK0104	SET UP OEM ANTERIORE	1	2				3	€ 84,00	E
900	900 Sei	1979-1989	HBK0109	SET UP OEM ANTERIORE	1	2	1	1		5	€ 140,00	E
900	Tornado RS pinze BREMBO	2003-2011	HBK0108	SET UP RACE	1	1		1		3	€ 84,00	E
900	Tornado RS pinze BREMBO	2003-2011	HBK0107	SET UP OEM ANTERIORE	1	1	1	1		4	€ 112,00	E
900	Tornado TRE / LE	2003-2006	HBK0106	SET UP RACE	1	1		1		3	€ 84,00	E
900	Tornado TRE / LE	2003-2006	HBK0105	SET UP OEM ANTERIORE	1	1	1	1		4	€ 112,00	E
1130	TnT	2004-2006	HBK0103	SET UP RACE	1	1		1		3	€ 84,00	E
1130	TnT	2004-2006	HBK0102	SET UP OEM ANTERIORE	1	1	1	1		4	€ 112,00	E
BETA												
250	Evo 250	2009-2011	HBFO201	SET UP OEM ANTERIORE	1					1	€ 28,00	E
	Moto Cross	1998-2000	HBK0200	SET UP OEM ANTERIORE	1			1		2	€ 56,00	E
	Moto Cross		HBC0201	LINEA FRIZIONE					1	1	€ 28,00	E
BIMOTA												
1000	KB1	1977-1979	HBK0300	SET UP OEM ANTERIORE	1	2		1		4	€ 112,00	E
1000	YB8	1990-1994	HBK0302	SET UP OEM ANTERIORE	1	1	1	1		4	€ 112,00	E
1000	YB8	1990-1994	HBC0302	LINEA FRIZIONE					1	1	€ 28,00	E
1098	SB6	1991-1999	HBK0301	SET UP OEM ANTERIORE	1	2		1		4	€ 112,00	E
BMW												
1000	S1000RR	2010-2013	HBK0618	SET UP RACE	1	1		1		3	€ 84,00	E
1000	S1000RR	2010-2013	HBK0616	SET UP OEM ANTERIORE	1	1	1	1		4	€ 112,00	E
1000	S1000RR ABS	2010-2013	HBK0620	SET UP OEM ANTERIORE	4			2		6	€ 216,00	E
1000	S1000RR ABS	2014-2018	HBK0401	SET UP OEM ANTERIORE	4			2		6	€ 216,00	E
1000	S1000R ABS	2014-2016	HBK0403	SET UP OEM ANTERIORE	4			2		6	€ 216,00	E
1100	R1100 RS ABS	1993-2002	HBK0619	SET UP OEM ANTERIORE	1	2	1	1		5	€ 180,00	E
1100	R1100S	1998-2006	HBFK0004	SET UP OEM ANTERIORE	1	2		1		4	€ 112,00	E
1200	R1200 GS Adventurer	2009	HBC0411	LINEA FRIZIONE					1	1	€ 28,00	E
1200	R1200C	1997-2004	HBK0613	SET UP OEM ANTERIORE	1	1	1	1		4	€ 112,00	E
BOMBARDIER												
650	Quad : DS650	2000-2003	HBK0650	SET UP OEM ANTERIORE	1	1		1		3	€ 84,00	E
BUELL												
1000	XB9SX	2004-2009	HBK0713	SET UP OEM ANTERIORE	1			1		2	€ 56,00	E
1125	CR1125	2009-2011	HBC0714	LINEA FRIZIONE					1	1	€ 28,00	E
1125	CR1125	2009-2011	HBK0714	SET UP OEM ANTERIORE	1			1		2	€ 56,00	E
1200	M2 Cyclone	1997-1998	HBK0700	SET UP OEM ANTERIORE	1			1		2	€ 56,00	E
1200	S1 Lightning - linea posteriore non possibile	1997-1998	HBK0702	SET UP OEM ANTERIORE	1		1	1		3	€ 84,00	E
1200	S1 Lightning Strike	1997-1998	HBK0704	SET UP OEM ANTERIORE	1			1		2	€ 56,00	E
1200	S1 White Lightning	1997-1998	HBK0706	SET UP OEM ANTERIORE	1		1	1		3	€ 84,00	E
1200	X1 Lightening	1999-2001	HBK0708	SET UP OEM ANTERIORE	1			1		2	€ 56,00	E
1200	XB12R	2003-2007	HBK0712	SET UP OEM ANTERIORE	1			1		2	€ 56,00	E

CILIND.	MODELLO	ANNI	CODICE	CONFIGURAZIONE	ANT. SUP	ANT. INF	AGG	POST	FRIZ.	TOT. TUBI	PREZZO PUBBLICO IVA ESCL.	FASCIA
1200	XB12S	2003-2007	HBK0711	SET UP OEM ANTERIORE	1			1		2	€ 56,00	E
1200	XB12SS	2010	HBFO715	SET UP OEM ANTERIORE	1					1	€ 28,00	E
BULTACO												
	Moto Cross	2000-2001	HBK0750	SET UP OEM ANTERIORE	1			1		2	€ 56,00	E
	Moto Cross		HBC0752	LINEA FRIZIONE					1	1	€ 28,00	E
CAGIVA												
50	Prima 50	1992-1995	HBK0827	SET UP OEM ANTERIORE	1			1		2	€ 56,00	E
125	Blues 125	1991-1993	HBK0844	SET UP OEM ANTERIORE	1			1		2	€ 56,00	E
125	Mito	1991-1999	HBK0838	SET UP OEM ANTERIORE	1			1		2	€ 56,00	E
125	Mito Evolution	2000-2001	HBK0837	SET UP OEM ANTERIORE	1			1		2	€ 56,00	E
125	Mito Mk1	1990-1991	HBK0818	SET UP OEM ANTERIORE	1			1		2	€ 56,00	E
125	Planet 125	1998-2006	HBK0843	SET UP OEM ANTERIORE	1			1		2	€ 56,00	E
125	Super City 125	1991-2006	HBK0842	SET UP OEM ANTERIORE	1			1		2	€ 56,00	E
250	250 Ala Blu Trail	1983-1984	HBFO800	SET UP OEM ANTERIORE	1					1	€ 28,00	E
500	Canyon 500 Trail	1998-2001	HBFO814	SET UP OEM ANTERIORE	1					1	€ 28,00	E
600	Canyon 600	1995-1997	HBK0845	SET UP OEM ANTERIORE	1			1		2	€ 56,00	E
650	650 Alazzurra	1985-1988	HBK0839	SET UP RACE	1	1		1		3	€ 84,00	E
650	650 Alazzurra	1985-1988	HBK0802	SET UP OEM ANTERIORE	1	2		1		4	€ 112,00	E
650	650 Alazzurra	1985-1988	HBC0819	LINEA FRIZIONE					1	1	€ 28,00	E
650	Raptor	2000-2001	HBK0832	SET UP RACE	1	1		1		3	€ 84,00	E
650	Raptor	2000-2001	HBK0831	SET UP OEM ANTERIORE	1	1	1	1		4	€ 112,00	E
750	750 Elefant	1994-1998	HBC0835	LINEA FRIZIONE					1	1	€ 28,00	E
750	750 Elefant	1994-1998	HBK0835	SET UP OEM ANTERIORE	1			1		2	€ 56,00	E
900	900 Elefant	1995-2000	HBK0840	SET UP RACE	1	1		1		3	€ 84,00	E
900	900 Elefant	1995-2000	HBK0809	SET UP OEM ANTERIORE	1	2		1		4	€ 112,00	E
900	900 ie Elefant	1991-2000	HBC0818	LINEA FRIZIONE					1	1	€ 28,00	E
900	900 ie Elefant	1991-2000	HBK0819	SET UP OEM ANTERIORE	1			1		2	€ 56,00	E
900	Gran Canyon	1998-2000	HBK0836	SET UP OEM ANTERIORE	1	1	1	1		4	€ 112,00	E
CCM												
644	644 Dual Sport	2003-2005	HBK0881	SET UP OEM ANTERIORE	1			1		2	€ 56,00	E
650	R30	2003-2005	HBK0880	SET UP OEM ANTERIORE	1			1		2	€ 56,00	E
404	404E	2003-2004	HBK0882	SET UP OEM ANTERIORE	1			1		2	€ 56,00	E
DUCATI												
250	250 Desmo	1975	HBFO900	SET UP OEM ANTERIORE	1					1	€ 28,00	E
350	350 Desmo	1975	HBFO901	SET UP OEM ANTERIORE	1					1	€ 28,00	E
400	400 Monster	1994-2002	HBC1176	LINEA FRIZIONE					1	1	€ 28,00	E
400	400 Monster	1994-2002	HBK1176	SET UP OEM ANTERIORE	1			1		2	€ 56,00	E
400	400 SS Sports	1991-1993	HBFO902	SET UP OEM ANTERIORE	1					1	€ 28,00	E
500	500 Pantah (ALTERNATIVE)	1980-1982	HBK1096	SET UP OEM ANTERIORE	1	2				3	€ 84,00	E
500	500 SL Pantah	1980-1984	HBK0905	SET UP OEM ANTERIORE	1	2		1		4	€ 112,00	E
600	600 Monster	1994-2002	HBC1176	LINEA FRIZIONE					1	1	€ 28,00	E
600	600 Monster	1994-2002	HBK1043	SET UP OEM ANTERIORE	1			1		2	€ 56,00	E
600	600 Monster Dark	1998-2001	HBC1044	LINEA FRIZIONE					1	1	€ 28,00	E
600	600 Monster Dark	1998-2001	HBK1044	SET UP OEM ANTERIORE	1			1		2	€ 56,00	E
600	600 Pantah	1980-1985	HBC0910	LINEA FRIZIONE					1	1	€ 28,00	E
600	600 SL Pantah	1980-1984	HBK0910	SET UP OEM ANTERIORE	1	2		1		4	€ 112,00	E
600	600 SS	1993-2002	HBC1086	LINEA FRIZIONE					1	1	€ 28,00	E
600	600 SS	1994-1998	HBK1086	SET UP OEM ANTERIORE	1			1		2	€ 56,00	E
600	600 TL Pantah	1984-1985	HBK0915	SET UP OEM ANTERIORE	1	2		1		4	€ 112,00	E
620	620 Monster	1994-2002	HBC1176	LINEA FRIZIONE					1	1	€ 28,00	E
620	620 Monster	2003-2006	HBK1177	SET UP OEM ANTERIORE	1			1		2	€ 56,00	E
620	620 Sport	2003-2005	HBK1102	SET UP RACE	1	1		1		3	€ 84,00	E
650	650 GT Pantah	1983-1986	HBK0917	SET UP OEM ANTERIORE	1	2		1		4	€ 112,00	E
650	Indiana 650	1986-1987	HBK1041	SET UP OEM ANTERIORE	1			1		2	€ 56,00	E

CILIND.	MODELLO	ANNI	CODICE	CONFIGURAZIONE	ANT. SUP	ANT. INF	AGG	POST	FRIZ.	TOT. TUBI	PREZZO PUBBLICO IVA ESCL.	FASCIA
695	695 Monster	2007-2010	HBC1183	LINEA FRIZIONE					1	1	€ 28,00	E
695	695 Monster	2007-2010	HBK1182	SET UP RACE	1	1		1		3	€ 84,00	E
695	695 Monster	2007-2010	HBK1196	SET UP SOPRA PARAFANGO ANTERIORE	1	1		1		3	€ 84,00	E
695	695 Monster	2007-2010	HBK1183	SET UP OEM ANTERIORE	1	1	1	1		4	€ 112,00	E
696	696 Monster	2010-2013	HBK1223	SET UP SOPRA PARAFANGO ANTERIORE	1	1		1		3	€ 84,00	E
748	748 Biposto / SPS	1999-2003	HBK0926	SET UP RACE	1	1		1		3	€ 84,00	E
748	748 Biposto / Strada	1995-1998	HBK0919	SET UP RACE	1	1		1		3	€ 84,00	E
748	748 Biposto / Strada	1995-1998	HBK0918	SET UP OEM ANTERIORE	1	1	1	1		4	€ 112,00	E
748	748R	1999-2002	HBC1171	LINEA FRIZIONE					1	1	€ 28,00	E
748	748R	1999-2002	HBK1171	SET UP RACE	1	1		1		3	€ 84,00	E
748	748R	2000-2002	HBC1172	LINEA FRIZIONE					1	1	€ 28,00	E
749	749	2003-2005	HBC1100	LINEA FRIZIONE					1	1	€ 28,00	E
749	749	2003-2005	HBK1100	SET UP SOPRA PARAFANGO ANTERIORE	1	1		1		3	€ 84,00	E
749	749	2003-2005	HBK1170	SET UP OEM ANTERIORE	1	1	1	1		4	€ 112,00	E
750	750 F1 Mk II	1985-1988	HBC0951	LINEA FRIZIONE					1	1	€ 28,00	E
750	750 F1 Mk II	1985-1988	HBK0951	SET UP OEM ANTERIORE	1	2		1		4	€ 112,00	E
750	750 F1 Montjuic	1987-1988	HBK0955	SET UP OEM ANTERIORE	1	2		1		4	€ 112,00	E
750	750 Monster	1994-2002	HBC1176	LINEA FRIZIONE					1	1	€ 28,00	E
750	750 Monster	1994-2002	HBK1130	SET UP OEM ANTERIORE	1			1		2	€ 56,00	E
750	750 Paso	1986-1994	HBC0956	LINEA FRIZIONE					1	1	€ 28,00	E
750	750 Paso	1986-1994	HBK1172	SET UP RACE	1	1		1		3	€ 84,00	E
750	750 Paso	1986-1994	HBK0956	SET UP OEM ANTERIORE	1	2		1		4	€ 112,00	E
750	750 Sport	1988-1990	HBC0961	LINEA FRIZIONE					1	1	€ 28,00	E
750	750 Sport	1988-1990	HBK0961	SET UP OEM ANTERIORE	1	2		1		4	€ 112,00	E
750	750 Sport	2003-2004	HBK1107	SET UP RACE	1	1		1		3	€ 84,00	E
750	750 SS	1991-1993	HBK1166	SET UP OEM ANTERIORE	1			1		2	€ 56,00	E
750	750 SS	1993-2002	HBC1165	LINEA FRIZIONE					1	1	€ 28,00	E
750	750 SS	1994-1997	HBK1165	SET UP RACE	1	1		1		3	€ 84,00	E
750	750 SS	1998-2002	HBK1144	SET UP RACE	1	1		1		3	€ 84,00	E
750	750 SS	2003-2004	HBK1106	SET UP RACE	1	1		1		3	€ 84,00	E
800	800 Sport	2003-2004	HBK1109	SET UP RACE	1	1		1		3	€ 84,00	E
800	800 SS	2003-2004	HBK1108	SET UP RACE	1	1		1		3	€ 84,00	E
800	800 SS	2003-2004	HBK1210	SET UP OEM ANTERIORE	1	1	1	1		4	€ 112,00	E
800	S2R 800	2004-2008	HBK1184	SET UP OEM ANTERIORE	1	1	1	1		4	€ 112,00	E
800	S2R 800	2007-2008	HBK1185	SET UP RACE	1	1		1		3	€ 84,00	E
848	848	2008-2009	HBK1205	SET UP SOPRA PARAFANGO ANTERIORE	1	1		1		3	€ 84,00	E
848	848	2008-2009	HBK1206	SET UP RACE	1	1		1		3	€ 84,00	E
848	848 / 848 EVO	2008-2013	HBC1206	LINEA FRIZIONE					1	1	€ 28,00	E
848	848 Evo	2010-2013	HBK1214	SET UP SOPRA PARAFANGO ANTERIORE	1	1		1		3	€ 84,00	E
848	848 Evo	2010-2013	HBK1215	SET UP RACE	1	1		1		3	€ 84,00	E
848	848 Streetfighter	2012-2013	HBC1221	LINEA FRIZIONE					1	1	€ 28,00	E
848	848 Streetfighter	2012-2013	HBK1221	SET UP RACE	1	1		1		3	€ 84,00	E
848	848 Streetfighter	2012-2013	HBK1222	SET UP SOPRA PARAFANGO ANTERIORE	1	1		1		3	€ 84,00	E
851	851	1987-1989	HBC0967	LINEA FRIZIONE					1	1	€ 28,00	E
851	851 SP1 & SP2	1992-1993	HBK0967	SET UP OEM ANTERIORE	1	1		1		3	€ 84,00	E
851	851 Strada	1987-1989	HBK0966	SET UP OEM ANTERIORE	1	2		1		4	€ 112,00	E
851	851 Strada	1992-1993	HBK0968	SET UP OEM ANTERIORE	1	1		1		3	€ 84,00	E
860	860 Darmah	1982	HBK0969	SET UP OEM ANTERIORE	1	2		2		5	€ 140,00	E
860	860 MHR	1981	HBK0973	SET UP OEM ANTERIORE	1	2		1		4	€ 112,00	E
860	860 GT	1974-1975	HBK0971	SET UP OEM ANTERIORE	1	2				3	€ 84,00	E
860	860 GTS	1976-1978	HBK0972	SET UP OEM ANTERIORE	1	2				3	€ 84,00	E

CILIND.	MODELLO	ANNI	CODICE	CONFIGURAZIONE	ANT. SUP	ANT. INF	AGG	POST	FRIZ.	TOT. TUBI	PREZZO PUBBLICO IVA ESCL.	FASCIA
888	888 SP2	1980	HBK1217	SET UP OEM ANTERIORE	1	2		1		4	€ 112,00	E
888	888 Strada	1992-1994	HBC1126	LINEA FRIZIONE					1	1	€ 28,00	E
888	888 Strada	1992-1994	HBK1126	SET UP OEM ANTERIORE	1	1		1		3	€ 84,00	E
899	899 Panigale ABS	2014-2015	HBK1899	SET UP OEM ANTERIORE	1	1	1	1		4	€ 144,00	E
899	899 / 1199 Panigale	2012-2014	HBC1899	LINEA FRIZIONE					1	1	€ 28,00	E
900	900 GTS	1976-1978	HBK1211	SET UP OEM ANTERIORE	1	2				3	€ 84,00	E
900	900 S2	1985	HBK0982	SET UP OEM ANTERIORE	1	2		1		4	€ 112,00	E
900	900 S2	1983-1984	HBK0981	SET UP OEM ANTERIORE	1	2		1		4	€ 112,00	E
900	900 SD Darmah Supersport	1978	HBK1199	SET UP OEM ANTERIORE	1	2		1		4	€ 112,00	E
900	900 SD Darmah Supersport	1980	HBK0979	SET UP OEM ANTERIORE	1	2	1	1		5	€ 140,00	E
900	900 SD Darmah Supersport	1981	HBK0980	SET UP OEM ANTERIORE	1	2		1		4	€ 112,00	E
900	900 SL	1991-1993	HBK1160	SET UP RACE	1	1		1		3	€ 84,00	E
900	900 SL	1991-2002	HBC1160	LINEA FRIZIONE					1	1	€ 28,00	E
900	900 SL pinza inferiore	1994-1997	HBK1157	SET UP RACE	1	1		1		3	€ 84,00	E
900	900 Sport	1989	HBC0986	LINEA FRIZIONE					1	1	€ 28,00	E
900	900 Sport	1989	HBK0986	SET UP OEM ANTERIORE	1	2		1		4	€ 112,00	E
900	900 Sport	2003	HBK1105	SET UP RACE	1	1		1		3	€ 84,00	E
900	900 SS	2003	HBK1104	SET UP RACE	1	1		1		3	€ 84,00	E
900	900 SS	1978-1980	HBK0987	SET UP OEM ANTERIORE	1	2		1		4	€ 112,00	E
900	900 SS	1981-1990	HBK0989	SET UP OEM ANTERIORE	1	2		1		4	€ 112,00	E
900	900 SS	1991-1993	HBK1163	SET UP RACE	1	1		1		3	€ 84,00	E
900	900 SS	1991-2002	HBC1163	LINEA FRIZIONE					1	1	€ 28,00	E
900	900 SS	1994-1997	HBK1153	SET UP RACE	1	1		1		3	€ 84,00	E
900	900 SS	1998-2002	HBK1193	SET UP OEM ANTERIORE	1	1		1		3	€ 84,00	E
900	900 SS Desmo	1974	HBK0991	SET UP OEM ANTERIORE	1	2		1		4	€ 112,00	E
900	900 SS MHR	1981	HBK1219	SET UP OEM ANTERIORE	1	2		1		4	€ 112,00	E
900	900 SS pinza inferiore - posteriore	2002	HBK1120	SET UP RACE	1	1		1		3	€ 84,00	E
900	900 Superlight II	1998-2002	HBK1149	SET UP RACE	1	1		1		3	€ 84,00	E
900	900 Superlight IV	2004-2005	HBK1220	SET UP RACE	1	1		1		3	€ 84,00	E
900	M900	1993-2000	HBC1056	LINEA FRIZIONE					1	1	€ 28,00	E
900	M900 Monster	1993-1999	HBK1167	SET UP RACE	1	1		1		3	€ 84,00	E
900	M900 Monster	1993-1999	HBK1056	SET UP OEM ANTERIORE	1	2		1		4	€ 112,00	E
900	MHR900R	1983-1984	HBC1224	LINEA FRIZIONE					1	1	€ 28,00	E
900	MHR900R	1983-1984	HBK1224	SET UP OEM ANTERIORE	1	2		1		4	€ 112,00	E
906	906 Paso	1986-1994	HBC1128	LINEA FRIZIONE					1	1	€ 28,00	E
906	906 Paso	1986-1994	HBK1128	SET UP OEM ANTERIORE	1	2		1		4	€ 112,00	E
906	906 Paso	1986-1994	HBK1173	SET UP RACE	1	1		1		3	€ 84,00	E
907	907 IE	1991-1994	HBK1000	SET UP OEM ANTERIORE	1	2		1		4	€ 112,00	E
916	916 BIP / Strada / SP / SPS	1994-2000	HBC1004	LINEA FRIZIONE					1	1	€ 28,00	E
916	916 Biposto / SPS	1998-2000	HBK1014	SET UP RACE	1	1		1		3	€ 84,00	E
916	916 Biposto / Strada / SP	1994-1997	HBK1009	SET UP RACE	1	1		1		3	€ 84,00	E
916	916 Biposto / Strada / SP	1994-1997	HBK1004	SET UP OEM ANTERIORE	1	1	1	1		4	€ 112,00	E
916	Monster S4	2001-2007	HBC1168	LINEA FRIZIONE					1	1	€ 28,00	E
916	Monster S4	2001-2007	HBK1169	SET UP RACE	1	1		1		3	€ 84,00	E
916	Monster S4	2001-2007	HBK1168	SET UP OEM ANTERIORE	1	1	1	1		4	€ 112,00	E
916	Monster S4S	2004-2007	HBC1197	LINEA FRIZIONE					1	1	€ 28,00	E
916	ST4	1998-2002	HBK1095	SET UP RACE	1	1		1		3	€ 84,00	E
916	ST4	1998-2002	HBK1082	SET UP OEM ANTERIORE	1	1	1	1		4	€ 112,00	E
916	ST4	1998-2004	HBC1072	LINEA FRIZIONE					1	1	€ 28,00	E
939	Supersport / Supersport S ABS	2017-2019	HBK0916	SET UP OEM ANTERIORE	3			2		5	€ 140,00	E
944	ST2	1997-2002	HBK1077	SET UP RACE	1	1		1		3	€ 84,00	E
944	ST2	1997-2002	HBK1072	SET UP OEM ANTERIORE	1	1	1	1		4	€ 112,00	E

CILIND.	MODELLO	ANNI	CODICE	CONFIGURAZIONE	ANT. SUP	ANT. INF	AGG	POST	FRIZ.	TOT. TUBI	PREZZO PUBBLICO IVA ESCL.	FASCIA
944	ST2	1998-2004	HBC1072	LINEA FRIZIONE					1	1	€ 28,00	E
996	996	1999-2000	HBK1175	SET UP RACE	1	1		1		3	€ 84,00	E
996	996 Biposto / SPS	1999-2002	HBK1174	SET UP RACE	1	1		1		3	€ 84,00	E
996	996 Biposto / SPS / R	1999-2002	HBC1174	LINEA FRIZIONE					1	1	€ 28,00	E
996	996 R	2001	HBK1216	SET UP RACE	1	1		1		3	€ 84,00	E
996	Monster S4R	2005-2010	HBC1212	LINEA FRIZIONE					1	1	€ 28,00	E
996	Monster S4R	2005-2010	HBK1213	SET UP RACE	1	1		1		3	€ 84,00	E
996	Monster S4R	2005-2010	HBK1212	SET UP OEM ANTERIORE	1	1	1	1		4	€ 112,00	E
998	998	2002-2004	HBC1164	LINEA FRIZIONE					1	1	€ 28,00	E
998	998	2002-2004	HBK1164	SET UP RACE	1	1		1		3	€ 84,00	E
998	999	2003-2006	HBK1099	SET UP SOPRA PARAFANGO ANTERIORE	1	1		1		3	€ 84,00	E
998	998R	2002-2004	HBK1162	SET UP OEM ANTERIORE	1	1	1	1		4	€ 112,00	E
998	998S	2002-2004	HBK1207	SET UP RACE	1	1		1		3	€ 84,00	E
998	999S	2003-2006	HBC1202	LINEA FRIZIONE					1	1	€ 28,00	E
998	999S	2003-2006	HBK1202	SET UP SOPRA PARAFANGO ANTERIORE	1	1		1		3	€ 84,00	E
998	999S	2005-2006	HBK1203	SET UP RACE	1	1		1		3	€ 84,00	E
998	Monster S4R	2004-2007	HBK1198	SET UP RACE	1	1		1		3	€ 84,00	E
998	Monster S4R	2004-2007	HBK1197	SET UP OEM ANTERIORE	1	1	1	1		4	€ 112,00	E
1000	1000 MHR Mille	1979-1984	HBC1204	LINEA FRIZIONE					1	1	€ 28,00	E
1000	1000 MHR Mille	1985-1987	HBK1204	SET UP OEM ANTERIORE	1	2		1		4	€ 112,00	E
1000	1000 SS Paul Smart Replica	2008-2009	HBC1194	LINEA FRIZIONE					1	1	€ 28,00	E
1000	1000 SS Paul Smart Replica	2008-2009	HBK1194	SET UP OEM ANTERIORE	1	1	1			3	€ 84,00	E
1000	1000DS Multistrada	2003-2006	HBC1101	LINEA FRIZIONE					1	1	€ 28,00	E
1000	1000DS Multistrada	2003-2006	HBK1101	SET UP RACE	1	1		1		3	€ 84,00	E
1000	GT1000	2007-2010	HBK1218	SET UP OEM ANTERIORE	1	1	1			3	€ 84,00	E
1000	S2R 1000	2007-2008	HBK1187	SET UP RACE	1	1		1		3	€ 84,00	E
1000	S2R 1000	2007-2008	HBK1186	SET UP OEM ANTERIORE	1	1	1	1		4	€ 112,00	E
1000	S2R 1000 / 800	2004-2008	HBC1186	LINEA FRIZIONE					1	1	€ 28,00	E
1100	Monster 1100S	2009-2010	HBC0903	LINEA FRIZIONE					1	1	€ 28,00	E
1100	Monster 1100S	2009-2010	HBK0903	SET UP OEM ANTERIORE	1	1		1		3	€ 84,00	E
1200	Multistrada 1200S	2010-2014	HBC0904	LINEA FRIZIONE					1	1	€ 28,00	E
1200	Multistrada 1200S ABS	2015-2016	HBK1901	SET UP OEM ANTERIORE	1	1	1	1		4	€ 144,00	E
1098	1098	2007-2008	HBC1073	LINEA FRIZIONE					1	1	€ 28,00	E
1098	1098 / S / Tricolore	2007-2008	HBK1192	SET UP SOPRA PARAFANGO ANTERIORE	1	1		1		3	€ 84,00	E
1098	1098 / S / Tricolore	2007-2008	HBK1195	SET UP RACE	1	1		1		3	€ 84,00	E
1098	Streetfighter 1098	2010-2013	HBC1222	LINEA FRIZIONE					1	1	€ 28,00	E
1100	Hypermotard 1100 / S	2007-2010	HBK1180	SET UP SOPRA PARAFANGO ANTERIORE	1	1		1		3	€ 84,00	E
1100	Hypermotard 1100 / S	2007-2010	HBK1181	SET UP RACE	1	1		1		3	€ 84,00	E
1100	Hypermotard 1100 / S	2007-2010	HBK1200	SET UP OEM ANTERIORE	1	1	1	1		4	€ 112,00	E
1100	Hypermotard 1100 EVO SP	2010-2012	HBC1003	LINEA FRIZIONE					1	1	€ 28,00	E
1100	Hypermotard 1100 EVO SP	2010-2012	HBK1003	SET UP SOPRA PARAFANGO ANTERIORE	1	1				2	€ 56,00	E
1100	Multistrada 1100 / S	2007-2010	HBC1188	LINEA FRIZIONE					1	1	€ 28,00	E
1100	Multistrada DS	2008	HBFKK0011	SET UP OEM ANTERIORE	3			1		4	€ 112,00	E
1100	Panigale 1199 / 1299	2012-2016	HBFKK0009	SET UP RACE	2			1		3	€ 84,00	E
1100	Panigale V4	2017-2018	HBFKK0008	SET UP RACE	3			1		4	€ 112,00	E
1198	1198	2009-2012	HBK1208	SET UP SOPRA PARAFANGO ANTERIORE	1	1		1		3	€ 84,00	E
1198	1198	2009-2012	HBK1209	SET UP RACE	1	1		1		3	€ 84,00	E
1199	1199 Panigale ABS	2012-2014	HBK1900	SET UP OEM ANTERIORE	4			2		6	€ 216,00	E

CILIND.	MODELLO	ANNI	CODICE	CONFIGURAZIONE	ANT. SUP	ANT. INF	AGG	POST	FRIZ.	TOT. TUBI	PREZZO PUBBLICO IVA ESCL.	FASCIA
GARINNI												
125	GR125 ST	2010	HBK1290	SET UP OEM ANTERIORE	1			1		2	€ 56,00	E
125	GR125 T3	2010	HBK1292	SET UP OEM ANTERIORE	1					1	€ 28,00	E
150	GR150 ST	2010	HBK1291	SET UP OEM ANTERIORE	1			1		2	€ 56,00	E
150	GR150 TI	2010	HBK1293	SET UP OEM ANTERIORE	1					1	€ 28,00	E
250	GR250 T3	2010	HBK1294	SET UP OEM ANTERIORE	1			1		2	€ 56,00	E
GAS GAS												
200	EC200	2000-2005	HBC1301	LINEA FRIZIONE					1	1	€ 28,00	E
200	EC200 Enduro	1996-2002	HBK1302	SET UP OEM ANTERIORE	1			1		2	€ 56,00	E
250	EC250	2008	HBK1304	SET UP OEM ANTERIORE	1			1		2	€ 56,00	E
250	EC250	1996-2002	HBK1303	SET UP OEM ANTERIORE	1			1		2	€ 56,00	E
250	EC250	2000-2005	HBC1301	LINEA FRIZIONE					1	1	€ 28,00	E
250	EC250 Enduro	1996-2002	HBK1302	SET UP OEM ANTERIORE	1			1		2	€ 56,00	E
270	270 TXT	1999-2003	HBK1305	SET UP OEM ANTERIORE	1					1	€ 28,00	E
300	EC300	1996-2002	HBK1301	SET UP OEM ANTERIORE	1			1		2	€ 56,00	E
300	EC300	2000-2005	HBC1301	LINEA FRIZIONE					1	1	€ 28,00	E
300	EC300 Enduro	1996-2002	HBK1302	SET UP OEM ANTERIORE	1			1		2	€ 56,00	E
	Moto Cross	2000	HBK1300	SET UP OEM ANTERIORE	1			1		2	€ 56,00	E
GILERA												
50	DNA 50	2000-2005	HBK1406	SET UP OEM ANTERIORE	1			1		2	€ 56,00	E
50	GSM50	2000-2001	HBK1401	SET UP OEM ANTERIORE	1					1	€ 28,00	E
125	DNA 125	2000-2005	HBK1407	SET UP OEM ANTERIORE	1			1		2	€ 56,00	E
125	GFR125	1993-1994	HBK1400	SET UP OEM ANTERIORE	1					1	€ 28,00	E
125	Runner FX125	1997-2001	HBK1402	SET UP OEM ANTERIORE	1			1		2	€ 56,00	E
125	Runner VX125	2000-2005	HBK1409	SET UP OEM ANTERIORE	1					1	€ 28,00	E
180	Runner FXR180	1998-2001	HBK1403	SET UP OEM ANTERIORE	1			1		2	€ 56,00	E
180	Runner FXR180 SP	2000-2001	HBK1404	SET UP OEM ANTERIORE	1			1		2	€ 56,00	E
200	Runner VXR200	2003-2010	HBK1410	SET UP OEM ANTERIORE	1			1		2	€ 56,00	E
500	Saturno 500	1990-1993	HBK1405	SET UP OEM ANTERIORE	1			1		2	€ 56,00	E
600	Nord West 600	1991-1993	HBK1408	SET UP OEM ANTERIORE	1	1		1		3	€ 84,00	E
HARLEY DAVIDSON												
500	FLHXI Street Glide	2006-2007	HBK1506	SET UP OEM ANTERIORE	1	2				3	€ 84,00	E
750	XG750 Street 750	2016	HBK1501	SET UP OEM ANTERIORE	1			1		2	€ 56,00	E
883	883 Hugger	2005-2011	HBK1821	SET UP OEM ANTERIORE	1					1	€ 28,00	E
883	XL883 Nightstar Iron	2008-2013	HBK1825	SET UP OEM ANTERIORE	1					1	€ 28,00	E
883	XLH Hugger 883	1987-2001	HBK1757	SET UP OEM ANTERIORE	1			1		2	€ 56,00	E
883	XLH Sportster 883	1985-2002	HBK1783	SET UP OEM ANTERIORE	1			1		2	€ 56,00	E
883	XLH Sportster 883	2003-2005	HBK1811	SET UP OEM ANTERIORE	1	2		1		4	€ 112,00	E
883	XLH Sportster 883	2006-2011	HBK1809	SET UP OEM ANTERIORE	1	2				3	€ 84,00	E
883	XLH Sportster 883R	2002-2005	HBK1812	SET UP RACE	1	1		1		3	€ 84,00	E
883	XLH Sportster De Luxe 883	1985-1992	HBK1800	SET UP OEM ANTERIORE	1			1		2	€ 56,00	E
1000	XLH 1000	1978-1985	HBK1749	SET UP OEM ANTERIORE	1	2				3	€ 84,00	E
1000	XLS 1000	1984-1985	HBK1808	SET UP OEM ANTERIORE	1					1	€ 28,00	E
1200	XL1200 Sportster	2006-2011	HBK1816	SET UP OEM ANTERIORE	1			1		2	€ 56,00	E
1200	XL1200 X-48	2010-2011	HBK1824	SET UP OEM ANTERIORE	1					1	€ 28,00	E
1200	XL1200C Sportster Custom - doppio disco	1995-2001	HBK1734	SET UP OEM ANTERIORE	1	2		1		4	€ 112,00	E
1200	XL1200C Sportster Custom - Standard	1995-2001	HBK1735	SET UP OEM ANTERIORE	1			1		2	€ 56,00	E
1200	XL1200S Sportster Sport	1999-2001	HBK1742	SET UP OEM ANTERIORE	1	2		1		4	€ 112,00	E
1200	XLH Sportster 1200	1987-1996	HBK1772	SET UP OEM ANTERIORE	1			1		2	€ 56,00	E
1200	XLH Sportster 1200	1997-1999	HBK1780	SET UP OEM ANTERIORE	1			1		2	€ 56,00	E
1200	XLH1200	2001-2003	HBK1826	SET UP OEM ANTERIORE	1	2				3	€ 84,00	E
1200	XR1200	2008-2010	HBK1502	SET UP SOPRA PARAFANGO ANTERIORE	1	1		1		3	€ 84,00	E

CILIND.	MODELLO	ANNI	CODICE	CONFIGURAZIONE	ANT. SUP.	ANT. INF.	AGG.	POST.	FRIZ.	TOT. TUBI	PREZZO PUBBLICO IVA ESCL.	FASCIA
1200	XR1200	2008-2010	HBK1819	SET UP OEM ANTERIORE	1	2		1		4	€ 112,00	E
1584	FXDF1584 Fat Bob	2007-2010	HBK1827	SET UP OEM ANTERIORE	1	2		1		4	€ 112,00	E
	FLHC Electra Glide Classic	1982-1984	HBK1500	SET UP OEM ANTERIORE	1	2	1	1		5	€ 140,00	E
	FLHR Road King	1994-2001	HBK1503	SET UP OEM ANTERIORE	1	2	1	1		5	€ 140,00	E
	FLHR Road King Injection	1995-1997	HBK1508	SET UP OEM ANTERIORE	1	2	1	1		5	€ 140,00	E
	FLHS Electra Glide Sport	1987-1992	HBK1511	SET UP OEM ANTERIORE	1	2	1	1		5	€ 140,00	E
	FLHTC Electra Glide Classic	1985-1993	HBK1517	SET UP OEM ANTERIORE	1	2	1	1		5	€ 140,00	E
	FLHTC Electra Ultra Glide Classic	2000-2006	HBK1822	SET UP OEM ANTERIORE	1	2		1		4	€ 112,00	E
	FLHTC-U Ultra Classic Electra Glide	1988-1994	HBK1526	SET UP OEM ANTERIORE	1	2	1	1		5	€ 140,00	E
	FLHTC-UI Ultra Classic Electra Glide	1995-2001	HBK1533	SET UP OEM ANTERIORE	1	2		1		4	€ 112,00	E
	FLST Heritage Softail	1986-1990	HBK1540	SET UP OEM ANTERIORE	1		1	1		3	€ 84,00	E
	FLSTC Heritage Softail Classic	1987-2003	HBK1545	SET UP OEM ANTERIORE	1		1	1		3	€ 84,00	E
	FLSTF Fat Boy	1989-2006	HBK1558	SET UP OEM ANTERIORE	1		1	1		3	€ 84,00	E
	FLSTF Fat Boy	2007-2011	HBK1823	SET UP OEM ANTERIORE	1					1	€ 28,00	E
	FLSTI Heritage	2006	HBK1541	SET UP OEM ANTERIORE	1					1	€ 28,00	E
	FLSTN Heritage Softail Nostalgia	1993-1998	HBK1569	SET UP OEM ANTERIORE	1		1	1		3	€ 84,00	E
	FLTC Tour Glide Classic	1984-1993	HBK1575	SET UP OEM ANTERIORE	1	2	1	1		5	€ 140,00	E
	FLTC-U Ultra Classic Tour Glide	1988-1991	HBK1585	SET UP OEM ANTERIORE	1	2	1	1		5	€ 140,00	E
	FLTRI Road Glide	1998-2000	HBK1813	SET UP OEM ANTERIORE	1	2	1	1		5	€ 140,00	E
	FXD Super Glide	1994-1997	HBK1589	SET UP OEM ANTERIORE	1			1		2	€ 56,00	E
	FXDB Dyna Daytona	1991-1993	HBK1593	SET UP OEM ANTERIORE	1	2		1		4	€ 112,00	E
	FXDB Street Bob	2006-2010	HBK1814	SET UP OEM ANTERIORE	1			1		2	€ 56,00	E
	FXDC Dyna Glide Custom	1991-1993	HBK1596	SET UP OEM ANTERIORE	1	2		1		4	€ 112,00	E
	FXDC Dyna Super Glide Custom	2008-2010	HBK1818	SET UP OEM ANTERIORE	1					1	€ 28,00	E
	FXDL Dyna Lowrider	1992-1998	HBK1599	SET UP OEM ANTERIORE	1	2		1		4	€ 112,00	E
	FXDS-C Dyna Low Rider Convertible	1994-1997	HBK1605	SET UP OEM ANTERIORE	1	2		1		4	€ 112,00	E
	FXDWG Dyna Wide Glide	1992-2001	HBK1609	SET UP OEM ANTERIORE	1			1		2	€ 56,00	E
	FXDX Dyna Super Glide Sport	1998-2007	HBK1619	SET UP OEM ANTERIORE	1	2		1		4	€ 112,00	E
	FXDX Super Glide Sport	1998-2001	HBK1623	SET UP OEM ANTERIORE	1	2		1		4	€ 112,00	E
	FXE Super Glide	1980-1984	HBK1627	SET UP OEM ANTERIORE	1			1		2	€ 56,00	E
	FXEF Super Glide Fat Bob	1984-1985	HBK1632	SET UP OEM ANTERIORE	1			1		2	€ 56,00	E
	FXLR Low Rider Custom	1991-1994	HBK1634	SET UP OEM ANTERIORE	1		1	1		3	€ 84,00	E
	FXR Super Glide Custom	1985-1994	HBK1638	SET UP OEM ANTERIORE	1			1		2	€ 56,00	E
	FXRS Low Rider	1991-1992	HBK1648	SET UP OEM ANTERIORE	1		1	1		3	€ 84,00	E
	FXRS Super Glide	1982-1990	HBK1650	SET UP OEM ANTERIORE	1		1	1		3	€ 84,00	E
	FXRS-C Low Rider Convertible	1989-1993	HBK1660	SET UP OEM ANTERIORE	1	2	1	1		5	€ 140,00	E
	FXRS-SP Low Rider Sport	1985-1993	HBK1665	SET UP OEM ANTERIORE	1	2	1	1		5	€ 140,00	E
	FXRT Sport Glide Tourer	1983-1993	HBK1674	SET UP OEM ANTERIORE	1	1	1	1		4	€ 112,00	E
	FXRT Super Glide Fat Bob	1985	HBK1684	SET UP OEM ANTERIORE	1	2	1	1		5	€ 140,00	E
	FXSB Low Rider	1982-1984	HBK1685	SET UP OEM ANTERIORE	1		1	1		3	€ 84,00	E
	FXST Softail	1983-1990	HBK1688	SET UP OEM ANTERIORE	1		1	1		3	€ 84,00	E
	FXST Softail Standard	1998-2002	HBK1696	SET UP OEM ANTERIORE	1		1	1		3	€ 84,00	E
	FXSTB Night Train Soft Tail	2000-2007	HBK1815	SET UP OEM ANTERIORE	1			1		2	€ 56,00	E
	FXSTB Softail Night Train	1998-1999	HBK1698	SET UP OEM ANTERIORE	1		1	1		3	€ 84,00	E
	FXSTC Softail Custom	1985-1998	HBK1700	SET UP OEM ANTERIORE	1		1	1		3	€ 84,00	E
	FXSTC Softail Custom	2008-2010	HBK1817	SET UP OEM ANTERIORE	1					1	€ 28,00	E
	FXSTS SE3 CVO Softail Springer	2009	HBK1801	SET UP OEM ANTERIORE	1					1	€ 28,00	E
	FXSTS Springer Softail	1988-1998	HBK1714	SET UP OEM ANTERIORE	1		1	1		3	€ 84,00	E

CILIND.	MODELLO	ANNI	CODICE	CONFIGURAZIONE	ANT. SUP	ANT. INF	AGG	POST	FRIZ.	TOT. TUBI	PREZZO PUBBLICO IVA ESCL.	FASCIA
	FXSTS Softail Springer	2009	HBC1801	LINEA FRIZIONE					1	1	€ 56,00	E
	FXSTSB Bad Boy	1994-1996	HBK1725	SET UP OEM ANTERIORE	1		1	1		3	€ 84,00	E
	FXWG Wide Glide	1980-1985	HBK1728	SET UP OEM ANTERIORE	1	2	1	1		5	€ 140,00	E
	MT350	1993-2000	HBK1505	SET UP OEM ANTERIORE	1			1		2	€ 56,00	E
	Sportster Low	2009-2010	HBK1820	SET UP OEM ANTERIORE	1					1	€ 28,00	E
	V-Rod VRSC	2001-2006	HBC1810	LINEA FRIZIONE					1	1	€ 28,00	E
	V-Rod VRSC	2001-2006	HBK1810	SET UP OEM ANTERIORE	1	2	1	1		5	€ 140,00	E
	VRSCDX Night Rod Special	2007-2010	HBC1504	LINEA FRIZIONE					1	1	€ 28,00	E
	VRSCDX Night Rod Special	2007-2010	HBK1504	SET UP OEM ANTERIORE	1	2		1		4	€ 112,00	E
	XL53C Sportster Custom 53	1998-2001	HBK1745	SET UP OEM ANTERIORE	1			1		2	€ 56,00	E
HONDA												
50	XR50 / XR100 Motard	2005-2009	HBK2561	SET UP OEM ANTERIORE	1					1	€ 28,00	E
80	CR80	1998-2002	HBK2757	SET UP OEM ANTERIORE	1			1		2	€ 56,00	E
80	MBX80 FWDD	1983-1986	HBK2280	SET UP OEM ANTERIORE	1	2				3	€ 84,00	E
125	ANF125i Innova	2003-2009	HBK2770	SET UP OEM ANTERIORE	1					1	€ 28,00	E
125	CB125R-SD	1983-1986	HBK2031	SET UP OEM ANTERIORE	1					1	€ 28,00	E
125	CB125T-DC Superdream	1982-1988	HBK2035	SET UP OEM ANTERIORE	1					1	€ 28,00	E
125	CBF125	2009	HBK2826	SET UP OEM ANTERIORE	1					1	€ 28,00	E
125	CBR125R	2004-2010	HBK2672	SET UP OEM ANTERIORE	1			1		2	€ 56,00	E
125	CBR125R	2011-2016	HBK2872	SET UP OEM ANTERIORE	1			1		2	€ 56,00	E
125	CG125 ES4 ES8	2004-2008	HBK2820	SET UP OEM ANTERIORE	1					1	€ 28,00	E
125	CG125 Titan ES	2000-2004	HBK2846	SET UP OEM ANTERIORE	1					1	€ 28,00	E
125	CLR125 City Fly	1998-2003	HBK2671	SET UP OEM ANTERIORE	1					1	€ 28,00	E
125	CR125	1992-1994	HBK2707	SET UP OEM ANTERIORE	1			1		2	€ 56,00	E
125	CR125	1995-2003	HBK2705	SET UP OEM ANTERIORE	1			1		2	€ 56,00	E
125	CR125	2004-2006	HBK2716	SET UP OEM ANTERIORE	1			1		2	€ 56,00	E
125	CR125 R	2006-2008	HBK2759	SET UP OEM ANTERIORE	1			1		2	€ 56,00	E
125	MBX125 F-E	1984-1985	HBK2278	SET UP OEM ANTERIORE	1					1	€ 28,00	E
125	ML125	1980-1985	HBK2841	SET UP OEM ANTERIORE	1					1	€ 28,00	E
125	ML125	1986-2000	HBK2842	SET UP OEM ANTERIORE	1					1	€ 28,00	E
125	MSX125 - Non ABS	2013-2017	HBK2295	SET UP OEM ANTERIORE	1			1		2	€ 56,00	E
125	MSX125 ABS	2017-2018	HBK2296	SET UP OEM ANTERIORE	2			2		4	€ 144,00	E
125	MTX125 RWF - WL	1985-1994	HBK2284	SET UP OEM ANTERIORE	1					1	€ 28,00	E
125	NS125 FG - FH	1986-1990	HBK2298	SET UP OEM ANTERIORE	1			1		2	€ 56,00	E
125	NS125 RK - RL Supersport	1988-1989	HBK2305	SET UP OEM ANTERIORE	1	2		1		4	€ 112,00	E
125	NSR125 RK - R3	1990-2003	HBK2311	SET UP OEM ANTERIORE	1			1		2	€ 56,00	E
125	RS125	2009	HBK2850	SET UP OEM ANTERIORE	1			1		2	€ 56,00	E
125	RS125	1989-1994	HBK2347	SET UP OEM ANTERIORE	1					1	€ 28,00	E
125	RS125 W Road Racer	1991	HBK2348	SET UP OEM ANTERIORE	2			1		3	€ 84,00	E
125	SES125 Dylan	2000-2007	HBK2771	SET UP OEM ANTERIORE	1					1	€ 28,00	E
125	SH125	2001-2004	HBK2016	SET UP OEM ANTERIORE	1					1	€ 28,00	E
125	SH125i	2005-2008	HBK2766	SET UP OEM ANTERIORE	1					1	€ 28,00	E
125	VT125C Shadow	2004-2008	HBK2683	SET UP OEM ANTERIORE	1					1	€ 28,00	E
125	XL125 RF	1985-1987	HBK2534	SET UP OEM ANTERIORE	1					1	€ 28,00	E
125	XL125 RT	1980	HBK2536	SET UP OEM ANTERIORE	1					1	€ 28,00	E
125	XL125V Varadero	2000-2003	HBK2876	SET UP OEM ANTERIORE	1			1		2	€ 56,00	E
125	XL125V Varadero	2004-2005	HBK2682	SET UP OEM ANTERIORE	1			1		2	€ 56,00	E
125	XL125V Varadero	2007-2008	HBK2775	SET UP OEM ANTERIORE	1			1		2	€ 56,00	E
125	XR125L	2003-2008	HBK2781	SET UP OEM ANTERIORE	1					1	€ 28,00	E
125	RS125	1995-2003	HBK2021	SET UP OEM ANTERIORE	1			1		2	€ 56,00	E
125	Z125 Monkey ABS - Z125MAK	2018-2020	HBK2036	SET UP OEM ANTERIORE	3			1		4	€ 112,00	E
150	CBX150 Aero	1990-1997	HBK2838	SET UP OEM ANTERIORE	1					1	€ 28,00	E
150	CG150 Titan	2009-2010	HBK2840	SET UP OEM ANTERIORE	1					1	€ 28,00	E

CILIND.	MODELLO	ANNI	CODICE	CONFIGURAZIONE	ANT. SUP	ANT. INF	AGG	POST	FRIZ.	TOT. TUBI	PREZZO PUBBLICO IVA ESCL.	FASCIA
150	CRF150R	2007-2017	HBK2760	SET UP OEM ANTERIORE	1			1		2	€ 56,00	E
150	NXR150 Bros ESD	2000-2010	HBK2845	SET UP OEM ANTERIORE	1					1	€ 28,00	E
200	MTX200 RWD	1983-1986	HBK2294	SET UP OEM ANTERIORE	1					1	€ 28,00	E
200	XLR200	1995-2009	HBK2824	SET UP OEM ANTERIORE	1					1	€ 28,00	E
200	XR200	1995-2009	HBK2825	SET UP OEM ANTERIORE	1					1	€ 28,00	E
230	CRF230F	2003-2015	HBK2778	SET UP OEM ANTERIORE	1					1	€ 28,00	E
250	250 RSB		HBK2002	SET UP OEM ANTERIORE	1					1	€ 28,00	E
250	ATC250 R	1983	HBK2010	SET UP OEM ANTERIORE	1			1		2	€ 56,00	E
250	ATC250R	1986	HBK2867	SET UP OEM ANTERIORE	1			1		2	€ 56,00	E
250	CB250N A B DXB Superdream	1980-1983	HBK2043	SET UP OEM ANTERIORE	1					1	€ 28,00	E
250	CB250RS-A	1980-1983	HBK2049	SET UP OEM ANTERIORE	1					1	€ 28,00	E
250	CB250RS-DC Deleuxe	1982-1984	HBK2053	SET UP OEM ANTERIORE	1					1	€ 28,00	E
250	CBF250 Hornet	1996-2006	HBK2701	SET UP OEM ANTERIORE	1			1		2	€ 56,00	E
250	CBF250 Hornet	2004-2007	HBK2677	SET UP OEM ANTERIORE	1			1		2	€ 56,00	E
250	CBR250 RRJ - RRR MC19	1988-1989	HBK2809	SET UP OEM ANTERIORE	1			1		2	€ 56,00	E
250	CBR250 RRM - RRR MC22	1990-1999	HBK2746	SET UP RACE	1	1		1		3	€ 84,00	E
250	CBR250R	2011-2013	HBK2873	SET UP RACE	1			1		2	€ 56,00	E
250	CBR250R ABS	2011-2013	HBK2015	SET UP OEM ANTERIORE	3			2		5	€ 180,00	E
250	CBX250 RSE	1984-1986	HBK2812	SET UP OEM ANTERIORE	1					1	€ 28,00	E
250	CBX250 Twister	2000-2010	HBK2834	SET UP OEM ANTERIORE	1					1	€ 28,00	E
250	CBX250 Twister	2001-2008	HBK2839	SET UP OEM ANTERIORE	1					1	€ 28,00	E
250	CJ250 T	1977-1978	HBK2200	SET UP OEM ANTERIORE	1	1				2	€ 56,00	E
250	CM250 TB Custom	1982-1984	HBK2202	SET UP OEM ANTERIORE	1					1	€ 28,00	E
250	CMX250		HBK2900	SET UP OEM ANTERIORE	1					1	€ 28,00	E
250	CR250	1992-1994	HBK2706	SET UP OEM ANTERIORE	1			1		2	€ 56,00	E
250	CR250	1995-1998	HBK2206	SET UP OEM ANTERIORE	1			1		2	€ 56,00	E
250	CR250	1999-2003	HBK2013	SET UP OEM ANTERIORE	1			1		2	€ 56,00	E
250	CR250	2004-2007	HBK2715	SET UP OEM ANTERIORE	1			1		2	€ 56,00	E
250	CR250 RH - RJ	1987-1988	HBK2346	SET UP OEM ANTERIORE	1			1		2	€ 56,00	E
250	CR250 RK	1989	HBK2345	SET UP OEM ANTERIORE	1			1		2	€ 56,00	E
250	CR250R	1990-1991	HBK2853	SET UP OEM ANTERIORE	1			1		2	€ 56,00	E
250	CRF250L	2013-2016	HBK2877	SET UP OEM ANTERIORE	1			1		2	€ 56,00	E
250	CRF250R	2004-2007	HBK2818	SET UP OEM ANTERIORE	1			1		2	€ 56,00	E
250	CRF250R	2008-2009	HBK2789	SET UP OEM ANTERIORE	1			1		2	€ 56,00	E
250	CRF250R	2010-2017	HBK2860	SET UP OEM ANTERIORE	1			1		2	€ 56,00	E
250	CRF250X	2004-2005	HBK2816	SET UP OEM ANTERIORE	1			1		2	€ 56,00	E
250	CRF250X	2006-2013	HBK2758	SET UP OEM ANTERIORE	1			1		2	€ 56,00	E
250	CRM250	1996-1998	HBK2576	SET UP OEM ANTERIORE	1			1		2	€ 56,00	E
250	Forza 250	2000-2003	HBK2755	SET UP OEM ANTERIORE	1	1	1	1		4	€ 112,00	E
250	NSF250R - Moto 3	2011-2016	HBK2001	SET UP OEM ANTERIORE	1			1		2	€ 56,00	E
250	NSR250 (MC16)	1986-1987	HBK2869	SET UP RACE	1	1		1		3	€ 84,00	E
250	NSR250 (MC16)	1986-1987	HBK2868	SET UP OEM ANTERIORE	1	1	1	1		4	€ 112,00	E
250	NSR250 (MC18 R/SP) R2J - R4J	1988	HBK2815	SET UP OEM ANTERIORE	1	1		1		3	€ 84,00	E
250	NSR250 (MC18 R/SP) R5K - R6K	1989	HBK2714	SET UP OEM ANTERIORE	1	1		1		3	€ 84,00	E
250	NSR250 (MC21 R/SE/SP)	1990-1993	HBK2712	SET UP OEM ANTERIORE	1	1		1		3	€ 84,00	E
250	NSR250 (MC28 R/SE/SP)	1994-1998	HBK2713	SET UP OEM ANTERIORE	1	1		1		3	€ 84,00	E
250	NSR250R Twin Disc Import	1993-1996	HBK2319	SET UP OEM ANTERIORE	1	1		1		3	€ 84,00	E
250	Quad : TRX250EX	2003-2006	HBK2702	SET UP RACE	1	1		1		3	€ 84,00	E
250	RS250	1996	HBK2747	SET UP RACE	1	1		1		3	€ 84,00	E
250	VT250 FD	1983-1987	HBK2481	SET UP OEM ANTERIORE	1					1	€ 28,00	E
250	VTR250 Y (MC33)	2000-2003	HBK2786	SET UP OEM ANTERIORE	1			1		2	€ 56,00	E
250	XR250L	2004	HBK2848	SET UP OEM ANTERIORE	1			1		2	€ 56,00	E
250	XR250R	1997-2005	HBK2603	SET UP OEM ANTERIORE	1			1		2	€ 56,00	E

CILIND.	MODELLO	ANNI	CODICE	CONFIGURAZIONE	ANT. SUP	ANT. INF	AGG	POST	FRIZ.	TOT. TUBI	PREZZO PUBBLICO IVA ESCL.	FASCIA
250	CRM250	1991-1992	HBK2022	SET UP OEM ANTERIORE	1			1		2	€ 56,00	E
300	CB300R	2008-2010	HBK2835	SET UP OEM ANTERIORE	1					1	€ 28,00	E
300	Quad : TRX300EX	2002-2006	HBK2703	SET UP RACE	1	1		1		3	€ 84,00	E
300	XRE300	2008-2010	HBK2836	SET UP OEM ANTERIORE	1			1		2	€ 56,00	E
350	CB350S-G	1986-1988	HBK2056	SET UP OEM ANTERIORE	1	2				3	€ 84,00	E
350	NX350	1998-2006	HBK2843	SET UP OEM ANTERIORE	1					1	€ 28,00	E
350	XL350R	1989	HBK2538	SET UP OEM ANTERIORE	1					1	€ 28,00	E
360	CB360 Removing Hardline	1973	HBK2575	SET UP OEM ANTERIORE	1	1				2	€ 56,00	E
360	CB360 Retaining Hardline	1973	HBK2577	SET UP OEM ANTERIORE	1	1				2	€ 56,00	E
400	Bros 400	1988-1995	HBK2650	SET UP OEM ANTERIORE	1			1		2	€ 56,00	E
400	CB1 (400) NC27	1989-1993	HBK2804	SET UP OEM ANTERIORE	1			1		2	€ 56,00	E
400	CB1 (Super 400) NC31	1992-1996	HBK2748	SET UP RACE	1	1		1		3	€ 84,00	E
400	CB400 / 4 F2	1978	HBK2063	SET UP OEM ANTERIORE	1	1				2	€ 56,00	E
400	CB400 F	1975-1977	HBK2059	SET UP OEM ANTERIORE	1	2				3	€ 84,00	E
400	CB400 F Twin Disc	1989-1990	HBK2060	SET UP OEM ANTERIORE	1	1				2	€ 56,00	E
400	CB400 SF	1995	HBK2649	SET UP OEM ANTERIORE	1	1		1		3	€ 84,00	E
400	CB400 Super Four	1998-2000	HBK2751	SET UP SOPRA PARAFANGO ANTERIORE	1	1		1		3	€ 84,00	E
400	CB400 Super Four	1998-2000	HBK2752	SET UP RACE	1	1		1		3	€ 84,00	E
400	CB400 Super Four VTEC 1 And 2	2001-2004	HBK2753	SET UP SOPRA PARAFANGO ANTERIORE	1	1		1		3	€ 84,00	E
400	CB400 Super Four VTEC 1 And 2	2001-2004	HBK2754	SET UP RACE	1	1		1		3	€ 84,00	E
400	CB400 T	1977	HBK2062	SET UP OEM ANTERIORE	1					1	€ 28,00	E
400	CB400F Super Four Import	1998	HBK2064	SET UP OEM ANTERIORE	1	1		1		3	€ 84,00	E
400	CB400N Superdream	1978-1981	HBK2061	SET UP OEM ANTERIORE	1	2				3	€ 84,00	E
400	CBR400R	1985-1987	HBK2115	SET UP OEM ANTERIORE	1	2				3	€ 84,00	E
400	CBR400RR Gullarm NC29	1989-1996	HBK2119	SET UP RACE	1	1		1		3	€ 84,00	E
400	CBR400RR Gullarm NC29	1989-1996	HBK2118	SET UP OEM ANTERIORE	1	1	1	1		4	€ 112,00	E
400	CBR400RR Triarm NC23	1988-1989	HBK2134	SET UP RACE	1	1		1		3	€ 84,00	E
400	NS400 RF - RG	1985-1988	HBK2307	SET UP OEM ANTERIORE	1	2		1		4	€ 112,00	E
400	NX4 Falcon	2000-2010	HBK2844	SET UP OEM ANTERIORE	1			1		2	€ 56,00	E
400	Quad : TRX400EX	2003	HBK2691	SET UP RACE	1	1		1		3	€ 84,00	E
400	Quad : TRX400EX	2004-2006	HBK2704	SET UP RACE	1	1		1		3	€ 84,00	E
400	RVF400R (NC35)	1994-1996	HBK2350	SET UP RACE	1	1		1		3	€ 84,00	E
400	RVF400R (NC35)	1994-1996	HBK2349	SET UP OEM ANTERIORE	1	1	1	1		4	€ 112,00	E
400	VF400F D	1982-1984	HBC2428	LINEA FRIZIONE					1	1	€ 28,00	E
400	VF400F D	1982-1984	HBK2428	SET UP OEM ANTERIORE	1			1		2	€ 56,00	E
400	VFR400R (NC21) Import	1985-1987	HBC2451	LINEA FRIZIONE					1	1	€ 28,00	E
400	VFR400R (NC21) Import	1985-1987	HBK2451	SET UP OEM ANTERIORE	1	2		1		4	€ 112,00	E
400	VFR400R (NC24) Import	1987-1989	HBK2454	SET UP OEM ANTERIORE	1	1		1		3	€ 84,00	E
400	VFR400R (NC30) Import	1989-1995	HBK2457	SET UP OEM ANTERIORE	1	1		1		3	€ 84,00	E
400	XR400R	1997-2005	HBK2601	SET UP OEM ANTERIORE	1			1		2	€ 56,00	E
450	CB450 DX	1989-1992	HBK2065	SET UP OEM ANTERIORE	1	2		1		4	€ 112,00	E
450	CB450 K5 USA Import	1972	HBK2067	SET UP OEM ANTERIORE	1	1				2	€ 56,00	E
450	CBR450 SR	1988-1994	HBK2837	SET UP OEM ANTERIORE	1	2		1		4	€ 112,00	E
450	CMX450		HBK2862	SET UP OEM ANTERIORE	1					1	€ 28,00	E
450	CRF450	2002-2003	HBK2594	SET UP OEM ANTERIORE	1			1		2	€ 56,00	E
450	CRF450R	2004-2007	HBK2602	SET UP OEM ANTERIORE	1			1		2	€ 56,00	E
450	CRF450R	2008	HBK2782	SET UP OEM ANTERIORE	1			1		2	€ 56,00	E
450	CRF450R	2009-2016	HBK2790	SET UP OEM ANTERIORE	1			1		2	€ 56,00	E
450	CRF450R	2014-2015	HBK2012	SET UP OEM ANTERIORE	1			1		2	€ 56,00	E
450	CRF450X	2005-2007	HBK2788	SET UP OEM ANTERIORE	1			1		2	€ 56,00	E
450	CRF450X	2008-2015	HBK2861	SET UP OEM ANTERIORE	1			1		2	€ 56,00	E
450	Quad : TRX450	2003-2006	HBK2700	SET UP RACE	1	1		1		3	€ 84,00	E
450	Quad : TRX450	2004-2006	HBK2743	SET UP OEM ANTERIORE	1	1	1	1		4	€ 112,00	E

CILIND.	MODELLO	ANNI	CODICE	CONFIGURAZIONE	ANT. SUP	ANT. INF	AGG	POST	FRIZ.	TOT. TUBI	PREZZO PUBBLICO IVA ESCL.	FASCIA
450	Quad : TRX450 - ATV Only	2004-2006	HBK2744	SET UP OEM ANTERIORE	1	1	1	1		4	€ 112,00	E
450	Quad : TRX450 : Winrow Enduro	2004-2006	HBK2779	SET UP OEM ANTERIORE	1	1	1	1		4	€ 112,00	E
450	Quad : TRX450 : Winrow MX	2004-2006	HBK2780	SET UP OEM ANTERIORE	1	1	1	1		4	€ 112,00	E
500	CB500 K1	1972	HBK2827	SET UP OEM ANTERIORE	1	1				2	€ 56,00	E
500	CB500 R-T	1994-1996	HBK2863	SET UP OEM ANTERIORE	1					1	€ 28,00	E
500	CB500 SW - SX	1997-2002	HBK2068	SET UP OEM ANTERIORE	1			1		2	€ 56,00	E
500	CB500 V - W - X	1996-2001	HBK2066	SET UP OEM ANTERIORE	1			1		2	€ 56,00	E
500	CB500F ABS	2013-2015	HBK2398	SET UP OEM ANTERIORE	2			2		4	€ 144,00	E
500	CB500X ABS	2013-2015	HBK2400	SET UP OEM ANTERIORE	2			2		4	€ 144,00	E
500	CBF500	2004-2007	HBK2730	SET UP OEM ANTERIORE	1			1		2	€ 56,00	E
500	CBR500R ABS	2013-2015	HBK2401	SET UP OEM ANTERIORE	2			2		4	€ 144,00	E
500	CR500	1985-1988	HBK2847	SET UP OEM ANTERIORE	1			1		2	€ 56,00	E
500	CR500	1992-1994	HBK2207	SET UP OEM ANTERIORE	1			1		2	€ 56,00	E
500	CR500	1995-2003	HBK2208	SET UP OEM ANTERIORE	1			1		2	€ 56,00	E
500	CR500	2004-2005	HBK2717	SET UP OEM ANTERIORE	1			1		2	€ 56,00	E
500	CX500	1978	HBK2784	SET UP OEM ANTERIORE	1	2				3	€ 84,00	E
500	CX500 A - B	1979-1982	HBK2209	SET UP OEM ANTERIORE	1	2				3	€ 84,00	E
500	CX500 CB Custom	1981-1984	HBK2213	SET UP OEM ANTERIORE	1	2				3	€ 84,00	E
500	CX500 EC Eurosport	1982-1984	HBK2217	SET UP OEM ANTERIORE	1	2		1		4	€ 112,00	E
500	CX500 ET Turbo	1982-1984	HBK2220	SET UP OEM ANTERIORE	1	2		1		4	€ 112,00	E
500	FT500 C	1982-1984	HBK2230	SET UP OEM ANTERIORE	1			1		2	€ 56,00	E
500	GB500 TT Cafe Racer	1989-1990	HBK2865	SET UP OEM ANTERIORE	1					1	€ 28,00	E
500	GL500 Silverwing	1982-1984	HBK2272	SET UP OEM ANTERIORE	1	2				3	€ 84,00	E
500	VF500 F2E	1984-1987	HBK2432	SET UP OEM ANTERIORE	1	2		1		4	€ 112,00	E
500	VT500 ED - EF	1983-1988	HBK2486	SET UP OEM ANTERIORE	1					1	€ 28,00	E
500	XBR500 F - SJ	1985-1989	HBK2528	SET UP OEM ANTERIORE	1					1	€ 28,00	E
500	XR500 RD-RE	1983-1984	HBK2024	SET UP OEM ANTERIORE	1					1	€ 28,00	E
500	CBF500 ABS	2004-2007	HBK2731	SET UP OEM ANTERIORE	2			2		4	€ 144,00	E
500	VF500 F2E (Retains metal hard line)	1984-1987	HBC2432	LINEA FRIZIONE					1	1	€ 28,00	E
550	CB550 F1 - F2	1977	HBK2072	SET UP OEM ANTERIORE	1	1				2	€ 56,00	E
550	CB550 F1 - F2	1977	HBK2073	SET UP OEM ANTERIORE	1	1				2	€ 56,00	E
550	CB550 K3	1977	HBK2077	SET UP OEM ANTERIORE	1	1				2	€ 56,00	E
550	CBX550 F2C - FD	1982-1986	HBK2184	SET UP OEM ANTERIORE	1	2		1		4	€ 112,00	E
600	Bros 600	1988-1995	HBK2658	SET UP OEM ANTERIORE	1			1		2	€ 56,00	E
600	CB600F Hornet	1998-2002	HBK2081	SET UP RACE	1	1		1		3	€ 84,00	E
600	CB600F Hornet	2003-2006	HBK2694	SET UP RACE	1	1		1		3	€ 84,00	E
600	CB600F Hornet	2007-2013	HBK2310	SET UP SOPRA PARAFANGO ANTERIORE	1	1		1		3	€ 84,00	E
600	CB600F Hornet	2007-2013	HBK2874	SET UP RACE	1	1		1		3	€ 84,00	E
600	CB600F Hornet	2007-2013	HBK2308	SET UP OEM ANTERIORE	1	1	1	1		4	€ 112,00	E
600	CB600F Hornet ABS	2007-2013	HBK2773	SET UP OEM ANTERIORE	6			2		8	€ 288,00	E
600	CBF600	2004-2007	HBK2675	SET UP RACE	1	1		1		3	€ 84,00	E
600	CBF600	2004-2007	HBK2676	SET UP SOPRA PARAFANGO ANTERIORE	1	1		1		3	€ 84,00	E
600	CBF600	2004-2007	HBK2674	SET UP OEM ANTERIORE	1	1	1	1		4	€ 112,00	E
600	CBF600 (Faired & Unfaired)	2008-2010	HBK2795	SET UP RACE	1	1		1		3	€ 84,00	E
600	CBF600 ABS	2008-2013	HBK2832	SET UP OEM ANTERIORE	5			2		7	€ 252,00	E
600	CBR600 F1 - F7 Sport	2001-2007	HBK2158	SET UP RACE	1	1		1		3	€ 84,00	E
600	CBR600 F1 - F7 Sport	2001-2007	HBK2159	SET UP SOPRA PARAFANGO ANTERIORE	1	1		1		3	€ 84,00	E
600	CBR600 F1 - F7 Sport	2001-2007	HBK2160	SET UP OEM ANTERIORE	1	1	1	1		4	€ 112,00	E
600	CBR600 FH - FJ - FK	1987-1989	HBK2136	SET UP OEM ANTERIORE	1	2		1		4	€ 112,00	E
600	CBR600 FL	1990	HBK2139	SET UP OEM ANTERIORE	1	2		1		4	€ 112,00	E
600	CBR600 FM - FN - FP - FR	1991-1994	HBK2141	SET UP RACE	1	1		1		3	€ 84,00	E

CILIND.	MODELLO	ANNI	CODICE	CONFIGURAZIONE	ANT. SUP	ANT. INF	AGG	POST	FRIZ.	TOT. TUBI	PREZZO PUBBLICO IVA ESCL.	FASCIA
600	CBR600 FM - FN - FP - FR	1991-1994	HBK2140	SET UP OEM ANTERIORE	1	1	1	1		4	€ 112,00	E
600	CBR600 FS - FT - FW	1995-1998	HBK2622	SET UP RACE	1	1		1		3	€ 84,00	E
600	CBR600 FS - FT - FW	1995-1998	HBK2624	SET UP SOPRA PARAFANGO ANTERIORE	1	1		1		3	€ 84,00	E
600	CBR600 FS - FT - FW - SPEC ON HOLD - DON'T USE	1995-1998	HBK2623	SET UP OEM ANTERIORE	1	1	1	1		4	€ 112,00	E
600	CBR600 FX - F3 And Sport	1998-2004	HBK2153	SET UP RACE	1	1		1		3	€ 84,00	E
600	CBR600 FX - F3 And Sport	1998-2004	HBK2154	SET UP SOPRA PARAFANGO ANTERIORE	1	1		1		3	€ 84,00	E
600	CBR600 FX - F3 And Sport	1998-2004	HBK2155	SET UP OEM ANTERIORE	1	1	1	1		4	€ 112,00	E
600	CBR600F ABS	2011-2013	HBK2312	SET UP OEM ANTERIORE	6			2		8	€ 288,00	E
600	CBR600RR	2003-2004	HBK2588	SET UP RACE	1	1		1		3	€ 84,00	E
600	CBR600RR	2003-2004	HBK2589	SET UP SOPRA PARAFANGO ANTERIORE	1	1		1		3	€ 84,00	E
600	CBR600RR	2005-2006	HBK2718	SET UP RACE	1	1		1		3	€ 84,00	E
600	CBR600RR	2005-2006	HBK2719	SET UP SOPRA PARAFANGO ANTERIORE	1	1		1		3	€ 84,00	E
600	CBR600RR	2007-2017	HBK2761	SET UP SOPRA PARAFANGO ANTERIORE	1	1		1		3	€ 84,00	E
600	CBR600RR	2007-2017	HBK2762	SET UP RACE	1	1		1		3	€ 84,00	E
600	CBR600RR ABS	2009-2017	HBK2831	SET UP OEM ANTERIORE	4			1		5	€ 180,00	E
600	FJS600 Silverwing ABS	2006-2010	HBK2769	SET UP OEM ANTERIORE	3			2		5	€ 180,00	E
600	NTV600-J Revere	1988-1991	HBK2323	SET UP OEM ANTERIORE	1			1		2	€ 56,00	E
600	VT600CN - CW Shadow	1992-2001	HBK2492	SET UP OEM ANTERIORE	1					1	€ 28,00	E
600	XL600 LMF Paris Dakar	1985-1986	HBK2537	SET UP OEM ANTERIORE	1					1	€ 28,00	E
600	XL600 RD -RF	1984-1986	HBK2549	SET UP OEM ANTERIORE	1					1	€ 28,00	E
600	XL600 VH - VK Transalp	1987-1989	HBK2386	SET UP OEM ANTERIORE	1					1	€ 28,00	E
600	XL600 VL - VT Transalp	1992-1996	HBK2390	SET UP OEM ANTERIORE	1			1		2	€ 56,00	E
600	XL600 VV - VX Transalp (Twin Disc)	1997-2003	HBK2870	SET UP RACE	1	1		1		3	€ 84,00	E
600	XL600 XL650 VU - V7 Transalp	2001-2007	HBK2540	SET UP RACE	1	1		1		3	€ 84,00	E
600	XL600 XL650 VU - V7 Transalp	2001-2007	HBK2539	SET UP OEM ANTERIORE	1	1	1	1		4	€ 112,00	E
600	XR600R	1991-1995	HBK2822	SET UP OEM ANTERIORE	1			1		2	€ 56,00	E
650	Bros 650	1988-1995	HBK2011	SET UP OEM ANTERIORE	1			1		2	€ 56,00	E
650	CB650 SC Nighthawk	1982-1985	HBK2086	SET UP OEM ANTERIORE	1	2				3	€ 84,00	E
650	CB650 Z	1981-1982	HBK2087	SET UP OEM ANTERIORE	1	2				3	€ 84,00	E
650	CB650F ABS	2014-2016	HBK2019	SET UP OEM ANTERIORE	4			2		6	€ 216,00	E
650	CB650F Non ABS	2015	HBK2090	SET UP RACE	1	1		1		3	€ 84,00	E
650	CBR650F ABS	2014-2016	HBK2014	SET UP OEM ANTERIORE	4			2		6	€ 216,00	E
650	CBR650R ABS (AK)	2019-2020	HBK2033	SET UP OEM ANTERIORE	4			3		7	€ 196,00	E
650	CX650 Custom	1983	HBK2851	SET UP OEM ANTERIORE	1					1	€ 28,00	E
650	CX650 E	1983-1986	HBK2750	SET UP OEM ANTERIORE	1	2		1		4	€ 112,00	E
650	CX650 ED Eurosport	1983-1986	HBK2223	SET UP OEM ANTERIORE	1	2		1		4	€ 112,00	E
650	CX650 TD Turbo	1983-1985	HBK2227	SET UP OEM ANTERIORE	1	2				3	€ 84,00	E
650	FMX650	2004-2008	HBK2735	SET UP OEM ANTERIORE	1			1		2	€ 56,00	E
650	GLE650 D2E Silverwing	1984-1986	HBK2275	SET UP OEM ANTERIORE	1	2				3	€ 84,00	E
650	NTV650 Deauville VW - V1	1998-2001	HBK2749	SET UP RACE	1	1		1		3	€ 84,00	E
650	NTV650 P - V	1992-1996	HBK2326	SET UP OEM ANTERIORE	1			1		2	€ 56,00	E
650	NX650 J - X Dominator	1988-2001	HBK2330	SET UP OEM ANTERIORE	1			1		2	€ 56,00	E
650	NX650 J - X Dominator (Italian)	1997-2001	HBK2864	SET UP OEM ANTERIORE	1			1		2	€ 56,00	E
650	SLR650 V - W	1997-1999	HBK2363	SET UP OEM ANTERIORE	1			1		2	€ 56,00	E
650	XL650 RY Transalp	2000-2002	HBK2552	SET UP RACE	1	1		1		3	€ 84,00	E
650	XR650 Enduro	1997-2006	HBK2559	SET UP OEM ANTERIORE	1			1		2	€ 56,00	E
650	XR650R UK	1997-2006	HBK2855	SET UP OEM ANTERIORE	1			1		2	€ 56,00	E
650	XR650R UK Supermoto'd By Customer	1997-2006	HBK2856	SET UP OEM ANTERIORE	1			1		2	€ 56,00	E

CILIND.	MODELLO	ANNI	CODICE	CONFIGURAZIONE	ANT. SUP	ANT. INF	AGG	POST	FRIZ.	TOT. TUBI	PREZZO PUBBLICO IVA ESCL.	FASCIA
650	XR650R USA	2001-2007	HBK2857	SET UP OEM ANTERIORE	1			1		2	€ 56,00	E
650	XR650R USA Supermoto'd By Customer	2001-2007	HBK2858	SET UP OEM ANTERIORE	1			1		2	€ 56,00	E
650	XRV650 Africa Twin	1988-1989	HBK2871	SET UP OEM ANTERIORE	1			1		2	€ 56,00	E
650	XL650V Transalp	2000-2007	HBFKK0002	SET UP OEM ANTERIORE	4			1		5	€ 140,00	E
650	NTV650 Deauville V2 - V5	2002-2005	HBK2017	SET UP OEM ANTERIORE						8	€ 224,00	E
650	CBR650F ABS (AH-AJ)	2017-2018	HBK2027	SET UP OEM ANTERIORE	4			2		6	€ 168,00	E
650	CB650F AH-AJ ABS (RC97)	2017-2018	HBK2029	SET UP OEM ANTERIORE	4			2		6	€ 168,00	E
700	NC700 DCT-ABS	2012-2014	HBK2890	SET UP OEM ANTERIORE	1	2	1	1		5	€ 180,00	E
700	NTV700 Deauville ABS VA6 -VA13	2006-2013	HBK2738	SET UP OEM ANTERIORE	7			2		9	€ 324,00	E
700	VF700C Magna (Import)	1987-1988	HBC2436	LINEA FRIZIONE					1	1	€ 28,00	E
700	VF700C Magna (Import)	1987-1988	HBK2436	SET UP OEM ANTERIORE	1	1	1			3	€ 84,00	E
700	Transalp 700 ABS XL700V8 - XL700VAB	2008-2011	HBK2541	SET UP OEM ANTERIORE	6			2		8	€ 224,00	E
750	750 F2	1979	HBK2004	SET UP OEM ANTERIORE	1	2		1		4	€ 112,00	E
750	750 K2	1975	HBK2005	SET UP OEM ANTERIORE	1	1				2	€ 56,00	E
750	750 K2	1979	HBK2006	SET UP OEM ANTERIORE	1	1				2	€ 56,00	E
750	750 K6	1983	HBK2007	SET UP OEM ANTERIORE			2			2	€ 56,00	E
750	750/4 F1		HBK2009	SET UP OEM ANTERIORE	1	1		1		3	€ 84,00	E
750	CB750 Custom	1980-1985	HBK2103	SET UP OEM ANTERIORE	1	2				3	€ 84,00	E
750	CB750 F	1981	HBK2088	SET UP OEM ANTERIORE	1	2		1		4	€ 112,00	E
750	CB750 F1 Twin Disc	1977	HBK2089	SET UP OEM ANTERIORE	1	2		1		4	€ 112,00	E
750	CB750 F2 Twin Disc	1977	HBK2854	SET UP OEM ANTERIORE	1	2		1		4	€ 112,00	E
750	CB750 F2N - F2V	1992-1997	HBK2092	SET UP OEM ANTERIORE	1	2		1		4	€ 112,00	E
750	CB750 FB	1979-1983	HBK2094	SET UP OEM ANTERIORE	1	2		1		4	€ 112,00	E
750	CB750 K2 Single Disc	1972	HBK2095	SET UP OEM ANTERIORE	1	1				2	€ 56,00	E
750	CB750 K3 - K4 Single Disc	1973-1974	HBK2104	SET UP OEM ANTERIORE	1	1				2	€ 56,00	E
750	CB750 K6	1976	HBK2720	SET UP OEM ANTERIORE	1	1				2	€ 56,00	E
750	CB750 K7	1978-1979	HBK2096	SET UP OEM ANTERIORE	1	1				2	€ 56,00	E
750	CB750 KZ	1978-1980	HBK2097	SET UP OEM ANTERIORE	1	2		1		4	€ 112,00	E
750	CBR750 Japanese Import	1987-1988	HBK2666	SET UP RACE	1	1		1		3	€ 84,00	E
750	CBX750 F1	1984-1986	HBK2196	SET UP OEM ANTERIORE	1	2		1		4	€ 112,00	E
750	CBX750 FE	1984-1986	HBK2197	SET UP OEM ANTERIORE	1	2		1		4	€ 112,00	E
750	NC750 S	2014-2015	HBK2891	SET UP OEM ANTERIORE	1			1		2	€ 56,00	E
750	RVF750R R - S (RC45)	1994-1998	HBK2358	SET UP OEM ANTERIORE	1	1	1	1		4	€ 112,00	E
750	RVF750R RC45	1994-1998	HBC2358	LINEA FRIZIONE					1	1	€ 28,00	E
750	VF750	1983	HBC2444	LINEA FRIZIONE					1	1	€ 28,00	E
750	VF750 CH - CV	1987-1996	HBK2438	SET UP OEM ANTERIORE	1					1	€ 28,00	E
750	VF750 FD - FE	1983-1984	HBK2444	SET UP OEM ANTERIORE	1	2		1		4	€ 112,00	E
750	VF750 Sabre	1982-1984	HBK2447	SET UP OEM ANTERIORE	1	2				3	€ 84,00	E
750	VF750 S-C	1982-1984	HBK2448	SET UP OEM ANTERIORE	1	2				3	€ 84,00	E
750	VF750S	1982-1984	HBC2448	LINEA FRIZIONE					1	1	€ 28,00	E
750	VFR750 FG - FH	1986-1987	HBK2697	SET UP RACE	1	1		1		3	€ 84,00	E
750	VFR750 FG - FH	1986-1987	HBK2464	SET UP OEM ANTERIORE	1	2		1		4	€ 112,00	E
750	VFR750 FJ - FK	1986-1987	HBC2464	LINEA FRIZIONE					1	1	€ 28,00	E
750	VFR750 FJ - FK	1988	HBK2698	SET UP RACE	1	1		1		3	€ 84,00	E
750	VFR750 FJ - FK	1988	HBK2466	SET UP OEM ANTERIORE	1	1	1	1		4	€ 112,00	E
750	VFR750 FL - FP	1990-1993	HBC2696	LINEA FRIZIONE					1	1	€ 28,00	E
750	VFR750 FL - FP (RC24)	1989-1993	HBK2699	SET UP RACE	1	1		1		3	€ 84,00	E
750	VFR750 FL - FP (RC24)	1989-1993	HBK2696	SET UP OEM ANTERIORE	1	1	1	1		4	€ 112,00	E
750	VFR750 FR - FV	1994-1997	HBC2635	LINEA FRIZIONE					1	1	€ 28,00	E
750	VFR750 FR - FV	1994-1997	HBK2635	SET UP RACE	1	1		1		3	€ 84,00	E
750	VFR750 RJ - RK (RC30)	1988-1990	HBC2475	LINEA FRIZIONE					1	1	€ 28,00	E
750	VFR750 RJ - RK (RC30)	1988-1990	HBK2475	SET UP OEM ANTERIORE	1	1		1		3	€ 84,00	E
750	VT750 V-W Shadow	1997-1998	HBK2859	SET UP OEM ANTERIORE	1					1	€ 28,00	E

CILIND.	MODELLO	ANNI	CODICE	CONFIGURAZIONE	ANT. SUP	ANT. INF	AGG	POST	FRIZ.	TOT. TUBI	PREZZO PUBBLICO IVA ESCL.	FASCIA
750	VT750C Shadow Spirit	2004-2008	HBK2688	SET UP OEM ANTERIORE	1					1	€ 28,00	E
750	XRV750 L - Y Africa Twin	1990-2003	HBK2823	SET UP RACE	1	1		1		3	€ 84,00	E
750	XRV750 L - Y Africa Twin	1990-2003	HBK2828	SET UP OEM ANTERIORE	1	1	1	1		4	€ 112,00	E
750	X-ADV ABS	2017-2018	HBK0010	SET UP OEM ANTERIORE	4			2		6	€ 216,00	E
800	PC800 Pacific Ocean	1989-1998	HBC2667	LINEA FRIZIONE					1	1	€ 28,00	E
800	PC800 Pacific Ocean	1989-1998	HBK2667	SET UP OEM ANTERIORE	1	2				3	€ 84,00	E
800	VFR800 FIW - FI1	1998-2001	HBC2741	LINEA FRIZIONE					1	1	€ 28,00	E
800	VFR800 FIW - FI1	1998-2001	HBK2708	SET UP OEM ANTERIORE	8			2		10	€ 280,00	E
800	VFR800 V-TEC Linked Brakes - Non ABS	2002-2009	HBK2741	SET UP OEM ANTERIORE	7			2		9	€ 252,00	E
800	VFR800 V-TEC Linked Brakes & ABS	2002-2005	HBK2739	SET UP OEM ANTERIORE	1		6	5		12	€ 432,00	E
800	VFR800 V-TEC Linked Brakes & ABS	2006-2013	HBK2742	SET UP OEM ANTERIORE	1		6	5		12	€ 432,00	E
800	VFR800 V-TEC Non ABS & ABS	2002-2013	HBC2742	LINEA FRIZIONE					1	1	€ 28,00	E
800	VT800 Shadow Import	1988	HBK2503	SET UP OEM ANTERIORE	1			1		2	€ 56,00	E
800	VFR800X Crossrunner ABS (XF-XH)	2015-2019	HBC2034	LINEA FRIZIONE					1	1	€ 28,00	E
800	VFR800X Crossrunner ABS (XF-XH)	2015-2019	HBK2034	SET UP OEM ANTERIORE	4		1	2		7	€ 196,00	E
900	CB900 F2		HBK2099	SET UP OEM ANTERIORE	1	2		1		4	€ 112,00	E
900	CB900 FA - FB	1980-1981	HBK2098	SET UP OEM ANTERIORE	1	2		1		4	€ 112,00	E
900	CB900 FC - FD	1982-1983	HBK2806	SET UP OEM ANTERIORE	1	2		1		4	€ 112,00	E
900	CB900 FZ	1979-1983	HBK2100	SET UP OEM ANTERIORE	1	2		1		4	€ 112,00	E
900	CB900F Hornet	1999-2007	HBK2591	SET UP RACE	1	1		1		3	€ 84,00	E
900	CBR900 RRN - RRS Fireblade	1992-1995	HBK2162	SET UP RACE	1	1		1		3	€ 84,00	E
900	CBR900 RRN - RRS Fireblade	1992-1995	HBK2161	SET UP OEM ANTERIORE	1	1	1	1		4	€ 112,00	E
900	CBR900 RRT - RRX Fireblade	1996-1999	HBK2172	SET UP RACE	1	1		1		3	€ 84,00	E
900	CBR900 RRT - RRX Fireblade	1996-1999	HBK2173	SET UP OEM ANTERIORE	1	1	1	1		4	€ 112,00	E
929	CBR929 RRY - RR1 Fireblade	2000-2001	HBK2179	SET UP RACE	1	1		1		3	€ 84,00	E
954	CBR954 RR2 - RR3 Fireblade	2002-2003	HBK2580	SET UP RACE	1	1		1		3	€ 84,00	E
1000	CB1000 FP-FT Big One	1993-1996	HBC2026	LINEA FRIZIONE					1	1	€ 28,00	E
1000	CB1000 FP-FT Big One	1993-1996	HBK2020	SET UP OEM ANTERIORE	1	2		1		4	€ 112,00	E
1000	CB1000 USA Import	1983	HBK2025	SET UP OEM ANTERIORE	1	2				3	€ 84,00	E
1000	CB1000R	2008-2016	HBK2801	SET UP SOPRA PARAFANGO ANTERIORE	1	1		2		4	€ 112,00	E
1000	CB1000R	2008-2016	HBK2819	SET UP RACE	1	1		2		4	€ 112,00	E
1000	CB1000R	2008-2016	HBK2800	SET UP OEM ANTERIORE	1	1	1	2		5	€ 140,00	E
1000	CB1000R (Non ABS & ABS)	2008-2017	HBC2817	LINEA FRIZIONE					1	1	€ 28,00	E
1000	CB1000R ABS	2009-2017	HBK2821	SET UP OEM ANTERIORE	6			3		9	€ 324,00	E
1000	CBF1000	2006-2010	HBC2725	LINEA FRIZIONE			1		1	2	€ 56,00	E
1000	CBF1000	2006-2010	HBK2726	SET UP RACE	1	1		1		3	€ 84,00	E
1000	CBF1000	2006-2010	HBK2725	SET UP OEM ANTERIORE	1	1	1	1		4	€ 112,00	E
1000	CBF1000 ABS A6 - AA	2006-2010	HBK2879	SET UP OEM ANTERIORE	5			2		7	€ 252,00	E
1000	CBF1000 ABS FAB -FAC	2011-2016	HBC2880	LINEA FRIZIONE					1	1	€ 36,00	E
1000	CBF1000 ABS FAB -FAC	2011-2016	HBK2880	SET UP OEM ANTERIORE	6			2		8	€ 288,00	E
1000	CBR1000 FH - FJ	1987-1988	HBK2102	SET UP RACE	1	1		1		3	€ 84,00	E
1000	CBR1000 FH - FJ	1987-1988	HBK2101	SET UP OEM ANTERIORE	1	1	1	1		4	€ 112,00	E
1000	CBR1000 FH - FN	1987-1992	HBC2121	LINEA FRIZIONE					1	1	€ 28,00	E
1000	CBR1000 FK - FN	1989-1992	HBK2808	SET UP RACE	1	1		1		3	€ 84,00	E
1000	CBR1000 FK - FN	1989-1992	HBK2807	SET UP OEM ANTERIORE	1	1	1	1		4	€ 112,00	E
1000	CBR1000F	1987-1992	HBC2807	LINEA FRIZIONE					1	1	€ 28,00	E
1000	CBR1000RR Fireblade	2004-2005	HBK2673	SET UP SOPRA PARAFANGO ANTERIORE	1	1		1		3	€ 84,00	E

CILIND.	MODELLO	ANNI	CODICE	CONFIGURAZIONE	ANT. SUP	ANT. INF	AGG	POST	FRIZ.	TOT. TUBI	PREZZO PUBBLICO IVA ESCL.	FASCIA
1000	CBR1000RR Fireblade	2004-2005	HBK2689	SET UP RACE	1	1		1		3	€ 84,00	E
1000	CBR1000RR Fireblade	2004-2007	HBC2689	LINEA FRIZIONE					1	1	€ 28,00	E
1000	CBR1000RR Fireblade	2006-2007	HBK2733	SET UP SOPRA PARAFANGO ANTERIORE	1	1		1		3	€ 84,00	E
1000	CBR1000RR Fireblade	2006-2007	HBK2734	SET UP RACE	1	1		1		3	€ 84,00	E
1000	CBR1000RR Fireblade	2008-2016	HBK2802	SET UP RACE	1	1		1		3	€ 84,00	E
1000	CBR1000RR Fireblade	2008-2016	HBK2803	SET UP SOPRA PARAFANGO ANTERIORE	1	1		1		3	€ 84,00	E
1000	CBR1000RR Fireblade ABS	2009-2016	HBK2829	SET UP OEM ANTERIORE	4			2		6	€ 216,00	E
1000	CBR1000RR Fireblade	2017-2018	HBFKK0012	SET UP RACE - SBK	4			1		5	€ 140,00	E
1000	CBX1000 A	1980	HBK2810	SET UP OEM ANTERIORE	1	2		1		4	€ 112,00	E
1000	CBX1000 Pro-Link	1981-1984	HBK2180	SET UP OEM ANTERIORE	1	2		1		4	€ 112,00	E
1000	CBX1000 Z	1978-1979	HBK2811	SET UP OEM ANTERIORE	1	2		1		4	€ 112,00	E
1000	CRF1000L Africa Twin ABS	2016-2018	HBK2018	SET UP OEM ANTERIORE	5			2		7	€ 252,00	E
1000	GL1000 Goldwing	1976	HBK2235	SET UP OEM ANTERIORE	1	2		1		4	€ 112,00	E
1000	GL1000 Goldwing	1976	HBK2236	SET UP OEM ANTERIORE	1	2		1		4	€ 112,00	E
1000	GL1000 KZ - K1 Goldwing	1979-1980	HBK2234	SET UP OEM ANTERIORE	1	2		1		4	€ 112,00	E
1000	VF1000 FE-FF	1984-1985	HBK2414	SET UP OEM ANTERIORE	1	2		1		4	€ 112,00	E
1000	VF1000 FII Bol Dor	1985-1986	HBK2415	SET UP OEM ANTERIORE	1	2		1		4	€ 112,00	E
1000	VF1000 RE - RG	1984-1986	HBK2417	SET UP RACE	1	1		1		3	€ 84,00	E
1000	VF1000 RE - RG	1984-1986	HBK2416	SET UP OEM ANTERIORE	1	2		1		4	€ 112,00	E
1000	VF1000 RE - RG	1984-1988	HBC2416	LINEA FRIZIONE					1	1	€ 28,00	E
1000	VTR1000 Firestorm FV - F6	1997-2006	HBC2504	LINEA FRIZIONE					1	1	€ 28,00	E
1000	VTR1000 Firestorm FV - F6	1997-2006	HBK2505	SET UP RACE	1	1		1		3	€ 84,00	E
1000	VTR1000 Firestorm FV - F6	1997-2006	HBK2506	SET UP SOPRA PARAFANGO ANTERIORE	1	1		1		3	€ 84,00	E
1000	VTR1000 Firestorm FV - F6	1997-2006	HBK2504	SET UP OEM ANTERIORE	1	1	1	1		4	€ 112,00	E
1000	VTR1000 SP1 - SP2	2000-2003	HBC2522	LINEA FRIZIONE					1	1	€ 28,00	E
1000	VTR1000 SP1 RC51	1999-2001	HBK2522	SET UP RACE	1	1		1		3	€ 84,00	E
1000	VTR1000 SP1 RC51	1999-2001	HBK2523	SET UP SOPRA PARAFANGO ANTERIORE	1	1		1		3	€ 84,00	E
1000	VTR1000 SP2 RC51	2002-2007	HBK2526	SET UP RACE	1	1		1		3	€ 84,00	E
1000	VTR1000 SP2 RC51	2002-2007	HBK2578	SET UP SOPRA PARAFANGO ANTERIORE	1	1		1		3	€ 84,00	E
1000	XL1000V Varadero	1998-2003	HBK2679	SET UP OEM ANTERIORE	1					1	€ 28,00	E
1000	XL1000V Varadero	2004-2008	HBK2678	SET UP OEM ANTERIORE	1					1	€ 28,00	E
1000	XL1000V Varadero ABS	2004-2006	HBK2680	SET UP OEM ANTERIORE	1					1	€ 36,00	E
1000	XL1000V Varadero ABS	2004-2006	HBK2681	SET UP OEM ANTERIORE	1					1	€ 36,00	E
1000	XL1000V Varadero ABS	2007-2008	HBK2774	SET UP OEM ANTERIORE	1					1	€ 36,00	E
1000	CBR1000RR Fireblade ABS	2017-2018	HBK2023	SET UP OEM ANTERIORE	4			2		6	€ 216,00	E
1000	CB1000R ABS AJ-AK	2018-2019	HBK2032	SET UP OEM ANTERIORE	3			3		6	€ 216,00	E
1100	CB1100 RC - RD	1982-1984	HBK2028	SET UP OEM ANTERIORE	1	2		1		4	€ 112,00	E
1100	CB1100 X11	1999-2002	HBK2805	SET UP OEM ANTERIORE	2	6		2		10	€ 280,00	E
1100	CBR1100 XXV - XX6	1996-2007	HBK2709	SET UP OEM ANTERIORE	8			2		10	€ 280,00	E
1100	CBR1100 XXV-XX6	1996-2007	HBC2709	LINEA FRIZIONE					1	1	€ 28,00	E
1100	GL1100 A - B Goldwing	1980-1981	HBK2239	SET UP OEM ANTERIORE	1	2		1		4	€ 112,00	E
1100	GL1100 A Goldwing (Import)	1982	HBK2813	SET UP OEM ANTERIORE	1	2		1		4	€ 112,00	E
1100	GL1100 AD Aspencade	1983	HBK2238	SET UP OEM ANTERIORE	1	2				3	€ 84,00	E
1100	GL1100 Goldwing DC Deluxe	1982	HBK2241	SET UP OEM ANTERIORE	1	2				3	€ 84,00	E
1100	ST1100 AT - AY ABS/TCS	1996-2002	HBK2584	SET UP OEM ANTERIORE	17					17	€ 612,00	E
1100	ST1100 Non ABS	1990-2002	HBK2711	SET UP RACE	1	1	1	1		4	€ 112,00	E
1100	ST1100 Pan European	1990-2002	HBC2378	LINEA FRIZIONE					1	1	€ 28,00	E
1100	ST1100 Pan European Non ABS	1990-2002	HBK2374	SET UP OEM ANTERIORE	1	1	1	1		4	€ 112,00	E

CILIND.	MODELLO	ANNI	CODICE	CONFIGURAZIONE	ANT. SUP	ANT. INF	AGG	POST	FRIZ.	TOT. TUBI	PREZZO PUBBLICO IVA ESCL.	FASCIA
1100	ST1100 Pan European Non ABS + ABS	1990-2002	HBC2379	LINEA FRIZIONE					1	1	€ 28,00	E
1100	VF1100 Magna V65	1984-1988	HBC2573	LINEA FRIZIONE					1	1	€ 28,00	E
1100	VF1100 Magna V65 Import	1983-1986	HBK2573	SET UP OEM ANTERIORE	1	2		1		4	€ 112,00	E
1100	VT1100 Shadow Import	1987-1994	HBC2814	LINEA FRIZIONE					1	1	€ 28,00	E
1100	VT1100 Shadow Import	1987-1994	HBK2814	SET UP OEM ANTERIORE	1					1	€ 28,00	E
1200	GL1200 AD Aspencade	1983	HBK2243	SET UP OEM ANTERIORE	1	1	1	1		4	€ 112,00	E
1200	GL1200 AD Aspencade Linked	1984-1987	HBK2244	SET UP OEM ANTERIORE	1	1		1		3	€ 84,00	E
1200	GL1200 AE - AH Aspencade	1984-1987	HBC2246	LINEA FRIZIONE					1	1	€ 28,00	E
1200	GL1200 AE Aspencade	1984	HBK2245	SET UP OEM ANTERIORE	1	1	1	1		4	€ 112,00	E
1200	GL1200 AF - AG - AH Aspencade	1985-1988	HBK2246	SET UP OEM ANTERIORE	1	1	1	1		4	€ 112,00	E
1200	GL1200 DE Goldwing Deluxe	1984	HBK2250	SET UP OEM ANTERIORE	1	1		1		3	€ 84,00	E
1200	GL1200 Interstate	1984	HBK2849	SET UP OEM ANTERIORE	1	1	1	1		4	€ 112,00	E
1300	CB1300	1995-2002	HBC2690	LINEA FRIZIONE					1	1	€ 28,00	E
1300	CB1300	1997-2002	HBK2690	SET UP OEM ANTERIORE	1	1	1	1		4	€ 112,00	E
1300	CB1300 SA	2005-2009	HBC2723	LINEA FRIZIONE					1	1	€ 28,00	E
1300	CB1300F	2003-2007	HBC2721	LINEA FRIZIONE					1	1	€ 28,00	E
1300	CB1300F	2003-2008	HBK2722	SET UP RACE	1	1		1		3	€ 84,00	E
1300	CB1300F	2003-2008	HBK2721	SET UP OEM ANTERIORE	1	2		1		4	€ 112,00	E
1300	CB1300S	2003-2008	HBK2724	SET UP RACE	1	1		1		3	€ 84,00	E
1300	CB1300S	2003-2008	HBK2723	SET UP OEM ANTERIORE	1	2		1		4	€ 112,00	E
1300	ST1300 Pan European ABS	2007-2013	HBK2740	SET UP OEM ANTERIORE	15					15	€ 540,00	E
1300	ST1300 Pan European Non ABS	2002-2006	HBK2030	SET UP OEM ANTERIORE	1	8		5		14	€ 392,00	E
1300	VTX1300	2004-2008	HBK2830	SET UP OEM ANTERIORE	1			1		2	€ 56,00	E
1300	VTX1300	2004-2008	HBK2684	SET UP OEM ANTERIORE	1		1	1		3	€ 84,00	E
1300	X4 1300	1997-2003	HBC2668	LINEA FRIZIONE					1	1	€ 28,00	E
1300	X4 1300	1997-2003	HBK2670	SET UP RACE	1	1		1		3	€ 84,00	E
1300	X4 1300	1997-2003	HBK2668	SET UP OEM ANTERIORE	1	1	1	1		4	€ 112,00	E
1300	CB1300 ABS SA5-SA9	2005-2009	HBK2833	SET UP OEM ANTERIORE	4			3		7	€ 252,00	E
1500	GL1500 J - K - L Goldwing	1988-1991	HBK2252	SET UP OEM ANTERIORE	1	1	1	1		4	€ 112,00	E
1500	GL1500 J SEY Goldwing	1988-2000	HBK2631	SET UP OEM ANTERIORE	1	1	1	1		4	€ 112,00	E
1500	Valkyrie F6C GL1500 CV - CW	1996-2003	HBC2395	LINEA FRIZIONE					1	1	€ 28,00	E
1500	Valkyrie F6C GL1500 CV - CW	1996-2003	HBK2396	SET UP RACE	1	1		1		3	€ 84,00	E
1500	Valkyrie F6C GL1500 CV - CW	1996-2003	HBK2397	SET UP SOPRA PARAFANGO ANTERIORE	1	1		1		3	€ 84,00	E
1500	Valkyrie F6C GL1500 CV - CW	1996-2003	HBK2395	SET UP OEM ANTERIORE	1	1	1	1		4	€ 112,00	E
1800	VTX1800	2004-2008	HBK2686	SET UP OEM ANTERIORE	1					1	€ 28,00	E
650	FX650 Vigor	2000	HBK2364	SET UP OEM ANTERIORE				1		1	€ 28,00	E
HUSABERG												
550	550 FC	1999-2005	HBK2990	SET UP OEM ANTERIORE	1			1		2	€ 56,00	E
	400 - 650 Motorcross / Enduro	1999-2005	HBK2991	SET UP OEM ANTERIORE	1			1		2	€ 56,00	E
HUSQVARNA												
125	WR125	2002-2007	HBK3005	SET UP OEM ANTERIORE	1			1		2	€ 56,00	E
250	TC250	2002-2007	HBK3002	SET UP OEM ANTERIORE	1			1		2	€ 56,00	E
250	TC250	2010-2015	HBC3006	LINEA FRIZIONE					1	1	€ 28,00	E
250	TC250	2010-2015	HBK3009	SET UP OEM ANTERIORE	1			1		2	€ 56,00	E
250	TE250	2010-2015	HBC3006	LINEA FRIZIONE					1	1	€ 28,00	E
250	TE250	2010-2015	HBK3008	SET UP OEM ANTERIORE	1			1		2	€ 56,00	E
250	WR250	2002-2007	HBK3005	SET UP OEM ANTERIORE	1			1		2	€ 56,00	E
250	WR250	2010-2015	HBC3006	LINEA FRIZIONE					1	1	€ 28,00	E

CILIND.	MODELLO	ANNI	CODICE	CONFIGURAZIONE	ANT. SUP	ANT. INF	AGG	POST	FRIZ.	TOT. TUBI	PREZZO PUBBLICO IVA ESCL.	FASCIA
250	WR250	2010-2015	HBK3010	SET UP OEM ANTERIORE	1			1		2	€ 56,00	E
300	WR300	2002-2007	HBK3005	SET UP OEM ANTERIORE	1			1		2	€ 56,00	E
310	TE310	2002-2007	HBK3004	SET UP OEM ANTERIORE	1			1		2	€ 56,00	E
310	TE310	2010-2015	HBC3006	LINEA FRIZIONE					1	1	€ 28,00	E
310	TE310	2010-2015	HBK3006	SET UP OEM ANTERIORE	1			1		2	€ 56,00	E
310	TE310R	2010-2015	HBK3007	SET UP OEM ANTERIORE	1			1		2	€ 56,00	E
350	WR350	2010-2015	HBC3006	LINEA FRIZIONE					1	1	€ 28,00	E
350	WR350	2010-2015	HBK3011	SET UP OEM ANTERIORE	1			1		2	€ 56,00	E
360	WR360	1998-2002	HBK3003	SET UP OEM ANTERIORE	1					1	€ 28,00	E
360	WR360	2003-2004	HBK3001	SET UP OEM ANTERIORE	1					1	€ 28,00	E
449	TE449	2010-2015	HBC3006	LINEA FRIZIONE					1	1	€ 28,00	E
450	TC450	2002-2007	HBK3002	SET UP OEM ANTERIORE	1			1		2	€ 56,00	E
450	TE449	2010-2015	HBK3006	SET UP OEM ANTERIORE	1			1		2	€ 56,00	E
450	TE450	2002-2007	HBK3004	SET UP OEM ANTERIORE	1			1		2	€ 56,00	E
510	TE510	2002-2007	HBK3004	SET UP OEM ANTERIORE	1			1		2	€ 56,00	E
570	TC570	2002-2007	HBK3002	SET UP OEM ANTERIORE	1			1		2	€ 56,00	E
650	TR650 Terra	2012-2014	HBK3012	SET UP OEM ANTERIORE	1			1		2	€ 56,00	E
	Trial		HBK3000	SET UP OEM ANTERIORE	1					1	€ 28,00	E
HYOSUNG												
125	RX125	1995-2005	HBK3056	SET UP RACE	1					1	€ 28,00	E
125	XR125	2007-2011	HBK3058	SET UP OEM ANTERIORE	1					1	€ 28,00	E
250	GT250 EFI	2006-2008	HBK3057	SET UP OEM ANTERIORE	1			1		2	€ 56,00	E
650	GT650 Comet	2003-2005	HBK3050	SET UP OEM ANTERIORE	1	2		1		4	€ 112,00	E
650	GT650 R	2006-2007	HBK3051	SET UP RACE	1	1		1		3	€ 84,00	E
650	GV650	2006-2015	HBK3055	SET UP RACE	1	1				2	€ 56,00	E
650	GV650	2006-2015	HBK3054	SET UP OEM ANTERIORE	1	2				3	€ 84,00	E
	GT125R / GT250R	2006-2007	HBK3052	SET UP RACE	1	1		1		3	€ 84,00	E
	GT125R / GT250R	2006-2007	HBK3053	SET UP OEM ANTERIORE	1	2		1		4	€ 112,00	E
ITALJET												
125	Dragster 125	1998-2003	HBK3950	SET UP OEM ANTERIORE	1			1		2	€ 56,00	E
KAWASAKI												
50	AR50 C1 - C10	1981-1997	HBK4042	SET UP OEM ANTERIORE	1					1	€ 28,00	E
65	KX65 Big Wheel	2001-2008	HBK4278	SET UP OEM ANTERIORE	1			1		2	€ 56,00	E
65	KX65 Small Wheel	2001-2008	HBK4736	SET UP OEM ANTERIORE	1			1		2	€ 56,00	E
80	AR80 C1 - C8	1983-1993	HBK4057	SET UP OEM ANTERIORE	1					1	€ 28,00	E
80	KX80	1997-2001	HBK4668	SET UP OEM ANTERIORE	1			1		2	€ 56,00	E
85	KX85	1997-2008	HBK4669	SET UP OEM ANTERIORE	1			1		2	€ 56,00	E
85	KX85	2012-2018	HBK4019	SET UP OEM ANTERIORE					1	1	€ 28,00	E
100	KX100	1997-2001	HBK4272	SET UP OEM ANTERIORE	1					1	€ 28,00	E
125	AR125 A1 - B8	1982-1994	HBK4023	SET UP OEM ANTERIORE	1					1	€ 28,00	E
125	KH125 K2 - K9	1982-1999	HBK4201	SET UP OEM ANTERIORE	1					1	€ 28,00	E
125	KH125 L1-EX	1983-1986	HBK4202	SET UP OEM ANTERIORE	1					1	€ 28,00	E
125	KMX125 A1 - A5 B1 - B12	1986-2002	HBK4251	SET UP OEM ANTERIORE	1			1		2	€ 56,00	E
125	KX125	1990-1993	HBK4274	SET UP OEM ANTERIORE	1			1		2	€ 56,00	E
125	KX125	1994-1996	HBK4671	SET UP OEM ANTERIORE	1			1		2	€ 56,00	E
125	KX125	2000-2002	HBK4666	SET UP OEM ANTERIORE	1			1		2	€ 56,00	E
125	KX125	2003-2008	HBK4006	SET UP OEM ANTERIORE	1			1		2	€ 56,00	E
200	KDX200 E1	1990-1994	HBK4189	SET UP OEM ANTERIORE	1			1		2	€ 56,00	E
200	KMX200 A2 - A3	1986-2002	HBK4252	SET UP OEM ANTERIORE	1			1		2	€ 56,00	E
200	VN2000	2004-2007	HBK4655	SET UP OEM ANTERIORE	1	1	1	1		4	€ 112,00	E
220	KDX220R A4 - A12	1997-2005	HBK4803	SET UP OEM ANTERIORE	1			1		2	€ 56,00	E
250	BJ250 Estrella	1996-1999	HBK4675	SET UP OEM ANTERIORE	1			1		2	€ 56,00	E
250	EL 250 D4 - D5	1993-1996	HBK4068	SET UP OEM ANTERIORE	1					1	€ 28,00	E
250	ER250 Z250T Scorpion B1 - B3	1983-1990	HBK4352	SET UP OEM ANTERIORE	1					1	€ 28,00	E

CILIND.	MODELLO	ANNI	CODICE	CONFIGURAZIONE	ANT. SUP	ANT. INF	AGG	POST	FRIZ.	TOT. TUBI	PREZZO PUBBLICO IVA ESCL.	FASCIA
250	GPX250R	1988-1996	HBK4661	SET UP RACE	1			1		2	€ 56,00	E
250	KH250 A1	1976-1980	HBK4210	SET UP OEM ANTERIORE	1	1				2	€ 56,00	E
250	KH250 B1 - B5	1979-1982	HBK4211	SET UP OEM ANTERIORE	1	1				2	€ 56,00	E
250	KLR250 D1 - D16	1984-2001	HBK4238	SET UP OEM ANTERIORE	1					1	€ 28,00	E
250	KMX250	2007	HBK4711	SET UP OEM ANTERIORE	1			1		2	€ 56,00	E
250	KR1 KR250B2	1989-1992	HBK4267	SET UP OEM ANTERIORE	1	2		1		4	€ 112,00	E
250	KR1S KR250C2	1989-1992	HBK4269	SET UP OEM ANTERIORE	1	2		1		4	€ 112,00	E
250	KX250	1990-1992	HBK4670	SET UP OEM ANTERIORE	1			1		2	€ 56,00	E
250	KX250	1994-1996	HBK4672	SET UP OEM ANTERIORE	1			1		2	€ 56,00	E
250	KX250	1997-2000	HBK4275	SET UP OEM ANTERIORE	1			1		2	€ 56,00	E
250	KX250	2001-2003	HBK4652	SET UP OEM ANTERIORE	1			1		2	€ 56,00	E
250	KX250	2004-2006	HBK4679	SET UP OEM ANTERIORE	1			1		2	€ 56,00	E
250	KX250	2006-2008	HBK4700	SET UP OEM ANTERIORE	1					1	€ 28,00	E
250	KX250F	2004-2006	HBK4746	SET UP OEM ANTERIORE	1			1		2	€ 56,00	E
250	KX250F	2005-2008	HBK4732	SET UP OEM ANTERIORE	1			1		2	€ 56,00	E
250	KX250F	2009-2015	HBK4731	SET UP OEM ANTERIORE	1			1		2	€ 56,00	E
250	Ninja 250R	2008-2012	HBK4720	SET UP OEM ANTERIORE	1			1		2	€ 56,00	E
250	Z250 A1- A3 Twin	1979-1981	HBK4349	SET UP OEM ANTERIORE	1			1		2	€ 56,00	E
250	ZZR250 EX250 H1 - H2	1990-1992	HBK4580	SET UP OEM ANTERIORE	1			1		2	€ 56,00	E
252	EL 252 F2	1997-1999	HBK4072	SET UP OEM ANTERIORE	1					1	€ 28,00	E
300	KLX300	1999-2002	HBK4627	SET UP OEM ANTERIORE	1			1		2	€ 56,00	E
300	Ninja 300 ABS	2013-2017	HBK4005	SET UP OEM ANTERIORE	2			2		4	€ 144,00	E
300	Quad : KLF300	2003-2004	HBK4622	SET UP OEM ANTERIORE	1	1	1			3	€ 84,00	E
300	Ninja 300	2015-2018	HBK40003	SET UP RACE	1			1		2	€ 56,00	E
305	GPZ305 EX305 A1 - B10	1983-1996	HBK4108	SET UP OEM ANTERIORE	1	2				3	€ 84,00	E
400	GPX400R Import	1987-1988	HBK4726	SET UP OEM ANTERIORE	1	2				3	€ 84,00	E
400	KH400 A1 - A4	1977-1980	HBK4217	SET UP OEM ANTERIORE	1	1				2	€ 56,00	E
400	KLX400	2004-2005	HBK4681	SET UP OEM ANTERIORE	1			1		2	€ 56,00	E
400	KLX400	2006-2007	HBK4706	SET UP OEM ANTERIORE	1			1		2	€ 56,00	E
400	KZ400	1975	HBK4281	SET UP OEM ANTERIORE	1	1				2	€ 56,00	E
400	Z400 FII C2	1984-1987	HBK4360	SET UP OEM ANTERIORE	1	2				3	€ 84,00	E
400	Z400 J1	1979	HBK4364	SET UP OEM ANTERIORE	1	2				3	€ 84,00	E
400	Z400 J2 - J3	1981-1983	HBK4365	SET UP OEM ANTERIORE	1	2				3	€ 84,00	E
400	Z400 S3		HBK4367	SET UP OEM ANTERIORE	1					1	€ 28,00	E
400	Z400 Twin	1980	HBK4368	SET UP OEM ANTERIORE	1	1				2	€ 56,00	E
400	Z400F ZR400 A1 - B1	1983-1985	HBK4369	SET UP OEM ANTERIORE	1	2				3	€ 84,00	E
400	ZX400 C2-C3	1985-1987	HBK4008	SET UP OEM ANTERIORE	1	1	1			3	€ 84,00	E
400	ZX400 G Import	1988	HBK4683	SET UP OEM ANTERIORE	1	2		1		4	€ 112,00	E
400	ZXR400 H1 - H2 Import	1989-1990	HBK4624	SET UP RACE	1	1		1		3	€ 84,00	E
400	ZXR400 L1 - L9	1991-2003	HBK4532	SET UP RACE	1	1		1		3	€ 84,00	E
400	ZXR400 L1 - L9	1991-2003	HBK4531	SET UP OEM ANTERIORE	1	2		1		4	€ 112,00	E
400	ZZR400	1990-2006	HBK4614	SET UP OEM ANTERIORE	1	1		1		3	€ 84,00	E
400	Ninja 400 ABS	2018-2019	HBK4015	SET UP OEM ANTERIORE	1	1	1	1		4	€ 144,00	E
440	Z440 (Ltd Z440) A	1981-1983	HBK4377	SET UP OEM ANTERIORE	1	1				2	€ 56,00	E
440	Z440 C1 - C2	1980-1982	HBK4372	SET UP OEM ANTERIORE	1					1	€ 28,00	E
440	Z440 D4 - D6	1982-1985	HBK4376	SET UP OEM ANTERIORE	1					1	€ 28,00	E
440	Z440 H1 - H2	1982-1983	HBK4374	SET UP OEM ANTERIORE	1					1	€ 28,00	E
450	EN450 Z450 Ltd A1 - A5	1985-1990	HBK4384	SET UP OEM ANTERIORE	1					1	€ 28,00	E
450	KLX450R	2008-2015	HBK4722	SET UP OEM ANTERIORE	1			1		2	€ 56,00	E
450	KMX450	2007	HBK4710	SET UP OEM ANTERIORE	1			1		2	€ 56,00	E
450	KX450F	2006-2008	HBK4704	SET UP OEM ANTERIORE	1			1		2	€ 56,00	E
450	KX450F	2009-2015	HBK4750	SET UP OEM ANTERIORE	1			1		2	€ 56,00	E
450	KX450F	2019	HBC4018	LINEA FRIZIONE					1	1	€ 28,00	E
450	KX450F	2019	HBK4018	SET UP OEM ANTERIORE	1					1	€ 28,00	E
500	EN500 A1 - C2	1990-1997	HBK4075	SET UP OEM ANTERIORE	1					1	€ 28,00	E

CILIND.	MODELLO	ANNI	CODICE	CONFIGURAZIONE	ANT. SUP	ANT. INF	AGG	POST	FRIZ.	TOT. TUBI	PREZZO PUBBLICO IVA ESCL.	FASCIA
500	ER-5 ER500 A1 - C1	1996-2006	HBF4081	SET UP OEM ANTERIORE	1					1	€ 28,00	E
500	GPZ500 S E9-E10 (Twin disc)	2002-2004	HBK4616	SET UP OEM ANTERIORE	1	2		1		4	€ 112,00	E
500	GPZ500 S EX500 A1 - A6	1987-1993	HBF4118	SET UP OEM ANTERIORE	1					1	€ 28,00	E
500	GPZ500 S EX500 D1 - D7	1994-2003	HBK4615	SET UP OEM ANTERIORE	1			1		2	€ 56,00	E
500	KH500	1976	HBK4221	SET UP OEM ANTERIORE	1	1				2	€ 56,00	E
500	KLE500 A1 - A3	1991-2002	HBK4226	SET UP OEM ANTERIORE	1			1		2	€ 56,00	E
500	KLE500 A3 - A7	2003-2007	HBK4759	SET UP OEM ANTERIORE	1			1		2	€ 56,00	E
500	KX500	1990-1993	HBK4276	SET UP OEM ANTERIORE	1			1		2	€ 56,00	E
500	KX500	1994-2001	HBK4643	SET UP OEM ANTERIORE	1			1		2	€ 56,00	E
500	KX500	2001-2004	HBK4667	SET UP OEM ANTERIORE	1			1		2	€ 56,00	E
500	Vulcan 500	1996-1997	HBF4729	SET UP OEM ANTERIORE	1					1	€ 28,00	E
500	Z500	1980-1983	HBK4391	SET UP OEM ANTERIORE	1	2				3	€ 84,00	E
550	550 ZR550 B1 - B6 Zephyr	1991-1998	HBK4427	SET UP OEM ANTERIORE	1	2		1		4	€ 112,00	E
550	GPZ550 Z550 A1 - A4	1983-1988	HBK4126	SET UP OEM ANTERIORE	1	2	2	1		6	€ 168,00	E
550	GPZ550 Z550 D1	1981	HBK4130	SET UP OEM ANTERIORE	1	2				3	€ 84,00	E
550	GPZ550 Z550 H1 - H2 Unitrak	1982	HBK4131	SET UP OEM ANTERIORE	1	2		1		4	€ 112,00	E
550	GT550 Z550 G1 - G9	1983-2001	HBK4165	SET UP OEM ANTERIORE	1	2				3	€ 84,00	E
550	Z550 A1	1980	HBK4392	SET UP OEM ANTERIORE	1	2				3	€ 84,00	E
550	Z550 A2 - A3	1981-1982	HBK4393	SET UP OEM ANTERIORE	1	2				3	€ 84,00	E
550	Z550 F ZR550 A1 - A2	1982-1987	HBK4395	SET UP OEM ANTERIORE	1	2				3	€ 84,00	E
550	Z550 Ltd C1 - C2	1980-1983	HBK4400	SET UP OEM ANTERIORE	1	2				3	€ 84,00	E
600	GPX600R C1 - C3	1988-1997	HBK4087	SET UP OEM ANTERIORE	1	2		1		4	€ 112,00	E
600	GPZ600R ZX600 A1 - A5	1985-1990	HBK4134	SET UP RACE	1	1	2	1		5	€ 140,00	E
600	GPZ600R ZX600 A1 - A5	1985-1990	HBK4133	SET UP OEM ANTERIORE	1	2	2	1		6	€ 168,00	E
600	KLR600 A1 - B4	1984-1990	HBF4240	SET UP OEM ANTERIORE	1					1	€ 28,00	E
600	ZL600 B1 Eliminator	1995-1997	HBF4453	SET UP OEM ANTERIORE	1					1	€ 28,00	E
600	ZX6R Ninja	2005-2006	HBK4676	SET UP RACE	1	1		1		3	€ 84,00	E
600	ZX6R Ninja	2007-2008	HBK4709	SET UP RACE	1	1		1		3	€ 84,00	E
600	ZX6R Ninja	2009-2012	HBK4734	SET UP RACE	1	1		1		3	€ 84,00	E
600	ZX6R Ninja	2013-2016	HBK4799	SET UP RACE	1	1		1		3	€ 84,00	E
600	ZX6R Ninja	2013-2016	HBK4801	SET UP SOPRA PARAFANGO ANTERIORE	1	1		1		3	€ 84,00	E
600	ZX6R Ninja ABS	2013-2018	HBK4802	SET UP OEM ANTERIORE	6			2		8	€ 288,00	E
600	ZX6R	2019	HBFKK0017	SET UP RACE - SUPERSTOCK	4			1		5	€ 140,00	E
600	ZX6R Ninja ZX600 C1H 636	2005-2006	HBK4718	SET UP SOPRA PARAFANGO ANTERIORE	1	1		1		3	€ 84,00	E
600	ZX6R Ninja ZX600 C1H 636	2005-2006	HBK4719	SET UP RACE	1	1		1		3	€ 84,00	E
600	ZX6R Ninja ZX600 F1 - F3	1995-1997	HBK4484	SET UP RACE	1	1		1		3	€ 84,00	E
600	ZX6R Ninja ZX600 F1 - F3	1995-1997	HBK4483	SET UP OEM ANTERIORE	1	2		1		4	€ 112,00	E
600	ZX6R Ninja ZX600 G1 - G2	1998-1999	HBK4490	SET UP RACE	1	1		1		3	€ 84,00	E
600	ZX6R Ninja ZX600 G1 - G2	1998-1999	HBK4489	SET UP OEM ANTERIORE	1	2		1		4	€ 112,00	E
600	ZX6RR Ninja	2005-2006	HBK4677	SET UP SOPRA PARAFANGO ANTERIORE	1	1		1		3	€ 84,00	E
600	ZX6RR Ninja B1 - K1	2003-2004	HBK4698	SET UP SOPRA PARAFANGO ANTERIORE	1	1		1		3	€ 84,00	E
600	ZX6RR Ninja B1 - K1	2003-2004	HBK4699	SET UP RACE	1	1		1		3	€ 84,00	E
600	ZZR600 ZX600 D1 - E11	1990-2006	HBK4585	SET UP RACE	1	1		1		3	€ 84,00	E
600	ZZR600 ZX600 D1 - E11	1990-2006	HBK4584	SET UP OEM ANTERIORE	1	2		1		4	€ 112,00	E
636	ZX6R Ninja ZX600 B1H	2003-2004	HBK4662	SET UP SOPRA PARAFANGO ANTERIORE	1	1		1		3	€ 84,00	E
636	ZX6R Ninja ZX600 B1H	2003-2004	HBK4663	SET UP RACE	1	1		1		3	€ 84,00	E
636	ZX6R Ninja ZX600 J1 - J2 A1P (636)	2000-2002	HBK4496	SET UP RACE	1	1		1		3	€ 84,00	E
636	ZX6R Ninja ZX600 J1 - J2 A1P (636)	2000-2002	HBK4495	SET UP OEM ANTERIORE	1	1	1	1		4	€ 112,00	E

CILIND.	MODELLO	ANNI	CODICE	CONFIGURAZIONE	ANT. SUP	ANT. INF	AGG	POST	FRIZ.	TOT. TUBI	PREZZO PUBBLICO IVA ESCL.	FASCIA
650	ER6-F	2012-2014	HBK4768	SET UP SOPRA PARAFANGO ANTERIORE	1	1		1		3	€ 84,00	E
650	ER6-F	2012-2014	HBK4769	SET UP RACE	1	1		1		3	€ 84,00	E
650	ER-6F	2006-2011	HBK4687	SET UP RACE	1	1		1		3	€ 84,00	E
650	ER-6F	2006-2011	HBK4688	SET UP SOPRA PARAFANGO ANTERIORE	1	1		1		3	€ 84,00	E
650	ER-6F	2012-2016	HBK4771	SET UP RACE	1	1		1		3	€ 84,00	E
650	ER-6F	2012-2016	HBK4772	SET UP SOPRA PARAFANGO ANTERIORE	1	1		1		3	€ 84,00	E
650	ER-6F ABS	2012-2016	HBK4760	SET UP OEM ANTERIORE	5			2		7	€ 252,00	E
650	ER-6N	2006-2011	HBK4689	SET UP RACE	1	1		1		3	€ 84,00	E
650	ER-6N	2006-2011	HBK4690	SET UP SOPRA PARAFANGO ANTERIORE	1	1		1		3	€ 84,00	E
650	ER-6N	2012-2016	HBK4762	SET UP SOPRA PARAFANGO ANTERIORE	1	1		1		3	€ 84,00	E
650	ER-6N	2012-2016	HBK4773	SET UP RACE	1	1		1		3	€ 84,00	E
650	ER-6N ABS	2006-2011	HBK4744	SET UP OEM ANTERIORE	7					7	€ 252,00	E
650	ER-6N ABS	2012-2016	HBK4776	SET UP OEM ANTERIORE	1	2	2	2		7	€ 252,00	E
650	KL650 B1 - B3 Tengai	1989-1991	HBK4222	SET UP OEM ANTERIORE	1			1		2	€ 56,00	E
650	KLE650 Versys	2007-2009	HBK4707	SET UP SOPRA PARAFANGO ANTERIORE	1	1		1		3	€ 84,00	E
650	KLE650 Versys	2007-2009	HBK4708	SET UP RACE	1	1		1		3	€ 84,00	E
650	KLE650 Versys	2010-2014	HBK4774	SET UP RACE	1	1		1		3	€ 84,00	E
650	KLE650 Versys	2010-2014	HBK4775	SET UP SOPRA PARAFANGO ANTERIORE	1	1		1		3	€ 84,00	E
650	KLE650 Versys ABS	2007-2009	HBK4755	SET UP OEM ANTERIORE	5			2		7	€ 252,00	E
650	KLR650 A1 - A3 C1 - C8	1987-2002	HBK4244	SET UP OEM ANTERIORE	1			1		2	€ 56,00	E
650	KLX650 C1 - C2	1993-1996	HBK4247	SET UP OEM ANTERIORE	1			1		2	€ 56,00	E
650	KZ650 F2 - F4 Roadster	1981-1984	HBK4282	SET UP OEM ANTERIORE	1	2				3	€ 84,00	E
650	Ninja 650 ABS	2017-2018	HBK4009	SET UP OEM ANTERIORE	3			1		4	€ 144,00	E
650	W650 EJ650 A1 - C4 EU Wide Bar	1999-2006	HBF4314	SET UP OEM ANTERIORE	1					1	€ 28,00	E
650	W650 EJ650 A1 - C4 UK Low Bar	1999-2006	HBF4313	SET UP OEM ANTERIORE	1					1	€ 28,00	E
650	Z650 ABS	2017-2018	HBK4011	SET UP OEM ANTERIORE	1	1	1	1		4	€ 56,00	E
650	Z650 B1	1977	HBK4405	SET UP OEM ANTERIORE	1	1				2	€ 56,00	E
650	Z650 B2 - B3	1978-1979	HBK4406	SET UP OEM ANTERIORE	1	2				3	€ 84,00	E
650	Z650 C2 - C3	1978-1980	HBK4409	SET UP OEM ANTERIORE	1	2		1		4	€ 112,00	E
650	Z650 D2 - D3	1978-1980	HBK4411	SET UP OEM ANTERIORE	1	2				3	€ 84,00	E
650	Z650 F1	1980	HBK4412	SET UP OEM ANTERIORE	1	2				3	€ 84,00	E
650	Vulcan 650 S ABS (EN650BFF - EN650DJF)	2015-2018	HBK4017	SET UP OEM ANTERIORE	1	1		2		4	€ 144,00	E
700	Quad : KFX700	2000-2006	HBK4684	SET UP OEM ANTERIORE	1	1				2	€ 56,00	E
750	750 ZR750 C1 - D1 Zephyr	1991-1999	HBK4004	SET UP RACE	1	1		1		3	€ 84,00	E
750	750 ZR750 C1 - D1 Zephyr	1991-1999	HBK4003	SET UP OEM ANTERIORE	1	2		1		4	€ 112,00	E
750	GPX750R F1 - F3	1987-1991	HBC4091	LINEA FRIZIONE					1	1	€ 28,00	E
750	GPX750R ZX750 F1 - F3	1987-1991	HBK4091	SET UP OEM ANTERIORE	1	2		1		4	€ 112,00	E
750	GPZ750 Turbo ZX750 E1 - E2	1983-1987	HBK4147	SET UP OEM ANTERIORE	1	2	2	1		6	€ 168,00	E
750	GPZ750 Z750 A1 - A5	1983-1988	HBK4152	SET UP OEM ANTERIORE	1	2		1		4	€ 112,00	E
750	GPZ750 Z750 R1	1982	HBK4156	SET UP OEM ANTERIORE	1	2	2	1		6	€ 168,00	E
750	GPZ750R R1 Non Anti-Dive	1981	HBK4148	SET UP OEM ANTERIORE	1	2		1		4	€ 112,00	E
750	GT750 Z750 P1 - P5	1982-1990	HBK4179	SET UP OEM ANTERIORE	1	2		1		4	€ 112,00	E
750	GT750 Z750 P7 - P9	1991-1996	HBK4665	SET UP OEM ANTERIORE	1	2		1		4	€ 112,00	E
750	KH750 Single Disc Retaining Metal	1975	HBK4747	SET UP OEM ANTERIORE	1	1				2	€ 56,00	E
750	KZ750 E	1980	HBK4284	SET UP OEM ANTERIORE	1	2		1		4	€ 112,00	E
750	VN750	1995-2006	HBK4740	SET UP OEM ANTERIORE	1	1		1		3	€ 84,00	E

CILIND.	MODELLO	ANNI	CODICE	CONFIGURAZIONE	ANT. SUP	ANT. INF	AGG	POST	FRIZ.	TOT. TUBI	PREZZO PUBBLICO IVA ESCL.	FASCIA
750	Z750	2004-2006	HBK4654	SET UP SOPRA PARAFANGO ANTERIORE	1	1		1		3	€ 84,00	E
750	Z750	2004-2006	HBK4664	SET UP RACE	1	1		1		3	€ 84,00	E
750	Z750	2007-2012	HBK4713	SET UP SOPRA PARAFANGO ANTERIORE	1	1		1		3	€ 84,00	E
750	Z750	2007-2012	HBK4714	SET UP RACE	1	1		1		3	€ 84,00	E
750	Z750 ABS	2007-2012	HBK4733	SET UP OEM ANTERIORE	5			2		7	€ 252,00	E
750	Z750 E		HBK4415	SET UP OEM ANTERIORE	1	2				3	€ 84,00	E
750	Z750 L2 - L4	1982-1984	HBK4416	SET UP OEM ANTERIORE	1	2		1		4	€ 112,00	E
750	Z750 Ltd Z750H2	1980-1981	HBK4423	SET UP OEM ANTERIORE	1	2		1		4	€ 112,00	E
750	Z750 Y1 Twin	1982-1983	HBK4424	SET UP OEM ANTERIORE	1	1		1		3	€ 84,00	E
750	Z750B Twin	1977	HBK4703	SET UP OEM ANTERIORE	1	1		1		3	€ 84,00	E
750	Z750S	2004-2006	HBK4692	SET UP RACE	1	1		1		3	€ 84,00	E
750	Z750S	2004-2006	HBK4693	SET UP SOPRA PARAFANGO ANTERIORE	1	1		1		3	€ 84,00	E
750	ZR-7 ZR750 F1 - F5 ZR - 75 H3	1999-2003	HBK4606	SET UP RACE	1	1		1		3	€ 84,00	E
750	ZR-7 ZR750 F1 - F5 ZR - 75 H3	1999-2003	HBK4456	SET UP OEM ANTERIORE	1	2		1		4	€ 112,00	E
750	ZX750		HBK4497	SET UP OEM ANTERIORE	1	2	2	1		6	€ 168,00	E
750	ZX750 GPA1		HBK4498	SET UP OEM ANTERIORE	1	2	2	1		6	€ 168,00	E
750	ZX7R Ninja ZX750 P1 - P7	1996-2003	HBC4501	LINEA FRIZIONE					1	1	€ 28,00	E
750	ZX7R Ninja ZX750 P1 - P7	1996-2003	HBK4502	SET UP RACE	1	1		1		3	€ 84,00	E
750	ZX7R Ninja ZX750 P1 - P7	1996-2003	HBK4501	SET UP OEM ANTERIORE	1	2		1		4	€ 112,00	E
750	ZX7RR Ninja ZX750 N1	1996-2003	HBK4514	SET UP RACE	1	1		1		3	€ 84,00	E
750	ZX7RR Ninja ZX750 N1	1996-2003	HBK4513	SET UP OEM ANTERIORE	1	2		1		4	€ 112,00	E
750	ZXR750 H1 - H2	1989-1990	HBC4545	LINEA FRIZIONE					1	1	€ 28,00	E
750	ZXR750 J1 - J2	1991-1995	HBC4547	LINEA FRIZIONE					1	1	€ 28,00	E
750	ZXR750 ZX750 H1 - H2	1989-1990	HBK4546	SET UP RACE	1	1		1		3	€ 84,00	E
750	ZXR750 ZX750 H1 - H2	1989-1990	HBK4545	SET UP OEM ANTERIORE	1	2		1		4	€ 112,00	E
750	ZXR750 ZX750 J1 - J2	1991-1992	HBK4548	SET UP RACE	1	1		1		3	€ 84,00	E
750	ZXR750 ZX750 J1 - J2	1991-1992	HBK4547	SET UP OEM ANTERIORE	1	2		1		4	€ 112,00	E
750	ZXR750 ZX750 K1 - L1	1991-1996	HBK4552	SET UP RACE	1	1		1		3	€ 84,00	E
750	ZXR750 ZX750 K1 - L1	1991-1996	HBK4551	SET UP OEM ANTERIORE	1	2		1		4	€ 112,00	E
750	ZXR750R ZX750 M1 - M2	1992-1994	HBK4730	SET UP RACE	1	1		1		3	€ 84,00	E
750	ZXR750R ZX750 M1 - M2	1992-1994	HBK4558	SET UP OEM ANTERIORE	1	2		1		4	€ 112,00	E
750	Z750R	2011-2012	HBK4013	SET UP SOPRA PARAFANGO ANTERIORE	1	1		1		3	€ 84,00	E
750	Z750R	2011-2012	HBK4014	SET UP RACE	1	1		1		3	€ 84,00	E
800	VN800 A1 - A3 B1 - B6 Classic E1 - E2 Drifter	1995-2006	HBK4301	SET UP OEM ANTERIORE	1					1	€ 28,00	E
800	W800	2011-2016	HBK4753	SET UP OEM ANTERIORE	1					1	€ 28,00	E
800	Z800 ABS	2013-2016	HBK4007	SET UP OEM ANTERIORE	4			1		5	€ 180,00	E
800	Z800 Non ABS	2013-2016	HBK4766	SET UP SOPRA PARAFANGO ANTERIORE	1	1		1		3	€ 84,00	E
800	Z800 Non ABS	2013-2016	HBK4767	SET UP RACE	1	1		1		3	€ 84,00	E
900	GPZ900R A1 - A8	1984-1996	HBC4157	LINEA FRIZIONE					1	1	€ 28,00	E
900	GPZ900R ZX900 A1 - A6	1984-1989	HBK4157	SET UP OEM ANTERIORE	1	2	2	1		6	€ 168,00	E
900	GPZ900R ZX900 A1-6 US SPEC	1984-1989	HBK4158	SET UP OEM ANTERIORE	1	2	2	1		6	€ 168,00	E
900	GPZ900R ZX900 A7 - A8	1990-1992	HBK4686	SET UP RACE	1	1		1		3	€ 84,00	E
900	GPZ900R ZX900 A7 - A8	1990-1992	HBK4685	SET UP OEM ANTERIORE	1	2		1		4	€ 112,00	E
900	VN900 Classic	2006-2010	HBK4691	SET UP OEM ANTERIORE	1			1		2	€ 56,00	E
900	Z900	1978	HBK4426	SET UP OEM ANTERIORE	1	2				3	€ 84,00	E
900	Z900 ABS	2017-2018	HBK4010	SET UP OEM ANTERIORE	3			3		6	€ 216,00	E
900	Z900 Replaces Metal Pipe	1976	HBK4765	SET UP RACE	1			1		2	€ 56,00	E
900	Z900 Retains Metal Pipe	1976	HBK4764	SET UP RACE	1			1		2	€ 56,00	E
900	ZX9R B1 - B4	1994-1997	HBC4519	LINEA FRIZIONE					1	1	€ 28,00	E
900	ZX9R C1 - C2	1998-1999	HBC4523	LINEA FRIZIONE					1	1	€ 28,00	E

CILIND.	MODELLO	ANNI	CODICE	CONFIGURAZIONE	ANT. SUP	ANT. INF	AGG	POST	FRIZ.	TOT. TUBI	PREZZO PUBBLICO IVA ESCL.	FASCIA
900	ZX9R E1 - E2	2000-2001	HBC4528	LINEA FRIZIONE					1	1	€ 28,00	E
900	ZX9R Ninja ZX900 B1 - B2	1994-1995	HBK4751	SET UP RACE	1	1		1		3	€ 84,00	E
900	ZX9R Ninja ZX900 B1 - B2	1994-1995	HBK4752	SET UP OEM ANTERIORE	1	2		1		4	€ 112,00	E
900	ZX9R Ninja ZX900 B3 - B4	1996-1997	HBK4520	SET UP RACE	1	1		1		3	€ 84,00	E
900	ZX9R Ninja ZX900 B3 - B4	1996-1997	HBK4519	SET UP OEM ANTERIORE	1	2		1		4	€ 112,00	E
900	ZX9R Ninja ZX900 C1 - C2	1998-1999	HBK4524	SET UP RACE	1	1		1		3	€ 84,00	E
900	ZX9R Ninja ZX900 C1 - C2	1998-1999	HBK4523	SET UP OEM ANTERIORE	1	2		1		4	€ 112,00	E
900	ZX9R Ninja ZX900 E1 - E2	2000-2001	HBK4528	SET UP RACE	1	1		1		3	€ 84,00	E
900	ZX9R Ninja ZX900 E1 - E2	2000-2001	HBK4678	SET UP OEM ANTERIORE	1	1	1	1		4	€ 112,00	E
900	ZX9R Ninja ZX900 F1P - F2P	2002-2005	HBK4682	SET UP RACE	1	1		1		3	€ 84,00	E
900	Z900RS Cafe ABS (EJF-EKF)	2018-2019	HBK4016	SET UP OEM ANTERIORE	4			2		6	€ 216,00	E
900	Z900RS ABS (CJF / CKF)	2018-2019	HBK4020	SET UP OEM ANTERIORE	4			2		6	€ 168,00	E
900	Z1R	1978	HBK4334	SET UP OEM ANTERIORE	2			1		3	€ 84,00	E
900	Z1R	1978	HBK4348	SET UP OEM ANTERIORE	1			1		2	€ 56,00	E
1000	GPZ1000RX A1 - A3	1985-1989	HBC4096	LINEA FRIZIONE					1	1	€ 28,00	E
1000	GPZ1000RX ZX1000 A1 - A3	1985-1988	HBK4096	SET UP OEM ANTERIORE	1	2	2	1		6	€ 168,00	E
1000	GTR1000 A1-A14	1986-1999	HBC4188	LINEA FRIZIONE					1	1	€ 28,00	E
1000	GTR1000 ZG1000 A1-A4	1986-1989	HBK4188	SET UP OEM ANTERIORE	1	2		1		4	€ 112,00	E
1000	GTR1000 ZG1000 A5-A14	1990-1999	HBK4717	SET UP OEM ANTERIORE	1	2		1		4	€ 112,00	E
1000	KLV1000	2004-2006	HBK4674	SET UP RACE	1	1		1		3	€ 84,00	E
1000	KLV1000	2004-2006	HBK4673	SET UP OEM ANTERIORE	1	1	1	1		4	€ 112,00	E
1000	KLZ1000 Versys ABS	2012-2016	HBK4001	SET UP OEM ANTERIORE	4			1		5	€ 180,00	E
1000	KZ1000 D1	1978	HBK4279	SET UP OEM ANTERIORE	1			1		2	€ 56,00	E
1000	RX1000	1985-1989	HBK4712	SET UP OEM ANTERIORE	1	2	2			5	€ 140,00	E
1000	Z1000	2003-2006	HBK4635	SET UP SOPRA PARAFANGO ANTERIORE	1	1		1		3	€ 84,00	E
1000	Z1000	2003-2006	HBK4636	SET UP RACE	1	1		1		3	€ 84,00	E
1000	Z1000	2007-2009	HBK4715	SET UP SOPRA PARAFANGO ANTERIORE	1	1		1		3	€ 84,00	E
1000	Z1000	2007-2009	HBK4716	SET UP RACE	1	1		1		3	€ 84,00	E
1000	Z1000	2010-2013	HBK4742	SET UP RACE	1	1		1		3	€ 84,00	E
1000	Z1000	2010-2013	HBK4743	SET UP SOPRA PARAFANGO ANTERIORE	1	1		1		3	€ 84,00	E
1000	Z1000	2014-2016	HBK4639	SET UP RACE	1	1		1		3	€ 84,00	E
1000	Z1000 A1	1977	HBK4317	SET UP OEM ANTERIORE	1	2		1		4	€ 112,00	E
1000	Z1000 A2	1978	HBK4318	SET UP OEM ANTERIORE	1	2		1		4	€ 112,00	E
1000	Z1000 A3/A4	1979-1980	HBK4757	SET UP OEM ANTERIORE	1	2		1		4	€ 112,00	E
1000	Z1000 ABS	2014-2019	HBK4739	SET UP OEM ANTERIORE	4			1		5	€ 180,00	E
1000	Z1000 CSR KZ1000M	1980-1990	HBK4041	SET UP OEM ANTERIORE	1	2		1		4	€ 112,00	E
1000	Z1000 H	1980-1981	HBK4320	SET UP OEM ANTERIORE	1	2		1		4	€ 112,00	E
1000	Z1000 J	1977	HBK4321	SET UP OEM ANTERIORE	1	2		1		4	€ 112,00	E
1000	Z1000 J1	1981	HBK4322	SET UP OEM ANTERIORE	1	2		1		4	€ 112,00	E
1000	Z1000 J2 - J3	1981-1984	HBK4323	SET UP OEM ANTERIORE	1	2		1		4	€ 112,00	E
1000	Z1000 Ltd	1979	HBK4761	SET UP OEM ANTERIORE	1	2		1		4	€ 112,00	E
1000	Z1000 Ltd Z1000K1	1981-1983	HBK4326	SET UP OEM ANTERIORE	1	2		1		4	€ 112,00	E
1000	Z1000 MKII	1978-1981	HBK4329	SET UP OEM ANTERIORE	1	2		1		4	€ 112,00	E
1000	Z1000 R2 Eddie Lawson Replica	1983-1984	HBK4330	SET UP OEM ANTERIORE	1	2		1		4	€ 112,00	E
1000	Z1000 ST E1	1979	HBK4333	SET UP OEM ANTERIORE	1	2		1		4	€ 112,00	E
1000	Z1000 ST E2	1980	HBK4332	SET UP OEM ANTERIORE	1	2		1		4	€ 112,00	E
1000	Z1000 SX	2011-2015	HBK4754	SET UP RACE	1	1		1		3	€ 84,00	E
1000	Z1000 SX ABS	2011-2019	HBK4770	SET UP OEM ANTERIORE	4			1		5	€ 180,00	E
1000	ZL1000 A1 Eliminator	1987-1990	HBK4448	SET UP OEM ANTERIORE	1	2		1		4	€ 112,00	E
1000	ZX10 B1 - B3	1988-1991	HBC4470	LINEA FRIZIONE					1	1	€ 28,00	E
1000	ZX10 ZX1000 B1 - B3	1988-1991	HBK4725	SET UP RACE	1	1		1		3	€ 84,00	E

CILIND.	MODELLO	ANNI	CODICE	CONFIGURAZIONE	ANT. SUP	ANT. INF	AGG	POST	FRIZ.	TOT. TUBI	PREZZO PUBBLICO IVA ESCL.	FASCIA
1000	ZX10 ZX1000 B1 - B3	1988-1991	HBK4470	SET UP OEM ANTERIORE	1	2		1		4	€ 112,00	E
1000	ZX10R ABS	2011-2015	HBK4758	SET UP OEM ANTERIORE	4			2		6	€ 216,00	E
1000	ZX10R ABS	2016-2018	HBK4756	SET UP OEM ANTERIORE	4			2		6	€ 216,00	E
1000	ZX10R Ninja	2004-2005	HBK4651	SET UP SOPRA PARAFANGO ANTERIORE	1	1		1		3	€ 84,00	E
1000	ZX10R Ninja	2004-2005	HBK4653	SET UP RACE	1	1		1		3	€ 84,00	E
1000	ZX10R Ninja	2006-2007	HBK4694	SET UP RACE	1	1		1		3	€ 84,00	E
1000	ZX10R Ninja	2006-2007	HBK4695	SET UP SOPRA PARAFANGO ANTERIORE	1	1		1		3	€ 84,00	E
1000	ZX10R Ninja	2008-2010	HBK4723	SET UP SOPRA PARAFANGO ANTERIORE	1	1		1		3	€ 84,00	E
1000	ZX10R Ninja	2008-2010	HBK4724	SET UP RACE	1	1		1		3	€ 84,00	E
1000	ZX10R Ninja	2011-2015	HBK4749	SET UP RACE	1	1		1		3	€ 84,00	E
1000	ZX10R Ninja Supersport	2016-2018	HBFKK0001	SET UP RACE	4			1		5	€ 140,00	E
1100	1100 ZR1100 A1 - B1 Zephyr	1992-1997	HBC4436	LINEA FRIZIONE					1	1	€ 28,00	E
1100	1100 ZR1100 A1 - B1 Zephyr	1992-1997	HBK4436	SET UP OEM ANTERIORE	1	2		1		4	€ 112,00	E
1100	GPZ1100 Z1100 A1 - A2	1983-1984	HBK4099	SET UP OEM ANTERIORE	1	2	2	1		6	€ 168,00	E
1100	GPZ1100 Z1100 A3 Non ABS	1985	HBK4101	SET UP OEM ANTERIORE	1	2		1		4	€ 112,00	E
1100	GPZ1100 Z1100 B1 - B2	1981-1982	HBK4102	SET UP OEM ANTERIORE	1	2		1		4	€ 112,00	E
1100	GPZ1100S ZX1100 E1 - E2 Non ABS	1995-1999	HBK4104	SET UP OEM ANTERIORE	1	2		1		4	€ 112,00	E
1100	Z1100 A1 - A4	1981-1983	HBK4335	SET UP OEM ANTERIORE	1	2		1		4	€ 112,00	E
1100	Z1100 R1 Eddie Lawson Replica	1984-1986	HBK4339	SET UP OEM ANTERIORE	1	2		1		4	€ 112,00	E
1100	ZL1100 Custom	1987	HBK4452	SET UP OEM ANTERIORE	1	2				3	€ 84,00	E
1100	ZL1100 Custom		HBC4452	LINEA FRIZIONE					1	1	€ 28,00	E
1100	ZRX1100 C1 - C4	1997-2001	HBK4460	SET UP RACE	1	1		1		3	€ 84,00	E
1100	ZRX1100 C1 - C4	1997-2001	HBK4459	SET UP OEM ANTERIORE	1	2		1		4	€ 112,00	E
1100	ZRX1100 C1 - C4	1997-2002	HBC4460	LINEA FRIZIONE					1	1	€ 28,00	E
1100	ZX1100 A1	1982-1983	HBK4474	SET UP OEM ANTERIORE	1	2	2	1		6	€ 168,00	E
1100	ZX1100 A2	1984-1989	HBK4475	SET UP OEM ANTERIORE	1	2	2	1		6	€ 168,00	E
1100	ZX1100 C1	1990-1995	HBK4476	SET UP OEM ANTERIORE	1	2		1		4	€ 112,00	E
1100	ZZR1100 ZX1100 C1 - C3	1990-1992	HBK4561	SET UP RACE	1	1		1		3	€ 84,00	E
1100	ZZR1100 ZX1100 C1 - C3	1990-1992	HBK4560	SET UP OEM ANTERIORE	1	2		1		4	€ 112,00	E
1100	ZZR1100 ZX1100 C1 - D9	1990-2001	HBC4560	LINEA FRIZIONE					1	1	€ 28,00	E
1100	ZZR1100 ZX1100 D1 - D9	1992-2001	HBK4567	SET UP RACE	1	1		1		3	€ 84,00	E
1100	ZZR1100 ZX1100 D1 - D9	1992-2001	HBK4566	SET UP OEM ANTERIORE	1	2		1		4	€ 112,00	E
1200	ZRX1200 A1 - A3P	2001-2005	HBK4660	SET UP RACE	1	1		1		3	€ 84,00	E
1200	ZRX1200 A1 - A3P	2001-2005	HBK4659	SET UP OEM ANTERIORE	1	2		1		4	€ 112,00	E
1200	ZRX1200R A1 - A3P	2001-2006	HBC4461	LINEA FRIZIONE					1	1	€ 28,00	E
1200	ZRX1200R A1 - A3P	2001-2006	HBK4645	SET UP RACE	1	1		1		3	€ 84,00	E
1200	ZRX1200R A1 - A3P	2001-2006	HBK4644	SET UP OEM ANTERIORE	1	2		1		4	€ 112,00	E
1200	ZRX1200S B1 - B3P	2001-2005	HBK4610	SET UP RACE	1	1		1		3	€ 84,00	E
1200	ZRX1200S B1 - B3P	2001-2005	HBK4611	SET UP OEM ANTERIORE	1	2		1		4	€ 112,00	E
1200	ZX12R Ninja ZX1200 A1 - A2 B1H - B2H C1H - C2H	1999-2003	HBK4478	SET UP RACE	1	1		1		3	€ 84,00	E
1200	ZX12R Ninja ZX1200 A1 - A2 B1H - B2H C1H - C2H	1999-2003	HBK4477	SET UP OEM ANTERIORE	1	1	1	1		4	€ 112,00	E
1200	ZX12R Ninja ZX1200 R	2003-2006	HBK4637	SET UP RACE	1	1		1		3	€ 84,00	E
1200	ZX12R Ninja ZX1200 R	2003-2006	HBK4638	SET UP SOPRA PARAFANGO ANTERIORE	1	1		1		3	€ 84,00	E
1200	ZZR1200 ZX1200	2002-2006	HBC4631	LINEA FRIZIONE					1	1	€ 28,00	E
1200	ZZR1200 ZX1200	2002-2006	HBK4632	SET UP RACE	1	1		1		3	€ 84,00	E
1200	ZZR1200 ZX1200	2002-2006	HBK4631	SET UP OEM ANTERIORE	1	2		1		4	€ 112,00	E
1300	KZ1300 B2 US Import	1980	HBK4280	SET UP OEM ANTERIORE	1	2		1		4	€ 112,00	E
1300	Z1300 A1 - A2	1979-1980	HBK4342	SET UP OEM ANTERIORE	1	2		1		4	€ 112,00	E

CILIND.	MODELLO	ANNI	CODICE	CONFIGURAZIONE	ANT. SUP	ANT. INF	AGG	POST	FRIZ.	TOT. TUBI	PREZZO PUBBLICO IVA ESCL.	FASCIA
1300	Z1300 A3 - A5	1981-1984	HBK4344	SET UP OEM ANTERIORE	1	2		1		4	€ 112,00	E
1300	ZG1300 A1 - A3	1987-1990	HBK4442	SET UP OEM ANTERIORE	1	2		1		4	€ 112,00	E
1400	ZZR1400	2006-2017	HBC4696	LINEA FRIZIONE					1	1	€ 28,00	E
1400	ZZR1400 ZX14	2006-2014	HBK4697	SET UP SOPRA PARAFANGO ANTERIORE	1	1		1		3	€ 84,00	E
1400	ZZR1400 ZX14	2006-2014	HBK4702	SET UP RACE	1	1		1		3	€ 84,00	E
1400	ZZR1400 ZX14 ABS	2006-2017	HBK4745	SET UP OEM ANTERIORE	7			2		9	€ 324,00	E
1441	ZZR1400 ZX14 ABS Performance Sport	2016-2018	HBK4012	SET UP OEM ANTERIORE	7			2		9	€ 324,00	E
1500	VN1500 B2 - B6 Vulcan C1 - C2 Classic	1988-1996	HBF4283	SET UP OEM ANTERIORE	1					1	€ 28,00	E
1500	VN1500 Classic D1-D2 E1 J1-J2 Drifter	1996-1999	HBC4293	LINEA FRIZIONE					1	1	€ 28,00	E
1500	VN1500 Classic D1-D2 E1 J1-J2 Drifter	1999-2003	HBC4300	LINEA FRIZIONE					1	1	€ 28,00	E
1500	VN1500 D1 - D2 E1 Classic J1 - J2 Drifter	1996-1999	HBK4293	SET UP OEM ANTERIORE	1			1		2	€ 56,00	E
1500	VN1500 E2 Classic G1 - G2 L1 - L2 Nomad	1998-1999	HBK4290	SET UP OEM ANTERIORE	1	1		1		3	€ 84,00	E
1500	VN1500 Vulcan	1996-2003	HBK4300	SET UP OEM ANTERIORE	1	2		1		4	€ 112,00	E
1600	VN1600 Classic	2004-2007	HBK4657	SET UP OEM ANTERIORE	1	1	1	1		4	€ 112,00	E
1600	VN1600 Classic Tourer	2004-2007	HBC4658	LINEA FRIZIONE					1	1	€ 28,00	E
1600	VN1600 Classic Tourer Fi	2004-2007	HBK4658	SET UP OEM ANTERIORE	1	1	1	1		4	€ 112,00	E
1600	VN1600 Mean Streak	2004-2007	HBK4680	SET UP RACE	1	1		1		3	€ 84,00	E
1600	VN1600 Mean Streak	2004-2007	HBK4656	SET UP OEM ANTERIORE	1	2		1		4	€ 112,00	E
1600	VN1600 Meanstreak	2004-2007	HBC4656	LINEA FRIZIONE					1	1	€ 28,00	E
	Z1 Z1A Z1B	1973-1975	HBK4319	SET UP OEM ANTERIORE	1	2				3	€ 84,00	E
	KH100 G5 - G8	1984-1993	HBF4737	SET UP OEM ANTERIORE	1					1	€ 28,00	E
	KH100 G5 - G8	1984-1993	HBK4190	SET UP OEM ANTERIORE	1	1				2	€ 56,00	E
	Z1A (Single Disc)	1973-1975	HBK4316	SET UP OEM ANTERIORE	1	1		1		3	€ 84,00	E
	ZRX400 E1-E2	1994-1995	HBK4462	SET UP OEM ANTERIORE	1	2		1		4	€ 112,00	E
	ZR250 Balius	1991-1996	HBK4581	SET UP OEM ANTERIORE	1			1		2	€ 56,00	E
	H1B - H1F	1972-1975	HBK4727	SET UP OEM ANTERIORE	1	1				2	€ 56,00	E
	KH100 G1 - G4	1980-1983	HBK4728	SET UP OEM ANTERIORE	1	1				2	€ 56,00	E
KEEWAY												
250	Landcruiser 250	2004-2005	HBK4850	SET UP OEM ANTERIORE	1			1		2	€ 56,00	E
KSR												
50	50	2004-2005	HBK4800	SET UP OEM ANTERIORE	1			1		2	€ 56,00	E
110	110	2004-2005	HBK4800	SET UP OEM ANTERIORE	1			1		2	€ 56,00	E
KTM												
50	SX50 - Magura	2012-2020	HBK3019	SET UP OEM ANTERIORE	1			1		2	€ 56,00	E
65	65 SX	2004-2012	HBK5026	SET UP OEM ANTERIORE	1			1		2	€ 56,00	E
65	65 SX	2014-2015	HBF5050	SET UP OEM ANTERIORE	1					1	€ 28,00	E
85	85 Big Wheel	2005-2006	HBK5020	SET UP OEM ANTERIORE	1			1		2	€ 56,00	E
85	85 SX	2003	HBK5027	SET UP OEM ANTERIORE	1			1		2	€ 56,00	E
85	85 SX	2004-2008	HBF5025	SET UP OEM ANTERIORE	1					1	€ 28,00	E
85	85 SX	2013-2015	HBK5041	SET UP OEM ANTERIORE	1			1		2	€ 56,00	E
125	125 Duke	2011-2012	HBF5030	SET UP OEM ANTERIORE	1					1	€ 28,00	E
125	125 EXC	2000-2005	HBK5012	SET UP OEM ANTERIORE	1			1		2	€ 56,00	E
125	125 SX	2000-2005	HBK5010	SET UP OEM ANTERIORE	1			1		2	€ 56,00	E
125	125 SX	2000-2008	HBK5029	SET UP OEM ANTERIORE	1			1		2	€ 56,00	E
125	125 SX - SX-F	2009-2015	HBC5000	LINEA FRIZIONE					1	1	€ 28,00	E
125	125 SX - SX-F	2009-2015	HBK5000	SET UP OEM ANTERIORE	1			1		2	€ 56,00	E
125	EXC	2004-2009	HBK5031	SET UP OEM ANTERIORE	1			1		2	€ 56,00	E
125	EXC	2013-2015	HBF5001	SET UP OEM ANTERIORE	1					1	€ 28,00	E
150	150 SX	2000-2008	HBK5029	SET UP OEM ANTERIORE	1			1		2	€ 56,00	E
150	EXC	2004-2009	HBK5031	SET UP OEM ANTERIORE	1			1		2	€ 56,00	E
150	EXC	2013-2015	HBF5001	SET UP OEM ANTERIORE	1					1	€ 28,00	E

CILIND.	MODELLO	ANNI	CODICE	CONFIGURAZIONE	ANT. SUP	ANT. INF	AGG	POST	FRIZ.	TOT. TUBI	PREZZO PUBBLICO IVA ESCL.	FASCIA
200	200 SX	2000-2005	HBK5011	SET UP OEM ANTERIORE	1			1		2	€ 56,00	E
200	200 SX	2000-2008	HBK5029	SET UP OEM ANTERIORE	1			1		2	€ 56,00	E
200	EXC	2004-2009	HBK5031	SET UP OEM ANTERIORE	1			1		2	€ 56,00	E
200	EXC	2013-2015	HBK5001	SET UP OEM ANTERIORE	1					1	€ 28,00	E
250	250 EXC	2000-2005	HBK5013	SET UP OEM ANTERIORE	1			1		2	€ 56,00	E
250	250 EXC Racing	2000-2005	HBK5004	SET UP OEM ANTERIORE	1			1		2	€ 56,00	E
250	250 SX	2000-2005	HBK5007	SET UP OEM ANTERIORE	1			1		2	€ 56,00	E
250	250 SX	2000-2008	HBK5029	SET UP OEM ANTERIORE	1			1		2	€ 56,00	E
250	250 SX - SX-F	2009-2015	HBC5000	LINEA FRIZIONE					1	1	€ 28,00	E
250	250 SX - SX-F	2009-2015	HBK5000	SET UP OEM ANTERIORE	1			1		2	€ 56,00	E
250	250 SX-F	2016	HBC5003	LINEA FRIZIONE					1	1	€ 28,00	E
250	EXC	2004-2009	HBK5031	SET UP OEM ANTERIORE	1			1		2	€ 56,00	E
250	EXC	2013-2015	HBK5001	SET UP OEM ANTERIORE	1					1	€ 28,00	E
250	Freeride 250 & 350	2012-2016	HBC5023	LINEA FRIZIONE					1	1	€ 28,00	E
250	Freeride 250 & 350	2012-2016	HBK5023	SET UP OEM ANTERIORE	1			1		2	€ 56,00	E
250	XC-F250 & XCF-W250	2009-2016	HBC5028	LINEA FRIZIONE					1	1	€ 28,00	E
300	300 EXC	1998-2006	HBK5033	SET UP OEM ANTERIORE	1					1	€ 28,00	E
350	300 SX	2000-2008	HBK5029	SET UP OEM ANTERIORE	1			1		2	€ 56,00	E
350	350 EXC	2007-2011	HBK5037	SET UP OEM ANTERIORE	1					1	€ 28,00	E
350	350 SX - SX-F	2009-2015	HBC5000	LINEA FRIZIONE					1	1	€ 28,00	E
350	350 SX - SX-F	2009-2015	HBK5000	SET UP OEM ANTERIORE	1			1		2	€ 56,00	E
350	350 XCF	2007-2013	HBK5039	SET UP OEM ANTERIORE	1			1		2	€ 56,00	E
350	EXC	2004-2009	HBK5031	SET UP OEM ANTERIORE	1			1		2	€ 56,00	E
350	EXC	2013-2015	HBK5001	SET UP OEM ANTERIORE	1					1	€ 28,00	E
380	380 SX Supermoto	1999-2006	HBK5021	SET UP OEM ANTERIORE	1					1	€ 28,00	E
390	RC 390 ABS	2014-2018	HBK5390	SET UP OEM ANTERIORE	1	1	1	1		4	€ 144,00	E
400	400 EXC Racing	2000-2005	HBK5005	SET UP OEM ANTERIORE	1			1		2	€ 56,00	E
400	400 SX	2000-2008	HBK5029	SET UP OEM ANTERIORE	1			1		2	€ 56,00	E
400	EXC	2004-2009	HBK5031	SET UP OEM ANTERIORE	1			1		2	€ 56,00	E
400	EXC	2013-2015	HBK5001	SET UP OEM ANTERIORE	1					1	€ 28,00	E
450	450 EXC Racing	2000-2005	HBK5006	SET UP OEM ANTERIORE	1			1		2	€ 56,00	E
450	450 EXC SX125	2003-2007	HBC5005	LINEA FRIZIONE					1	1	€ 28,00	E
450	450 SX	2000-2005	HBK5008	SET UP OEM ANTERIORE	1			1		2	€ 56,00	E
450	450 SX	2000-2008	HBK5029	SET UP OEM ANTERIORE	1			1		2	€ 56,00	E
450	450 SX - SX-F	2009-2015	HBC5000	LINEA FRIZIONE					1	1	€ 28,00	E
450	450 SX - SX-F	2009-2015	HBK5000	SET UP OEM ANTERIORE	1			1		2	€ 56,00	E
450	EXC	2004-2009	HBK5031	SET UP OEM ANTERIORE	1			1		2	€ 56,00	E
450	EXC	2013-2015	HBK5001	SET UP OEM ANTERIORE	1					1	€ 28,00	E
450	450 SMR	2012-2014	HBC5044	LINEA FRIZIONE					1	1	€ 28,00	E
450	450 SMR	2012-2014	HBK5044	SET UP OEM ANTERIORE	1			1		2	€ 56,00	E
525	525 EXC	2003-2007	HBC5022	LINEA FRIZIONE					1	1	€ 28,00	E
525	525 EXC	2003-2007	HBK5022	SET UP OEM ANTERIORE	1			1		2	€ 56,00	E
525	525 SX	2003-2006	HBK5009	SET UP OEM ANTERIORE	1			1		2	€ 56,00	E
530	530 SX	2000-2008	HBK5029	SET UP OEM ANTERIORE	1			1		2	€ 56,00	E
530	EXC	2004-2008	HBK5031	SET UP OEM ANTERIORE	1			1		2	€ 56,00	E
530	EXC	2013-2015	HBK5001	SET UP OEM ANTERIORE	1					1	€ 28,00	E
620	620 Duke	1994-1998	HBK5036	SET UP OEM ANTERIORE	1					1	€ 28,00	E
625	625 SMC	2002-2006	HBK5024	SET UP OEM ANTERIORE	1			1		2	€ 56,00	E
640	640 Duke	1995-2003	HBK5019	SET UP OEM ANTERIORE	1			1		2	€ 56,00	E
640	640 Duke	2003-2005	HBK5017	SET UP OEM ANTERIORE	1			1		2	€ 56,00	E
640	640 LC4	2000-2005	HBK5015	SET UP OEM ANTERIORE	1			1		2	€ 56,00	E
640	640 LC4 Adventurer	2000-2005	HBK5016	SET UP SOPRA PARAFANGO ANTERIORE	1	1		1		3	€ 84,00	E
660	660 SMC	2003-2006	HBK5018	SET UP OEM ANTERIORE	1			1		2	€ 56,00	E
690	690 SMC R ABS	2014-2016	HBK5051	SET UP OEM ANTERIORE	2			2		4	€ 144,00	E
690	690 Duke ABS	2015-2017	HBK5045	SET UP OEM ANTERIORE	1	1	1	1		4	€ 144,00	E

CILIND.	MODELLO	ANNI	CODICE	CONFIGURAZIONE	ANT. SUP	ANT. INF	AGG	POST	FRIZ.	TOT. TUBI	PREZZO PUBBLICO IVA ESCL.	FASCIA
690	690 SMC	2008-2010	HBK5028	SET UP OEM ANTERIORE	1			1		2	€ 56,00	E
790	790 Duke ABS	2018-2019	HBK5046	SET UP OEM ANTERIORE	4			2		6	€ 216,00	E
950	950 Adventurer	2000-2005	HBK5002	SET UP SOPRA PARAFANGO ANTERIORE	1	1		1		3	€ 84,00	E
990	990 Adventurer	2008-2009	HBK5032	SET UP OEM ANTERIORE	1	1	1			3	€ 84,00	E
990	990 Duke	2000-2005	HBK5014	SET UP OEM ANTERIORE	1			1		2	€ 56,00	E
990	990 R Super Duke	2011-2012	HBK5043	SET UP RACE	1	1				2	€ 56,00	E
990	990 SMR / SMT	2009-2011	HBK5038	SET UP RACE	1	1		1		3	€ 84,00	E
990	990 SMR / SMT	2009-2011	HBK5042	SET UP OEM ANTERIORE	1	2	1	1		5	€ 140,00	E
990	990 Super Duke	2004-2006	HBC5035	LINEA FRIZIONE					1	1	€ 28,00	E
990	990 Super Duke	2004-2006	HBK5035	SET UP OEM ANTERIORE	1	1		1		3	€ 84,00	E
990	990 Super Duke	2007-2010	HBK5034	SET UP RACE	1	1		1		3	€ 84,00	E
1190	RC8 / R	2009-2011	HBC5040	LINEA FRIZIONE					1	1	€ 28,00	E
1190	RC8 / R	2009-2011	HBK5040	SET UP RACE	1	1		1		3	€ 84,00	E
KYMCO												
125	Agility 125		HBF5452	SET UP OEM ANTERIORE	1					1	€ 28,00	E
125	People 125	2004-2005	HBF5450	SET UP OEM ANTERIORE	1					1	€ 28,00	E
250	Quad : 250R	2005	HBK5451	SET UP OEM ANTERIORE	1	1	1	1		4	€ 112,00	E
	Quad : Quadrunner		HBK5453	SET UP OEM ANTERIORE	1	2		1		4	€ 112,00	E
LAMBRETTA												
	Disc Brake Model Upgrade		HBF5475	SET UP OEM ANTERIORE	1					1	€ 28,00	E
LAVERDA												
500	500 Montjuic	1979-1983	HBK5508	SET UP OEM ANTERIORE	1	2		1		4	€ 112,00	E
500	500 Sport	1983-1984	HBK5513	SET UP OEM ANTERIORE	1	2		1		4	€ 112,00	E
500	500 Standard	1983-1984	HBK5515	SET UP OEM ANTERIORE	1	2		1		4	€ 112,00	E
650	650 Sport	1993-1997	HBK5558	SET UP OEM ANTERIORE	1	1		1		3	€ 84,00	E
750	750 Café Racer	2000-2001	HBK5522	SET UP OEM ANTERIORE	1	2		1		4	€ 112,00	E
750	750 Formula	1997-2002	HBK5518	SET UP OEM ANTERIORE	1	2		1		4	€ 112,00	E
750	750 S Strike	1998-2001	HBK5531	SET UP OEM ANTERIORE	1	2		1		4	€ 112,00	E
750	750 S Super Sport	2000-2001	HBK5532	SET UP OEM ANTERIORE	1	2		1		4	€ 112,00	E
750	750 SS	1997-2002	HBK5517	SET UP OEM ANTERIORE	1	2		1		4	€ 112,00	E
1000	RGA RGS 1000	1981-1986	HBC5543	LINEA FRIZIONE					1	1	€ 28,00	E
1000	RGA RGS 1000	1981-1986	HBK5543	SET UP OEM ANTERIORE	1	2		1		4	€ 112,00	E
1000	RGS 1000 Corsa	1984-1986	HBC5546	LINEA FRIZIONE					1	1	€ 28,00	E
1000	RGS 1000 Corsa	1984-1986	HBK5546	SET UP OEM ANTERIORE	1	2		1		4	€ 112,00	E
1000	RGS 1000 Executive	1983-1984	HBK5549	SET UP OEM ANTERIORE	1	2		1		4	€ 112,00	E
1000	SFC 1000 Sports	1985-1989	HBK5551	SET UP OEM ANTERIORE	1	2		1		4	€ 112,00	E
1200	1200 Sports	1978-1982	HBK5500	SET UP OEM ANTERIORE	1	2		1		4	€ 112,00	E
1200	1200 TS	1980-1982	HBK5505	SET UP OEM ANTERIORE	1	2		1		4	€ 112,00	E
1200	Formula Mirage 1200	1982	HBK5557	SET UP OEM ANTERIORE	1	2		1		4	€ 112,00	E
1200	Mirage 1200	1978-1979	HBC5542	LINEA FRIZIONE					1	1	€ 28,00	E
1200	Mirage 1200	1978-1979	HBK5542	SET UP OEM ANTERIORE	1	2		1		4	€ 112,00	E
	Jota 120 / 180	1978-1982	HBC5534	LINEA FRIZIONE					1	1	€ 28,00	E
	Jota 120	1978-1982	HBK5534	SET UP OEM ANTERIORE	1	2		1		4	€ 112,00	E
	Jota 180	1978-1982	HBK5536	SET UP OEM ANTERIORE	1	2		1		4	€ 112,00	E
	SFC	1976	HBK5556	SET UP OEM ANTERIORE	1	2		1		4	€ 112,00	E
LEXMOTO												
125	Venom EFI	2016	HBK7500	SET UP OEM ANTERIORE	1	1		1		3	€ 84,00	E
LML												
125	125	2016	HBF2901	SET UP OEM ANTERIORE	1					1	€ 28,00	E
150	150	2016	HBF2901	SET UP OEM ANTERIORE	1					1	€ 28,00	E
200	200	2016	HBF2901	SET UP OEM ANTERIORE	1					1	€ 28,00	E
MAICO												
	Moto Cross	1985	HBF5700	SET UP OEM ANTERIORE	1					1	€ 28,00	E
	Moto Cross	1986	HBF5701	SET UP OEM ANTERIORE	1					1	€ 28,00	E

CILIND.	MODELLO	ANNI	CODICE	CONFIGURAZIONE	ANT. SUP	ANT. INF	AGG	POST	FRIZ.	TOT. TUBI	PREZZO PUBBLICO IVA ESCL.	FASCIA
MONTESA												
315	315R Trials	2001-2004	HBC8600	LINEA FRIZIONE					1	1	€ 28,00	E
315	315R Trials	2001-2004	HBK8600	SET UP OEM ANTERIORE	1			1		2	€ 56,00	E
MOTO GUZZI												
350	V35 (1977) & V50 MK II	1979-1983	HBK5833	SET UP OEM ANTERIORE	1	1		1		3	€ 84,00	E
350	V35 MK II - MK III	1984-1988	HBK5825	SET UP OEM ANTERIORE	1	1	1	1		4	€ 112,00	E
500	V50 MK III	1984-1986	HBK5838	SET UP OEM ANTERIORE	1	1	1	1		4	€ 112,00	E
500	V50 Monza MK I - MK II	1981-1983	HBK5841	SET UP OEM ANTERIORE	1	1		1		3	€ 84,00	E
500	V50 Monza MK III	1984-1986	HBK5842	SET UP OEM ANTERIORE	1	1		1		3	€ 84,00	E
650	V65 Lario	1985-1988	HBK5844	SET UP OEM ANTERIORE	1	1	1	1		4	€ 112,00	E
650	V65 SP	1985	HBK5852	SET UP OEM ANTERIORE	1	1	1	1		4	€ 112,00	E
650	V65 TT	1985-1988	HBK5848	SET UP OEM ANTERIORE	1	1		1		3	€ 84,00	E
750	750 S	1975	HBK5861	SET UP OEM ANTERIORE	1	1		1		3	€ 84,00	E
750	750 S3	1976	HBK5800	SET UP OEM ANTERIORE	1	1	1	1		4	€ 112,00	E
750	750 Targa	1990-1994	HBK5849	SET UP OEM ANTERIORE	1	1	1			3	€ 84,00	E
850	850 Le Mans MK II - MK III	1979-1985	HBK5815	SET UP OEM ANTERIORE	1	1	1	1		4	€ 112,00	E
850	850 Le Mans MK I	1978-1979	HBK5814	SET UP OEM ANTERIORE	1	1	1	1		4	€ 112,00	E
850	850 T3 ALL Models	1976-1980	HBK5801	SET UP OEM ANTERIORE	1	2	1	1		5	€ 140,00	E
850	850 T4	1980-1983	HBK5803	SET UP OEM ANTERIORE	1	1	1	1		4	€ 112,00	E
850	850 T5	1983-1988	HBK5807	SET UP OEM ANTERIORE	1	1	1	1		4	€ 112,00	E
1000	1000 (ie Daytona RS)	1992-2000	HBK5855	SET UP OEM ANTERIORE	1	1		1		3	€ 84,00	E
1000	1000 (ie Daytona)	1992-2000	HBK5856	SET UP OEM ANTERIORE	1	1		1		3	€ 84,00	E
1000	1000 Le Mans MK IV - MK V	1985-1994	HBK5817	SET UP OEM ANTERIORE	1	1	1	1		4	€ 112,00	E
1000	1000 Mille GT	1971	HBK5818	SET UP OEM ANTERIORE	1	1				2	€ 56,00	E
1000	1000 Mille GT	1988-1991	HBK5860	SET UP OEM ANTERIORE	1	1	1	1		4	€ 112,00	E
1000	1000 Spada MK I - MK II	1980-1988	HBK5820	SET UP OEM ANTERIORE	1	1	1	1		4	€ 112,00	E
1000	1000 Spada MK III	1989-1995	HBK5859	SET UP OEM ANTERIORE	1	1	1	1		4	€ 112,00	E
1000	Mistral SP 1000	1982	HBK5819	SET UP OEM ANTERIORE	1	1	1	1		4	€ 112,00	E
1000	SP1000 NT	1981	HBK5851	SET UP OEM ANTERIORE	1	1	1	1		4	€ 112,00	E
1100	1100 Sport (Carb)	1994-1996	HBK5853	SET UP OEM ANTERIORE	1	1		1		3	€ 84,00	E
1100	1100 Sport (Injection)	1996-1999	HBK5854	SET UP OEM ANTERIORE	1	1		1		3	€ 84,00	E
1100	California III	1988-1993	HBK5850	SET UP OEM ANTERIORE	1	1	1	1		4	€ 112,00	E
	Breva	2003-2008	HBK5858	SET UP RACE	1	1		1		3	€ 84,00	E
	Breva	2003-2008	HBK5857	SET UP OEM ANTERIORE	1	1	1	1		4	€ 112,00	E
MOTO MORINI												
350	3,5	1979	HBK5877	SET UP OEM ANTERIORE	1	2				3	€ 84,00	E
500	501 Camel Sahara	1989	HBK5878	SET UP OEM ANTERIORE	1			1		2	€ 56,00	E
1200	Corsaro	2010	HBC5875	LINEA FRIZIONE					1	1	€ 28,00	E
1200	Corsaro	2010	HBK5876	SET UP RACE	1	1		1		3	€ 84,00	E
1200	Corsaro	2010	HBK5875	SET UP OEM ANTERIORE	1	1	1	1		4	€ 112,00	E
MV AGUSTA												
500	Monza	1979	HBK5900	SET UP OEM ANTERIORE	1	2		1		4	€ 112,00	E
750	Brutale	2000-2005	HBK5903	SET UP OEM ANTERIORE	3					3	€ 84,00	E
750	F4 S F4 S-1 F4 SPR F4 SPR Senna	2000-2005	HBC5901	LINEA FRIZIONE					1	1	€ 28,00	E
750	F4 S F4 S-1 F4 SPR F4 SPR Senna	2000-2005	HBK5902	SET UP OEM ANTERIORE	1					1	€ 28,00	E
750	F4 S F4 S-1 F4 SPR F4 SPR Senna	2000-2005	HBK5901	SET UP RACE	1	1		1		3	€ 84,00	E
MZ												
660	Mastiff / Baghira 660cc	1998-2007	HBK9990	SET UP OEM ANTERIORE	1			1		2	€ 56,00	E
NORTON												
750	Roadster 750	1972	HBK6019	SET UP OEM ANTERIORE	1					1	€ 28,00	E
750	Commando 750		HBK6002	SET UP OEM ANTERIORE	1					1	€ 28,00	E
850	Commando 850 MKIII	1975	HBK6003	SET UP OEM ANTERIORE	1	1		1		3	€ 84,00	E

CILIND.	MODELLO	ANNI	CODICE	CONFIGURAZIONE	ANT. SUP	ANT. INF	AGG	POST	FRIZ.	TOT. TUBI	PREZZO PUBBLICO IVA ESCL.	FASCIA
850	Commando 850 MKIII	1976	HBK6004	SET UP OEM ANTERIORE	1	1				2	€ 56,00	E
	Commando	1973	HBK6001	SET UP OEM ANTERIORE	1					1	€ 28,00	E
	Commando MKIIA	1973	HBK6006	SET UP OEM ANTERIORE	1					1	€ 28,00	E
	Commando MKIIA	1974	HBK6007	SET UP OEM ANTERIORE	1					1	€ 28,00	E
	Commando MKIIA - US Model	1974	HBK6012	SET UP OEM ANTERIORE	1					1	€ 28,00	E
	Beta TR 34	1987	HBK6000	SET UP OEM ANTERIORE	1			1		2	€ 56,00	E
	Commando MKII	1976	HBK6005	SET UP OEM ANTERIORE	1	1				2	€ 56,00	E
	Commando MKIII	1975-1978	HBK6008	SET UP OEM ANTERIORE	1	1		1		3	€ 84,00	E
	Commando Roadster	1972	HBK6009	SET UP OEM ANTERIORE	1	1				2	€ 56,00	E
	Commando Rotary		HBK6010	SET UP OEM ANTERIORE	1	2				3	€ 84,00	E
	F1 / F1 Sport / F1 JPS Racing	1988-1993	HBK6011	SET UP OEM ANTERIORE	1	1		1		3	€ 84,00	E
	Commando MKIII Interstate	1975-1978	HBK6020	SET UP OEM ANTERIORE	1	1		1		3	€ 84,00	E
PEUGEOT												
50	Elyseo 50	2000-2007	HBK6517	SET UP OEM ANTERIORE	1					1	€ 28,00	E
100	Elyseo 100	2000-2007	HBK6518	SET UP OEM ANTERIORE	1					1	€ 28,00	E
125	Elyseo 125	2000-2007	HBK6519	SET UP OEM ANTERIORE	1					1	€ 28,00	E
150	Elyseo 150	2000-2007	HBK6516	SET UP OEM ANTERIORE	1			1		2	€ 56,00	E
500	Speedfight 1 50cc	1997-2007	HBK6500	SET UP OEM ANTERIORE	1			1		2	€ 56,00	E
500	Speedfight 2 50cc	2001-2007	HBK6515	SET UP OEM ANTERIORE	1			1		2	€ 56,00	E
PIAGGIO												
50	Fly	2005-2009	HBK6731	SET UP OEM ANTERIORE	1					1	€ 28,00	E
50	NRG Extreme	1997-2002	HBK6725	SET UP OEM ANTERIORE	1			1		2	€ 56,00	E
50	Zip	1997-2007	HBK6726	SET UP OEM ANTERIORE	1					1	€ 28,00	E
	T5	1998-2002	HBK6727	SET UP OEM ANTERIORE	1					1	€ 28,00	E
125	Vespa ET 4 125	1996-2007	HBK6730	SET UP OEM ANTERIORE	1					1	€ 28,00	E
125	Vespa PX	1996-2007	HBK6728	SET UP OEM ANTERIORE	1					1	€ 28,00	E
500	B500		HBK6729	SET UP OEM ANTERIORE	1					1	€ 28,00	E
QUASAR												
	Quasar	1977-1983	HBK6740	SET UP OEM ANTERIORE	1	2		1		4	€ 112,00	E
ROYAL ENFIELD												
350	Bullet	2011-2014	HBK6751	SET UP OEM ANTERIORE	1					1	€ 28,00	E
350	Machismo 350	2000-2005	HBK1280	SET UP OEM ANTERIORE	1					1	€ 28,00	E
500	Classic 500 Efi	2011-2014	HBK6752	SET UP OEM ANTERIORE	1					1	€ 28,00	E
500	Electra	2011-2014	HBK6753	SET UP OEM ANTERIORE	1					1	€ 28,00	E
500	Electra 500 Efi	2011-2014	HBK6757	SET UP OEM ANTERIORE	1					1	€ 28,00	E
500	Electra X	2004-2008	HBK6750	SET UP OEM ANTERIORE	1					1	€ 28,00	E
500	Bullet 500 Efi	2011-2014	HBK6758	SET UP OEM ANTERIORE	1					1	€ 28,00	E
535	Continental GT 535	2013-2014	HBK6754	SET UP OEM ANTERIORE	1			1		2	€ 56,00	E
Sachs												
125	125 Madman	2008-2011	HBK6756	SET UP OEM ANTERIORE	1			1		2	€ 56,00	E
125	XTC125	2000-2008	HBK6755	SET UP OEM ANTERIORE	1			1		2	€ 56,00	E
SAUBER												
500	GP500 Front Line Kit 2 Line	2001-2002	HBK6800	SET UP RACE	1	1				2	€ 56,00	E
500	GP500 Front Line Kit 3 Line	2001-2002	HBK6801	SET UP OEM ANTERIORE	1	1	1			3	€ 84,00	E
SCOMADI												
250	TL250S	2009-2010	HBK6850	SET UP OEM ANTERIORE	1			1		2	€ 56,00	E
SHERCO												
	80 / 125 / 200 / 250 / 290 / 320	1999-2010	HBK6860	SET UP OEM ANTERIORE	1					1	€ 28,00	E
	2.5i / 300i Enduro	2012	HBC6862	LINEA FRIZIONE					1	1	€ 28,00	E
	2.5i / 5.1i / 5.5i Enduro	2012	HBK6861	SET UP OEM ANTERIORE	1			1		2	€ 56,00	E
SUZUKI												

CILIND.	MODELLO	ANNI	CODICE	CONFIGURAZIONE	ANT. SUP	ANT. INF	AGG	POST	FRIZ.	TOT. TUBI	PREZZO PUBBLICO IVA ESCL.	FASCIA
50	AP50	1996-2002	HBF7664	SET UP OEM ANTERIORE	1					1	€ 28,00	E
50	AY50 Katana	1997-2003	HBF7003	SET UP OEM ANTERIORE				1		1	€ 28,00	E
50	TR50 Street Magic	1998-2000	HBF7013	SET UP OEM ANTERIORE	1					1	€ 28,00	E
50	ZR50 SKE - SKX	1983-1985	HBF7595	SET UP OEM ANTERIORE	1					1	€ 28,00	E
50	ZR50 SLKX Custom	1981-1982	HBF7601	SET UP OEM ANTERIORE	1					1	€ 28,00	E
80	RM80	1986-2003	HBK7623	SET UP OEM ANTERIORE	1			1		2	€ 56,00	E
80	RM80	2004-2005	HBK7686	SET UP OEM ANTERIORE	1			1		2	€ 56,00	E
85	RM85	2010	HBK7833	SET UP OEM ANTERIORE	1			1		2	€ 56,00	E
85	XN85 Turbo	1983-1986	HBK7594	SET UP OEM ANTERIORE	1	2	2	1		6	€ 168,00	E
125	125 FU	1993	HBK7001	SET UP OEM ANTERIORE	1			1		2	€ 56,00	E
125	Address 125	2008	HBF7762	SET UP OEM ANTERIORE	1					1	€ 28,00	E
125	DR125 SD - SE	1983-1985	HBF7007	SET UP OEM ANTERIORE	1					1	€ 28,00	E
125	DR125 SF - SJ Raider	1985-1994	HBF7009	SET UP OEM ANTERIORE	1					1	€ 28,00	E
125	DR125SM	2008-2012	HBK7760	SET UP OEM ANTERIORE	1			1		2	€ 56,00	E
125	GN125	1998	HBF7770	SET UP OEM ANTERIORE	1					1	€ 28,00	E
125	GP125 D	1983-1989	HBF7051	SET UP OEM ANTERIORE	1					1	€ 28,00	E
125	GP125 N (Re Intro 79-82 Mod)	1985-1986	HBF7058	SET UP OEM ANTERIORE	1					1	€ 28,00	E
125	GP125 X - D	1982-1989	HBF7060	SET UP OEM ANTERIORE	1					1	€ 28,00	E
125	GS125 ESZ - ESX	1982-2000	HBF7068	SET UP OEM ANTERIORE	1					1	€ 28,00	E
125	GS125 S Katana	1980	HBK7077	SET UP OEM ANTERIORE	1		1			2	€ 56,00	E
125	GT125 L - B	1974-1977	HBF7393	SET UP OEM ANTERIORE	1					1	€ 28,00	E
125	RG125 F Gamma	1991-1995	HBF7000	SET UP OEM ANTERIORE	1					1	€ 28,00	E
125	RG125 FUN - FUR Gamma	1991-1995	HBF7435	SET UP OEM ANTERIORE	1					1	€ 28,00	E
125	RG125 UG - UJ Gamma	1986-1991	HBF7440	SET UP OEM ANTERIORE	1					1	€ 28,00	E
125	RM125	1988-1998	HBK7712	SET UP OEM ANTERIORE	1			1		2	€ 56,00	E
125	RM125	1999-2006	HBK7685	SET UP OEM ANTERIORE	1			1		2	€ 56,00	E
125	RM125	2007-2010	HBK7831	SET UP OEM ANTERIORE	1			1		2	€ 56,00	E
125	TS125 RK - RR	1990-1996	HBK7516	SET UP OEM ANTERIORE	1			1		2	€ 56,00	E
125	TS125 XF - XJ	1985-1989	HBF7523	SET UP OEM ANTERIORE	1					1	€ 28,00	E
125	Van Van RV125	2003-2015	HBF7744	SET UP OEM ANTERIORE	1					1	€ 28,00	E
125	VL125 Intruder	2005-2008	HBF7749	SET UP OEM ANTERIORE	1					1	€ 28,00	E
125	GSX-R125 ABS L7 - L8	2017-2018	HBK7021	SET UP OEM ANTERIORE	1	1	1	1		4	€ 144,00	E
125	GSX-S125 ABS L7 - L9	2017-2019	HBK7025	SET UP OEM ANTERIORE	2			2		4	€ 112,00	E
250	250 ET - ET	1980	HBF7002	SET UP OEM ANTERIORE	1					1	€ 28,00	E
250	GN250	1987-1997	HBF7014	SET UP OEM ANTERIORE	1					1	€ 28,00	E
250	GS250 TT - TX	1980-1981	HBF7078	SET UP OEM ANTERIORE	1					1	€ 28,00	E
250	GSX250 ET - EX	1980-1981	HBF7223	SET UP OEM ANTERIORE	1					1	€ 28,00	E
250	GSX250 EZ Katana	1982	HBK7225	SET UP OEM ANTERIORE	1		1			2	€ 56,00	E
250	GT250 A	1976	HBF7395	SET UP OEM ANTERIORE	1					1	€ 28,00	E
250	GT250 B	1977	HBF7396	SET UP OEM ANTERIORE	1					1	€ 28,00	E
250	GT250 C	1978	HBF7397	SET UP OEM ANTERIORE	1					1	€ 28,00	E
250	GT250 EN - EX X7	1979-1982	HBF7398	SET UP OEM ANTERIORE	1					1	€ 28,00	E
250	GT250 K	1973	HBF7399	SET UP OEM ANTERIORE	1					1	€ 28,00	E
250	GT250 L	1974	HBF7400	SET UP OEM ANTERIORE	1					1	€ 28,00	E
250	Quad : LTZ250	2004-2006	HBK7689	SET UP OEM ANTERIORE	1	1		1		3	€ 84,00	E
250	RG250 F Gamma	1983	HBF7004	SET UP OEM ANTERIORE	1					1	€ 28,00	E
250	RG250 F Gamma Mk II	1984-1989	HBK7005	SET UP OEM ANTERIORE	1	2	2	1		6	€ 168,00	E
250	RG250 FCH Gamma	1987-1989	HBK7452	SET UP OEM ANTERIORE	1	2		1		4	€ 112,00	E
250	RG250 FG - FH Gamma	1985-1989	HBK7455	SET UP OEM ANTERIORE	1	2		1		4	€ 112,00	E
250	RG250 WD Mk I Gamma	1983	HBK7459	SET UP OEM ANTERIORE	1	2		1		4	€ 112,00	E
250	RG250 WE Mk II Gamma	1984	HBK7460	SET UP OEM ANTERIORE	1	2		1		4	€ 112,00	E
250	RGV250 K - L	1989-1990	HBK7791	SET UP RACE	1	1		1		3	€ 84,00	E
250	RGV250 K - L	1989-1990	HBK7466	SET UP OEM ANTERIORE	1	2		1		4	€ 112,00	E
250	RGV250 M - N	1991-1992	HBK7469	SET UP RACE	1	1		1		3	€ 84,00	E
250	RGV250 M - N	1991-1992	HBK7468	SET UP OEM ANTERIORE	1	2		1		4	€ 112,00	E

CILIND.	MODELLO	ANNI	CODICE	CONFIGURAZIONE	ANT. SUP	ANT. INF	AGG	POST	FRIZ.	TOT. TUBI	PREZZO PUBBLICO IVA ESCL.	FASCIA
250	RGV250 P - R	1993-1994	HBK7475	SET UP RACE	1	1		1		3	€ 84,00	E
250	RGV250 P - R	1993-1994	HBK7474	SET UP OEM ANTERIORE	1	2		1		4	€ 112,00	E
250	RGV250 SP VJ23 Import	1996-1998	HBK7690	SET UP SOPRA PARAFANGO ANTERIORE	1	1		1		3	€ 84,00	E
250	RGV250 VJ21	1988	HBK7840	SET UP OEM ANTERIORE	1	1	1	1		4	€ 112,00	E
250	RM250	1976-1998	HBK7817	SET UP OEM ANTERIORE	1			1		2	€ 56,00	E
250	RM250	1999-2006	HBK7687	SET UP OEM ANTERIORE	1			1		2	€ 56,00	E
250	RM250	2007-2009	HBK7672	SET UP OEM ANTERIORE	1					1	€ 28,00	E
250	RMX250	1999-2005	HBK7696	SET UP OEM ANTERIORE	1			1		2	€ 56,00	E
250	RMZ250	2004-2006	HBK7688	SET UP OEM ANTERIORE	1			1		2	€ 56,00	E
250	RMZ250	2007-2013	HBK7043	SET UP OEM ANTERIORE	1			1		2	€ 56,00	E
250	TS250 XG - XJ	1985-1989	HBK7531	SET UP OEM ANTERIORE	1					1	€ 28,00	E
250	TU250X	1997-2000	HBK7792	SET UP OEM ANTERIORE	1					1	€ 28,00	E
350	DR350 SES - SEX	1995-1999	HBK7024	SET UP OEM ANTERIORE	1			1		2	€ 56,00	E
350	DR350 SL - SR	1990-1994	HBK7019	SET UP OEM ANTERIORE	1			1		2	€ 56,00	E
380	GT380 J	1972	HBK7401	SET UP OEM ANTERIORE	1					1	€ 28,00	E
380	GT380 K	1973	HBK7402	SET UP OEM ANTERIORE	1					1	€ 28,00	E
380	GT380 L	1974	HBK7403	SET UP OEM ANTERIORE	1					1	€ 28,00	E
380	GT380 M	1975	HBK7404	SET UP OEM ANTERIORE	1					1	€ 28,00	E
400	AN400 Burgman	2004-2008	HBK7737	SET UP OEM ANTERIORE	1	1	1	1		4	€ 112,00	E
400	DR-Z400 S	1999-2006	HBK7632	SET UP OEM ANTERIORE	1			1		2	€ 56,00	E
400	DR-Z400 SM	2004-2005	HBK7692	SET UP OEM ANTERIORE	1			1		2	€ 56,00	E
400	DR-Z400 SM	2006-2008	HBK7738	SET UP OEM ANTERIORE	1			1		2	€ 56,00	E
400	GN400 TT	1980-1982	HBK7042	SET UP OEM ANTERIORE	1					1	€ 28,00	E
400	GS400 Single Disc	1977-1980	HBK7082	SET UP OEM ANTERIORE	1	1				2	€ 56,00	E
400	GS425 Single Disc	1977-1980	HBK7083	SET UP OEM ANTERIORE	1	1				2	€ 56,00	E
400	GSF400 M - R Bandit Single Disc	1991-1995	HBK7168	SET UP OEM ANTERIORE	1	1		1		3	€ 84,00	E
400	GSF400 M - R Bandit Twin Disc	1991-1995	HBK7751	SET UP OEM ANTERIORE	1	1	1	1		4	€ 112,00	E
400	GSF400 V - Y Bandit	1996-2003	HBK7681	SET UP OEM ANTERIORE	1	2		1		4	€ 112,00	E
400	GSX400 D	1986	HBK7229	SET UP OEM ANTERIORE	1	2	1			4	€ 112,00	E
400	GSX400 E	1986	HBK7230	SET UP OEM ANTERIORE	1		1			2	€ 56,00	E
400	GSX400 EX - EZ	1980-1985	HBK7231	SET UP OEM ANTERIORE	1		1			2	€ 56,00	E
400	GSX400 FX Non Antidive	1981	HBK7237	SET UP OEM ANTERIORE	1	2		1		4	€ 112,00	E
400	GSX400 FZ - FD Anti Dive	1982-1986	HBK7240	SET UP OEM ANTERIORE	1	2	1			4	€ 112,00	E
400	GSX400 SSN Katana	1992-1993	HBK7684	SET UP RACE	1	1		1		3	€ 84,00	E
400	GSX400 SSN Katana	1992-1993	HBK7683	SET UP OEM ANTERIORE	1	2		1		4	€ 112,00	E
400	GSX400 TX Custom	1981-1985	HBK7243	SET UP OEM ANTERIORE	1					1	€ 28,00	E
400	GSXR400 GK71B	1986-1987	HBK7807	SET UP OEM ANTERIORE	1	2	2	1		6	€ 168,00	E
400	GSXR400 GK71F	1986-1987	HBK7804	SET UP RACE	1	1				2	€ 56,00	E
400	GSXR400 GK71F	1986-1987	HBK7803	SET UP OEM ANTERIORE	1	2				3	€ 84,00	E
400	GSXR400 RRSP Import	1987-1989	HBK7350	SET UP OEM ANTERIORE	1	2		1		4	€ 112,00	E
400	GSXR400R GK76A	1990-1992	HBK7342	SET UP RACE	1	1		1		3	€ 84,00	E
400	GSXR400R GK76A	1990-1992	HBK7341	SET UP OEM ANTERIORE	1	1	1	1		4	€ 112,00	E
400	Quad : LTZ400	2003-2006	HBK7665	SET UP OEM ANTERIORE	1	1		1		3	€ 84,00	E
400	Quad : LTZ400 - ATV A Arms	2006	HBK7736	SET UP OEM ANTERIORE	1	2		1		4	€ 112,00	E
400	RG400 Gamma	1985-1986	HBK7462	SET UP OEM ANTERIORE	1	2				3	€ 84,00	E
450	GS450 EG - EJ	1985-1989	HBK7084	SET UP OEM ANTERIORE	1	1				2	€ 56,00	E
450	Quad : LTR450	2006	HBK7734	SET UP OEM ANTERIORE	1	1	1	1		4	€ 112,00	E
450	Quad : LTR450 - ATV A Arms	2006	HBK7734	SET UP OEM ANTERIORE	1	1	1	1		4	€ 112,00	E
450	Quad : LTR450 QR Spec Only	2006	HBK7734	SET UP RACE	1	1		1		3	€ 84,00	E
450	RMZ450	2005-2008	HBK7735	SET UP OEM ANTERIORE	1			1		2	€ 56,00	E
450	RMZ450	2009-2013	HBK7828	SET UP OEM ANTERIORE	1			1		2	€ 56,00	E
500	GS500	2004-2008	HBK7675	SET UP OEM ANTERIORE	1			1		2	€ 56,00	E

CILIND.	MODELLO	ANNI	CODICE	CONFIGURAZIONE	ANT. SUP	ANT. INF	AGG	POST	FRIZ.	TOT. TUBI	PREZZO PUBBLICO IVA ESCL.	FASCIA
500	GS500 EK - ER	1989-1994	HBK7090	SET UP OEM ANTERIORE	1			1		2	€ 56,00	E
500	GS500 ES - K2	1995-2002	HBK7097	SET UP OEM ANTERIORE	1			1		2	€ 56,00	E
500	GS500F	2003-2008	HBK7676	SET UP OEM ANTERIORE	1			1		2	€ 56,00	E
500	GT500 A	1975-1978	HBK7405	SET UP OEM ANTERIORE	1					1	€ 28,00	E
500	RG500 G - CH Gamma Sports	1985-1989	HBK7461	SET UP OEM ANTERIORE	1	2		1		4	€ 112,00	E
550	GS550 D	1977-1978	HBK7808	SET UP OEM ANTERIORE	1	2				3	€ 84,00	E
550	GS550 EN	1978-1979	HBK7780	SET UP OEM ANTERIORE	1	2		1		4	€ 112,00	E
550	GS550 ET - EX	1980-1981	HBK7781	SET UP OEM ANTERIORE	1	2		1		4	€ 112,00	E
550	GS550 EZ Antidive	1982-1985	HBK7107	SET UP OEM ANTERIORE	1	2	2	1		6	€ 168,00	E
550	GS550 LT - LX	1980-1982	HBK7111	SET UP OEM ANTERIORE	1	2		1		4	€ 112,00	E
550	GS550 MX Katana	1981-1984	HBK7715	SET UP OEM ANTERIORE	1	2				3	€ 84,00	E
550	GSX550 ESD / EE / ESE / EFE	1983-1984	HBK7248	SET UP OEM ANTERIORE	1	2	2	1		6	€ 168,00	E
550	GSX550 ESE (Non Antidive)	1986	HBK7705	SET UP RACE	1	1		1		3	€ 84,00	E
550	GSX550 ESE (Non Antidive)	1986	HBK7704	SET UP OEM ANTERIORE	1	2		1		4	€ 112,00	E
550	GT550 A	1976	HBK7835	SET UP OEM ANTERIORE	1					1	€ 28,00	E
550	GT550 K	1973	HBK7750	SET UP OEM ANTERIORE	1	1				2	€ 56,00	E
550	GT550 L-M	1973	HBK7750	SET UP OEM ANTERIORE	1	1				2	€ 56,00	E
600	DR600 RG Paris Dakar	1986-1987	HBK7030	SET UP OEM ANTERIORE	1					1	€ 28,00	E
600	DR600 SF - RG Raider	1984-1987	HBK7032	SET UP OEM ANTERIORE	1					1	€ 28,00	E
600	GSF600 S - T - X Bandit	1995-1999	HBK7175	SET UP RACE	1	1		1		3	€ 84,00	E
600	GSF600 S - T - X Bandit	1995-1999	HBK7174	SET UP OEM ANTERIORE	1	2		1		4	€ 112,00	E
600	GSF600 Y-K4 Bandit	2000-2004	HBK7189	SET UP RACE	1	1		1		3	€ 84,00	E
600	GSF600 Y-K4 Bandit	2000-2004	HBK7188	SET UP OEM ANTERIORE	1	2		1		4	€ 112,00	E
600	GSR600	2006-2010	HBK7726	SET UP RACE	1	1		1		3	€ 84,00	E
600	GSR600	2006-2010	HBK7727	SET UP SOPRA PARAFANGO ANTERIORE	1	1		1		3	€ 84,00	E
600	GSX600 F Katana	2004-2005	HBK7701	SET UP RACE	1	1		1		3	€ 84,00	E
600	GSX600 F Katana	2004-2005	HBK7700	SET UP OEM ANTERIORE	1	2		1		4	€ 112,00	E
600	GSX600 FJ - FV	1988-1997	HBK7607	SET UP RACE	1	1		1		3	€ 84,00	E
600	GSX600 FJ - FV	1988-1997	HBK7259	SET UP OEM ANTERIORE	1	2		1		4	€ 112,00	E
600	GSX600 FW - K4	1998-2004	HBK7616	SET UP RACE	1	1		1		3	€ 84,00	E
600	GSX600 FW - K4	1998-2004	HBK7268	SET UP OEM ANTERIORE	1	2		1		4	€ 112,00	E
600	GSXR600 K1 - K3	2001-2003	HBK7363	SET UP RACE	1	1		1		3	€ 84,00	E
600	GSXR600 K1 - K3	2001-2003	HBK7364	SET UP SOPRA PARAFANGO ANTERIORE	1	1		1		3	€ 84,00	E
600	GSXR600 K4 - K5	2004-2005	HBK7679	SET UP RACE	1	1		1		3	€ 84,00	E
600	GSXR600 K4 - K5	2004-2005	HBK7680	SET UP SOPRA PARAFANGO ANTERIORE	1	1		1		3	€ 84,00	E
600	GSXR600 K6 - K7	2006-2007	HBK7728	SET UP RACE	1	1		1		3	€ 84,00	E
600	GSXR600 K6 - K7	2006-2007	HBK7729	SET UP SOPRA PARAFANGO ANTERIORE	1	1		1		3	€ 84,00	E
600	GSXR600 K8	2008	HBK7771	SET UP RACE	1	1		1		3	€ 84,00	E
600	GSXR600 K8	2008	HBK7797	SET UP SOPRA PARAFANGO ANTERIORE	1	1		1		3	€ 84,00	E
600	GSXR600 K9 - L0	2009-2010	HBK7800	SET UP SOPRA PARAFANGO ANTERIORE	1	1		1		3	€ 84,00	E
600	GSXR600 K9 - L0	2009-2010	HBK7801	SET UP RACE	1	1		1		3	€ 84,00	E
600	GSXR600 L1-L8	2011-2018	HBK7820	SET UP SOPRA PARAFANGO ANTERIORE	1	1		1		3	€ 84,00	E
600	GSXR600 L1-L8	2011-2018	HBK7821	SET UP RACE	1	1		1		3	€ 84,00	E
600	GSXR600 V - W SRAD	1997-1998	HBK7353	SET UP RACE	1	1		1		3	€ 84,00	E
600	GSXR600 V - W SRAD	1997-1998	HBK7354	SET UP SOPRA PARAFANGO ANTERIORE	1	1		1		3	€ 84,00	E
600	GSXR600 X - Y SRAD	1999-2000	HBK7359	SET UP RACE	1	1		1		3	€ 84,00	E
600	GSXR600 X - Y SRAD	1999-2000	HBK7360	SET UP SOPRA PARAFANGO ANTERIORE	1	1		1		3	€ 84,00	E

CILIND.	MODELLO	ANNI	CODICE	CONFIGURAZIONE	ANT. SUP	ANT. INF	AGG	POST	FRIZ.	TOT. TUBI	PREZZO PUBBLICO IVA ESCL.	FASCIA
600	RF600 RP - RV	1993-1997	HBK7720	SET UP RACE	1	1		1		3	€ 84,00	E
600	RF600 RP - RV	1993-1997	HBK7422	SET UP OEM ANTERIORE	1	2		1		4	€ 112,00	E
600	VS600 GLS - GLT Intruder	1995-1997	HBK7555	SET UP OEM ANTERIORE	1					1	€ 28,00	E
650	Burgman 650 Executive	2006-2008	HBK7748	SET UP OEM ANTERIORE	1	1	1	1		4	€ 112,00	E
650	DL650 V-Strom	2003-2008	HBK7673	SET UP RACE	1	1		1		3	€ 84,00	E
650	DL650 V-Strom	2003-2008	HBK7699	SET UP SOPRA PARAFANGO ANTERIORE	1	1		1		3	€ 84,00	E
650	DL650 V-Strom ABS K7- L1	2007-2011	HBK7847	SET UP OEM ANTERIORE	6			2		8	€ 288,00	E
650	DL650 V-Strom ABS L2 - L6	2012-2016	HBK7845	SET UP OEM ANTERIORE	3			2		5	€ 180,00	E
650	DR650	1996-2003	HBK7836	SET UP OEM ANTERIORE	1			1		2	€ 56,00	E
650	DR650R SE	1991-2014	HBK7656	SET UP OEM ANTERIORE	1			1		2	€ 56,00	E
650	GS650 GTX - GTD	1981-1985	HBK7114	SET UP OEM ANTERIORE	1	2		1		4	€ 112,00	E
650	GS650 GX Katana	1981-1984	HBK7120	SET UP OEM ANTERIORE	1	2		1		4	€ 112,00	E
650	GS650 GZ Antidive	1982-1984	HBK7124	SET UP OEM ANTERIORE	1	2	2	1		6	€ 168,00	E
650	GS650G Anti Dive	1981	HBK7841	SET UP OEM ANTERIORE	1	2	2	1		6	€ 168,00	E
650	GSF650 K5 - K8 Bandit Faired	2005-2008	HBK7815	SET UP RACE	1	1		1		3	€ 84,00	E
650	GSF650 K5 - K8 Bandit Faired	2005-2008	HBK7816	SET UP SOPRA PARAFANGO ANTERIORE	1	1		1		3	€ 84,00	E
650	GSF650 K5 - K8 Bandit Naked	2005-2008	HBK7709	SET UP SOPRA PARAFANGO ANTERIORE	1	1		1		3	€ 84,00	E
650	GSF650 K5 - K8 Bandit Naked	2005-2008	HBK7711	SET UP RACE	1	1		1		3	€ 84,00	E
650	GSF650 SA Bandit	2007-2012	HBC7709	LINEA FRIZIONE					1	1	€ 28,00	E
650	GSF650S ABS Bandit Front	2005-2006	HBK7708	SET UP OEM ANTERIORE	7					7	€ 252,00	E
650	GSF650S ABS Bandit Rear	2005-2006	HBK7708	SET UP OEM ANTERIORE			1	1		2	€ 56,00	E
650	GSF650S ABS Bandit Front	2007-2012	HBK7834	SET UP OEM ANTERIORE	1	1	1	1		4	€ 144,00	E
650	GSX650F ABS K8-L5 7x Line Kit	2008-2015	HBK7714	SET UP OEM ANTERIORE	7					7	€ 252,00	E
650	GSX650F K8-L2 Non ABS	2008-2012	HBK7765	SET UP RACE	1	1		1		3	€ 84,00	E
650	GSX650F K8-L5 Non ABS	2008-2015	HBK7764	SET UP SOPRA PARAFANGO ANTERIORE	1	1		1		3	€ 84,00	E
650	LS650 FG - PJ - PT Savage	1987-1998	HBK7408	SET UP OEM ANTERIORE	1					1	€ 28,00	E
650	SFV650 Gladius K9-L4	2009-2014	HBK7812	SET UP RACE	1	1		1		3	€ 84,00	E
650	SFV650 Gladius K9-L4	2009-2014	HBK7813	SET UP SOPRA PARAFANGO ANTERIORE	1	1		1		3	€ 84,00	E
650	SV650 (Naked)	2004	HBK7809	SET UP OEM ANTERIORE	1	1	1	1		4	€ 112,00	E
650	SV650 N K3 - K8	2003-2008	HBK7694	SET UP RACE	1	1		1		3	€ 84,00	E
650	SV650 N K3 - K8	2003-2008	HBK7811	SET UP SOPRA PARAFANGO ANTERIORE	1	1		1		3	€ 84,00	E
650	SV650 N X - K2	1999-2002	HBK7485	SET UP RACE	1	1		1		3	€ 84,00	E
650	SV650 N X - K2	1999-2002	HBK7484	SET UP OEM ANTERIORE	1	2		1		4	€ 112,00	E
650	SV650 N ABS K7 - L5	2007-2015	HBK7098	SET UP OEM ANTERIORE	3			2		5	€ 140,00	E
650	SV650 SK3 - SK5 Faired Model	2003-2005	HBK7646	SET UP RACE	1	1		1		3	€ 84,00	E
650	SV650 SK6 - SK8 Faired Model	2006-2008	HBK7810	SET UP RACE	1	1		1		3	€ 84,00	E
650	SV650 SK6 - SK8 Faired Model	2006-2008	HBK7758	SET UP OEM ANTERIORE	1	1	1	1		4	€ 112,00	E
650	SV650 SK9 - SK13 Faired Model	2009-2013	HBK7838	SET UP RACE	1	1		1		3	€ 84,00	E
650	SV650 SK9 - SK13 Faired Model	2009-2013	HBK7839	SET UP SOPRA PARAFANGO ANTERIORE	1	1		1		3	€ 84,00	E
650	SV650 SX - SK2 Faired Model	1999-2002	HBK7490	SET UP RACE	1	1		1		3	€ 84,00	E
650	SV650 SX - SK2 Faired Model	1999-2002	HBK7491	SET UP OEM ANTERIORE	1	2		1		4	€ 112,00	E
650	XF650 V - Y Freewind	1997-2001	HBK7589	SET UP OEM ANTERIORE	1			1		2	€ 56,00	E
650	SV650A ABS L6-L8	2016-2018	HBK7017	SET UP OEM ANTERIORE	3			2		5	€ 180,00	E
650	GSF650S ABS Bandit Rear	2007-2012	HBR7834	SET UP OEM ANTERIORE			1	1		2	€ 72,00	E

CILIND.	MODELLO	ANNI	CODICE	CONFIGURAZIONE	ANT. SUP	ANT. INF	AGG	POST	FRIZ.	TOT. TUBI	PREZZO PUBBLICO IVA ESCL.	FASCIA
650	SV650 X L8-L9 ABS	2018-2019	HBK7022	SET UP OEM ANTERIORE	3			2		5	€ 180,00	E
750	DR750 S J - K Desert Express / Dr Big	1988-1989	HBK7037	SET UP OEM ANTERIORE	1			1		2	€ 56,00	E
750	GS750	1977-1978	HBK7127	SET UP OEM ANTERIORE	1	1				2	€ 56,00	E
750	GS750 B	1977	HBK7739	SET UP OEM ANTERIORE	1			1		2	€ 56,00	E
750	GS750 D/DN/EN	1979	HBK7128	SET UP OEM ANTERIORE	1	2		1		4	€ 112,00	E
750	GS750 DB	1977	HBK7129	SET UP OEM ANTERIORE	1	2		1		4	€ 112,00	E
750	GS750 LX US Import		HBK7130	SET UP OEM ANTERIORE	1	2				3	€ 84,00	E
750	GSR750 ABS L2-L6	2012-2016	HBK7843	SET UP OEM ANTERIORE	4			1		5	€ 180,00	E
750	GSR750 L1-L6	2011-2016	HBK7826	SET UP RACE	1	1		1		3	€ 84,00	E
750	GSR750 L1-L6	2011-2016	HBK7827	SET UP SOPRA PARAFANGO ANTERIORE	1	1		1		3	€ 84,00	E
750	GSX750 EE / EF / ES Antidive	1984-1989	HBK7273	SET UP OEM ANTERIORE	1	2	2	1		6	€ 168,00	E
750	GSX750 ESD Antidive	1983	HBK7278	SET UP OEM ANTERIORE	1	2	2	1		6	€ 168,00	E
750	GSX750 ET - EX	1980-1981	HBK7785	SET UP RACE	1	1		1		3	€ 84,00	E
750	GSX750 ET - EX	1980-1981	HBK7784	SET UP OEM ANTERIORE	1	2		1		4	€ 112,00	E
750	GSX750 FK - FV	1989-1997	HBK7787	SET UP RACE	1	1		1		3	€ 84,00	E
750	GSX750 FK - FV	1989-1997	HBK7287	SET UP OEM ANTERIORE	1	2		1		4	€ 112,00	E
750	GSX750 FW - FK5	1998-2005	HBK7300	SET UP RACE	1	1		1		3	€ 84,00	E
750	GSX750 FW - FK5	1998-2005	HBK7299	SET UP OEM ANTERIORE	1	2		1		4	€ 112,00	E
750	GSX750 SE Katana (Non Flip Up)	1984	HBK7814	SET UP OEM ANTERIORE	1	2	2	1		6	€ 168,00	E
750	GSX750 SF Katana	1985-1986	HBC7285	LINEA FRIZIONE					1	1	€ 28,00	E
750	GSX750 SF Katana	1985-1986	HBK7285	SET UP OEM ANTERIORE	1	2		1		4	€ 112,00	E
750	GSX750 W - K1 Retro	1997-2002	HBK7309	SET UP OEM ANTERIORE	1	2		1		4	€ 112,00	E
750	GSXR750 / 3 Japanese Import	1991	HBC7380	LINEA FRIZIONE					1	1	€ 28,00	E
750	GSXR750 / 3 Japanese Import	1991	HBK7380	SET UP OEM ANTERIORE	1	2		1		4	€ 112,00	E
750	GSXR750 F - H	1985-1987	HBC7365	LINEA FRIZIONE					1	1	€ 28,00	E
750	GSXR750 F - H	1985-1987	HBK7719	SET UP RACE	1	1		1		3	€ 84,00	E
750	GSXR750 F - H	1985-1987	HBK7365	SET UP OEM ANTERIORE	1	2		1		4	€ 112,00	E
750	GSXR750 J - M	1988-1991	HBC7368	LINEA FRIZIONE					1	1	€ 28,00	E
750	GSXR750 J Slingshot	1988	HBK7717	SET UP RACE	1	1		1		3	€ 84,00	E
750	GSXR750 J Slingshot	1988	HBK7368	SET UP OEM ANTERIORE	1	2		1		4	€ 112,00	E
750	GSXR750 K Slingshot	1989	HBK7718	SET UP RACE	1	1		1		3	€ 84,00	E
750	GSXR750 K Slingshot	1989	HBK7369	SET UP OEM ANTERIORE	1	2		1		4	€ 112,00	E
750	GSXR750 K4 - K5	2004-2005	HBK7670	SET UP RACE	1	1		1		3	€ 84,00	E
750	GSXR750 K4 - K5	2004-2005	HBK7671	SET UP SOPRA PARAFANGO ANTERIORE	1	1		1		3	€ 84,00	E
750	GSXR750 K6 - K7	2006-2007	HBK7730	SET UP RACE	1	1		1		3	€ 84,00	E
750	GSXR750 K6 - K7	2006-2007	HBK7731	SET UP SOPRA PARAFANGO ANTERIORE	1	1		1		3	€ 84,00	E
750	GSXR750 K8	2008	HBK7768	SET UP SOPRA PARAFANGO ANTERIORE	1	1		1		3	€ 84,00	E
750	GSXR750 K8	2008	HBK7769	SET UP RACE	1	1		1		3	€ 84,00	E
750	GSXR750 K9 - L0	2009-2010	HBK7798	SET UP SOPRA PARAFANGO ANTERIORE	1	1		1		3	€ 84,00	E
750	GSXR750 K9 - L0	2009-2010	HBK7799	SET UP RACE	1	1		1		3	€ 84,00	E
750	GSXR750 L Slingshot	1990	HBK7371	SET UP RACE	1	1		1		3	€ 84,00	E
750	GSXR750 L Slingshot	1990	HBK7370	SET UP OEM ANTERIORE	1	2		1		4	€ 112,00	E
750	GSXR750 L1 - L8	2011-2018	HBK7818	SET UP SOPRA PARAFANGO ANTERIORE	1	1		1		3	€ 84,00	E
750	GSXR750 L1 - L8	2011-2018	HBK7819	SET UP RACE	1	1		1		3	€ 84,00	E
750	GSXR750 M Slingshot	1991	HBK7790	SET UP RACE	1	1		1		3	€ 84,00	E
750	GSXR750 M Slingshot	1991	HBK7372	SET UP OEM ANTERIORE	1	2		1		4	€ 112,00	E
750	GSXR750 T - W SRAD	1996-1998	HBK7381	SET UP RACE	1	1		1		3	€ 84,00	E
750	GSXR750 T - W SRAD	1996-1998	HBK7382	SET UP SOPRA PARAFANGO ANTERIORE	1	1		1		3	€ 84,00	E

CILIND.	MODELLO	ANNI	CODICE	CONFIGURAZIONE	ANT. SUP	ANT. INF	AGG	POST	FRIZ.	TOT. TUBI	PREZZO PUBBLICO IVA ESCL.	FASCIA
750	GSXR750 WN - WP	1992-1993	HBK7373	SET UP OEM ANTERIORE	1	2		1		4	€ 112,00	E
750	GSXR750 WR - WS	1994-1995	HBK7378	SET UP SOPRA PARAFANGO ANTERIORE	1	1		1		3	€ 84,00	E
750	GSXR750 WR - WS	1994-1995	HBK7379	SET UP RACE	1	1		1		3	€ 84,00	E
750	GSXR750 WT	1996	HBK7682	SET UP SOPRA PARAFANGO ANTERIORE	1	1		1		3	€ 84,00	E
750	GSXR750 X SRAD	1999	HBK7387	SET UP RACE	1	1		1		3	€ 84,00	E
750	GSXR750 X SRAD	1999	HBK7388	SET UP SOPRA PARAFANGO ANTERIORE	1	1		1		3	€ 84,00	E
750	GSXR750 Y - K3	2000-2003	HBK7391	SET UP RACE	1	1		1		3	€ 84,00	E
750	GSXR750 Y - K3	2000-2003	HBK7392	SET UP SOPRA PARAFANGO ANTERIORE	1	1		1		3	€ 84,00	E
750	GSX-S750 ABS	2017-2018	HBK7016	SET UP OEM ANTERIORE	1	1	1	1		4	€ 144,00	E
750	GT750 (K L M A B) Replaces the metal lines from the Front Calipers	1973-1977	HBK7406	SET UP OEM ANTERIORE	1	2		1		4	€ 112,00	E
750	GT750 (K L M A B) Retains the metal lines from the Front Calipers	1973-1977	HBK7407	SET UP OEM ANTERIORE	1	2		1		4	€ 112,00	E
750	VS750 GLPG - GLPM Intruder	1985-1991	HBC7559	LINEA FRIZIONE					1	1	€ 28,00	E
750	VS750 GLPG - GLPM Intruder	1985-1991	HBF7559	SET UP OEM ANTERIORE	1					1	€ 28,00	E
800	C800 Intruder	2001-2015	HBF7746	SET UP OEM ANTERIORE	1					1	€ 28,00	E
800	DR800 S L Dr Big	1990	HBK7041	SET UP OEM ANTERIORE	1			1		2	€ 56,00	E
800	DR800 S M - V Dr Big	1991-2000	HBK7039	SET UP OEM ANTERIORE	1			1		2	€ 56,00	E
800	M50 (M800) Boulevard / Intruder	2011	HBK7822	SET UP OEM ANTERIORE	1			1		2	€ 56,00	E
800	M800 Intruder	2006-2008	HBF7745	SET UP OEM ANTERIORE	1					1	€ 28,00	E
800	M800 Intruder VZ800	2006-2008	HBF7585	SET UP OEM ANTERIORE	1					1	€ 28,00	E
800	VS800 GL - GLV Volusia	1991-1997	HBF7716	SET UP OEM ANTERIORE	1					1	€ 28,00	E
800	VS800 GL - GLV Volusia	1997-2004	HBF7802	SET UP OEM ANTERIORE	1					1	€ 28,00	E
800	VX800 GLM - GLV Roadster	1991-1997	HBK7574	SET UP OEM ANTERIORE	1			1		2	€ 56,00	E
800	VX800 GLM - GLV Roadster US / Euro Import	1991-1996	HBK7566	SET UP OEM ANTERIORE	1			1		2	€ 56,00	E
800	VZ800 Intruder	2007-2009	HBF7794	SET UP OEM ANTERIORE	1					1	€ 28,00	E
800	VZ800 Marauder	1997-1998	HBF7584	SET UP OEM ANTERIORE	1					1	€ 28,00	E
850	GS850 GN - GT	1979-1980	HBK7131	SET UP OEM ANTERIORE	1	2		1		4	€ 112,00	E
850	GS850 GX - GG	1981-1988	HBK7132	SET UP OEM ANTERIORE	1	2		1		4	€ 112,00	E
900	RF900 RR - RW	1994-1998	HBC7428	LINEA FRIZIONE					1	1	€ 28,00	E
900	RF900 RR - RW	1994-1998	HBK7721	SET UP RACE	1	1		1		3	€ 84,00	E
900	RF900 RR - RW	1994-1998	HBK7428	SET UP OEM ANTERIORE	1	2		1		4	€ 112,00	E
1000	DL1000 V-Strom	2002-2008	HBC7663	LINEA FRIZIONE					1	1	€ 28,00	E
1000	DL1000 V-Strom	2002-2008	HBK7695	SET UP RACE	1	1		1		3	€ 84,00	E
1000	DL1000 V-Strom	2002-2008	HBK7663	SET UP OEM ANTERIORE	1	1	1	1		4	€ 112,00	E
1000	DL1000 V-Strom ABS	2014-2015	HBC7008	LINEA FRIZIONE					1	1	€ 36,00	E
1000	DL1000 V-Strom ABS	2014-2015	HBK7008	SET UP OEM ANTERIORE	4			1		5	€ 180,00	E
1000	GS1000 E GS1000ET	1980-1984	HBK7062	SET UP OEM ANTERIORE	1	2		1		4	€ 112,00	E
1000	GS1000 EN	1979	HBK7775	SET UP OEM ANTERIORE	1	2		1		4	€ 112,00	E
1000	GS1000 ET - GT	1980-1984	HBK7776	SET UP OEM ANTERIORE	1	2		1		4	€ 112,00	E
1000	GS1000 G	1980-1983	HBK7779	SET UP OEM ANTERIORE	1	2		1		4	€ 112,00	E
1000	GS1000 L US Import	1980	HBK7777	SET UP OEM ANTERIORE	1	2		1		4	€ 112,00	E
1000	GS1000 S	1979	HBK7778	SET UP OEM ANTERIORE	1	2		1		4	€ 112,00	E
1000	GSX1000 SZ - SD Katana	1981-1984	HBK7200	SET UP OEM ANTERIORE	1	2	2	1		6	€ 168,00	E
1000	GSXR1000 K1 - K2	2001-2002	HBK7314	SET UP RACE	1	1		1		3	€ 84,00	E
1000	GSXR1000 K1 - K2	2001-2002	HBK7315	SET UP SOPRA PARAFANGO ANTERIORE	1	1		1		3	€ 84,00	E
1000	GSXR1000 K3 - K4	2003-2004	HBK7630	SET UP SOPRA PARAFANGO ANTERIORE	1	1		1		3	€ 84,00	E
1000	GSXR1000 K3 - K4	2003-2004	HBK7631	SET UP RACE	1	1		1		3	€ 84,00	E

CILIND.	MODELLO	ANNI	CODICE	CONFIGURAZIONE	ANT. SUP	ANT. INF	AGG	POST	FRIZ.	TOT. TUBI	PREZZO PUBBLICO IVA ESCL.	FASCIA
1000	GSXR1000 K5 - K6	2005-2006	HBK7706	SET UP SOPRA PARAFANGO ANTERIORE	1	1		1		3	€ 84,00	E
1000	GSXR1000 K5 - K6	2005-2006	HBK7707	SET UP RACE	1	1		1		3	€ 84,00	E
1000	GSXR1000 K7	2007	HBK7752	SET UP SOPRA PARAFANGO ANTERIORE	1	1		1		3	€ 84,00	E
1000	GSXR1000 K7	2007	HBK7753	SET UP RACE	1	1		1		3	€ 84,00	E
1000	GSXR1000 K7 - K8	2007-2008	HBC7752	LINEA FRIZIONE					1	1	€ 28,00	E
1000	GSXR1000 K8	2008	HBK7772	SET UP SOPRA PARAFANGO ANTERIORE	1	1		1		3	€ 84,00	E
1000	GSXR1000 K8	2008	HBK7773	SET UP RACE	1	1		1		3	€ 84,00	E
1000	GSXR1000 K9 - L1	2009-2011	HBK7795	SET UP RACE	1	1		1		3	€ 84,00	E
1000	GSXR1000 K9 - L1	2009-2011	HBK7796	SET UP SOPRA PARAFANGO ANTERIORE	1	1		1		3	€ 84,00	E
1000	GSXR1000 L2 - L6	2012-2016	HBK7829	SET UP SOPRA PARAFANGO ANTERIORE	1	1		1		3	€ 84,00	E
1000	GSXR1000 L2 - L6	2012-2016	HBK7830	SET UP RACE	1	1		1		3	€ 84,00	E
1000	GSXR1000 L5 - L6 ABS	2015-2016	HBK7006	SET UP OEM ANTERIORE	4			1		5	€ 180,00	E
1000	GSXR1000 L7 ABS	2017-2019	HBK7015	SET UP OEM ANTERIORE	4			2		6	€ 216,00	E
1000	GSXR1000 L7 no ABS	2017-2018	HBFKK005	SET UP RACE	1	1		1		3	€ 84,00	E
1000	GSX-S1000F & GSX-S1000 (Non ABS)	2015-2016	HBK7011	SET UP RACE	1	1		1		3	€ 84,00	E
1000	GSX-S1000F & GSX-S1000 (Non ABS)	2015-2016	HBK7010	SET UP OEM ANTERIORE	1	2		1		4	€ 112,00	E
1000	GSX-S1000F & GSX-S1000 ABS	2015-2016	HBK7012	SET UP OEM ANTERIORE	3			2		5	€ 180,00	E
1000	SV1000 N	2003-2006	HBK7637	SET UP SOPRA PARAFANGO ANTERIORE	1	1		1		3	€ 84,00	E
1000	SV1000 N	2003-2006	HBK7638	SET UP RACE	1	1		1		3	€ 84,00	E
1000	SV1000 Top Yoke Conversion	2003-2006	HBK7639	SET UP OEM ANTERIORE	1	1		1		3	€ 84,00	E
1000	SV1000J Top Yoke Conversion	2003	HBC7639	LINEA FRIZIONE					1	1	€ 28,00	E
1000	SV1000S	2003-2007	HBC7666	LINEA FRIZIONE					1	1	€ 28,00	E
1000	SV1000S Faired Model	2003-2006	HBK7666	SET UP RACE	1	1		1		3	€ 84,00	E
1000	SV1000S Faired Model	2003-2006	HBK7667	SET UP SOPRA PARAFANGO ANTERIORE	1	1		1		3	€ 84,00	E
1000	TL1000R W-K2	1998-2002	HBC7496	LINEA FRIZIONE					1	1	€ 28,00	E
1000	TL1000R W-K2	1998-2002	HBK7496	SET UP RACE	1	1		1		3	€ 84,00	E
1000	TL1000R W-K2	1998-2002	HBK7497	SET UP SOPRA PARAFANGO ANTERIORE	1	1		1		3	€ 84,00	E
1000	TL1000S V-K1	1997-2001	HBK7504	SET UP RACE	1	1		1		3	€ 84,00	E
1000	TL1000S V-K1	1997-2001	HBK7505	SET UP SOPRA PARAFANGO ANTERIORE	1	1		1		3	€ 84,00	E
1000	GSXR1000R L7 - L9 ABS	2017-2019	HBK7020	SET UP OEM ANTERIORE	3			3		6	€ 216,00	E
1100	GSX1100 EE - EG	1984-1988	HBK7205	SET UP OEM ANTERIORE	1	2		1		4	€ 112,00	E
1100	GSX1100 ESD	1983-1985	HBK7207	SET UP OEM ANTERIORE	1	2	2	1		6	€ 168,00	E
1100	GSX1100 ET - EX	1980-1981	HBK7210	SET UP OEM ANTERIORE	1	2		1		4	€ 112,00	E
1100	GSX1100 EZ - SZ Katana	1982	HBK7212	SET UP OEM ANTERIORE	1	2	2	1		6	€ 168,00	E
1100	GSX1100 FJ - FR Sports Tourer Power Screen	1988-1994	HBK7213	SET UP OEM ANTERIORE	1	2		1		4	€ 112,00	E
1100	GSX1100 GM - GN	1991-1994	HBK7782	SET UP OEM ANTERIORE	1	1	1	1		4	€ 112,00	E
1100	GSX1100 SD	1983	HBK7783	SET UP OEM ANTERIORE	1	2	2	1		6	€ 168,00	E
1100	GSX1100F	1988-1994	HBC7213	LINEA FRIZIONE					1	1	€ 28,00	E
1100	GSXR1100 G - J	1986-1988	HBC7316	LINEA FRIZIONE					1	1	€ 28,00	E
1100	GSXR1100 G - H	1986-1987	HBK7662	SET UP RACE	1	1		1		3	€ 84,00	E
1100	GSXR1100 G - H	1986-1987	HBK7316	SET UP OEM ANTERIORE	1	2		1		4	€ 112,00	E
1100	GSXR1100 J	1988	HBK7320	SET UP RACE	1	1		1		3	€ 84,00	E
1100	GSXR1100 J	1988	HBK7319	SET UP OEM ANTERIORE	1	2		1		4	€ 112,00	E
1100	GSXR1100 K	1989	HBK7788	SET UP RACE	1	1		1		3	€ 84,00	E
1100	GSXR1100 K	1989	HBK7321	SET UP OEM ANTERIORE	1	2		1		4	€ 112,00	E
1100	GSXR1100 K - N Slingshot	1989-1992	HBC7321	LINEA FRIZIONE					1	1	€ 28,00	E

CILIND.	MODELLO	ANNI	CODICE	CONFIGURAZIONE	ANT. SUP	ANT. INF	AGG	POST	FRIZ.	TOT. TUBI	PREZZO PUBBLICO IVA ESCL.	FASCIA
1100	GSXR1100 L	1990	HBK7323	SET UP RACE	1	1		1		3	€ 84,00	E
1100	GSXR1100 L	1990	HBK7322	SET UP OEM ANTERIORE	1	2		1		4	€ 112,00	E
1100	GSXR1100 M	1991	HBK7825	SET UP RACE	1	1		1		3	€ 84,00	E
1100	GSXR1100 M	1991	HBK7324	SET UP OEM ANTERIORE	1	2		1		4	€ 112,00	E
1100	GSXR1100 N	1992	HBK7789	SET UP RACE	1	1		1		3	€ 84,00	E
1100	GSXR1100 N	1992	HBK7325	SET UP OEM ANTERIORE	1	2		1		4	€ 112,00	E
1100	GSXR1100 WP - WT	1993-1996	HBC7326	LINEA FRIZIONE					1	1	€ 28,00	E
1100	GSXR1100 WP - WT	1993-1996	HBK7326	SET UP RACE	1	1		1		3	€ 84,00	E
1100	GSXR1100 WP - WT	1993-1996	HBK7327	SET UP SOPRA PARAFANGO ANTERIORE	1	1		1		3	€ 84,00	E
1200	GSF1200 K1 - K5 Bandit	2001-2005	HBC7621	LINEA FRIZIONE					1	1	€ 28,00	E
1200	GSF1200 K1 - K5 Bandit	2001-2005	HBK7621	SET UP RACE	1	1		1		3	€ 84,00	E
1200	GSF1200 K1 - K5 Bandit	2001-2005	HBK7622	SET UP OEM ANTERIORE	1	2		1		4	€ 112,00	E
1200	GSF1200 K6 Bandit	2006	HBC7722	LINEA FRIZIONE					1	1	€ 28,00	E
1200	GSF1200 K6 Bandit	2006	HBK7722	SET UP SOPRA PARAFANGO ANTERIORE	1	1		1		3	€ 84,00	E
1200	GSF1200 K6 Bandit	2006	HBK7723	SET UP RACE	1	1		1		3	€ 84,00	E
1200	GSF1200 K6 Bandit ABS	2006	HBK7725	SET UP OEM ANTERIORE	7					7	€ 252,00	E
1200	GSF1200 T - Y Bandit	1996-2000	HBK7145	SET UP RACE	1	1		1		3	€ 84,00	E
1200	GSF1200 T - Y Bandit	1996-2000	HBK7152	SET UP OEM ANTERIORE	1	2		1		4	€ 112,00	E
1200	GSF1200 T-Y Bandit	1996-2000	HBC7145	LINEA FRIZIONE					1	1	€ 28,00	E
1200	GSX1200 Inazuma	1999-2000	HBC7805	LINEA FRIZIONE					1	1	€ 28,00	E
1200	GSX1200 Inazuma	1999-2000	HBK7806	SET UP RACE	1	1		1		3	€ 84,00	E
1200	GSX1200 Inazuma	1999-2000	HBK7805	SET UP OEM ANTERIORE	1	2		1		4	€ 112,00	E
1200	GSF1200 Bandit Cam 4 Line Kit	1996-2005	HBK7142		1	1	1	1		4	€ 112,00	E
1200	GSF1200 Bandit Cam 2 Line Kit	1996-2005	HBK7143		1	1				2	€ 56,00	E
1200	GSF1200 Bandit Cam 3 Line Kit	1996-2005	HBK7144		1	1	1			3	€ 84,00	E
1200	GSF1200 T - Y Bandit	1996-2000	HBK7153	SET UP SOPRA PARAFANGO ANTERIORE	1	1		1		3	€ 84,00	E
1250	GSF1250 K7 - L1 Bandit	2007-2011	HBK7740	SET UP SOPRA PARAFANGO ANTERIORE	1	1		1		3	€ 84,00	E
1250	GSF1250 K7 - L1 Bandit	2007-2011	HBK7741	SET UP RACE	1	1		1		3	€ 84,00	E
1250	GSF1250 SA ABS Bandit	2007-2011	HBC7743	LINEA FRIZIONE					1	1	€ 36,00	E
1250	GSF1250 SA ABS K7 - L1 Bandit	2007-2011	HBK7743	SET UP OEM ANTERIORE	7					7	€ 252,00	E
1250	GSX1250FA L0-L6 ABS	2010-2016	HBC7837	LINEA FRIZIONE					1	1	€ 36,00	E
1250	GSX1250FA L0-L6 ABS	2010-2016	HBK7837	SET UP OEM ANTERIORE	7					7	€ 252,00	E
1250	GSF1250 SA ABS K7 - L1 Bandit Rear (replaces the metal pipes on rear only as well as the rubber ones)	2007-2011	HBR7742	SET UP OEM ANTERIORE			1	1		2	€ 72,00	E
1250	GSF1250 SA ABS K7 - L1 Bandit Standard Rears	2007-2011	HBR7743	SET UP OEM ANTERIORE			1	1		2	€ 72,00	E
1300	GSX1300 B-King	2008-2012	HBC7757	LINEA FRIZIONE					1	1	€ 28,00	E
1300	GSX1300 B-King	2008-2012	HBK7756	SET UP SOPRA PARAFANGO ANTERIORE	1	1		1		3	€ 84,00	E
1300	GSX1300 B-King	2008-2012	HBK7757	SET UP RACE	1	1		1		3	€ 84,00	E
1300	GSX1300R ABS L3- L5 Hayabusa	2013-2018	HBK7786	SET UP OEM ANTERIORE	3			2		5	€ 180,00	E
1300	GSX1300R Hayabusa K8 - L2	2008-2012	HBC7767	LINEA FRIZIONE					1	1	€ 28,00	E
1300	GSX1300R K8 - L4 Hayabusa	2008-2014	HBK7766	SET UP SOPRA PARAFANGO ANTERIORE	1	1		1		3	€ 84,00	E
1300	GSX1300R K8 - L4 Hayabusa	2008-2014	HBK7767	SET UP RACE	1	1		1		3	€ 84,00	E
1300	GSX1300R L3-L8 Hayabusa	2013-2018	HBC7768	LINEA FRIZIONE					1	1	€ 28,00	E
1300	GSX1300R RX - K3 / RZ Hayabusa	1999-2007	HBC7766	LINEA FRIZIONE					1	1	€ 28,00	E

CILIND.	MODELLO	ANNI	CODICE	CONFIGURAZIONE	ANT. SUP	ANT. INF	AGG	POST	FRIZ.	TOT. TUBI	PREZZO PUBBLICO IVA ESCL.	FASCIA
1300	GSX1300R RX - K7 Hayabusa	1999-2007	HBK7336	SET UP OEM ANTERIORE	1	1		1		3	€ 84,00	E
1300	GSX1300R RX - K7 Hayabusa	1999-2007	HBK7604	SET UP RACE	1	1		1		3	€ 84,00	E
1400	GSX1400 K1 - K8	2001-2008	HBC7221	LINEA FRIZIONE					1	1	€ 28,00	E
1400	GSX1400 K1 - K8	2001-2008	HBK7222	SET UP RACE	1	1		1		3	€ 84,00	E
1400	GSX1400 K1 - K8	2001-2008	HBK7221	SET UP OEM ANTERIORE	1	2		1		4	€ 112,00	E
1400	VS1400 GLPH - GLPV Intruder	1987-1999	HBC7537	LINEA FRIZIONE					1	1	€ 28,00	E
1400	VS1400 GLPH - GLPV Intruder	1987-1999	HBK7537	SET UP OEM ANTERIORE	1					1	€ 28,00	E
1400	VS1400 GLPH - GLPV Intruder	1987-1999	HBK7538	SET UP OEM ANTERIORE	1			1		2	€ 56,00	E
1500	M90 Boulevard / Intruder	2011	HBK7823	SET UP OEM ANTERIORE	1	1		1		3	€ 84,00	E
1500	M90 Boulevard / Intruder	2011	HBK7824	SET UP SOPRA PARAFANGO ANTERIORE	1	1		1		3	€ 84,00	E
1500	VL1500 LC Intruder	1998-2004	HBC7713	LINEA FRIZIONE					1	1	€ 28,00	E
1500	VL1500 LC Intruder (Single Front Disc)	1998-2001	HBK7713	SET UP OEM ANTERIORE	1			1		2	€ 56,00	E
1500	VL1500 LC Intruder (Twin Disc)	2002-2004	HBK7710	SET UP OEM ANTERIORE	1	1		1		3	€ 84,00	E
1600	M1600 Boulevard	2004-2005	HBK7698	SET UP OEM ANTERIORE	1	1	1			3	€ 84,00	E
1600	VS1600 Intruder	2004-2005	HBK7697	SET UP OEM ANTERIORE	1					1	€ 28,00	E
1600	VZ1600 Marauder	2004-2005	HBC7677	LINEA FRIZIONE					1	1	€ 28,00	E
1600	VZ1600 Marauder	2004-2005	HBK7678	SET UP RACE	1	1		1		3	€ 84,00	E
1600	VZ1600 Marauder	2004-2005	HBK7677	SET UP OEM ANTERIORE	1	2		1		4	€ 112,00	E
1800	M1800R Intruder	2006-2008	HBK7733	SET UP RACE	1	1		1		3	€ 84,00	E
1800	M1800R Intruder	2006-2008	HBK7755	SET UP OEM ANTERIORE	1	2		1		4	€ 112,00	E
1800	VZR1800 Intruder	2012-2015	HBK7832	SET UP OEM ANTERIORE	1	1	1	1		4	€ 112,00	E
1800	VZR1800 M109R Boulevard	2006-2008	HBK7732	SET UP RACE	1	1		1		3	€ 84,00	E
1800	VZR1800 M109R Boulevard	2006-2008	HBK7755	SET UP OEM ANTERIORE	1	2		1		4	€ 112,00	E
1800	VLR1800 (E2 only) K8-L1	2008-2011	HBK7023	SET UP OEM ANTERIORE	6			4		10	€ 280,00	E
	GP100 X - ED	1981-1991	HBK7045	SET UP OEM ANTERIORE	1					1	€ 28,00	E
	GT185 K - C	1973-1978	HBK7394	SET UP OEM ANTERIORE	1					1	€ 28,00	E
	Volty Import	1997-2000	HBK7793	SET UP OEM ANTERIORE	1					1	€ 28,00	E
	M1800R Intruder	2006-2008	HBK7018	SET UP OEM ANTERIORE	1	2		1		4	€ 112,00	E
	DR650R SEP DO NOT USE - CUSTOMER COMPLAINT REGARDING INCORRECT SPEC	1991-1994	HBK7691	SET UP OEM ANTERIORE	1	1		1		3	€ 84,00	E
	GT550 L-M	1974-1975	HBK7754	SET UP OEM ANTERIORE	1	1				2	€ 56,00	E
	Goose 350	1991-1996	HBK7774	SET UP OEM ANTERIORE	1			1		2	€ 56,00	E
TEMA												
	Motocross / Enduro	2002	HBK7900	SET UP OEM ANTERIORE	1					1	€ 28,00	E
	Motocross Enduro	2002	HBC7950	LINEA FRIZIONE					1	1	€ 28,00	E
TM												
250	250 EN	2003-2008	HBC7976	LINEA FRIZIONE					1	1	€ 28,00	E
	Motocross	2002	HBK7925	SET UP OEM ANTERIORE	1			1		2	€ 56,00	E
	Motorcross	2002	HBC7975	LINEA FRIZIONE					1	1	€ 28,00	E
TRAXX												
110	Sky 110	2010	HBK7950	SET UP OEM ANTERIORE	1					1	€ 28,00	E
125	Fly 125	2010	HBK7952	SET UP OEM ANTERIORE	1			1		2	€ 56,00	E
250	Shark 250	2010	HBK7953	SET UP OEM ANTERIORE	1					1	€ 28,00	E
	Joto 125	2010	HBK7951	SET UP OEM ANTERIORE	1					1	€ 28,00	E
TRIUMPH												
600	Daytona 600	2003-2005	HBK8132	SET UP RACE	1	1		1		3	€ 84,00	E
600	Daytona 600	2003-2005	HBK8164	SET UP SOPRA PARAFANGO ANTERIORE	1	1		1		3	€ 84,00	E

CILIND.	MODELLO	ANNI	CODICE	CONFIGURAZIONE	ANT. SUP	ANT. INF	AGG	POST	FRIZ.	TOT. TUBI	PREZZO PUBBLICO IVA ESCL.	FASCIA
600	Speed Four 600	2002-2005	HBK8144	SET UP SOPRA PARAFANGO ANTERIORE	1	1		1		3	€ 84,00	E
600	Speed Four 600	2002-2005	HBK8145	SET UP RACE	1	1		1		3	€ 84,00	E
600	TT600	2000-2003	HBK8129	SET UP SOPRA PARAFANGO ANTERIORE	1	1		1		3	€ 84,00	E
600	TT600	2000-2003	HBK8130	SET UP RACE	1	1		1		3	€ 84,00	E
675	Daytona 675	2006-2008	HBK8142	SET UP SOPRA PARAFANGO ANTERIORE	1	1		1		3	€ 84,00	E
675	Daytona 675	2006-2008	HBK8143	SET UP RACE	1	1		1		3	€ 84,00	E
675	Daytona 675	2009-2010	HBK8172	SET UP SOPRA PARAFANGO ANTERIORE	1	1		1		3	€ 84,00	E
675	Daytona 675	2009-2010	HBK8173	SET UP RACE	1	1		1		3	€ 84,00	E
675	Daytona 675R	2011-2014	HBK8176	SET UP RACE	1	1		1		3	€ 84,00	E
675	Street Triple 675	2013	HBK8185	SET UP RACE	1	1		1		3	€ 84,00	E
675	Street Triple 675	2013	HBK8186	SET UP SOPRA PARAFANGO ANTERIORE	1	1		1		3	€ 84,00	E
675	Street Triple 675	2007-2012	HBK8151	SET UP SOPRA PARAFANGO ANTERIORE	1	1		1		3	€ 84,00	E
675	Street Triple 675	2007-2012	HBK8152	SET UP RACE	1	1		1		3	€ 84,00	E
675	Street Triple R 675	2010-2011	HBK8179	SET UP SOPRA PARAFANGO ANTERIORE	1	1		1		3	€ 84,00	E
675	Street Triple R 675	2010-2011	HBK8180	SET UP RACE	1	1		1		3	€ 84,00	E
675	Daytona 675R ABS	2013-2017	HBK8027	SET UP OEM ANTERIORE	4			2		6	€ 216,00	E
750	Bonneville 750 Low Bar	1986	HBK8012	SET UP OEM ANTERIORE	1	1		1		3	€ 84,00	E
750	Daytona 750	1992-1993	HBK8181	SET UP OEM ANTERIORE	1	2		1		4	€ 112,00	E
750	Speed Triple 750	1997	HBK8184	SET UP OEM ANTERIORE	1	2		1		4	€ 112,00	E
800	Bonneville T100	2000-2006	HBK8146	SET UP OEM ANTERIORE	1			1		2	€ 56,00	E
800	Tiger 800	2010-2014	HBK8187	SET UP SOPRA PARAFANGO ANTERIORE	1	1		1		3	€ 84,00	E
800	Tiger 800	2010-2014	HBK8188	SET UP RACE	1	1		1		3	€ 84,00	E
800	Tiger 800 XC	2011	HBK8183	SET UP SOPRA PARAFANGO ANTERIORE	1	1		1		3	€ 84,00	E
865	America	2004-2007	HBK8140	SET UP OEM ANTERIORE	1			1		2	€ 56,00	E
865	America	2008-2009	HBK8155	SET UP OEM ANTERIORE	1			1		2	€ 56,00	E
865	Bonneville T100	2007-2010	HBK8158	SET UP OEM ANTERIORE	1			1		2	€ 56,00	E
865	Bonneville T100	2011-2014	HBK8200	SET UP OEM ANTERIORE	1			1		2	€ 56,00	E
865	Bonneville T100 SE Mag Wheel	2010-2014	HBK8001	SET UP OEM ANTERIORE	1			1		2	€ 56,00	E
865	Speedmaster	2000-2002	HBK8139	SET UP OEM ANTERIORE	1			1		2	€ 56,00	E
865	Speedmaster	2003-2010	HBK8162	SET UP OEM ANTERIORE	1	1		1		3	€ 84,00	E
865	Speedmaster	2003-2010	HBK8163	SET UP RACE	1	1		1		3	€ 84,00	E
900	Adventurer Thunderbird 900	1995-2003	HBK8169	SET UP OEM ANTERIORE	1			1		2	€ 56,00	E
900	Adventurer Thunderbird Sport 900	1995-2003	HBK8085	SET UP OEM ANTERIORE	1			1		2	€ 56,00	E
900	Bonneville 900 Scrambler	2004-2007	HBK8150	SET UP OEM ANTERIORE	1			1		2	€ 56,00	E
900	Daytona 900	1991-1996	HBC8013	LINEA FRIZIONE					1	1	€ 28,00	E
900	Daytona 900	1992-1997	HBK8013	SET UP OEM ANTERIORE	1	2		1		4	€ 112,00	E
900	Legend TT	1998-2001	HBK8136	SET UP OEM ANTERIORE	1			1		2	€ 56,00	E
900	Scrambler 900	2008	HBK8157	SET UP OEM ANTERIORE	1			1		2	€ 56,00	E
900	Speed Triple	1994-1996	HBC8015	LINEA FRIZIONE					1	1	€ 28,00	E
900	Speed Triple	1994-1996	HBK8015	SET UP OEM ANTERIORE	1	2		1		4	€ 112,00	E
900	Speed Triple T509	1997-2007	HBK8081	SET UP SOPRA PARAFANGO ANTERIORE	1	1		1		3	€ 84,00	E
900	Speed Triple T509	1997-2007	HBK8082	SET UP RACE	1	1		1		3	€ 84,00	E
900	Sprint 900	1993-1997	HBK8056	SET UP OEM ANTERIORE	1	2		1		4	€ 112,00	E
900	Sprint Executive	1998-2003	HBK8141	SET UP RACE	1	1		1		3	€ 84,00	E
900	Sprint Executive	1998-2003	HBK8165	SET UP OEM ANTERIORE	1	2		1		4	€ 112,00	E
900	Sprint RS	1999-2004	HBK8133	SET UP SOPRA PARAFANGO ANTERIORE	1	1		1		3	€ 84,00	E

CILIND.	MODELLO	ANNI	CODICE	CONFIGURAZIONE	ANT. SUP	ANT. INF	AGG	POST	FRIZ.	TOT. TUBI	PREZZO PUBBLICO IVA ESCL.	FASCIA
900	Sprint RS	1999-2004	HBK8134	SET UP RACE	1	1		1		3	€ 84,00	E
900	Sprint Sport	1998-2003	HBK8091	SET UP SOPRA PARAFANGO ANTERIORE	1	1		1		3	€ 84,00	E
900	Sprint ST	1998-2004	HBK8092	SET UP SOPRA PARAFANGO ANTERIORE	1	1		1		3	€ 84,00	E
900	Sprint ST	1998-2004	HBK8135	SET UP RACE	1	1		1		3	€ 84,00	E
900	Thrupton 900	2008	HBK8156	SET UP OEM ANTERIORE	1			1		2	€ 56,00	E
900	Thunderbird 900	1995-2000	HBC8131	LINEA FRIZIONE					1	1	€ 28,00	E
900	Thunderbird 900	1995-2003	HBK8000	SET UP OEM ANTERIORE	1			1		2	€ 56,00	E
900	Thunderbird Sport 900	1997-2004	HBK8003	SET UP OEM ANTERIORE	1	2		1		4	€ 112,00	E
900	Tiger 900	1993-2000	HBK8025	SET UP RACE	1	1		1		3	€ 84,00	E
900	Tiger 900	1993-2000	HBK8024	SET UP OEM ANTERIORE	1	2		1		4	€ 112,00	E
900	Trident 900	1991	HBK8041	SET UP RACE	1	1		1		3	€ 84,00	E
900	Trident 900	1991	HBK8040	SET UP OEM ANTERIORE	1	2		1		4	€ 112,00	E
900	Trident 900	1992-1998	HBC8040	LINEA FRIZIONE					1	1	€ 28,00	E
900	Trident 900	1992-1998	HBK8043	SET UP RACE	1	1		1		3	€ 84,00	E
900	Trident 900	1992-1998	HBK8042	SET UP OEM ANTERIORE	1	2		1		4	€ 112,00	E
900	Trident Sprint Sports	1996	HBC8060	LINEA FRIZIONE					1	1	€ 28,00	E
900	Trident Sprint Sports	1996	HBK8060	SET UP OEM ANTERIORE	1	2		1		4	€ 112,00	E
900	Trophy 900	1991-2002	HBC8063	LINEA FRIZIONE					1	1	€ 28,00	E
900	Trophy 900	1991-2002	HBK8064	SET UP RACE	1	1		1		3	€ 84,00	E
900	Trophy 900	1991-2002	HBK8174	SET UP SOPRA PARAFANGO ANTERIORE	1	1		1		3	€ 84,00	E
900	Trophy 900	1991-2002	HBK8063	SET UP OEM ANTERIORE	1	2		1		4	€ 112,00	E
900	Street Twin ABS	2016-2018	HBK8009	SET UP OEM ANTERIORE	3			2		5	€ 180,00	E
900	Bonneville Thrupton	2004-2010	HBK8149	SET UP OEM ANTERIORE	1			1		2	€ 56,00	E
955	Daytona 955i	2001-2004	HBK8006	SET UP RACE	1	1		1		3	€ 84,00	E
955	Daytona 955i	2001-2004	HBK8007	SET UP SOPRA PARAFANGO ANTERIORE	1	1		1		3	€ 84,00	E
955	Daytona 955i	2005-2007	HBK8148	SET UP RACE	1	1		1		3	€ 84,00	E
955	Daytona T595 (955i Daytona)	1997-2000	HBK8004	SET UP RACE	1	1		1		3	€ 84,00	E
955	Daytona T595 (955i Daytona)	1997-2000	HBK8005	SET UP SOPRA PARAFANGO ANTERIORE	1	1		1		3	€ 84,00	E
955	Speed Triple 955i	2002-2003	HBK8168	SET UP SOPRA PARAFANGO ANTERIORE	1	1		1		3	€ 84,00	E
955	Speed Triple 955i	2002-2003	HBK8175	SET UP RACE	1	1		1		3	€ 84,00	E
955	Tiger 955	2000-2003	HBK8127	SET UP RACE	1	1		1		3	€ 84,00	E
955	Tiger 955	2000-2003	HBK8128	SET UP SOPRA PARAFANGO ANTERIORE	1	1		1		3	€ 84,00	E
955	Tiger 955i	2004-2008	HBK8166	SET UP RACE	1	1		1		3	€ 84,00	E
955	Tiger 955i	2004-2008	HBK8167	SET UP SOPRA PARAFANGO ANTERIORE	1	1		1		3	€ 84,00	E
1000	Daytona 1000	1992-1993	HBK8182	SET UP OEM ANTERIORE	1	2		1		4	€ 112,00	E
1050	Speed Triple 1050	2005-2010	HBK8171	SET UP RACE	1	1		1		3	€ 84,00	E
1050	Speed Triple 1050	2005-2010	HBK8159	SET UP OEM ANTERIORE	1	1	1	1		4	€ 112,00	E
1050	Sprint ST 1050	2005-2010	HBK8153	SET UP SOPRA PARAFANGO ANTERIORE	1	1		1		3	€ 84,00	E
1050	Sprint ST 1050	2005-2010	HBK8154	SET UP RACE	1	1		1		3	€ 84,00	E
1050	Tiger 1050	2007-2009	HBK8002	SET UP OEM ANTERIORE	1	1	1	1		4	€ 112,00	E
1050	Tiger 1050	2010-2011	HBK8008	SET UP OEM ANTERIORE	1	1	1	1		4	€ 112,00	E
1200	Daytona 1200	1992-1997	HBK8126	SET UP OEM ANTERIORE	1	2		1		4	€ 112,00	E
1200	Trophy 1200	1991-2002	HBC8063	LINEA FRIZIONE					1	1	€ 28,00	E
1200	Trophy 1200	1991-2002	HBK8064	SET UP RACE	1	1		1		3	€ 84,00	E
1200	Trophy 1200	1991-2002	HBK8174	SET UP SOPRA PARAFANGO ANTERIORE	1	1		1		3	€ 84,00	E
1200	Trophy 1200	1991-2002	HBK8063	SET UP OEM ANTERIORE	1	2		1		4	€ 112,00	E
2300	Rocket III	2004-2010	HBK8138	SET UP RACE	1	1		1		3	€ 84,00	E
2300	Rocket III	2004-2010	HBK8137	SET UP OEM ANTERIORE	1	1	1	1		4	€ 112,00	E

CILIND.	MODELLO	ANNI	CODICE	CONFIGURAZIONE	ANT. SUP	ANT. INF	AGG	POST	FRIZ.	TOT. TUBI	PREZZO PUBBLICO IVA ESCL.	FASCIA
2300	Rocket III ABS Roadster	2011-2013	HBK8014	SET UP OEM ANTERIORE	4			2		6	€ 216,00	E
	T140 D US Specification	1979	HBK8018	SET UP OEM ANTERIORE	1	2		1		4	€ 112,00	E
	T140 E US Specification	1980	HBK8019	SET UP OEM ANTERIORE	1	1		1		3	€ 84,00	E
	T140 V	1975	HBK8020	SET UP OEM ANTERIORE	1	1		1		3	€ 84,00	E
	T140 V	1978	HBK8021	SET UP OEM ANTERIORE	1	1		1		3	€ 84,00	E
	T160 V	1975	HBK8022	SET UP OEM ANTERIORE	1	2		1		4	€ 112,00	E
	TSS Electro / Bonneville Low Bar		HBK8023	SET UP OEM ANTERIORE	1	2		1		4	€ 112,00	E
	T140 E UK Specification	1979	HBK8026	SET UP OEM ANTERIORE	1	1	1			3	€ 84,00	E
	TSX 4		HBK8079	SET UP OEM ANTERIORE	1	1		1		3	€ 84,00	E
	TSX 8		HBK8080	SET UP OEM ANTERIORE	1	1		1		3	€ 84,00	E
VESPA												
300	GTS 300 Super Sport	2012-2014	HBK8501	SET UP OEM ANTERIORE	1			1		2	€ 56,00	E
	Douglas	1991	HBK8500	SET UP OEM ANTERIORE	1					1	€ 28,00	E
YAMAHA												
50	BWS NG B-Whizz	1999-2005	HBK9637	SET UP OEM ANTERIORE	1					1	€ 28,00	E
50	CW50 BWS B-Whizz	1999-2004	HBK9638	SET UP OEM ANTERIORE	1					1	€ 28,00	E
50	DT50	2004-2013	HBK9776	SET UP OEM ANTERIORE	1					1	€ 28,00	E
50	Neos	2004-2009	HBK9740	SET UP OEM ANTERIORE	1					1	€ 28,00	E
50	YQ50 Aerox	1998-2003	HBK9613	SET UP OEM ANTERIORE	1			1		2	€ 56,00	E
50	YSR50	1980	HBK9062	SET UP OEM ANTERIORE	1					1	€ 28,00	E
85	YZ85	2001-2010	HBK9498	SET UP OEM ANTERIORE	1			1		2	€ 56,00	E
100	RS100	2004	HBK9653	SET UP OEM ANTERIORE	1					1	€ 28,00	E
125	DT125 R	1988-2003	HBK9025	SET UP OEM ANTERIORE	1			1		2	€ 56,00	E
125	DT125 X - SM	2004-2007	HBK9705	SET UP OEM ANTERIORE	1			1		2	€ 56,00	E
125	MT125	2015-2016	HBK9008	SET UP OEM ANTERIORE	1			1		2	€ 56,00	E
125	NXC125 Cygnus X	2004-2008	HBK9654	SET UP OEM ANTERIORE	1					1	€ 28,00	E
125	Quad : YFM125	2011-2012	HBK9769	SET UP OEM ANTERIORE	1	1	1	1		4	€ 112,00	E
125	RD125 LC	1982-1989	HBK9132	SET UP OEM ANTERIORE	1					1	€ 28,00	E
125	RDZ125		HBK9747	SET UP OEM ANTERIORE	1					1	€ 28,00	E
125	TDR125	1993-1997	HBK9651	SET UP OEM ANTERIORE	1					1	€ 28,00	E
125	TZ125		HBK9726	SET UP OEM ANTERIORE	1					1	€ 28,00	E
125	TZR125	1987-1990	HBK9233	SET UP OEM ANTERIORE	1			1		2	€ 56,00	E
125	TZR125	1991-1997	HBK9764	SET UP OEM ANTERIORE	1			1		2	€ 56,00	E
125	TZR125 Belgarda (Brembo)	1987-1992	HBK9234	SET UP OEM ANTERIORE	1			1		2	€ 56,00	E
125	WR125R	2008-2009	HBK9760	SET UP RACE	1			1		2	€ 56,00	E
125	WR125X	2008-2009	HBK9766	SET UP OEM ANTERIORE	1			1		2	€ 56,00	E
125	WR125X	2010-2014	HBK9783	SET UP OEM ANTERIORE	1			1		2	€ 56,00	E
125	X-Max 125	2006-2008	HBK9698	SET UP OEM ANTERIORE	1			1		2	€ 56,00	E
125	X-MAX 125	2014-2016	HBK9102	SET UP OEM ANTERIORE	1			1		2	€ 56,00	E
125	XT125	1982-1985	HBK9372	SET UP OEM ANTERIORE	1					1	€ 28,00	E
125	XTZ125 E	2006-2010	HBK9741	SET UP OEM ANTERIORE	1					1	€ 28,00	E
125	XV125 S Virago	1997-2001	HBK9730	SET UP OEM ANTERIORE	1					1	€ 28,00	E
125	YBR125	2008	HBK9718	SET UP OEM ANTERIORE	1					1	€ 28,00	E
125	YBR125	2006-2010	HBK9680	SET UP OEM ANTERIORE	1					1	€ 28,00	E
125	YBR125 Custom	2008	HBK9717	SET UP OEM ANTERIORE	1					1	€ 28,00	E
125	YBR125 ED	2006-2010	HBK9680	SET UP OEM ANTERIORE	1					1	€ 28,00	E
125	YP125R Majesty	1999-2007	HBK9655	SET UP OEM ANTERIORE	1					1	€ 28,00	E
125	YZ125	1998-2004	HBK9493	SET UP OEM ANTERIORE	1			1		2	€ 56,00	E
125	YZ125	2005-2010	HBK9650	SET UP OEM ANTERIORE	1			1		2	€ 56,00	E
125	YZF-R125	2008-2013	HBK9719	SET UP OEM ANTERIORE	1			1		2	€ 56,00	E
125	YZF-R125	2014-2015	HBK9722	SET UP OEM ANTERIORE	1			1		2	€ 56,00	E
125	MT125A ABS	2015-2017	HBK9011	SET UP OEM ANTERIORE	2			2		4	€ 144,00	E
180	DTN / DTZ 180	1985-1991	HBK9745	SET UP OEM ANTERIORE	1					1	€ 28,00	E
180	TDR180		HBK9749	SET UP OEM ANTERIORE	1					1	€ 28,00	E

CILIND.	MODELLO	ANNI	CODICE	CONFIGURAZIONE	ANT. SUP	ANT. INF	AGG	POST	FRIZ.	TOT. TUBI	PREZZO PUBBLICO IVA ESCL.	FASCIA
180	RX180	1980-1985	HBK9748	SET UP OEM ANTERIORE	1					1	€ 28,00	E
200	DT200	1980-2010	HBK9746	SET UP OEM ANTERIORE	1			1		2	€ 56,00	E
200	Quad : YFZ200 Blaster	2003-2004	HBK9635	SET UP RACE	1	1		1		3	€ 84,00	E
200	Quad : YFZ200 Blaster	2005-2006	HBK9690	SET UP OEM ANTERIORE	1	1	1	1		4	€ 112,00	E
200	RD200	1978-1983	HBK9139	SET UP OEM ANTERIORE	1					1	€ 28,00	E
200	SDR200 Import	1987-1990	HBK9190	SET UP OEM ANTERIORE	1			1		2	€ 56,00	E
225	XT225	1980-1990	HBK9641	SET UP OEM ANTERIORE	1					1	€ 28,00	E
250	Quad : YFM250	2011-2012	HBK9770	SET UP OEM ANTERIORE	1	1	1	1		4	€ 112,00	E
250	R1-Z 250 2 Stroke	1990-1991	HBK9520	SET UP RACE	1	1		1		3	€ 84,00	E
250	RD250 C	1976	HBK9152	SET UP OEM ANTERIORE	1					1	€ 28,00	E
250	RD250 D	1977	HBK9153	SET UP OEM ANTERIORE	1			1		2	€ 56,00	E
250	RD250 DX	1977	HBK9154	SET UP OEM ANTERIORE	1					1	€ 28,00	E
250	RD250 DXD	1977	HBK9155	SET UP OEM ANTERIORE	1					1	€ 28,00	E
250	RD250 E	1978	HBK9156	SET UP OEM ANTERIORE	1			1		2	€ 56,00	E
250	RD250 F	1979	HBK9157	SET UP OEM ANTERIORE	1			1		2	€ 56,00	E
250	RD250 LC	1980-1983	HBK9158	SET UP OEM ANTERIORE	1					1	€ 28,00	E
250	RZ250	1983-1984	HBK9708	SET UP OEM ANTERIORE	1	2		1		4	€ 112,00	E
250	SR250	1980-1996	HBK9194	SET UP OEM ANTERIORE	1					1	€ 28,00	E
250	SRV250		HBK9707	SET UP OEM ANTERIORE	1					1	€ 28,00	E
250	TDR250	1988-1992	HBK9216	SET UP OEM ANTERIORE	1			1		2	€ 56,00	E
250	TTR250	1994	HBK9609	SET UP OEM ANTERIORE	1			1		2	€ 56,00	E
250	TTR250	1995	HBK9706	SET UP OEM ANTERIORE	1					1	€ 28,00	E
250	TZ250	1980-1990	HBK9727	SET UP OEM ANTERIORE	1	1				2	€ 56,00	E
250	TZ250	1991-2000	HBK9728	SET UP OEM ANTERIORE	1	1		1		3	€ 84,00	E
250	TZR250 2MA / 1KT	1986-1990	HBK9240	SET UP OEM ANTERIORE	1			1		2	€ 56,00	E
250	TZR250 3MA (Reverse Cylinder)	1989-1990	HBK9242	SET UP OEM ANTERIORE	1	1		1		3	€ 84,00	E
250	TZR250 3XV	1991-1996	HBK9241	SET UP OEM ANTERIORE	1	1		1		3	€ 84,00	E
250	WR250	2001-2005	HBK9614	SET UP OEM ANTERIORE	1			1		2	€ 56,00	E
250	WR250F	2004	HBK9716	SET UP OEM ANTERIORE	1			1		2	€ 56,00	E
250	WR250F	2007-2008	HBK9701	SET UP OEM ANTERIORE	1			1		2	€ 56,00	E
250	WR250F Motorcross	2005-2006	HBK9647	SET UP OEM ANTERIORE	1			1		2	€ 56,00	E
250	WR250R	2008-2009	HBK9720	SET UP OEM ANTERIORE	1			1		2	€ 56,00	E
250	WR250X	2008-2010	HBK9723	SET UP OEM ANTERIORE	1			1		2	€ 56,00	E
250	XG250 Tricker	2005-2016	HBK9007	SET UP OEM ANTERIORE	1			1		2	€ 56,00	E
250	X-Max 250	2006-2008	HBK9676	SET UP OEM ANTERIORE	1			1		2	€ 56,00	E
250	X-Max 250	2007-2008	HBK9699	SET UP OEM ANTERIORE	1					1	€ 28,00	E
250	XS250 SE	1980-1985	HBK9337	SET UP OEM ANTERIORE	1					1	€ 28,00	E
250	XT250 Serow	2004-2005	HBK9724	SET UP OEM ANTERIORE	1			1		2	€ 56,00	E
250	XTZ250 Leader	2006-2010	HBK9743	SET UP OEM ANTERIORE	1			1		2	€ 56,00	E
250	XTZ250 X	2006-2010	HBK9742	SET UP OEM ANTERIORE	1			1		2	€ 56,00	E
250	XVS250 Dragstar	2004-2005	HBK9631	SET UP OEM ANTERIORE	1					1	€ 28,00	E
250	YP250 Majesty	1996-2004	HBK9691	SET UP OEM ANTERIORE	1					1	€ 28,00	E
250	YS250 Fazer	2008-2010	HBK9744	SET UP OEM ANTERIORE	1					1	€ 28,00	E
250	YZ250	1991	HBK9494	SET UP OEM ANTERIORE	1					1	€ 28,00	E
250	YZ250	1992-1995	HBK9492	SET UP OEM ANTERIORE	1			1		2	€ 56,00	E
250	YZ250	1998-2003	HBK9495	SET UP OEM ANTERIORE	1			1		2	€ 56,00	E
250	YZ250 / YZF250	2004-2010	HBK9640	SET UP OEM ANTERIORE	1			1		2	€ 56,00	E
250	YZ250 / YZF250	2004-2011	HBK9649	SET UP OEM ANTERIORE	1			1		2	€ 56,00	E
250	YZ250F YZF	2006-2008	HBK9682	SET UP OEM ANTERIORE	1			1		2	€ 56,00	E
250	YZ250F YZF	2011-2017	HBK9758	SET UP OEM ANTERIORE	1			1		2	€ 56,00	E
300	YZF-R3 ABS	2015-2017	HBK9009	SET UP OEM ANTERIORE	4			2		6	€ 168,00	E
300	YZF-R3	2016-2019	HBKFK0014	SET UP RACE	1			1		2	€ 56,00	E
350	Quad : YFZ350 Banshee	1989-2003	HBK9633	SET UP RACE	1	1		1		3	€ 84,00	E
350	Quad : YFZ350X Warrior	1989-2003	HBK9618	SET UP RACE	1	1		1		3	€ 84,00	E
350	RD350 LC	1980-1983	HBK9164	SET UP OEM ANTERIORE	1	2				3	€ 84,00	E

CILIND.	MODELLO	ANNI	CODICE	CONFIGURAZIONE	ANT. SUP	ANT. INF	AGG	POST	FRIZ.	TOT. TUBI	PREZZO PUBBLICO IVA ESCL.	FASCIA
350	RD350 YPVS	1983-1985	HBK9184	SET UP OEM ANTERIORE	1	2		1		4	€ 112,00	E
350	RD350A Replacing Metal Pipe	1974	HBK9768	SET UP OEM ANTERIORE	1	1				2	€ 56,00	E
350	RD350A Retaining Metal Pipe	1974	HBK9767	SET UP OEM ANTERIORE	1	1				2	€ 56,00	E
350	TX350 E	1978	HBK9232	SET UP OEM ANTERIORE	1			1		2	€ 56,00	E
350	XT350	1985-1996	HBK9377	SET UP OEM ANTERIORE	1					1	€ 28,00	E
350	RD350 F2 YPVS	1986-1992	HBK9185	SET UP OEM ANTERIORE	1	2		1		4	€ 112,00	E
400	FZ400 Sports	1985	HBK9058	SET UP OEM ANTERIORE	1	2		1		4	€ 112,00	E
400	FZR400 Genesis Import	1985-1987	HBK9084	SET UP OEM ANTERIORE	1	2		1		4	€ 112,00	E
400	FZR400RR	1992-1996	HBK9085	SET UP RACE	1	1		1		3	€ 84,00	E
400	FZR400RR	1992-1996	HBK9086	SET UP OEM ANTERIORE	1	2		1		4	€ 112,00	E
400	FZR400RR SP	1991-1992	HBK9095	SET UP OEM ANTERIORE	1	2		1		4	€ 112,00	E
400	RD400 C / D Replaces Bundy	1976-1977	HBK9612	SET UP OEM ANTERIORE	1				1	2	€ 56,00	E
400	RD400 C / D Retains Bundy	1976-1977	HBK9634	SET UP OEM ANTERIORE	1				1	2	€ 56,00	E
400	RD400 E / F	1978-1979	HBK9611	SET UP OEM ANTERIORE	1				1	2	€ 56,00	E
400	WR400	1999-2000	HBK9608	SET UP OEM ANTERIORE	1				1	2	€ 56,00	E
400	WR400	2001-2003	HBK9615	SET UP OEM ANTERIORE	1				1	2	€ 56,00	E
400	XJR400	1985-1995	HBK9773	SET UP RACE	1	1			1	3	€ 84,00	E
400	XJR400	1996-2000	HBK9625	SET UP RACE	1	1			1	3	€ 84,00	E
400	XR400RV	1996-2001	HBK9548	SET UP OEM ANTERIORE	1				1	2	€ 56,00	E
400	XS400 D SOHC	1976-1977	HBK9545	SET UP OEM ANTERIORE	1				1	2	€ 56,00	E
400	XS400 SE	1980-1983	HBK9343	SET UP OEM ANTERIORE	1	1				2	€ 56,00	E
400	XV5400 Dragstar	2000-2007	HBK9710	SET UP OEM ANTERIORE	1					1	€ 28,00	E
400	YP400 Majesty 400	2003-2008	HBK9681	SET UP OEM ANTERIORE	1				1	2	€ 56,00	E
400	YZ400	1999	HBK9617	SET UP OEM ANTERIORE	1				1	2	€ 56,00	E
426	WR426F	2001-2003	HBK9616	SET UP OEM ANTERIORE	1				1	2	€ 56,00	E
426	YZ426	2000-2004	HBK9496	SET UP OEM ANTERIORE	1				1	2	€ 56,00	E
450	Quad : YFZ450	2004-2006	HBK9624	SET UP RACE	1	1			1	3	€ 84,00	E
450	Quad : YFZ450	2004-2006	HBK9688	SET UP OEM ANTERIORE	1	1	1	1		4	€ 112,00	E
450	Quad : YFZ450	2009-2016	HBK9692	SET UP OEM ANTERIORE	1	1	1	1		4	€ 112,00	E
450	Quad : YFZ450 - ATV Only	2004-2006	HBK9689	SET UP OEM ANTERIORE	1	1	1	1		4	€ 112,00	E
450	WR450F	2007-2008	HBK9700	SET UP OEM ANTERIORE	1				1	2	€ 56,00	E
450	WR450F Enduro	2005-2006	HBK9736	SET UP OEM ANTERIORE	1				1	2	€ 56,00	E
450	WR450F Motorcross	2005-2006	HBK9646	SET UP OEM ANTERIORE	1				1	2	€ 56,00	E
450	YZ450	2005	HBK9648	SET UP OEM ANTERIORE	1				1	2	€ 56,00	E
450	YZ450F YZF	2006-2010	HBK9683	SET UP OEM ANTERIORE	1				1	2	€ 56,00	E
450	YZ450F YZF	2011-2017	HBK9759	SET UP OEM ANTERIORE	1				1	2	€ 56,00	E
500	KS500 C	1976	HBK9131	SET UP OEM ANTERIORE	1				1	2	€ 56,00	E
500	RD500 LC YPVS	1984-1987	HBK9186	SET UP OEM ANTERIORE	1	2	2	1		6	€ 168,00	E
500	RVZ500R	1984-1986	HBK9187	SET UP OEM ANTERIORE	1	2	2	1		6	€ 168,00	E
500	SR500	1978-1983	HBK9195	SET UP OEM ANTERIORE	1	1				2	€ 56,00	E
500	XP500 T-Max	2000-2004	HBK9704	SET UP OEM ANTERIORE	1				1	2	€ 56,00	E
500	XP500 T-Max	2004-2007	HBK9677	SET UP OEM ANTERIORE	1	1	1	1		4	€ 112,00	E
500	XS500 C	1976	HBK9349	SET UP OEM ANTERIORE	1	1				2	€ 56,00	E
500	XS500 E Twin Disc Conversion	1978	HBK9739	SET UP OEM ANTERIORE	1	2			1	4	€ 112,00	E
500	XT500	1977-1983	HBK9389	SET UP OEM ANTERIORE	1					1	€ 28,00	E
530	XP500 T-Max	2008	HBK9715	SET UP OEM ANTERIORE	1	2			1	4	€ 112,00	E
530	T-Max SX-DX ABS	2018-2019	HBK0018	SET UP OEM ANTERIORE	3	1			1	5	€ 180,00	E
530	T-Max SX-DX	2018-2019	HBK0019	SET UP OEM ANTERIORE	3				1	4	€ 112,00	E
535	XV535 DX Virago	1998-2001	HBK9433	SET UP OEM ANTERIORE	1		1			2	€ 56,00	E
535	XV535 S Virago	1994-1997	HBK9437	SET UP OEM ANTERIORE	1			1		2	€ 56,00	E
535	XV535 Virago Import	1988-1998	HBK9441	SET UP OEM ANTERIORE	1			1		2	€ 56,00	E
550	XJ550	1981-1985	HBK9267	SET UP OEM ANTERIORE	1	2				3	€ 84,00	E

CILIND.	MODELLO	ANNI	CODICE	CONFIGURAZIONE	ANT. SUP	ANT. INF	AGG	POST	FRIZ.	TOT. TUBI	PREZZO PUBBLICO IVA ESCL.	FASCIA
550	XJ550 US Import	1985	HBK9272	SET UP OEM ANTERIORE	1	1				2	€ 56,00	E
550	XZ550	1982-1985	HBK9486	SET UP OEM ANTERIORE	1	2				3	€ 84,00	E
550	XZ550S	1984-1985	HBK9489	SET UP OEM ANTERIORE	1	2				3	€ 84,00	E
600	FZ6 Fazer S2 ABS (solo carenata)	2007-2010	HBK9693	SET UP OEM ANTERIORE	6			2		8	€ 288,00	E
600	FZ6 N Fazer	2004-2006	HBK9628	SET UP RACE	1	1		1		3	€ 84,00	E
600	FZ6 N Fazer	2004-2006	HBK9629	SET UP SOPRA PARAFANGO ANTERIORE	1	1		1		3	€ 84,00	E
600	FZ6 N Fazer	2007-2010	HBK9756	SET UP SOPRA PARAFANGO ANTERIORE	1	1		1		3	€ 84,00	E
600	FZ6 N Fazer	2007-2010	HBK9757	SET UP RACE	1	1		1		3	€ 84,00	E
600	FZ6 S Fazer	2004-2006	HBK9626	SET UP RACE	1	1		1		3	€ 84,00	E
600	FZ6 S Fazer	2004-2006	HBK9627	SET UP SOPRA PARAFANGO ANTERIORE	1	1		1		3	€ 84,00	E
600	FZ6 S2 Fazer	2007-2010	HBK9754	SET UP SOPRA PARAFANGO ANTERIORE	1	1		1		3	€ 84,00	E
600	FZ6 S2 Fazer	2007-2010	HBK9755	SET UP RACE	1	1		1		3	€ 84,00	E
600	FZ600 Sports	1987-1988	HBK9059	SET UP OEM ANTERIORE	1	2		1		4	€ 112,00	E
600	FZR600	1989-1990	HBK9098	SET UP RACE	1	1		1		3	€ 84,00	E
600	FZR600	1989-1990	HBK9097	SET UP OEM ANTERIORE	1	2		1		4	€ 112,00	E
600	FZR600 Genesis	1991-1993	HBK9100	SET UP OEM ANTERIORE	1	2		1		4	€ 112,00	E
600	FZR600 R US Import	1994-1996	HBK9585	SET UP OEM ANTERIORE	1	1		1		3	€ 84,00	E
600	FZR600R	1994-1996	HBK9105	SET UP OEM ANTERIORE	1	1		1		3	€ 84,00	E
600	FZS600 Fazer	1998-2003	HBK9119	SET UP RACE	1	1		1		3	€ 84,00	E
600	FZS600 Fazer	1998-2003	HBK9118	SET UP OEM ANTERIORE	1	2		1		4	€ 112,00	E
600	SRX600	1986-1988	HBK9200	SET UP OEM ANTERIORE	1	2		1		4	€ 112,00	E
600	TT600N	1985-1989	HBK9774	SET UP OEM ANTERIORE	1					1	€ 28,00	E
600	XJ6	2008-2009	HBK9753	SET UP RACE	1	1		1		3	€ 84,00	E
600	XJ6 N	2009-2010	HBK9762	SET UP RACE	1	1		1		3	€ 84,00	E
600	XJ6 N	2009-2010	HBK9763	SET UP SOPRA PARAFANGO ANTERIORE	1	1		1		3	€ 84,00	E
600	XJ600	1990	HBK9751	SET UP OEM ANTERIORE	1	2				3	€ 84,00	E
600	XJ600	1984-1992	HBK9273	SET UP OEM ANTERIORE	1	2		1		4	€ 112,00	E
600	XJ600 F Diversion ABS	2011	HBK9005	SET UP OEM ANTERIORE	4			1		5	€ 180,00	E
600	XJ600 N	2000	HBK9775	SET UP RACE	1	1		1		3	€ 84,00	E
600	XJ600 N	1994-1997	HBK9729	SET UP OEM ANTERIORE	1			1		2	€ 56,00	E
600	XJ600 N - S Diversion	1998-2003	HBK9575	SET UP RACE	1	1		1		3	€ 84,00	E
600	XJ600 N Single Disc Diversion	1992-1997	HBK9282	SET UP OEM ANTERIORE	1			1		2	€ 56,00	E
600	XT600	1987-1990	HBK9711	SET UP OEM ANTERIORE	1			1		2	€ 56,00	E
600	XT600	1991-2003	HBK9657	SET UP OEM ANTERIORE	1			1		2	€ 56,00	E
600	XT600 Z Tenere	1986-1990	HBK9390	SET UP OEM ANTERIORE	1			1		2	€ 56,00	E
600	YX600 Radian	1986-1994	HBK9283	SET UP OEM ANTERIORE	1	2				3	€ 84,00	E
600	YZF600R Thundercat	1996-2002	HBK9505	SET UP OEM ANTERIORE	1	1		1		3	€ 84,00	E
600	YZF-R6	1998-2002	HBK9524	SET UP OEM ANTERIORE	1	1		1		3	€ 84,00	E
600	YZF-R6	1998-2002	HBK9525	SET UP SOPRA PARAFANGO ANTERIORE	1	1		1		3	€ 84,00	E
600	YZF-R6	2003-2004	HBK9566	SET UP RACE	1	1		1		3	€ 84,00	E
600	YZF-R6	2005	HBK9644	SET UP RACE	1	1		1		3	€ 84,00	E
600	YZF-R6	2005	HBK9645	SET UP SOPRA PARAFANGO ANTERIORE	1	1		1		3	€ 84,00	E
600	YZF-R6	2006-2016	HBK9686	SET UP RACE	1	1		1		3	€ 84,00	E
600	YZF-R6 Rossi Replica	2006-2007	HBK9687	SET UP RACE	1	1		1		3	€ 84,00	E
600	YZF-R6 ABS	2017-2019	HBFKK0013	SET UP OEM ANTERIORE	3	1		1		5	€ 180,00	E
600	YZF-R6	2018-2019	HBFKK0015	SET UP SUPERSPORT	4			1		5	€ 140,00	E
600	YZF-R6	2018-2019	HBFKK0016	SET UP RACE	2			1		3	€ 84,00	E
650	XJ650	1980-1984	HBK9289	SET UP OEM ANTERIORE	1	2				3	€ 84,00	E
650	XJ650 Maxim USA Import - Single disc	1982-1984	HBK9290	SET UP OEM ANTERIORE	1	1				2	€ 56,00	E

CILIND.	MODELLO	ANNI	CODICE	CONFIGURAZIONE	ANT. SUP	ANT. INF	AGG	POST	FRIZ.	TOT. TUBI	PREZZO PUBBLICO IVA ESCL.	FASCIA
650	XJ650 Turbo	1982-1985	HBK9294	SET UP OEM ANTERIORE	1	2				3	€ 84,00	E
650	XS650	1981-1982	HBK9351	SET UP OEM ANTERIORE	1	2				3	€ 84,00	E
650	XS650 B - **** CHECK 10x1.00mm Thread ****	1975	HBK9350	SET UP OEM ANTERIORE	1	2				3	€ 84,00	E
650	XS650 C	1975	HBK9352	SET UP OEM ANTERIORE	1	2				3	€ 84,00	E
650	XS650 E - F	1978-1980	HBK9353	SET UP OEM ANTERIORE	1	2				3	€ 84,00	E
650	XS650 II	1972	HBK9354	SET UP OEM ANTERIORE	1					1	€ 28,00	E
650	XS650 SE	1979-1982	HBK9355	SET UP OEM ANTERIORE	1	1		1		3	€ 84,00	E
650	XS650 US Import		HBK9360	SET UP OEM ANTERIORE	1	1				2	€ 56,00	E
650	XV650 Dragstar	1997-2007	HBK9459	SET UP OEM ANTERIORE	1					1	€ 28,00	E
650	XV650A Dragstar Classic	1998-2006	HBK9464	SET UP OEM ANTERIORE	1					1	€ 28,00	E
660	MT-03	2006-2008	HBK9674	SET UP RACE	1	1		1		3	€ 84,00	E
660	MT-03	2006-2008	HBK9675	SET UP OEM ANTERIORE	1	1	1	1		4	€ 112,00	E
660	Quad : YFZ660R Raptor	2000-2005	HBK9619	SET UP RACE	1	1		1		3	€ 84,00	E
660	Quad : YFZ660R Raptor	2000-2005	HBK9620	SET UP OEM ANTERIORE	1	2		1		4	€ 112,00	E
660	SZR660	1996-1997	HBK9203	SET UP OEM ANTERIORE	1			1		2	€ 56,00	E
660	XT660 Z Tenere	2008-2010	HBK9721	SET UP RACE	1	1		1		3	€ 84,00	E
660	XT660R	2004-2010	HBK9643	SET UP OEM ANTERIORE	1			1		2	€ 56,00	E
660	XT660X	2004-2010	HBK9630	SET UP OEM ANTERIORE	1			1		2	€ 56,00	E
660	XT660Z Tenere	1991-2003	HBK9761	SET UP OEM ANTERIORE	1			1		2	€ 56,00	E
660	XT660Z Tenere ABS	2014-2016	HBK9010	SET UP OEM ANTERIORE	6			2		8	€ 288,00	E
660	XTZ660 R	2000-2008	HBK9734	SET UP RACE	1	1		1		3	€ 84,00	E
660	XTZ660 Tenere	1991-1999	HBK9397	SET UP OEM ANTERIORE	1			1		2	€ 56,00	E
700	MT-07	2013-2016	HBK9671	SET UP RACE	1	1		1		3	€ 84,00	E
700	MT-07	2013-2016	HBK9673	SET UP SOPRA PARAFANGO ANTERIORE	1	1		1		3	€ 84,00	E
700	MT-07 ABS	2013-2019	HBK9685	SET UP OEM ANTERIORE	6			2		8	€ 288,00	E
700	Quad : YFM700 Raptor	2006-2008	HBK9702	SET UP OEM ANTERIORE	1	1	1	1		4	€ 112,00	E
700	Quad : YFM700 Raptor	2009-2012	HBK9004	SET UP OEM ANTERIORE	1	1	1	1		4	€ 112,00	E
700	XV700 Virago Import	1985	HBK9732	SET UP RACE	1	1				2	€ 56,00	E
700	XV700 Virago Import	1985	HBK9731	SET UP OEM ANTERIORE	1	2				3	€ 84,00	E
700	Tracer 700 ABS	2016-2018	HBK9012	SET UP OEM ANTERIORE	5			2		7	€ 252,00	E
700	XSR700 ABS	2015-2018	HBK9902	SET UP OEM ANTERIORE	5			2		7	€ 252,00	E
750	FZ750	1985-1986	HBK9061	SET UP OEM ANTERIORE	1	2		1		4	€ 112,00	E
750	FZ750	1985-1988	HBC9061	LINEA FRIZIONE					1	1	€ 28,00	E
750	FZ750	1987-1995	HBK9067	SET UP OEM ANTERIORE	1	2		1		4	€ 112,00	E
750	FZR750 Genesis	1989-1992	HBK9108	SET UP OEM ANTERIORE	1	2		1		4	€ 112,00	E
750	FZR750 R OW01	1989-1992	HBK9110	SET UP OEM ANTERIORE	1	1		1		3	€ 84,00	E
750	FZX750	1987-1989	HBC9128	LINEA FRIZIONE					1	1	€ 28,00	E
750	FZX750	1987-1989	HBK9128	SET UP OEM ANTERIORE	1	2		1		4	€ 112,00	E
750	XJ750 Antidive	1982-1984	HBK9298	SET UP OEM ANTERIORE	1	2	2			5	€ 140,00	E
750	XS750	1978-1979	HBK9361	SET UP OEM ANTERIORE	1	2		1		4	€ 112,00	E
750	XS750 E	1977-1978	HBK9362	SET UP OEM ANTERIORE	1	2		1		4	€ 112,00	E
750	XS750 SE	1980-1982	HBK9363	SET UP OEM ANTERIORE	1	2		1		4	€ 112,00	E
750	XTZ750 Super Tenere	1989-1996	HBK9406	SET UP OEM ANTERIORE	1	2		1		4	€ 112,00	E
750	XV750 SE	1981-1983	HBK9452	SET UP OEM ANTERIORE	1					1	€ 28,00	E
750	XV750 Virago	1992-1997	HBK9534	SET UP RACE	1	1				2	€ 56,00	E
750	XV750 Virago	1992-1997	HBK9533	SET UP OEM ANTERIORE	1	2				3	€ 84,00	E
750	YZF750 SP	1993-1998	HBC9511	LINEA FRIZIONE					1	1	€ 28,00	E
750	YZF750 SP	1993-1998	HBK9511	SET UP OEM ANTERIORE	1	1		1		3	€ 84,00	E
750	YZF750R	1995-1998	HBK9532	SET UP OEM ANTERIORE	1	1		1		3	€ 84,00	E
750	YZF-R7	1999-2002	HBK9623	SET UP RACE	1	1		1		3	€ 84,00	E
800	FZ8 SA-NA ABS (carenata / scarenata)	2010-2015	HBK9782	SET UP OEM ANTERIORE	7			2		9	€ 324,00	E
800	FZ8 S-N (carenata / scarenata)	2010-2015	HBK9750	SET UP RACE	1	1		1		3	€ 84,00	E

CILIND.	MODELLO	ANNI	CODICE	CONFIGURAZIONE	ANT. SUP	ANT. INF	AGG	POST	FRIZ.	TOT. TUBI	PREZZO PUBBLICO IVA ESCL.	FASCIA
850	MT-09	2013-2015	HBK9778	SET UP SOPRA PARAFANGO ANTERIORE	1	1		1		3	€ 84,00	E
850	MT-09	2013-2015	HBK9779	SET UP RACE	1	1		1		3	€ 84,00	E
850	MT-09 (Inc Sport Tracker) ABS	2013-2018	HBK9780	SET UP OEM ANTERIORE	5			2		7	€ 252,00	E
850	MT-09 Tracer ABS	2015-2016	HBK9777	SET UP OEM ANTERIORE	5			2		7	€ 252,00	E
850	TDM850	1991-1996	HBK9205	SET UP OEM ANTERIORE	1	2		1		4	€ 112,00	E
850	TDM850	1997-2002	HBK9210	SET UP RACE	1	1		1		3	€ 84,00	E
850	TDM850	1997-2002	HBK9211	SET UP SOPRA PARAFANGO ANTERIORE	1	1		1		3	€ 84,00	E
850	TDM850	1997-2002	HBK9725	SET UP OEM ANTERIORE	1	1	1	1		4	€ 112,00	E
850	TRX850	1996-2000	HBK9226	SET UP OEM ANTERIORE	1	1		1		3	€ 84,00	E
850	TRX850	1996-2000	HBK9709	SET UP SOPRA PARAFANGO ANTERIORE	1	1		1		3	€ 84,00	E
850	XS850	1980-1985	HBK9366	SET UP OEM ANTERIORE	1	2		1		4	€ 112,00	E
850	Niken / Niken GT RN58	2017-2018	HBK9014	SET UP OEM ANTERIORE	6			2		8	€ 224,00	E
900	TDM900 (Non ABS)	2002-2012	HBK9555	SET UP SOPRA PARAFANGO ANTERIORE	1	1		1		3	€ 84,00	E
900	TDM900 (Non ABS)	2002-2012	HBK9557	SET UP RACE	1	1		1		3	€ 84,00	E
900	TDM900 (Non ABS)	2002-2012	HBK9556	SET UP OEM ANTERIORE	1	1	1	1		4	€ 112,00	E
900	TDM900A ABS	2005-2010	HBK9559	SET UP OEM ANTERIORE	7			2		9	€ 324,00	E
900	XJ900 F	1986-1991	HBK9301	SET UP OEM ANTERIORE	1	2		1		4	€ 112,00	E
900	XJ900 F	1991-1994	HBK9642	SET UP OEM ANTERIORE	1	2		1		4	€ 112,00	E
900	XJ900 S	1983-1985	HBK9315	SET UP OEM ANTERIORE	1	2	2	1		6	€ 168,00	E
900	XJ900 S Diversion	1994-1996	HBK9712	SET UP RACE	1	1		1		3	€ 84,00	E
900	XJ900 S Diversion	1994-1996	HBK9735	SET UP OEM ANTERIORE	1	1	1	1		4	€ 112,00	E
900	XJ900 S Diversion	1997-2003	HBK9002	SET UP RACE	1	1		1		3	€ 84,00	E
900	XJ900 S Diversion	1997-2003	HBK9003	SET UP SOPRA PARAFANGO ANTERIORE	1	1		1		3	€ 84,00	E
900	XJ900 S Diversion	1997-2003	HBK9001	SET UP OEM ANTERIORE	1	1	1	1		4	€ 112,00	E
900	XSR900 ABS (7 Lines)	2016-2018	HBK9901	SET UP OEM ANTERIORE	5			2		7	€ 252,00	E
900	XSR900 ABARTH ABS (7 Lines)	2017-2018	HBK9900	SET UP OEM ANTERIORE	5			2		7	€ 252,00	E
920	XV920 Import	1981	HBK9652	SET UP OEM ANTERIORE	1	2				3	€ 84,00	E
950	XVS950 Midnight Star	2009-2015	HBK9752	SET UP OEM ANTERIORE	1			1		2	€ 56,00	E
1000	FZ1 Fazer	2009-2015	HBK9120	SET UP RACE	1	1		1		3	€ 84,00	E
1000	FZ1-N Fazer	2006-2010	HBK9668	SET UP RACE	1	1		1		3	€ 84,00	E
1000	FZ1-NA ABS Fazer (solo scarenata)	2008-2012	HBK9116	SET UP OEM ANTERIORE	7			2		9	€ 324,00	E
1000	FZ1-S Fazer (Faired)	2006-2010	HBK9667	SET UP RACE	1	1		1		3	€ 84,00	E
1000	FZ1-SA ABS Fazer (solo scarenata)	2007-2012	HBK9117	SET UP OEM ANTERIORE	6			2		8	€ 288,00	E
1000	FZR1000 EXUP	1989-1991	HBC9074	LINEA FRIZIONE					1	1	€ 28,00	E
1000	FZR1000 Genesis	1987-1988	HBC9072	LINEA FRIZIONE					1	1	€ 28,00	E
1000	FZR1000 Genesis	1987-1988	HBK9072	SET UP OEM ANTERIORE	1	2		1		4	€ 112,00	E
1000	FZR1000 RU EXUP	1991-1994	HBK9083	SET UP RACE	1	1		1		3	€ 84,00	E
1000	FZR1000 RU EXUP	1991-1994	HBK9082	SET UP OEM ANTERIORE	1	2		1		4	€ 112,00	E
1000	FZR1000R EXUP	1989-1990	HBK9658	SET UP RACE	1	1		1		3	€ 84,00	E
1000	FZR1000R EXUP	1989-1990	HBK9074	SET UP OEM ANTERIORE	1	2		1		4	€ 112,00	E
1000	FZR1000R EXUP	1995-1996	HBK9076	SET UP OEM ANTERIORE	1	1		1		3	€ 84,00	E
1000	FZS1000 Fazer	2001-2005	HBK9115	SET UP RACE	1	1		1		3	€ 84,00	E
1000	FZS1000 Fazer	2001-2005	HBK9114	SET UP OEM ANTERIORE	1	2		1		4	€ 112,00	E
1000	GTS1000	1993-1996	HBC9733	LINEA FRIZIONE					1	1	€ 28,00	E
1000	GTS1000 A ABS Front	1993-1996	HBK9733	SET UP OEM ANTERIORE	1	1	1	1		7	€ 252,00	E
1000	GTS1000 A ABS Rear	1993-1996	HBR9733	SET UP OEM ANTERIORE			1	1		2	€ 72,00	E
1000	MT-10 ABS	2016-2018	HBK9639	SET UP OEM ANTERIORE	5			2		7	€ 252,00	E
1000	XV1000 TR1	1981-1985	HBK9221	SET UP OEM ANTERIORE	1	2				3	€ 84,00	E
1000	XV1000 Virago	1986-1989	HBK9414	SET UP OEM ANTERIORE	1	2		1		4	€ 112,00	E
1000	YZF1000R Thunderace	1996-2001	HBK9499	SET UP OEM ANTERIORE	1	1		1		3	€ 84,00	E

CILIND.	MODELLO	ANNI	CODICE	CONFIGURAZIONE	ANT. SUP	ANT. INF	AGG	POST	FRIZ.	TOT. TUBI	PREZZO PUBBLICO IVA ESCL.	FASCIA
1000	YZF1000R Thunderace	1996-2002	HBC9499	LINEA FRIZIONE					1	1	€ 28,00	E
1000	YZF-R1	1998-2001	HBK9516	SET UP OEM ANTERIORE	1	1		1		3	€ 84,00	E
1000	YZF-R1	1998-2001	HBK9517	SET UP SOPRA PARAFANGO ANTERIORE	1	1		1		3	€ 84,00	E
1000	YZF-R1	2002-2003	HBK9522	SET UP RACE	1	1		1		3	€ 84,00	E
1000	YZF-R1	2004-2005	HBK9632	SET UP RACE	1	1		1		3	€ 84,00	E
1000	YZF-R1	2006	HBK9684	SET UP RACE	1	1		1		3	€ 84,00	E
1000	YZF-R1	2007-2008	HBK9703	SET UP RACE	1	1		1		3	€ 84,00	E
1000	YZF-R1	2009-2011	HBK9737	SET UP RACE	1	1		1		3	€ 84,00	E
1000	YZF-R1	2012-2014	HBK9772	SET UP RACE	1	1		1		3	€ 84,00	E
1000	YZF-R1 ABS	2015-2018	HBK9535	SET UP OEM ANTERIORE	5			2		7	€ 252,00	E
1000	YZF-R1 no ABS	2015-2019	HBFKK006	SET UP SBK	4			1		5	€ 140,00	E
1000	YZF-R1 no ABS	2015-2019	HBFKK007	SET UP RACE	2			1		3	€ 84,00	E
1100	BT1100 Bulldog	2003-2006	HBK9622	SET UP RACE	1	1		1		3	€ 84,00	E
1100	BT1100 Bulldog	2003-2006	HBK9621	SET UP OEM ANTERIORE	1	2		1		4	€ 112,00	E
1100	FJ1100	1985-1986	HBC9038	LINEA FRIZIONE					1	1	€ 28,00	E
1100	FJ1100	1985-1986	HBK9038	SET UP OEM ANTERIORE	1	2	2	1		6	€ 168,00	E
1100	MT-01	2005-2012	HBC9670	LINEA FRIZIONE					1	1	€ 28,00	E
1100	MT-01	2005-2012	HBK9670	SET UP RACE	1	1		1		3	€ 84,00	E
1100	MT-01	2005-2012	HBK9672	SET UP OEM ANTERIORE	1	1	1	1		4	€ 112,00	E
1100	XS1100	1978-1980	HBK9332	SET UP OEM ANTERIORE	1	2		1		4	€ 112,00	E
1100	XS1100 S	1981-1984	HBK9333	SET UP OEM ANTERIORE	1	2		1		4	€ 112,00	E
1100	XS1100 SG USA Import		HBK9656	SET UP OEM ANTERIORE	1	2		1		4	€ 112,00	E
1100	XV1100 Virago	1989-1999	HBK9418	SET UP OEM ANTERIORE	1	2				3	€ 84,00	E
1100	XVS1100 A Dragstar	2001-2008	HBK9456	SET UP OEM ANTERIORE	1	2		1		4	€ 112,00	E
1100	XVS1100 V Star (USA)	1998-2008	HBK9567	SET UP OEM ANTERIORE	1	2		1		4	€ 112,00	E
1100	XVS1100A Dragstar	1998-2008	HBK9455	SET UP RACE	1	1		1		3	€ 84,00	E
1200	FJ1200 (1TX / 3CV / 3XW)	1986-1996	HBC9042	LINEA FRIZIONE					1	1	€ 28,00	E
1200	FJ1200 (3CV - 3XW)	1988-1996	HBK9042	SET UP OEM ANTERIORE	1	2		1		4	€ 112,00	E
1200	FJ1200 A ABS	1991-1996	HBC9046	LINEA FRIZIONE					1	1	€ 36,00	E
1200	FJ1200 Anti Dive	1986-1987	HBK9040	SET UP OEM ANTERIORE	1	2	2	1		6	€ 168,00	E
1200	FJ1200A ABS	1991-1996	HBK9046	SET UP OEM ANTERIORE	8					8	€ 288,00	E
1200	V-Max 1200	1985-2003	HBK9246	SET UP RACE	1	1		1		3	€ 84,00	E
1200	V-Max 1200	1985-2003	HBK9245	SET UP OEM ANTERIORE	1	2		1		4	€ 112,00	E
1200	V-Max 1200	1991-2003	HBC9245	LINEA FRIZIONE					1	1	€ 28,00	E
1200	XJR1200	1995-1998	HBC9316	LINEA FRIZIONE					1	1	€ 28,00	E
1200	XJR1200	1995-1998	HBK9316	SET UP RACE	1	1		1		3	€ 84,00	E
1200	XT1200Z Super Tenere ABS	2010-2015	HBK9006	SET UP OEM ANTERIORE	6			2		8	€ 288,00	E
1200	XVZ12TD Venture XVZ1200TD	1999-2001	HBK9468	SET UP OEM ANTERIORE	1	1	2	1		5	€ 140,00	E
1300	FJR1300	2000-2005	HBC9581	LINEA FRIZIONE					1	1	€ 28,00	E
1300	FJR1300	2000-2005	HBK9582	SET UP RACE	1	1		1		3	€ 84,00	E
1300	FJR1300	2000-2005	HBK9581	SET UP OEM ANTERIORE	1	2		1		4	€ 112,00	E
1300	FJR1300A ABS	2006-2007	HBC9662	LINEA FRIZIONE					1	1	€ 36,00	E
1300	FJR1300 AS ABS	2006-2007	HBK9662	SET UP OEM ANTERIORE	6		3	2		11	€ 396,00	E
1300	FJR1300A ABS	2008-2014	HBC9666	LINEA FRIZIONE					1	1	€ 36,00	E
1300	FJR1300A ABS	2008	HBK9666	SET UP OEM ANTERIORE	5			2		7	€ 252,00	E
1300	XJR1300	1999-2001	HBK9326	SET UP RACE	1	1		1		3	€ 84,00	E
1300	XJR1300	1999-2001	HBK9320	SET UP OEM ANTERIORE	1	2		1		4	€ 112,00	E
1300	XJR1300	1999-2016	HBC9326	LINEA FRIZIONE					1	1	€ 28,00	E
1300	XJR1300	2002-2016	HBK9573	SET UP RACE	1	1		1		3	€ 84,00	E
1300	XVS1300A Midnight Star	2006-2010	HBK9697	SET UP OEM ANTERIORE	1	1	1	1		4	€ 112,00	E
1300	XVZ1300 A Royal Star	1996-1999	HBC9476	LINEA FRIZIONE					1	1	€ 28,00	E
1300	XVZ1300 A Royal Star	1996-2001	HBK9476	SET UP OEM ANTERIORE	1	2		1		4	€ 112,00	E
1300	XVZ1300 AT Tour Classic	1997-2001	HBK9471	SET UP OEM ANTERIORE	1	2		1		4	€ 112,00	E

CILIND.	MODELLO	ANNI	CODICE	CONFIGURAZIONE	ANT. SUP	ANT. INF	AGG	POST	FRIZ.	TOT. TUBI	PREZZO PUBBLICO IVA ESCL.	FASCIA
1300	XVZ1300 TF Venture Star	1998-2001	HBK9482	SET UP OEM ANTERIORE	1	2		1		4	€ 112,00	E
1600	XV1600 Road Star	1998-2002	HBK9562	SET UP OEM ANTERIORE	1	2		1		4	€ 112,00	E
1600	XV1600 Roadstar Silverado	1999-2001	HBK9558	SET UP OEM ANTERIORE	1	2		1		4	€ 112,00	E
1600	XV1600 Wild Star	1998-2004	HBK9429	SET UP OEM ANTERIORE	1	2		1		4	€ 112,00	E
1700	V-Max 1700	2009-2011	HBC9771	LINEA FRIZIONE					1	1	€ 28,00	E
1700	V-Max 1700 ABS	2009-2011	HBK9771	SET UP OEM ANTERIORE	9			2		11	€ 396,00	E
1700	XV1700 Road Star	2004-2005	HBK9636	SET UP OEM ANTERIORE	1	2		1		4	€ 112,00	E
1700	XV1700 Warrior	2004-2005	HBK9659	SET UP RACE	1	1		1		3	€ 84,00	E
1700	XV1700 Warrior	2004-2005	HBK9660	SET UP OEM ANTERIORE	1	1	1	1		4	€ 112,00	E
1900	XV1900 Midnight Star	2006-2007	HBK9679	SET UP RACE	1	1		1		3	€ 84,00	E
1900	XV1900 Midnight Star	2006-2012	HBC9738	LINEA FRIZIONE					1	1	€ 28,00	E
1900	XV1900 Midnight Star	2006-2012	HBK9738	SET UP OEM ANTERIORE	1			1		2	€ 56,00	E
	YZF-R15 V1.0	2012	HBF9519	SET UP OEM ANTERIORE	1					1	€ 28,00	E
	YZF-R15 V2.0	2012-2013	HBK9518	SET UP OEM ANTERIORE	1			1		2	€ 56,00	E
	FS1E-DX	1983	HBF9057	SET UP OEM ANTERIORE	1					1	€ 28,00	E
	RDZ135	1991-1997	HBF9765	SET UP OEM ANTERIORE	1					1	€ 28,00	E







CRUISE CONTROL MECCANICO PER MOTO



Creato dal fondatore dell'azienda australiana Roy Mentis nel 2001 dopo un estenuante viaggio in Namibia, dove aveva testato un serbatoio di grandi dimensioni di propria produzione riscontrando allo stesso tempo un affaticamento notevole del polso per le lunghe ore in sella, il cruise control di Kaoko è stato recentemente rinnovato ed arriva ora in Italia grazie alla Forbikes che ne cura la distribuzione in collaborazione con R&G Racing.

Il dispositivo, semplice e geniale come tutte le novità che lasciano il segno, consiste in una coppia di pesi per il manubrio che sostituiscono gli originali e in cui quello destro assolve la funzione di cruise control.

Il meccanismo prevede una rotella dentata che, ruotata dopo essere stata attivata, crea una sufficiente frizione al comando dell'acceleratore per permettere che questo rimanga aperto nella posizione desiderata, vincendo il richiamo della molla, ma allo stesso tempo consente, in caso di necessità, di chiudere il gas in un attimo con la rotazione inversa della mano in quanto la resistenza applicata è minima.

Il dispositivo non crea alcun pericolo, sia perché il comando del gas resta sempre nelle mani del conduttore con la possibilità di esercitare qualsiasi azione, sia perché la sua attivazione non è automatica ma deve essere comandata, altrimenti la manopola del gas ruota liberamente come sempre.

Nel tempo, Kaoko (che deve il suo nome proprio alla zona selvaggia in Africa dove profeticamente avvenne l'intuizione del titolare) ha sviluppato sempre più numerosi kit per adattare il cruise control in sostituzione dei pesi al manubrio, il più possibile simili agli originali: attualmente sono ben 300 i modelli disponibili per la maggior parte delle moto in circolazione, tutti forniti di semplici istruzioni per il montaggio che può essere eseguito da soli in pochi minuti.



MODELLO	ANNI	CODICE	NOTE	PREZZO AL PUBBLICO (IVA ESCLUSA)	FASCIA
APRILIA					
Caponord	2004-2006	KA-CAPO	CON PARAMANI OEM	€ 99,00	F
Caponord 1000 ETV	2007	KA-CAPO	CON PARAMANI OEM	€ 99,00	F
Caponord 1200 ABS	2013-	KA-APR400	NON ADATTO CON MANOPOLE RISCALDATE	€ 101,00	F
Caponord Travel Pack		KA-APR400	CON PARAMANI OEM	€ 101,00	F
Dorsoduro	2009-	KA-APR400	CON PARAMANI OEM	€ 101,00	F
Mana 850	2008	KA-APR300	NON ADATTO CON MANOPOLE RISCALDATE	€ 94,00	F
Pegaso 650		KA-APR200		€ 94,00	F
RSV1000R/RR/Factory	2008-	KA-APR300	NON ADATTO CON MANOPOLE RISCALDATE	€ 94,00	F
RSV4	2009-2014	KA-APR405		€ 101,00	F
RSV4	2009-2017	KA-APR500		€ 94,00	F
RSV4 1100 Factory	2019-	KA-APR500		€ 94,00	F
RSV4 RF	2018	KA-APR500		€ 94,00	F
RSV4 RR	2018	KA-APR500		€ 94,00	F
Shiver 750	2013-	KA-APR200		€ 94,00	F
Shiver 900	2017-	KA-APR200		€ 94,00	F
Shiver Sport ABS	2013-	KA-APR200		€ 94,00	F
SL1000 Falco	2000-	KA-APR200		€ 94,00	F
SRV 850 Scooter	2013	KA-APR405		€ 101,00	F
Trail	2006-2013	KA-APR200		€ 94,00	F
Tuono C4 RR	2018	KA-APR300	NON ADATTO CON MANOPOLE RISCALDATE	€ 94,00	F
Tuono V4 APRC ABS	-2015	KA-APR300	NON ADATTO CON MANOPOLE RISCALDATE	€ 94,00	F
Tuono V4 Factory	2018	KA-APR300	NON ADATTO CON MANOPOLE RISCALDATE	€ 94,00	F
BMW					
C1 Scooter	2000-	KA-CCF918	TUTTI I DIAMETRI SUPERIORI A 18MM SENZA TERMINALI MANUBRIO - MODELLI EUROPEI	€ 94,00	F
C600 Evolution Scooter	2013-	KA-CCF915	PER STABILIZZATORE CROMATO CCF915C	€ 94,00	F
C600 Sport Scooter	2013-	KA-CCF915	PER STABILIZZATORE CROMATO CCF915C	€ 94,00	F
C650 Sport		KA-CCF915	PER STABILIZZATORE CROMATO CCF915C	€ 94,00	F
C650GT Scooter	2013-	KA-CCF915	PER STABILIZZATORE CROMATO CCF915C	€ 94,00	F
F650CS Single	-2007	KA-CCF300	CON MANOPOLE RISCALDATE	€ 94,00	F
F650GS	-2008	KA-CCF300U	SENZA MANOPOLE RISCALDATE	€ 94,00	F
F650GS	-2007	KA-CCF300	CON MANOPOLE RISCALDATE	€ 94,00	F
F650GS Dakar	-2008	KA-CCF300U	SENZA MANOPOLE RISCALDATE	€ 94,00	F
F650GS Dakar	-2007	KA-CCF300	CON MANOPOLE RISCALDATE	€ 94,00	F
F650GS Twin	2008-2012	KA-CCF700	CON O SENZA PARAMANI OEM IN PLASTICA	€ 94,00	F
F650GS Twin	2008-2012	KA-CCF900	CON PARAMANI CON LE BARRE IN ACCIAIO	€ 85,00	F
F700GS	2013-	KA-CCF500	ADATTO PER PARAMANI BARKBUSTERS BHG040	€ 94,00	F
F700GS	2013-	KA-CCF910	CON PARAMANI CON LE BARRE IN ACCIAIO	€ 85,00	F
F750GS	-2019	KA-CCF400-13WC		€ 94,00	F
F800GS	2013-	KA-CCF500	ADATTO PER PARAMANI BARKBUSTERS BHG040	€ 94,00	F
F800GS	2013-	KA-CCF910	CON PARAMANI CON LE BARRE IN ACCIAIO	€ 85,00	F
F800GS Adventure	2013-	KA-CCF910	CON PARAMANI CON LE BARRE IN ACCIAIO	€ 85,00	F
F800GS Twin	2008-2012	KA-CCF700	CON O SENZA PARAMANI OEM IN PLASTICA	€ 94,00	F
F800GS Twin	2008-2012	KA-CCF900	CON PARAMANI CON LE BARRE IN ACCIAIO	€ 85,00	F
F800GT	2013-	KA-CCF916		€ 94,00	F
F800R	-2014	KA-CCF700	CON O SENZA PARAMANI OEM IN PLASTICA	€ 94,00	F
F800R	2015-	KA-CCF112	SENZA PARAMANI	€ 94,00	F
F800R	-2014	KA-CCF110		€ 94,00	F
F800S	2006-	KA-CCF600	MODELLI CON VITE SVASATA SU TERMINALI MANUBRIO SVASATI	€ 94,00	F
F800S	2006-	KA-CCF800	MODELLI CON COPERTURA SU TERMINALE SVASATO	€ 94,00	F
F800ST	2006-	KA-CCF600	MODELLI CON VITE SVASATA SU TERMINALI MANUBRIO SVASATI	€ 94,00	F

MODELLO	ANNI	CODICE	NOTE	PREZZO AL PUBBLICO (IVA ESCLUSA)	FASCIA
F800ST	2006-	KA-CCF800	MODELLI CON COPERTURA SU TERMINALE SVASATO	€ 94,00	F
F850GS	-2019	KA-CCF400-13WC		€ 94,00	F
G310	2016-	KA-CCF135	SENZA PARAMANI OEM IN PLASTICA	€ 85,00	F
G310 GS	2016-	KA-CCF135	SENZA PARAMANI OEM IN PLASTICA	€ 85,00	F
G310 HP	-2019	KA-CCF135	SENZA PARAMANI OEM IN PLASTICA	€ 85,00	F
G310R	-2019	KA-CCF135	SENZA PARAMANI OEM IN PLASTICA	€ 85,00	F
G650GS	-2010	KA-CCF300U	SENZA MANOPOLE RISCALDATE	€ 94,00	F
G650GS	2011-	KA-CCF120	CON O SENZA PARAMANI OEM / CON PARAMANI BHG45-NP	€ 94,00	F
G650GS	-2010	KA-CCF300	CON MANOPOLE RISCALDATE	€ 94,00	F
G650GS Sertao	-2010	KA-CCF300U	SENZA MANOPOLE RISCALDATE	€ 94,00	F
G650GS Sertao	2011-	KA-CCF120	CON O SENZA PARAMANI OEM / CON PARAMANI BHG45-NP	€ 94,00	F
G650X Challenger		KA-KBB400		€ 85,00	F
G650X Country		KA-APR300	MODELLI CON DADO ESAGONALE A/F FILETTATO ALL'ESTREMITÀ DEL MANUBRIO	€ 94,00	F
G650X Country		KA-CCF115	CON PARAMANI HIGHWAY DIRT BIKES	€ 94,00	F
Grand America	2018	KA-CCF130C		€ 99,00	F
HP2		KA-KTMADHP2	ANCHE CON PARAMANI TOURATECH	€ 94,00	F
HP4	2013-	KA-CCF110		€ 94,00	F
K1200 S/R	-2016	KA-CCF500	ADATTO PER PARAMANI BARKBUSTERS BHG040	€ 94,00	F
K1200GT		KA-CCF100	ANCHE CON PARAMANI BARKBUSTERS VPS STORM	€ 94,00	F
K1300 S/R	-2016	KA-CCF500	ADATTO PER PARAMANI BARKBUSTERS BHG040	€ 94,00	F
K1300GT		KA-CCF100	ANCHE CON PARAMANI BARKBUSTERS VPS STORM	€ 94,00	F
K1600B	2018	KA-CCF130C		€ 99,00	F
K1600GT	2012-	KA-CCF130		€ 94,00	F
K1600GT	2011-	KA-CCF130C		€ 99,00	F
K1600GTL	2012-	KA-CCF130		€ 94,00	F
K1600GTL	2011-	KA-CCF130C		€ 99,00	F
K75C		KA-CCF918	TUTTI I DIAMETRI SUPERIORI A 18MM SENZA TERMINALI MANUBRIO - MODELLI EUROPEI	€ 94,00	F
R Nine T	2014-	KA-CCF900		€ 85,00	F
R Nine T Scrambler	2016-2018	KA-CCF900		€ 85,00	F
R100CS		KA-CCF918	TUTTI I DIAMETRI SUPERIORI A 18MM SENZA TERMINALI MANUBRIO - MODELLI EUROPEI	€ 94,00	F
R100GS	1981-	KA-CCF918	TUTTI I DIAMETRI SUPERIORI A 18MM SENZA TERMINALI MANUBRIO - MODELLI EUROPEI	€ 94,00	F
R100S		KA-CCF918	TUTTI I DIAMETRI SUPERIORI A 18MM SENZA TERMINALI MANUBRIO - MODELLI EUROPEI	€ 94,00	F
R1100GS		KA-CCF100	ANCHE CON PARAMANI BARKBUSTERS VPS STORM	€ 94,00	F
R1100R		KA-CCF100	ANCHE CON PARAMANI BARKBUSTERS VPS STORM	€ 94,00	F
R1100RT		KA-CCF100	ANCHE CON PARAMANI BARKBUSTERS VPS STORM	€ 94,00	F
R1100S		KA-CCF200		€ 97,00	F
R1150GS		KA-CCF100	ANCHE CON PARAMANI BARKBUSTERS VPS STORM	€ 94,00	F
R1150GS Adventure		KA-CCF100	ANCHE CON PARAMANI BARKBUSTERS VPS STORM	€ 94,00	F
R1150R		KA-CCF100	ANCHE CON PARAMANI BARKBUSTERS VPS STORM	€ 94,00	F
R1150RS	2004	KA-CCF100	ANCHE CON PARAMANI BARKBUSTERS VPS STORM	€ 94,00	F
R1150RT		KA-CCF100	ANCHE CON PARAMANI BARKBUSTERS VPS STORM	€ 94,00	F
R1200 S/R	-2016	KA-CCF500	ADATTO PER PARAMANI BARKBUSTERS BHG040	€ 94,00	F
R1200C		KA-CCF600C		€ 99,00	F
R1200CL		KA-CCF600C		€ 99,00	F
R1200GS	-2007	KA-CCF400	MODELLI CON BULLONE DI TENUTA CENTRALE 90MM	€ 94,00	F
R1200GS	2008-	KA-CCF400-08	MODELLI CON BULLONE DI TENUTA CENTRALE 80MM	€ 94,00	F
R1200GS Adventure	-2007	KA-CCF400	MODELLI CON BULLONE DI TENUTA CENTRALE 90MM	€ 94,00	F
R1200GS Adventure	2008-	KA-CCF400-08	MODELLI CON BULLONE DI TENUTA CENTRALE 80MM	€ 94,00	F
R1200GS Adventure LC	2013-	KA-CCF400-13WC	MODELLI A LIQUIDO	€ 94,00	F

MODELLO	ANNI	CODICE	NOTE	PREZZO AL PUBBLICO (IVA ESCLUSA)	FASCIA
R1200GS LC	2013-	KA-CCF400-13WC	MODELLI A LIQUIDO	€ 94,00	F
R1200GS Rallye	2017	KA-CCF400-13WC		€ 94,00	F
R1200GS Trophy	2015-	KA-CCF400-13WC		€ 94,00	F
R1200R (solo modelli a liquido)	2015-	KA-CCF400-13WC	MODELLI A LIQUIDO	€ 94,00	F
R1200R Air Cooled	-2014	KA-CCF500	ADATTO PER PARAMANI BARKBUSTERS BHG040	€ 94,00	F
R1200RS	2015-	KA-CCF500	ADATTO PER PARAMANI BARKBUSTERS BHG040	€ 94,00	F
R1200RT	-2009	KA-CCF100	ANCHE CON PARAMANI BARKBUSTERS VPS STORM	€ 94,00	F
R1200RT	2010-	KA-CCF500	ADATTO PER PARAMANI BARKBUSTERS BHG040	€ 94,00	F
R1200ST	-2007	KA-CCF400	MODELLI CON BULLONE DI TENUTA CENTRALE 90MM	€ 94,00	F
R1200ST	2008-	KA-CCF400-08	MODELLI CON BULLONE DI TENUTA CENTRALE 80MM	€ 94,00	F
R1250GS	-2019	KA-CCF400-13WC		€ 94,00	F
R1250R	2019-	KA-CCF400-13WC		€ 94,00	F
R25		KA-CCF918	TUTTI I DIAMETRI SUPERIORI A 18MM SENZA TERMINALI MANUBRIO - MODELLI EUROPEI	€ 94,00	F
R50	1955-	KA-CCF918	TUTTI I DIAMETRI SUPERIORI A 18MM SENZA TERMINALI MANUBRIO - MODELLI EUROPEI	€ 94,00	F
R50	1955-	KA-CCF917	TUTTI I DIAMETRI SUPERIORI A 16MM SENZA TERMINALI MANUBRIO - MODELLI USA	€ 94,00	F
R60	1955-	KA-CCF918	TUTTI I DIAMETRI SUPERIORI A 18MM SENZA TERMINALI MANUBRIO - MODELLI EUROPEI	€ 94,00	F
R60	1955-	KA-CCF917	TUTTI I DIAMETRI SUPERIORI A 16MM SENZA TERMINALI MANUBRIO - MODELLI USA	€ 94,00	F
R65LS		KA-CCF918	TUTTI I DIAMETRI SUPERIORI A 18MM SENZA TERMINALI MANUBRIO - MODELLI EUROPEI	€ 94,00	F
R68		KA-CCF918	TUTTI I DIAMETRI SUPERIORI A 18MM SENZA TERMINALI MANUBRIO - MODELLI EUROPEI	€ 94,00	F
R69	1955-	KA-CCF918	TUTTI I DIAMETRI SUPERIORI A 18MM SENZA TERMINALI MANUBRIO - MODELLI EUROPEI	€ 94,00	F
R69S	1955-	KA-CCF918	TUTTI I DIAMETRI SUPERIORI A 18MM SENZA TERMINALI MANUBRIO - MODELLI EUROPEI	€ 94,00	F
R69S	1955-	KA-CCF917	TUTTI I DIAMETRI SUPERIORI A 16MM SENZA TERMINALI MANUBRIO - MODELLI USA	€ 94,00	F
R75		KA-CCF918	TUTTI I DIAMETRI SUPERIORI A 18MM SENZA TERMINALI MANUBRIO - MODELLI EUROPEI	€ 94,00	F
R80GS	1981-	KA-CCF918	TUTTI I DIAMETRI SUPERIORI A 18MM SENZA TERMINALI MANUBRIO - MODELLI EUROPEI	€ 94,00	F
R80RT		KA-CCF918	TUTTI I DIAMETRI SUPERIORI A 18MM SENZA TERMINALI MANUBRIO - MODELLI EUROPEI	€ 94,00	F
R80ST		KA-CCF918	TUTTI I DIAMETRI SUPERIORI A 18MM SENZA TERMINALI MANUBRIO - MODELLI EUROPEI	€ 94,00	F
R850GS		KA-CCF100	ANCHE CON PARAMANI BARKBUSTERS VPS STORM	€ 94,00	F
R850R		KA-CCF100	ANCHE CON PARAMANI BARKBUSTERS VPS STORM	€ 94,00	F
R90		KA-CCF918	TUTTI I DIAMETRI SUPERIORI A 18MM SENZA TERMINALI MANUBRIO - MODELLI EUROPEI	€ 94,00	F
R90S		KA-CCF918	TUTTI I DIAMETRI SUPERIORI A 18MM SENZA TERMINALI MANUBRIO - MODELLI EUROPEI	€ 94,00	F
S1000R	2015-	KA-CCF112		€ 94,00	F
S1000RR	2010-	KA-CCF110		€ 94,00	F
S1000XR	2015-	KA-CCF400-13WC		€ 94,00	F
BENELLI					
TNT 125	2017-	KA-APR500		€ 94,00	F
BUELL					
1125R	2008-	KA-BUB		€ 139,00	F
Ulysses XB12X		KA-BUB	PER MODELLI CON O SENZA PARAMANI OEM	€ 139,00	F
Ulysses XB12SS		KA-BUB	PER MODELLI CON O SENZA PARAMANI OEM	€ 139,00	F
Ulysses XB12R		KA-BUB	PER MODELLI CON O SENZA PARAMANI OEM	€ 139,00	F
Ulysses XB12XT		KA-BUB	PER MODELLI CON O SENZA PARAMANI OEM	€ 139,00	F
Ulysses XB12X		KA-BUB100	MANOPOLE RIZOMA CON SUPPORTI PER SPECCHIETTI	€ 139,00	F

MODELLO	ANNI	CODICE	NOTE	PREZZO AL PUBBLICO (IVA ESCLUSA)	FASCIA
Ulysses XB12SS		KA-BUB100	MANOPOLE RIZOMA CON SUPPORTI PER SPECCHIETTI	€ 139,00	F
Ulysses XB12R		KA-BUB100	MANOPOLE RIZOMA CON SUPPORTI PER SPECCHIETTI	€ 139,00	F
Ulysses XB12XT		KA-BUB100	MANOPOLE RIZOMA CON SUPPORTI PER SPECCHIETTI	€ 139,00	F
CAN-AM					
Spyder Roadster	-2012	KA-CAN100S		€ 94,00	F
Spyder	-2012	KA-CAN100S	CON RISER KIT	€ 94,00	F
Spyder ST	2013-	KA-CAN200		€ 94,00	F
Spyder RT	2013-	KA-CAN200		€ 94,00	F
Spyder RS	2013-	KA-CAN200		€ 94,00	F
Spyder F3	2013-	KA-CAN200		€ 94,00	F
Spyder F35	2013-	KA-CAN200		€ 94,00	F
DUCATI					
748		KA-DUC100	MANUBRIO CON DIAMETRO INTERNO 16.8MM - ANCHE CON SPECCHIETTI CRG	€ 101,00	F
848		KA-DUC100	MANUBRIO CON DIAMETRO INTERNO 16.8MM - ANCHE CON SPECCHIETTI CRG	€ 101,00	F
848 Evo	2011-2013	KA-DUC105CRG	SOLO CON SPECCHIETTI CRG	€ 106,00	F
848 Evo	2011-2013	KA-DUC105	MANUBRIO CON DIAMETRO INTERNO 14MM	€ 101,00	F
916		KA-DUC100	MANUBRIO CON DIAMETRO INTERNO 16.8MM - ANCHE CON SPECCHIETTI CRG	€ 101,00	F
996		KA-DUC100	MANUBRIO CON DIAMETRO INTERNO 16.8MM - ANCHE CON SPECCHIETTI CRG	€ 101,00	F
998		KA-DUC100	MANUBRIO CON DIAMETRO INTERNO 16.8MM - ANCHE CON SPECCHIETTI CRG	€ 101,00	F
999		KA-DUC100	MANUBRIO CON DIAMETRO INTERNO 16.8MM - ANCHE CON SPECCHIETTI CRG	€ 101,00	F
1000GT Sport Classic		KA-DUCST		€ 94,00	F
1098		KA-DUC100	MANUBRIO CON DIAMETRO INTERNO 16.8MM - ANCHE CON SPECCHIETTI CRG	€ 101,00	F
1198		KA-DUC100	MANUBRIO CON DIAMETRO INTERNO 16.8MM - ANCHE CON SPECCHIETTI CRG	€ 101,00	F
Diavel	2011-	KA-DUCST		€ 94,00	F
Monster 1100 Evo	2008-2014	KA-DUC105	MANUBRIO CON DIAMETRO INTERNO 14MM	€ 101,00	F
Monster 1100 Evo	2008-2014	KA-DUC105CRG	SOLO CON SPECCHIETTI CRG	€ 106,00	F
Monster 1200	2014-	KA-DUC125REV1		€ 85,00	F
Monster 1200	2013-	KA-DUC125CRG	SOLO CON SPECCHIETTI CRG	€ 94,00	F
Monster 1200R	2016-	KA-DUC125REV1		€ 85,00	F
Monster 1200S	2014-	KA-DUC125REV1		€ 85,00	F
Monster 659 ABS	-2014	KA-DUC105	MANUBRIO CON DIAMETRO INTERNO 14MM	€ 101,00	F
Monster 696	2013-	KA-DUC100	MANUBRIO CON DIAMETRO INTERNO 16.8MM - ANCHE CON SPECCHIETTI CRG	€ 101,00	F
Monster 796 ABS	2010-	KA-DUC105	MANUBRIO CON DIAMETRO INTERNO 14MM	€ 101,00	F
Monster 796 ABS	2010-	KA-DUC105CRG	SOLO CON SPECCHIETTI CRG	€ 106,00	F
Monster 821		KA-DUC100	MANUBRIO CON DIAMETRO INTERNO 16.8MM - ANCHE CON SPECCHIETTI CRG	€ 101,00	F
Monster S2		KA-DUCST		€ 94,00	F
Monster S2R		KA-DUCST		€ 94,00	F
Monster S4R	2004-	KA-DUCST		€ 94,00	F
Monster S4RS	2004-	KA-DUCST		€ 94,00	F
Multistrada 1100	2004-2009	KA-DUCST		€ 94,00	F
Multistrada 1100S	2004-2009	KA-DUCST		€ 94,00	F
Multistrada 1200	2010-	KA-DUC100	MANUBRIO CON DIAMETRO INTERNO 16.8MM - ANCHE CON SPECCHIETTI CRG	€ 101,00	F
Multistrada 1200 Enduro	2017-	KA-DUC125REV1		€ 85,00	F
Multistrada 1200 MTS	2013	KA-DUC120	CON PARAMANI DUCATI ENDURO	€ 94,00	F
Multistrada 1200S	2010-	KA-DUC100	MANUBRIO CON DIAMETRO INTERNO 16.8MM - ANCHE CON SPECCHIETTI CRG	€ 101,00	F

MODELLO	ANNI	CODICE	NOTE	PREZZO AL PUBBLICO (IVA ESCLUSA)	FASCIA
Multistrada 1260 Enduro	2017-	KA-DUC125REV1		€ 85,00	F
Multistrada 950	2017-	KA-DUC125REV1		€ 85,00	F
Panigale 1199	2014	KA-DUC110		€ 85,00	F
Panigale 1299	2016-	KA-DUC110		€ 85,00	F
Panigale 899	2013-	KA-DUC110		€ 85,00	F
Panigale 959	2016-	KA-DUC110		€ 85,00	F
S4	2006	KA-DUC115		€ 94,00	F
Scrambler		KA-DUC100	MANUBRIO CON DIAMETRO INTERNO 16.8MM - ANCHE CON SPECCHIETTI CRG	€ 101,00	F
ST2	2000-2003	KA-DUC115		€ 94,00	F
ST3	2005-	KA-DUCST		€ 94,00	F
ST3S	2005-	KA-DUCST		€ 94,00	F
ST4		KA-DUC115		€ 94,00	F
ST4	2005-	KA-DUCST		€ 94,00	F
ST4S	2001-2004	KA-DUC115		€ 94,00	F
ST4S	2005-	KA-DUCST		€ 94,00	F
Streetfighter		KA-DUC100	MANUBRIO CON DIAMETRO INTERNO 16.8MM - ANCHE CON SPECCHIETTI CRG	€ 101,00	F
Streetfighter 848		KA-DUC105CRG	SOLO CON SPECCHIETTI CRG	€ 106,00	F
Streetfighter 848	2007-2013	KA-DUC105	MANUBRIO CON DIAMETRO INTERNO 14MM	€ 101,00	F
Streetfighter S		KA-DUC100	MANUBRIO CON DIAMETRO INTERNO 16.8MM - ANCHE CON SPECCHIETTI CRG	€ 101,00	F
Super Sport 939	2017	KA-DUC125REV1		€ 85,00	F
Super Sport S	2018	KA-DUC125REV1		€ 85,00	F
X Diavel S	2016	KA-DUCST		€ 94,00	F
HARLEY DAVIDSON					
Big Barrel Shape (Black finish)		KA-HDBBB	MANUBRIO DI SERIE	€ 139,00	F
Big Barrel Shape (Black finish)		KA-HDBBB-0.8	MANUBRIO CON DIAMETRO INTERNO 21MM	€ 139,00	F
Big Barrel Shape (Chrome finish)		KA-HDBBC	MANUBRIO DI SERIE	€ 139,00	F
Big Barrel Shape (Chrome finish)		KA-HDBBC-0.8	MANUBRIO CON DIAMETRO INTERNO 21MM	€ 139,00	F
Cannon Ball Shape (Black finish)		KA-HDCBB	MANUBRIO DI SERIE	€ 139,00	F
Cannon Ball Shape (Black finish)		KA-HDCBB-0.8	MANUBRIO CON DIAMETRO INTERNO 21MM	€ 139,00	F
Cannon Ball Shape (Chrome finish)		KA-HDCBC	MANUBRIO DI SERIE	€ 139,00	F
Cannon Ball Shape (Chrome finish)		KA-HDCBC-0.8	MANUBRIO CON DIAMETRO INTERNO 21MM	€ 139,00	F
Snubbie Shape (Black finish)		KA-HDSNUB	MANUBRIO DI SERIE	€ 99,00	F
Snubbie Shape (Black finish)		KA-HDSNUB-0.8	MANUBRIO CON DIAMETRO INTERNO 21MM	€ 99,00	F
Torpedo Shape (Black finish)		KA-HDTB	MANUBRIO DI SERIE	€ 139,00	F
Torpedo Shape (Black finish)		KA-HDTB-0.8	MANUBRIO CON DIAMETRO INTERNO 21MM	€ 139,00	F
Torpedo Shape (Chrome finish)		KA-HDTC	MANUBRIO DI SERIE	€ 139,00	F
Torpedo Shape (Chrome finish)		KA-HDTC-0.8	MANUBRIO CON DIAMETRO INTERNO 21MM	€ 139,00	F
HONDA					
599		KA-HND28	PER MODELLI CON TERMINALI 28MM	€ 94,00	F
1100 Saber		KA-TCH-0.75 oppure KA-TBH-0.75	MODELLI CON PARAMANI OEM E MANOPOLE RISCALDATE	€ 139,00	F
Ace Deluxe VT750		KA-TCH-0.75 oppure KA-TBH-0.75	MODELLI CON PARAMANI OEM E MANOPOLE RISCALDATE	€ 139,00	F
Africa Twin	-2003	KA-HNDVARAOXF	CON O SENZA MANOPOLE RISCALDATE OXFORD	€ 94,00	F
Africa Twin CRF1000L	2016-	KA-HND310	CON O SENZA PARAMANI OEM - ADATTO CON MANOPOLE RISCALDATE	€ 94,00	F

MODELLO	ANNI	CODICE	NOTE	PREZZO AL PUBBLICO (IVA ESCLUSA)	FASCIA
CB1000		KA-HND30-17	PER MODELLI CON TERMINALI 30MM	€ 94,00	F
CB1000R	2018	KA-HND100		€ 94,00	F
CB1000R Predator	2008-	KA-HND30-17	PER MODELLI CON TERMINALI 30MM	€ 94,00	F
CB1100A	2011-	KA-HND30-19	MANUBRIO CON DIAMETRO INTERNO > 19MM	€ 94,00	F
CB1100F	2013-	KA-HND100		€ 94,00	F
CB1300		KA-HND30-17	PER MODELLI CON TERMINALI 30MM	€ 94,00	F
CB500F	2013-	KA-HND100		€ 94,00	F
CB500X	2013-	KA-HND100		€ 94,00	F
CB600 Hornet	-2008	KA-HND28	PER MODELLI CON TERMINALI 28MM	€ 94,00	F
CB600 Hornet	2009-	KA-HND30-17	PER MODELLI CON TERMINALI 30MM	€ 94,00	F
CB650F	-2019	KA-HND100		€ 94,00	F
CBF1000	2008-	KA-HND30-17	PER MODELLI CON TERMINALI 30MM	€ 94,00	F
CBF600		KA-HND30-17	PER MODELLI CON TERMINALI 30MM	€ 94,00	F
CBF650F	-2017	KA-HND30-17	PER MODELLI CON TERMINALI 30MM	€ 94,00	F
CBR1000RR	-2019	KA-HND28	PER MODELLI CON TERMINALI 28MM	€ 94,00	F
CBR1100XX Blackbird		KA-HND31	PER MODELLI CON TERMINALI 31MM	€ 94,00	F
CBR250R		KA-HND100		€ 94,00	F
CBR300F	2013-	KA-HND100		€ 94,00	F
CBR300R	2013-	KA-HND100		€ 94,00	F
CBR500R	2013-	KA-HND100		€ 94,00	F
CBR600F4i		KA-HND30-19	MANUBRIO CON DIAMETRO INTERNO > 19MM	€ 94,00	F
CBR600RR	-2008	KA-HND28	PER MODELLI CON TERMINALI 28MM	€ 94,00	F
CBR600RR	2008-	KA-HND30-19	MANUBRIO CON DIAMETRO INTERNO > 19MM	€ 94,00	F
CBR650F	2015-	KA-HND31	PER MODELLI CON TERMINALI 31MM	€ 94,00	F
CBR900RR		KA-HND31	PER MODELLI CON TERMINALI 31MM	€ 94,00	F
CMX250		KA-TCH-0.75 oppure KA-TBH-0.75	MODELLI CON PARAMANI OEM E MANOPOLE RISCALDATE	€ 139,00	F
CTX700	2013-	KA-HND100		€ 94,00	F
CTX700 DCT	2013-	KA-HND100		€ 94,00	F
CTX700 N	2013-	KA-HND100		€ 94,00	F
CTX700 ND	2013-	KA-HND100		€ 94,00	F
F4i	2006	KA-HND28	PER MODELLI CON TERMINALI 28MM	€ 94,00	F
F6B Goldwing	2012-	KA-HND31	PER MODELLI CON TERMINALI 31MM	€ 94,00	F
FJS 600 Silverwing	2002-	KA-HNDFJS	MODELLI CON PARAMANI OEM E MANOPOLE RISCALDATE	€ 94,00	F
Integra Scooter	2012-	KA-HND100		€ 94,00	F
Interstate 1300	2014-	KA-TCH-0.8 oppure KA-TBH-0.8	MODELLI CON PARAMANI OEM E MANOPOLE RISCALDATE	€ 139,00	F
NC700	2012-	KA-HND100		€ 94,00	F
NC700X	2012-	KA-HND100		€ 94,00	F
NC750	2013-	KA-HND100		€ 94,00	F
NM4	2015-	KA-HND28	PER MODELLI CON TERMINALI 28MM	€ 94,00	F
NT700A Deauville		KA-HNDNT	MODELLI CON PARAMANI OEM E MANOPOLE RISCALDATE	€ 94,00	F
NT700V Deauville		KA-HNDNT	MODELLI CON PARAMANI OEM E MANOPOLE RISCALDATE	€ 94,00	F
Shadow 1100		KA-TCH-0.8 oppure KA-TBH-0.8	MODELLI CON PARAMANI OEM E MANOPOLE RISCALDATE	€ 139,00	F
Shadow 750		KA-TCH-0.8 oppure KA-TBH-0.8	MODELLI CON PARAMANI OEM E MANOPOLE RISCALDATE	€ 139,00	F
Shadow Aero		KA-TCH-0.8 oppure KA-TBH-0.8	MODELLI CON PARAMANI OEM E MANOPOLE RISCALDATE	€ 139,00	F
Shadow American		KA-TCH-0.8 oppure KA-TBH-0.8	MODELLI CON PARAMANI OEM E MANOPOLE RISCALDATE	€ 139,00	F
Shadow Sabre		KA-TCH-0.8 oppure KA-TBH-0.8	MODELLI CON PARAMANI OEM E MANOPOLE RISCALDATE	€ 139,00	F
Spirit 1100		KA-TCH-0.8 oppure KA-TBH-0.8	MODELLI CON PARAMANI OEM E MANOPOLE RISCALDATE	€ 139,00	F
ST1100		KA-HNDST1100	MODELLI CON PARAMANI OEM E MANOPOLE RISCALDATE	€ 94,00	F

MODELLO	ANNI	CODICE	NOTE	PREZZO AL PUBBLICO (IVA ESCLUSA)	FASCIA
ST1300	2002-	KA-HNDST	CON O SENZA MANOPOLE RISCALDATE	€ 94,00	F
ST1300 Pan European	2002-	KA-HNDST	CON O SENZA MANOPOLE RISCALDATE	€ 94,00	F
Stateline 1300	2010-	KA-TCH-0.8 oppure KA-TBH-0.8	MODELLI CON PARAMANI OEM E MANOPOLE RISCALDATE	€ 139,00	F
Varadero		KA-HNDVARAOXF	CON O SENZA MANOPOLE RISCALDATE OXFORD	€ 94,00	F
VFR1200 DCT Tour Edition	2018-	KA-HND310	MODELLI CON PARAMANI OEM E MANOPOLE RISCALDATE	€ 94,00	F
VFR1200 XDJ Cross Tourer Highlander	2018-	KA-HND310	MODELLI CON PARAMANI OEM E MANOPOLE RISCALDATE	€ 94,00	F
VFR1200F	2010-	KA-HND28	PER MODELLI CON TERMINALI 28MM	€ 94,00	F
VFR1200FD	2010-	KA-HND28	PER MODELLI CON TERMINALI 28MM	€ 94,00	F
VFR1200X	2012-2016	KA-HND200	CON O SENZA PARAMANI OEM	€ 94,00	F
VFR1200X Cross Tourer	2016-2017	KA-HND200	PER MODELLI CON PARAMANI OEM	€ 94,00	F
VFR1200XD	2012-2016	KA-HND200	CON O SENZA PARAMANI OEM	€ 94,00	F
VFR1200XD	2017	KA-HND310	MODELLI CON PARAMANI OEM E MANOPOLE RISCALDATE	€ 94,00	F
VFR1200XD	2017	KA-HND310	MODELLI CON PARAMANI OEM E MANOPOLE RISCALDATE	€ 94,00	F
VFR750 RC36	1993-1998	KA-HND305	MODELLI CON PARAMANI OEM E MANOPOLE RISCALDATE	€ 94,00	F
VFR800	2001-	KA-HND31	PER MODELLI CON TERMINALI 31MM	€ 94,00	F
VFR800X Cross Runner	2011-2014	KA-HND300	MODELLI CON PARAMANI OEM E MANOPOLE RISCALDATE	€ 94,00	F
VFR800X Cross Runner	2015-2018	KA-HND320	MODELLI CON PARAMANI OEM E MANOPOLE RISCALDATE	€ 94,00	F
VLX Deluxe VT600		KA-TCH-0.75 oppure KA-TBH-0.75	MODELLI CON PARAMANI OEM E MANOPOLE RISCALDATE	€ 139,00	F
VT1100 Shadow Spirit		KA-TCH-0.75 oppure KA-TBH-0.75	MODELLI CON PARAMANI OEM E MANOPOLE RISCALDATE	€ 139,00	F
VT1300		KA-TCH-0.8 oppure KA-TBH-0.8	MODELLI CON PARAMANI OEM E MANOPOLE RISCALDATE	€ 139,00	F
VT750 C2		KA-TCH-0.75 oppure KA-TBH-0.75	MODELLI CON PARAMANI OEM E MANOPOLE RISCALDATE	€ 139,00	F
VT750 C2B		KA-TCH-0.75 oppure KA-TBH-0.75	MODELLI CON PARAMANI OEM E MANOPOLE RISCALDATE	€ 139,00	F
VT750 S		KA-TCH-0.75 oppure KA-TBH-0.75	MODELLI CON PARAMANI OEM E MANOPOLE RISCALDATE	€ 139,00	F
VTR1000 Firestorm	1998-2008	KA-HND31	PER MODELLI CON TERMINALI 31MM	€ 94,00	F
VTX1300		KA-TCH-0.8 oppure KA-TBH-0.8	MODELLI CON PARAMANI OEM E MANOPOLE RISCALDATE	€ 139,00	F
VTX1800		KA-TCH-0.8 oppure KA-TBH-0.8	MODELLI CON PARAMANI OEM E MANOPOLE RISCALDATE	€ 139,00	F
X-ADV	2017-	KA-HND310	MODELLI CON PARAMANI OEM E MANOPOLE RISCALDATE	€ 94,00	F
X-ADV Hard Track	2017-	KA-HND310	MODELLI CON PARAMANI OEM E MANOPOLE RISCALDATE	€ 94,00	F
X-ADV Travel Edition	2017-	KA-HND310	MODELLI CON PARAMANI OEM E MANOPOLE RISCALDATE	€ 94,00	F
X-ADV X-End	2017-	KA-HND310	MODELLI CON PARAMANI OEM E MANOPOLE RISCALDATE	€ 94,00	F
XR650L		KA-KTMADXR	MODELLI CON PARAMANI OEM E MANOPOLE RISCALDATE	€ 96,00	F
HUSQVARNA					
Vitpilen 401	2018-	KA-KTM100	PER MODELLI SENZA PARAMANI	€ 94,00	F
Svartpilen 401	2018-	KA-KTM100	PER MODELLI SENZA PARAMANI	€ 94,00	F
Svartpilen 701	2019-	KA-KTM100	PER MODELLI SENZA PARAMANI	€ 94,00	F
TR650 Terra	2013	KA-HUS100	PER MODELLI CON PARAMANI BARKBUSTER	€ 94,00	F
HYOSUNG					
GV650 Aquila		KA-HYOS110		€ 85,00	F
GV250 Aquila		KA-HYOS110		€ 85,00	F
ST7		KA-HYOS110		€ 85,00	F
INDIAN					
Scout	2015-2017	KA-INDTB100 oppure KA-INDTC100		€ 139,00	F
Scout Sixty	2018	KA-INDTB110		€ 139,00	F
KAWASAKI					
650R		KA-KAW221	KAW200 PER I MODELLI CON PARAMANI	€ 94,00	F
EN650 Vulcan	2015-	KA-KAW221	KAW200 PER I MODELLI CON PARAMANI	€ 94,00	F

MODELLO	ANNI	CODICE	NOTE	PREZZO AL PUBBLICO (IVA ESCLUSA)	FASCIA
ER-5F		KA-KAW221	KAW200 PER I MODELLI CON PARAMANI	€ 94,00	F
ER-6F	-2017	KA-KAW221	KAW200 PER I MODELLI CON PARAMANI	€ 94,00	F
ER-6N		KA-KAW221	KAW200 PER I MODELLI CON PARAMANI	€ 94,00	F
GTR1400	2011-2017	KA-KAW221	CON MANOPOLE RISCALDATE	€ 94,00	F
GTR1400 Concours		KA-KAW221	CON MANOPOLE RISCALDATE	€ 94,00	F
KLR650	2008-2015	KA-KAW221	KAW200 PER I MODELLI CON PARAMANI	€ 94,00	F
KLR650	-2008	KA-UNIKIT17.4		€ 94,00	F
KLR650 ABS	-2017	KA-KAW221	KAW200 PER I MODELLI CON PARAMANI	€ 94,00	F
KLR650L		KA-KAW221	KAW200 PER I MODELLI CON PARAMANI	€ 94,00	F
Ninja 250		KA-KAW170		€ 98,00	F
Ninja 400	2018	KA-KAW221		€ 94,00	F
Ninja 636		KA-KAW400		€ 101,00	F
Ninja 650L		KA-KAW221	KAW200 PER I MODELLI CON PARAMANI	€ 94,00	F
Ninja ZX-10R	2013-2017	KA-KAW400		€ 101,00	F
Versys 1000	2012-	KA-KAW221	KAW200 PER I MODELLI CON PARAMANI	€ 94,00	F
Versys KLE650	-2019	KA-KAW221	KAW200 PER I MODELLI CON PARAMANI	€ 94,00	F
Versys KLE650Z	2019	KA-KAW221	KAW200 PER I MODELLI CON PARAMANI	€ 94,00	F
Vulcan 900 (Classic & Custom)		KA-TCK-0.75		€ 139,00	F
Vulcan Cruiser (Classic)		KA-TCK-0.75		€ 139,00	F
Vulcan S ABS	2015-	KA-KAW221	KAW200 PER I MODELLI CON PARAMANI	€ 94,00	F
Vulcan S Café	-2019	KA-KAW221	KAW200 PER I MODELLI CON PARAMANI	€ 94,00	F
Z1000	2010-2017	KA-KAW170		€ 98,00	F
Z1000	-2009	KA-KAW100		€ 94,00	F
Z1000SX	2012-2017	KA-KAW160		€ 99,00	F
Z250	2019-	KA-KAW200		€ 94,00	F
Z300	2016-	KA-KAW170		€ 98,00	F
Z400	2019-	KA-KAW200		€ 94,00	F
Z750R	-2009	KA-KAW100		€ 94,00	F
Z750S	-2009	KA-KAW100		€ 94,00	F
Z800	2013-2017	KA-KAW100		€ 94,00	F
Z900	2017	KA-KAW221	KAW200 PER I MODELLI CON PARAMANI	€ 94,00	F
Z900 RS	2018-	KA-KAW221	KAW200 PER I MODELLI CON PARAMANI	€ 94,00	F
Z900 RS Café	-2019	KA-KAW221	KAW200 PER I MODELLI CON PARAMANI	€ 94,00	F
ZR1000E Naked	2013	KA-KAW170		€ 98,00	F
ZR900	2017	KA-KAW221	KAW200 PER I MODELLI CON PARAMANI	€ 94,00	F
ZRX1200R		KA-KAW100		€ 94,00	F
ZX-10	2007-2010	KA-KAW400		€ 101,00	F
ZX-10R		KA-KAW400		€ 101,00	F
ZX-10RR		KA-KAW400		€ 101,00	F
ZX-12		KA-KAW221	KAW200 PER I MODELLI CON PARAMANI	€ 94,00	F
ZX130 Scooter		KA-KAW221	KAW200 PER I MODELLI CON PARAMANI	€ 94,00	F
ZX-14	-2012	KA-KAW221	KAW200 PER I MODELLI CON PARAMANI	€ 94,00	F
ZX-14R	2013-2017	KA-KAW221	KAW200 PER I MODELLI CON PARAMANI	€ 94,00	F
ZX-6	1991-1996	KA-KAW170		€ 98,00	F
ZX-6R	2016-	KA-KAW170		€ 98,00	F
ZX-7	1991-1996	KA-KAW170		€ 98,00	F
ZX-7R		KA-KAW400		€ 101,00	F
ZX-9		KA-KAW400		€ 101,00	F
ZX-9R	-1997	KA-KAW170		€ 98,00	F
ZZR1100		KA-KAW100		€ 94,00	F
ZZR1200		KA-KAW100		€ 94,00	F

MODELLO	ANNI	CODICE	NOTE	PREZZO AL PUBBLICO (IVA ESCLUSA)	FASCIA
ZZR1400		KA-KAW221	KAW200 PER I MODELLI CON PARAMANI	€ 94,00	F
ZZR1400SE		KA-KAW221	KAW200 PER I MODELLI CON PARAMANI	€ 94,00	F
KTM					
690		KA-KTMAD.BBEW	SOLO PER PARAMANI BARKBUSTERS	€ 139,00	F
690		KA-VIBRASTOP	PER PARAMANI OEM IN PLASTICA (RIDUCE LE VIBRAZIONI DEL MANUBRIO)	€ 139,00	F
690 Duke		KA-KTM100		€ 94,00	F
690 Duke R		KA-KTM100		€ 94,00	F
690 E		KA-KTMAD		€ 94,00	F
690 R		KA-KTM100		€ 94,00	F
690 SE		KA-KTMAD		€ 94,00	F
690 SM		KA-KTMAD		€ 94,00	F
690 SMC Supermoto		KA-KTM100		€ 94,00	F
790 Adventure	2019-	KA-KTMAD		€ 94,00	F
790 Adventure R	2019-	KA-KTMAD		€ 94,00	F
790 Duke	2018-	KA-KTM100		€ 94,00	F
950		KA-VIBRASTOP	PER PARAMANI OEM IN PLASTICA (RIDUCE LE VIBRAZIONI DEL MANUBRIO)	€ 139,00	F
950 SM		KA-KTM100		€ 94,00	F
950 SMR		KA-KTM100		€ 94,00	F
950 Super Enduro		KA-KTMAD		€ 94,00	F
950 Supermoto		KA-KTMAD		€ 94,00	F
990		KA-KTMAD.BBEW	SOLO PER PARAMANI BARKBUSTERS	€ 139,00	F
990		KA-VIBRASTOP	PER PARAMANI OEM IN PLASTICA (RIDUCE LE VIBRAZIONI DEL MANUBRIO)	€ 139,00	F
990 Adventure		KA-KTMAD		€ 94,00	F
990 Adventure Dakar		KA-KTMAD		€ 94,00	F
990 Adventure R		KA-KTMAD		€ 94,00	F
990 Adventure S		KA-KTMAD		€ 94,00	F
990 R		KA-KTM100		€ 94,00	F
990 SM		KA-KTM100		€ 94,00	F
990 SMR		KA-KTMAD		€ 94,00	F
990 SMT		KA-KTMAD		€ 94,00	F
990 SMT		KA-KTM100		€ 94,00	F
990 Super Duke		KA-KTM100		€ 94,00	F
990 Super Duke R		KA-KTM100		€ 94,00	F
990 T Supermoto		KA-KTM100		€ 94,00	F
1050 Adventure	2015-2018	KA-VIBRASTOP2	PER PARAMANI OEM IN PLASTICA (RIDUCE LE VIBRAZIONI DEL MANUBRIO)	€ 139,00	F
1050 Adventure	2015-	KA-KTMAD		€ 94,00	F
1090		KA-KTMAD.BBEW	SOLO PER PARAMANI BARKBUSTERS	€ 139,00	F
1090 Adventure		KA-KTMAD		€ 94,00	F
1090 Adventure R	-2017	KA-KTMAD		€ 94,00	F
1190		KA-KTMAD.BBEW	SOLO PER PARAMANI BARKBUSTERS	€ 139,00	F
1190 Adventure	2013-2018	KA-KTMAD		€ 94,00	F
1190 Adventure	2013-2018	KA-VIBRASTOP2	PER PARAMANI OEM IN PLASTICA (RIDUCE LE VIBRAZIONI DEL MANUBRIO)	€ 139,00	F
1190 RC8		KA-KTMRC		€ 94,00	F
1190 RC8R		KA-KTMRC		€ 94,00	F
1290 Adventure	-2018	KA-KTMAD.BBEW	SOLO PER PARAMANI BARKBUSTERS	€ 139,00	F
1290 Adventure	-2018	KA-VIBRASTOP2	PER PARAMANI OEM IN PLASTICA (RIDUCE LE VIBRAZIONI DEL MANUBRIO)	€ 139,00	F
1290 Adventure	-2018	KA-KTMAD		€ 94,00	F
1290 Super Adventure	2019-	KA-KTMAD		€ 94,00	F

MODELLO	ANNI	CODICE	NOTE	PREZZO AL PUBBLICO (IVA ESCLUSA)	FASCIA
1290 Super Duke	2014-	KA-KTM100		€ 94,00	F
1290 Super Duke R	2019-	KA-KTMAD		€ 94,00	F
LC4 640 Adventure		KA-KTMAD		€ 94,00	F
LC8 950 Adventure S		KA-KTMAD		€ 94,00	F
KYMCO					
XCITING 500	-2018	KA-KYM100C		€ 101,00	F
XCITING 500R	-2018	KA-KYM100B		€ 94,00	F
XCITING 500i	-2018	KA-KYM100C		€ 101,00	F
Peoples S200	-2018	KA-KYM100C		€ 101,00	F
VISAR 125		KA-KYM100B		€ 94,00	F
MOTO-GUZZI					
Bellagio 940	2011	KA-APR300C	NON ADATTO CON MANOPOLE RISCALDATE	€ 99,00	F
Breva 1100		KA-MOTOBRE	PER MODELLI SENZA PARAMANI	€ 94,00	F
Breva 1200		KA-MOTOBRE	PER MODELLI SENZA PARAMANI	€ 94,00	F
California Models	2007-2012	KA-GUZ100C-ST		€ 139,00	F
Griso 1200 SE	2013	KA-APR300C	NON ADATTO CON MANOPOLE RISCALDATE	€ 99,00	F
Griso 8V	2011-	KA-APR300C	NON ADATTO CON MANOPOLE RISCALDATE	€ 99,00	F
Norge 1100		KA-MOTOBRE	PER MODELLI SENZA PARAMANI	€ 94,00	F
Norge 1200		KA-MOTOBRE	PER MODELLI SENZA PARAMANI	€ 94,00	F
Norge 1200	2006-2007	KA-GUZ105		€ 94,00	F
Norge 1200 GT 8V	-2017	KA-STELHG	PER MODELLI CON PARAMANI OEM	€ 101,00	F
Norge 850		KA-STELHG	PER MODELLI CON PARAMANI OEM	€ 101,00	F
Norge GT 8V	2013-2016	KA-MOTOBRE	PER MODELLI SENZA PARAMANI	€ 94,00	F
Sport 1200 4VABS		KA-APR300	NON ADATTO CON MANOPOLE RISCALDATE	€ 94,00	F
Stelvio 1200		KA-APR300	NON ADATTO CON MANOPOLE RISCALDATE	€ 94,00	F
Stelvio 1200 GT 8V	-2017	KA-STELHG	PER MODELLI CON PARAMANI OEM	€ 101,00	F
Stelvio 1200 NTX		KA-STELHG	PER MODELLI CON PARAMANI OEM	€ 101,00	F
Stelvio NTX		KA-APR300	NON ADATTO CON MANOPOLE RISCALDATE	€ 94,00	F
V7 Ballagio 940	2012-	KA-V7100C		€ 101,00	F
V7 Racer	2012	KA-APR300C	NON ADATTO CON MANOPOLE RISCALDATE	€ 99,00	F
V7 Racer	2013-	KA-V7100C		€ 101,00	F
V7 Special	2013	KA-V7100C		€ 101,00	F
V7 Stone	2013-	KA-V7100		€ 94,00	F
V7 Stone II	2013-	KA-V7100		€ 94,00	F
V7 Stone III	2018	KA-V7100		€ 94,00	F
MV AGUSTA					
F4RR	2011-	KA-MV100		€ 94,00	F
Rivale 800cc	2013-	KA-MV105	PER MODELLI CON PARAMANI OEM	€ 94,00	F
Turismo Veloce	2015-	KA-MV105	PER MODELLI CON PARAMANI OEM	€ 94,00	F
PIAGGIO					
GTS300		KA-VESP100		€ 99,00	F
MP3 300 LT	2010	KA-PIA100		€ 85,00	F
MP3 400	2009	KA-PIA100		€ 85,00	F
Vespa GT 250		KA-VESP100		€ 99,00	F
ROYAL ENFIELD					
350cc Classic	2000-	KA-ENF100		€ 94,00	F
500cc Classic	2000-	KA-ENF100		€ 94,00	F
Thunderbird		KA-ENF100C		€ 94,00	F
SUZUKI					
400cc Burgman Limited Edition	2010-	KA-VS1000UWC		€ 99,00	F
650 Burgman	-2018	KA-SUZ400		€ 94,00	F

MODELLO	ANNI	CODICE	NOTE	PREZZO AL PUBBLICO (IVA ESCLUSA)	FASCIA
650 Burgman		KA-SUZ400-16.8	PER MODELLI CON MANUBRIO 16.8MM	€ 94,00	F
650 Burgman Deluxe	-2018	KA-SUZ400		€ 94,00	F
650 Burgman Executive	-2018	KA-SUZ400C		€ 99,00	F
B-King		KA-SUZ100		€ 101,00	F
Boulevard C109R	2008	KA-C109SNUB		€ 94,00	F
Boulevard C109R	2008	KA-SUZC109		€ 116,00	F
Boulevard C50		KA-SUZTC	TERMINALE MANUBRIO TORPEDO IN COLORE CROMATO	€ 139,00	F
Boulevard C90		KA-SUZTC	TERMINALE MANUBRIO TORPEDO IN COLORE CROMATO	€ 139,00	F
Boulevard M109R		KA-SUZM109SNUB		€ 94,00	F
Boulevard M109R		KA-SUZM109TC		€ 139,00	F
Boulevard M50		KA-SUZTC	TERMINALE MANUBRIO TORPEDO IN COLORE CROMATO	€ 139,00	F
Boulevard M90		KA-SUZM109SNUB		€ 94,00	F
Boulevard M90		KA-SUZM109TC		€ 139,00	F
Boulevard MB50		KA-SUZBBC	TERMINALE MANUBRIO A BARILOTTO IN COLORE CROMATO	€ 139,00	F
C1800RT		KA-C109SNUB		€ 94,00	F
C800C		KA-SUZTC	TERMINALE MANUBRIO TORPEDO IN COLORE CROMATO	€ 139,00	F
DL1000 V-Strom		KA-VS1000UW-S	PER MODELLI CON PARAMANI OEM	€ 97,00	F
DL1000 V-Strom		KA-VS1000UWPT	MODELLI CON MANUBRIO 14MM E CON PARAMANI OEM	€ 101,00	F
DL1000XT ABS	2018	KA-VS1000UW-S	PER MODELLI CON PARAMANI OEM	€ 97,00	F
DL650 V-Strom		KA-VS650W-S	PER MODELLI SENZA PARAMANI	€ 97,00	F
DL650 V-Strom		KA-VS650WPT	MODELLI CON MANUBRIO 14MM E SENZA PARAMANI OEM	€ 101,00	F
DL650 V-Strom		KA-VS1000UW-S	PER MODELLI CON PARAMANI OEM	€ 97,00	F
DL650 V-Strom		KA-VS1000UWPT	MODELLI CON MANUBRIO 14MM E CON PARAMANI OEM	€ 101,00	F
DL650XT	2017	KA-VS1000UW-S	PER MODELLI CON PARAMANI OEM	€ 97,00	F
DL650XT ABS	2018	KA-VS1000UW-S	PER MODELLI CON PARAMANI OEM	€ 97,00	F
DR650 SE		KA-VS650W-S	PER MODELLI SENZA PARAMANI	€ 97,00	F
DRZ400		KA-VS650W-S	PER MODELLI SENZA PARAMANI	€ 97,00	F
DRZ400 S		KA-VS650W-S	PER MODELLI SENZA PARAMANI	€ 97,00	F
Gladius 650	-2014	KA-SUZ100		€ 101,00	F
GSF1200		KA-SUZ100		€ 101,00	F
GSF1250	2015-	KA-SUZ100		€ 101,00	F
GSR600A		KA-SUZ100		€ 101,00	F
GSR650		KA-SUZ100		€ 101,00	F
GSR750		KA-SUZ100		€ 101,00	F
GSX1200		KA-SUZ100		€ 101,00	F
GSX1250A		KA-SUZ100		€ 101,00	F
GSX1250FA		KA-SUZ100		€ 101,00	F
GSX1250SA		KA-SUZ100		€ 101,00	F
GSX1300R Hayabusa	-2007	KA-SUZ200		€ 94,00	F
GSX1300R Hayabusa	2008-2014	KA-SUZ200-08		€ 94,00	F
GSX1400R Hayabusa	-2007	KA-SUZ200		€ 94,00	F
GSX600N		KA-SUZ100		€ 101,00	F
GSX600S		KA-SUZ100		€ 101,00	F
GSX650A		KA-SUZ100		€ 101,00	F
GSX650F		KA-SUZ100		€ 101,00	F
GSX650FA		KA-SUZ100		€ 101,00	F
GSX650N		KA-SUZ100		€ 101,00	F
GSX650S		KA-SUZ100		€ 101,00	F
GSX650SA		KA-SUZ100		€ 101,00	F
GSX-750		KA-SUZ100		€ 101,00	F
GSX-F650	2008-	KA-SUZ200		€ 94,00	F
GSX-F650 Katana		KA-SUZ200		€ 94,00	F

MODELLO	ANNI	CODICE	NOTE	PREZZO AL PUBBLICO (IVA ESCLUSA)	FASCIA
GSX-F750 Katana		KA-SUZ200		€ 94,00	F
GSXR1000	-2016	KA-SUZ100		€ 101,00	F
GSX-R1000	-2016	KA-SUZ100-16.8	PER MODELLI CON MANUBRIO 16.8MM	€ 101,00	F
GSX-R600	-2016	KA-SUZ100-16.8	PER MODELLI CON MANUBRIO 16.8MM	€ 101,00	F
GSX-R750	-2016	KA-SUZ100		€ 101,00	F
GSX-R750	-2016	KA-SUZ100-16.8	PER MODELLI CON MANUBRIO 16.8MM	€ 101,00	F
GSX-S1000FA	2016	KA-SUZ100		€ 101,00	F
GSX-S750F	2015-	KA-SUZ100		€ 101,00	F
GSX-S750Z	2017	KA-SUZ100		€ 101,00	F
Intruder C50		KA-SUZBBC	TERMINALE MANUBRIO A BARILOTTO IN COLORE CROMATO	€ 139,00	F
Intruder C90		KA-SUZBBC	TERMINALE MANUBRIO A BARILOTTO IN COLORE CROMATO	€ 139,00	F
Intruder VS800		KA-SUZTC	TERMINALE MANUBRIO TORPEDO IN COLORE CROMATO	€ 139,00	F
LC1500		KA-SUZTC	TERMINALE MANUBRIO TORPEDO IN COLORE CROMATO	€ 139,00	F
M1800R		KA-SUZM109SNUB		€ 94,00	F
M1800R		KA-SUZM109TC		€ 139,00	F
M800		KA-SUZTC	TERMINALE MANUBRIO TORPEDO IN COLORE CROMATO	€ 139,00	F
Marauder VZ1600		KA-SUZTC	TERMINALE MANUBRIO TORPEDO IN COLORE CROMATO	€ 139,00	F
MB850		KA-SUZBBC	TERMINALE MANUBRIO A BARILOTTO IN COLORE CROMATO	€ 139,00	F
SV1000N		KA-SUZ300		€ 94,00	F
SV1000S		KA-SUZ300		€ 94,00	F
SV650		KA-SUZ100		€ 101,00	F
TL1000R		KA-SUZ100		€ 101,00	F
TL1000S		KA-SUZ100		€ 101,00	F
VL800C		KA-SUZTC	TERMINALE MANUBRIO TORPEDO IN COLORE CROMATO	€ 139,00	F
VL800T		KA-SUZBBC	TERMINALE MANUBRIO A BARILOTTO IN COLORE CROMATO	€ 139,00	F
VLR1800T		KA-C109SNUB		€ 94,00	F
VLR1800T		KA-SUZC109		€ 116,00	F
VS800		KA-SUZBBC	TERMINALE MANUBRIO A BARILOTTO IN COLORE CROMATO	€ 139,00	F
VS800		KA-SUZBBC	TERMINALE MANUBRIO A BARILOTTO IN COLORE CROMATO	€ 139,00	F
VZ800L		KA-SUZBBC	TERMINALE MANUBRIO A BARILOTTO IN COLORE CROMATO	€ 139,00	F
TRIUMPH					
955		KA-SPTRIP		€ 94,00	F
Bonneville America	-2017	KA-BONI	SOLO MODELLI CON RUOTE A RAGGI	€ 85,00	F
Bonneville SE 900	-2014	KA-SCRAMCRG	SOLO CON SPECCHIETTI CRG	€ 99,00	F
Bonneville SE 900	-2014	KA-SCRAM	SOLO MODELLI CON CERCHI IN LEGA	€ 94,00	F
Bonneville Speedmaster	-2017	KA-BONI	SOLO MODELLI CON RUOTE A RAGGI	€ 85,00	F
Bonneville T100	-2017	KA-BONI	SOLO MODELLI CON RUOTE A RAGGI	€ 85,00	F
Bonneville T100	2017-2018	KA-BON120	SENZA SPECCHIETTI OEM	€ 94,00	F
Bonneville T120	2016-	KA-BON120	PER MODELLI SENZA PARAMANI	€ 94,00	F
Roadster	-2019	KA-TROCI		€ 99,00	F
Rocket 3	-2019	KA-TROCI		€ 99,00	F
Scrambler 900	-2017	KA-SCRAM		€ 94,00	F
Scrambler 900	-2017	KA-SCRAMCRG	SOLO CON SPECCHIETTI CRG	€ 99,00	F
Speed Triple	-2010	KA-SPTRIP		€ 94,00	F
Speed Triple 1050	2011-	KA-SPTRIP11		€ 94,00	F
Speed Triple 1050	2011-	KA-SPTRIP11CRG	SOLO CON SPECCHIETTI CRG	€ 101,00	F
Sprint GT 1050	-2017	KA-TST1050REV1		€ 94,00	F
Sprint RS 955		KA-TST1050REV1		€ 94,00	F
Sprint ST 1050		KA-TST1050REV1		€ 94,00	F
Sprint ST 955		KA-TST1050REV1		€ 94,00	F
Street Triple 675	-2010	KA-THRUX		€ 85,00	F
Street Triple 675R	-2010	KA-THRUX		€ 85,00	F

MODELLO	ANNI	CODICE	NOTE	PREZZO AL PUBBLICO (IVA ESCLUSA)	FASCIA
Thrupton 900		KA-THRUX		€ 85,00	F
Thunderbird	1995-2004	KA-TB900	CON TERMINALLI MANUBRIO OEM IN ACCIAIO INOX	€ 96,00	F
Thunderbird 1600	-2010	KA-TBIRD		€ 94,00	F
Thunderbird 1600	2011-	KA-TBIRDSS		€ 94,00	F
Thunderbird 1700LT	2013-	KA-TBIRDSS		€ 94,00	F
Thunderbird Commander 1700	2013-	KA-TBIRDSS		€ 94,00	F
Thunderbird Storm	2012-	KA-TBIRDSSB		€ 96,00	F
Thunderbird Storm	-2010	KA-TBIRDB		€ 94,00	F
Tiger 1050		KA-TIG1050	PER MODELLI CON O SENZA PARAMANI OEM	€ 94,00	F
Tiger 1200 Explorer	2013-2017	KA-TIG1200	PER MODELLI CON PARAMANI OEM	€ 101,00	F
Tiger 1200 Explorer XCX	2016-2017	KA-TIGXC	PER MODELLI CON PARAMANI OEM	€ 94,00	F
Tiger 800	1997	KA-TIG800		€ 101,00	F
Tiger 800	2011-2017	KA-TIGXC	PER MODELLI CON PARAMANI OEM	€ 94,00	F
Tiger 800XC	2011-2017	KA-TIGXC	PER MODELLI CON PARAMANI OEM	€ 94,00	F
Tiger 955i	2001-	KA-TIG995		€ 94,00	F
Tiger Sport	2013-	KA-TIG121		€ 101,00	F
Trophy 1200	2013-	KA-TST1050REV1		€ 94,00	F
URAL					
Ural	2000-2014	KA-URAL100	PER MODELLI CON TAPPI IN PLASTICA O SENZA TAPPI FINALI	€ 139,00	F
VICTORY					
Victory	2007	KA-HDTCV07-0.8	TERMINALE MANUBRIO TORPEDO IN COLORE CROMATO	€ 139,00	F
Victory	2008-	KA-HDTCV08-0.8	TERMINALE MANUBRIO TORPEDO IN COLORE CROMATO	€ 139,00	F
Victory	2008-	KA-HDBBCV08-0.8	TERMINALE MANUBRIO A BARILOTTO IN COLORE CROMATO	€ 139,00	F
YAMAHA					
FJ-09	2014-2017	KA-YAM650HG	NON ADATTO SENZA MANOPOLE RISCALDATE	€ 94,00	F
FJ-09	2014-2017	KA-YAM650	NON ADATTO CON MANOPOLE RISCALDATE - SOLO CON PARAMANI OEM	€ 94,00	F
FJR1300	-2018	KA-YAM500		€ 99,00	F
FJR1300 AS	-2018	KA-YAM500		€ 99,00	F
FZ-1	-2017	KA-YAM300S	FINITURA ARGENTO	€ 99,00	F
FZ-1	-2017	KA-YAM300	FINITURA NERA	€ 94,00	F
FZ-1 S	-2017	KA-YAM300S	FINITURA ARGENTO	€ 99,00	F
FZ-1 S	-2017	KA-YAM300	FINITURA NERA	€ 94,00	F
FZ6		KA-YAM300S	FINITURA ARGENTO	€ 99,00	F
FZ6		KA-YAM300	FINITURA NERA	€ 94,00	F
FZ-6R		KA-YAM300S	FINITURA ARGENTO	€ 99,00	F
FZ-6R	2015-	KA-YAM300	FINITURA NERA	€ 94,00	F
Majesty	2013-2014	KA-YAM810	PER MODELLI SENZA PARAMANI OEM	€ 94,00	F
Midnight Star		KA-YAMSTAR		€ 99,00	F
MT-01		KA-YAM300	FINITURA NERA	€ 94,00	F
MT-03	-2016	KA-YAM800		€ 94,00	F
MT-07 / FZ-07	2013-2017	KA-YAM810	PER MODELLI SENZA PARAMANI OEM	€ 94,00	F
MT-09 / FZ-09	-2018	KA-YAM810	PER MODELLI SENZA PARAMANI OEM	€ 94,00	F
MT-09 SP	2018	KA-YAM810	PER MODELLI SENZA PARAMANI OEM	€ 94,00	F
MT-09 Sport Tracker		KA-YAM810	PER MODELLI SENZA PARAMANI OEM	€ 94,00	F
MT-09 Sport Tracker ABS		KA-YAM810	PER MODELLI SENZA PARAMANI OEM	€ 94,00	F
MT-09 Street Rally	-2017	KA-YAM810	PER MODELLI SENZA PARAMANI OEM	€ 94,00	F
MT-10	2016-	KA-YAM810	PER MODELLI SENZA PARAMANI OEM	€ 94,00	F
MT-10	2017-	KA-YAM650HG	NON ADATTO SENZA MANOPOLE RISCALDATE	€ 94,00	F
Niken	2018-	KA-YAM810	PER MODELLI SENZA PARAMANI OEM	€ 94,00	F
R1	2004-	KA-YAM500		€ 99,00	F

MODELLO	ANNI	CODICE	NOTE	PREZZO AL PUBBLICO (IVA ESCLUSA)	FASCIA
R6		KA-YAM500		€ 99,00	F
Raider		KA-YAMLINER		€ 99,00	F
Roadliner		KA-YAMLINER		€ 99,00	F
Roadstar 1100	2004-	KA-YAMSTAR		€ 99,00	F
Roadstar 1300	2004-	KA-YAMSTAR		€ 99,00	F
Roadstar 1600	2004-	KA-YAMSTAR		€ 99,00	F
Roadstar 1700	2004-	KA-YAMSTAR		€ 99,00	F
Stratoliner		KA-YAMLINER		€ 99,00	F
Stryker 80 Star	2013-	KA-YAMSTAR		€ 99,00	F
Super Tenere XT1200Z	2010-2013	KA-YAM630	CON O SENZA PARAMANI OEM - ADATTO CON PARAMANI BARKBUSTERS	€ 94,00	F
TDM 850		KA-YAM300S	FINITURA ARGENTO	€ 99,00	F
TDM 850		KA-YAM300	FINITURA NERA	€ 94,00	F
TDM 900		KA-YAM300S	FINITURA ARGENTO	€ 99,00	F
TDM 900		KA-YAM300	FINITURA NERA	€ 94,00	F
Tenere XT 600Z	2008-2009	KA-YAM600	PER MODELLI SENZA PARAMANI	€ 94,00	F
Tenere XT 660Z	2008-2009	KA-YAM600	PER MODELLI SENZA PARAMANI	€ 94,00	F
Tenere XT 660Z	2008-	KA-YAM620	CON PARAMANI OEM O PARAMANI BARKBUSTER	€ 94,00	F
T-Max 500 Scooter	2010-	KA-YAMTMAX		€ 99,00	F
T-Max 530	2012-	KA-YAMTMAX		€ 99,00	F
Tracer MT-09	2014-2017	KA-YAM650	NON ADATTO CON MANOPOLE RISCALDATE - SOLO CON PARAMANI OEM	€ 94,00	F
Tracer MT-09	2014-2017	KA-YAM650HG	NON ADATTO SENZA MANOPOLE RISCALDATE	€ 94,00	F
V-Max	2009-2017	KA-YAM700		€ 94,00	F
V-Max 1200	1985-2007	KA-SUZ100		€ 101,00	F
V-Star 1100	2004-	KA-YAMSTAR		€ 99,00	F
V-Star 1300	2004-	KA-YAMSTAR		€ 99,00	F
V-Star 1600	2004-	KA-YAMSTAR		€ 99,00	F
V-Star 1700	2004-	KA-YAMSTAR		€ 99,00	F
V-Star XVS650 Classic	1997-	KA-YAMWARSNUB		€ 99,00	F
Warrior Cruiser	2008-	KA-YAMWARSNUB		€ 99,00	F
XJ1300		KA-YAM300S	FINITURA ARGENTO	€ 99,00	F
XJ1300		KA-YAM300	FINITURA NERA	€ 94,00	F
XJ6	2014-	KA-YAM300S	VERSIONE USA	€ 99,00	F
XJ6	2014-	KA-YAM300	VERSIONE USA	€ 94,00	F
XJ900		KA-YAM300S	FINITURA ARGENTO	€ 99,00	F
XJ900		KA-YAM300	FINITURA NERA	€ 94,00	F
XJR1200		KA-YAM300S	FINITURA ARGENTO	€ 99,00	F
XJR1200		KA-YAM300	FINITURA NERA	€ 94,00	F
XJR1300		KA-YAM300S	FINITURA ARGENTO	€ 99,00	F
XJR1300		KA-YAM300	FINITURA NERA	€ 94,00	F
XJR900		KA-YAM300S	FINITURA ARGENTO	€ 99,00	F
XJR900		KA-YAM300	FINITURA NERA	€ 94,00	F
XSR700	2019-	KA-YAM810	PER MODELLI SENZA PARAMANI OEM	€ 94,00	F
XSR900	2016-2017	KA-YAM810	PER MODELLI SENZA PARAMANI OEM	€ 94,00	F
XV1900 Midnight Star		KA-YAMLINER		€ 99,00	F
XV1900AT	2013-	KA-YAMLINER		€ 99,00	F
XVS1300A		KA-YAMSTAR		€ 99,00	F
XVS950A		KA-YAMSTAR		€ 99,00	F





nonoise™
HEARING PROTECTORS **MOTORSPORT**



**NONOISE PROTEGGE
IL VOSTRO UDITO**



FILTRO DI PRECISIONE

- Riducono il rumore del vento e della strada
- Consentono la comunicazione e l'uso dell'interfono
- Non interferiscono con la percezione dell'ambiente circostante
- Sono comodi, lavabili e riutilizzabili

LA PROTEZIONE IDEALE PER I MOTOCICLISTI E I PROFESSIONISTI DELLE DUE RUOTE

PERCHÉ UTILIZZARE GLI INSERTI AURICOLARI NONOISE?

Quando si va in moto, il livello di rumorosità del vento può raggiungere 105 dB e, quando si assiste a una gara motociclistica, si è esposti addirittura a 130 dB. Poiché 85 dB possono già causare danni permanenti all'udito, è essenziale utilizzare gli inserti auricolari.

PERCHÉ QUESTI INSERTI SONO DIVERSI DAGLI ALTRI?

Il frutto di venti anni di sviluppo da parte di esperti professionisti, gli inserti NoNoise MOTO sono migliori rispetto ai tradizionali tappi per le orecchie in schiuma, cera o silicone.

I filtri ceramici di precisione, coperti da brevetto, garantiscono la massima protezione in presenza di livelli di rumorosità pericolosi dovuti a motori, vento e rumori della strada. Il filtro, unico nel suo genere, permette di sentire voci, sirene e clacson in maniera chiara e non ovattata.

Comodi e adatti a ogni età - ideali per motociclisti e appassionati delle due ruote.

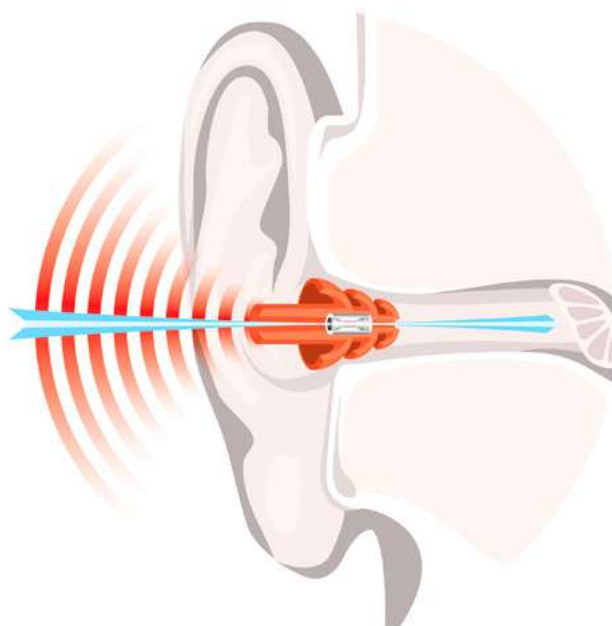

KIT 2 PZ. PROTEZIONI UDITO CON FILTRO CERAMICO
"NONOISE MOTOR"

NN004

FASCIA
C

€ 18,86







La collaborazione tra FORBIKES SRL e l'inglese R&G RACING è oramai attiva già da diversi anni.



La distribuzione in esclusiva per l'Italia delle rinomate protezioni motociclistiche decorre dal 2010 e ad oggi ha raggiunto ottimi traguardi sul mercato italiano. La R&G RACING è da tempo conosciuta e stimata nel mercato motociclistico, produce protezioni per la salvaguardia di ogni parte della moto, la gamma degli articoli spazia dalle protezioni salvatelaio (tamponi) alla protezione di scarichi, forcelle, forcellone, ammortizzatori, manubri, carter motore e molto altro.

Inizialmente impegnata a proteggere l'incolumità delle più aggressive supersportive, R&G vanta oggi una gamma di prodotti tale da interessare categorie come le Naked, Turismo, maxi enduro, maxi scooter e altro.

Gli articoli sono studiati e progettati dalla R&G racing parts nella sede dello Hampshire in Inghilterra e, severamente testati dai team locali sui circuiti di tutto il mondo. R&G RACING vanta un team di professionisti sempre pronti a realizzare le protezioni per gli ultimi modelli di moto uscenti sul mercato e per questo sempre aggiornati.

Tra le ultime novità gli accessori e le protezioni per Yamaha XTZ 700 TENERE



VEDI L'APPLICATIVO MOTO COMPLETO ALLA SEZIONE DOWNLOAD DEL SITO WWW.FORBIKES.IT

LEGENDA PRE-CODICI ARTICOLI PIÙ IMPORTANTI R&G RACING

AB	BARRE PARAMOTORE ADVENTURE BARS
AIC	COVER PRESE D'ARIA
BE	STABILIZZATORI / TAMPONI MANUBRIO
BLP	PLACCHETTE COPRI FORI POGGIAPIEDI POSTERIORI
BP	PIASTRA
BRG	RETINA PROTEZIONE RADIATORE CON LOGO
CG	PARACATENA
CHG	PROTEZIONE ANTERIORE TESTA CILINDRO
CP	TAMPONI / PROTEZIONI TELAIO
CR	NOTTOLINI CAVALLETTA POSTERIORE
DG	RETINA PROTEZIONE COLLETTORI SCARICO
DSP	KIT SCHERMO PROTEZIONE STRUMENTAZIONE
ECC	PROTEZIONI CARTER MOTORE - PEZZO SINGOLO
ECG	PROTEZIONE MOTORE
ECS	PROTEZIONI CARTER MOTORE "A SLITTA"
EH	STAFFA SUPPORTO SCARICO
EP	PROTEZIONE SILENZIATORE
ES	TAMPONI PROTEZIONE SILENZIATORE
EZBG	KIT ADESIVI ANTI-SCIVOLO PARATACCO / FORCELLONE / ECC...
EZRG	KIT ADESIVI ANTI-SCIVOLO SERBATOIO
FAP	ADATTATORI PER MINIFRECCHE ANTERIORI
FERG	ESTENSIONE PARAFANGO ANTERIORE
FI	INSERTO PROTEZIONE TELAIO
FP	PROTEZIONI PERNO FORCELLA ANTERIORE
FSK	PROTEZIONI TELAIO
FT	CORNICE PORTATARGA / PROTEZIONE CINGHIA
HLG	RETINA PROTEZIONE FANALE ANTERIORE
HLS	PROTEZIONE FANALE ANTERIORE
IAS	ADATTATORI PER MINIFRECCHE
IF	FASCIA STRUMENTAZIONE
ITB	NOTTOLINI CAVALLETTA
KEC	KIT PROTEZIONI CARTER MOTORE
LA	LUCE TARGA

LG	PROTEZIONE LEVA FRENO IN CARBONIO
LP	PORTATARGA
LPK	PIASTRINE UNIVERSALI MONTAGGIO / SUPPORTO TARGA
LS	TAMPONI FINE CORSA PER STERZO
MBP	PLACCHETTE COPRIFORI SPECCHIETTI
MLG	PROTEZIONE LEVA FRENO / FRIZIONE
MR	RISERS SPECCHIETTI
OCG	RETINA PROTEZIONE RADIATORE OLIO
PB	SUPPORTI PER CAVALLETTA CON PROTEZIONI
PKS	BASE APPOGGIO CAVALLETTA
RAD	RETINA PROTEZIONE RADIATORE ACQUA
RAINLIGHT	LUCE POSTERIORE PIOGGIA
REK	KIT ESTENSIONE SUPPORTO CATADIOTTRO
RG	MINIFRECCHE
RGH	PARAFANGO POSTERIORE
RIMTAPE	STRISCE PER CERCHI
RP	POGGIAPIEDE FISSO RACING
RS	TAMPONI PROTEZIONE RADIATORE
RSET	PEDANE ARRETRATE
SBP	PIASTRA CHIUSURA ASSE POSTERIORE
SC	PROTEZIONE AMMORTIZZATORE
SCG	RETINA PROTEZIONE RADIATORE OLIO ACCIAIO INOSSIDABILE
SHOCKTUBE	PROTEZIONE MONOAMMORTIZZATORE
SP	PROTEZIONI FORCELLONE
SRG	RETINA PROTEZIONE RADIATORE ACCIAIO INOSSIDABILE
SS	CURSORI PERNO RUOTA POSTERIORE
TG	PINNA SICUREZZA CATENA
TH	PIASTRA PER AGGANCIAMENTO CINGHIE
TLS	SLIDERS CODONE POSTERIORE IN CARBONIO
TP	PEDANE RACING
TS	SLIDERS SERBATOIO IN CARBONIO
UCP	TAMPONI TELAIO SOTTOCARENA
YTI	GIOGO TAPPO SUPERIORE

AB

BARRE PARAMOTORE ADVENTURE BARS



BE

STABILIZZATORI / TAMPONI MANUBRIO



BLP

PLACCHETTE COPRI FORI POGGIPIEDI POSTERIORI



BP

PIASTRA



BRG

RETINA PROTEZIONE RADIATORE CON LOGO



CG

PARACATENA



CHG

PROTEZIONE ANTERIORE TESTA CILINDRO



CP

TAMPONI / PROTEZIONI TELAI



CR

NOTTOLINI CAVALLETTO POSTERIORE



DG

RETINA PROTEZIONE COLLETTORI SCARICO



DSP

KIT SCHERMO PROTEZIONE STRUMENTAZIONE



ECC

PROTEZIONI CARTER MOTORE - PEZZO SINGOLO



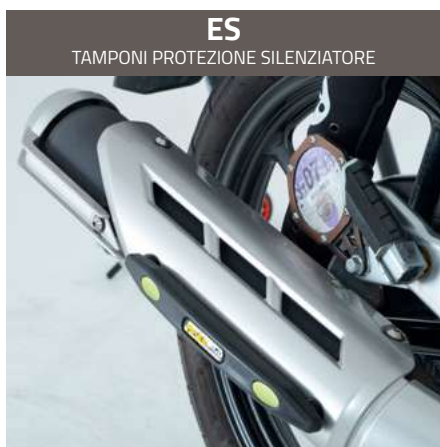
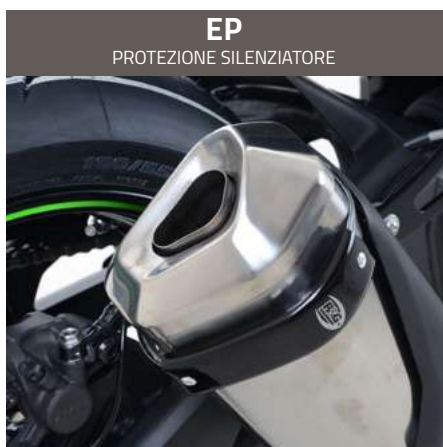
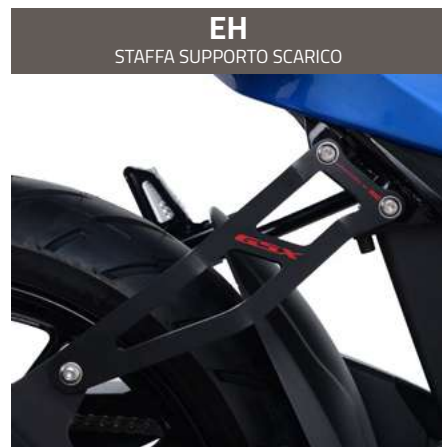

HLS

PROTEZIONE FANALE ANTERIORE



ITB

NOTTOLINI CAVALLETTO



KEC

KIT PROTEZIONI CARTER MOTORE



LA

LUCE TARGA



LG

PROTEZIONE LEVA FRENO IN CARBONIO



LP

PORTATARGA



LS

TAMPONI FINE CORSA PER STERZO



MBP

PLACCHETTE COPRIFORI SPECCHIETTI



MLG

PROTEZIONE LEVA FRENO / FRIZIONE



MR

RISERS SPECCHIETTI



OCG

RETINA PROTEZIONE RADIATORE OLIO



PB

SUPPORTI PER CAVALLETTO CON PROTEZIONI



PKS

BASE APPOGGIO CAVALLETTO



RAD

RETINA PROTEZIONE RADIATORE ACQUA



RAINLIGHT

LUCE POSTERIORE PIOGGIA



REK

KIT ESTENSIONE SUPPORTO CATADIOTTRO



RG

MINIFRECCHE



RGH

PARAFANGO POSTERIORE

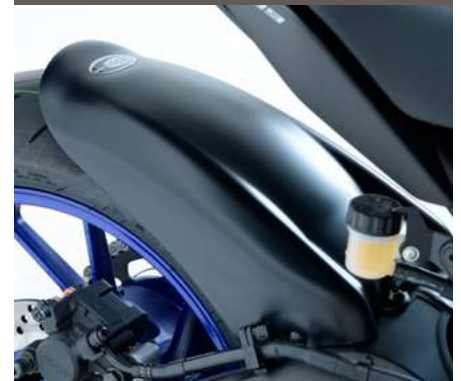

RIMTAPE

STRISCE PER CERCHI



RP

POGGIAPIEDE FISSO RACING



RS

TAMPONI PROTEZIONE RADIATORE



RSET

PEDANE ARRETRATE



SBP

PIASTRA CHIUSURA ASSE POSTERIORE



SC

PROTEZIONE AMMORTIZZATORE



SCG

RETINA PROTEZIONE RADIATORE OLIO ACCIAIO INOSSIDABILE



SHOCKTUBE

PROTEZIONE MONOAMMORTIZZATORE



SP

PROTEZIONI FORCELLONE



SRG

RETINA PROTEZIONE RADIATORE ACCIAIO INOSSIDABILE



SS

CURSORI PERNO RUOTA POSTERIORE



TG

PINNA SICUREZZA CATENA



TH

PIASTRA PER AGGANCIAMENTO CINGHIE



TLS

SLIDERS CODONE POSTERIORE IN CARBONIO



TP

PEDANE RACING



TS

SLIDERS SERBATOIO IN CARBONIO



UCP

TAMPONI TELAIO SOTTOCARENA



YTI

GIOGO TAPPO SUPERIORE





Via Agnoletti 4/F/G - 42124 Reggio Emilia - Tel. 0522 232590 - Fax: 0522 238020
E-mail: commerciale@forbikes.it - www.forbikes.it