



DISEGNI PASTIGLIE E LORO APPLICAZIONE PER MOTOCICLI

PAD DRAWINGS AND THEIR MOTORCYCLE APPLICATIONS

LISTE DES APPLICATIONS MOTOS ET CROQUIS

ZEICHNUNGEN DER BELAGEN UND ANWENDUNG FUER
MOTORRAEDER

DISEÑO DE PASTILLAS Y SU APLICACIÓN PARA MOTOCICLETAS

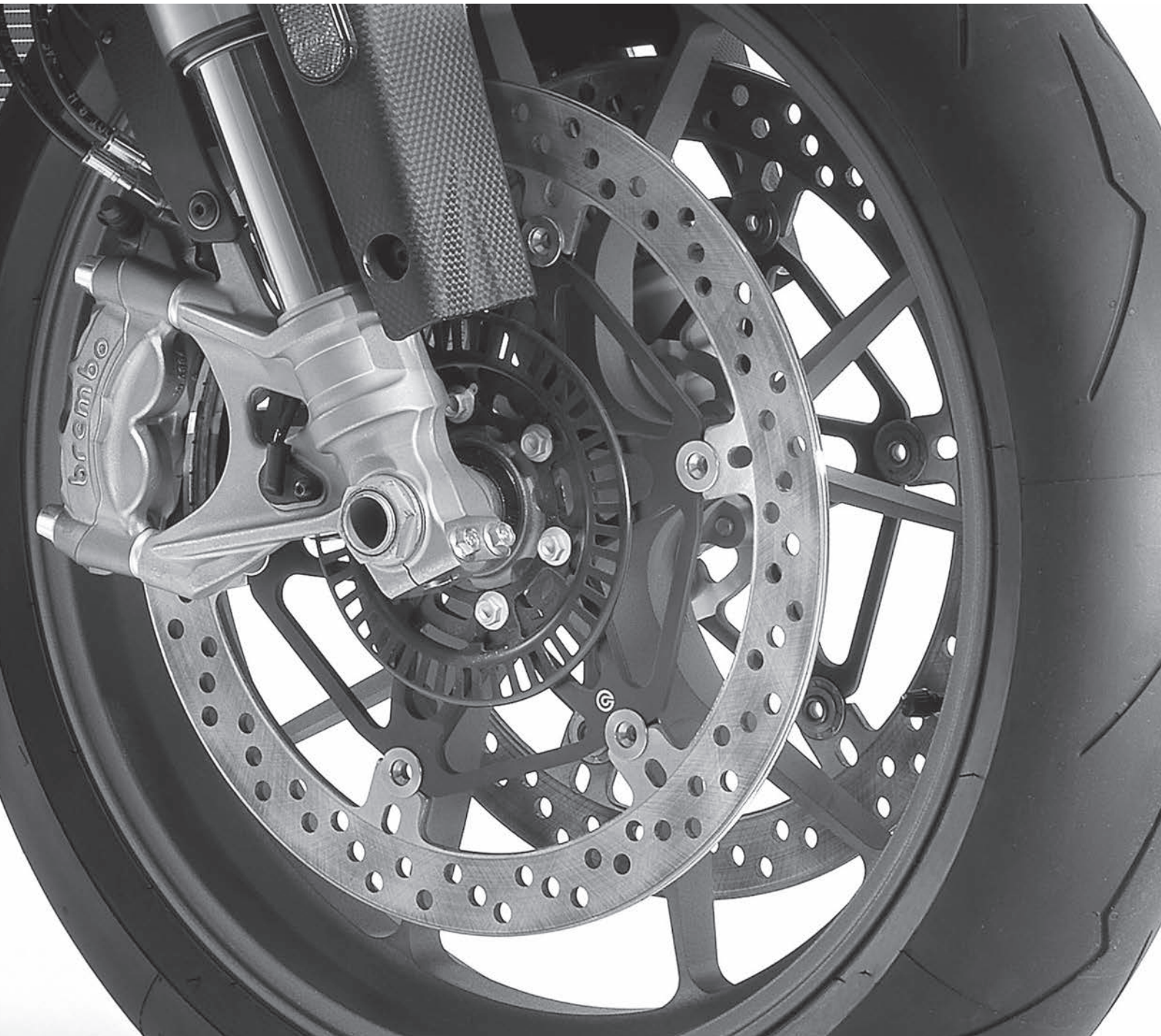



07BB01.06 39.8 x 56.2 x 6.8

07BB01.35 “ “ “
GENUINE

07BB01.SP “ “ “

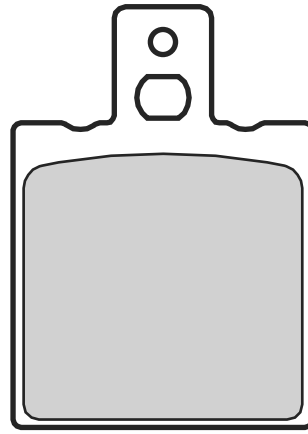

2



ALFER

250 MC 87 > 87 •

APRILIA

50 RS 93 > 95 •

50 RS 96 > 99 •

125 AF-1 EUROPA 89 > 91 •

125 AF-1 FUTURA 89 > 91 •

125 AF1 86 > 92 •

125 AF1 REPLICA, SINTESI 88 > 89 •

125 RS EXTREMA 93 > 98 •

125 RS REPLICA 93 > 97 •

125 TUAREG RALLY 89 > 89 •

125 TUAREG WIND 89 > 89 •

350 RALLY 86 > •

350 TUAREG 88 > •

350 TUAREG WIND 87 > 87 •

350 TUAREG WIND 88 > 89 •

ASPES

125 SINTESI 88 > •

BENELLI

125 2C SPORT 70 > 85 •

125 2C TURISMO 70 > 85 •

500 504 SPORT 76 > 86 •

650 654 83 > 85 •

650 654 SPORT 83 > 85 •

BIMOTA

400 YB 7 89 > •

600 BELLARIA 90 > •

600 YB 9 SR 97 > 04 •

600 YB 9 SRI 97 > 04 •

750 YB 4 88 > •

851 TESI 91 > •

900 DB2 93 > •

900 DB2 SR 94 > •

906 TESI 91 > •

1000 DB 1 87 > 90 •

1000 DB 1 91 > •

1000 DB 1 RS 87 > •

1000 FURANO 92 > •

1000 TESI 2D 04 > 06 •

1000 TUATARA 90 > •

1000 YB 6 87 > •

1000 YB 8 89 > •

1098 DB7 09 > •

1100 SB6 94 > 96 •

1200 YB 5 FS 87 > •

CAGIVA

50 COCIS 89 > • •

50 LUCKY EXPLORER 88 > 91 •

50 SUPER CITY 93 > 95 •

50 W4 92 > 94 •

80 COCIS 91 > •

80 W4 92 > •

125 CROSS 84 > 87 •

125 CRUISER 87 > •

125 ELEFANT 3 86 > 88 •

125 ENDURO 86 > •

125 FRECCIA C10 88 > 89 •

125 FRECCIA C10 89 > •

ANNIVERSARY

125 FRECCIA C12 89 > •

125 FRECCIA C9 88 > •

125 MITO 90 > 91 •

125 MITO 2 92 > 93 •

125 MITO 525 08 > 12 •

125 MITO EURO2 04 > 07 •

125 MITO EV 94 > 03 •

125 PLANET 98 > 00 •

125 RAPTOR 03 > 04 •

125 RAPTOR 05 > •

250 MXR 82 > •

250 SST 81 > •

250 SXT 83 > •

250 WMX GP 82 > •

350 ALA ROSSA 83 > •

350 ELEFANT 85 > 89 •

350 SST 80 > •

350 SXT 83 > •

350 T4 87 > •

350 T4 R 87 > •

500 MITO 07 > •

500 RIVER 99 > •

500 T4 E 87 > •

500 T4 R 87 > •

500 WMX 85 > 86 •

525 SP MITO 08 > •

600 RIVER 94 > •

650 ALA AZZURRA 85 > • •

650 ELEFANT 85 > 87 •

750 ELEFANT 87 > • •

DUCATI

350 XL 82 > •

400 MONSTER 400 00 > 02 •

500 PANTAH 77 > • •

600 PANTAH 81 > •

650 INDIANA 86 > •

695 MONSTER 695 07 > 08 •

748 748 00 > 02 •

748 748 BIPOSTO 98 > 98 •

748 748 BIPOSTO 99 > 99 •

748 748 R 00 > 00 •

748 748 R 01 > 02 •

748 748 S 00 > 02 •

748 748 SPS 98 > 99 •

750 PASO 87 > 88 •

851 851 89 > •

851 851 SP2 90 > •

851 851 SP3 91 > •

851 851 SUPERBIKE 91 > •

888 888 RACING 92 > •

900 SUPERSPORT 900 90 > 97 •

916 916 94 > 96 •

916 916 BIPOSTO SENNA 94 > 98 •

916 916 S 94 > 96 •

916 916 SP 94 > 96 •

916 916 SPS 97 > 98 •

996 996 99 > •

996 996 R 01 > •

996 996 S 00 > •

996 996 SPS 99 > •

996 996 SPS II 99 > •

996 996 SPS III 00 > •

996 MONSTER S4 R 03 > 03 •

998 998 02 > •

998 998 F.E. 04 > •

998 998 MATRIX 04 > •

998 998 R 02 > •



998 998 S 02 > •

FRIGERIO PUCH

125 F7 89 > •
 125 REPLAY 89 > •
 250 CROSS 84 > 85 •
 250 REPLAY 89 > •
 350 HV 70 > •

GILERA

125 CROSS 84 > 85 •
 125 MXR 90 > •
 125 RX 83 > •
 200 RX 85 > •
 250 ARIZONA RALLY 70 > •
 250 CROSS 83 > •
 250 NGR 85 > •

HONDA

125 NSR, F 88 > 89 •

HUSQVARNA

125 CR 84 > 86 •
 240 CR 84 > 85 •
 250 CR 84 > 86 •
 250 CX 84 > 85 •

KEEWAY

125 ENDURO 07 > •
 125 X-RAY 07 > •

KRAMIT

125 SCRAMBLER 70 > •

LAVERDA

125 LZ 82 > •
 125 LZ (CU) 85 > •
 125 SP 82 > •
 125 ST 82 > •
 350 350 77 > • •
 500 500 77 > • •
 600 ATLAS 86 > •

MOTO GUZZI

350 350 77 > • • •
 350 NTX 88 > 89 •
 350 NTX 90 > •
 350 V 35 84 > • •
 350 V 35 FLORIDA 87 > •
 350 V 35 II 84 > • •
 350 V 35 IMOLA 84 > • •
 350 V 35 POLIZIA 84 > • •
 350 V 35 TT 84 > • •
 500 V 50 C 80 > 90 • • •
 500 V 50 III 85 > • • •
 500 V 50 MONZA 84 > • • •
 500 V 50 POLIZIA 80 > 90 • • •
 650 NTX 87 > 90 •
 650 V 65 86 > •
 650 V 65 FLORIDA 87 > •
 650 V 65 LARIO 87 > •
 750 TARGA 89 > •

1000 DAYTONA 92 > 95 •
 1000 DAYTONA RACING 92 > 96 •
 1000 DAYTONA RS 97 > 98 •
 1000 V10 CENTAURO 97 > 99 •
 1000 V10 CENTAURO SPORT 98 > 99 •
 1100 CALIFORNIA EV TOURING 02 > 05 •
 1100 SPORT 94 > 96 •
 1100 SPORT CORSA 98 > 99 •
 1100 SPORT I.E. 96 > 99 •
 1100 V11 BALLABIO 03 > 05 •
 1100 V11 CAFE SPORT 03 > 05 •
 1100 V11 COPPA ITALIA 04 > 05 •
 1100 V11 LE MANS 01 > 02 •
 1100 V11 LE MANS 01 > •
 1100 V11 LE MANS 03 > 05 •
 1100 V11 NAKED 01 > •
 1100 V11 SCURA 02 > •
 1100 V11 SPORT 01 > 02 •
 1100 V11 SPORT ROSSO 01 > •

MOTO MORINI

350 DART 87 > 89 •
 350 EXCALIBUR 87 > 94 •
 400 DART 89 > 89 •
 400 DART 90 > •
 501 COGUARO 89 > •
 501 EXCALIBUR 89 > 89 •
 501 EXCALIBUR 90 > 94 •

SWM

500 4 T 70 > •



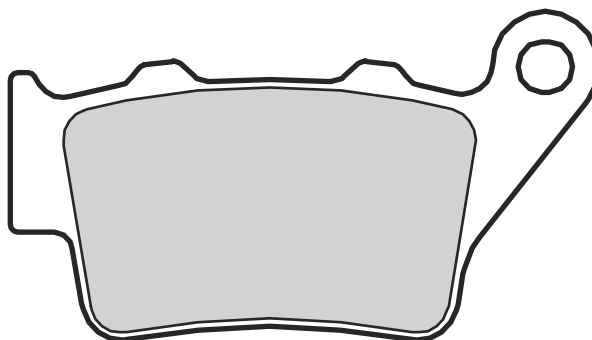
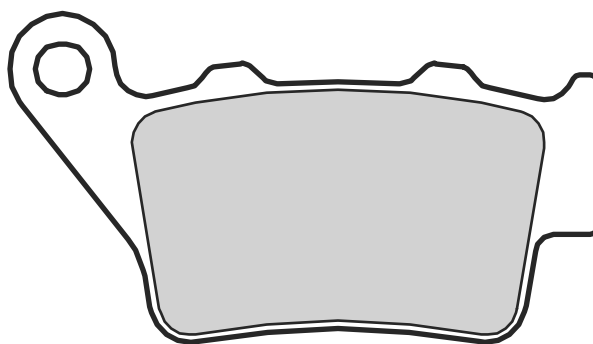

07BB02.35 GENUINE	77.9 x 41.2 x 9
07BB02.58 GENUINE	“ “ “
07BB02.65 GENUINE	“ “ “
07BB02.SP	“ “ “
07BB02.SD	“ “ “
07BB02.SX	“ “ “
07BB02.TT	“ “ “

**ALFER**

125 VRE - 4 STROKE	00 >	•
250 VR CROSS	99 >	•
250 VR ENDURO	99 >	•
250 VR NO LIMIT	99 >	•
250 VR SUPERMOTARD	99 >	•

APRILIA

650 PEGASO	04 >	•
650 PEGASO I.E.	01 > 04	•
650 PEGASO STRADA	05 >	•
650 PEGASO TRAIL	06 >	•
660 PEGASO FACTORY	05 >	•
750 DORSODURO	09 > 16	•
750 DORSODURO ABS	09 > 16	•
750 DORSODURO FACTORY	11 > 16	•
750 SHIVER	07 > 16	•
750 SHIVER	09 >	•
750 SHIVER ABS	09 >	•
750 SHIVER GT	09 > 16	•
750 SHIVER GT ABS	09 > 16	•
750 SHIVER SL	07 > 16	•
750 SMV DORSODURO	08 > 08	•
750 SMV DORSODURO	09 >	•
850 MANA	07 > 07	•

900 DORSODURO	17 >	•
900 SHIVER	17 >	•
1200 CAPONORD	13 > 16	•
1200 CAPONORD ABS	14 > 16	•
1200 CAPONORD TP	14 >	•
1200 CAPONORD TRAVEL PACK	14 > 16	•
1200 DORSODURO	12 > 15	•
1200 DORSODURO ABS	14 > 15	•

BENELLI

449 BX CROSS	07 > 12	•
449 BX SUPERMOTARD	08 > 12	•
505 ENDURO	08 >	•

BETA

125 JONATHAN	99 >	•
350 EURO	99 >	•
350 JONATHAN	02 >	•

BMW

313 G 310 R	16 >	•
400 C 400 X	18 >	•
650 F 650 CS	02 > 06	•
650 F 650 CS SCARVER	01 > 06	•

650 F 650 GS	00 > 06	•
650 F 650 GS ABS	05 > 05	•
650 F 650 GS DAKAR	00 > 06	•
650 F 650 GS RALLY	00 > 06	•
650 F 650 ST	93 > 00	•
650 G 650 GS	09 > 16	•
650 G 650 XCHALLENGE	07 > 12	•
650 G 650 XCOUNTRY	07 > 12	•
650 G 650 XMOTO	07 > 12	•
650 GS 650 SERTA0	12 >	•
700 F 700 GS	13 >	•
750 F 750 GS	18 >	•
800 F 650 GS	08 > 12	•
800 F 700 GS	16 >	•
800 F 800 GS	08 >	•
800 F 800 GS ADVENTURE	14 >	•
800 F 800 GT	13 >	•
800 F 800 R	09 > 14	•
800 F 800 R	15 >	•
800 F 800 S	06 > 12	•
800 F 800 ST	06 > 12	•
800 F 800 ST TOURING	11 > 12	•
850 F 850 GS	18 >	•
850 F 850 GS ADVENTURE	18 >	•
1000 S 1000 R	13 >	•
1000 S 1000 R ABS	14 >	•



1000 S 1000 RR	09 >	•
1000 S 1000 RR HP4	12 > 14	•

CCM

600 RS	01 >	•
600 SPORT	99 >	•
600 SUPERMOTO	99 >	•
644 DS	02 >	•
644 R30	02 >	•

CF MOTO

400 NK EFI	17 >	•
650 NK EFI	17 >	•

DUCATI

400 SCRAMBLER SIXTY2	16 >	•
797 MONSTER	17 >	•
797 MONSTER 797+	17 >	•
803 SCRAMBLER CAFE' RACER	17 >	•
803 SCRAMBLER CLASSIC	15 >	•
803 SCRAMBLER DESERT SLED	17 >	•
803 SCRAMBLER FLAT TRACK	16 >	•
803 SCRAMBLER FULL THROTTLE	15 >	•
803 SCRAMBLER ICON	15 >	•
803 SCRAMBLER ITALIAN INDEPENDENT	16 >	•
803 SCRAMBLER MATCH 2.0	18 >	•
803 SCRAMBLER URBAN ENDURO	15 >	•
1000 GT 1000	07 > 10	•
1000 GT 1000 TOURING	09 >	•
1000 PAUL SMART 1000 L.E.	05 >	•
1000 SPORT 1000	05 > 06	•
1000 SPORT 1000 (BIPOSTO)	07 >	•
1000 SPORT 1000 (MONOPOSTO)	07 >	•
1000 SPORT 1000 S	07 > 09	•
1000 SPORT BIPOSTO	07 >	•
1100 SCRAMBLER	18 >	•
1100 SCRAMBLER SPECIAL	18 >	•
1100 SCRAMBLER SPORT	18 >	•

FANTIC MOTOR

500 CABALLERO	17 >	•
---------------	------	---

GAS GAS

125 EC	97 > 99	•
200 EC	99 > 99	•
250 EC	97 > 99	•
250 MC	97 > 99	•
300 EC	99 > 99	•

HIGHLAND

450 MX	06 >	•
950 V2	99 >	•

HONDA

500 CB	97 >	•
500 CB S	98 >	•
650 NX DOMINATOR	97 > 99	•
650 SLR	97 >	•
650 VIGOR FX	99 > 02	•

HRD

50 GS ENDURO	00 >	•
--------------	------	---

HUSABERG

400 FC	99 >	•
400 FE	99 >	•
400 FS SUPERMOTARD	01 >	•
450 FC	03 > 09	•
450 FC (CROSS)	05 > 09	•
450 FE (ENDURO)	05 > 09	•
450 FE E	04 > 09	•
450 FSC SUPERMOTARD	03 > 09	•
450 FSE SUPERMOTARD	03 > 09	•
450 FX	03 > 09	•
470 FC	01 > 02	•
470 FX	01 > 02	•
550 FC	01 > 08	•
550 FC (CROSS)	05 > 08	•
550 FE (ENDURO)	05 > 08	•
550 FE E	04 > 08	•
600 FC	99 >	•
600 FE	99 >	•
650 FE (ENDURO)	05 > 08	•
650 FSC SUPERMOTARD	01 > 08	•
650 FSE SUPERMOTARD	01 > 08	•
650 FX	01 > 08	•

HUSQVARNA

125 CR	95 > 98	•
125 CR	99 > 02	•
125 CR	03 > 04	•
125 SM	98 > 99	•
125 SM S	09 > 13	•
125 SM S 4T	11 > 13	•
125 SMS	00 > 01	•
125 SMS	05 > 13	•
125 WR	95 > 97	•
125 WR	98 > 02	•
125 WR	03 > 04	•
125 WR E	94 > 05	•
125 WR E	06 > 13	•
250 CR	95 > 98	•
250 CR	99 > 04	•
250 TC	02 > 03	•
250 TE	03 > 13	•
250 WR	95 > 97	•
250 WR	98 > 00	•
250 WR	01 >	•
350 TE	95 >	•
360 WR	95 > 98	•
360 WR	98 >	•
400 SM R	02 >	•
400 TE	01 >	•
401 SVARTPILEN	17 >	•
401 VITPILEN	17 >	•
410 TE	95 > 98	•

410 TE	99 > 00	•
410 TE E	00 > 01	•
449 TE 449	02 > 05	•
450 SMR	03 > 04	•
450 SMR	05 > 05	•
450 TC	03 > 03	•
510 SMR	05 > 05	•
510 TC	02 > 04	•
510 TE 511	05 > 05	•
510 TE R	04 >	•
570 NOX	01 > 03	•
570 R	01 >	•
570 SMR	01 > 04	•
570 SMR R	04 > 04	•
570 TC	02 > 04	•
570 TE	01 > 04	•
610 LT	00 >	•
610 SM	98 > 99	•
610 SM	05 > 09	•
610 SMS	00 > 04	•
610 SMS	06 > 09	•
610 TC	96 > 97	•
610 TC	98 > 98	•
610 TC	99 > 00	•
610 TE	96 > 97	•
610 TE	98 > 98	•
610 TE	99 > 00	•
610 TE E	98 > 04	•
610 TE E DUAL PURPOSE	06 >	•
610 TE E LT	99 > 99	•
610 TE E LT	00 >	•
630 SMR	04 >	•
630 SMS	10 >	•
630 TE	10 >	•
650 TR STRADA	13 > 14	•
650 TR TERRA	13 > 14	•
690 VITPILEN 701	18 >	•
701 ENDURO	17 >	•
701 SUPERMOTO	15 >	•
900 NUDA	12 > 14	•
900 NUDA ABS	12 > 14	•
900 NUDA R	12 > 14	•

HYOSUNG

450 RX SM	08 >	•
-----------	------	---

INDIAN

1000 SCOUT SIXTY	17 >	•
1200 SCOUT	17 > 18	•
1200 SCOUT	17 >	•

KRAMIT

250 GS	97 >	•
250 MX	97 >	•
250 SM	97 >	•
250 SMR	00 >	•

KTM

125 DUKE	11 > 14	•
125 EGS	94 > 98	•
125 EGS	99 >	•
125 EXC	94 > 97	•
125 EXC	98 > 98	•





125 EXC	99 > 00	•
125 EXC	01 > 03	•
125 EXE	00 > 01	•
125 LC2	96 > 98	•
125 RC	14 >	•
125 STING	99 >	•
125 SUPERMOTO	00 > 01	•
125 SX	94 > 97	•
125 SX	98 > 98	•
125 SX	99 > 00	•
125 SX	01 > 03	•
125 SXS	01 > 02	•
200 DUKE	12 > 14	•
200 EGS	98 > 98	•
200 EGS	99 >	•
200 EXC	98 > 98	•
200 EXC	99 > 00	•
200 EXC	01 > 03	•
200 MXC	98 > 00	•
200 MXC	01 > 03	•
200 RC	14 >	•
250 EGS	94 > 98	•
250 EGS	99 >	•
250 EXC	94 > 98	•
250 EXC	99 > 00	•
250 EXC	01 > 03	•
250 EXC RACING	03 > 04	•
250 GS	94 >	• •
250 MXC	00 > 00	•
250 MXC	01 >	•
250 SX	94 > 98	•
250 SX	99 > 00	•
250 SX	01 > 02	•
250 SXS	01 >	•
300 EGS	94 > 98	•
300 EGS	99 >	•
300 EXC	94 > 98	•
300 EXC	99 > 00	•
300 EXC	01 > 03	•
300 MXC	97 > 98	•
300 MXC	99 > 00	•
300 MXC	01 > 03	•
300 SX	94 > 05	•
350 EXC	94 >	•
360 EGS	96 > 97	•
360 EXC	96 > 97	•
360 MXC	97 >	•
360 SX	96 > 97	•
380 EGS	98 >	•
380 EXC	98 > 02	•
380 MXC	98 >	•
380 SX	98 > 02	•
390 DUKE	13 > 14	•
390 RC	14 >	•
400 DUKE	94 > 95	•
400 EGS	94 > 97	•
400 EXC	94 > 96	•
400 EXC	00 > 02	•
400 LC4	98 > 01	•
400 MXC	02 >	•
400 SUPERMOTO	01 >	•
400 SX	98 > 02	•
400 SXC	97 >	•
440 SX	94 >	•

450 EXC	03 > 03	•
450 MXC	03 >	•
450 RALLY	11 >	•
450 SX	03 > 03	•
520 EXC	01 > 02	•
520 MXC	01 > 02	•
520 SX	00 > 00	•
520 SX	01 > 02	•
525 EXC	03 > 03	•
525 MXC	03 >	•
525 SX	03 > 03	•
540 SXC	99 >	•
540 SXS	01 > 02	•
550 MXC	96 >	•
620 ADVENTURE	97 >	•
620 DUKE 4T	94 > 97	•
620 EGS	94 > 97	•
620 EXC	94 >	•
620 LC4	98 > 99	•
620 LC4 RALLY DAKAR	97 >	•
620 SC	01 >	•
620 SUPERMOTO	01 >	•
620 SX	94 > 98	•
620 SX	99 >	•
620 SXC	97 >	•
625 SC	02 >	•
625 SMC	05 >	•
625 SUPERMOTO	02 >	•
625 SXC	03 >	•
640 ADVENTURE TRAVELLER'S EDITION	07 >	•
640 DUKE	98 >	•
640 DUKE II	99 > 04	•
640 DUKE II	05 > 07	•
640 LC4	98 > 04	•
640 LC4	05 > 06	•
640 LC4 ADVENTURE	98 > 02	•
640 LC4 ADVENTURE	03 > 04	•
640 LC4 ADVENTURE	05 > 06	•
640 LC4 ENDURO	03 > 05	•
640 LC4 ENDURO	06 >	•
640 LC4 RALLY DAKAR	97 >	•
640 LC4 SUPERMOTO	00 > 02	•
640 LC4 SUPERMOTO	03 > 04	•
640 LC4 SUPERMOTO	05 > 06	•
660 LC4 RALLY	99 > 02	•
660 LC4 RALLY DAKAR	97 >	•
660 RALLYE FACTORY REPLICA	03 > 07	•
660 SM FACTORY	02 >	•
660 SM FACTORY REPLICA	03 >	•
660 SMC	03 > 03	•
660 SMC	06 >	•
660 SMS	07 >	•
690 DUKE	08 > 11	•
690 DUKE	15 >	•
690 DUKE ABS	12 >	•
690 DUKE R	10 > 11	•
690 DUKE R	14 >	•
690 ENDURO R	14 >	•
690 LC4 690 ENDURO	08 >	•
690 LC4 690 ENDURO R	09 >	•
690 SM PRESTIGE	07 >	•
690 SMC	08 >	•

690 SMC R	14 >	•
690 SUPERMOTO	07 >	•
790 DUKE	18 >	•
950 DUKE	03 >	•
950 RALLYE	02 >	•
990 SUPER DUKE	05 >	•
990 SUPERDUKE R	07 >	•

MAICO

250 CROSS	99 >	•
250 ENDURO	99 >	•
500 CROSS	99 >	•
500 ENDURO	99 >	•
500 SUPERMOTARD	99 >	•

ROYAL ENFIELD

535 CONTINENTAL GT	14 >	•
--------------------	------	---

SWM

600 SUPERDUAL	15 >	•
600 SUPERDUAL GT PACK	18 >	•
600 SUPERDUAL T	18 >	•
600 SUPERDUAL X	18 >	•

SYM

125 FRIDDLE III	18 >	•
400 MAXSYM	11 >	•

TM

80 CROSS	96 >	•
125 125	96 > 00	•
125 CROSS	91 >	•
250 E	95 > 00	•
250 E 4-STROKE	00 >	•
300 300	98 > 00	•
320 320	96 >	•
400 4T	00 > 00	•
530 SMM BLACK DREAM	04 >	•

TRIUMPH

660 STREET TRIPLE S	17 >	•
675 DAYTONA R	13 > 16	•
675 DAYTONA R TRIPLE	13 > 16	•
675 DAYTONA TRIPLE	13 >	•
675 STREET TRIPLE RX	15 > 16	•
765 STREET TRIPLE R	17 >	•
765 STREET TRIPLE R LOW	17 > 18	•
765 STREET TRIPLE RS	17 >	•
765 STREET TRIPLE S	17 >	•

VERTEMATI

500 CROSS	02 >	•
501 ENDURO	02 >	•
501 SUPERMOTARD	02 >	•

VICTORY

1200 OCTANE	17 >	•
-------------	------	---

VOR

400 CROSS	00 > 01	•
-----------	---------	---



400 EN	02 >	•
400 MX	02 >	•
400 SM	02 >	•
450 EN	02 >	•
450 MX	02 >	•
450 SM	02 >	•
500 CROSS 495	99 >	•
500 ENDURO 492	99 >	•
500 SUPERMOTARD (492)	00 > 01	•
530 EN	02 >	•
530 MX	02 >	•
530 SM	02 >	•



YAMAHA

125 WR R, XY	09 >	•
125 YBR	06 > 07	•
600 TT 600	97 >	•
600 TT 600 R	97 >	•
660 MT 03	06 > 15	•
660 XT R	04 > 13	•
660 XT X	04 >	•
660 XTZ TENERE' ABS	11 >	•
660 XTZ TENERE'	08 > 13	•

ZERO

2.8 ZF FX	14 > 14	•
-----------	---------	---



2.8 ZF FX	15 >	•
5.7 ZF FX	14 > 14	•
5.7 ZF FX	15 > 15	•
8.5 ZF DS	14 > 14	•
8.5 ZF S	14 > 14	•
9.4 ZF DS	15 >	•
9.4 ZF S	15 >	•
11.4 ZF DS	14 > 14	•
11.4 ZF S	14 > 14	•
11.4 ZF SR	14 > 14	•
12.5 ZF DS	15 >	•
12.5 ZF S	15 >	•
12.5 ZF SR	15 >	•





2

07BB03.06	108.5 x 40.1 x 7.6
07BB03.35 GENUINE	“ “ “
07BB03.3A GENUINE	“ “ “
07BB03.59 GENUINE	“ “ “
07BB03.90 GENUINE	“ “ “
07BB03.SA	“ “ “
07BB03.LA	“ “ “
07BB03.SP	“ “ “

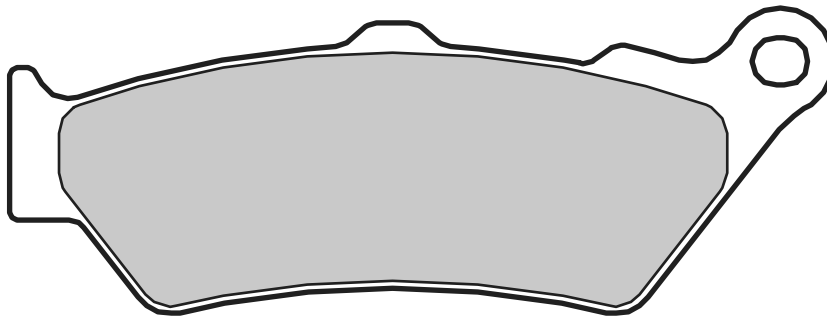
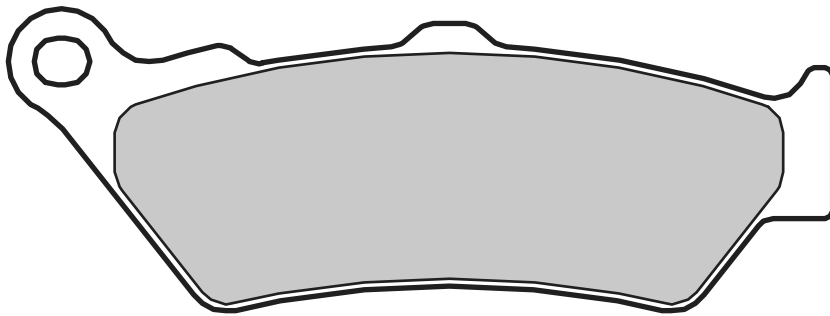

APRILIA

650 MOTÒ	95 >	•
650 PEGASO	97 > 03	•
650 PEGASO	04 >	•
650 PEGASO I.E.	01 > 04	•
650 PEGASO TRAIL	06 >	•
650 STARCK	96 >	•
1000 ETV CAPO NORD	01 > 03	•
1000 ETV CAPO NORD ABS	04 >	•
1000 ETV CAPO NORD RALLY RAID	04 >	•

BENELLI

500 LEONCINO TRAIL	18 >	•
--------------------	------	---

BIMOTA

1100 DBX	13 >	•
----------	------	---

BMW

650 F 650 CS	02 > 06	•
650 F 650 CS SCARVER	01 > 06	•
650 F 650 GS	00 > 06	•
650 F 650 GS ABS	05 > 05	•
650 F 650 GS DAKAR	00 > 06	•

650 F 650 GS RALLY	00 > 06	•
650 F 650 ST	93 > 00	•
650 G 650 GS	09 > 16	•
650 G 650 XCHALLENGE	07 > 12	•
650 G 650 XCOUNTRY	07 > 12	•
650 GS 650 SERTAO	12 >	•
700 F 700 GS	13 >	•
750 F 750 GS	18 >	•
800 F 650 GS	08 > 12	•
800 F 700 GS	16 >	•
800 F 800 GS	08 >	•
800 F 800 GS ADVENTURE	14 >	•
850 F 850 GS	18 >	•





850 F 850 GS ADVENTURE	18 >	•
1200 HP2 ENDURO	06 > 09	•
1200 R 1200 GS	13 >	•
1200 R 1200 GS ADVENTURE	14 >	•
1200 R 1200 R	15 >	•
1200 R 1200 RS	15 >	•
1200 R 1200 RT	14 >	•
1600 K 1600 B	17 >	•
1600 K 1600 GRAND AMERICA	18 >	•
1600 K 1600 GT	11 >	•
1600 K 1600 GTL	11 >	•

CF MOTO

400 NK EFI	17 >	•
650 NK EFI	17 >	•

DUCATI

400 SCRAMBLER	15 >	•
400 SCRAMBLER SIXTY2	16 >	•
1000 GT 1000	07 > 10	•
1000 GT 1000 TOURING	09 >	•
1000 PAUL SMART 1000 L.E.	05 >	•
1000 SPORT 1000	05 > 06	•
1000 SPORT 1000 (BIPOSTO)	07 >	•
1000 SPORT 1000 (MONOPOSTO)	07 >	•
1000 SPORT 1000 S	07 > 09	•
1000 SPORT BIPOSTO	07 >	•
1200 DIAVEL	11 >	•
1200 DIAVEL CARBON	14 >	•
1200 DIAVEL DARK	14 >	•
1200 DIAVEL STRADA	13 >	•

HARLEY DAVIDSON

750 STREET DARK CUSTOM	16 >	•
------------------------	------	---

HONDA

500 CB	97 >	•
500 CB S	98 >	•
650 NTV DEAUVILLE	98 > 00	•
650 NTV DEAUVILLE	01 > 02	•
650 NX DOMINATOR	97 > 99	•
650 VIGOR FX	99 > 02	•

HUSQVARNA

650 TR STRADA	13 > 14	•
650 TR TERRA	13 > 14	•
701 ENDURO	17 >	•

INDIAN

1000 SCOUT SIXTY	17 >	•
1200 SCOUT	17 >	•

KTM

450 RALLY	11 >	•
ADVENTURE		
640 TRAVELLER'S EDITION	07 >	•
640 LC4 ADVENTURE	05 > 06	•
690 ENDURO R	14 >	•
690 LC4 690 ENDURO	08 >	•
690 LC4 690 ENDURO R	09 >	•
950 ADVENTURE S	03 >	•
950 LC8 ADVENTURE	03 >	•
950 SUPER ENDURO	07 >	•
950 SUPERENDURO R	06 > 10	•
990 ADVENTURE	06 >	•
990 ADVENTURE ABS	06 >	•
990 ADVENTURE R	10 > 12	•
990 ADVENTURE S	06 >	•

MOTO GUZZI

940 BELLAGIO	07 > 13	•
1100 CALIFORNIA ALUMINIUM	03 >	•
1100 CALIFORNIA CLASSIC	06 >	•
1100 CALIFORNIA EV	01 >	•
1100 CALIFORNIA EV SPORT	01 > 02	•
1100 CALIFORNIA EV TOURING	97 > 00	•
1100 CALIFORNIA EV TOURING	03 > 05	•
1100 CALIFORNIA JACKAL	99 > 01	•
1100 CALIFORNIA JACKAL BASIC	00 >	•
1100 CALIFORNIA JACKAL BASIC	01 >	•
1100 CALIFORNIA METAL	02 > 03	•
1100 CALIFORNIA SPECIAL	99 > 00	•
1100 CALIFORNIA SPECIAL	01 >	•
1100 CALIFORNIA SPECIAL ALUMINIUM	02 >	•
1100 CALIFORNIA SPECIAL SPORT	02 >	•
1100 CALIFORNIA STONE	01 > 05	•
1100 CALIFORNIA TITANIUM	03 > 04	•
1100 CALIFORNIA TOURING	06 > 08	•
1100 CALIFORNIA VINTAGE	06 > 12	•
1100 QUOTA ES	99 > 01	•
1400 CALIFORNIA CUSTOM	13 >	•
1400 CALIFORNIA TOURING	13 >	•

MOTO MORINI

1200 GRANPASSO	08 > 09	•
1200 SCRAMBLER	09 > 17	•

ROYAL ENFIELD

535 CONTINENTAL GT	14 >	•
--------------------	------	---

SWM

600 SUPERDUAL GT PACK	18 >	•
600 SUPERDUAL T	18 >	•
600 SUPERDUAL X	18 >	•

SYM

125 FRIDDLE III	18 >	•
-----------------	------	---

TM

250 ENDURO	05 >	•
250 F	05 >	•
250 F ENDURO	05 >	•
250 MX	06 >	•
300 MX	05 >	•

TRIUMPH

1500 THUNDERBIRD	09 >	•
1600 THUNDERBIRD	09 > 16	•
1700 THUNDERBIRD NIGHTSTORM	14 > 18	•
1700 THUNDERBIRD STORM	11 >	•
2300 ROCKET III	04 > 08	•
2300 ROCKET III ABS	09 >	•
2300 ROCKET III CLASSIC	07 >	•
2300 ROCKET III ROADSTER	11 >	•
2300 ROCKET III TOURING	09 >	•
2300 ROCKET III TOURING ABS	09 >	•
2300 ROCKET X	15 >	•

VICTORY

1200 OCTANE	17 >	•
-------------	------	---

YAMAHA

125 DT X SUPERMOTARD	05 > 06	•
660 XT R	04 > 13	•

ZERO

9.4 ZF DS	15 >	•
9.4 ZF S	15 >	•
12.5 ZF DS	15 >	•
12.5 ZF S	15 >	•
12.5 ZF SR	15 >	•





07BB04.30 GENUINE	94 x 36.2 x 10
07BB04.35 GENUINE	94 x 36.2 x 7.6
07BB04.83 GENUINE	“ “ “
07BB04.95 GENUINE	“ “ “
07BB04.SA	94 x 36.2 x 8
07BB04.LA	“ “ “
07BB04.SP	“ “ “
07BB04.SD	“ “ “
07BB04.SX	“ “ “
07BB04.TT	“ “ “

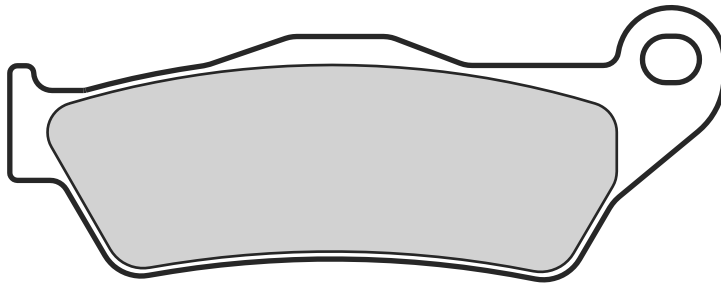
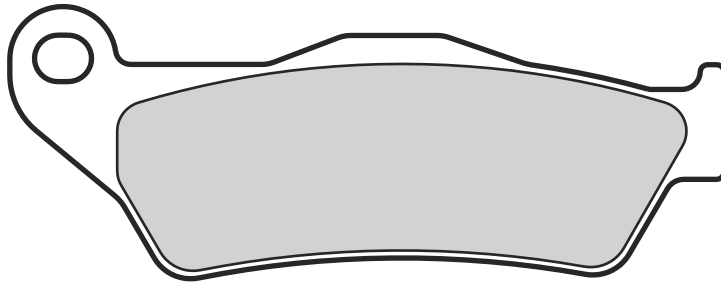

ALFER

125 VRE - 4 STROKE	00 >	•
250 VR CROSS	99 >	•
250 VR ENDURO	99 >	•
250 VR NO LIMIT	99 >	•
250 VR SUPERMOTARD	99 >	•

APRILIA

125 MX supermotard	04 > 06	•
125 MX supermoto	07 >	•
125 RX	96 > 02	•
125 RX ENDURO	08 > 13	•
125 RX SUPERMOTARD	08 > 13	•

125 SX

08 > •

650 PEGASO

96 > 96 •

850 SRV

12 > 16 •

1000 RST FUTURA

01 > 04 •

BENELLI

449 BX CROSS

07 > 12 •

505 ENDURO

08 > •

BIMOTA

1100 DBX

13 > •

BMW

450 ENDURO	08 >	•
450 G 450 X	09 > 12	•
1170 R NINE T SCRAMBLER	16 >	•
1200 HP2 ENDURO	06 > 09	•
1200 HP2 SPORT	08 > 12	•
1200 R 1200 R DARK WHITE	14 >	•
1200 R NINE T	14 >	•
1200 R NINE T PURE	17 >	•
1200 R NINE T RACER	17 >	•
1200 R NINE T URBAN GS	17 >	•



CAGIVA

900 ELEFANT	93 >	• •
-------------	------	-----

CCM

450 ENDURO	08 >	•
450 MX	08 >	•
600 RS	01 >	•
600 SPORT	99 >	•
600 SUPERMOTO	99 >	•
644 DS	02 >	•
644 R30	02 >	•

DUCATI

620 MULTISTRADA 620 (BIDISCO)	05 >	•
695 MONSTER 695	07 > 08	•
803 MONSTER S2 R	05 > 07	•
803 MONSTER S2 R DARK	05 > 06	•
950 MULTISTRADA	17 >	•
1200 MULTISTRADA	15 >	•
1200 MULTISTRADA ENDURO	16 >	•
1200 MULTISTRADA S	15 >	•
1200 MULTISTRADA S D-AIR	15 >	•
1200 MULTISTRADA S PIKES PEAK	15 >	•
1200 MULTISTRADA S TOURING ABS	15 > 16	•
1200 MULTISTRADA TOURING ABS	15 > 16	•
1260 MULTISTRADA	18 >	•
1260 MULTISTRADA S	18 >	•
1260 MULTISTRADA S D-AIR	18 >	•
1260 MULTISTRADA S PIKES PEAK	18 >	•

GAS GAS

50 WILD HP	04 >	• •
125 EC	97 > 99	•
200 EC	99 > 99	•
200 WILD HP	08 >	• •
240 WILD HP	04 >	• •
250 EC	97 > 99	•
250 MC	97 > 99	•
250 WILD HP	08 >	• •
300 EC	99 > 99	•
300 WILD HP	03 >	• •
450 WILD HP	03 >	• •
515 WILD HP	09 >	• •

HARLEY DAVIDSON

750 STREET DARK CUSTOM	16 >	•
------------------------	------	---

HIGHLAND

450 MX	06 >	•
950 V2	99 >	•

HONDA

650 SLR	97 >	•
---------	------	---

HUSABERG

ALL MODELS	93 >	•
125 TE	13 > 14	•
250 FE	13 > 14	•
250 TE	11 > 14	•
300 TE	11 > 14	•
350 FE	13 > 14	•
390 FE	10 > 14	•
400 FC	99 >	•
400 FE	99 >	•
450 FC	03 > 09	•
450 FC (CROSS)	05 > 09	•
450 FE	09 > 14	•
450 FE (ENDURO)	05 > 09	•
450 FE E	04 > 09	•
450 FX	03 > 09	•
470 FC	01 > 02	•
470 FX	01 > 02	•
501 FE	13 > 14	•
550 FC	01 > 08	•
550 FC (CROSS)	05 > 08	•
550 FE (ENDURO)	05 > 08	•
550 FE E	04 > 08	•
570 FE	09 > 12	•
600 FC	99 >	•
600 FE	99 >	•
650 FE (ENDURO)	05 > 08	•
650 FX	01 > 08	•

HUSQVARNA

50 SM	10 >	•
125 CR	95 > 98	•
125 CR	99 > 02	•
125 CR	03 > 04	•
125 CR	05 > 13	•
125 SM	98 > 99	•
125 SM S	09 > 13	•
125 SM S 4T	11 > 13	•
125 SMS	00 > 01	•
125 SMS	05 > 13	•
125 TC	14 >	•
125 TE	11 > 12	•
125 TE	14 >	•
125 TE 4T	11 > 13	•
125 WR	95 > 97	•
125 WR	98 > 02	•
125 WR	03 > 04	•
125 WR	05 >	•
125 WR E	94 > 05	•
125 WR E	06 > 13	•
250 CR	95 > 98	•
250 CR	99 > 04	•
250 CR	05 >	•
250 FC	14 >	•
250 FE	14 >	•
250 TC	02 > 03	•
250 TC	14 >	•
250 TE	03 > 13	•
250 TE	14 >	•
250 TE 4T	10 > 13	•
250 WR	95 > 97	•
250 WR	98 > 00	•

250 WR	01 >	•
300 TC	14 >	•
300 TE	14 >	•
300 WR	09 > 13	•
310 TE	10 > 12	•
310 TE 4T	10 >	•
350 FC	14 >	•
350 FE	14 >	•
350 TE	95 >	•
360 WR	95 > 98	•
360 WR	98 >	•
400 TE	01 >	•
410 TE	95 > 98	•
410 TE	99 > 00	•
410 TE E	00 > 01	•
449 TC 449	04 > 13	•
449 TE 449	02 > 05	•
449 TE 449	06 > 13	•
450 FC	14 >	•
450 FE	14 >	•
450 TC	03 > 03	•
501 FE	14 >	•
510 TC	02 > 04	•
510 TC 511	05 > 10	•
510 TE 511	05 > 05	•
510 TE 511	06 >	•
510 TE CENTENNIAL	04 >	•
510 TE R	04 >	•
570 TC	02 > 04	•
570 TE	01 > 04	•
610 TC	96 > 97	•
610 TC	98 > 98	•
610 TC	99 > 00	•
610 TE	96 > 97	•
610 TE	98 > 98	•
610 TE	99 > 00	•
610 TE E	98 > 04	•
610 TE E DUAL PURPOSE	06 >	•
610 TE E LT	99 > 99	•
630 SM	10 >	•
630 TE	10 >	•

KRAMIT

250 GS	97 >	•
250 MX	97 >	•
250 SM	97 >	•

KTM

125 EGS	93 > 93	•
125 EGS	94 > 98	•
125 EGS	99 >	•
125 EXC	93 > 93	•
125 EXC	94 > 97	•
125 EXC	98 > 98	•
125 EXC	99 > 00	•
125 EXC	01 > 03	•
125 EXC	04 >	•
125 EXC SIX DAYS	09 >	•
125 EXE	00 > 01	•
125 GS	92 >	•
125 LC2	96 > 98	•
125 MX	92 >	•





125 SUPERMOTO	00 > 01	•
125 SX	92 > 93	•
125 SX	94 > 97	•
125 SX	98 > 98	•
125 SX	99 > 00	•
125 SX	01 > 03	•
125 SX	04 >	•
125 SXS	01 > 02	•
144 SX	07 > 08	•
150 SX	09 >	•
200 EGS	98 > 98	•
200 EGS	99 >	•
200 EXC	98 > 98	•
200 EXC	99 > 00	•
200 EXC	01 > 03	•
200 EXC	04 >	•
200 MXC	98 > 00	•
200 MXC	01 > 03	•
200 SX	04 >	•
250 EGS	94 > 98	•
250 EGS	99 >	•
250 EXC	94 > 98	•
250 EXC	99 > 00	•
250 EXC	01 > 03	•
250 EXC	04 >	•
250 EXC F	06 >	•
250 EXC F SIX DAYS	09 >	•
250 EXC RACING	03 > 04	•
250 EXC RACING	05 >	•
250 EXC TPI	18 >	•
250 MX	92 >	•
250 MXC	00 > 00	•
250 MXC	01 >	•
250 SX	92 > 93	•
250 SX	94 > 98	•
250 SX	99 > 00	•
250 SX	01 > 02	•
250 SX	03 >	•
250 SX-F	06 >	•
250 SXC	03 >	•
250 SXS	01 >	•
300 EGS	93 > 93	•
300 EGS	94 > 98	•
300 EGS	99 >	•
300 EXC	93 > 03	•
300 EXC	94 > 98	•
300 EXC	99 > 00	•
300 EXC	01 > 03	•
300 EXC	04 >	•
300 EXC SIX DAYS	09 >	•
300 EXC TPI	18 >	•
300 MXC	97 > 98	•
300 MXC	99 > 00	•
300 MXC	01 > 03	•
300 SX	92 > 93	•
300 SX	94 > 05	•
300 SX	06 >	•
350 EXC	94 >	•
350 EXC F	11 >	•
350 EXC F SIX DAYS	11 >	•
350 EXC LC4	93 > 94	•
350 SXF	11 >	•
360 EGS	96 > 97	•
360 EXC	96 > 97	•

360 MXC	97 >	•
360 SX	96 > 97	•
380 EGS	98 >	•
380 EXC	98 > 02	•
380 MXC	98 >	•
380 SX	98 > 02	•
400 EGS	94 > 97	•
400 EXC	94 > 96	•
400 EXC	00 > 02	•
400 EXC RACING	05 >	•
400 LC4	98 > 01	•
400 MXC	02 >	•
400 SUPERMOTO	01 >	•
400 SX	98 > 02	•
400 SXC	97 >	•
440 SX	94 >	•
450 EXC	03 > 03	•
450 EXC	04 >	•
450 EXC R	05 > 06	•
450 EXC R	07 >	•
450 MXC	03 >	•
450 SX	03 > 03	•
450 SX	04 >	•
450 SX RACING	05 >	•
450 SXF	07 >	•
450 XC-F	08 >	•
500 EXC F	12 > 18	•
500 MX	92 >	•
500 SX	92 > 93	•
505 505 XC-F	09 >	•
505 SX-F	07 >	•
520 EXC	01 > 02	•
520 MXC	01 > 02	•
520 SX	00 > 00	•
520 SX	01 > 02	•
525 EXC	03 > 03	•
525 EXC	04 >	•
525 EXC RACING	05 >	•
525 MXC	03 >	•
525 SX	03 > 03	•
525 SX	04 >	•
525 SX RACING	05 >	•
525 XC DESERT RACING	04 >	•
530 EXC	08 >	•
530 EXC R	08 > 08	•
540 SXC	99 >	•
540 SXS	01 > 02	•
550 MXC	96 >	•
600 LC4	93 >	•
620 ADVENTURE	97 >	•
620 EGS	94 > 97	•
620 EXC	94 >	•
620 LC4	98 > 99	•
620 LC4 RALLY DAKAR	97 >	•
620 SC	01 >	•
620 SUPERMOTO	01 >	•
620 SX	94 > 98	•
620 SX	99 >	•
620 SXC	97 >	•
625 SC	02 >	•
625 SUPERMOTO	02 >	•
625 SXC	03 >	•
640 LC4	98 > 04	•
640 LC4	05 > 06	•

640 LC4 ADVENTURE	98 > 02	•
640 LC4 ADVENTURE	03 > 04	•
640 LC4 ENDURO	03 > 05	•
640 LC4 ENDURO	06 >	•
640 LC4 RALLY DAKAR	97 >	•
640 LC4 SUPERMOTO	00 > 02	•
660 LC4 RALLY	99 > 02	•
660 LC4 RALLY DAKAR	97 >	•
660 RALLYE FACTORY REPLICA	03 > 07	•
790 DUKE	18 >	•
950 ADVENTURE S	03 >	•
950 LC8 ADVENTURE	01 > 02	•
950 LC8 ADVENTURE	03 >	•
950 RALLYE	02 >	•
950 SUPER ENDURO	07 >	•
950 SUPERENDURO R	06 > 10	•
950 SUPERMOTO	05 >	•
950 SUPERMOTO R	07 > 08	•
990 990 SUPERMOTO R	09 >	•
990 ADVENTURE	06 >	•
990 ADVENTURE ABS	06 >	•
990 ADVENTURE R	10 > 12	•
990 ADVENTURE S	06 >	•
990 SUPERMOTO	06 >	•
990 SUPERMOTO T	09 >	•
1050 ADVENTURE	15 > 16	•
1090 SUPER ADVENTURE	17 >	•
1090 SUPER ADVENTURE R	17 >	•
1190 ADVENTURE	13 > 16	•
1290 SUPER ADVENTURE	15 > 16	•
1290 SUPER ADVENTURE R	17 >	•
1290 SUPER ADVENTURE S	17 >	•
1290 SUPER ADVENTURE T	17 >	•

MAICO

250 CROSS	99 >	•
250 ENDURO	99 >	•
500 CROSS	99 >	•
500 ENDURO	99 >	•
500 SUPERMOTARD	99 >	•

MOTO GUZZI

850 BREVA	06 > 07	•
850 GRISO	06 > 07	•
940 BELLAGIO	07 > 13	•
1100 BREVA	05 > 07	•
1100 BREVA ABS	05 > 07	•
1100 GRISO	05 > 08	•
1100 QUOTA ES	99 > 01	•
1200 BREVA	11 >	•
1200 GRISO 8V	07 > 13	•
1200 NORGE	06 > 07	•
1200 NORGE ABS	06 > 07	•
1200 NORGE GT 8V	08 > 16	•
1200 SPORT	06 >	•
1200 SPORT 4V	09 >	•
1200 SPORT 8V	12 >	•
1200 SPORT 8V SE	12 >	•
1200 SPORT ABS	06 >	•
1200 STELVIO	08 > 11	•
1200 STELVIO 8V SE	12 >	•
1200 STELVIO NTX	09 > 11	•



MOTO MORINI

1200 GRANFERRO	10 >	•
1200 GRANPASSO	08 > 09	•
1200 SCRAMBLER	09 > 17	•

RIEJU

250 MRX MARATHON	10 >	•
450 MRX	08 >	•

SHERCO

125 SE-R	17 >	•
250 2.5 I ENDURO	06 > 11	•
250 I/IR	12 >	•
250 SE R	14 >	•
250 SEF	14 >	•
250 SEI-F	14 >	•
250 SX 2.5	09 > 10	•
250 SX 2.5	11 >	•
300 I/IR	12 >	•
300 SE 3.0	10 >	•
300 SE 3.0I-F	10 > 11	•
300 SE R	14 >	•
300 SEF	14 >	•
300 SEI-F	13 >	•
450 ENDURO	04 > 04	•
450 ENDURO	05 > 11	•
450 IR	12 >	•
450 SEF	14 >	•
510 5.1 I ENDURO	06 > 11	•
510 IR	12 >	•

SUZUKI

650 SU 650X	18 >	•
-------------	------	---

SWM

125 RS R	16 >	•
125 SM R	16 >	•

250 MC S	16 >	•
340 RS S	16 >	•
500 RS R	15 >	•

TM

80 CROSS	96 >	•
85 85	01 > 12	•
125 125	96 > 00	•
125 125	01 > 04	•
125 ENDURO	01 > 04	•
125 ENDURO	05 >	•
125 MX	06 >	•
250 250	01 > 04	•
250 250 4-STROKE	01 >	•
250 E	95 > 00	•
250 E	01 >	•
250 E 4-STROKE	00 >	•
250 E 4-STROKE	01 > 04	•
300 300	98 > 00	•
300 300	01 >	•
300 E	01 > 04	•
320 320	96 >	•
400 4T	00 > 00	•
400 4T	01 >	•
400 E 4 STROKE	01 >	•
450 4T	02 > 04	•
450 ENDURO 4 STROKE	02 > 04	•
450 F	05 >	•
450 F ENDURO	05 >	•
450 FT FI	17 >	•
530 4T	01 > 04	•
530 E 4 STROKE	01 > 04	•
530 F	05 >	•
530 F ENDURO	05 >	•

TRIUMPH

800 TIGER XC	18 >	•
800 TIGER XCA	18 >	•
800 TIGER XCX	18 >	•

800 TIGER XR	18 >	•
800 TIGER XRT	18 >	•
800 TIGER XRX	18 >	•
800 TIGER XRX LOW	18 >	•
1200 BONNEVILLE BOBBER BLACK	18 >	•
1200 BONNEVILLE SPEED MASTER	18 >	•
1200 SPEEDMASTER	18 >	•

VERTEMATI

500 CROSS	02 >	•
501 ENDURO	02 >	•
501 SUPERMOTARD	02 >	•

VOR

400 CROSS	00 > 01	•
400 EN	02 >	•
400 MX	02 >	•
450 EN	02 >	•
450 MX	02 >	•
500 CROSS 495	99 >	•
500 ENDURO 492	99 >	•
530 EN	02 >	•
530 MX	02 >	•

YAMAHA

125 YZF R	08 > 13	•
150 FZH FAZER	11 >	•
600 TT	93 >	•
600 TT 600	97 >	•
600 TT 600 R	97 >	•
660 XTZ TENERE' ABS	11 >	•
660 XTZ TENERE'	08 > 13	•

ZERO

2.8 ZF FX	15 >	•
5.7 ZF FX	15 > 15	•





07BB06.06 119.7 x 51.8 x 7.8

2

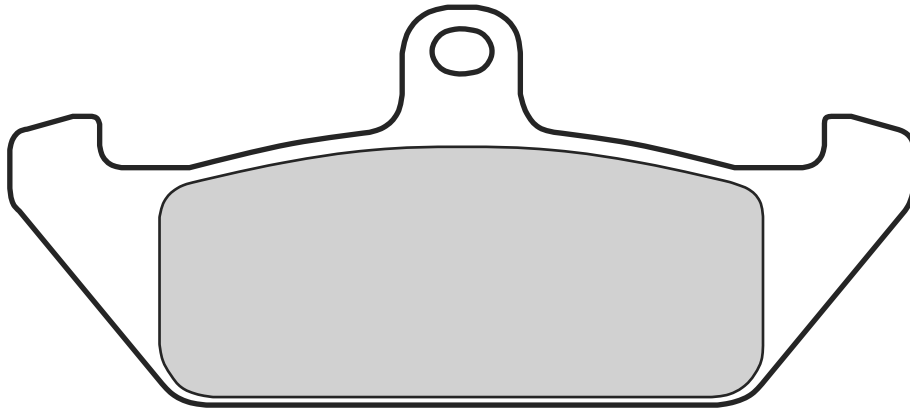

APRILIA

350	TUAREG WIND	88 > 89	•
600	TUAREG WIND	88 > 89	•

CAGIVA

350	ELEFANT	85 > 89	•
650	ELEFANT	85 > 87	•
750	ELEFANT BIFARO	90 >	•
750	LUCKY EXPLORER	88 >	•



DUCATI

650	INDIANA	86 >	•
750	INDIANA	89 >	•

LAVERDA

600	ATLAS	86 >	•
-----	-------	------	---



MOTO GUZZI

650	VT 65 TT BAJA	86 >	•
750	NTX	89 > 89	•

MOTO MORINI

350	INDIANA	88 >	•
501	EXCALIBUR	86 > 86	• •
501	EXCALIBUR	89 > 89	•
650	INDIANA	88 >	•
750	INDIANA	88 >	•



07BB07.08 84.9 x 42.4 x 7.5

55.8 x 37 x 9.8

07BB07.TT “ “ “

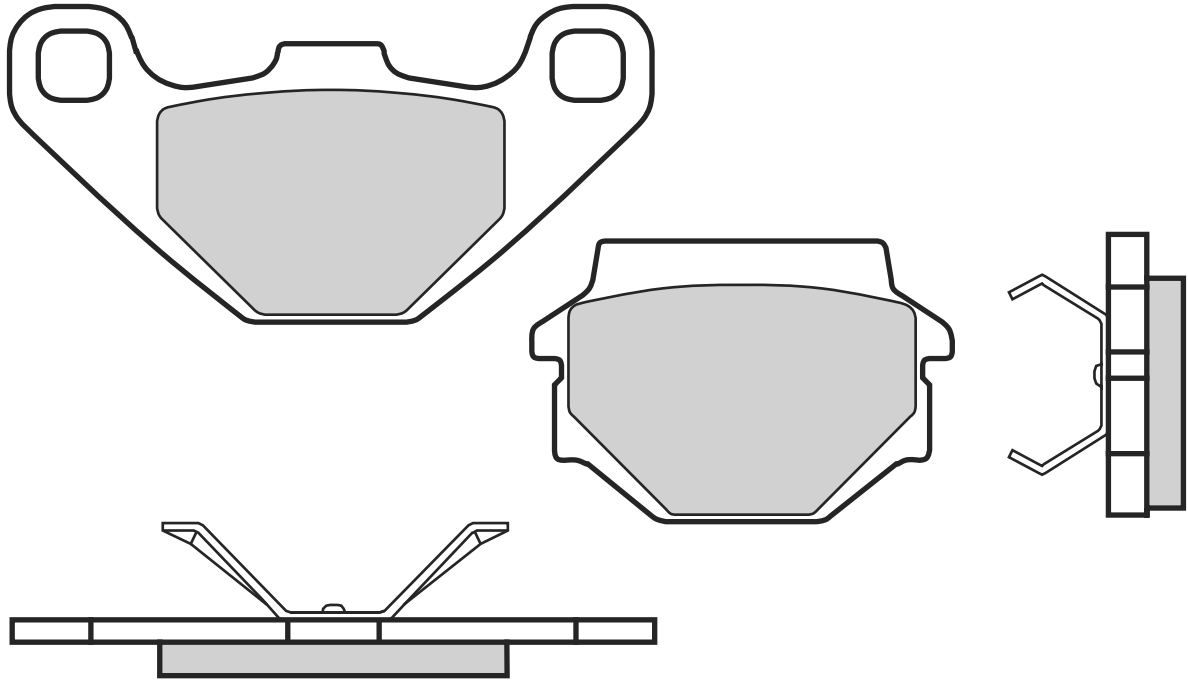

APRILIA

125 PEGASO	89 > 91	•
125 RX	91 > 91	•
125 RX	96 > 02	•
125 TUAREG WIND	90 >	•
350 TUAREG WIND	90 >	•
600 TUAREG	88 >	•
600 TUAREG WIND	90 >	•
650 MOTÒ	95 >	•
650 PEGASO	92 > 95	•
650 PEGASO	96 > 96	•
650 PEGASO	97 > 03	•
650 STARCK	96 >	•

BUELL

1200 RS	93 >	•
---------	------	---

CAGIVA

125 CROSS	88 >	•
125 W9	96 >	•
125 WMX	89 >	•
250 WMX	89 >	•
500 W16	94 > 98	•
600 W16	94 >	•

FANTIC MOTOR

50 RAIDER	84 >	•
50 STRADA	83 >	•
125 STRADA	83 >	•

HUSQVARNA

125 CR	91 > 91	•
125 WR	91 > 91	•
240 WR	91 >	•
250 CR, WR	91 >	•
260 WR	91 >	•
360 TE	95 > 98	•
510 CROSS COUNTRY LC	87 >	•
510 ENDURO LC	87 >	•
510 MOTOCROSS LC	87 >	•
510 TC MOTOCROSS	88 >	•
610 TC CROSS	91 > 95	•
610 TE	91 > 95	•

KRAMIT

50 SCRAMBLER	70 >	•
125 ER	89 >	•
250 ER	89 >	•
250 MC	89 >	•
300 ER	89 >	•

KTM

125 EGS	93 > 93	•
125 EXC	93 > 93	•
125 GS	92 >	•
125 MX	89 > 91	• •
125 MX	92 >	•
125 SX	92 > 93	•
250 MX	89 > 91	• •
250 MX	92 >	•
250 SX	92 > 93	•
300 EGS	93 > 93	•
300 EXC	93 > 03	•
300 SX	92 > 93	•
350 EXC LC4	93 > 94	•
500 MX	89 > 91	• •
500 MX	92 >	•
500 SX	92 > 93	•
600 LC4	93 >	•
600 MX	91 >	• •

TM

400 CROSS	00 >	•
-----------	------	---

YAMAHA

125 TDR ITALIA	90 >	•
----------------	------	---



**07BB09.07**

99.9 x 46.8 x 8.5

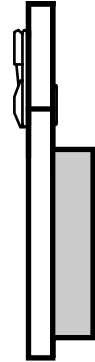
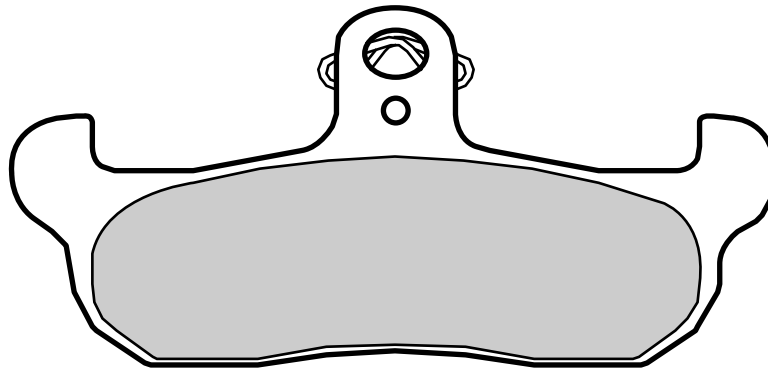

2

**APRILIA**

125 AF1	86 > 92	•
125 RX	90 > 90	•
125 TUAREG RALLY	89 > 89	•
125 TUAREG WIND	88 > 88	•
350 RALLY	86 >	•

CAGIVA

50 WMX	89 >	•
125 CROSS	88 >	•
125 CRUISER	87 >	•
125 FRECCIA C9	88 >	•
125 LUCKY EXPLORER	88 >	•
125 WMX	87 > 88	•
125 WMX	89 >	•
250 CROSS	86 >	•
250 WMX	87 > 88	•
250 WMX	89 >	•

FRIGERIO PUCH

125 F7	89 >	•
250 REPLAY	89 >	•

GILERA

125 RC TOP RALLY	89 >	•
600 RC	88 >	•

HM

50 CRE	98 > 05	•
--------	---------	---

HONDA

50 CRE	93 >	•
--------	------	---

HUSABERG

ALL MODELS	89 > 92	•
350 350	91 >	•
500 500	91 >	•
501 ENDURO	70 >	•
600 ENDURO	70 >	•

HUSQVARNA

125 CR	91 > 91	•
125 WR	91 > 91	•
240 WR	87 > 90	•
240 WR	91 >	•
250 CR, WR	91 >	•
250 WR	87 > 91	•
250 XC	87 >	•
260 WR	91 >	•
360 TE	95 > 98	•
400 WR	87 >	•
430 CR	87 >	•
430 WR	87 >	•
430 XC	87 >	•
500 XC	87 >	•

510 CROSS COUNTRY LC	87 >	•
510 ENDURO LC	87 >	•
510 MOTOCROSS LC	87 >	•
510 TC MOTOCROSS	88 >	•
510 TE ENDURO	88 >	•
510 TX CROSS COUNTRY	88 >	•
610 TC CROSS	91 > 95	•
610 TE	91 > 95	•

KRAMIT

125 ER	89 >	•
250 ER	89 >	•
250 MC	89 >	•
300 ER	89 >	•

MOTO MORINI

400 DART	89 > 89	•
----------	---------	---

TM

80 GS	87 >	•
80 MC	87 >	•
125 GS	87 >	•
400 CROSS	00 >	•

YAMAHA

125 DT TENERE	89 >	•
125 TDR ITALIA	90 >	•



07BB10.SC 77.4 x 40.7 x 8.3

07BB10.RC “ “ “

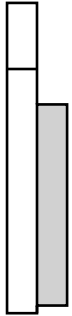
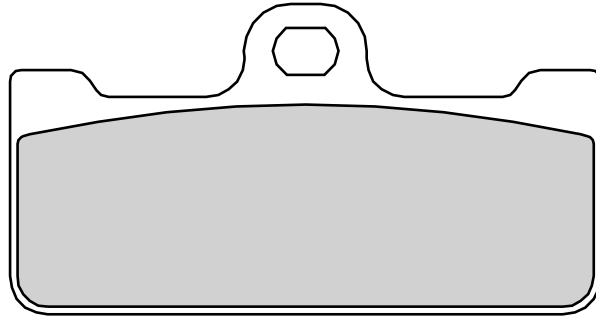

2



APRILIA

450	SXV VAN DEN BOSCH REPLICA	08 > 08	•
550	SXV VAN DEN BOSCH REPLICA	08 > 08	•



**07BB12.05**

35.7 x 45.4 x 6

07BB12.TT

“ “ “

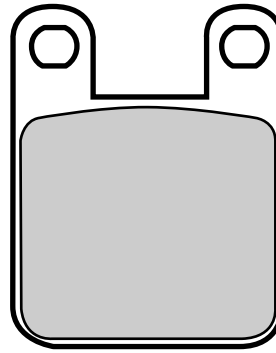

2

**ALFER**

80 MC 87 > •

APRILIA

240 TX 86 > •

250 AF1 REPLICA 90 > •

280 CLIMBER 92 > 94 • •

311 TX 86 > • •

312 TX 88 > 89 •

312 TXR 88 > 89 •

BETA

50 REV 00 > • •

50 RR ENDURO 99 > 03 •

50 RR STANDARD 99 > •

50 RR SUPERMOTARD 99 > 03 •

50 RR SUPERMOTARD 04 > 07 • •

50 ST 97 > • •

50 SUPER TRIAL 92 > •

50 TECHNO 96 > • •

50 TEMPO 92 > 96 •

80 EVO JUNIOR 10 > • •

80 REV 00 > 07 • •

125 ALP 99 > • •

125 TR 97 > •

125 TR34 89 > 90 • •

125 TR35 88 > 90 • •

125 TRIAL 97 > •

200 ALP 00 > • •

240 ALP 92 > •

240 SUPER TRIAL 92 > •

250 ALP 92 > 96 •

250 ALP 97 > • •

250 EIKON 99 > • •

250 TECHNO 96 > • •

250 ZERO 91 > •

260 ALP 96 > •

260 TR34 89 > 92 •

260 TR35 89 > 92 •

260 ZERO 91 > •

BULTACO

50 ASTRO 01 > •

50 LOBITO 99 > •

CAGIVA

50 CORSA 98 > •

50 MITO 99 > 02 •

DERBI

50 BLACK DEVIL 04 > •

50 DRD PRO R 06 > •

50 DRD RACING R 05 > •

50 DRD RACING R LIMITED EDITION 05 > •

50 DRD RACING SM 05 > •

50 DRD RACING SM LIMITED EDITION 05 > •

50 FDX 89 > •

50 FENIX 94 > • •

50 GP 01 > •

50 GPR 98 > 08 •

50 GPR 09 > •

50 GPR NUDE 04 > •

50 GPR RACING 04 > •

50 GPX1 06 > •

50 SAVANNAH 91 > •

50 SENDA DRD EVO SM 09 > •

50 SENDA DRD PRO R/SM 09 > •

50 SENDA DRD RACING R/SM 09 > •

50 SENDA R 94 > 99 • •

50 SENDA R 03 > 04 •

50 SENDA SM 99 > 02 • •

50 SENDA SM DRD 03 > 04 • •

50 SENDA SM DRD BLACK ED. 03 > •

50 SENDA X-RACE R/SM 09 > • •

50 SENDA X-TREME R/SM 09 > • •

50 X-RACE R 05 > • •

50 X-TREME R 05 > • •

75 GPR 89 > •

80 GPR CUP 04 > •

125 BOULEVARD S 09 > •

125 CROSS CITY 09 > •

125 GP1 05 > •

125 GPR 05 > •

125 GPR NUDE 05 > •

125 GPR RACING 09 > •

125 SENDA 4-STROKE 04 > •

125 SENDA BAJA R/SM 09 > •

125 SENDA R 4-STROKE 05 > •

125 SENDA X-TREME SM 04 > •

125 TERRA 07 > 07 • •

FANTIC MOTOR

50 CLUBMANN 94 > •

50 TRIAL 89 > •

250 K-ROO 91 > •

250 TRIAL 91 > •

305 TRIAL 88 > •

307 TRIAL 91 > • •

GARELLI

50 CICLONE LC, SM 86 > •

50 GSP 09 > •

323 TRIAL 86 > •

GAS GAS

50 TXT BOY 04 > • •

125 DELTA 91 > •

125 PAMPERA 96 > 03 • •

200 PAMPERA 99 > • •

200 TX 97 > • •

250 PAMPERA 96 > 99 • •

250 TRIAL 89 > • •

270 TX 97 > • •

320 TX 97 > • •

370 PAMPERA 96 > • •

GILERA

50 HAK 99 > • •

50 RCR 04 > • •

50 SMT 04 > • •

50 SUPERMOTARD 01 > • •

50 ZULU 01 > • •

125 GSM 00 > • •

125 SC 06 > •

HRD

50 SONIC 00 > 02 •

50 SONIC TRIAL 00 > 02 •

125 SUPERMOTARD 00 > •

125 TRIAL 00 > •



HUSQVARNA

50	HUSKY BOY	01 >	•
50	RACING	98 >	•
50	SM	02 > 09	•
50	WR	02 >	•
50	WRS	98 >	•

KTM

50	SX	99 >	•
65	SX	00 > 01	•

MACAL

50	TROPHY	99 >	•
----	--------	------	---

MALAGUTI

50	DRAKON	05 >	•
50	NKD	04 >	•
50	NKD DRAGON	06 >	•
50	XSM	03 >	•

MONTESA

125	COTA	88 >	• •
260	EVASION	92 >	•
304	COTA	88 >	• •
307	COTA	89 >	• •
307	COTA TRIAL	88 >	• •
309	COTA	89 >	•
310	COTA	89 >	•
311	COTA TRIAL	92 >	•
315	COTA R	97 >	• •
335	COTA	87 > 91	• •
360	ENDURO	85 >	•

MORBIDELLI MBA

125	JR	76 >	• •
-----	----	------	-----

PEUGEOT

50	BUXY R (AJP CALIPER)	93 > 97	•
50	JET C-TECH	05 > 08	•
50	JET C-TECH	09 >	• •

50	LOOXOR	02 > 05	•
50	XP6 ENDURO	06 >	• •
50	XP6 SUPERMOTARD	06 >	• •
50	XP6 TRIAL	04 > 05	• •
50	XPS6 ENDURO	02 >	• •
50	XPS6 SUPERMOTARD	04 > 05	•
50	XR6	02 > 07	•
50	XR7	08 >	•
150	LOOXOR	02 > 05	•

PUCH

50	TZX	92 >	•
75	COBRA	85 >	•

RIEJU

50	DRAC	97 >	• •
50	EVOLUTION RS1	96 > 00	• •
50	FD4 SUPER MARATHON	85 >	•
50	MATRIX	03 >	•
50	MRX	02 > 04	• •
50	MRX PRO	05 >	•
50	MX (AJP CALIPER)	02 >	• •
50	NKD	04 >	•
50	RACING	01 >	•
50	RR SUPERMOTARD	96 >	• •
50	RRX SPIKE	08 >	• •
50	RS1	92 > 00	• •
50	RS1	01 >	•
50	RS1 CASTROL	01 >	•
50	RS2 MATRIX	03 >	•
50	RS3 PRO	12 >	•
50	SMX	02 >	•
50	SMX PRO	08 >	•
50	SPIKE	02 >	•
50	SPIKE (AJP CALIPER)	02 >	•
80	CROSS, ENDURO	87 >	• •
80	RST	91 >	• •
125	MRX	03 >	•
125	MRX (AJP CALIPER)	03 >	• •
125	RR	97 >	• •
125	RS3	10 >	•
125	SMX	03 >	•

125	SMX (AJP CALIPER)	03 >	• •
125	TANGO	06 > 07	•
125	TANGO	08 >	•
125	TANGO PRO	08 >	•
250	TANGO	08 >	•

SCORPA

115	TY-S F TRIAL	06 >	•
-----	--------------	------	---

SHERCO

50	ENDURO	02 > 06	•
50	ENDURO	07 >	•
50	SM	02 >	•
50	SUPERMOTARD	07 >	•
80	80	01 >	• •
125	125	01 > 01	• •
125	125	02 >	•
125	CITY CORP 4T ENDURO	03 >	•
125	CITY CORP 4T SM	03 >	•
125	ST	01 > 05	• •
200	200	01 >	• •
250	250	99 > 00	• •

SIMSON

125	SM	01 >	•
125	STAR	99 >	•

SUZUKI

50	DR BIG	89 >	•
50	RMX	00 >	• •
50	SMX SUPERMOTARD	00 >	• •

TGB

50	CAPPUCCIO	09 >	•
----	-----------	------	---

YAMAHA

50	DT R	04 > 11	•
125	XT R	05 >	• •
125	XT X SUPERMOTARD	05 >	•
250	TY R	91 > 92	•
250	TY Z	93 > 96	• •



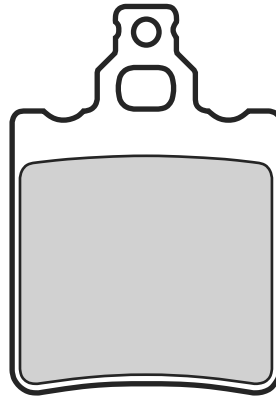

07BB13.05	35.8 x 51.6 x 5.9
07BB13.24	“ “ “
GENUINE	
07BB13.SD	“ “ “

**APRILIA**

50 AF-1	86 > 92	•
50 AF-1 EUROPA	90 > 91	•
50 AF-1 FUTURA	90 > 92	•
50 ET	85 >	•
50 ET TUAREG	86 >	•
50 MX	03 >	•
50 PEGASO	70 >	•
50 RS	93 > 95	•
50 RS	96 > 99	•
50 RS EXTREMA	00 >	•
50 RS REPLICA	00 > 05	•
50 RX	90 > 91	•
50 RX	92 > 05	•
50 RX RACING	04 > 07	•
50 TUAREG	85 > 85	•
50 TUAREG	86 >	•
50 TUAREG RALLY	90 >	•
125 TUAREG WIND	88 > 88	•
240 CLIMBER	89 > 90	•
275 CLIMBER	89 > 90	•

BETA

350 4.0 MOTARD	04 >	•
350 ALP 4.0	04 > 05	•

CAGIVA

50 BLUES	89 > 93	•
50 LUCKY EXPLORER	88 > 91	•
50 W4	92 > 94	•
80 COCIS	91 >	•
80 W4	92 >	•
125 ALETTA ORO	85 >	•
125 ALETTA ROSSA	83 >	•
125 DAKAR	89 > 90	•
125 E2	86 >	•
125 ELECTRA	83 >	•

125 ELEFANT	83 > 86	•
125 LUCKY EXPLORER	88 >	•
125 N 90	90 > 91	•
125 SPORT	85 >	•
125 SST	81 >	•
125 SXT	81 >	•
125 TAMANACO	89 > 90	•
125 W8	92 > 98	•
200 ALETTA ELECTRA	83 >	•
200 CROSS	83 >	•

FANTIC MOTOR

50 CABALLERO RC	90 >	•
50 CABALLERO RS	90 >	•
50 K-ROO	91 >	•
50 KOALA	88 > 95	•
50 OASIS	88 > 89	•
50 OASIS	90 >	•
75 OASIS	89 >	•
125 K-ROO	91 >	•
125 RAIDER LC	83 > 84	•
250 K-ROO	91 >	•
250 TRIAL	91 >	•
305 TRIAL	88 >	•

FRIGERIO PUCH

125 CROSS	84 > 85	•
125 REPLAY	89 >	•

GARELLI

125 SPORT	84 > 85	•
125 STRADA	84 > 85	•
125 STRADA GTA	83 > 85	•
125 TIGER XLE	86 >	•

GILERA

125 X1	89 > 89	•
250 NGR	85 >	•

HRD

125 SILVER HORSE	85 >	•
------------------	------	---

LAVERDA

125 125	84 >	•
125 CUSTOM	86 >	•
125 GS LESMO	86 >	•
125 LB (CU/SP)	84 >	•
125 LB SPORT	84 >	•
125 LB STRADA	85 >	•
125 LESMO	86 >	•
125 LS STRADA	85 >	•
125 NAVARRO	90 >	•
125 TOLEDO	90 >	•
150 FORMULA	86 >	•

MALAGUTI

50 DUNE ES	89 >	•
50 EVOLUTION	91 >	•
50 MDX	86 >	•
50 RST SPORT	88 > 96	•
50 XTM	03 >	•

MALANCA

80 GTI	70 >	•
125 GTI	80 >	•
125 MARK ENDURO	85 >	•
125 OB ONE M6	85 >	•
125 SPORT	78 >	•

ZÜNDAPP

80 KS SUPER	80 > 82	•
-------------	---------	---



07BB14.08 55.6 x 53.8 x 8.9

07BB14.18 “ “ “
GENUINE

07BB14.SP “ “ “

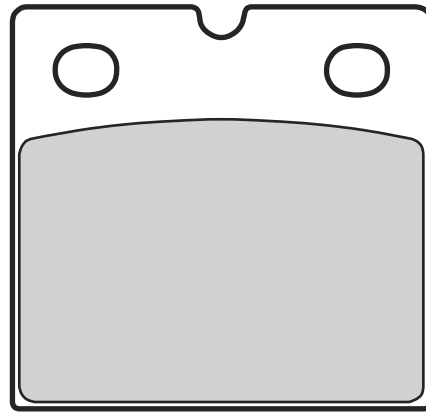

2



BENELLI

350	354 TURISMO, SPORT	83 > 85	•
500	504 SPORT	76 > 86	•
650	654	83 > 85	•
650	654 SPORT	83 > 85	•
750	SEI	75 > 80	•
900	SEI	78 > 86	•

BIMOTA

1000	DB 1	87 > 90	•
1200	YB 5 FS	87 >	•

BMW

450	R 45	81 > 85	•
650	R 65	81 > 85	•
650	R 65 GS	87 > 92	•
650	R 65 LS	82 > 85	•
650	R 65/1	86 > 92	•
750	K 75	84 > 86	•
750	K 75 ABS (SPECIAL CALIPER)	91 >	•
750	K 75 C	84 > 90	•
750	K 75 RT	89 > 96	•
750	K 75 S	85 > 87	• •
750	K 75T	84 > 90	•
800	R 80	81 >	•
800	R 80 GS	81 > 87	•
800	R 80 R	92 > 92	•
800	R 80 RT	83 > 84	•
800	R 80/7	79 > 81	•
1000	K 1	88 > 93	•
1000	K 100	83 > 92	• •
1000	K 100 ABS (SPECIAL CALIPER)	91 >	•
1000	K 100 LT	87 > 91	• •
1000	K 100 LT	92 >	•
1000	K 100 LT ABS	90 > 91	• •
1000	K 100 RS	83 >	• •
1000	K 100 RS 16V	90 >	•
1000	K 100 RT	84 > 89	• •

1000 R 100 CS

81 > 83

•

1000 R 100 CS

84 > 87

• •

1000 R 100 R

91 > 91

•

1000 R 100 RS

76 > 80

•

1000 R 100 RS

81 > 83

•

1000 R 100 RS

84 > 92

• •

1000 R 100 RS

93 >

•

1000 R 100 RT

79 > 80

•

1000 R 100 RT

81 > 83

•

1000 R 100 RT

84 > 90

• •

1000 R 100 S

78 > 80

•

1000 R 100 T

79 >

•

1100 K 1100 LT (no ABS)

92 > 98

•

1100 K 1100 RS

93 > 96

•

1100 R 1100 RS

93 > 93

•

1200 K 1200 GT

02 > 04

•

1200 K 1200 GT ABS

02 > 04

•

1200 K 1200 RS

97 > 00

•

1200 K 1200 RS

01 > 06

•

DUCATI

600	PANTAH	81 >	•
650	SL	84 >	•
750	LAGUNA SECA	87 >	•
750	PASO	87 > 88	•
750	SANTAMONICA	87 > 88	• •
750	SPORT	74 > 76	•
750	SPORT	88 > 89	• •
900	MIKE HAILWOOD REPLICHA	85 >	• •
900	REPLICHA	85 >	• •
900	S2	82 >	• •
900	S2 DESMO	85 >	• •
900	SUPERSPORT 900	81 >	• •
906	PASO	89 > 91	• •
906	SANTAMONICA	87 >	• •
1000	MIKE HAILWOOD REPLICHA	85 >	• •
1000	R1	84 >	• •
1000	S2 DESMO	85 >	• •

HOREX

125	IMPERATOR	96 >	•
125	REGENT	96 >	•
560	560 E	86 >	•
600	COLUMBUS	87 >	•

HRD

600	600 (HOREX)	85 >	• •
-----	-------------	------	-----

INDIAN

1700	CHIEF BLACKHAWK	11 > 13	•
1700	CHIEF BOMBER	10 > 13	•
1700	CHIEF CLASSIC	10 > 13	•
1700	CHIEF DARK HORSE	10 > 13	•
1700	CHIEF DELUXE	09 > 13	•
1700	CHIEF ROADMASTER	09 > 13	•
1700	CHIEF STANDAR	09 > 13	•
1700	CHIEF VINTAGE	09 > 13	•

LAVERDA

650	SFC	86 >	• •
650	V-SIX	93 >	• •
750	SF3	74 > 78	•
1000	1000	73 >	•
1000	EXECUTIVE	84 >	• •
1000	JOTA	84 >	• •
1000	RGS	82 > 83	• •
1000	SFC	86 >	• •

MOTO GUZZI

750	NTX	90 >	•
750	S3	75 > 76	•
750	SP	91 >	• •
750	V75	86 >	• •
850	LE MANS	76 > 80	•
850	LE MANS III	81 > 84	• •
850	LE MANS T4 (GERMANY)	85 >	• •
850	T3	75 > 85	• •





850 T3 CALIFORNIA	76 > 85	•
850 T3 CARABINIERI	83 > 85	• •
850 T3 GERMANIA	75 > 85	•
850 T3 POLIZIA	83 > 85	• •
850 T4	83 >	• •
850 T5	85 > 89	• •
1000 CALIFORNIA II	83 > 86	•
1000 CALIFORNIA III	87 > 93	• •
1000 GS CONVERT	75 >	• •
1000 GS CONVERT GERMANIA	75 >	•
1000 GT 1000	87 > 91	• •
1000 LE MANS IV	85 > 89	• •
1000 S 1000	89 > 94	• •
1000 SP 1000	78 >	•
1000 SP 1000 II	83 > 88	• •
1000 SP 1000 III	89 > 94	• •
1000 STRADA	93 > 94	• •
1000 V	93 >	•
1000 V CALIFORNIA	70 >	• •

1000 V I CONVERT	70 >	•
1100 CALIFORNIA	94 > 97	• •
1100 SPORT	01 >	•

MZ

125 ETZ	82 >	•
125 ROADSTER	70 >	•
150 ETZ	82 >	•
250 ETZ	82 >	•
251 ETZ	81 >	•
251 SAXON TOUR	96 >	•
251 SPORTSTAR MUZ	96 >	•
300 ETZ LUX	90 >	•
300 ETZ X	88 >	•
301 ETZ	90 >	•
301 SAXON TOUR	70 >	•
301 SPORTSTAR MUZ	96 >	•
500 SAXON COUNTRY	92 >	•
500 SAXON FUN	92 >	•
500 SAXON VOYAGER	70 >	•

500 SILVER STAR CLASSIC	93 >	•
-------------------------	------	---

NORTON

COMMANDER	90 >	• •
F 1	90 >	•
INTERPOL	83 >	• •
WANKEL CLASSIC	88 >	• •

OSSA

500 YANQEE	78 >	•
------------	------	---

SWM

350 SAHARA	70 >	•
------------	------	---

TRIUMPH

750 BONNEVILLE	87 > 88	• •
----------------	---------	-----

ZÜNDAPP

175 KS	81 >	•
--------	------	---

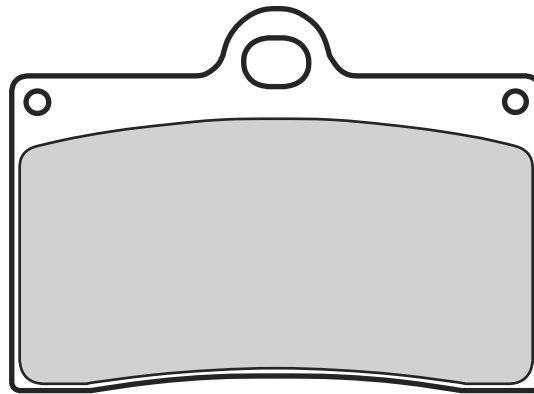

07BB15.07	69.7 x 51 x 8.4
07BB15.35 GENUINE	“ “ “
07BB15.SA	“ “ “
07BB15.LA	“ “ “
07BB15.SC	“ “ “
07BB15.RC	“ “ “

**APRILIA**

250 AF1 REPLICA	90 >	•
250 RS	95 > 97	•

BETA

125 JONATHAN	99 >	•
350 4.0 MOTARD	04 >	•
350 EURO	99 >	•
350 JONATHAN	02 >	•

BIMOTA

400 YB 7	89 >	•
500 V-DUE	97 >	•
600 BELLARIA	90 >	•
600 YB 9 SR	97 > 04	•
600 YB 9 SRI	97 > 04	•
650 BB1 SUPERMONO	97 >	•
750 SB7	94 >	•
750 YB 4	88 >	•
851 TESI	91 >	•
900 DB2	93 >	•
900 DB2 SR	94 >	•
900 MANTRA	97 >	•
906 TESI	91 >	•

1000 DB 1

91 > •

1000 DB 1 RS

87 > •

1000 FURANO

92 > •

1000 TESI 2D

04 > 06 •

1000 TUATARA

90 > •

1000 YB 11

97 > •

1000 YB 6

87 > •

1000 YB 8

89 > •

1100 SB6

94 > 96 •

1100 SB6

97 > •

CAGIVA

125 MITO 2	92 > 93	•
125 MITO 525	08 > 12	•
125 MITO EURO2	04 > 07	•
125 MITO EV	94 > 03	•
125 N1	96 >	•
125 PLANET	98 > 00	•
125 RAPTOR	03 > 04	•
125 SP MITO 525	08 > 12	•
500 MITO	07 >	•
500 RIVER	99 >	•
525 SP MITO	08 >	•
600 RIVER	94 >	•

DUCATI

350 350 SUPERSPORT	92 > 97	•
400 400 SUPERSPORT	93 > 97	•
400 MONSTER 400	95 > 97	•
500 502 SINGLE	93 >	•
500 502 SUPERMONO	93 >	•
600 600 SUPERSPORT	91 > 97	•
600 MONSTER 600	93 > 99	•
600 MONSTER 600 CITY	99 > 99	•
600 MONSTER 600 DARK	98 > 99	•
600 MONSTER 600 DARK CITY	98 > 99	•
748 748 BIPOSTO	95 > 97	•
748 748 BIPOSTO	98 > 98	•
748 748 SP	95 > 97	•
750 750 SUPERSPORT	91 > 98	•
750 F1	85 > 88	•
750 LAGUNA SECA	87 >	•
750 MONSTER 750 (BIDISCO)	96 > 98	•
750 MONSTER 750 (MONODISCO)	96 > 97	•
750 MONSTER 750 CITY, DARK CITY	99 > 02	•
851 851	89 >	•





851	851 SP2	90 >	•
851	851 SP3	91 >	•
851	851 SUPERBIKE	91 >	•
888	888 RACING	92 >	•
888	888 SP	92 >	•
888	888 SP4	92 >	•
888	888 SP5	93 >	•
888	888 SUPERBIKE STRADA	94 > 95	•
900	FE	97 >	•
900	MONSTER 900	93 > 99	•
900	MONSTER 900 CITY	99 > 01	•
900	MONSTER 900 CROMO	98 > 01	•
900	MONSTER 900 DARK CITY	99 > 01	•
900	MONSTER 900 SPECIAL	98 >	•
900	SUPERLIGHT 900	92 > 97	•
900	SUPERSPORT 900	90 > 97	•
907	907 I.E.	92 > 93	•
916	916	94 > 96	•
916	916 BIPOSTO SENNA	94 > 98	•
916	916 S	94 > 96	•
916	916 SP	94 > 96	•
916	916 SPS	97 > 98	•

FANTIC MOTOR

125	SM	12 >	•
-----	----	------	---

GAS GAS

125	SM	02 >	•
250	SM	02 >	•
400	FSE SM	02 >	•
450	FSE SM	03 > 06	•
450	SM FSR	07 >	•

GILERA

350	SATURNO	88 >	•
500	SATURNO	88 >	•
600	SATURNO PIUMA	90 >	•

HONDA

125	RS (GP)	95 >	•
250	RS R	93 >	•

HUSQVARNA

400	SM R	02 >	•
450	SMR	03 > 04	•
570	R	01 >	•
570	SMR	01 > 04	•
570	SMR R	04 > 04	•

INDIAN

1700	CHIEF BLACKHAWK	11 > 13	•
1700	CHIEF BOMBER	10 > 13	•
1700	CHIEF CLASSIC	10 > 13	•
1700	CHIEF DARK HORSE	10 > 13	•
1700	CHIEF DELUXE	09 > 13	•
1700	CHIEF ROADMASTER	09 > 13	•
1700	CHIEF STANDAR	09 > 13	•
1700	CHIEF VINTAGE	09 > 13	•

ITALJET

900	GRIFON	00 >	•
-----	--------	------	---

KTM

125	STING	99 >	•
400	DUKE	94 > 95	•
450	SM FACTORY REPLICA	04 >	•
525	SMR	04 > 04	•
620	DUKE 4T	94 > 97	•
640	DUKE	98 >	•
640	LC4 SUPERMOTO	03 > 04	•
660	SM FACTORY	02 >	•
660	SM FACTORY REPLICA	03 >	•
660	SMC	03 > 03	•
660	SMS	07 >	•

LAVERDA

650	FORMULA	94 > 95	•
650	GHOST	96 >	•
650	SPORT	94 > 95	•
650	STRADA	96 >	•
668	668	96 >	•
668	DIAMANTE	96 > 98	•
668	GHOST STRIKE LEGEND	96 > 98	•
750	CUP	98 >	•
750	DIAMANTE	97 >	•
750	GHOST STRIKE	97 >	•
750	S	97 > 98	•
750	S FORMULA	99 > 00	•
750	S SCARENATO	97 > 98	•
750	S SPORT	99 > 00	•
750	STRIKE BIFARO	98 > 99	•
750	STRIKE MONOFARO	98 > 99	•
750	T8	98 >	•
800	TTS	99 >	•

MOTO GUZZI

1000	DAYTONA	92 > 95	•
1000	DAYTONA RACING	92 > 96	•
1000	DAYTONA RS	97 > 98	•
1000	V10 CENTAURO	97 > 99	•
1000	V10 CENTAURO SPORT	98 > 99	•
1100	CALIFORNIA EV TOURING	97 > 00	•

1100	CALIFORNIA JACKAL BASIC	00 >	•
1100	CALIFORNIA SPECIAL	99 > 00	•
1100	SPORT	94 > 96	•
1100	SPORT CORSA	98 > 99	•
1100	SPORT I.E.	96 > 99	•

MZ

660	SKORPION CUP MUZ	99 >	•
660	SKORPION REPLICA MUZ	97 >	•

NORTON

F 1	90 >	•
TT	92 >	•

PGO

250	G-MAX	06 >	•
-----	-------	------	---

SACHS

125	X-ROAD 4T	05 >	•
125	XTC	99 >	•
125	XTC N	99 >	•
650	ROADSTER	01 >	•
800	B 805	02 >	•
800	ROADSTER	00 >	•
800	S 805	03 >	•

TM

125	SMR	05 >	•
125	SMX	06 >	•
400	SMR F	02 >	•
450	SMR F	04 >	•
450	SMX F	03 >	•
530	SMR F	03 >	•
530	SMR F ES	03 >	•
600	SMX F	03 >	•

VOR

400	SM	02 >	•
450	SM	02 >	•
500	SUPERMOTARD (492)	00 > 01	•
530	SM	02 >	•

VOXAN

1000	CAFE' RACER	01 >	•
1000	ROADSTER	01 >	•

YAMAHA

125	TZR R ITALIA	92 > 94	•
250	TZR R	94 >	•
660	SZR	96 >	•



07BB16.06 100.1 x 51.7 x 7.6

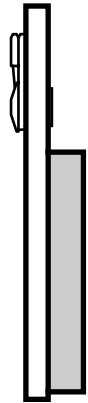
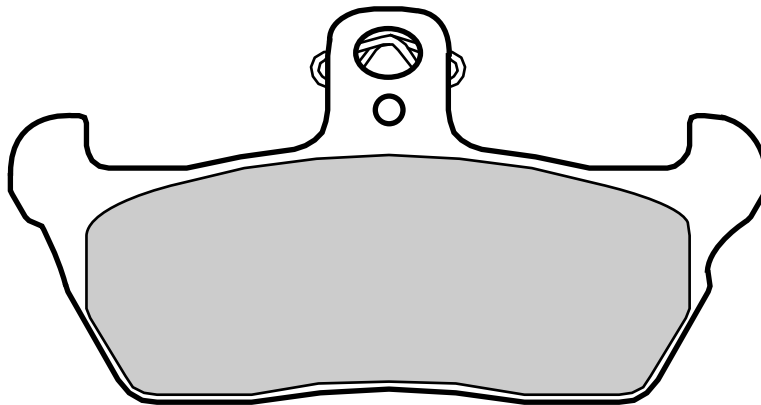

2



APRILIA

125 RX	91 > 91	•
125 TUAREG RALLY	90 > 91	•
350 TUAREG	88 >	•
350 TUAREG WIND	90 >	•
600 TUAREG	88 >	•
600 TUAREG WIND	90 >	•

CAGIVA

50 SUPER CITY	93 > 95	•
80 SUPER CITY	94 >	•
125 FRECCIA C10	88 > 89	•
125 FRECCIA C10 ANNIVERSARY	89 >	•
125 FRECCIA C12	89 >	•
125 K 7	90 > 92	•
125 MITO	90 > 91	•

125 N 90	90 > 91	•
125 SUPER CITY	92 >	•
125 TAMANACO	89 > 90	•
125 W8	92 > 98	•
125 W9	96 >	•
350 W12	92 >	•
500 W16	94 > 98	•
600 W16	94 >	•
750 ELEFANT BIFARO	90 >	•

GILERA

125 APACHE	91 > 93	•
600 R, RC	91 >	•

MOTO GUZZI

1000 QUOTA	92 > 95	•
------------	---------	---

MOTO MORINI

350 COGUARO	89 >	•
350 COGUARO NEW YORK	89 >	•
350 DART	87 > 89	•
350 EXCALIBUR	87 > 94	•
350 KANGURO	87 >	•
400 DART	90 >	•
501 COGUARO	89 >	•
501 EXCALIBUR	90 > 94	•
501 KANGURO	87 >	•
501 NEW YORK	89 > 91	•

SUZUKI

250 WOLF	90 >	•
----------	------	---

YAMAHA

125 TDR R ITALIA	92 >	•
------------------	------	---



2



07BB18.34
GENUINE

39.8 x 49.5 x 7

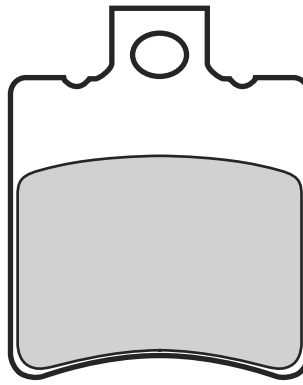

APRILIA

125 RX	85 > 85	•
250 RS	95 > 97	•
250 RS	98 > 01	•



BIMOTA

1000 SB8 K GOBERT	04 >	•
-------------------	------	---



GARELLI

125 TIGER XR	83 >	•
125 TIGER XRD	83 >	•



07BB19.07 75.1 x 55.5 x 8.7

07BB19.35 “ “ “
GENUINE

07BB19.73 “ “ “
GENUINE

07BB19.90 “ “ “
GENUINE

07BB19.SA “ “ “

07BB19.LA “ “ “

07BB19.SC “ “ “

07BB19.RC “ “ “

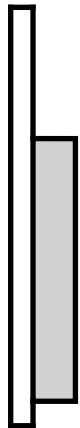
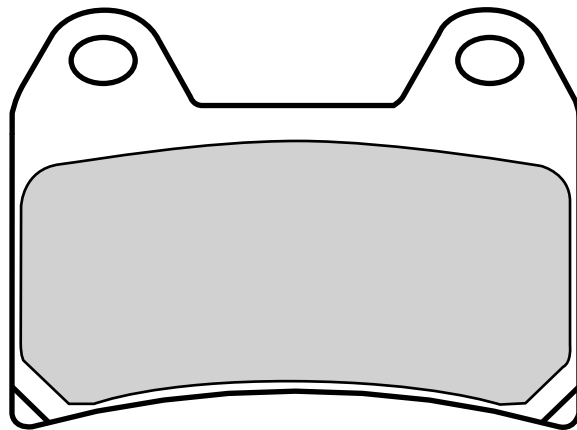

APRILIA

250 RS	98 > 01	•
650 PEGASO STRADA	05 >	•
750 DORSODURO FACTORY	11 > 16	•
750 SMV DORSODURO	08 > 08	•
1000 BLUE MARLIN	02 >	•
1000 RST FUTURA	01 > 04	•
1000 RSV	97 > 01	•
1000 RSV R	00 > 00	•
1000 RSV SP	99 >	•
1000 RSV TUONO 4R	11 >	•
1000 SL FALCO	00 > 04	•
1000 TUONO ABS	13 >	•
1000 TUONO FIGHTER	03 >	•
1000 TUONO V4R	11 > 13	•
1200 DORSODURO	12 > 15	•
1200 DORSODURO ABS	14 > 15	•

BENELLI

125 BORN IN HELL	98 > 99	•
402 S	18 >	•
500 LEONCINO	16 > 16	•
502 TRK	16 >	•

899 TNT	07 >	•
899 TRE 899 K	09 >	•
900 TORNADO 3	00 > 02	•
1130 TNT	04 > 05	•
1130 TNT	05 >	•
1130 TRE K	06 > 16	•

BIMOTA

900 DB4	99 >	•
1000 SB8 K GOBERT	04 >	•
1000 SB8 K SANTAMONICA	06 > 06	•
1000 SB8 R	98 >	•

BMW

650 G 650 XMOTO	07 > 12	•
800 F 800 GT	13 >	•
800 F 800 R	09 > 14	•
800 F 800 S	06 > 12	•
800 F 800 ST	06 > 12	•
800 F 800 ST TOURING	11 > 12	•
1170 R NINE T SCRAMBLER	16 >	•
1200 R NINE T PURE	17 >	•
1200 R NINE T RACER	17 >	•

1200 R NINE T URBAN GS 17 > •

CAGIVA

125 RAPTOR	05 >	•
650 RAPTOR	01 > 04	•
650 V-RAPTOR	01 > 05	•
1000 RAPTOR	00 > 06	•
1000 V-RAPTOR	00 > 06	•
1000 X3 RAPTOR	04 > 06	•
1000 XTRA RAPTOR	02 > 06	•

DUCATI

400 MONSTER 400	00 > 02	•
400 MONSTER 400 (MONODISCO)	05 >	•
400 MONSTER 400 DARK	05 > 05	•
600 MONSTER 600	00 > 01	•
600 MONSTER 600 DARK	00 > 01	•
600 MONSTER 600 DARK CITY	00 >	•
600 MONSTER 600 METALLIC	00 > 01	•





620	MONSTER 620 (BIDISCO)	05 > 06	•
620	MONSTER 620 DARK	03 >	•
620	MONSTER 620 DARK (MONODISCO)	04 > 04	•
620	MONSTER 620 I.E.	02 >	•
620	MONSTER 620 I.E DARK	02 > 05	•
620	MONSTER 620 S I.E.	02 > 05	•
620	MONSTER 620, DARK	05 > 06	•
620	MULTISTRADA 620 SD	03 >	•
748	748	00 > 02	•
748	748 BIPOSTO	99 > 99	•
748	748 R	00 > 00	•
748	748 S	00 > 02	•
748	748 SPS	98 > 99	•
750	750 SUPERSPORT	99 >	•
750	750 SUPERSPORT I.E.	00 > 02	•
750	750 SUPERSPORT S I.E.	02 >	•
750	MONSTER 750 DARK	00 > 01	•
750	MONSTER 750 DARK I.E.	02 > 02	•
750	MONSTER 750 METALLIC	00 > 01	•
750	SPORT	00 > 01	•
803	MONSTER 800	03 > 05	•
803	MONSTER 800 S I.E.	03 > 05	•
848	848	07 > 11	•
848	STREETFIGHTER	12 >	•
848	STREETFIGHTER S	12 >	•
900	MH 900 EVOLUTION	01 > 02	•
900	MONSTER 900 CROMO I.E.	00 > 01	•
900	MONSTER 900 DARK I.E.	01 > 01	•
900	MONSTER 900 I.E.	00 >	•
900	MONSTER 900 METALLIC I.E.	00 >	•
900	MONSTER 900 S I.E.	00 > 01	•
900	SPORT TOURING 4	99 >	•
900	SUPERSPORT 900	98 > 99	•
900	SUPERSPORT 900 I.E.	00 > 02	•
900	SUPERSPORT 900 S I.E.	02 > 02	•
916	MONSTER S4	02 > 03	•
916	MONSTER S4 FOGGY	02 > 03	•
916	ST4	99 > 99	•
916	ST4	00 > 03	•
916	ST4 S	03 > 04	•
916	ST4 S ABS	03 > 04	•
944	SPORT TOURING 2	99 > 00	•
992	ST3	04 > 07	•
992	ST3 ABS, ST3 S ABS	07 >	•
992	ST4, ST4 ABS	05 >	•
992	SUPERSPORT 1000	06 >	•
992	SUPERSPORT 1000 DS	05 >	•
992	SUPERSPORT 1000 S	03 >	•
996	996	99 >	•
996	996 S	00 >	•
996	996 SPS	99 >	•
996	996 SPS II	99 >	•
996	996 SPS III	00 >	•
996	MONSTER S4 R	03 > 03	•
996	MONSTER S4 R	04 >	•
998	998	02 >	•

998	998 MATRIX	04 >	•
1000	MONSTER 1000	04 > 05	•
1000	MONSTER 1000 S	05 >	•
1000	MONSTER 1000 S I.E.	03 >	•
1000	MONSTER S2 R 1000	06 > 08	•
1000	MULTISTRADA 1000 DS	03 > 06	•
1000	MULTISTRADA 1000 S DS	05 >	•
1100	HYPERMOTARD	07 > 09	•
1100	HYPERMOTARD EVO	10 > 12	•
1100	MONSTER	09 >	•
1100	MONSTER EVO ABS	11 >	•
1100	MONSTER S	09 >	•
1100	MULTISTRADA	07 > 09	•
1100	MULTISTRADA S	07 > 09	•
1200	MULTISTRADA	10 > 14	•
1200	MULTISTRADA ABS	10 >	•
1200	MULTISTRADA S GT	12 > 14	•
1200	MULTISTRADA S PIKES PEAK	11 > 14	•
1200	MULTISTRADA S TOURING	13 > 14	•
1200	MULTISTRADA TOURING ABS	10 > 14	•

HOREX

1200	VR6	11 >	•
------	-----	------	---

HUSQVARNA

570	NOX	01 > 03	•
610	LT	00 >	•
610	SM	98 > 99	•
610	SMS	00 > 04	•
610	TE E LT	00 >	•
630	SMR	04 >	•
690	VITPILEN 701	18 >	•
900	NUDA	12 > 14	•
900	NUDA ABS	12 > 14	•

KTM

625	SMC	05 >	•
640	DUKE II	99 > 04	•
640	DUKE II	05 > 07	•
640	LC4 SUPERMOTO	05 > 06	•
660	SMC	04 > 05	•
660	SMC	06 >	•
690	DUKE	15 >	•
690	DUKE ABS	12 >	•
690	SUPERMOTO	07 >	•
1050	ADVENTURE	15 > 16	•
1090	SUPER ADVENTURE	17 >	•
1090	SUPER ADVENTURE R	17 >	•
1190	ADVENTURE	13 > 16	•
1290	SUPER ADVENTURE	15 > 16	•
1290	SUPER ADVENTURE R	17 >	•
1290	SUPER ADVENTURE S	17 >	•
1290	SUPER ADVENTURE T	17 >	•

MOTO GUZZI

750	BREVA 750 I.E.	03 > 06	•
750	NEVADA	03 >	•
750	NEVADA CLASSIC I.E.	06 > 08	•

750	V7 CAFE' CLASSIC	10 > 10	•
750	V7 CLASSIC	09 > 12	•
750	V7 CLUBMAN RACER	10 >	•
750	V7 II RACER	15 > 16	•
750	V7 II SCRAMBLER	16 >	•
750	V7 II SPECIAL	15 > 16	•
750	V7 II STONE	15 > 16	•
750	V7 II STORNELLO	16 > 16	•
750	V7 II STORNELLO LTD EDITION	17 >	•
750	V7 III ANNIVERSARIO	17 >	•
750	V7 III CARBON	18 >	•
750	V7 III MILANO	18 >	•
750	V7 III RACER	17 >	•
750	V7 III ROUGH	18 >	•
750	V7 III SPECIAL	17 >	•
750	V7 III STONE	17 >	•
750	V7 RACER	11 > 14	•
750	V7 SPECIAL	12 > 14	•
750	V7 STONE	12 > 14	•
850	BREVA	06 > 07	•
850	GRISO	06 > 07	•
850	V9 BOBBER	16 >	•
850	V9 CUSTOM ROAMER	16 >	•
850	V9 X-TRACK	17 >	•
1100	BREVA	05 > 07	•
1100	BREVA ABS	05 > 07	•
1100	CALIFORNIA ALUMINIUM	03 >	•
1100	CALIFORNIA CLASSIC	06 >	•
1100	CALIFORNIA EV	01 >	•
1100	CALIFORNIA EV SPORT	01 > 02	•
1100	CALIFORNIA EV TOURING	02 > 05	•
1100	CALIFORNIA EV TOURING	03 > 05	•
1100	CALIFORNIA JACKAL	99 > 01	•
1100	CALIFORNIA JACKAL BASIC	01 >	•
1100	CALIFORNIA METAL	02 > 03	•
1100	CALIFORNIA SPECIAL	01 >	•
1100	CALIFORNIA SPECIAL ALUMINIUM	02 >	•
1100	CALIFORNIA SPECIAL SPORT	02 >	•
1100	CALIFORNIA STONE	01 > 05	•
1100	CALIFORNIA TITANIUM	03 > 04	•
1100	CALIFORNIA TOURING	06 > 08	•
1100	CALIFORNIA VINTAGE	06 > 12	•
1100	GRISO	05 > 08	•
1100	SPORT	01 >	•
1100	V11 BALLABIO	03 > 05	•
1100	V11 CAFE SPORT	03 > 05	•
1100	V11 COPPA ITALIA	04 > 05	•
1100	V11 LE MANS	01 > 02	•
1100	V11 LE MANS	01 >	•
1100	V11 LE MANS	03 > 05	•
1100	V11 NAKED	01 >	•
1100	V11 SCURA	02 >	•
1100	V11 SPORT	01 > 02	•
1100	V11 SPORT ROSSO	01 >	•
1200	BREVA	11 >	•
1200	GRISO 8V	07 > 13	•
1200	NORGE	06 > 07	•



1200 NORGE ABS	06 > 07	•
1200 NORGE GT 8V	08 > 16	•
1200 SPORT	06 >	•
1200 SPORT 4V	09 >	•
1200 SPORT 8V	12 >	•
1200 SPORT 8V SE	12 >	•
1200 SPORT ABS	06 >	•
1200 STELVIO	08 > 11	•
1200 STELVIO 8V SE	12 >	•
1200 STELVIO NTX	09 > 11	•
1400 AUDACE	15 >	•
1400 CALIFORNIA CUSTOM	13 >	•
1400 CALIFORNIA TOURING	13 >	•
1400 ELDORADO	15 >	•

MOTO MORINI

1200 1200 SPORT	09 >	•
1200 9 1/2	06 > 08	•
1200 CORSARO	06 > 08	•

MV AGUSTA

675 BRUTALE	12 >	•
675 F3	11 > 14	•
800 BRUTALE RC	18 >	•
800 BRUTALE RR	15 >	•
800 BRUTALE RR PIRELLI	18 >	•
800 DRAGSTER	15 >	•
800 DRAGSTER RC	17 >	•
800 DRAGSTER RR	15 >	•
800 DRAGSTER RR LH44	15 >	•
800 RVS#1	18 >	•
920 BRUTALE	10 > 11	•
989 BRUTALE R	08 >	•
990 BRUTALE R	10 >	•
1000 F4 LH 44	18 >	•
1090 BRUTALE R	12 >	•

MZ

1000 MUZ S	01 > 02	•
------------	---------	---

NORTON

961 COMMANDO SE	10 > 11	•
961 COMMANDO SF SPORT	11 >	•

SACHS

500 MADASS	05 >	•
------------	------	---

SUZUKI

1200 GSX	99 > 01	•
----------	---------	---

VOXAN

1000 EVO	04 >	•
----------	------	---

YAMAHA

400 XJR	95 >	•
660 XT X	04 >	•
850 TRX	95 >	•
1200 XJR ITALIA	95 > 98	•

**07BB20.35**
GENUINE

50.8 x 53.7 x 7.4

07BB20.65
GENUINE

" " "

07BB20.9A
GENUINE

" " "

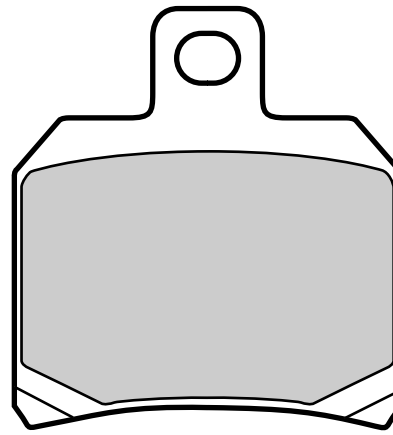
**APRILIA**

1000 BLUE MARLIN	02 >	•
1000 ETV CAPO NORD	01 > 03	•
1000 ETV CAPO NORD ABS	04 >	•
1000 ETV CAPO NORD RALLY RAID	04 >	•
1000 RSV	97 > 01	•
1000 RSV	02 > 06	•
1000 RSV 4RF	15 >	•
1000 RSV 4RR	15 >	•
1000 RSV FACTORY	03 > 06	•
1000 RSV NERA	04 >	•
1000 RSV R	00 > 00	•
1000 RSV R	01 >	•
1000 RSV SP	99 >	•
1000 RSV TUONO 4R	11 >	•
1000 RSV4 FACTORY	09 > 10	•
1000 RSV4 FACTORY APRC	11 > 12	•
1000 RSV4 FACTORY APRC ABS	13 >	•
1000 RSV4 R	10 > 16	•
1000 RSV4 R APRC ABS	14 >	•
1000 RSV4 RACING FACTORY ABS	18 >	•
1000 RSV4 RF	15 > 16	•
1000 RSV4 RR	15 > 16	•
1000 SL FALCO	00 > 04	•
1000 TUONO	13 >	•
1000 TUONO ABS	13 >	•
1000 TUONO FIGHTER	03 >	•
1000 TUONO R	03 >	•
1000 TUONO RACING	04 >	•
1000 TUONO V4R	11 > 13	•
1000 TUONO V4R APRC ABS	14 >	•
1100 TUONO V4 FACTORY	17 >	•
1100 TUONO V4 FACTORY RR	15 >	•
1100 TUONO V4 RR	17 >	•
1200 CAPONORD RALLY	15 >	•

BENELLI

300 BN 302	14 >	•
300 BN 302 TORNADO	16 >	•
302 TORNADO	16 >	•
500 LEONCINO	16 > 16	•

502 TRK	16 >	•
600 BN	14 > 16	•
600 BN GT	14 > 16	•
600 BN R	15 > 16	•
899 TNT	07 >	•
899 TNT CENTURY RACER	11 > 11	•
900 TORNADO 3	03 > 08	•
1130 TNT	04 > 05	•
1130 TNT	05 >	•
1130 TNT CAFE' RACER	05 > 08	•
1130 TNT CENTURY RACER	11 >	•
1130 TNT OFFICINE	07 >	•
1130 TNT R 160	10 > 16	•
1130 TNT SPORT	05 > 06	•
1130 TNT TITANIUM	05 > 08	•
1130 TORNADO TRE	06 > 08	•
1130 TORNADO TRE R	13 >	•
1130 TRE K	06 > 16	•
1130 TRE K AMAZONAS	13 > 16	•

BIMOTA

800 TESI 3D RACECAFE'	16 >	•
1000 BB3	13 >	•
1078 TESI 3D NAKED	16 >	•
1100 TESI 3D	07 >	•
1198 DB8	10 >	•
1198 IMPETO	16 >	•
1200 DB11 VLX (RED CALL)	13 >	•
1200 DB12	12 >	•

BOMBARDIER-CAN AM

500 TRAXTER 4X4	99 > 00	• •
-----------------	---------	-----

CAGIVA

650 RAPTOR	01 > 04	•
650 V-RAPTOR	01 > 05	•
1000 RAPTOR	00 > 06	•
1000 V-RAPTOR	00 > 06	•
1000 X-RAPTOR	03 > 06	•
1000 X3 RAPTOR	04 > 06	•
1000 XTRA RAPTOR	02 > 06	•

DUCATI

400 SCRAMBLER	15 >	•
---------------	------	---

620 MULTISTRADA 620 SD	03 >	•
659 monster 659	12 > 13	•
659 MONSTER 659 ABS	12 > 14	•
696 MONSTER 696	08 > 08	•
696 MONSTER 696 / MONSTER 696 +	09 > 10	•
696 MONSTER 696 ABS	10 > 14	•
696 MONSTER 696 ANNIVERSARY / ABS	13 > 13	•
748 749	03 > 07	•
748 749 DARK	05 > 06	•
748 749 R	03 > 07	•
748 749 S	03 > 07	•
795 MONSTER 795	12 > 15	•
795 MONSTER 795 ABS	13 > 15	•
795 MONSTER 795 ABS CORSE STRIPE	14 > 14	•
796 HYPERMOTARD	10 >	•
796 MONSTER	11 >	•
796 MONSTER 796	11 >	•
796 MONSTER 796 ABS	11 >	•
796 MONSTER 796 ABS	13 >	•
796 MONSTER 796 ANNIVERSARY	13 >	•
796 MONSTER 796 ANNIVERSARY	13 >	•
803 HYPERMOTARD SP	13 >	•
803 HYPERSTRADA	13 >	•
821 HYPERMOTARD SP	13 > 15	•
821 MONSTER 821	15 >	•
821 MONSTER 821 DARK	15 > 16	•
821 MONSTER 821 STRIPE	15 >	•
848 848	07 > 11	•
848 848 EVO	11 > 13	•
848 STREETFIGHTER	12 >	•
848 STREETFIGHTER S	12 >	•
899 PANIGALE	14 > 15	•
900 MH 900 EVOLUTION	01 > 02	•
939 HYPERMOTARD	16 >	•
939 HYPERMOTARD SP	16 >	•
939 HYPERSTRADA	16 >	•
939 SUPERSPORT	17 >	•
939 SUPERSPORT S	17 >	•
959 PANIGALE	16 >	•
959 PANIGALE CORSE	18 >	•



990	DESMOSEDICI RR (D16RR)	07 > 08	•
998	999	03 > 07	•
998	999 R	03 > 07	•
998	999 S	03 > 07	•
999	999 XEROX	06 >	•
1000	MULTISTRADA 1000 DS	03 > 06	•
1000	MULTISTRADA 1000 S DS	05 >	•
1098	1098 R BAYLISS	09 >	•
1098	STREETFIGHTER	09 >	•
1098	STREETFIGHTER S	09 >	•
1099	1098	07 > 09	•
1099	1098 S	07 > 09	•
1099	1098 TRICOLORE	07 > 09	•
1100	HYPERMOTARD	07 > 09	•
1100	HYPERMOTARD EVO	10 > 12	•
1100	HYPERMOTARD EVO SP	10 > 12	•
1100	HYPERMOTARD S	07 > 09	•
1100	MONSTER	09 >	•
1100	MONSTER EVO ABS	11 >	•
1100	MONSTER S	09 >	•
1100	MULTISTRADA	07 > 09	•
1100	MULTISTRADA S	07 > 09	•
1103	PANIGALE V4	18 >	•
1103	PANIGALE V4 S	18 >	•
1103	PANIGALE V4 SPECIALE	18 >	•
1198	1098 BAYLISS	09 > 09	•
1198	1098 R	08 >	•
1198	1198	09 >	•
1198	1198 S	09 >	•
1198	1198 SP	11 >	•
1199	PANIGALE	12 >	•
1199	PANIGALE R	13 >	•
1199	PANIGALE S	12 >	•
1199	SUPERLEGGERA	14 >	•
1200	DIAVEL TITANIUM	15 >	•
1200	MONSTER	14 >	•
1200	MONSTER R	15 >	•
1200	MONSTER S	14 >	•
1200	MONSTER S STRIPE	15 >	•
1200	MULTISTRADA	10 > 14	•
1200	MULTISTRADA ABS	10 >	•
1200	MULTISTRADA S GT	12 > 14	•
1200	MULTISTRADA S PIKES PEAK	11 > 14	•
1200	MULTISTRADA S TOURING	13 > 14	•
1200	MULTISTRADA TOURING ABS	10 > 14	•
1262	XDIAVEL	16 >	•
1262	XDIAVEL S	16 >	•

1299	PANIGALE	15 >	•
1299	PANIGALE R	15 >	•
	PANIGALE R FINAL EDITION	18 >	•
1299	PANIGALE S	15 >	•
	PANIGALE S ANNIVERSARIO	17 >	•
1299	PANIGALE SUPERLEGGERA	17 >	•

ENERGICA

11.7	EGO	15 >	•
11.7	EVA	15 >	•
11.7	EVA ESSEESSE 9	18 >	•

HONDA

1000	RCV213V	15 >	•
1000	RCV213V	16 > 18	•

HOREX

1200	CAFE RACER	17 >	•
1200	CLASSIC	17 >	•
1200	VR6	11 >	•

KAWASAKI

1000	H2	15 >	•
1000	H2 R	15 >	•
1000	ZX H2 CARBON NINJA	17 > 18	•
1000	ZX H2 NINJA	15 > 18	•
1000	ZX H2R NINJA	17 > 18	•

KTM

1190	RC8	08 > 16	•
1190	RC8 R	09 > 16	•
1190	RC8 R TRACK	11 > 16	•
1290	SUPER DUKE GT	16 >	•
1290	SUPER DUKE R	14 >	•

LAVERDA

1000	SFC (LIMITED EDITION)	03 >	•
------	-----------------------	------	---

MONDIAL

1000	PIEGA	02 >	•
1000	PIEGA EVO	04 >	•
1000	PIEGA RZ NUJA	04 >	•

MOTO GUZZI

750	V7 CAFE' CLASSIC	10 > 10	•
750	V7 CLASSIC	09 > 12	•
750	V7 CLUBMAN RACER	10 >	•

750	V7 RACER	11 > 14	•
750	V7 SPECIAL	12 > 14	•
750	V7 STONE	12 > 14	•

MOTO MORINI

1200	1200 SPORT	09 >	•
1200	9 1/2	06 > 08	•
1200	CORSARO	06 > 08	•
1200	CORSARO 1200ZZ	18 >	•
1200	SCRAMBLER	18 >	•

MV AGUSTA

675	BRUTALE	12 >	•
675	F3	11 > 14	•
675	F3	15 >	•
675	F3 RC	16 >	•
675	F3 RC	18 >	•
800	BRUTALE RC	18 >	•
800	BRUTALE RR	15 >	•
800	BRUTALE RR PIRELLI	18 >	•
800	DRAGSTER	15 >	•
800	DRAGSTER RC	17 >	•
800	DRAGSTER RR	15 >	•
800	DRAGSTER RR LH44	15 >	•
800	F3	13 >	•
800	F3 AMG GT	16 >	•
800	F3 RC	16 >	•
800	RIVALE	13 >	•
800	RVS#1	18 >	•
800	STRADALE	15 >	•
800	TURISMO VELOCE	14 >	•
800	TURISMO VELOCE LUSSO	14 >	•
800	TURISMO VELOCE RC	17 >	•
1000	F4 LH 44	18 >	•
1000	F4 RC	17 >	•
1000	F4 RC	18 >	•

NORTON

961	COMMANDO CAFE' RACER	11 > 17	•
961	COMMANDO SE	10 > 11	•
961	COMMANDO SE	12 >	•
961	COMMANDO SF	13 >	•
961	COMMANDO SF SPORT	11 >	•
961	DOMINATOR NAKED	15 >	•
1200	K5X	18 >	•
1200	V4 RR	17 >	•

PIAGGIO

125	LIBERTY	18 >	•
-----	---------	------	---





07BB21.07 57.6 x 53.6 x 8.9

07BB21.SA “ “ “

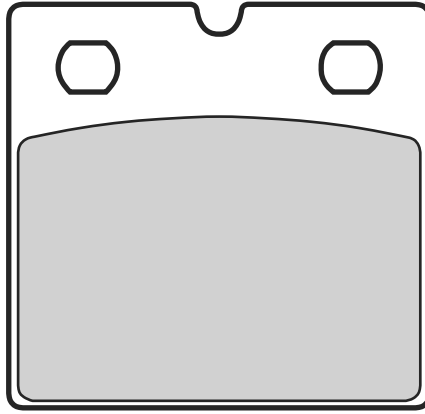

BMW

750	K 75 ABS (SPECIAL CALIPER)	91 >	•
750	K 75 RT	89 > 96	•
800	R 80 R	93 >	•
1000	K 100 ABS (SPECIAL CALIPER)	91 >	•
1000	R 100 RS	93 >	•



07BB22.07 99.6 x 55.6 x 8.3

07BB22.SA “ “ “

07BB22.LA “ “ “

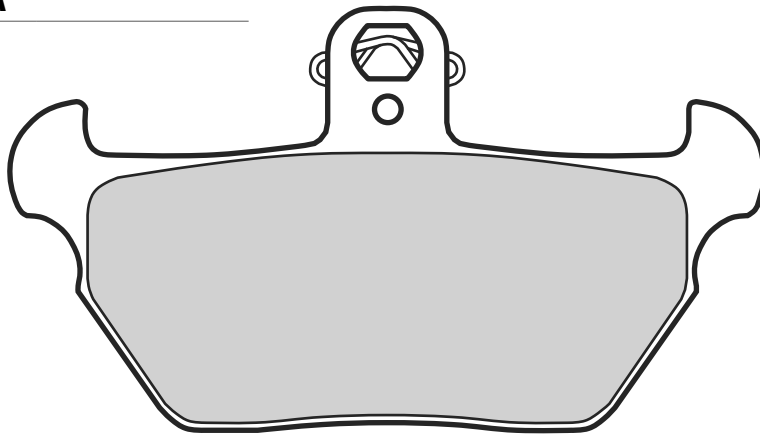

BMW

800	R 80 R	92 > 92	•
1000	K 1	88 > 93	•
1000	K 100 LT	92 >	•
1000	K 100 RS 16V	90 >	•
1000	R 100 R	91 > 91	•

1000	R 100 R	92 > 97	•
1100	K 1100 LT (no ABS)	92 > 98	•
1100	K 1100 RS	93 > 96	•
1100	R 1100 RS	93 > 93	•



07BB23.07

59.7 x 58.5 x 9

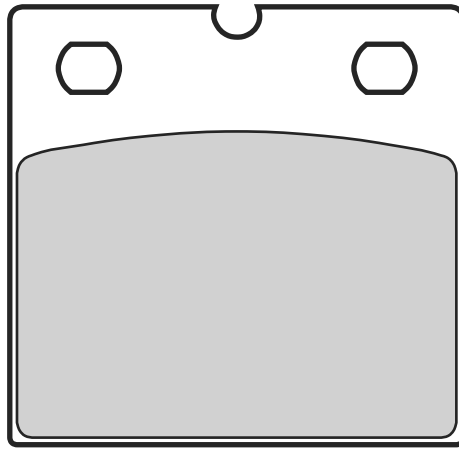

2



BENELLI

900 SEI 78 > 86 •

1000 R 100 GS 88 > 97 •
1000 R 100 RT 91 > 95 •

1000 CALIFORNIA II 83 > 86 •
1000 GS CONVERT GERMANIA 75 > •
1000 SP 1000 78 > •

BMW

650 R 65/1 86 > 92 •
800 R 80 GS 88 > •
800 R 80 RT 85 > •

MOTO GUZZI

850 LE MANS 76 > 80 •
850 T3 CALIFORNIA 76 > 85 •
850 T3 GERMANIA 75 > 85 •

TRIUMPH

750 BONNEVILLE 84 > 86 •



07BB24.07

100 x 56.1 x 8.4

07BB24.SA

“ “ “

07BB24.LA

“ “ “

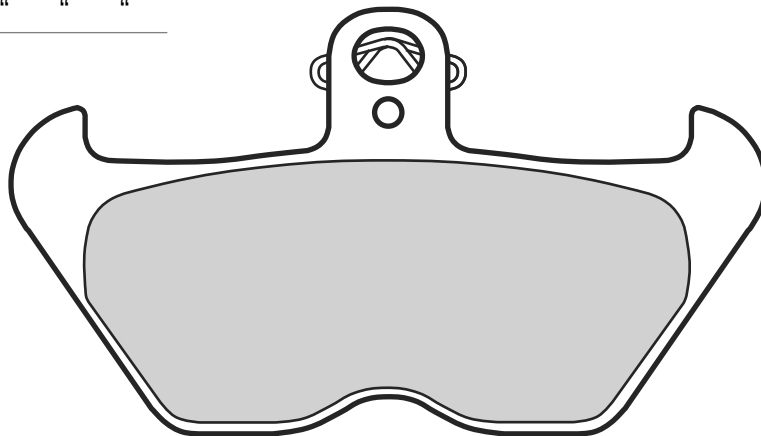

BMW

850 R 850 C 99 > •
850 R 850 GS 99 > •
850 R 850 R 96 > 02 •
850 R 850 ROADSTER 96 > 02 •

850 R 850 RT 98 > 00 •
1100 R 1100 GS 94 > 99 •
1100 R 1100 R 95 > 01 •
1100 R 1100 RS 94 > 02 •
1100 R 1100 RT 95 > •

1100 R 1100 S 99 > 00 •
1150 R 1150 GS 98 > 01 •
1200 K 1200 LT 99 > 00 •
1200 K 1200 RS 97 > 00 •
1200 R 1200 C 98 > 02 •



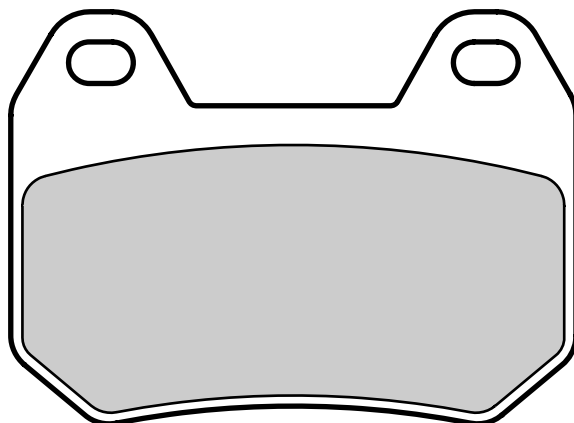

07BB25.07 74.9 x 54.6 x 8.9

**BMW**

1200 K 1200 LT	99 > 00	•
1200 K 1200 LT ABS	01 > 03	•
1200 R 1200 CL	03 > 04	•



07BB26.07 77 x 51.4 x 8.6

07BB26.SA “ “ “

07BB26.LA “ “ “

07BB26.SC “ “ “

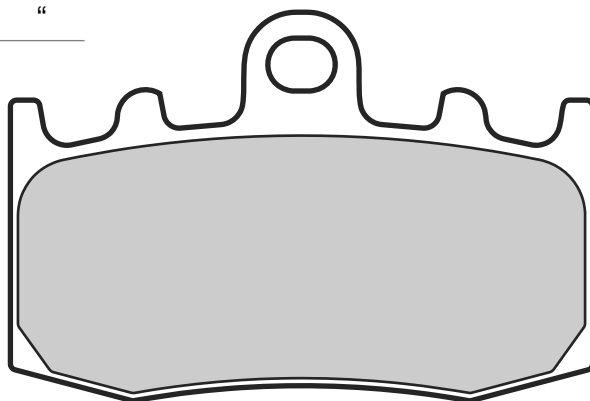
**BMW**

850 R 850 RT ABS	01 >	•
1100 R 1100 S	01 >	•
1150 R 1150 GS	02 > 03	•
R 1150 GS ADVENTURE ABS INTEGRALE	01 > 05	•
1150 R 1150 RT	01 > 06	•
1200 HP2 MEGAMOTO	07 > 12	•

1200 K 1200 GT	02 > 04	•
1200 K 1200 GT ABS	02 > 04	•
1200 K 1200 RS	01 > 06	•
1200 K 1200 S	05 > 08	•
1200 K 1200 S ABS	05 > 08	•
1200 R 1200 CL	03 > 04	•
1200 R 1200 GS	04 > 12	•
1200 R 1200 GS ABS	04 > 12	•

1200 R 1200 GS ADVENTURE	06 > 13	•
R 1200 GS TRIPPLE BLACK	11 > 13	•
1200 R 1200 RT	05 > 13	•
1200 R 1200 S	06 >	•
1200 R 1200 ST	06 >	•
1300 K 1300 GT	09 > 11	•
1300 K 1300 S	09 > 16	•



07BB27.5A
GENUINE 64 x 41.8 x 11

07BB27.SD 64 x 41.8 x 9

07BB27.SX “ “ “

07BB27.TT “ “ “

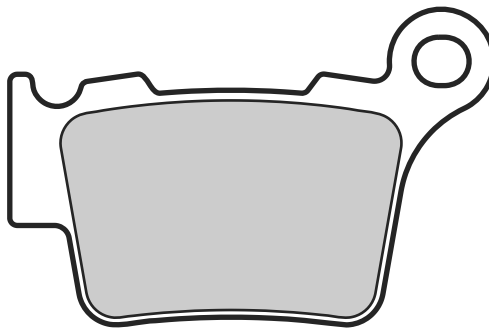
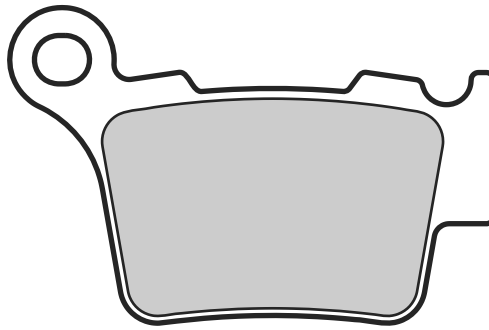

BMW

450 ENDURO	08 >	•
450 G 450 SMR	09 > 12	•
450 G 450 X	09 > 12	•

HUSABERG

125 TE	13 > 14	•
250 FE	13 > 14	•
250 TE	11 > 14	•
300 TE	11 > 14	•
350 FE	13 > 14	•
390 FE	10 > 14	•
450 FE	09 > 14	•
501 FE	13 > 14	•
570 FE	09 > 12	•

HUSQVARNA

125 CR	05 > 13	•
125 TC	14 >	•
125 TE	11 > 12	•
125 TE	14 >	•
125 TE 4T	11 > 13	•

125 WR	05 >	•
250 CR	05 >	•
250 FC	14 >	•
250 FE	14 >	•
250 SMR	06 >	•
250 TC	14 >	•
250 TE	14 >	•
250 TE 4T	10 > 13	•
300 TC	14 >	•
300 TE	14 >	•
300 WR	09 > 13	•
310 TE	10 > 12	•
310 TE 4T	10 >	•
350 FC	14 >	•
350 FE	14 >	•
449 SMR	11 > 13	•
449 TC 449	04 > 13	•
449 TE 449	06 > 13	•
450 FC	14 >	•
450 FE	14 >	•
450 FS	15 >	•
450 SMR	06 > 13	•
450 SMR R	06 >	•

501 FE	14 >	•
510 SM CENTENNIAL	06 >	•
510 SMR	06 >	•
510 TC 511	05 > 10	•
510 TE 511	06 >	•
510 TE CENTENNIAL	04 >	•
511 SMR	11 >	•
630 SM	10 >	•

KTM

125 EXC	04 >	•
125 EXC SIX DAYS	09 >	•
125 SX	04 >	•
144 SX	07 > 08	•
150 SX	09 >	•
200 EXC	04 >	•
200 SX	04 >	•
250 EXC	04 >	•
250 EXC F	06 >	•
250 EXC F SIX DAYS	09 >	•
250 EXC RACING	05 >	•
250 EXC TPI	18 >	•





250 SX	03 >	•
250 SX-F	06 >	•
250 SXC	03 >	•
300 EXC	04 >	•
300 EXC SIX DAYS	09 >	•
300 EXC TPI	18 >	•
300 SX	06 >	•
350 EXC F	11 >	•
350 EXC F SIX DAYS	11 >	•
350 SXF	11 >	•
400 EXC RACING	05 >	•
450 EXC	04 >	•
450 EXC R	05 > 06	•
450 EXC R	07 >	•
450 SM FACTORY REPLICA	04 >	•
450 SMR	04 > 06	•
450 SMR	07 > 12	•
450 SMR	13 > 16	•
450 SX	04 >	•
450 SX RACING	05 >	•
450 SXF	07 >	•
450 XC-F	08 >	•
500 EXC F	12 > 18	•

505 505 XC-F	09 >	•
505 SX-F	07 >	•
525 EXC	04 >	•
525 EXC RACING	05 >	•
525 SMR	04 > 04	•
525 SMR	05 >	•
525 SX	04 >	•
525 SX RACING	05 >	•
525 XC DESERT RACING	04 >	•
530 EXC	08 >	•
530 EXC R	08 > 08	•
560 SMR	06 >	•
660 SMC	04 > 05	•

RIEJU

250 MRX MARATHON	10 >	•
450 MRX	08 >	•

SHERCO

125 SE-R	17 >	•
250 I/IR	12 >	•
250 SE R	14 >	•

250 SEF	14 >	•
250 SEI-F	14 >	•
250 SX 2.5	11 >	•
300 I/IR	12 >	•
300 SE R	14 >	•
300 SEF	14 >	•
300 SEI-F	13 >	•
450 IR	12 >	•
450 SEF	14 >	•
510 IR	12 >	•

SUZUKI

650 SU 650X	18 >	•
-------------	------	---

SWM

125 RS R	16 >	•
125 SM R	16 >	•
250 MC S	16 >	•
300 RS R	15 >	•
340 RS S	16 >	•
450 SM R	15 >	•
500 RS R	15 >	•



07BB28.09 94 x 36.2 x 8.6

07BB28.SP “ “ “

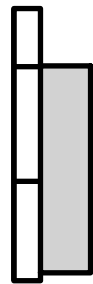
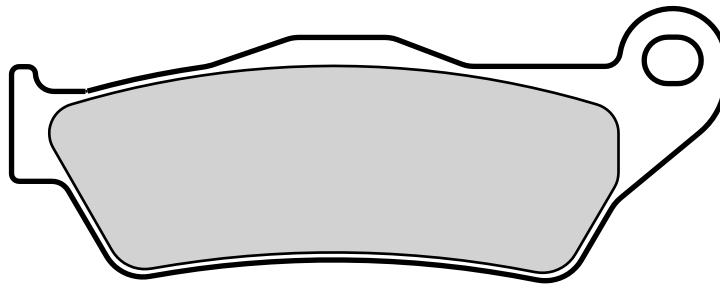
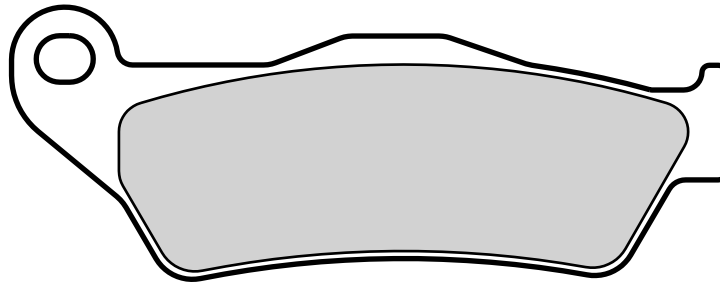

BMW

850 R 850 C	99 >	•
850 R 850 GS	99 >	•
850 R 850 R	96 > 02	•
850 R 850 R	03 >	•
850 R 850 ROADSTER	96 > 02	•
850 R 850 RT	98 > 00	•
850 R 850 RT ABS	01 >	•
1000 S 1000 XR	15 >	•
1100 R 1100 GS	94 > 99	•
1100 R 1100 R	95 > 01	•
1100 R 1100 RS	94 > 02	•
1100 R 1100 RT	95 >	•
1100 R 1100 S	99 > 00	•
1100 R 1100 S	01 >	•
1100 R 1100 S ABS	01 >	•

1150 R 1150 GS	98 > 01	•
1150 R 1150 GS	02 > 03	•
1150 R 1150 GS	04 > 05	•
1150 R 1150 GS ADVENTURE ABS INTEGRALE	01 > 05	•
1150 R 1150 GS ADVENTURE NO ABS INTEGRALE	02 > 05	•
1150 R 1150 R	01 > 06	•
1150 R 1150 R ROCKSTER	02 > 06	•
1150 R 1150 RS	01 > 06	•
1150 R 1150 RT	01 > 06	•
1150 R 1150 S	03 > 06	•
1200 HP2 MEGAMOTO	07 > 12	•
1200 K 1200 R	05 >	•
1200 K 1200 R SPORT	07 > 11	•
1200 K 1200 S	05 > 08	•

1200 K 1200 S ABS	05 > 08	•
1200 R 1200 C	98 > 02	•
1200 R 1200 C	03 > 04	•
1200 R 1200 GS	04 > 12	•
1200 R 1200 GS ABS	04 > 12	•
1200 R 1200 GS ADVENTURE	06 > 13	•
1200 R 1200 GS TRIPPLE BLACK	11 > 13	•
1200 R 1200 R	07 > 14	•
1200 R 1200 RT	05 > 13	•
1200 R 1200 S	06 >	•
1200 R 1200 ST	06 >	•
1300 K 1300 GT	09 > 11	•
1300 K 1300 R	09 > 16	•
1300 K 1300 R DYNAMIC	11 > 16	•
1300 K 1300 S	09 > 16	•





07BB31.35
GENUINE

39.8 x 56.2 x 7.9

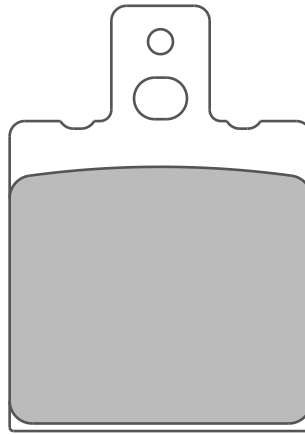

2



ALFER

80	MC	87 >	•
125	MC	87 > 87	•
125	MC	88 >	•
250	GR ENDURO	85 > 87	•
250	GR ENDURO	88 >	•
250	MC	85 > 86	•
250	MC	87 > 87	•
250	MC	88 >	•
300	GR	85 >	•
300	GR ENDURO	88 >	•

APRILIA

50	TUONO	04 >	•
125	CLASSIC	96 >	•
125	ETX	86 > 87	•
125	RED ROSE	87 > 89	•
125	RED ROSE	90 > 94	•
125	RS	99 > 05	•
125	RS PISTA	04 > 05	•
125	SPORT PRODUCTION	92 >	•
125	TUONO	04 >	•
200	CLIMBER	93 >	• •
250	TUAREG RALLY	86 >	•
350	ETX	86 >	•
600	ETX	86 >	•
600	TUAREG	86 > 87	•
600	TUAREG WIND	88 > 89	•

BENELLI

125	2C 4-STROKE	70 > 85	•
125	BX	89 > 91	•
125	CUSTOM	85 > 89	•
125	JARNO	89 > 93	•
350	354 TURISMO, SPORT	83 > 85	•
900	TORNADO 3	00 > 02	•

BETA

50	KR TWIN	88 >	• •
50	S02	97 >	•
50	TEMPO	97 > 98	•
250	GS	82 >	•
250	RV	82 >	•
260	ALP	96 >	•
500	GS	82 >	•
500	RV	82 >	•

BIMOTA

500	V-DUE	97 >	•
650	BB1 SUPERMONO	97 >	•
750	SB7	94 >	•
900	DB4	99 >	•
900	MANTRA	97 >	•
1000	SB8 K SANTAMONICA	06 > 06	•
1000	SB8 K SANTAMONICA	07 >	•
1000	SB8 R	98 >	•
1000	YB 11	97 >	•
1100	SB6	97 >	•

CAGIVA

50	PRIMA	92 > 92	• •
50	SUPER CITY	92 > 92	• •
80	SUPER CITY	92 > 93	• •
80	SUPER CITY	94 >	•
125	BLUES	89 > 93	•
125	DAKAR	89 > 90	•
125	K 7	90 > 92	•
125	N1	96 >	•
125	SP MITO 525	08 > 12	•
125	SUPER CITY	92 >	•
200	ELEFANT	85 > 87	•
350	ALA AZZURRA	83 >	• •
350	ALA BLU	83 >	•



350	ALA VERDE	83 >	•
350	W12	92 >	•
500	CROSS	80 >	•
750	LUCKY EXPLORER	88 >	•

DB MOTORS

50	ZZ PIRAT	00 >	•
50	ZZ SPORT	00 >	•

DERBI

125	MULHACEN	07 > 07	•
-----	----------	---------	---

DUCATI

350	350 SUPERSPORT	92 > 97	•
350	F3	88 >	• •
350	XL	82 >	•
400	400 SUPERSPORT	93 > 97	•
400	MONSTER 400	95 > 97	•
400	MONSTER 400 (MONODISCO)	05 >	•
400	MONSTER 400 DARK	05 > 05	•
500	502 SINGLE	93 >	•
500	502 SUPERMONO	93 >	•
600	600 SUPERSPORT	91 > 97	•
600	MONSTER 600	93 > 99	•
600	MONSTER 600	00 > 01	•
600	MONSTER 600 CITY	99 > 99	•
600	MONSTER 600 DARK	98 > 99	•
600	MONSTER 600 DARK	00 > 01	•
600	MONSTER 600 DARK CITY	98 > 99	•
600	MONSTER 600 DARK CITY	00 >	•
600	MONSTER 600 METALLIC	00 > 01	•



620	MONSTER 620 (BIDISCO)	05 > 06	•
620	MONSTER 620 DARK	03 >	•
620	MONSTER 620 DARK (MONODISCO)	04 > 04	•
620	MONSTER 620 DARK (MONODISCO)	05 >	•
620	MONSTER 620 I.E.	02 >	•
620	MONSTER 620 I.E. DARK	02 > 05	•
620	MONSTER 620 S I.E.	02 > 05	•
620	MONSTER 620, DARK	05 > 06	•
620	MULTISTRADA 620 (BIDISCO)	05 >	•
620	MULTISTRADA 620 DARK (MONODISCO)	05 >	•
650	SL	84 >	•
748	748 BIPOSTO	95 > 97	•
748	748 SP	95 > 97	•
750	750 SUPERSPORT	91 > 98	•
750	F1	85 > 88	•
750	INDIANA	89 >	•
750	MONSTER 750 (BIDISCO)	96 > 98	•
750	MONSTER 750 (MONODISCO)	96 > 97	•
750	MONSTER 750 CITY, DARK CITY	99 > 02	•
750	MONSTER 750 DARK	00 > 01	•
750	MONSTER 750 DARK I.E.	02 > 02	•
750	MONSTER 750 METALLIC	00 > 01	•
750	SPORT	74 > 76	•
803	MONSTER 800	03 > 05	•
803	MONSTER 800 S I.E.	03 > 05	•
803	MONSTER S2 R	05 > 07	•
803	MONSTER S2 R DARK	05 > 06	•
888	888 SP	92 >	•
888	888 SP4	92 >	•
888	888 SP5	93 >	•
888	888 SUPERBIKE STRADA	94 > 95	•
900	FE	97 >	•
900	MONSTER 900	93 > 99	•
900	MONSTER 900 CITY	99 > 01	•
900	MONSTER 900 CROMO	98 > 01	•
900	MONSTER 900 CROMO I.E.	00 > 01	•
900	MONSTER 900 DARK CITY	99 > 01	•
900	MONSTER 900 DARK I.E.	01 > 01	•
900	MONSTER 900 I.E.	00 >	•
900	MONSTER 900 METALLIC I.E.	00 >	•
900	MONSTER 900 S I.E.	00 > 01	•
900	MONSTER 900 SPECIAL	98 >	•
900	SUPERLIGHT 900	92 > 97	•
907	907 I.E.	92 > 93	•
916	MONSTER S4	02 > 03	•
916	MONSTER S4 FOGGY	02 > 03	•
996	MONSTER S4 R	04 >	•

998	MONSTER S4 R TESTASTRETTA	07 >	•
998	MONSTER S4 RS TESTASTRETTA	06 >	•
1000	MONSTER 1000	04 > 05	•
1000	MONSTER 1000 S	05 >	•
1000	MONSTER 1000 S I.E.	03 >	•
1000	MONSTER S2 R 1000	06 > 08	•

FANTIC MOTOR

250	COACH	91 >	•
-----	-------	------	---

GARELLI

50	TIGER XLE	86 >	• •
50	URKA	91 >	•

GILERA

50	SIOUX	92 >	• •
125	ARIZONA	83 >	•
125	CHRONO	91 >	•
125	CX	91 >	•
125	FAST BIKE	88 >	•
125	FREESTYLE	92 >	•
125	MX	83 >	•
125	MX1	88 >	•
125	R1	88 >	•
125	SP 01	89 >	•
125	SP 02	89 >	•
125	XR1	88 >	•
125	XR2	88 >	•
200	ARIZONA	85 >	•
200	FAST BIKE	88 >	•
200	RV	85 > 85	•
200	RV	86 >	•
250	MX LC	83 >	•
350	DAKOTA	89 >	•
350	XRT	89 >	•
500	DAKOTA	86 >	•
600	NORDWEST	90 >	•
600	XRT	89 >	•

HONDA

50	CRE	93 >	•
----	-----	------	---

HRD

125	STRADA	83 >	• •
-----	--------	------	-----

HUSQVARNA

125	CX	84 > 85	•
400	ENDURO	85 >	•
430	ENDURO	85 >	•
500	CR	84 > 86	•
500	CX	84 > 85	•
500	TC	86 >	•
510	TE	86 >	•
540	504	83 >	•

ITALJET

350	350	83 >	•
-----	-----	------	---

KTM

50	MX	91 >	•
80	MX	91 >	•
85	MX	90 >	•
125	MX	86 > 88	• •

LAVERDA

50	ATLAS	86 >	• •
50	GAUCHO	92 >	• •
125	FL	82 >	•
650	FORMULA	94 > 95	•
650	GHOST	96 >	•
650	SPORT	94 > 95	•
650	STRADA	96 >	•
668	668	96 >	•
668	DIAMANTE	96 > 98	•
668	GHOST STRIKE LEGEND	96 > 98	•
750	CUP	98 >	•
750	DIAMANTE	97 >	•
750	GHOST STRIKE	97 >	•
750	S	97 > 98	•
750	S FORMULA	99 > 00	•
750	S SCARENATO	97 > 98	•
750	S SPORT	99 > 00	•
750	STRIKE BIFARO	98 > 99	•
750	STRIKE MONOFARO	98 > 99	•
750	T8	98 >	•

MAICO

250	GM LC	85 >	•
-----	-------	------	---

MALAGUTI

50	ENDURO	85 >	•
50	MRX	89 >	•
50	RST	89 >	• •

MONTESA

260	EVASION	92 >	•
309	COTA	89 >	•
310	COTA	89 >	•
311	COTA TRIAL	92 >	•

MOTO GUZZI

125	BX	92 >	• •
125	CUSTOM	85 >	•
125	ENDURO TT	85 >	•
250	TS	75 > 76	•
350	FALCO	88 >	• •
350	IMOLA	78 >	• •
350	NEVADA	92 >	• •
350	NTX	88 > 89	•
350	NTX	90 >	•
350	V 35 FLORIDA	87 >	•
400	400	77 >	• •
650	NTX	87 > 90	•
650	V 65	86 >	•
650	V 65 FLORIDA	87 >	•
650	V 65 LARIO	87 >	•
650	V 65 TT	84 >	• •
750	NEVADA	92 > 96	•
750	NEVADA	97 > 02	• •





750	NTX	89 > 89	•
750	TARGA	89 >	•
1000	V	93 >	•

MOTO MORINI

250	COUNTRY	88 >	•
350	COGUARO	89 >	•
350	COGUARO NEW YORK	89 >	•
350	INDIANA	88 >	•
350	KANGURO	87 >	•
501	KANGURO	87 >	•
501	NEW YORK	89 > 91	•
650	INDIANA	88 >	•
750	INDIANA	88 >	•

MZ

660	SKORPION CUP MUZ	99 >	•
-----	------------------	------	---

660	SKORPION REPLICA MUZ	97 >	•
660	SKORPION SPORT MUZ	95 > 99	•
660	SKORPION TOUR MUZ	95 > 99	•
660	SKORPION TRAVELLER MUZ	99 >	•

OSSA

500	YANQEE	78 >	•
-----	--------	------	---

SACHS

80	LOTUS SW	70 >	•
----	----------	------	---

SIMSON

50	HABICT	01 >	•
50	SPATZ	99 >	•

50	SPERBER	99 >	•
80	SR	70 >	•

SWM

125	GP	86 >	• •
125	S1-S2	70 >	•
250	EXPLORER	86 >	• •
250	PIONER	86 >	• •
250	S1-S2	70 >	•
329	TRL	86 >	•

YAMAHA

125	TDR R ITALIA	92 >	•
125	TZR R ITALIA	92 > 94	•
660	SZR	96 >	•



07BB32.35
GENUINE

50.8 x 53.7 x 7.9

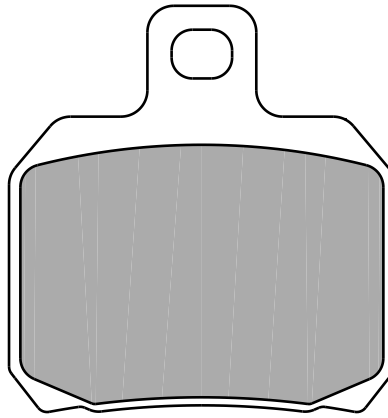

2



BENELLI

899 TRE 899 K 09 > •

BIMOTA

1000 DB5 05 > •

1000 DB6 R DELIRIO 06 > •

1098 DB7 08 > •

1100 DB6 R DELIRIO 08 > •

DERBI

50 GPR NUDE 04 > •

50 GPR RACING 04 > •

125 GP1 05 > •

659 MULHACÉN 06 > •

659 MULHACÉN CAFE' 08 > •

DUCATI

620 SUPERSPORT 620 S 03 > •

750 750 SUPERSPORT 99 > •

750 750 SUPERSPORT I.E. 00 > 02 •

750 750 SUPERSPORT S I.E. 02 > •

750 SPORT 00 > 01 •

803 SUPERSPORT 800 06 > •

803 SUPERSPORT 800 S 03 > 06 •

803 SUPERSPORT 800 SS 03 > •

900 SPORT TOURING 4 99 > •

900 SUPERSPORT 900 98 > 99 •

900 SUPERSPORT 900 I.E. 00 > 02 •

900 SUPERSPORT 900 S I.E. 02 > 02 •

916 ST4 99 > 99 •

916 ST4 00 > 03 •

916 ST4 S 03 > 04 •

916 ST4 S ABS 03 > 04 •

944 SPORT TOURING 2 99 > 00 •

992 ST3 04 > 07 •

992 ST3 ABS, ST3 S ABS 07 > •

992 ST4, ST4 ABS 05 > •

992 SUPERSPORT 1000 06 > •

992 SUPERSPORT 1000 DS 05 > •

992 SUPERSPORT 1000 S 03 > •

LAVERDA

800 TTS 99 > •

MONDIAL

1000 STARFIGHTER 04 > •

MOTO GUZZI

750 BREVA 750 I.E. 03 > 06 •

750 NEVADA 03 > •

750 NEVADA CLASSIC I.E. 06 > 08 •

750 V7 II RACER 15 > 16 •

750 V7 II STORNELLO 16 > 16 •

850 V9 BOBBER 16 > •

850 V9 CUSTOM ROAMER 16 > •

1200 MGS-01 CORSA 05 > •

RIEJU

50 SMX PRO 08 > •

125 MARATHON PRO 09 > •

MARATHON PRO 09 > •

125 SUPERMOTARD 09 > •

125 TANGO 08 > •

125 TANGO PRO 08 > •

250 TANGO 08 > •

VOXAN

1000 CAFE' RACER 01 > •

1000 EVO 04 > •

1000 ROADSTER 01 > •





07BB33.96
GENUINE 34.9 x 40.5 x 7.9

07BB33.SA 34.9 x 40.5 x 8

07BB33.LA “ “ “

07BB33.SC 34.9 x 40.5 x 8.7

07BB33.RC “ “ “

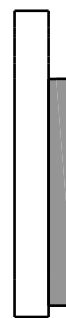
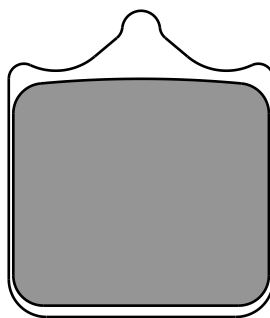
**APRILIA**

1000 RSV	02 > 06	•
1000 RSV FACTORY	03 > 06	•
1000 RSV NERA	04 >	•
1000 RSV R	01 >	•
1000 TUONO R	03 >	•
1000 TUONO RACING	04 >	•

BENELLI

449 BX SUPERMOTARD	08 > 12	•
500 LEONCINO 500	18 >	•
600 BN	14 > 16	•
752 S	18 >	•
899 TNT CENTURY RACER	11 > 11	•
900 TORNADO 3	03 > 08	•
1130 TNT CAFE' RACER	05 > 08	•
1130 TNT CENTURY RACER	11 >	•
1130 TNT OFFICINE	07 >	•
1130 TNT R	17 >	•
1130 TNT R 160	10 > 16	•
1130 TNT SPORT	05 > 06	•
1130 TNT TITANIUM	05 > 08	•
1130 TORNADO TRE	06 > 08	•
1130 TORNADO TRE R	13 >	•
1130 TRE K AMAZONAS	13 > 16	•

BIMOTA

1000 DB5	05 >	•
1000 DB6 R DELIRIO	06 >	•
1000 SB8 K SANTAMONICA	07 >	•
1078 DB10 BIMOTARD	12 >	•
1078 DB5	12 >	•
1098 DB7	08 >	•
1100 DB6 R DELIRIO	08 >	•
1100 TESI 3D	07 >	•
1200 DB12	12 >	•
1200 DB9 BRIVIDO	12 >	•

BMW

450 G 450 SMR	09 > 12	•
1000 S 1000 R	13 >	•



1000 S 1000 R ABS	14 >	•
1000 S 1000 RR	09 >	•

CAGIVA

1000 X-RAPTOR	03 > 06	•
---------------	---------	---

DERBI

659 MULHACÉN	06 >	•
659 MULHACÉN CAFE'	08 >	•

DUCATI

748 748 R	01 > 02	•
748 749	03 > 07	•
748 749 DARK	05 > 06	•
748 749 R	03 > 07	•
748 749 S	03 > 07	•
996 996 R	01 >	•
998 998 F.E.	04 >	•
998 998 R	02 >	•
998 998 S	02 >	•
998 999	03 > 07	•
998 999 R	03 > 07	•
998 999 S	03 > 07	•
998 MONSTER S4 R	07 >	•
998 TESTASTRETTA	06 >	•
998 MONSTER S4 RS	06 >	•
998 TESTASTRETTA	06 >	•
999 999 XEROX	06 >	•

HUSQVARNA

250 SMR	06 >	•
449 SMR	11 > 13	•
450 SMR	05 > 05	•
450 SMR	06 > 13	•
450 SMR R	06 > 13	•
510 SM CENTENNIAL	06 >	•
510 SMR	05 > 05	•
510 SMR	06 >	•
511 SMR	11 >	•
610 SM	05 > 09	•
610 SMS	06 > 09	•



630 SMS	10 >	•
701 SUPERMOTO	15 >	•

HYOSUNG

450 RX SM	08 >	•
-----------	------	---

KTM

690 DUKE	08 > 11	•
690 DUKE R	10 > 11	•
690 SM PRESTIGE	07 >	•
690 SMC	08 >	•
690 SMC R	14 >	•
950 DUKE	03 >	•
950 SUPERMOTO	05 >	•
950 SUPERMOTO R	07 > 08	•
990 SUPER DUKE	05 >	•
990 SUPERDUKE R	07 >	•
990 SUPERMOTO	06 >	•
990 SUPERMOTO T	09 >	•

LAVERDA

1000 SFC (LIMITED EDITION)	03 >	•
----------------------------	------	---

MONDIAL

1000 PIEGA	02 >	•
1000 PIEGA EVO	04 >	•
1000 PIEGA RZ NUDA	04 >	•
1000 STARFIGHTER	04 >	•

MOTO GUZZI

750 GRISO	04 >	•
1200 MGS-01 CORSA	05 >	•

MOTO MORINI

1200 GRANFERRO	10 >	•
----------------	------	---

MV AGUSTA

910 BRUTALE R	06 > 08	•
1000 F4 312 R	07 >	•
1000 F4 R	06 >	•



1000 F4 R 1+1
1000 F4 SENNA



06 > •
06 > •



SHERCO

450 4.5 I SUPERMOTARD 06 > •



TRIUMPH

1050 SPEED 94 15 > 16 •

1050 SPEED TRIPLE 08 > 13 •

1050 SPEED TRIPLE (SPECIAL EDITION) 09 > •

1050 SPEED TRIPLE ABS 11 > 12 •

1050 SPEED TRIPLE S ABS 08 > 08 •

1050 SPEED TRIPLE S ABS 09 > 10 •

NORTON

961 COMMANDO CAFE' RACER 11 > 17 •

961 COMMANDO CAFE' RACER 18 > •

961 COMMANDO SE 12 > •

961 COMMANDO SF 13 > •

SWM

440 GRAN MILANO 18 > •

450 SIX DAYS 18 > •

450 SM R 15 > •

600 SUPERDUAL 15 > •

TM

660 SMX F 05 > •



07BB34.29
GENUINE

67.8 x 56.5 x 12

2

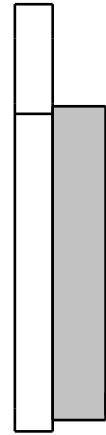
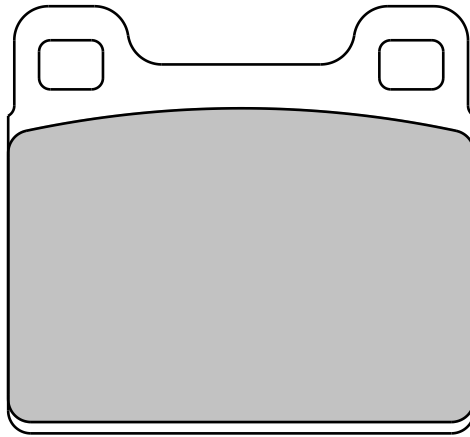

BOMBARDIER-CAN AM

400	LYNX ENDURO RC	05 >	•
400	SKI-DOO MX Z X LC	98 > 99	•
440	LYNX RAVE	05 >	•
440	LYNX RAVE RC	07 >	•
440	SKI-DOO MX Z RACING	06 >	•
440	SKI-DOO MX Z X	02 > 03	•
440	SKI-DOO MX Z X LC	97 > 01	•
440	SKI-DOO MX Z X RACING	04 >	•
453	LYNX RAVE RC	06 >	•
500	LYNX ENDURO RC	04 >	•
500	LYNX ENDURO SPECIAL/RER	02 >	•
500	LYNX SUPER TOURING	02 >	•
500	SKI-DOO GRAND TOURING	02 >	•
500	SKI-DOO GSX SS	04 >	•
500	SKI-DOO LEGEND SS	04 >	•
500	SKI-DOO MX Z	01 >	•
500	SKI-DOO MX Z SS TRAIL & ADRENALINE	04 >	•
500	SKI-DOO SKANDIC	02 >	•
500	SKI-DOO SKANDIC SUPER WIDE TRACK F	03 >	•
500	SKI-DOO SKANDIC WIDE TRACK F	03 >	•
550	LYNX ENDURO	05 >	•
550	LYNX ENDURO RC	05 >	•
550	LYNX RANGER	05 >	•
550	LYNX RAVE N-DURO F	06 >	•
550	LYNX ST	05 >	•
550	LYNX ST F	04 >	•
550	LYNX YETI	08 >	•
550	LYNX YETI PRO	08 >	•
550	LYNX YETI SUV	09 >	•
550	SKI-DOO SKANDIC SUV F	04 >	•

550	SKI-DOO SKANDIC SWT	04 >	•
550	SKI-DOO SKANDIC WT F	04 >	•
600	LYNX YETI	08 >	•
600	LYNX ENDURO HO	04 >	•
600	LYNX ENDURO HO SDI	05 >	•
600	LYNX ENDURO RC	04 >	•
600	LYNX ENDURO RER	02 >	•
600	LYNX ENDURO SPECIAL	02 >	•
600	LYNX RANGER	04 >	•
600	LYNX RANGER LCE	03 >	•
600	LYNX RAVE HO SDI	08 >	•
600	LYNX RAVE N-DURO	06 >	•
600	LYNX RAVE RC HO SDI	06 >	•
600	LYNX RAVE RE	08 >	•
600	LYNX RAVE RE HO	07 >	•
600	LYNX RAVE XT N-DURO HO SDI	07 >	•
600	LYNX SPORT TOURING	03 >	•
600	LYNX SPORT TOURING HO SDI	05 >	•
600	LYNX ST	04 >	•
600	LYNX SUPER TOURING	02 >	•
600	LYNX XTRIM N-DURO HO SDI	06 >	•
600	LYNX XTRIM SDI	08 >	•
600	LYNX YETI SDI	06 >	•
600	LYNX YETI TUV HO SDI	07 >	•
600	SKI-DOO EXPEDITION HO SDI	05 >	•
600	SKI-DOO EXPEDITION TUV HO SDI	07 >	•
600	SKI-DOO GRAND TOURING	02 >	•
600	SKI-DOO GSX HO	04 >	•
600	SKI-DOO LEGEND HO SDI	04 >	•
600	SKI-DOO MX Z	99 >	•

600	SKI-DOO MX Z BLIZZARD HO SDI	07 >	•
600	SKI-DOO MX Z HO	03 >	•
600	SKI-DOO MX Z HO ADRENALINE	06 >	•
600	SKI-DOO MX Z HO RENEGADE	04 >	•
600	SKI-DOO MX Z HO RENEGADE X	04 >	•
600	SKI-DOO MX Z HO SDI	04 >	•
600	SKI-DOO MX Z HO SDI ADRENALINE & X	05 >	•
600	SKI-DOO MX Z HO SDI RENEGADE	05 >	•
600	SKI-DOO MX Z HO SDI RENEGADE X	05 >	•
600	SKI-DOO MX Z HO SDI RENEGADE, EARLY INTRO	05 >	•
600	SKI-DOO MX Z HO TRAIL & ADRENALINE & X	04 >	•
600	SKI-DOO MX Z RENEGADE X HO SDI	07 >	•
600	SKI-DOO MX Z REV HO 007 SPECIAL EDITION	03 >	•
600	SKI-DOO MX Z X HO SDI	07 >	•
600	SKI-DOO MX Z XRS HO SDI	07 >	•
600	SKI-DOO SKANDIC	02 >	•
600	SKI-DOO SKANDIC SUV	03 >	•
600	SKI-DOO SKANDIC SUV HO SDI	08 >	•
600	SKI-DOO SKANDIC WT	05 >	•
600	SKI-DOO SKANDIC WTLC	04 >	•
600	SKI-DOO SUMMIT	02 >	•



600	SKI-DOO SUMMIT HO	03 >	•
600	SKI-DOO SUMMIT HO SDI ADRENALINE	06 >	•
700	LYNX ENDURO RER	02 >	•
700	LYNX ENDURO SPECIAL	02 >	•
700	LYNX SUPER TOURING	02 >	•
700	SKI-DOO GRAND TOURING	02 >	•
700	SKI-DOO LEGEND	04 >	•
700	SKI-DOO MX Z	01 >	•
700	SKI-DOO SUMMIT	02 >	•
700	SKI-DOO SUMMIT HO	03 >	•
800	LYNX ADVENTURE HO	05 >	•
800	LYNX MOUNTAIN HO	04 >	•
800	LYNX RAVE	05 >	•
800	LYNX RAVE CROSS HO	04 >	•
800	LYNX RAVE RC	04 >	•
800	LYNX RAVE RC HO POWER TEK	07 >	•
800	LYNX RAVE RC PT	06 >	•
800	LYNX RAVE SPECIAL	02 >	•
800	LYNX RAVE XT N-DURO HO POWER T	07 >	•
800	LYNX RAVE XTRIM N-DURO POWER TEK	06 >	•
800	LYNX SPORT TOURING	03 >	•
800	LYNX SUPER TOURING	02 >	•
800	LYNX YETI PRO ARMY V	09 >	•
800	LYNX YETI PRO V	07 >	•
800	LYNX YETI SUV V	07 >	•

800	LYNX YETI V	08 >	•
800	SKI-DOO EXPEDITION TUV V	07 > 08	•
800	SKI-DOO EXPEDITION TUV V 4-TEC	09 >	•
800	SKI-DOO GRAND TOURING	02 >	•
800	SKI-DOO GRAND TOURING SE SDI	03 >	•
800	SKI-DOO GSX HO	04 >	•
800	SKI-DOO GTX	05 >	•
800	SKI-DOO LEGEND SDI	04 >	•
800	SKI-DOO LEGEND SE SDI	03 >	•
800	SKI-DOO MX Z	01 >	•
800	SKI-DOO MX Z BLIZZARD HO PTEK	07 >	•
800	SKI-DOO MX Z HO ADRENALINE & X	04 >	•
800	SKI-DOO MX Z HO RENEGADE	05 >	•
800	SKI-DOO MX Z HO RENEGADE X	04 >	•
800	SKI-DOO MX Z RENEGADE X HO PTEK	07 >	•
800	SKI-DOO MX Z REV	02 >	•
800	SKI-DOO MX Z REV HO 007 SPECIAL EDITION	03 >	•
800	SKI-DOO MX Z X HO PTEK	07 >	•

800	SKI-DOO MX Z XRS HO PTEK	07 >	•
800	SKI-DOO SKANDIC SWT V	07 >	•
800	SKI-DOO SUMMIT	02 >	•
800	SKI-DOO SUMMIT HO	03 >	•
800	SKI-DOO SUMMIT HO ADRENALINE & X	06 >	•
800	SLI-DOO SUMMIT X HO	03 >	•
1000	LYMX RANGER V	03 >	•
1000	LYNX TOURING V	05 >	•
1000	SKI-DOO EXPEDITION V	05 >	•
1000	SKI-DOO MACH Z SDI	05 >	•
1000	SKI-DOO MACH Z SDI ADRENALINE & X	06 >	•
1000	SKI-DOO MX Z SDI RENEGADE RT	07 >	•
1000	SKI-DOO MX Z SDI RENEGADE X	06 >	•
1000	SKI-DOO SUMMIT SDI HIGHMARK	05 >	•
1000	SKI-DOO SUMMIT SDI HIGHMARK X	05 >	•
1300	LYNX EXPEDITION TUV V	06 >	•
1300	LYNX YETI TUV V	06 >	•
1300	LYNX YETI V	08 >	•
1300	SKI-DOO EXPEDITION TUV (EUROPE)	07 >	•
1300	SKI-DOO EXPEDITION V	08 >	•





07BB35.90
GENUINE

86 x 43.5 x 10

2

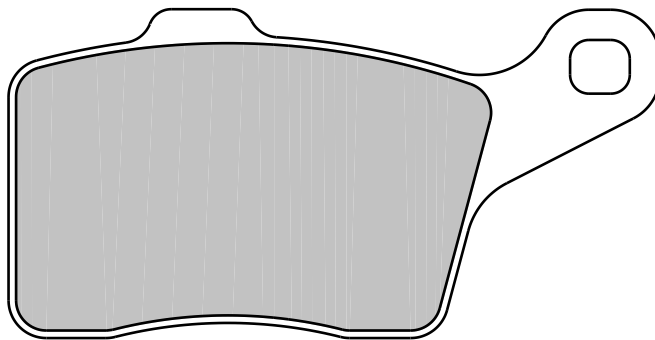
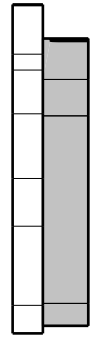
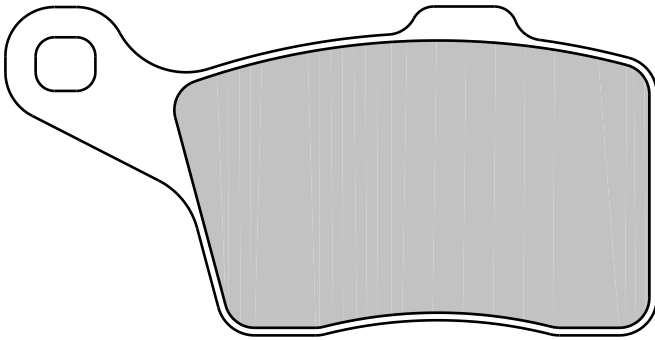

BOMBARDIER-CAN AM

600	LYNX ADVENTURE GRAND TOURER SDI	09 >	•
600	LYNX ADVENTURE GT GT SDI	10 >	•
600	LYNX RAVE	09 >	•
600	LYNX RAVE RE E-TEC	09 >	•
600	LYNX RAVE RS LYNX XTRIM	08 >	•
600	COMMANDER LIMITED SDI	70 >	•
600	LYNX XTRIM COMMANDER SDI	70 >	•

600	LYNX XTRIM SC E-TEC	70 >	•
600	SKI-DOO EXPEDITION SE HOETEC XU	11 >	•
600	SKI-DOO EXPEDITION TUV H.O. SDI REV-XU	09 >	•
600	SKI-DOO EXPEDITION TUV H.O. SDI XU	10 >	•
600	SKI-DOO EXPEDITION TUV SE HO SDI XU	10 >	•
600	SKI-DOO MX Z RS	08 >	•
600	SKI-DOO SKANDIC WT ACE XU	11 >	•

600	SKI-DOO SKANDIC WT HO ETEC	11 >	•
800	LYNX RAVE POWER TEK	09 >	•
800	LYNX XTRIM SC POWER TEK	70 >	•
1200	LYNX ADVENTURE GT	10 >	•
1200	SKI-DOO EXPEDITION SE XU	11 >	•
1200	SKI-DOO EXPEDITION TUV REV-XU	10 >	•
1200	SKI-DOO EXPEDITION TUV SE REV-XU	10 >	•



07BB36.35
GENUINE

75.1 x 55.5 x 7

2

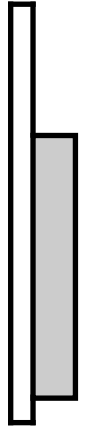
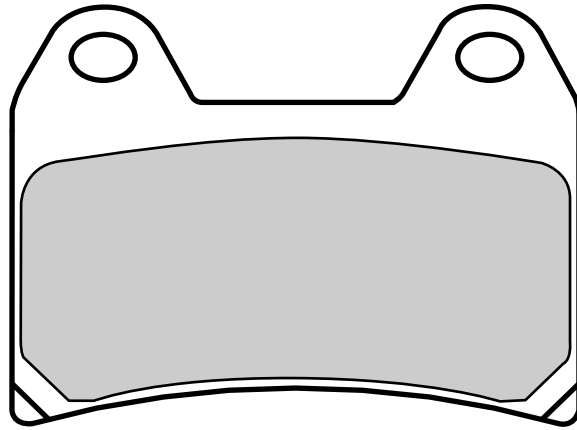

DUCATI

620	MONSTER 620 DARK (MONODISCO)	05 >	•	696	MONSTER 696 / MONSTER 696 +	09 > 10	•	796	MONSTER	11 >	•
620	MULTISTRADA 620 DARK (MONODISCO)	05 >	•	696	MONSTER 696 ABS	10 > 14	•	796	MONSTER 796	11 >	•
620	SUPERSPORT 620 S	03 >	•	696	MONSTER 696 ANNIVERSARY / ABS	13 > 13	•	796	MONSTER 796 ABS	11 >	•
659	monster 659	12 > 13	•	795	MONSTER 795	12 > 15	•	796	MONSTER 796 ABS ANNIVERSARY	13 >	•
659	MONSTER 659 ABS	12 > 14	•	795	MONSTER 795 ABS	13 > 15	•	796	MONSTER 796 ANNIVERSARY	13 >	•
696	MONSTER 696	08 > 08	•	795	MONSTER 795 ABS CORSE STRIPE	14 > 14	•	803	SUPERSPORT 800	06 >	•
				796	HYPERMOTARD	10 >	•	803	SUPERSPORT 800 S	03 > 06	•
								803	SUPERSPORT 800 SS	03 >	•





07BB37.93
GENUINE 102.2 x 42 x 7.7

07BB37.SA “ “ “

07BB37.LA “ “ “

07BB37.SC “ “ “

07BB37.RC “ “ “

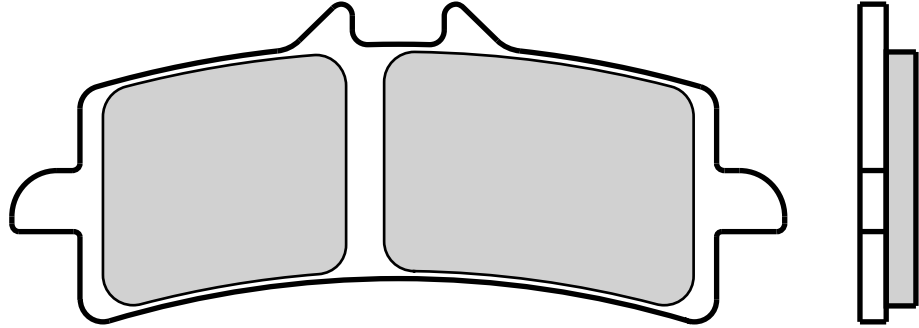

APRILIA

1000 RSV 4RF	15 >	•
1000 RSV 4RR	15 >	•
1000 RSV4 FACTORY	09 > 10	•
1000 RSV4 FACTORY APRC	11 > 12	•
1000 RSV4 FACTORY APRC ABS	13 > 16	•
1000 RSV4 FACTORY APRC ABS	13 >	•
1000 RSV4 R	10 > 16	•
1000 RSV4 R APRC ABS	14 >	•
1000 RSV4 RACING FACTORY ABS	18 >	•
1000 RSV4 RF	15 > 16	•
1000 RSV4 RR	15 > 16	•
1100 TUONO V4 FACTORY	17 >	•
1100 TUONO V4 RF ABS	18 >	•
1100 TUONO V4 RR	17 >	•

BIMOTA

800 TESI 3D RACECAFE'	16 >	•
1000 BB3	13 >	•
1078 TESI 3D NAKED	16 >	•
1098 DB7	09 >	•
1198 DB8	10 >	•
1198 IMPETO	16 >	•
1200 DB11 VLX (RED CALL)	13 >	•

BMW

1000 S 1000 RR HP4	12 > 14	•
1200 HP2 SPORT	08 > 12	•

DUCATI

848 848 EVO	11 > 13	•
990 DESMOSEDICI RR (D16RR)	07 > 08	•
1098 1098 R BAYLISS	09 >	•
1098 STREETFIGHTER	09 >	•
1098 STREETFIGHTER S	09 >	•
1099 1098	07 > 09	•
1099 1098 S	07 > 09	•
1099 1098 TRICOLORE	07 > 09	•
1100 HYPERMOTARD EVO SP	10 > 12	•
1100 HYPERMOTARD S	07 > 09	•
1103 PANIGALE V4	18 >	•
1103 PANIGALE V4 S	18 >	•
1103 PANIGALE V4 SPECIALE	18 >	•
1198 1098 BAYLISS	09 > 09	•
1198 1098 R	08 >	•
1198 1198	09 >	•
1198 1198 S	09 >	•
1198 1198 SP	11 >	•
1199 PANIGALE	12 >	•
1199 PANIGALE R	13 >	•
1199 PANIGALE S	12 >	•
1199 SUPERLEGGERA	14 >	•
1200 DIAVEL	11 >	•
1200 DIAVEL CARBON	14 >	•
1200 DIAVEL DARK	14 >	•
1200 DIAVEL STRADA	13 >	•
1200 DIAVEL TITANIUM	15 >	•
1200 MONSTER R	15 >	•
1200 MONSTER S	14 >	•
1200 MONSTER S STRIPE	15 >	•
1200 MULTISTRADA S	15 >	•

1200 MULTISTRADA S D-AIR	15 >	•
1200 MULTISTRADA S PIKES PEAK	15 >	•
1200 MULTISTRADA S TOURING ABS	15 > 16	•
1260 MULTISTRADA S	18 >	•
1260 MULTISTRADA S D-AIR	18 >	•
1260 MULTISTRADA S PIKES PEAK	18 >	•
1262 XDIAVEL S	16 >	•
1299 PANIGALE	15 >	•
1299 PANIGALE R	15 >	•
1299 PANIGALE R FINAL EDITION	18 >	•
1299 PANIGALE S	15 >	•
1299 PANIGALE S ANNIVERSARIO	17 >	•
1299 PANIGALE SUPERLEGGERA	17 >	•

ENERGICA

11.7 EGO	15 >	•
11.7 EVA	15 >	•
11.7 EVA ESSEESSE 9	18 >	•

HONDA

1000 CBR RR SP	17 > 18	•
1000 CBR RR SP2	17 > 18	•
1000 RC213V-S	16 > 18	•
1000 RCV213V	15 >	•
1000 RCV213V	16 > 18	•



HOREX

1200 CAFE RACER	17 >	•
1200 CLASSIC	17 >	•

HUSQVARNA

450 FS	15 >	•
900 NUDA R	12 > 14	•

KAWASAKI

998 NINJA H2 SX	18 >	•
1000 H2	15 >	•
1000 H2 R	15 >	•
1000 Z R	17 >	•
1000 ZX 10 R	16 >	•
1000 ZX 10 R SE	18 >	•
1000 ZX 10 R WINTER EDITION	16 >	•
1000 ZX 10 RR	17 >	•
1000 ZX H2 CARBON NINJA	17 > 18	•
1000 ZX H2 NINJA	15 > 18	•
1000 ZX H2R NINJA	17 > 18	•
1400 ZZR ABS	16 >	•
1400 ZZR PERFORMANCE SPORT	17 >	•

KTM

450 SMR	13 > 16	•
690 DUKE R	14 >	•
990 990 SUPERMOTO R	09 >	•
1190 RC8	08 > 16	•

1190 RC8 R	09 > 16	•
1190 RC8 R TRACK	11 > 16	•
1290 SUPER DUKE GT	16 >	•
1290 SUPER DUKE R	14 >	•

MOTO GUZZI

850 V85	18 >	•
---------	------	---

MOTO MORINI

1187 MILANO	18 >	•
1200 CORSARO 1200ZZ	18 >	•
1200 MILANO	18 >	•
1200 SCRAMBLER	18 >	•

MV AGUSTA

675 F3	15 >	•
675 F3 RC	16 >	•
675 F3 RC	18 >	•
800 F3	13 >	•
800 F3 AMG GT	16 >	•
800 F3 RC	16 >	•
1000 F4 R CORSA CORTA	12 >	•
1000 F4 RC	17 >	•
1000 F4 RC	18 >	•
1000 F4 RR	11 >	•
1000 F4 RR CORSA CORTA	12 >	•
1078 BRUTALE RR	08 >	•
1078 F4 312 RR	08 >	•
1078 F4 CC	08 >	•
1090 BRUTALE	13 >	•

1090 BRUTALE CORSA	14 >	•
1090 BRUTALE RR	10 >	•

NORTON

1200 K5X	18 >	•
1200 V4 RR	17 >	•

SUZUKI

600 GSX-R	11 > 16	•
750 GSX-R	11 >	•
1000 GSX R	12 > 16	•
1000 GSX R	17 >	•
1000 GSX R ABS	15 >	•
1000 GSX RR	17 >	•
1000 GSX S 1000 F ABS	15 >	•
1000 GSX S ABS	15 >	•
1000 GSX S F	15 >	•
1300 GSX R HAYABUSA (RED CALL)	13 >	•

TRIUMPH

675 DAYTONA R	13 > 16	•
675 DAYTONA R TRIPLE	11 > 12	•
675 DAYTONA R TRIPLE	13 > 16	•
765 STREET TRIPLE RS	17 >	•
1050 SPEED 94R	15 > 16	•
1050 SPEED TRIPLE R	12 > 15	•
1050 SPEED TRIPLE R ABS	12 >	•
1050 SPEED TRIPLE S	16 >	•
1200 THRUXTON R	16 >	•





07BB38.59 GENUINE	85 x 50.8 x 8
07BB38.84 GENUINE	“ “ “
07BB38.SA	“ “ “
07BB38.LA	“ “ “
07BB38.SC	“ “ “
07BB38.RC	“ “ “

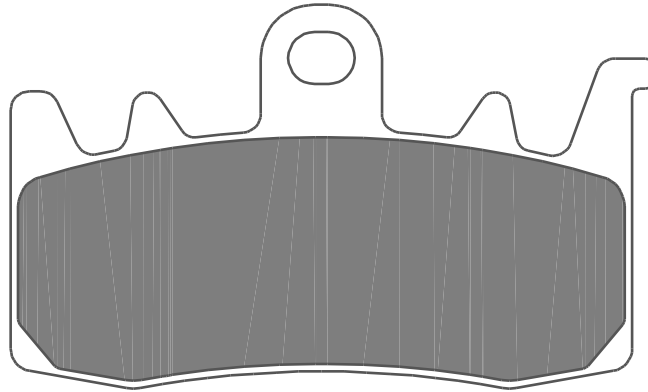

APRILIA

1000 TUONO	13 >	•
1000 TUONO V4R APRC ABS	14 >	•
1100 TUONO V4 FACTORY RR	15 >	•
1200 CAPONORD	13 > 16	•
1200 CAPONORD ABS	14 > 16	•
1200 CAPONORD RALLY	15 >	•
1200 CAPONORD TP	14 >	•
1200 CAPONORD TRAVEL PACK	14 > 16	•

BENELLI

300 BN 302 TORNADO	16 >	•
600 BN GT	14 > 16	•
600 BN R	15 > 16	•

BMW

313 G 310 R	16 >	•
800 F 800 R	15 >	•
1000 S 1000 XR	15 >	•
1200 R 1200 GS	13 >	•
1200 R 1200 GS ADVENTURE	14 >	•
1200 R 1200 R	15 >	•
1200 R 1200 RS	15 >	•
1200 R 1200 RT	14 >	•
1200 R NINE T	14 >	•

BOMBARDIER-CAN AM

1330 SPYDER F3	15 > 18	•
1330 SPYDER F3 LIMITED	16 > 18	•

1330 SPYDER F3 S	15 > 18	•
1330 SPYDER F3 T	16 > 18	•
1330 SPYDER RS	14 > 16	•
1330 SPYDER RS RSS	13 >	•
1330 SPYDER RSS	14 > 15	•
1330 SPYDER RSS SPECIAL SERIES	15 >	•
1330 SPYDER RT	14 > 18	•
1330 SPYDER RT LIMITED	13 > 18	•
1330 SPYDER RT RTS	13 >	•
1330 SPYDER RTS	14 > 15	•
1330 SPYDER RTS SPECIAL SERIES	15 >	•
1330 SPYDER ST	14 > 16	•
1330 SPYDER ST LIMITED	13 > 15	•
1330 SPYDER ST STS	13 >	•
1330 SPYDER STS	14 > 15	•
1330 SPYDER STS SPECIAL SERIES	15 >	•

DUCATI

797 MONSTER	17 >	•
797 MONSTER 797+	17 >	•
803 HYPERMOTARD	13 >	•
803 HYPERMOTARD SP	13 >	•
803 HYPERSTRADA	13 >	•
803 SCRAMBLER CAFE' RACER	17 >	•
803 SCRAMBLER CLASSIC	15 >	•

803 SCRAMBLER DESERT SLED	17 >	•
803 SCRAMBLER FLAT TRACK	16 >	•
803 SCRAMBLER FULL THROTTLE	15 >	•
803 SCRAMBLER ICON	15 >	•
803 SCRAMBLER ITALIAN INDEPENDENT	16 >	•
803 SCRAMBLER MATCH 2.0	18 >	•
803 SCRAMBLER URBAN ENDURO	15 >	•
821 HYPERMOTARD SP	13 > 15	•
821 MONSTER 821	15 >	•
821 MONSTER 821 DARK	15 > 16	•
821 MONSTER 821 STRIPE	15 >	•
899 PANIGALE	14 > 15	•
939 HYPERMOTARD	16 >	•
939 HYPERMOTARD SP	16 >	•
939 HYPERSTRADA	16 >	•
939 SUPERSPORT	17 >	•
939 SUPERSPORT S	17 >	•
950 MULTISTRADA	17 >	•
959 PANIGALE	16 >	•
959 PANIGALE CORSE	18 >	•
1100 SCRAMBLER	18 >	•
1100 SCRAMBLER SPECIAL	18 >	•
1100 SCRAMBLER SPORT	18 >	•
1200 MONSTER	14 >	•
1200 MULTISTRADA	15 >	•



1200 MULTISTRADA ENDURO	16 >	•
1200 MULTISTRADA TOURING ABS	15 > 16	•
1260 MULTISTRADA	18 >	•
1262 XDIAVEL	16 >	•

FANTIC MOTOR

500 CABALLERO	17 >	•
---------------	------	---

KYMCO

550 AK 550	17 >	•
------------	------	---

MV AGUSTA

800 RIVALE	13 >	•
800 STRADALE	15 >	•
800 TURISMO VELOCE	14 >	•
800 TURISMO VELOCE LUSSO	14 >	•

800 TURISMO VELOCE RC	17 >	•
-----------------------	------	---

NORTON

961 DOMINATOR NAKED	15 >	•
---------------------	------	---

PIAGGIO

125 LIBERTY	18 >	•
-------------	------	---

TRIUMPH

765 STREET TRIPLE R	17 >	•
765 STREET TRIPLE R LOW	17 > 18	•
1200 TIGER EXPLORER	16 > 17	•
1200 TIGER XC	18 >	•
1200 TIGER XCA	18 >	•
1200 TIGER XCX	18 >	•
1200 TIGER XR	18 >	•
1200 TIGER XRT	18 >	•
1200 TIGER XRX	18 >	•

1200 TIGER XRX LOW	18 >	•
1215 TIGER EXPLORER XC ABS	17 >	•
1215 TIGER EXPLORER XC ABS (> VIN 740277)	16 > 16	•
1215 TIGER EXPLORER XCA ABS	16 >	•
1215 TIGER EXPLORER XCX ABS	18 >	•
1215 TIGER EXPLORER XCX Low ABS	16 >	•
1215 TIGER EXPLORER XR ABS	16 >	•
1215 TIGER EXPLORER XRT ABS	16 >	•
1215 TIGER EXPLORER XRX Low ABS	17 >	•





07BB39.9A
GENUINE

96.3 x 43.4 x 8.7

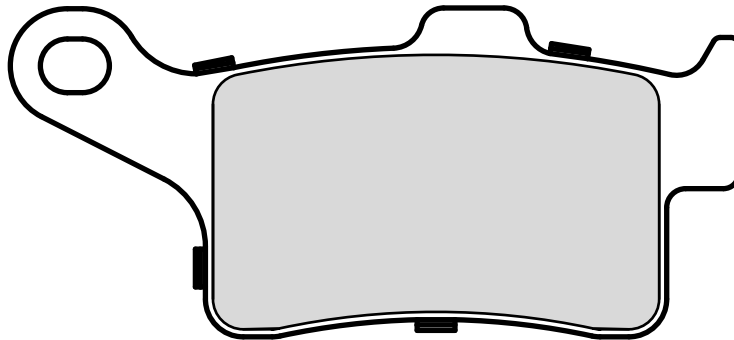
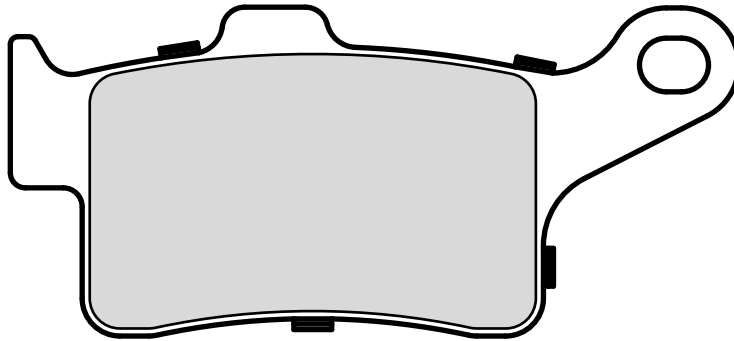

BOMBARDIER-CAN AM

998	SPYDER SPORT	16 >	•
998	SPYDER SPORT TOURING	16 >	• •
1330	SPYDER SPORT CRUISING	16 >	• •
1330	SPYDER TOURING	16 >	• •



07GR01.01

31.2 x 49 x 5.6

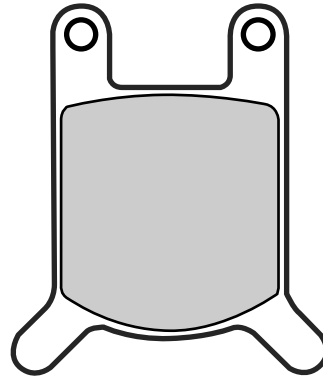

2



BENELLI

250 254 83 > 84 •

80 RX 9 AIR COOLED 82 > 83 •
80 ULTRA 81 > •
80 ULTRA CHOPPER AC 81 > 83 •

PUCH

50 COBRA 6 GT, GTL 80 > •
50 MONZA 4 SL, GSL 80 > •

BETA

50 MG 83 > •
50 SQUIRREL 83 > •

HOREX

80 REBELL N 70 > •
80 REBELL T 86 > •
80 SPORT L 86 > •

RIEJU

80 NEVADA SPORT 70 > •

CASAL

50 RZ 70 > •

MALAGUTI

25 CHOPPER 86 > •
40 CHOPPER 83 > •
50 FIFTY HF WC 83 > •
50 RONCO 83 > •
50 SPORT XL 83 > •
50 V4 OLIPIQUE 83 > •
80 CHOPPER 83 > •
125 RUNNER 86 > 86 •

SACHS

80 LOTUS SA 70 > •

FANTIC MOTOR

50 SUPER SIX 83 > •

ZÜNDAPP

50 KS SUPER SPORT 79 > •
50 KS TT 80 > 81 •
80 KS SUPER 83 > •
80 KS TOURING 80 > •
175 KS 78 > 80 •

GARELLI

40 S SPORT 70 > •
80 SPORT 83 > •

ZWEIRAD RÖTH

50 REBEL SPORT 70 > •
80 REBEL SPORT 70 > •

HERCULES

50 RS 79 > 83 •
50 ULTRA 79 > 83 •
80 AC CHOP 81 > 83 •
80 CHOPPER 81 > •
80 RX 9 82 > 83 •

MOTO GUZZI

125 T 81 > •

OSSA

350 TU-YO 70 > •





07GR02.04

49 x 58 x 7.1

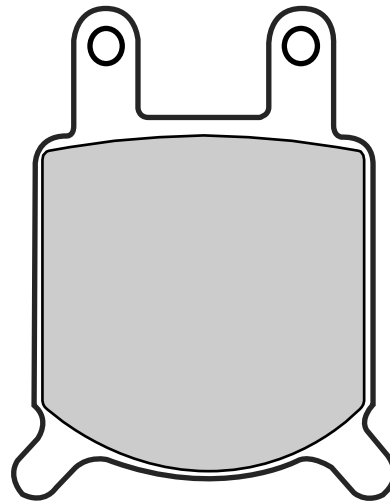

2



ASPES

125 JUMA	76 > 82	•
----------	---------	---

BETA

125 CUSTOM	83 >	•
125 TS	83 >	•
250 CUSTOM	82 >	•

FANTIC MOTOR

125 SPORT HP1	86 >	•
---------------	------	---

GARELLI

125 GTA	86 >	•
125 TSR	83 >	•

GILERA

80 TG1	83 >	•
125 GR1	85 >	•
125 RV	86 >	•
125 TG1	85 >	•
200 RV	86 >	•
200 T4	85 >	•
200 T4C	85 >	•
200 T4S	85 >	•

KREIDLER

125 MUSTANG	83 >	•
-------------	------	---

LAVERDA

125 125	80 > 83	•
---------	---------	---

MOTO MORINI

125 STRADA	70 >	•
250 STRADA	70 >	•
250 TT	86 >	•
350 K2	84 >	•
350 SPORT	80 >	• •
350 STRADA	70 >	•
350 TT	80 >	•
500 STRADA	70 >	•
500 TT	80 >	•

ZÜNDAPP

80 KS	80 >	•
125 KS	79 > 81	•



07GR03.CC

98.1 x 32.6 x 7.6

110.8 x 35.7 x 7.6

2

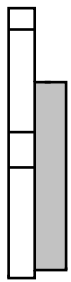
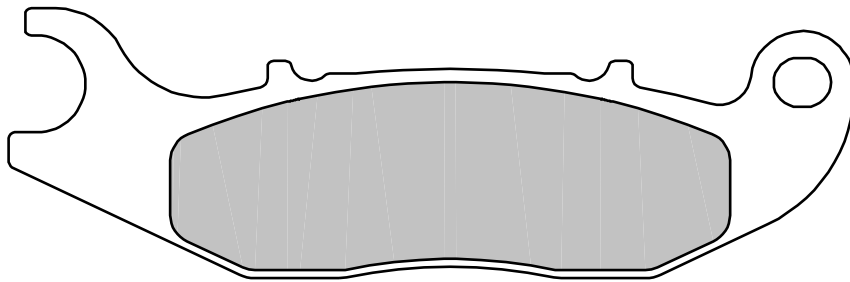
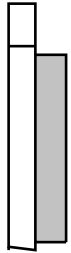
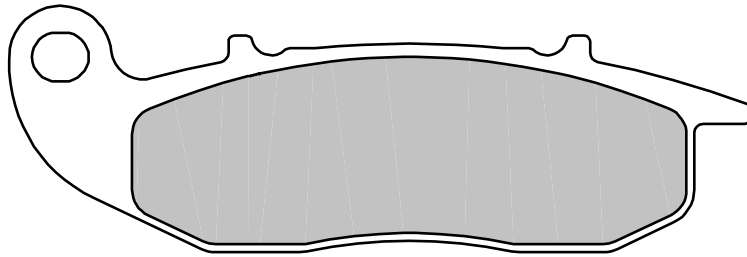

AJP

240	MX	13 >	•
650	ADVENTURE	17 >	•

DERBI

50	SENDA DRD EVO SM	09 >	•
50	SENDA DRD PRO R/SM	09 >	•
50	SENDA DRD RACING R/SM	09 >	•
125	CROSS CITY	09 >	•
125	MULHACEN	08 >	•
125	SENDA BAJA R/SM	09 >	•
125	SENDA DRD R/SM	09 >	•

125	TERRA	08 >	•
125	TERRA ADVENTURE	08 >	•

HM

125	CRE BAJA	11 >	•
-----	----------	------	---

HONDA

250	CRF L	14 >	•
250	CRF L ABS	17 > 18	•
250	CRF RALLY	17 > 18	•

PIAGGIO

125	LIBERTY iGET 4T 3V	17 >	•
-----	--------------------	------	---

125	MEDLEY	16 >	•
125	MEDLEY S	17 >	•
125	NEW LIBERTY	16 >	•
150	MEDLEY	16 >	•
150	MEDLEY S	18 >	•

RIEJU

50	MRT	11 >	•
----	-----	------	---

SCORPA

250	T-RIDE	08 >	•
-----	--------	------	---





07GR05.CC

65.7 x 36.7 x 7.4

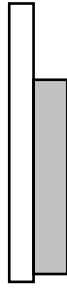
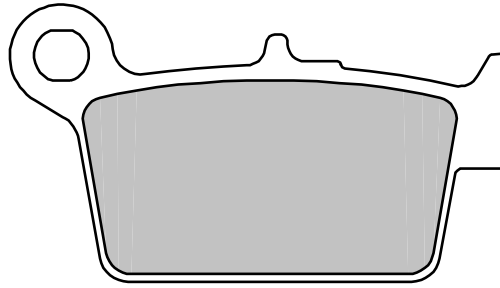
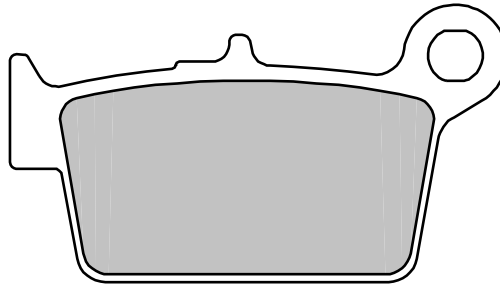

BETA

50	RR ENDURO	10 >	•
50	RR SUPERMOTARD	08 >	•
125	ALP 4-STROKE (EBE)	06 >	•

125	ENDURO	10 >	•
125	M4 (EBE)	06 >	•
125	RR ENDURO	10 >	•
125	RR SUPERMOTARD	08 >	•
125	URBAN	10 >	•

200	ALP 4-STROKE (EBE)	06 >	•
200	URBAN	10 >	•
350	ALP 4.0 (EBE)	06 >	•
350	M4	06 >	•
350	M4 (EBE)	06 >	•



07GR06.SA

78.1 x 46.2 x 7.8

07GR06.SC

“ “ “

07GR06.RC

“ “ “

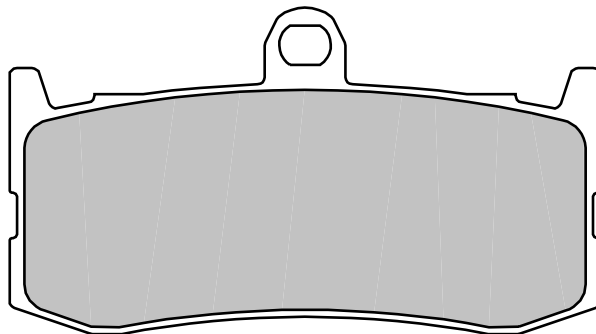

TRIUMPH

675	DAYTONA TRIPLE	09 > 12	•
-----	----------------	---------	---



07GR07.SD 76.4 x 38 x 6.9

07GR07.SX “ “ “

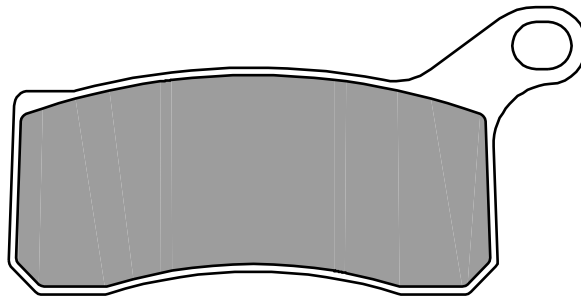
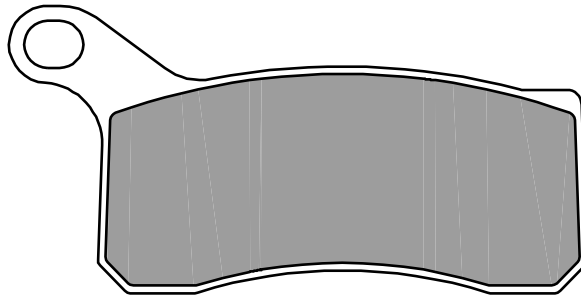

HM

50	CRE SIX COMPETITION	09 >	•
50	CRM DERAPAGE	09 >	•
125	CRM DERAPAGE	11 >	•

KTM

450	SX ATV	08 >	•
450	XC ATV	08 >	•
505	SX ATV	08 >	•
505	XC ATV	08 >	•



07GR08.SD 58.7 x 35.3 x 8.2

07GR08.SX “ “ “

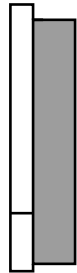
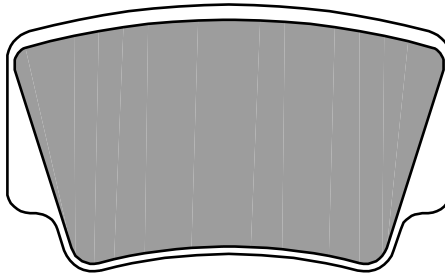

KTM

450	SX ATV	08 >	•
450	XC ATV	08 >	•
505	SX ATV	08 >	•
505	XC ATV	08 >	•





07GR09.CC

88.2 x 48.9 x 7.8

55.6 x 35.9 x 10.3

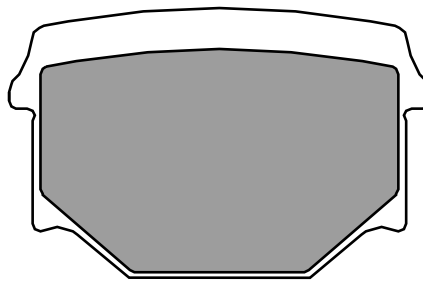
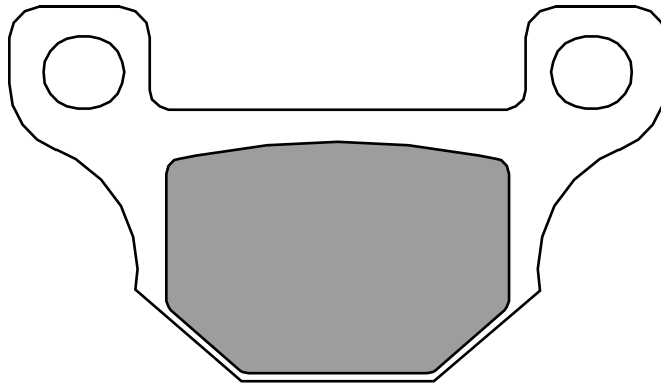

DERBI

125	MULHACEN	08 >	•
125	SENDA DRD R/SM	09 >	•
125	TERRA	08 >	•
125	TERRA ADVENTURE	08 >	•

RIEJU

50	MRT	09 > 10	• •
50	MRT SUPERMOTARD	09 >	• •
50	RRX	08 >	• •

SUZUKI

50	SPIKE X	08 >	• •
125	MARATHON PRO	09 >	•
125	MARATHON PRO SUPERMOTARD	09 >	•
125	GN	05 >	•
125	GN Z, E	82 > 90	•
125	GS E, KATANA	90 > 94	•
125	GS ESD	83 > 94	•

TGB

50	BULLET	09 >	•
50	BULLET	10 >	•
50	BULLET RR	11 >	•
50	BULLET RS	11 >	•
50	CORONA	03 >	•
50	RX	06 >	•
125	BULLET RR	11 >	•
125	BULLET RS	11 >	•



07GR10.01 43.4 x 64.4 x 7

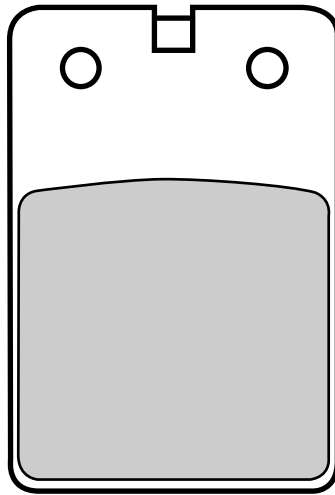

FANTIC MOTOR

125 SPORT 84 > 85 •



GILERA

125 RV 83 > 85 •
200 RV 85 > 85 •



MOTO MORINI

400 S 84 > •
500 6 V CLASSIC 89 > •



07GR11.CC 84.7 x 36.6 x 7.9
47.7 x 31.4 x 12.2

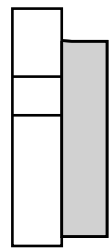
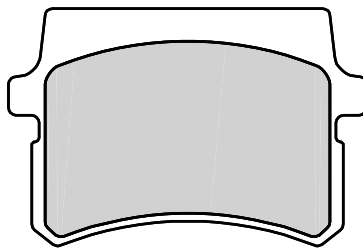
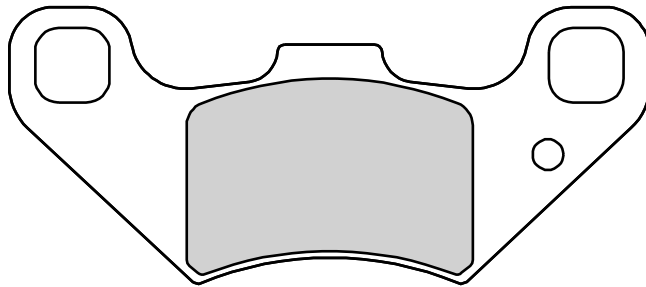

PGO

50 BUGRIDER 06 > •
150 BR BUGXTER 05 > •



200 BR BUGRIDER 07 > •
250 BR BUGRIDER 05 > •

QUADZILLA

250 E 250 06 > •
250 XRV, E 06 > •





07GR12.CC 76.9 x 41.9 x 7.5

07GR12.SA “ “ “

07GR12.SP “ “ “

07GR12.SC “ “ “

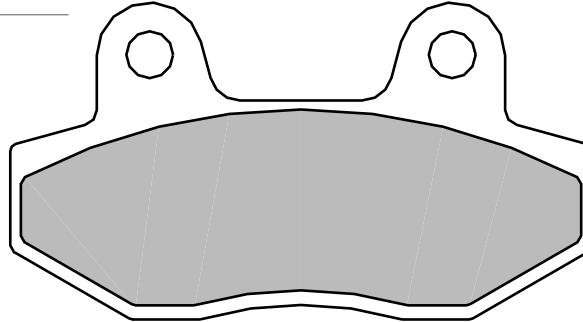

2



BETA

150 R 10 > •

GARELLI

125 XO' I 10 > 11 •
150 XO' I 10 > 11 •
200 XO' I 10 > 11 •

HYOSUNG

125 GT 07 > • •
125 GT COMET 04 > • •
125 GT NAKED 13 > • •
125 GT R SUPERSPORT 07 > • •

125 GV AGUILA 05 > •
125 RT KARION 07 > • •
125 RX SM 07 > • •
125 XR X 07 > • •
250 GT COMET 03 > • •
250 GT IR 13 > 14 • •
250 GT P 13 > • •
250 GT R 07 > • •
650 GT 04 > • •
650 GT CUSTOM
TRENDKILLER 07 > • •
650 GT I 13 > •
650 GT IR 13 > •
650 GT R 05 > • •

650 GT S 05 > • •
650 GT TTC 07 > • •
650 GT X 07 > • •
650 GV AGUILA 06 > • •
650 i NAKED 15 > •
700 I DELUXE 13 > •

ITALJET

50 ROLLERCRAFT 08 > •
125 TORPEDO 08 > •
150 TORPEDO 08 > •
650 BAZOOKA 06 > • •
650 GRIFON 06 > • •



07GR13.CC 78.9 x 46.9 x 7.3

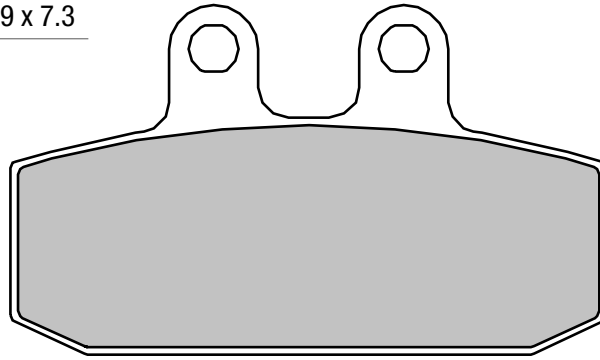

2



APRILIA

125 ETX	86 > 87	•
125 RED ROSE	87 > 89	•
600 ETX	86 >	•
850 MANA	08 > 11	•
850 MANA GT	09 > 16	•

CAGIVA

125 ROADSTER	94 >	•
200 ROADSTER	96 >	•

FANTIC MOTOR

250 RAIDER LC	84 >	•
---------------	------	---

GARELLI

125 TIGER XLE	86 >	•
---------------	------	---

GILERA

125 COUGAR	99 >	•
125 ER	86 >	•
125 FAST BIKE	88 >	•
125 KK	85 >	•
125 KR	85 >	•
125 KZ	85 >	•
125 MXR	90 >	•
125 NEBRASKA	86 >	•
125 R1	88 >	•

125 RTX	85 >	•
125 XR1	88 >	•
125 XR2	88 >	•
200 ARIZONA HAWK	85 >	•
200 ER	87 >	•
250 ARIZONA RALLY	70 >	•
350 DAKOTA	89 >	•
350 XRT	89 >	•
500 DAKOTA	86 >	•
600 XRT	89 >	•

HONDA

125 CA REBEL	97 >	•
125 CITYFLY	99 >	•
125 CRM	90 > 98	•
125 MTX CAMEL	88 >	•
125 MTX R	86 >	•
125 NS	85 > 88	•
125 NSR F	90 > 92	•
125 NSR R, ITALY	89 >	•
125 NX	90 > 98	•
125 RTV NSR	87 >	•
125 XL R, P.D.	85 >	•
200 XL R, P.D.	85 >	•

MALAGUTI

500 SPIDER MAX GT	04 >	•
500 SPIDER MAX RS	09 >	•

MOTO GUZZI

750 V7 II SCRAMBLER	16 >	•
750 V7 II SPECIAL	15 > 16	•
750 V7 II STONE	15 > 16	•
750 V7 II STORNELLO LTD EDITION	17 >	•
750 V7 III ANNIVERSARIO	17 >	•
750 V7 III CARBON	18 >	•
750 V7 III MILANO	18 >	•
750 V7 III RACER	17 >	•
750 V7 III ROUGH	18 >	•
750 V7 III SPECIAL	17 >	•
750 V7 III STONE	17 >	•
850 V85	18 >	•
850 V9 X-TRACK	17 >	•

SACHS

125 ROADSTER	01 >	•
125 ZX	99 >	•
125 ZZ	99 >	•

SIMSON

125 RS	01 >	•
125 SCHIKRA	99 >	•





07GR14.06 76.5 x 41.9 x 7.3

2

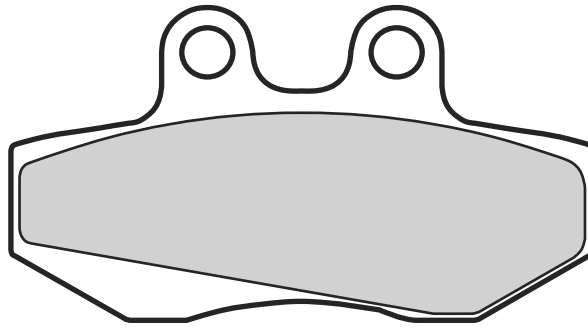

APRILIA

125 CLASSIC	96 >	•
125 PEGASO	89 > 91	•
125 RED ROSE	90 > 94	•
125 TUAREG RALLY	92 >	•
125 TUAREG WIND	89 > 89	•
125 TUAREG WIND	90 >	•
600 PEGASO	90 >	•

BETA

50 PRO RACE	98 >	•
50 RR ENDURO	99 > 03	•
50 RR STANDARD	99 >	•
50 RR SUPERMOTARD	99 > 03	•

BULTACO

50 ASTRO	01 >	•
50 LOBITO	99 >	•

DERBI

50 GPR	98 > 08	•
50 SENDA R	03 > 04	•
125 ATMOSPHERE	99 >	•
180 PREDATOR	99 >	•

GAS GAS

50 EC ROOKIE	01 > 04	•
--------------	---------	---

50 SM ROOKIE

01 > •

GILERA

150 RUNNER FX	97 >	•
200 FX RUNNER	97 > 98	•

HRD

50 GS ENDURO	00 >	•
50 SONIC	00 > 02	•
50 SONIC TRIAL	00 > 02	•
125 SUPERMOTARD	00 >	•
125 TRIAL	00 >	•

HUSQVARNA

50 SM	02 > 09	•
50 WR	02 >	•

ITALJET

50 SM	02 >	•
125 SM	02 >	•

PEUGEOT

50 XR6	02 > 07	•
--------	---------	---

RIEJU

50 MRX PRO	05 >	•
50 RACING	01 >	•

50 RS2 MATRIX

03 > •

50 SMX

02 > •

50 SPIKE

02 > •

50 SPIKE (AJP CALIPER)

02 > •

125 MRX

03 > •

125 SMX

03 > •

SHERCO

50 ENDURO	02 > 06	•
50 SM	02 >	•
125 125	02 >	•
125 CITY CORP 4T ENDURO	03 >	•
125 CITY CORP 4T SM	03 >	•

SIAMOTO

125 BD	02 >	•
--------	------	---

SIMSON

125 SM	01 >	•
--------	------	---

YAMAHA

125 XT X SUPERMOTARD	05 >	•
----------------------	------	---



07GR15.06

99.6 x 46.9 x 7.4

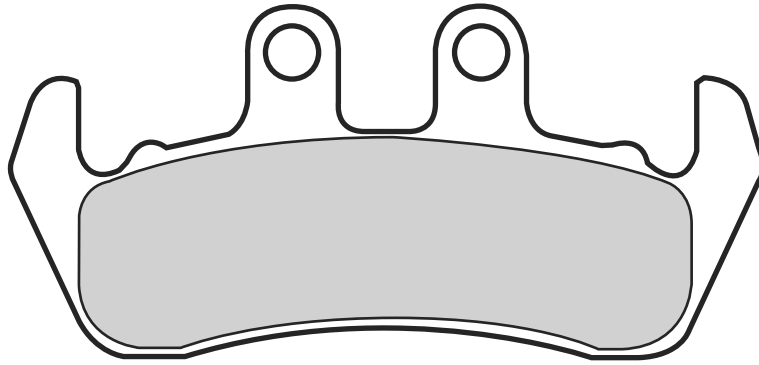

2



YAMAHA

125 DT TENERE SCOUT	90 >	•
125 DTZ TENERE	90 >	•



07GR16.SD

40.8 x 42.1 x 7.4

07GR16.SX

“ “ “

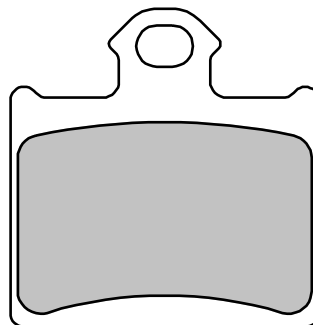

HUSQVARNA

65 CR	12 >	•
85 TC	14 >	•

KTM

0 FREERIDE E	15 >	•
85 SX	11 > 11	•
85 SX	12 >	•
250 FREERIDE R	14 >	•
350 FREERIDE	12 >	•



**07GR17.05**

55.4 x 46.4 x 6

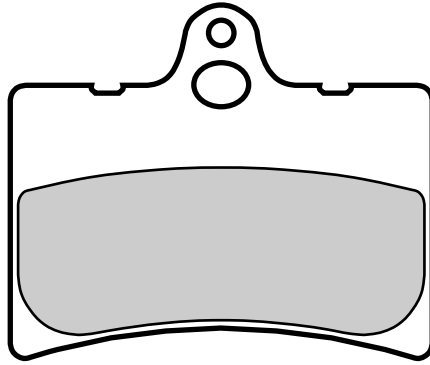
**BETA**

260 TR34 93 > •

CAGIVA

50 PRIMA 93 > •

80 PRIMA 92 > •

125 PRIMA 92 > •

**07GR18.CC**

69.4 x 45.4 x 8.7

07GR18.SA

" " "

07GR18.SC

" " "

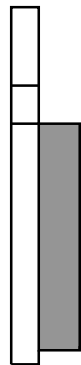
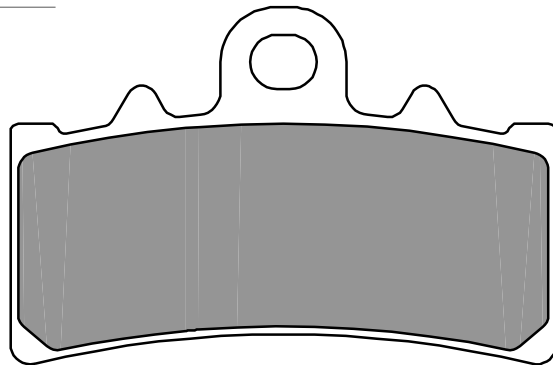
**BMW**

400 C 400 X 18 > •

HUSQVARNA

401 SVARTPILEN 17 > •

401 VITPILEN 17 > •

KTM

125 DUKE 11 > 14 •

125 RC 14 > •

200 DUKE 12 > 14 •

200 RC 14 > •

390 DUKE 13 > 14 •

390 RC 14 > •



07GR19.CC

40.9 x 42.8 x 5.3

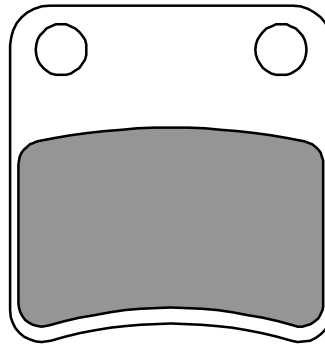

2



APRILIA

850	MANA GT (PARKING BRAKE)	09 > 16	•
-----	-------------------------	---------	---

HONDA

700	A-ADV (PARKING BRAKE)	17 >	•
700	CTX D ABS W/DCT (PARKING BRAKE)	14 > 16	•
700	CTX ND ABS W/DCT (PARKING BRAKE)	14 > 16	•

700	NC SD ABS W/DCT (PARKING BRAKE)	12 >	•
700	NC X PARKING BRAKE	12 >	•
700	TRX INTEGRA PARKING BRAKE	12 >	•
700	VULTUS ABS w/DCT parking brake	15 >	• •
750	NC X (PARKING BRAKE)	14 >	•
750	NCS (PARKING BRAKE)	14 >	•
750	VULTUS ABS w/DCT	15 >	•
750	VULTUS ABS w/DCT parking brake	15 >	•

750	X ADV (PARKING BRAKE)	17 > 18	•
1000	CRF L AFRICA TWIN (PARKING BRAKE)	16 > 18	•
1000	ADV SPORTS (PARKING BRAKE)	18 >	•
1200	CROSSTOURER PARKING BRAKE	12 >	•
1200	VFR FW PARKING BRAKE	10 > 16	•



07GR20.SD

58.6 x 39.7 x 7.5

07GR20.SX

“ “ “

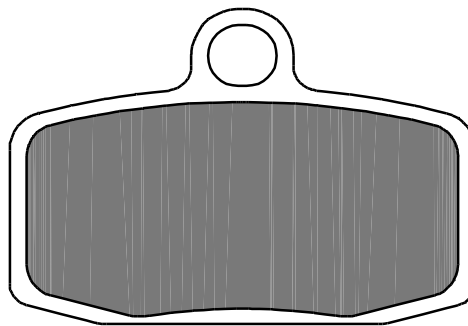

HUSQVARNA

85	TC	14 >	•
----	----	------	---

KTM

	FREERIDE E	15 >	•
85	SX	12 >	•
250	FREERIDE R	14 >	•
350	FREERIDE	12 >	•





07GR21.06

87.1 x 53 x 7.4

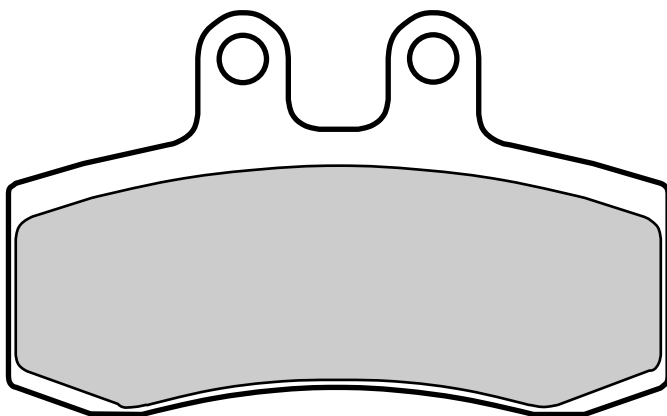

APRILIA

650 PEGASO 92 > 95 •

MZ

125 SM 99 > 01 •
125 SX 99 > 01 •

660 BAGHIRA MUZ 96 > •
660 BLACK PANTHER MUZ 00 > •
660 MASTIFF MUZ 00 > •
660 STREET MOTO MUZ 00 > •



07GR22.SD

67 x 51 x 7

07GR22.SX

“ “ “

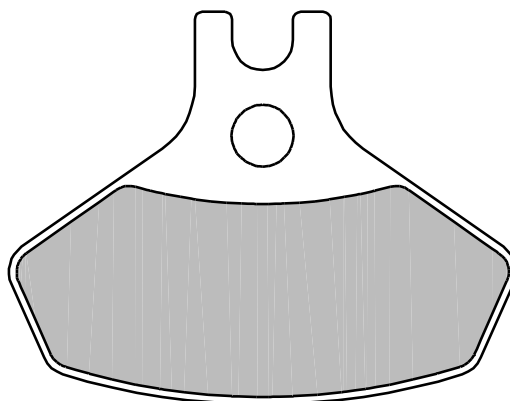

BOMBARDIER-CAN AM

450 DS 08 > 12 •



07GR23.CC

35.8 x 42.1 x 5.9

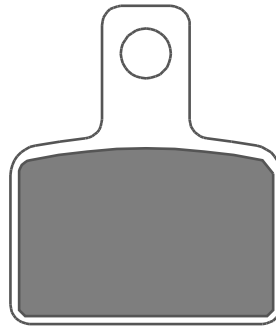

2



BETA

125 EVO	09 >	•
200 EVO	09 >	•
250 EVO (2-T / 4-T)	09 >	•
290 EVO	09 >	•
300 EVO	09 >	•



07GR24.CC

40.8 x 44.6 x 6.4

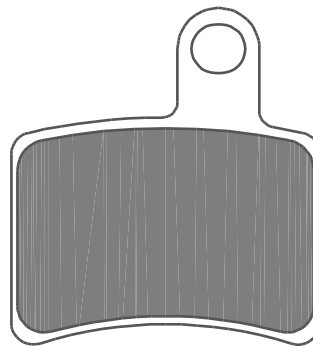
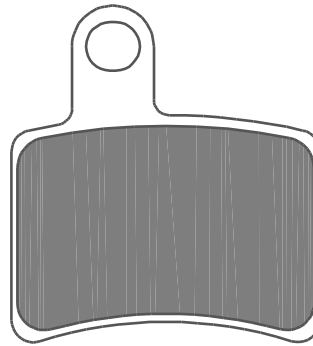

BETA

80 REV	08 >	•
125 REV 3	06 >	•
200 REV3	06 >	•
250 REV 3	05 >	•
250 REV 3 4-T	07 >	•
270 REV 3	05 >	•





07GR25.SD

95.2 x 39.7 x 7.1

07GR25.SX

“ “ “

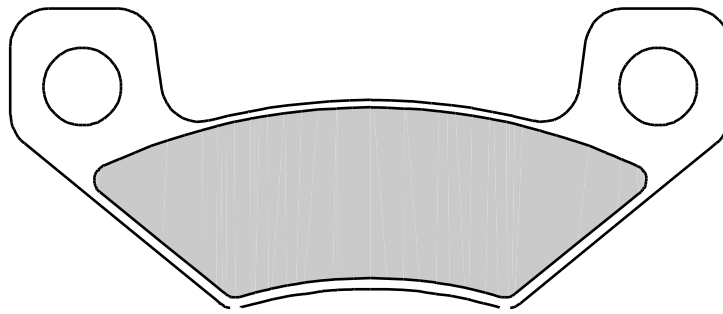

2



BOMBARDIER-CAN AM

450 DS

08 > 12





07GR26.SD

95.1 x 36 x 7.6

109.4 x 39.9 x 7.6

07GR26.SX

“ “ “

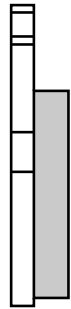
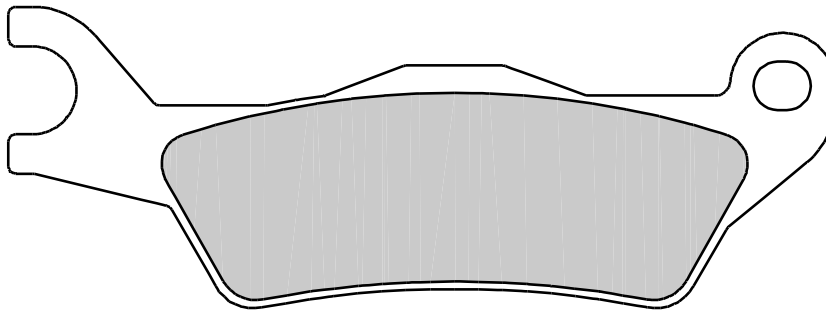
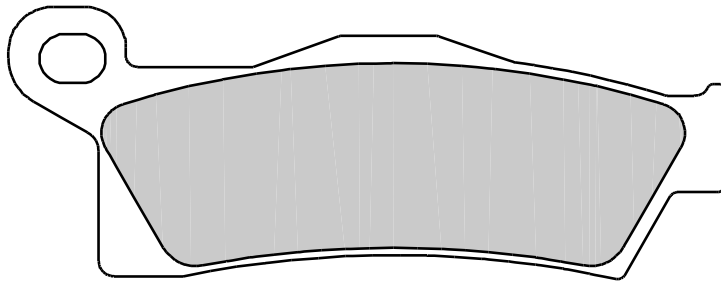

BOMBARDIER-CAN AM

450	OUTLANDER MAX RIGHT/REAR	15 >	• •
450	OUTLANDER RIGHT/REAR	15 >	• •
500	OUTLANDER LEFT/REAR	13 >	• •
500	OUTLANDER MAX LEFT/REAR	13 >	• •
500	OUTLANDER MAX RIGHT	13 >	•
500	OUTLANDER RIGHT	13 >	•

500	RENEGADE LEFT	12 > 13	• •
500	RENEGADE RIGHT/REAR	14 >	• •
650	OUTLANDER LEFT	13 >	• •
650	OUTLANDER LEFT/REAR	13 >	• •
650	OUTLANDER MAX LEFT	13 >	•
650	OUTLANDER MAX RIGHT/REAR	13 >	•
650	OUTLANDER RIGHT/REAR	13 >	•
800	OUTLANDER LEFT/REAR	12 >	• •
800	OUTLANDER MAX RIGHT/REAR	13 >	• •

800	RENEGADE LEFT	12 > 13	• •
800	RENEGADE RIGHT	12 > 13	•
800	RENEGADE RIGHT/REAR	14 >	• •
1000	OUTLANDER LEFT/REAR	12 >	• •
1000	OUTLANDER MAX LEFT/REAR	12 >	• •
1000	OUTLANDER MAX RIGHT	12 >	•
1000	OUTLANDER RIGHT	12 >	•
1000	RENEGADE LEFT	12 > 13	• •
1000	RENEGADE RIGHT	12 > 13	•





07GR27.SD

95.1 x 36 x 7.6
109.4 x 39.9 x 7.6

07GR27.SX

“ “ “

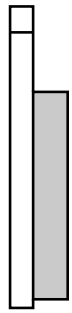
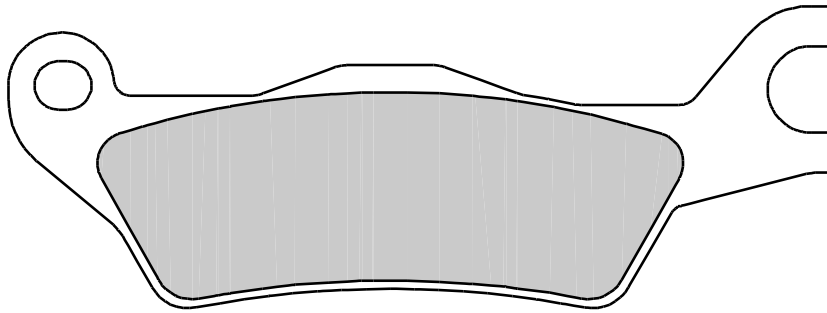
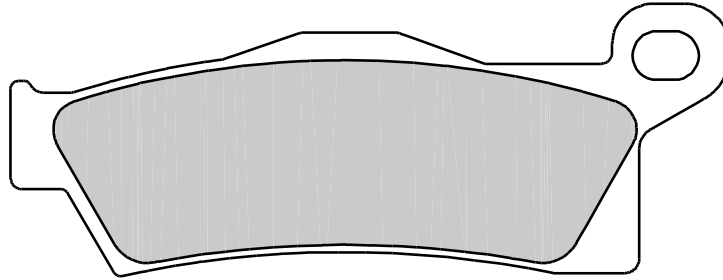

BOMBARDIER-CAN AM

450	OUTLANDER LEFT	15 >	•
450	OUTLANDER MAX/LEFT	15 >	•
500	OUTLANDER MAX RIGHT	13 >	•
500	OUTLANDER RIGHT	13 >	•
500	RENEGADE LEFT	14 >	• •

500	RENEGADE RIGHT	12 > 13	• •
650	OUTLANDER MAX RIGHT/REAR	13 >	•
650	OUTLANDER RIGHT	13 >	•
650	OUTLANDER RIGHT/REAR	13 >	•
800	OUTLANDER MAX LEFT	13 >	•

800	OUTLANDER RIGHT	12 >	•
800	RENEGADE LEFT/REAR	14 >	• •
800	RENEGADE RIGHT	12 > 13	•
1000	OUTLANDER MAX RIGHT	12 >	•
1000	OUTLANDER RIGHT	12 >	•
1000	RENEGADE RIGHT	12 > 13	•



07GR35.SP

69.4 x 42.5 x 7.5

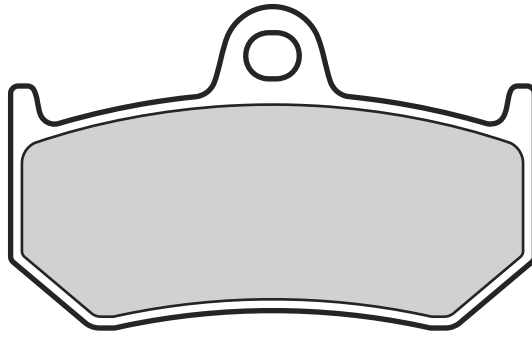

2



MV AGUSTA

750 BRUTALE	03 > 10	•
750 BRUTALE AMERICA	04 >	•
750 BRUTALE GLADIO	05 >	•
750 BRUTALE MAMBA	05 >	•
750 BRUTALE ORO	02 >	•
750 BRUTALE S	02 >	•
750 F4	00 > 04	•
750 F4 AGO	03 >	•
750 F4 SPR	03 >	•
910 BRUTALE R	06 > 08	•
910 BRUTALE S	04 >	•

920 BRUTALE	10 > 11	•
989 BRUTALE R	08 >	•
990 BRUTALE R	10 >	•
1000 F4 312 R	07 >	•
1000 F4 CORSE	05 >	•
1000 F4 MAMBA	03 >	•
1000 F4 R	06 >	•
1000 F4 R 1+1	06 >	•
1000 F4 R CORSA CORTA	12 >	•
1000 F4 RR	11 >	•
1000 F4 RR CORSA CORTA	12 >	•
1000 F4 S, 1+1	04 >	•
1000 F4 SENNA	06 >	•

1000 F4 TAMBURINI	04 >	•
1078 BRUTALE RR	08 >	•
1078 F4 312 RR	08 >	•
1078 F4 CC	08 >	•
1090 BRUTALE	13 >	•
1090 BRUTALE CORSA	14 >	•
1090 BRUTALE R	12 >	•
1090 BRUTALE RR	10 >	•

NORTON

961 COMMANDO CAFE' RACER	18 >	•
--------------------------	------	---





07GR48.04

35.6 x 38.5 x 6

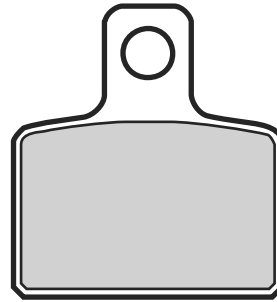

2



APRILIA

50	MINI RX	04 >	•
----	---------	------	---

BETA

50	PRO RACE	04 >	• •
----	----------	------	-----

GAS GAS

125	RANDONE	12 >	•
125	TXT	04 >	•
125	TXT CONTACT	18 >	•
125	TXT GP	18 >	•
125	TXT PRO RACING	14 >	•
125	TXT PRO REPLICA	13 >	•
200	TXT	04 >	•
250	TXT	04 >	•
250	TXT CONTACT	18 >	•
250	TXT GP	18 >	•
250	TXT PRO RACING	14 >	•
250	TXT PRO REPLICA	13 >	•
280	TXT	04 >	•
280	TXT CONTACT	18 >	•
280	TXT GP	18 >	•
280	TXT PRO RACING	14 >	•
280	TXT PRO REPLICA	13 >	•
300	TXT	04 >	•
300	TXT GP	18 >	•

300	TXT PRO RACING	14 >	•
300	TXT PRO REPLICA	13 >	•

HONDA

250	COTA 4 RT	05 >	•
260	COTA 4 RT	14 >	•

HUSQVARNA

50	CR JUNIOR	06 >	•
50	CR PRO SENIOR	06 >	•
50	CR SENIOR	06 >	•

JOTAGAS

125	JT	14 >	•
250	JT	14 >	•
280	JT	14 >	•
300	JT	14 >	•

MONTESA

250	COTA 4RT	05 >	•
260	COTA 4RIDE	16 >	•
260	COTA 4RT	14 >	•
260	COTA 4RT RACE REPLICA	15 >	•
300	COTA RR	15 >	•

360	315R	01 >	04 •
-----	------	------	------

OSSA

280	TR I	10 >	•
280	TR I EXPLORER	12 >	•
300	TR FACTORY R	15 >	•

SCORPA

115	SY F TRIAL	06 >	•
115	TY-S F TRIAL	06 >	•
125	SY F TRIAL	06 >	•
125	TY-S F TRIAL	06 >	•
250	SY F TRIAL	06 >	•
250	SY TRIAL	00 >	•

SHERCO

125	ST	06 >	•
250	2.5	01 >	•
290	2.9	01 >	•
320	3.2 4T	05 >	•

VERTIGO

300	COMBAT CAMO WORKS	15 >	•
300	COMBAT ICE HELL	15 >	•
300	COMBAT RR	15 >	•



07GR49.SD 62 x 40.7 x 9.5
82.2 x 40.7 x 9.5

07GR49.SX “ “ “

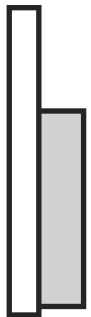
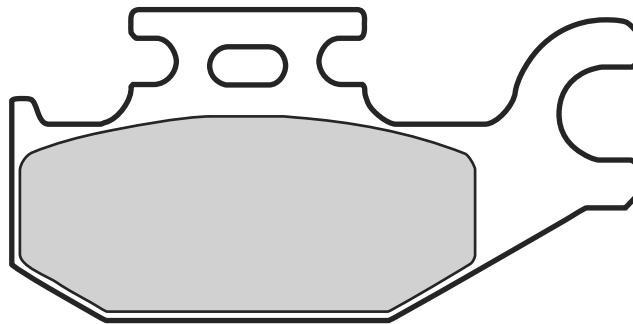
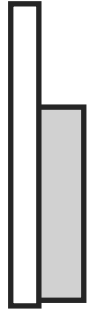
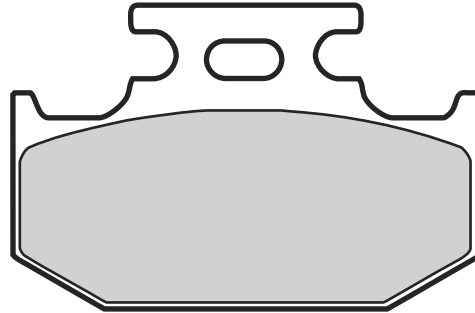

BOMBARDIER-CAN AM

250 DS left/rear	06 > 14	• •
330 OUTLANDER LEFT/REAR	03 > 05	• •
400 OUTLANDER LEFT/REAR	03 > 06	• •
400 OUTLANDER LEFT/REAR	07 >	•
400 OUTLANDER MAX LEFT/REAR	03 > 06	• •
400 OUTLANDER MAX LEFT/REAR	07 >	•
500 QUEST LEFT/REAR	02 >	• •
500 TRAXTER 4X4 LEFT/REAR	01 >	• •
500 TRAXTER MAX LEFT/REAR	03 > 05	•
650 DS (DS650/EBE)	01 >	• •
650 QUEST (QUEST/EBE)	02 >	• •

650 QUEST MAX LEFT/REAR	03 >	•
650 TRAXTER MAX LEFT/REAR	03 > 05	•
800 OUTLANDER	06 >	• •
800 OUTLANDER XT	06 >	• •
1000 COMMANDER MAX LEFT	14 >	•
1000 MAVERICK LEFT	13 >	•

CANNONDALE

440 BLAZE LEFT/REAR	03 >	• •
440 CANNIBAL left/rear	03 >	•
440 CANNIBAL right	03 >	•
440 GLAMIS left/rear	03 >	• •
440 MOTO LEFT/REAR	03 >	• •

SUZUKI

125 BURGMAN ABS	14 >	•
-----------------	------	---

YAMAHA

400 XT	86 >	•
400 YFM FAM KODIAK	00 >	•
400 YFM FWN BIG BEAR 4WD	00 >	•
400 YFM FWNH BIG BEAR-BUCKMASTER 4WD	00 >	•
400 YFM N BIG BEAR 2WD	00 >	•
450 YFM FA_ KODIAK	03 >	•
450 YFM KODIAK	03 >	•
450 YFM WOLVERINE	06 >	•



**07GR50.SD**62 x 40.7 x 9.5
82.2 x 40.7 x 9.5**07GR50.SX**

“ “ “

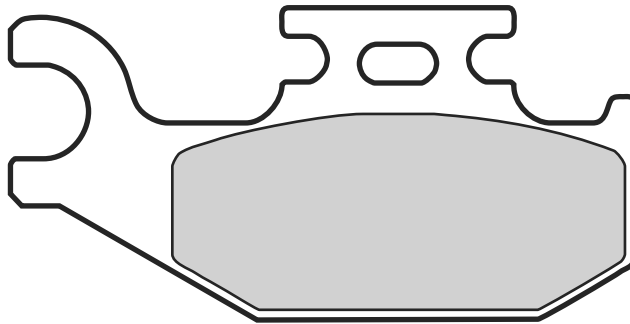
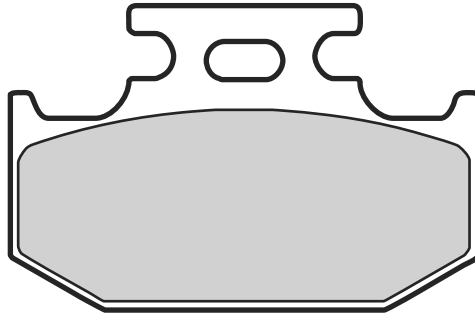
**BOMBARDIER-CAN AM**

250	DS RIGHT	06 > 14	•
330	OUTLANDER RIGHT	03 > 05	•
400	OUTLANDER LEFT/REAR	07 >	•
400	OUTLANDER MAX LEFT/REAR	03 >	•
400	OUTLANDER MAX LEFT/REAR	07 >	•
400	OUTLANDER RIGHT	03 >	•
500	QUEST RIGHT	02 >	•
500	TRAXTER 4X4 RIGHT	01 > 05	• •

650	DS RIGHT (DS650/EBE)	01 >	•
650	QUEST MAX LEFT/REAR	03 >	•
650	QUEST MAX RIGHT	03 >	•
650	QUEST RIGHT (QUEST/EBE)	02 >	•
650	TRAXTER MAX	03 > 05	•
650	TRAXTER MAX LEFT/REAR	03 > 05	•
800	OUTLANDER	06 >	•
800	OUTLANDER XT	06 >	•

1000	COMMANDER MAX RIGHT	14 >	•
1000	MAVERICK RIGHT	13 >	•

CANNONDALE

440	BLAZE RIGHT	03 >	•
440	CANNIBAL left/rear	03 >	•
440	CANNIBAL right	03 >	•
440	GLAMIS left/rear	03 >	•
440	MOTO	03 >	•
440	SPEED	03 >	•



07GR51.05

56.4 x 43.5 x 6.6

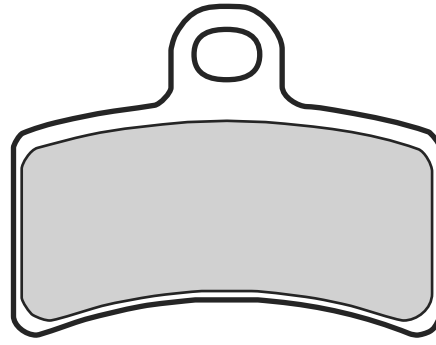

2



GAS GAS

50	EC BOY	01 >	• •
50	EC ROOKIE	01 > 04	•
50	SM ROOKIE	01 >	•
50	TXT BOY	01 > 03	• •
50	TXT ROOKIE	02 > 03	• •
65	MC	05 >	• •
80	TXT ROOKIE	02 > 03	• •
125	PAMPERA	04 >	•
250	PAMPERA	02 >	•
280	PAMPERA	04 >	•





07GR52.09 94 x 47 x 8.7
73 x 47 x 10.7

07GR52.SD “ “ “

07GR52.SX “ “ “

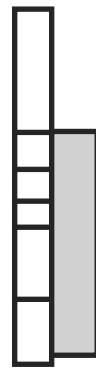
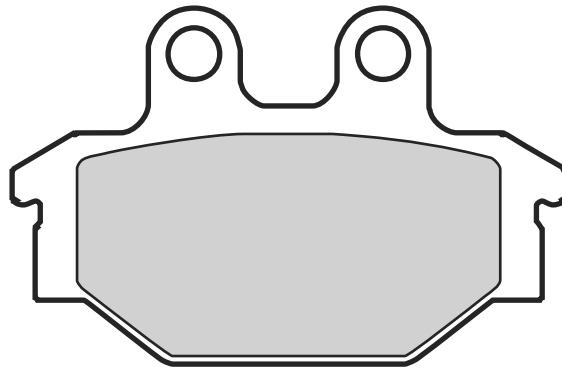
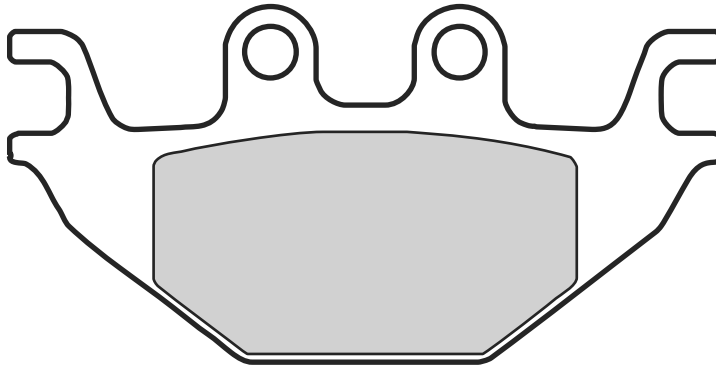

ADLY

300	ATV SPORT	07 >	•
300	CROSS X OVER	07 >	•
300	CROSS X ROAD	07 >	•
320	320 S	07 >	•
320	320 U	07 >	•

ARCTIC CAT

250	DVX	06 > 09	•
300	DVX	09 >	•

CPI

250	XS ATV	07 >	•
-----	--------	------	---

HERCULES

280	ATV	07 >	•
-----	-----	------	---

KAWASAKI

300	KVF BRUTE FORCE	13 >	•
-----	-----------------	------	---

KYMCO

250	KXR	04 >	•
250	KXR (L3/E4/0235)	04 >	•
250	MXU	06 >	•
250	URBAN QUAD	06 >	•
300	MAXXER	06 >	•
300	MAXXER SUPERMOTO	15 >	•
300	MXU	06 >	• •
500	MXU	06 > 08	• •
500	UXV	08 > 10	• •

SYM

125	SB WOLF	11 >	•
-----	---------	------	---

200	TRACKRUNNER	06 >	• •
250	QUADLANDER	06 >	•
250	SB	14 >	•
250	SN NI WOLF	14 >	•
300	CITY MAX	06 >	•
300	CITYCOM	15 >	•
300	QUADLANDER	06 >	• •
300	SB CAFE' RACER	16 >	•
300	WOLF CAFE' RACER	15 >	•
300	WOLF CLASSIC	15 >	•
600	QUAD RAIDER	08 >	• •

YAMAHA

125	MT	14 >	•
125	YZF R	08 > 13	•
125	YZF R	14 >	•



07GR53.SD

94.5 x 45.5 x 7

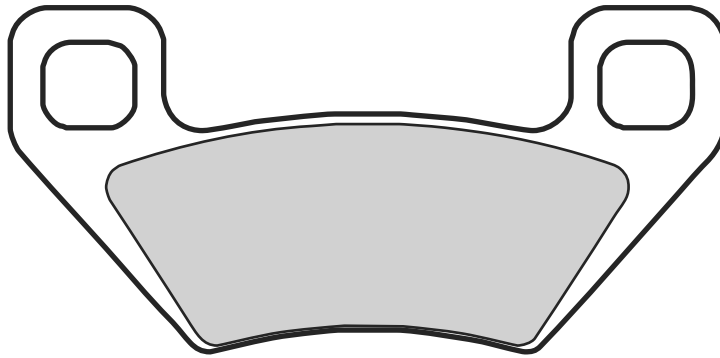

2



ARCTIC CAT

250 2X4	05 >	• •
300 2X4	10 >	•
300 4X4	05 >	• •
400 2X4/4X4 (FIS)	05 >	• •
400 TRV	09 >	• •
450 H1	10 >	• •
450 XC	11 >	• •
500 2X4/4X4 (FIS)	05 >	• •
500 TBX 4X4	05 >	• •
500 TRV 4X4	05 >	• •
550 H1	09 >	• •
550 LTD	09 >	• •
550 PROWLER	09 >	• •

550 TRV	09 >	• •
650 H1 4X4 AUT.	05 >	• •
650 PROWLER	06 >	• •
650 V2 4X4 AUT.	05 >	• •
650 V2 4X4 AUT. LE	05 >	• •
700 DIESEL	06 >	• •
700 H1	09 >	• •
700 PROWLER	08 >	• •
700 TBX	12 >	• •
700 TRV	09 >	• •
700 WILDCAT SPORT	15 >	•
700 WILDCAT SPORT LTD	16 >	•
700 WILDCAT SPORT LTD EPS	17 >	•
700 WILDCAT SPORT XT	15 >	•

700 WILDCAT SPORT XT EPS	16 >	•
1000 PROWLER	09 >	• •
1000 THUNDERCAT	09 >	• •
1000 TRV	09 >	• •
1000 WILDCAT 4X	16 >	•
1000 WILDCAT X LTD	17 >	•
1000 WILDCAT X SE	17 >	•
1000 WILDCAT XS	16 >	•

KYMCO

400 MAXXER	08 > 10	• •
400 MXU	08 > 11	• •
450 MAXXER	10 >	• •
450 MXU I	11 >	•



**07GR54.SD**

67.6 x 44 x 7.7

07GR54.SX

“ “ “

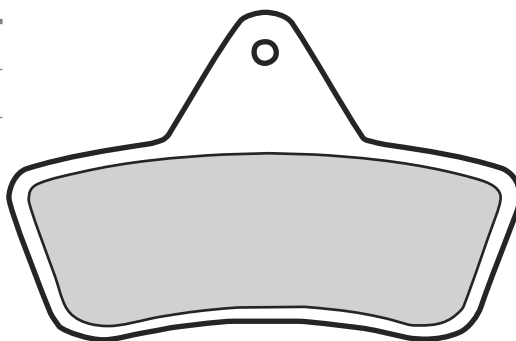
**ARCTIC CAT**

250	2X4/4X4	99 > 04	• •
300	2X4/4X4	98 > 04	• •
375	2X4/4X4	02 >	• •
400	2X4/4X4	98 > 04	• •
400	2X4/4X4 (FIS)	02 > 04	• •
400	TBX 4X4	04 >	• •

454	ARCTIC CAT 4X4	98 >	• •
454	BEAR CAT 2X4/4X4	96 > 98	• •
500	2X4/4X4	98 > 04	• •
500	2X4/4X4 (FIS)	02 > 04	• •
500	TBX 4X4	02 > 04	• •
500	TRV 4X4	03 > 04	• •

LAVERDA

125	HP QUASAR	04 >	•
180	HP QUASAR	04 >	•
400	QUASAR 4X4	04 >	• •
500	QUASAR 4X4	04 >	• •
500	QUASAR 4X4 C	04 >	• •

**07GR55.SD**

43.2 x 25.4 x 8.4

**ARCTIC CAT**

250	2X4 (MAN. HAND BRAKE)	99 >	•
250	4X4 (MAN. HAND BRAKE)	00 >	•
300	2X4 (MAN. HAND BRAKE)	98 > 04	•
300	4X4 (MAN. HAND BRAKE)	98 >	•
375	2X4/4X4 (MAN. HAND BRAKE)	02 >	•
400	2X4 (MAN. HAND BRAKE)	98 > 02	•

400	2X4/4X4 (FIS) AUT. (MAN. HAND BRAKE)	03 > 04	•
400	2X4/4X4 (FIS)(MAN. HAND BRAKE)	02 > 04	•
400	4X4 (MAN. HAND BRAKE)	98 > 04	•
400	TBX 4X4 (MAN. HAND BRAKE)	04 >	•
454	BEAR CAT 2X4/4X4 (MAN. HAND BRAKE)	98 >	•
500	2X4 (FIS)(MAN. HAND BRAKE)	02 >	•
500	2X4 (MAN. HAND BRAKE)	02 >	•

500	4X4 (FIS) AUT.(MAN. HAND BRAKE)	02 > 03	•
500	4X4 (FIS)(MAN. HAND BRAKE)	02 > 03	•
500	4X4 (MAN. HAND BRAKE)	98 > 02	•
500	TBX 4X4 (MAN. HAND BRAKE)	03 > 04	•
500	TBX 4X4 AUT.(MAN. HAND BRAKE)	02 >	•
500	TRV 4X4 (MAN. HAND BRAKE)	03 > 04	•



07GR56.05

67.4 x 50.9 x 7

07GR56.SC

“ “ “

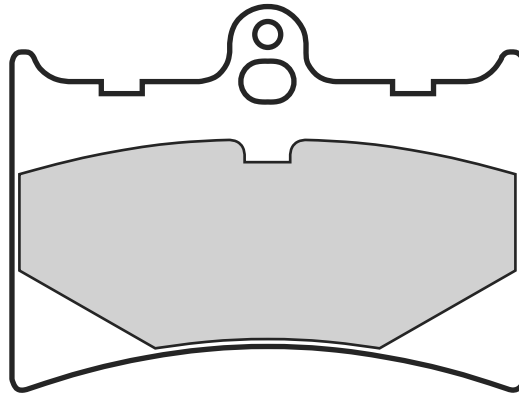

2



ALFER

125 MC	88 >	•
250 GR ENDURO	88 >	•
250 MC	88 >	•
300 GR ENDURO	88 >	•

APRILIA

125 AF-1 EUROPA	89 > 91	•
125 AF-1 FUTURA	89 > 91	•
125 AF1 REPLIC, SINTESI	88 > 89	•
125 RS	99 > 05	•
125 RS EXTREMA	93 > 98	•
125 RS PISTA	04 > 05	•
125 RS REPLIC	93 > 97	•
125 SPORT PRODUCTION	92 >	•
125 TUONO	04 >	•

ASPES

125 SINTESI	88 >	•
-------------	------	---

BENELLI

125 BX	89 > 91	•
125 JARNO	89 > 93	•

GILERA

125 CHRONO	91 >	•
125 CX	91 >	•
125 FREESTYLE	92 >	•
125 MX1	88 >	•
125 SP 01	89 >	•
125 SP 02	89 >	•
600 NORTHWEST	90 >	•

KTM

125 GS	87 > 87	• •
125 MX	87 > 87	• •
250 GS	87 > 87	• •
250 MX	87 > 87	• •
500 MX	87 > 87	• •

600 MC, LC4, ENDURO

88 > • •

MOTO GUZZI

1000 QUOTA	92 > 95	•
------------	---------	---

MZ

660 SKORPION SPORT MUZ	95 > 99	•
660 SKORPION TOUR MUZ	95 > 99	•
660 SKORPION TRAVELLER MUZ	99 >	•

TM

125 CROSS	89 > 90	•
125 CROSS	91 >	•
125 ENDURO	89 > 90	•



07GR57.05

75 x 40.3 x 6.7

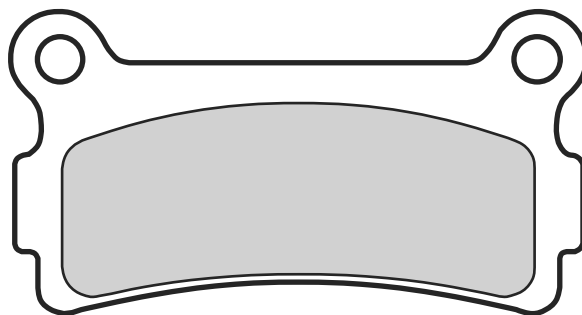

BETA

50 MX ENDURO	92 >	•
50 SUPER TRIAL	92 >	•
125 TRIAL	97 >	•

240 ALP	92 >	•
240 SUPER TRIAL	92 >	•
250 ALP	92 > 96	•
250 ZERO	91 >	•
260 SYNT	92 >	•

260 TR34	89 > 92	•
260 TR34	93 >	•
260 TR35	89 > 92	•
260 ZERO	91 >	•



**07GR58.04**

49.6 x 43.4 x 6

07GR58.SX

“ “ “

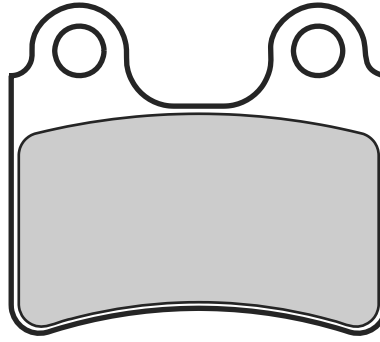
**BETA**

80	EVO	09 >	•
80	REV	08 >	•
125	EVO	09 >	•
125	REV 3	00 > 05	• •
125	REV 3	06 >	•
200	EVO	09 >	•
200	REV3	06 >	•
250	EVO (2-T / 4-T)	09 >	•
250	REV 3	00 > 04	• •
250	REV 3	05 >	•
250	REV 3 4-T	07 >	•
270	REV 3	00 > 04	• •
270	REV 3	05 >	•
290	EVO	09 >	•
300	EVO	09 >	•

GAS GAS

50	EC ROOKIE	05 >	•
125	RANDONE	12 >	•
125	TXT	04 >	•
200	TXT	04 >	•
250	TXT	04 >	•
280	TXT	04 >	•
300	TXT	04 >	•

HONDA

260	COTA 4 RT	14 >	•
-----	-----------	------	---

MONTESA

250	COTA 4RT	05 >	•
260	COTA 4RT	14 >	•
360	315R	01 > 04	•

OSSA

280	TR I	10 >	•
280	TR I EXPLORER	12 >	•

SCORPA

115	SY F TRIAL	06 >	•
125	SY F TRIAL	06 >	•
125	TY-S F TRIAL	06 >	•
250	SY F TRIAL	06 >	•
250	SY TRIAL	00 >	•

SHERCO

125	ST	06 >	•
250	2.5	01 >	•
290	2.9	01 >	•
320	3.2 4T	05 >	•



07GR59.15 71.6 x 34.9 x 9.4

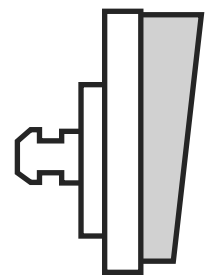
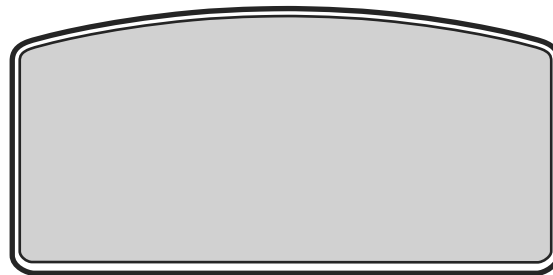
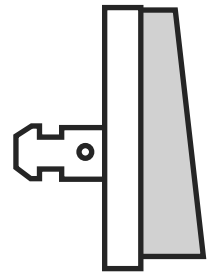
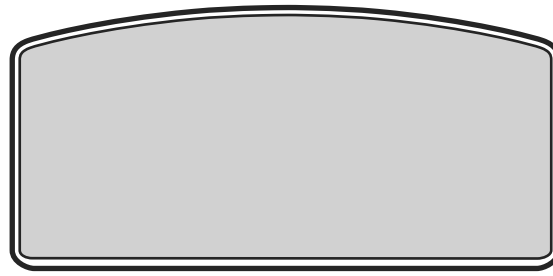

2



BMW

600 R 60/7	76 > 78 •
750 R 75/6	74 > 76 •
750 R 75/7	76 > 77 •

800 R 80/7	77 > 78 •
800 R 80/7	79 > 81 •
900 R 90 S	73 > 76 •
900 R 90/6	73 > 76 •
1000 R 100 RS	76 > 80 •

1000 R 100 RT	79 > 80 •
1000 R 100 S	76 > 77 •
1000 R 100 S	78 > 80 •
1000 R 100 T	79 > •
1000 R 100/7	76 > •



07GR60.07 55.6 x 52.8 x 9

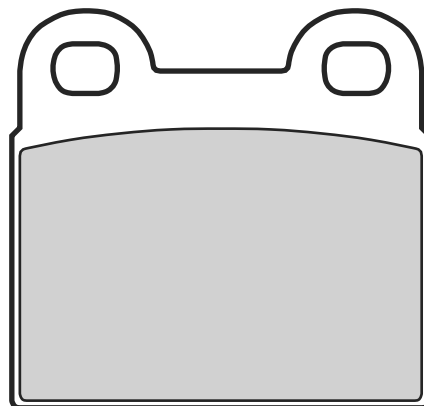

BMW

450 R 45	78 > 80 •
650 R 65	78 > 80 •
1000 R 100 CS	81 > 83 •
1000 R 100 RS	81 > 83 •
1000 R 100 RT	81 > 83 •





07GR62.07	81 x 45.9 x 9
07GR62.SA	“ “ “
07GR62.LA	“ “ “
07GR62.SC	“ “ “

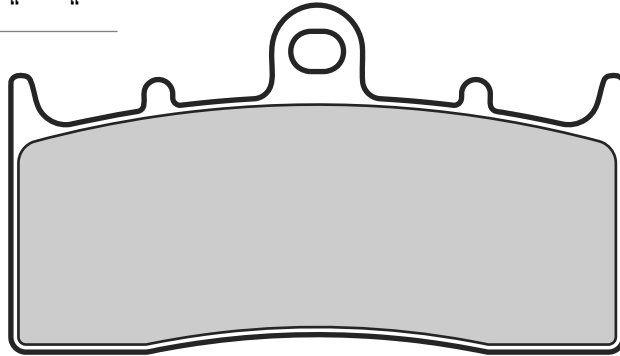

BMW

850 R 850 R	03 >	•
1100 R 1100 S ABS	01 >	•
1150 R 1150 GS	04 > 05	•
1150 R 1150 GS ADVENTURE NO ABS INTEGRALE	02 > 05	•
1150 R 1150 R	01 > 06	•

1150 R 1150 R ROCKSTER	02 > 06	•
1150 R 1150 RS	01 > 06	•
1150 R 1150 S	03 > 06	•
1200 K 1200 LT ABS	01 > 03	•
1200 K 1200 R	05 >	•
1200 K 1200 R SPORT	07 > 11	•
1200 R 1200 C	03 > 04	•
1200 R 1200 R	07 > 14	•

1200 R 1200 R DARK WHITE	14 >	•
1300 K 1300 R	09 > 16	•
1300 K 1300 R DYNAMIC	11 > 16	•
1600 K 1600 B	17 >	•
1600 K 1600 GRAND AMERICA	18 >	•
1600 K 1600 GT	11 >	•
1600 K 1600 GTL	11 >	•



07GR63.19	43.9 x 43.2 x 8
	44.7 x 48.9 x 8

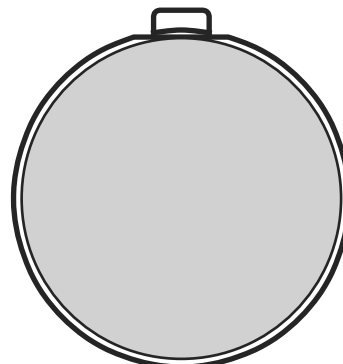
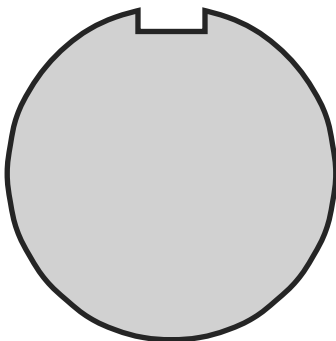

HYOSUNG

125 CRUISE CLASSIC	99 >	•
125 CRUISE II	99 >	•
125 F	00 >	•

125 GA	98 >	•
125 GF	98 >	•
125 GS	99 >	•

SUZUKI

125 GP ALL MODELS	77 >	•
-------------------	------	---



07GR64.07 78.9 x 45.9 x 9
07GR64.TT “ “ “

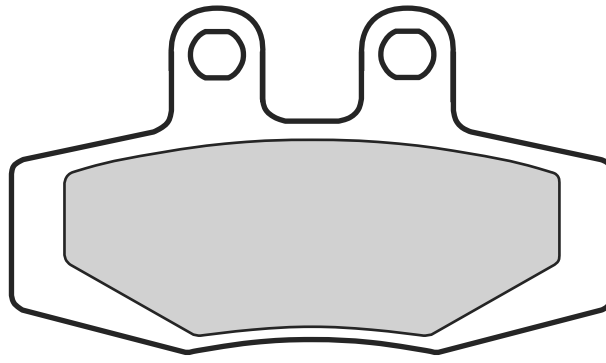

2



KTM

125 EXC	90 > 91	• •
125 GS	88 > 88	• •
125 GS	89 > 91	• •
125 MX	88 > 88	• •
250 EXC	90 > 91	• •
250 GS	88 > 93	• •
250 MX	88 > 88	• •

300 EXC		
350 EXC		
350 GS		
350 MX		
500 MX		
550 LC4		
550 MX		
600 EXC		

90 > 92	• •
87 > 91	• •
87 >	• •
87 >	• •
88 > 88	• •
87 >	• •
87 >	• •
87 >	• •

600 INCAS		
600 MX		

89 >	• •
87 > 90	• •

MAICO

250 GP	89 >	• •
400 GP	89 >	• •
500 GP	89 >	• •



07GR65.27 44.2 x 45.6 x 16
 44.2 x 45.6 x 10

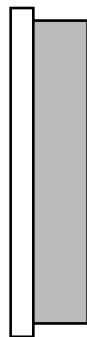
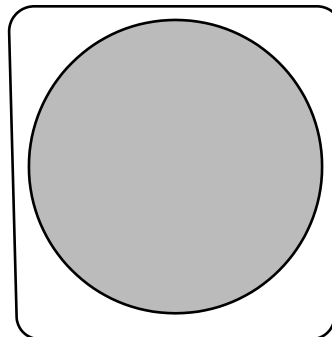
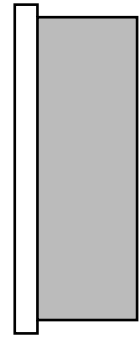
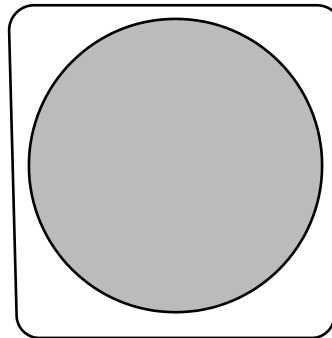

KAWASAKI

90 KH	78 >	•
100 KH EX,G	81 > 82	•
400 KZ	78 > 79	•



**07GR66.10**

59.5 x 52 x 10.4

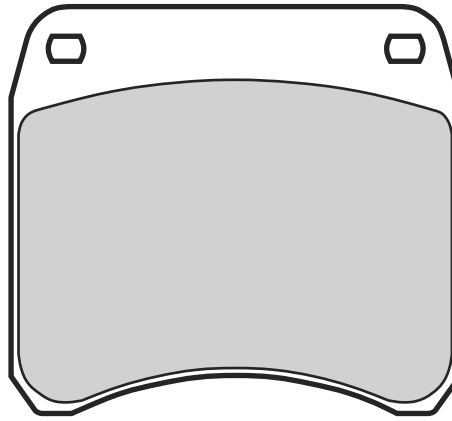
**TRIUMPH**

750	BONNEVILLE T 140 V, E	75 > 80	• •
750	BONNEVILLE T 140 V, E	81 > 83	• •
750	THUNDERBIRD TR 65	81 >	•
750	TIGER TR7 R TRIAL	81 >	•
750	TIGER TR7 V	73 > 81	• •
750	TRIDENT T 160 V	75 > 77	• •
750	TSS	82 >	• •
750	TSX	82 >	• •

**07GR68.SA**

91.6 x 48.5 x 7.9

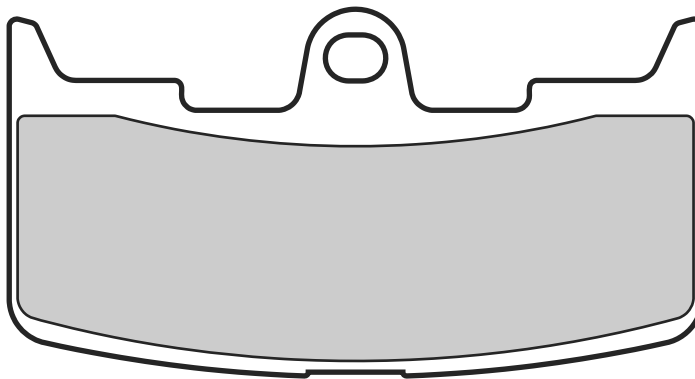
**BUELL**

984	XB9R FIREBOLT	02 >	•
984	XB9S LIGHTNING	03 >	•
984	XB9SX CITY X	05 >	•
1200	XB12 R	04 >	•
1200	XB12 S LIGHTNING	04 > 08	•
1200	XB12 SCG LIGHTNING	04 > 08	•
1200	XB12 STT SUPER TT	07 >	•
1200	XB12 X ULYSSES	06 >	•



07GR69.SD 61.8 x 31.6 x 6.5

07GR69.SX “ “ “

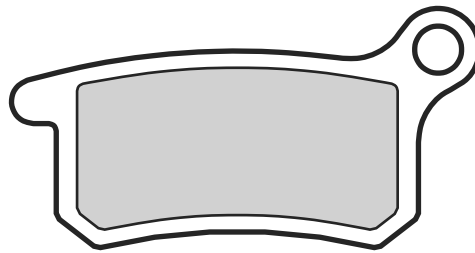
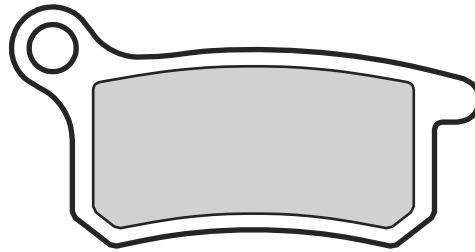

2



HUSQVARNA

65	CR	12 >	•
65	TC	17 >	• •

KTM

65	SX	02 > 03	•
65	SX	04 > 08	•
65	SX	09 >	• •
85	SX	04 > 10	• •
85	SX	11 > 11	•



**07GR70.SD**

43.3 x 25 x 5

07GR70.SX

" " "

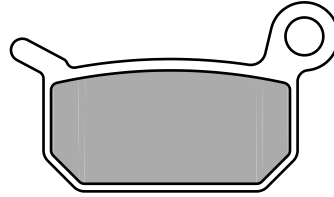
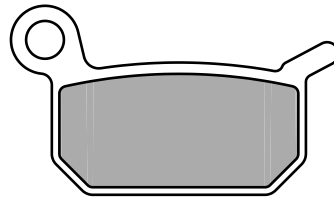
**HUSQVARNA**

50	CR PRO SENIOR	06 >	•
50	CR SENIOR	06 >	•
50	SM	10 >	•
50	TC	17 >	• •

50	SX PRO JUNIOR	02 >	•
50	SX PRO SENIOR	02 > 03	• •
50	SX PRO SENIOR	04 >	• •
50	SX PRO SENIOR	04 >	•
65	SX	04 > 08	•

50	R3	03 >	• •
50	R3 XC	03 >	• •
50	RX2	03 >	• •
50	RX3	03 >	• •
65	RX	05 >	• •
150	RX	11 >	•

KTM

50	SM SUPERMOTO	06 >	• •
50	SX	09 > 18	• •
50	SX MINI	09 > 18	• •

LEM

50	CX2	03 >	• •
50	CX3	03 >	• •
50	R2	03 >	• •

POLINI

50	X1 R	04 >	• •
50	X3 R	04 >	• •
65	X5 RP	05 >	• •

**07GR71.SD**

44.6 x 50.7 x 7

07GR71.SX

" " "

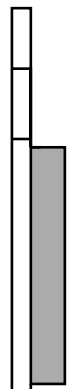
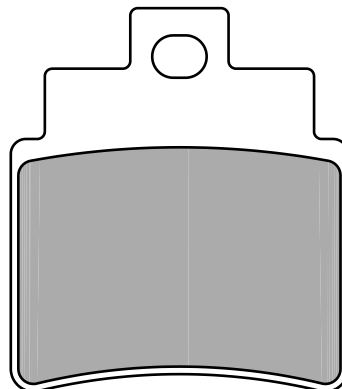
**ARCTIC CAT**

250	DVX	06 > 09	•
300	DVX	09 >	•

GILERA

250	OREGON QUAD	07 >	•
-----	-------------	------	---

KYMCO

250	KXR	04 >	•
-----	-----	------	---

250	KXR (L3/E4/0235)	04 >	•
250	MXU	06 >	•
250	URBAN QUAD	06 >	•
300	MAXXER	06 >	•
300	MAXXER SUPERMOTO	15 >	•



07GR72.SA

69.7 x 51.6 x 7.5

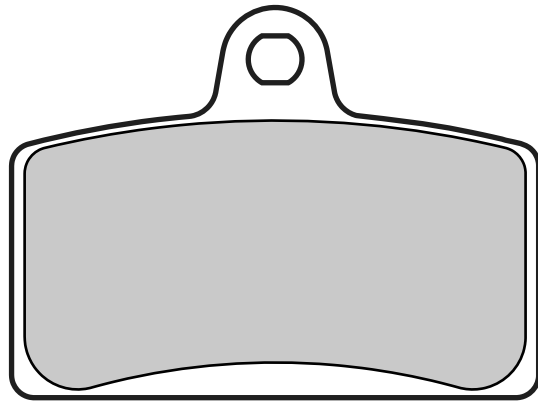

2



APRILIA

125 RS	17 >	•
125 RS-4	11 > 11	•
125 RS-4	12 >	•
125 TUONO ABS	15 >	•

DERBI

50 DRD PRO R	06 >	•
50 GPR	09 >	•
50 GPX1	06 >	•



80 GPR CUP	04 >	•
125 GPR	05 >	•
125 GPR NUDE	05 >	•
125 GPR RACING	09 >	•

GILERA

125 SC	06 >	•
--------	------	---

MALAGUTI

50 DRAKON	05 >	•
-----------	------	---



50 NKD DRAGON	06 >	•
---------------	------	---

PEUGEOT

50 XR7	08 >	•
--------	------	---

RIEJU

50 RS3 PRO	12 >	•
125 RS3	10 >	•
125 TANGO	06 > 07	•



**07GR73.SD**62 x 40.7 x 8.3
82.2 x 40.7 x 8.3**07GR73.SX**

“ “ “

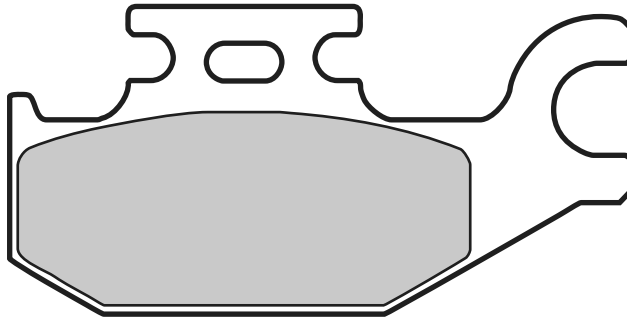
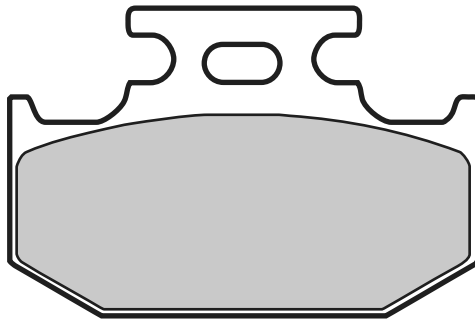
**SUZUKI**

400	KING QUAD KLT-A, KLT-F	08 >	•
400	KING QUAD LT-A, LT-F	08 >	•
450	KING QUAD LT-A	08 >	•
500	LT-A KING QUAD	11 >	•
700	LT-A KING QUAD	05 >	•
750	KING QUAD LT-A LEFT	08 >	•



07GR74.SD

62 x 40.7 x 8.3
82.2 x 40.7 x 8.3

07GR74.SX

“ “ “

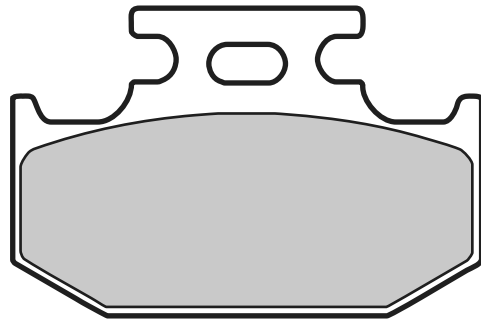

2

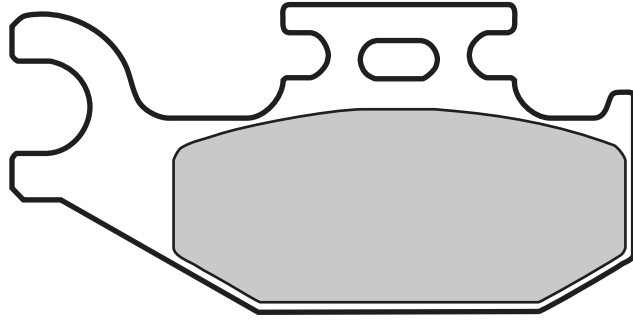

SUZUKI

400	KING QUAD KLT-A, KLT-F	08 >	•
400	KING QUAD LT-A, LT-F	08 >	•
450	KING QUAD LT-A	08 >	•
500	LT-A KING QUAD	11 >	•
700	LT-A KING QUAD	05 >	•
750	KING QUAD LT-A RIGHT	08 >	•

YAMAHA

450	YXR RHINO	06 >	•
700	YFM R RAPTOR left	06 >	•
700	YFM RY left/rear	09 >	•





07GR75.SA 76.7 x 49.7 x 8.3

07GR75.SX “ “ “

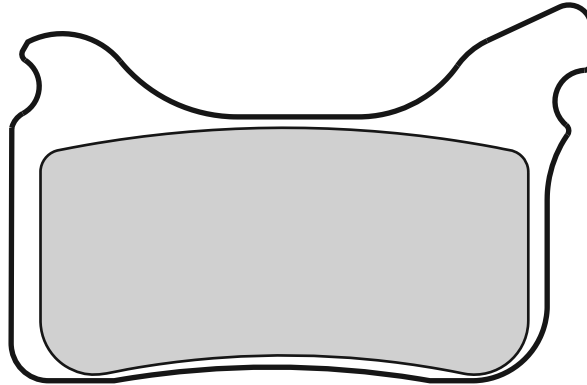
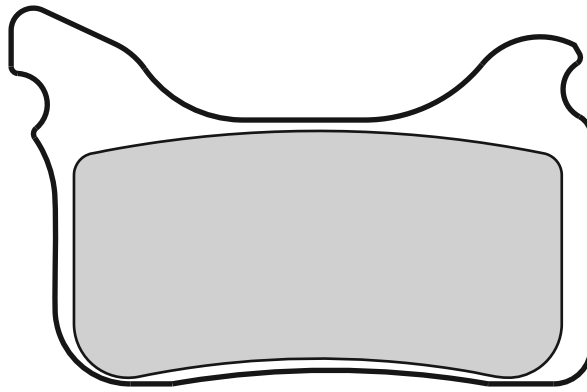

APRILIA

450	SXV	06 > 08	•
550	SXV	06 > 14	•
660	PEGASO FACTORY	05 >	•

KTM

450	SMR	04 > 06	•
525	SMR	05 >	•



07GR76.SA	34.9 x 45.9 x 7.7
07GR76.SX	“ “ “
07GR76.RC	“ “ “

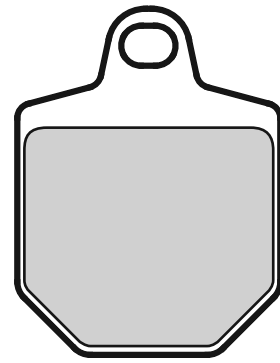

2



HM

125 CRM X SUPERMOTARD	07 > 07	•
250 CRM X SUPERMOTARD	07 >	•
450 CRM X SUPERMOTARD	07 >	•
490 CRE FX	07 >	•
500 CRM F SUPERMOTO	11 >	•
500 CRM X SUPERMOTARD	07 > 09	•

KTM

450 SMR	07 > 12	•
560 SMR	06 >	•



07GR77.07	68.3 x 55.3 x 9.2
07GR77.SA	“ “ “
07GR77.LA	“ “ “
07GR77.SC	“ “ “

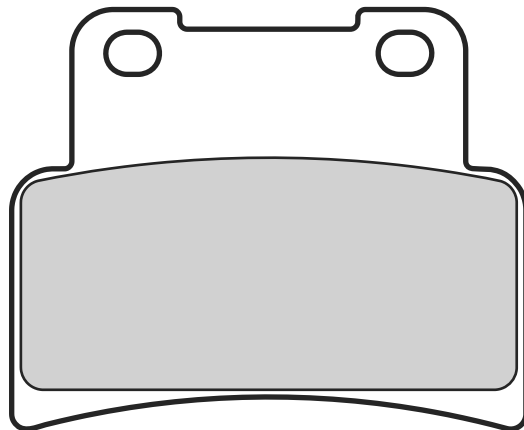

APRILIA

125 RS	06 > 16	•
750 DORSODURO	09 > 16	•
750 DORSODURO ABS	09 > 16	•
750 SHIVER	07 > 16	•
750 SHIVER	09 >	•
750 SHIVER ABS	09 >	•
750 SHIVER GT	09 > 16	•

750 SHIVER GT ABS	09 > 16	•
750 SHIVER SL	07 > 16	•
750 SMV DORSODURO	09 >	•
850 MANA	07 > 07	•
850 MANA	08 > 11	•
850 MANA GT	09 > 16	•
900 DORSODURO	17 >	•
900 SHIVER	17 >	•

SYM

400 MAXSYM	11 >	•
------------	------	---

YAMAHA

125 MT	14 >	•
125 YZF R	14 >	•





07GR78.CC

103.5 x 42.4 x 9.1

62.5 x 34.1 x 11

07GR78.SD

“ “ “

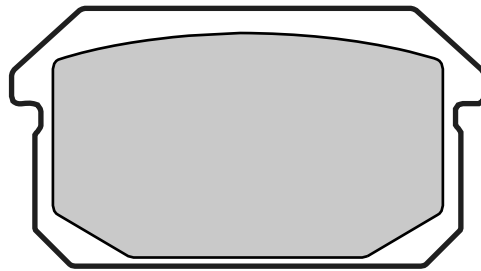
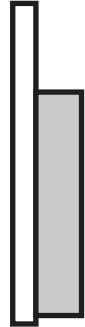
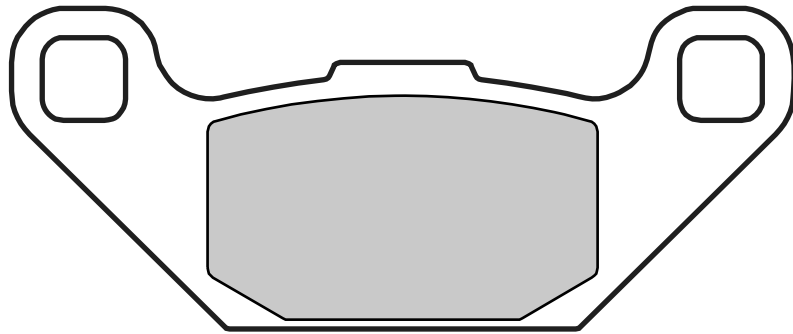

ADLY

300 ATV SPORT

07 >



CPI

250 XS QUAD

06 >



QUADZILLA

250 E 250
250 XRV, E

06 >

06 >





07GR79.CC

93.9 x 32.7 x 8

2

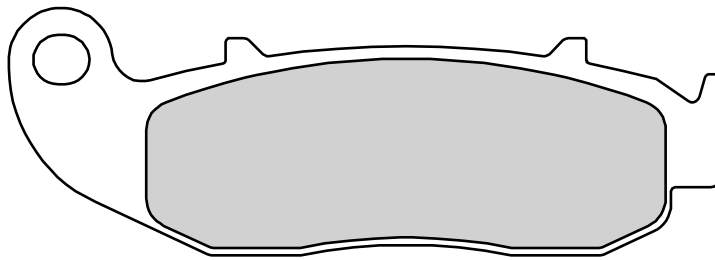
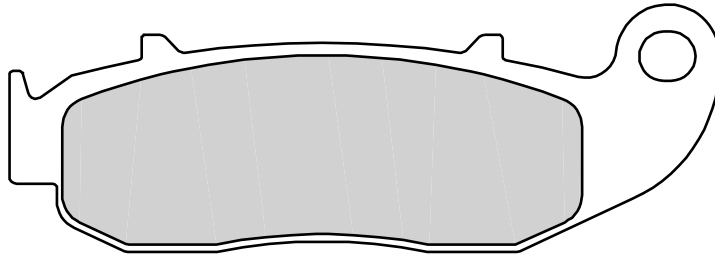

FANTIC MOTOR

50	CABALLERO MOTARD	10 >	•
50	CABALLERO REGOLARITA'	10 >	•
125	CABALLERO MOTARD	10 >	•
125	CABALLERO REGOLARITA'	10 >	•
200	CABALLERO MOTARD	10 >	•
200	CABALLERO REGOLARITA'	10 >	•





07GR80.CC 114.3 x 38.6 x 9.5

07GR80.SA “ “ “

2

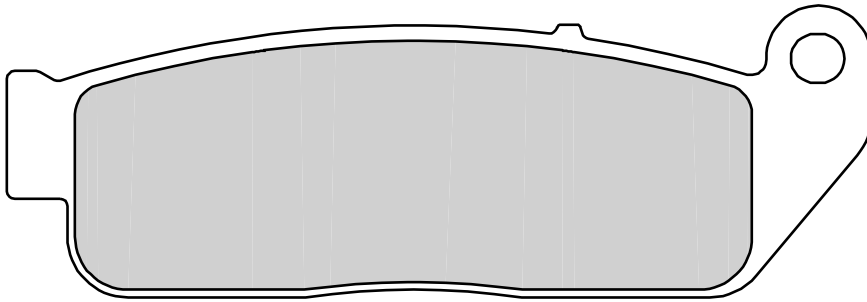
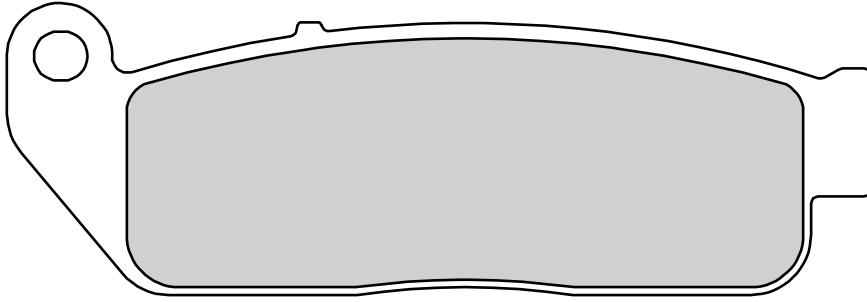

INDIAN

1130 SCOUT

15 > •



07GR81.CC

93.7 x 45.3 x 8.4
72.5 x 45.3 x 10.7

07GR81.SP

“ “ “

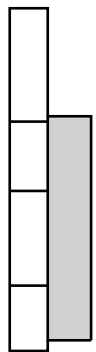
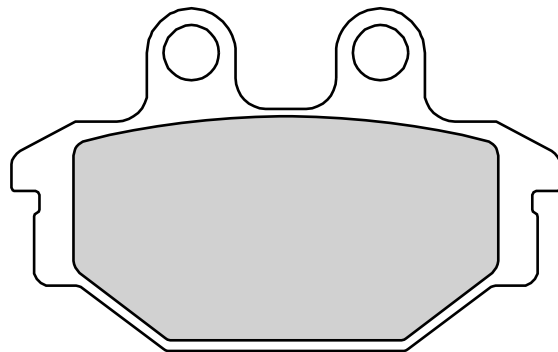
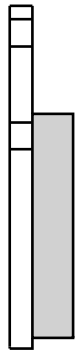
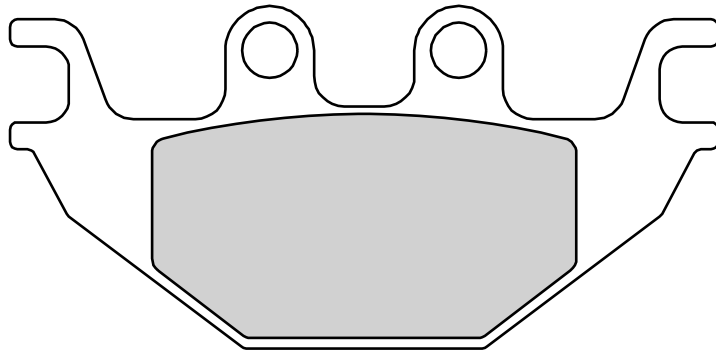

INDIAN

1130 SCOUT

15 >



**07GR82.CC**

40.9 x 42.2 x 5.4

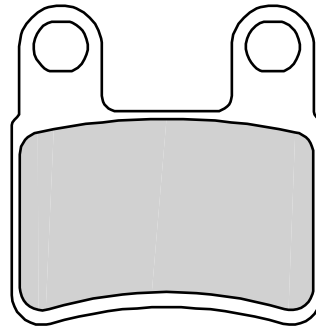
**KYMCO**

400	MAXXER (PARKING BRAKE)	08 > 10	•
400	MXU (PARKING BRAKE)	08 > 11	•
450	MAXXER (PARKING BRAKE)	10 >	•
450	MXU I	11 >	•
450	MXU I (PARKING BRAKE)	11 >	•

**07GR83.SA**

67.6 x 48.3 x 7

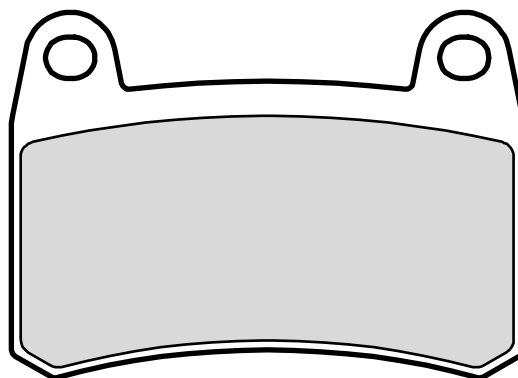
**BENELLI**

250	LEONCINO 250	18 >	•
251	BN 251	15 >	•
300	BN 302	14 >	•
302	TORNADO	16 >	•



07GR84.CC

56 x 31.8 x 5

07GR84.SX

“ “ “

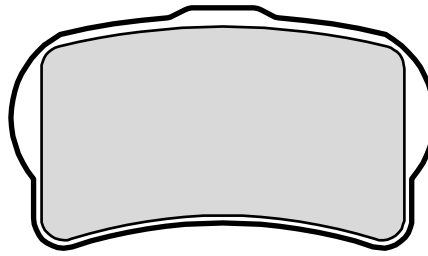

2



GAS GAS

125	TXT CONTACT	18 >	•
125	TXT GP	18 >	•
125	TXT PRO RACING	14 >	•
125	TXT PRO REPLICA	13 >	•
250	TXT CONTACT	18 >	•
250	TXT GP	18 >	•
250	TXT PRO RACING	14 >	•
250	TXT PRO REPLICA	13 >	•
280	TXT CONTACT	18 >	•
280	TXT GP	18 >	•
280	TXT PRO RACING	14 >	•
280	TXT PRO REPLICA	13 >	•

300	TXT GP	18 >	•
300	TXT PRO RACING	14 >	•
300	TXT PRO REPLICA	13 >	•

JOTAGAS

125	JT	14 >	•
250	JT	14 >	•
280	JT	14 >	•
300	JT	14 >	•

MONTESA

260	COTA 4RIDE	16 >	•
-----	------------	------	---

260	COTA 4RT RACE REPLICA	15 >	•
300	COTA RR	15 >	•

OSSA

300	TR FACTORY R	15 >	•
-----	--------------	------	---

VERTIGO

300	COMBAT CAMO WORKS	15 >	•
300	COMBAT ICE HELL	15 >	•
300	COMBAT RR	15 >	•





07GR85.SD 146.2 x 52.3 x 7.6

2

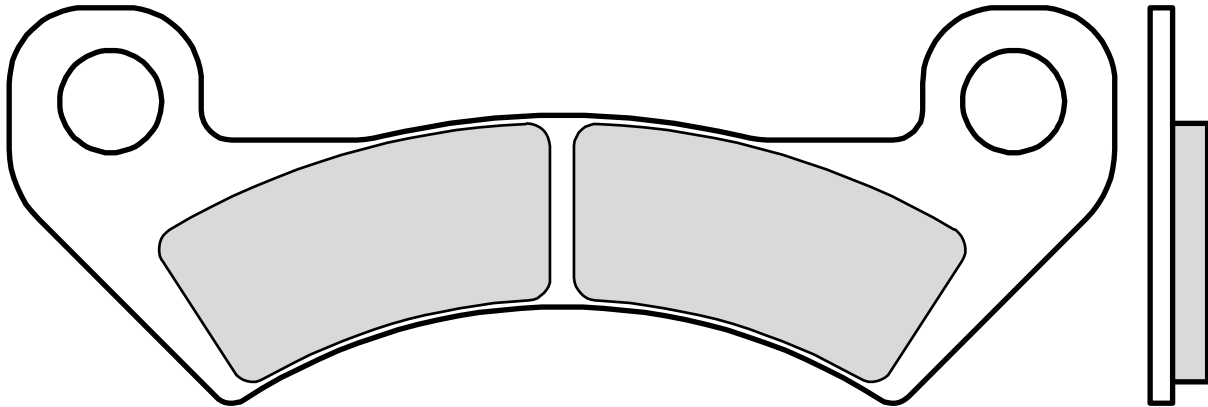

ARCTIC CAT

1000 WILDCAT 4X	16 >	•
1000 WILDCAT X LTD	17 >	•
1000 WILDCAT X SE	17 >	•
1000 WILDCAT XS	16 >	•

JOHN DEERE

625 GATOR	11 >	•
825 D GATOR	11 >	•
825 GATOR	11 >	•



07GR86.SD 101.8 x 42.5 x 6.8

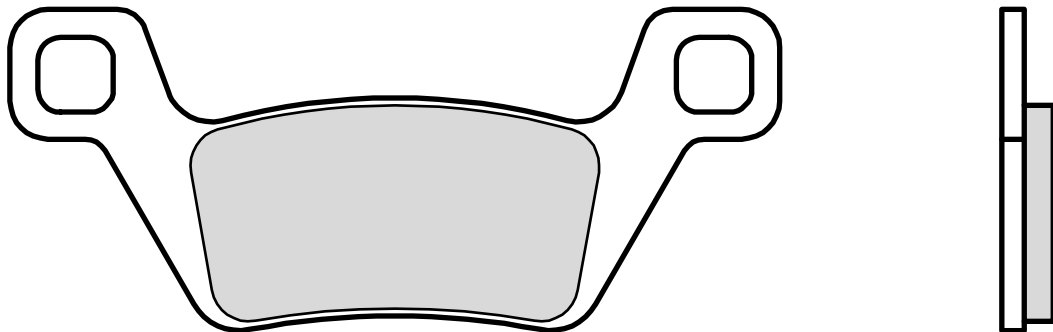

KYMCO

500 MXU	09 > 14	•
500 MXU DX	11 >	•
550 MXU	12 >	•
700 MXU	13 >	•
700 UXV	14 >	•



07GR87.SD 122.1 x 50.9 x 7.8

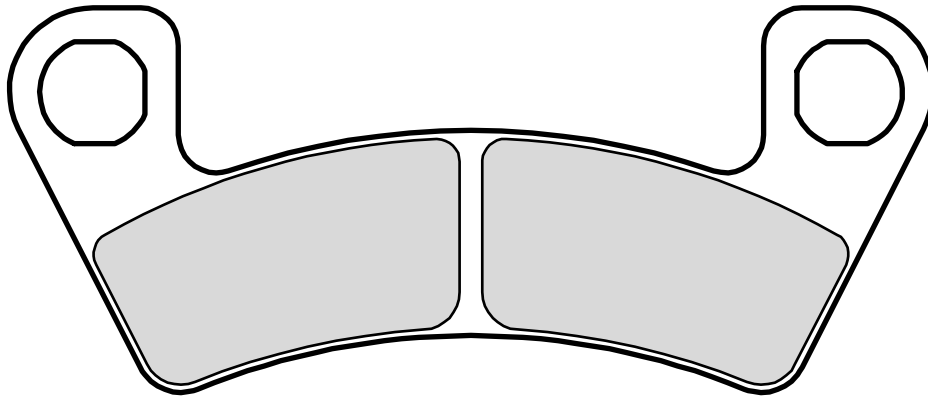

2



ARCTIC CAT

700	WILDCAT SPORT	15 >	•
700	WILDCAT SPORT LTD	16 >	•
700	WILDCAT SPORT LTD EPS	17 >	•
700	WILDCAT SPORT XT	15 >	•
700	WILDCAT SPORT XT EPS	16 >	•





07GR88.SA

96.4 x 43.4 x 8

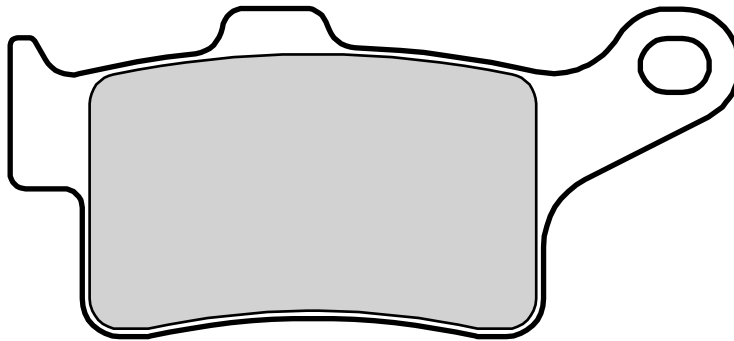
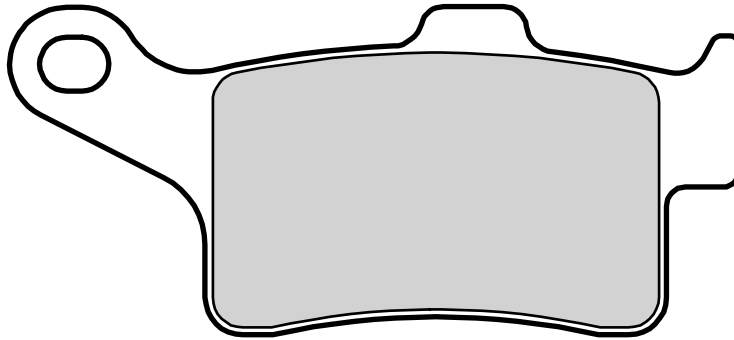

2



BOMBARDIER-CAN AM

1330 SPYDER F3	15 > 18	•
1330 SPYDER F3 LIMITED	16 > 18	•
1330 SPYDER F3 S	15 > 18	•
1330 SPYDER F3 T	16 > 18	•
1330 SPYDER RS	14 > 16	•
1330 SPYDER RS RSS	13 >	•

1330 SPYDER RSS	14 > 15	•
1330 SPYDER RSS SPECIAL SERIES	15 >	•
1330 SPYDER RT	14 > 18	•
1330 SPYDER RT LIMITED	13 > 18	•
1330 SPYDER RTS SPECIAL SERIES	15 >	•

1330 SPYDER ST	14 > 16	•
1330 SPYDER ST LIMITED	13 > 15	•
1330 SPYDER ST STS	13 >	•
1330 SPYDER STS	14 > 15	•
1330 SPYDER STS SPECIAL SERIES	15 >	•



07HD01.05 113.9 x 65.4 x 7.2

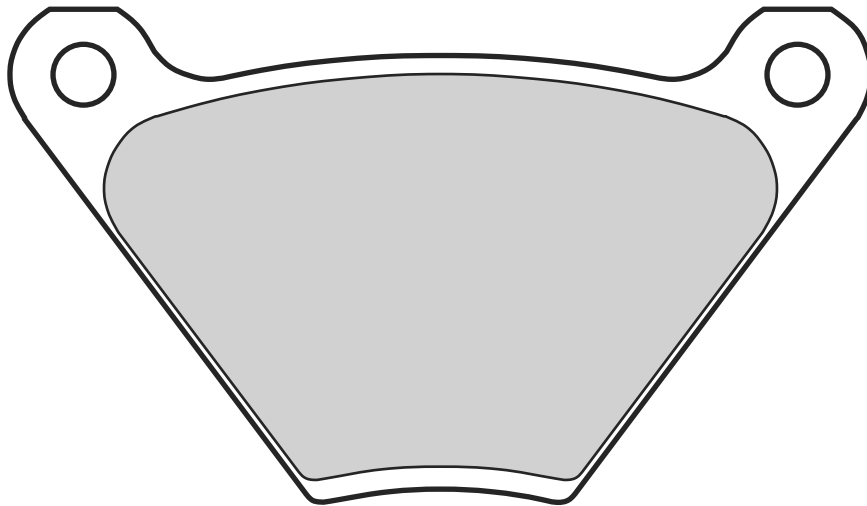

2



HARLEY DAVIDSON

1000 XLCH	73 >	•
1200 FL FLH POLICE	75 > 79	• •
1200 FLH	74 > 76	• •
1200 FLH	80 >	•
1200 FLH ANNIVERSARY	78 >	• •
1200 FLH TOURING	77 > 78	• •
1200 FLHS	77 > 80	• •

1200 FX	74 > 80	•
1200 FXE	74 > 80	•
1200 FXS	78 > 79	•
1340 FLH 80	78 > 80	• •
1340 FLH 80	81 >	•
1340 FLH ELECTRA GLIDE	82 > 83	•
1340 FLH ELECTRA GLIDE SPEC.	84 >	•

1340 FXB 80	80 > 81	•
1340 FXB STURGIS	82 >	•
1340 FXE 80	78 > 81	•
1340 FXE SUPER GLIDE	83 > 84	•
1340 FXEF 80 FAT BOB	79 > 81	•
1340 FXR	78 > 81	•
1340 FXS 80	79 > 81	•
1340 FXS LOW RIDER	82 >	•
1340 FXWG 80	80 > 81	•





07HD02.02

53.4 x 68.8 x 6.5

2

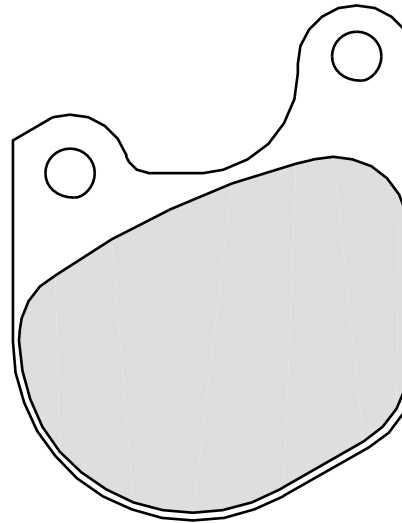
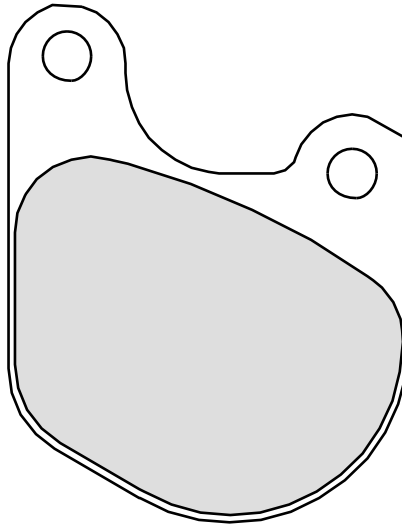

HARLEY DAVIDSON

883 XLH 883 SPORTSTER	70 > 83	•
1000 XL	78 >	•
1000 XLCH	78 > 80	•
1000 XLH SPORTSTER	79 > 82	•
1000 XLH SPORTSTER	83 > 85	•
1000 XLS ANNIVERSARY	82 >	•
1000 XLS SPORTSTER	79 > 82	•
1000 XLS SPORTSTER	83 >	•
1000 XLX 61	83 >	•

1000 XR	85 >	•
1200 FX	74 > 80	•
1200 FXE	74 > 80	•
1200 FXS	78 > 79	•
1340 FLTH TOUR GLIDE	84 >	•
1340 FXB 80	80 > 81	•
1340 FXB STURGIS	82 >	•
1340 FXE	82 >	•
1340 FXE 80	78 > 81	•
1340 FXE SUPER GLIDE	83 > 84	•
1340 FXEF 80 FAT BOB	79 > 81	•

1340 FXR	78 > 81	•
1340 FXR 1340 SUPER GLIDE	82 > 83	•
1340 FXRS LOW GLIDE	82 > 84	•
1340 FXRS SUPER GLIDE II	82 > 83	•
1340 FXRT SUPER GLIDE II	83 >	•
1340 FXS 80	79 > 81	•
1340 FXS LOW RIDER	82 >	•
1340 FXSB LOW RIDER	83 >	•
1340 FXWG 80	80 > 81	•
1340 FXWG WIDE GLIDE	83 > 84	•



07HD03.03 71.1 x 88.9 x 6.6

2

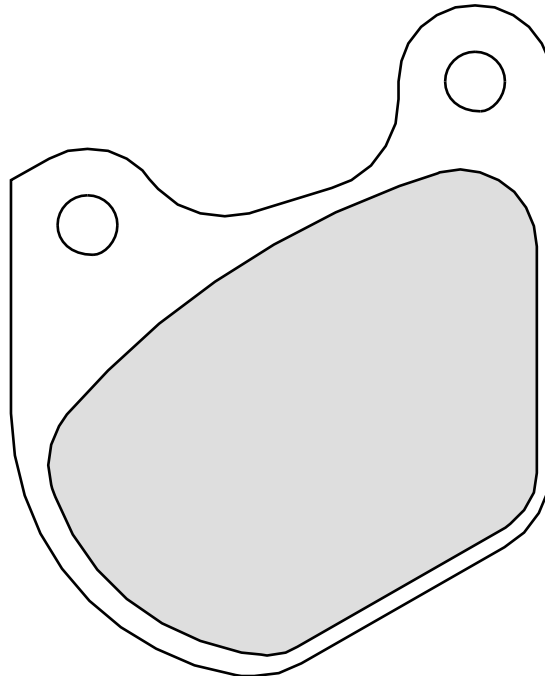
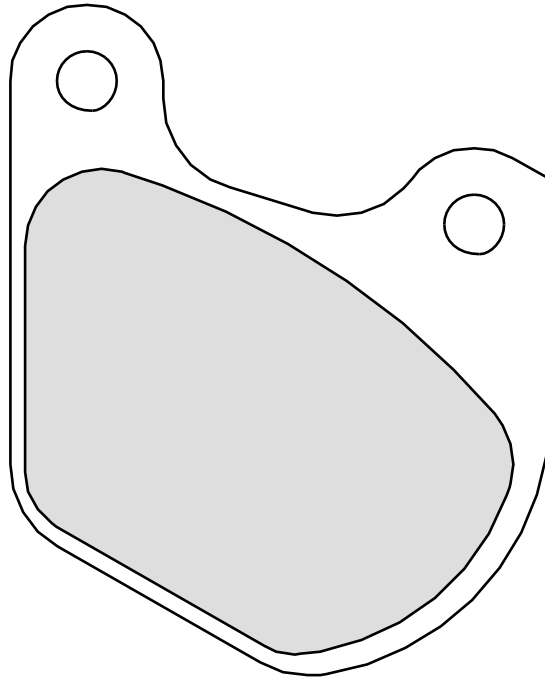

HARLEY DAVIDSON

1000 XL	78 >	•
1000 XLCH	78 > 80	•
1000 XLH SPORTSTER	79 > 82	•

1000 XLS SPORTSTER	79 > 82	•
1340 FLH CLASSIC	82 > 83	•
1340 FLH ELECTRA GLIDE	82 > 83	•
1340 FLH HERITAGE	81 >	•

1340 FLT 80	80 > 81	•
1340 FLT 80 CLASSIC	81 >	•
1340 FLT CLASSIC	82 > 83	•
1340 FLT TOUR GLIDE	82 >	•





07HD04.13

74.4 x 48.9 x 12

2

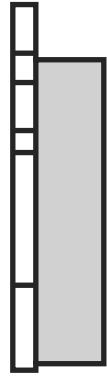
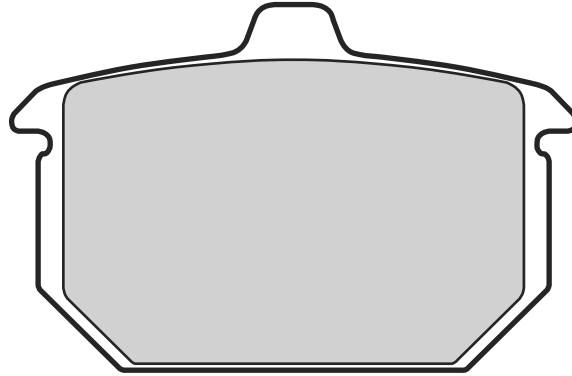

HARLEY DAVIDSON

883	XLH 883 SPORTSTER	85 > 86	•
1000	XLH SPORTSTER	83 > 85	•
1000	XLS ANNIVERSARY	82 >	•
1000	XLS SPORTSTER	83 >	•
1000	XLX 61	83 >	•
1000	XR	85 >	•
1100	XLH SPORTSTER	85 > 86	•
1100	XLX	86 >	•
1340	FLHT ELECTRA GLIDE	85 > 86	•

1340	FLHTC ELECTRA GLIDE CLASSIC	85 > 86	•
1340	FLST HERITAGE SOFTAIL	86 > 87	•
1340	FLTC TOUR GLIDE CLASSIC	85 > 86	•
1340	FXE	85 > 86	•
1340	FXR 1340 SUPER GLIDE	82 > 83	•
1340	FXR 1340 SUPER GLIDE	85 > 86	•
1340	FXRD SPORT GLIDE GTE	85 > 86	•
1340	FXRS LOW GLIDE	82 > 84	•

1340	FXRS LOW RIDER	85 > 86	•
1340	FXRS SUPER GLIDE II	82 > 83	•
1340	FXRT 1340 SPORT GLIDE	85 > 86	•
1340	FXRT SUPER GLIDE II	83 >	•
1340	FXSB LOW RIDER	83 >	•
1340	FXST SOFTAIL	84 > 86	•
1340	FXSTC 1340 SOFTAIL CUSTOM	85 > 86	•
1340	FXWG WIDE GLIDE	83 > 84	•
1340	FXWG WIDE GLIDE	85 > 86	•

ATTENZIONE! IL DISEGNO RIPORTATO NON È IN MISURE ORIGINALI



07HD05.07 174.3 x 72.8 x 10.4

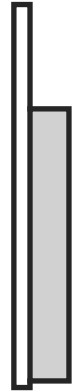
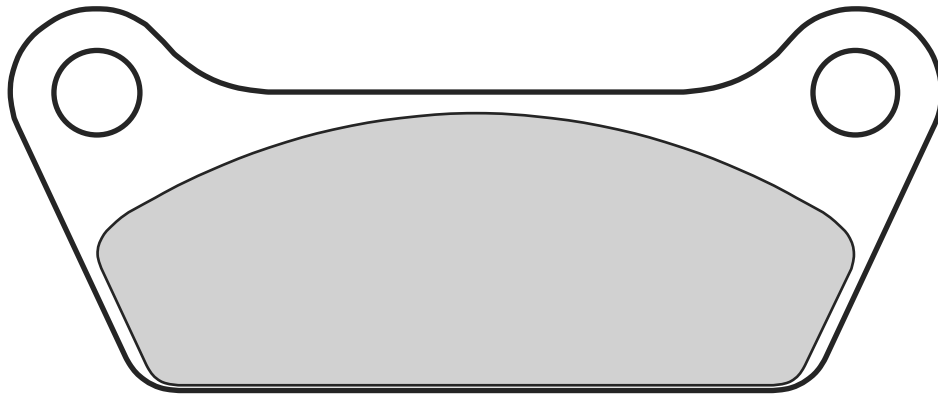

2



HARLEY DAVIDSON

1200 FLH	80 >	•
1340 FLH 80	81 >	•
1340 FLH CLASSIC	82 > 83	•
1340 FLH ELECTRA GLIDE SPEC.	84 >	•
1340 FLH HERITAGE	81 >	•
1340 FLT	84 > 85	•
1340 FLT 80	80 > 81	•
1340 FLT 80 CLASSIC	81 >	•
1340 FLT CLASSIC	82 > 83	•
1340 FLT TOUR GLIDE	82 >	•
1340 FLTH TOUR GLIDE	84 >	•





07HD06.14 59.3 x 61.5 x 13

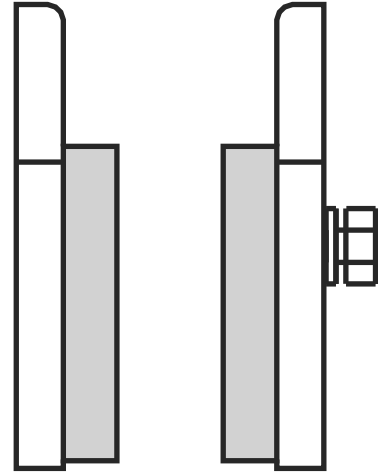
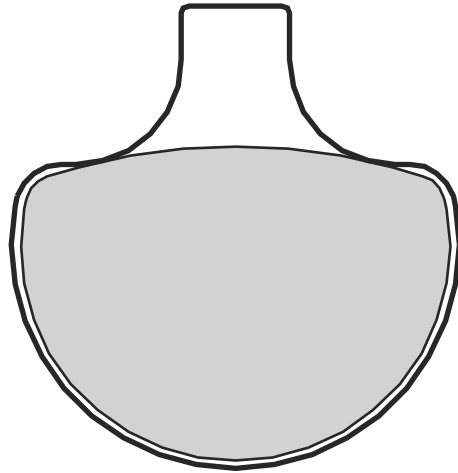

2



HARLEY DAVIDSON

883	XLH 883 SPORTSTER	85 > 86	•
883	XLH 883 SPORTSTER	87 > 89	•
883	XLH 883 SPORTSTER	90 > 99	•
1100	XLH	87 > 88	•
1100	XLH SPORTSTER	85 > 86	•
1100	XLX	86 >	•
1200	XLH 1200 SPORTSTER	90 > 99	•
1340	FLHS ELECTRA GLIDE SPORT	90 >	•
1340	FLHT ELECTRA GLIDE	85 > 86	•
1340	FLHT ELECTRA GLIDE CLASSIC	87 > 99	•
1340	FLHTC ELECTRA GLIDE CLASSIC	85 > 86	•
1340	FLHTC ELECTRA GLIDE CLASSIC	90 > 99	•
1340	FLHTC ELECTRA GLIDE CLASSIC	93 >	•
1340	FLHTC ULTRA CLASSIC	90 > 99	•
1340	FLST HERITAGE SOFTAIL	86 > 87	•
1340	FLST HERITAGE SOFTAIL	88 > 99	•
1340	FLSTC HERITAGE SOFTAIL CLASSIC	90 > 99	•

1340	FLSTF FAT BOY	90 > 99	•
1340	FLSTN HERITAGE SOFTAIL NOST.	93 > 99	•
1340	FLT	84 > 85	•
1340	FLTC TOUR GLIDE CLASSIC	85 > 86	•
1340	FLTC TOUR GLIDE CLASSIC	90 >	•
1340	FXDB DYNA GLIDE DAYTONA	91 > 99	•
1340	FXDB DYNA GLIDE STURGIS	91 > 99	•
1340	FXDB STURGIS	91 > 99	•
1340	FXDL DYNA LOW RIDER	93 > 99	•
1340	FXDWG DYNA WIDE GLIDE	93 > 99	•
1340	FXE	85 > 86	•
1340	FXLR 1340 LOW RIDER CUSTOM	87 > 88	•
1340	FXLR 1340 LOW RIDER CUSTOM	93 > 99	•
1340	FXR	87 > 88	•
1340	FXR 1340 SUPER GLIDE	85 > 86	•
1340	FXR 1340 SUPER GLIDE	90 > 99	•
1340	FXRD SPORT GLIDE GTE	85 > 86	•
1340	FXRS LOW RIDER	85 > 86	•

1340	FXRS LOW RIDER SPORT	87 > 99	•
1340	FXRS LOW RIDER, CONVERT.	90 > 99	•
1340	FXRT 1340 SPORT GLIDE	85 > 86	•
1340	FXRT 1340 SPORT GLIDE	90 > 99	•
1340	FXST SOFTAIL	84 > 86	•
1340	FXSTC 1340 SOFTAIL CUSTOM	85 > 86	•
1340	FXSTC 1340 SOFTAIL CUSTOM	88 > 99	•
1340	FXSTS 1340 SPRINGER SOFTAIL	90 > 99	•
1340	FXWG	87 > 88	•
1340	FXWG WIDE GLIDE	85 > 86	•
1450	FLSTS/I HERITAGE SPRINGER	00 > 03	•
1450	FLSTSC/I SPRINGER SOFTAIL CLASSIC	05 >	•
1450	FXSTS/I SOFTAIL	05 > 05	•
1450	FXSTS/I SOFTAIL	06 > 06	•
1450	FXSTS/I SPRINGER SOFTAIL	00 > 06	•
1584	FLSTSC/I SOFTAIL	07 > 07	•



07HD07.SP 127.1 x 50.8 x 7.4

2

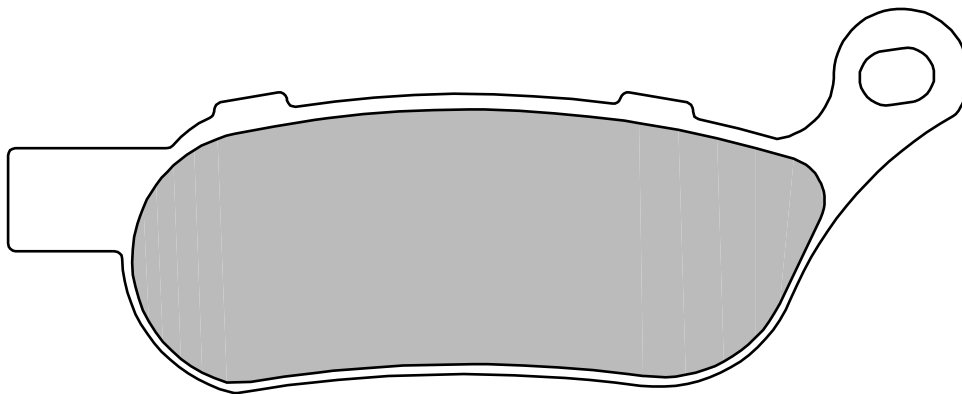
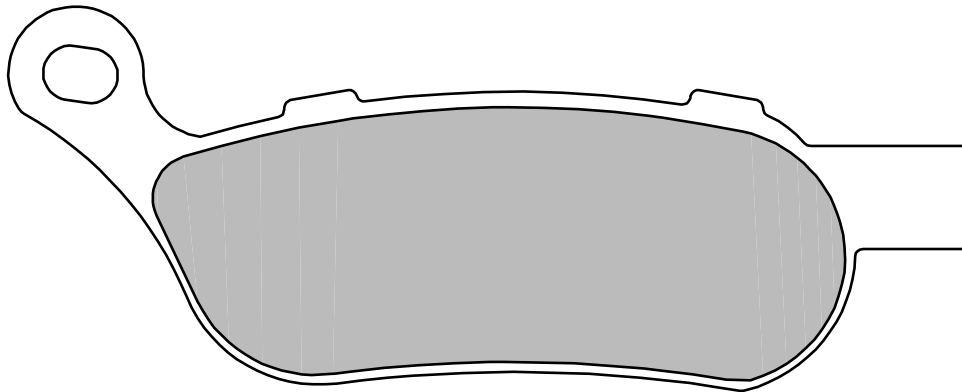

HARLEY DAVIDSON

1584	FLSTC HERITAGE SOFTAIL CLASSIC	08 >	•
1584	FLSTF FAT BOY	08 >	•
1584	FLSTFB FAT BOY SPECIAL	10 >	•
1584	FLSTN SOFTAIL DELUXE	08 >	•
1584	FXCW ROCKER	08 >	•
1584	FXCWC ROCKER C	08 >	•
1584	FXD DYNA SUPER GLIDE	08 >	•
1584	FXDB DYNA STREET BOB	08 >	•
1584	FXDC DYNA SUPER GLIDE CUSTOM	08 >	•

1584	FXDF FAT BOB	08 >	•
1584	FXDL DYNA LOW RIDER	08 >	•
1584	FXDWG DYNA WIDE GLIDE	08 >	•
1584	FXST/SOFTAIL STANDARD	08 >	•
1584	FXSTB NIGHT TRAIN	08 >	•
1584	FXSTC SOFTAIL CUSTOM	08 >	•
1690	BLACKLINE	13 >	•
1690	DYNA LOW RIDER S	17 >	•
1690	DYNA STREET BOB	14 >	•
1690	DYNA SUPER GLIDE CUSTOM	14 >	•

1690	FAT BOY	12 >	•
1690	FAT BOY SPECIAL	12 >	•
1690	FLSTC HERITAGE SOFTAIL CLASSIC	16 >	•
1690	FXDB STREET BOB	16 >	•
1690	FXDF FAT BOB	16 >	•
1690	SOFTAIL DELUXE	12 >	•
1690	SWITCHBACK	12 >	•
1801	FLSS SOFTAIL SLIM S	16 >	•
1801	FLSTFBS FAT BOY S	16 >	•
1802	CVO BREAKOUT	13 >	•
1802	CVO SOFTAIL DELUXE	14 >	•



**07HD08.SP**

46 x 49.5 x 7

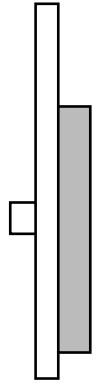
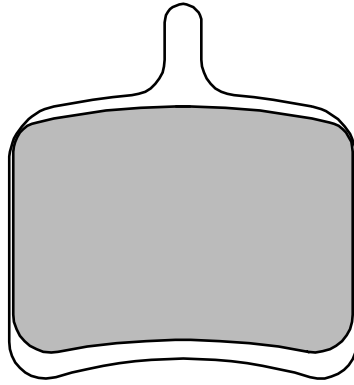
**BUELL**1125 CR
1125 R09 >
08 >**EBR**1190 RX
1190 SX12 >
14 >**07HD09.10**

104.1 x 62 x 11.5

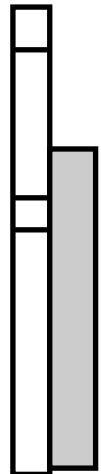
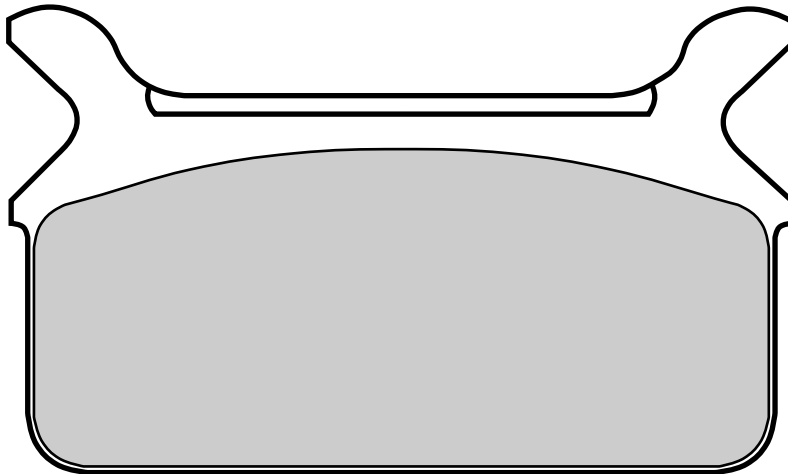
**HARLEY DAVIDSON**

1340	FLHS ELECTRA GLIDE SPORT	90 >	•
1340	FLHTC ELECTRA GLIDE CLASSIC	90 > 99	•
1340	FLHTC ULTRA CLASSIC	90 > 99	•
1340	FLST HERITAGE SOFTAIL	88 > 99	•
1340	FLTC TOUR GLIDE CLASSIC	90 >	•



07HD10.11 104.1 x 62 x 11.3

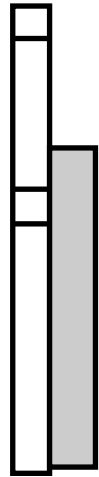
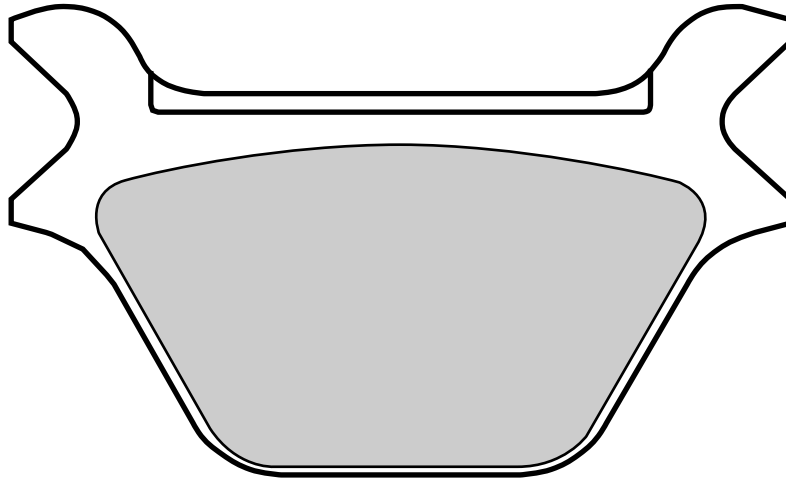

2



HARLEY DAVIDSON

883	XLH 883 SPORTSTER	87 > 89	•	1340	FXDB DYNA GLIDE DAYTONA	91 > 99	•	1340	FXR 1340 SUPER GLIDE	90 > 99	•
883	XLH 883 SPORTSTER	90 > 99	•	1340	FXDB DYNA GLIDE STURGIS	91 > 99	•	1340	FXRS LOW RIDER SPORT	87 > 99	•
1100	XLH	87 > 88	•	1340	FXDB STURGIS	91 > 99	•	1340	FXRS LOW RIDER, CONVERT.	90 > 99	•
1200	XLH 1200 SPORTSTER	90 > 99	•	1340	FXDL DYNA LOW RIDER	93 > 99	•	1340	FXRT 1340 SPORT GLIDE	90 > 99	•
1340	FLHT ELECTRA GLIDE CLASSIC	87 > 99	•	1340	FXDWG DYNA WIDE GLIDE	93 > 99	•	1340	FXSTC 1340 SOFTAIL CUSTOM	88 > 99	•
1340	FLHTC ELECTRA GLIDE CLASSIC	93 >	•	1340	FXE	82 >	•	1340	FXSTS 1340 SPRINGER SOFTAIL	90 > 99	•
1340	FLSTC HERITAGE SOFTAIL CLASSIC	90 > 99	•	1340	FXLR 1340 LOW RIDER CUSTOM	87 > 88	•	1340	FXWG	87 > 88	•
1340	FLSTF FAT BOY	90 > 99	•	1340	FXLR 1340 LOW RIDER CUSTOM	93 > 99	•				
1340	FLSTN HERITAGE SOFTAIL NOST.	93 > 99	•	1340	FXR	87 > 88	•				





07HD11.09 111.9 x 56.2 x 10.9

2

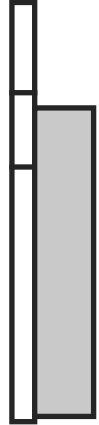
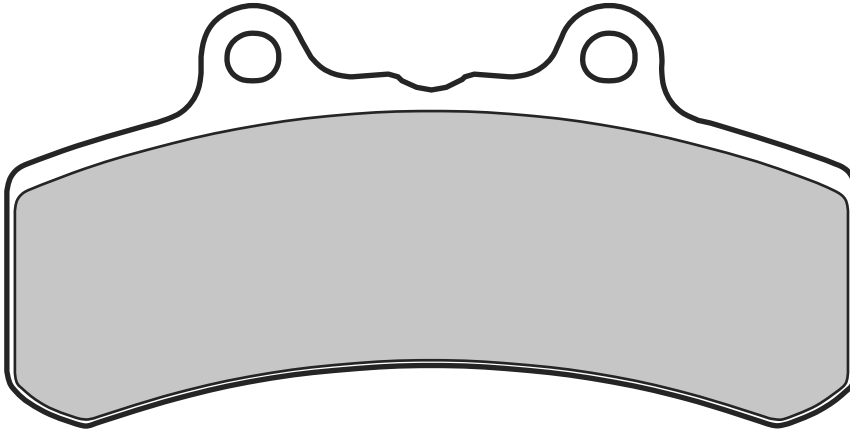

BUELL

1200 M2	97 > 97	•
1200 RS	93 >	•



07HD13.SA 101.6 x 38.6 x 8.9

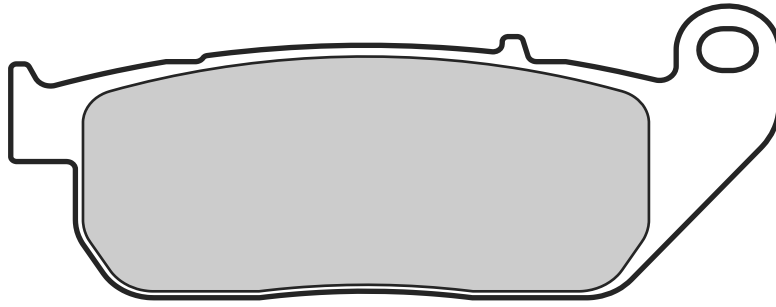

2

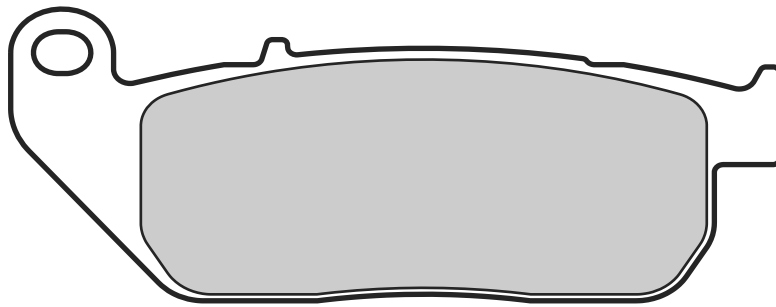

HARLEY DAVIDSON

883	XL 883 R ROADSTER	10 > 13	•
883	XL 883 SPORTSTER	04 >	•
883	XL C SPORTSTER CUSTOM	04 >	•

883	XL L SPORTSTER LOW	06 >	•
883	XL L SUPER LOW	11 > 13	•
883	XL N IRON	13 > 13	•
1200	XL 1200 R SPORTSTER ROADSTER	04 >	•

1200	XL C SPORTSTER CUSTOM	04 > 13	•
1200	XL N NIGHTSTER	07 >	•
1200	XL V SEVENTY-TWO	11 > 13	•
1200	XL X FORTY EIGHT	11 > 13	•





07HD14.SP

85.7 x 44.3 x 10

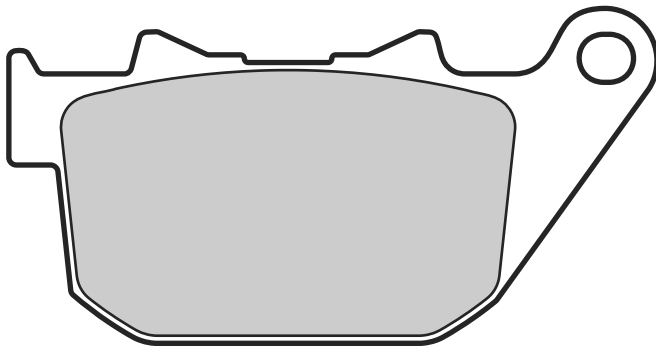
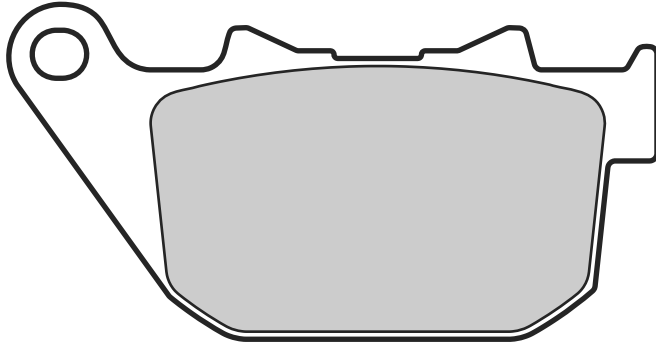

2



HARLEY DAVIDSON

883	XL 883 R ROADSTER	10 > 13	•
883	XL 883 SPORTSTER	04 >	•
883	XL C SPORTSTER CUSTOM	04 >	•
883	XL L SPORTSTER LOW	06 >	•

883	XL L SUPER LOW	11 > 13	•
883	XL N IRON	13 > 13	•
1200	XL 1200 R SPORTSTER ROADSTER	04 >	•
1200	XL C SPORTSTER CUSTOM	04 > 13	•

1200	XL N NIGHTSTER	07 >	•
1200	XL V SEVENTY-TWO	11 > 13	•
1200	XL X FORTY EIGHT	11 > 13	•
1200	XR	08 >	•
1200	XR 1200 X	10 >	•



07HD15.SA

88.6 x 61.8 x 8

2

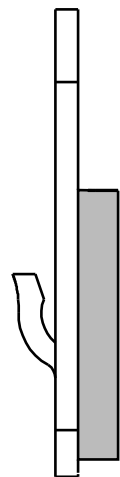
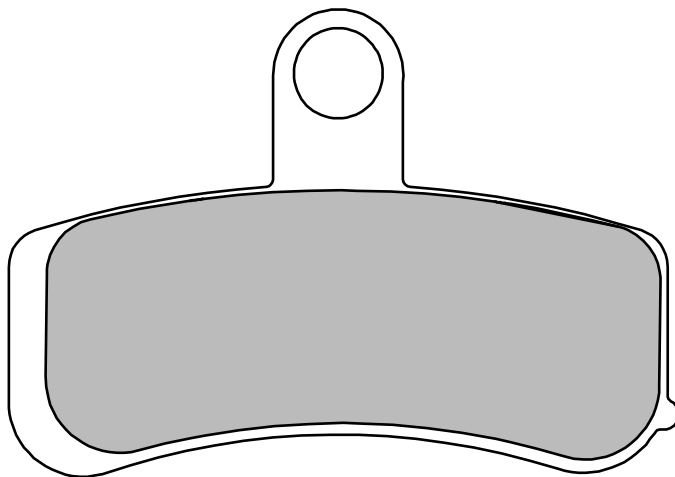
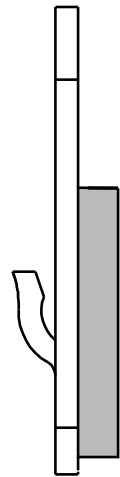
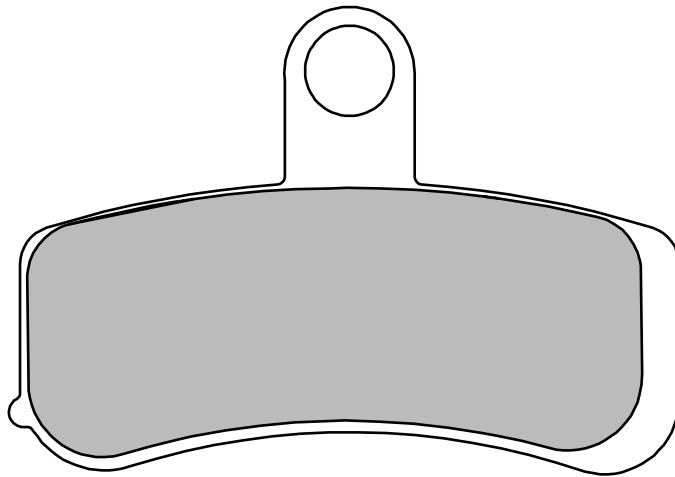

HARLEY DAVIDSON

1584	FLSTC HERITAGE SOFTAIL CLASSIC	08 >	•
1584	FLSTF FAT BOY	08 >	•
1584	FLSTFB FAT BOY SPECIAL	10 >	•
1584	FLSTN SOFTAIL DELUXE	08 >	•
1584	FXCW ROCKER	08 >	•
1584	FXCWC ROCKER C	08 >	•
1584	FXD DYNA SUPER GLIDE	08 >	•
1584	FXDB DYNA STREET BOB	08 >	•

1584	FXDC DYNA SUPER GLIDE CUSTOM	08 >	•
1584	FXDF FAT BOB	08 >	•
1584	FXDL DYNA LOW RIDER	08 >	•
1584	FXDWG DYNA WIDE GLIDE	08 >	•
1584	FXST/SOFTAIL STANDARD	08 >	•
1584	FXSTB NIGHT TRAIN	08 >	•
1584	FXSTC SOFTAIL CUSTOM	08 >	•
1690	BLACKLINE	13 >	•

1690	DYNA LOW RIDER S	17 >	•
1690	DYNA STREET BOB	14 >	•
1690	DYNA SUPER GLIDE CUSTOM	14 >	•
1690	FAT BOY	12 >	•
1690	FAT BOY SPECIAL	12 >	•
1690	FXDB STREET BOB	16 >	•
1690	FXDF FAT BOB	16 >	•
1690	SOFTAIL DELUXE	12 >	•
1690	SWITCHBACK	12 >	•
1802	CVO BREAKOUT	13 >	•
1802	CVO SOFTAIL DELUXE	14 >	•





07HD16.CC

97.3 x 63.4 x 8

07HD16.SA

“ “ “

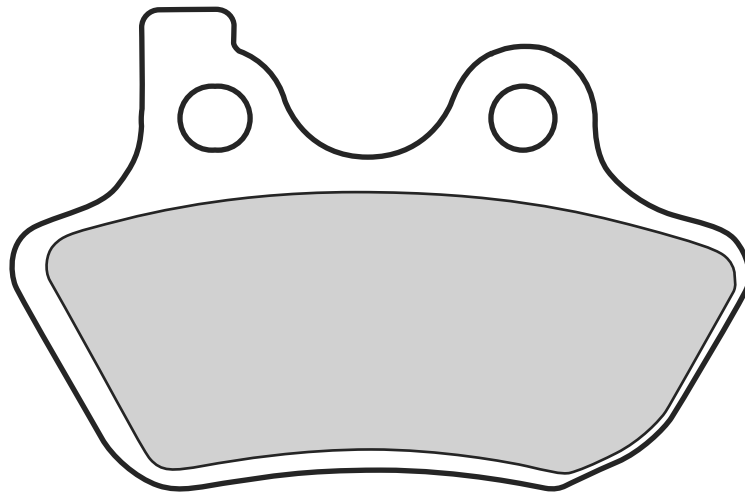
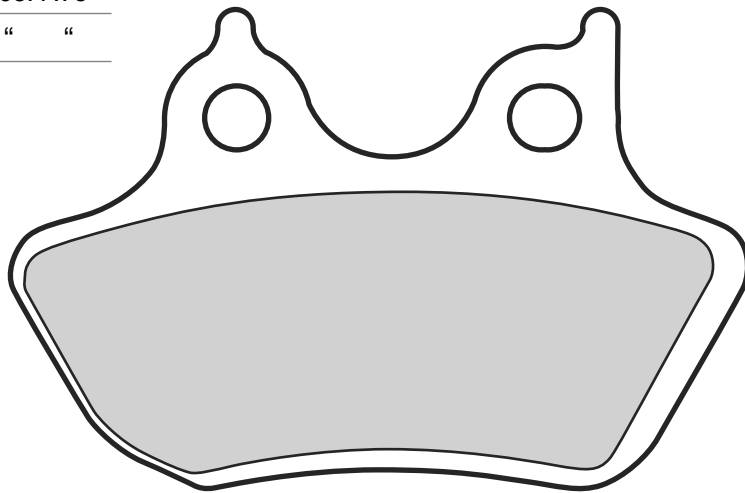

HARLEY DAVIDSON

883	XL 883 R SPORTSER	00 > 03	• •
883	XL 883 SPORTSTER CUSTOM	00 > 03	• •
883	XLH 883 SPORTSTER	00 > 03	• •
883	XLH 883 SPORTSTER HUGGER	00 > 03	• •
1130	VRSCA V-ROD	02 > 05	• •
1130	VRSCB V-ROD	04 >	• •
1200	XL SPORTSTER CUSTOM	00 > 03	• •
1200	XL SPORTSTER SPORT	00 > 03	• •
1200	XLH 1200 SPORTSTER	00 > 03	• •
1450	FLHR/I ROAD KING	00 > 06	• •
1450	FLHRCI ROAD KING CLASSIC	00 > 06	• •
1450	FLHRS/I ROAD KING CUSTOM	04 > 06	• •

1450	FLHT/I ELECTRA GLIDE STANDARD	00 > 06	• •
1450	FLHTC/I ELECTRA GLIDE CLASSIC	00 > 06	• •
1450	FLHTCUI ULTRA CLASSIC ELECTRA GLIDE	00 > 06	• •
1450	FLHXI STREET GLIDE	06 >	• •
1450	FLSTC HERITAGE SOFTAIL CLASSIC	00 > 04	• •
1450	FLSTC SOFTAIL	06 > 07	• •
1450	FLSTCI SOFTAIL	06 > 06	• •
1450	FLSTF FAT BOY	06 > 07	• •
1450	FLSTF/I FAT BOY	00 >	• •
1450	FLSTI HERITAGE SOFTAIL	06 >	•
1450	FLSTN/I SOFTAIL DELUXE	05 >	• •

1450	FLSTS/I HERITAGE SPRINGER	00 > 03	•
1450	FLSTSC/I SPRINGER SOFTAIL CLASSIC	05 >	•
1450	FLTR/I ROAD GLIDE CLASSIC	00 > 06	• •
1450	FXD DYNA SUPER GLIDE	00 > 03	• •
1450	FXDBI DYNA STREET BOB	06 >	• •
1450	FXDC/I DYNA SUPER GLIDE CUSTOM	05 > 06	• •
1450	FXDI 35TH ANNIVERSARY SUPER GLIDE	06 >	•
1450	FXDI DYNA SUPER GLIDE	04 > 06	• •
1450	FXDL DYNA LOW RIDER	00 > 03	• •
1450	FXDLI DYNA LOW RIDER	04 >	• •



1450	FXDS DYNA CONVERTIBLE	00 > 02	• •
1450	FXDWG DYNA WIDE GLIDE	00 > 03	• •
1450	FXDWGI DYNA WIDE GLIDE	00 > 06	• •
1450	FXDX DYNA SUPER GLIDE SPORT	00 > 03	• •

1450	FXDXI DYNA SUPER GLIDE SPORT	04 > 06	• •
1450	FXDXT DYNA SUPER GLIDE T-SPORT	00 > 03	• •
1450	FXST SOFTAIL STANDARD	00 > 05	• •
1450	FXST SOFTAIL STANDARD	06 >	•

1450	FXSTB/I NIGHT TRAIN	00 > 05	• •
1450	FXSTB/I NIGHT TRAIN	06 >	•
1450	FXSTD/I SOFTAIL DUECE	00 > 05	• •
1450	FXSTD/I SOFTAIL DUECE	06 >	•
1450	FXSTS/I SOFTAIL	05 > 05	•
1450	FXSTS/I SPRINGER SOFTAIL	00 > 06	•
1584	FXSTD SOFTAIL DEUCE	07 > 07	•



07HD18.CC

97.5 x 63.6 x 8

07HD18.SP

“ “ “

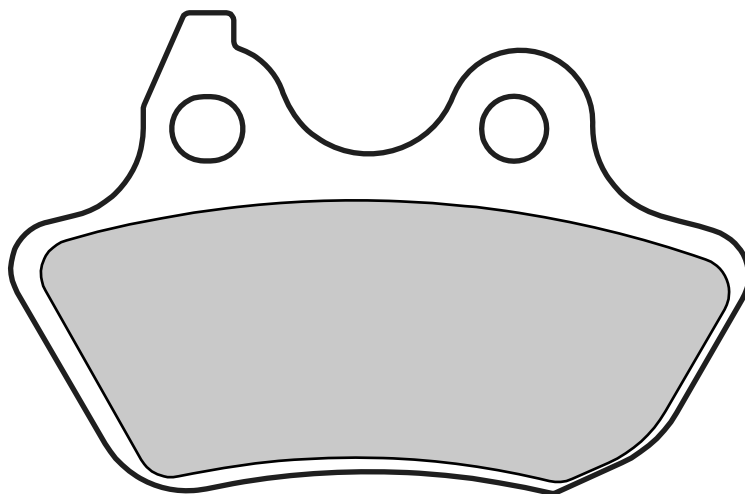
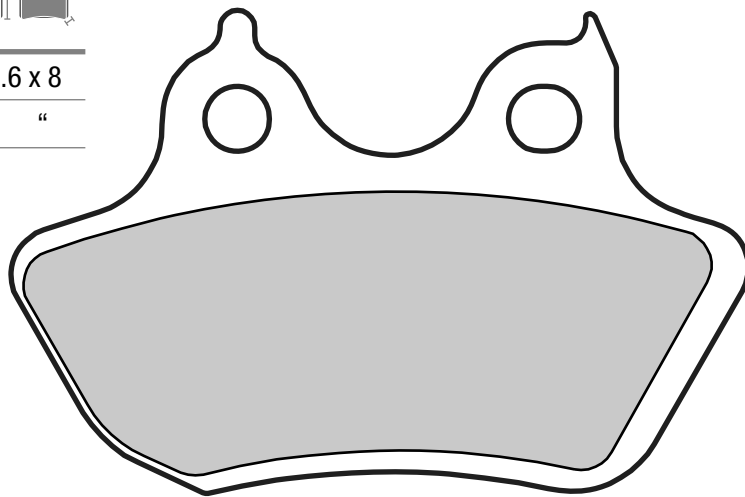

HARLEY DAVIDSON

1450	FLSTI HERITAGE SOFTAIL	06 >	•
	FXDI 35TH		
1450	ANNIVERSARY SUPER GLIDE	06 >	•

1450	FXST SOFTAIL STANDARD	06 >	•
1450	FXSTB/I NIGHT TRAIN	06 >	•
1450	FXSTD/I SOFTAIL DUECE	06 >	•
1450	FXSTS/I SOFTAIL	06 > 06	•
1584	FLSTSC/I SOFTAIL	07 > 07	•
1584	FXSTD SOFTAIL DEUCE	07 > 07	•





07HD19.SA 61 x 46.5 x 7.3

07HD19.SC “ “ “

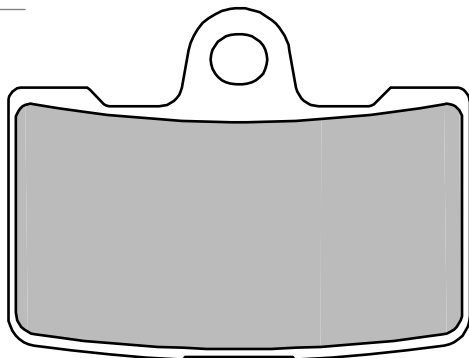

BUELL

1125 CR	09 >	•
1125 R	08 >	•
1200 XB12 R FIREBOLT	09 >	•
1200 XB12 S LIGHTNING	09 >	•
1200 XB12 SCG LIGHTNING	09 >	•

EBR

1190 RX	12 >	•
1190 SX	14 >	•



07HD20.SA 74.5 x 55.2 x 9.2

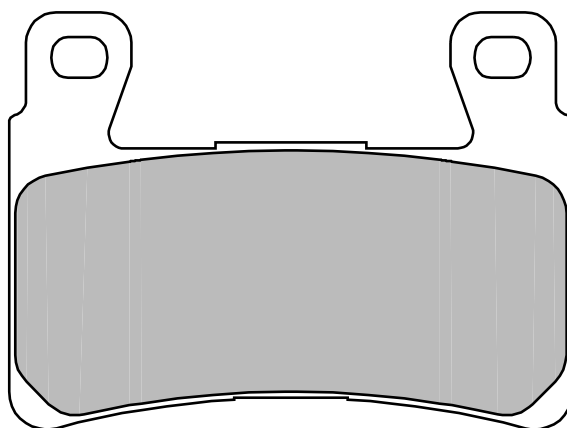

HARLEY DAVIDSON

1200 XR	08 >	•
1200 XR 1200 X	10 >	•
1690 FLSTC HERITAGE SOFTAIL CLASSIC	16 >	•
1750 FLDE SOFTAIL DELUXE	18 >	•
1750 FLFB FAT BOY	18 >	•

1750 FLHC HERITAGE CLASSIC	18 >	•
1750 FLSL SOFTAIL SLIM	18 >	•
1750 FXBB STREET BOB	18 >	•
1750 FXBR BREAKOUT	18 >	•
1750 FXFB FAT BOB	18 >	•
1750 FXLR LOW RIDER	18 >	•
1801 FLSS SOFTAIL SLIM S	16 >	•

1801 FLSTFBS FAT BOY S	16 >	•
1870 FLFBS FAT BOY	18 >	•
1870 FLHCS HERITAGE CLASSIC	18 >	•
1870 FXBRS BREAKOUT	18 >	•

HONDA

125 CB 125 R	18 >	•
--------------	------	---



07HD21.CC

94 x 36 x 9

07HD21.SA

“ “ “

07HD21.SP

“ “ “

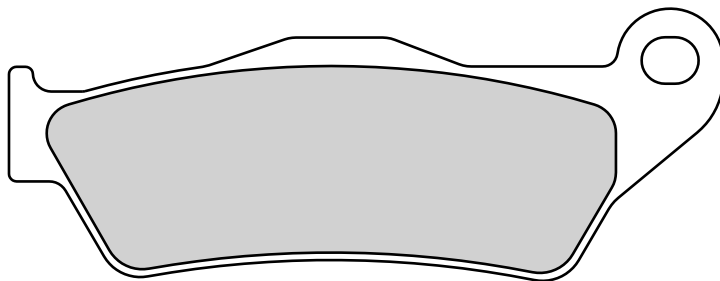
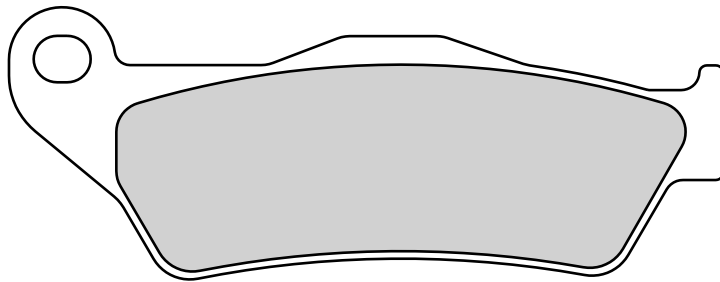

HARLEY DAVIDSON

500 STREET	14 >	• •
750 STREET	14 >	• •





07HD22.CC

118 x 48.5 x 9.2

07HD22.SA

“ “ “

2

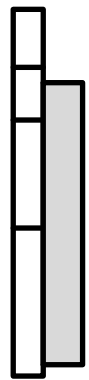
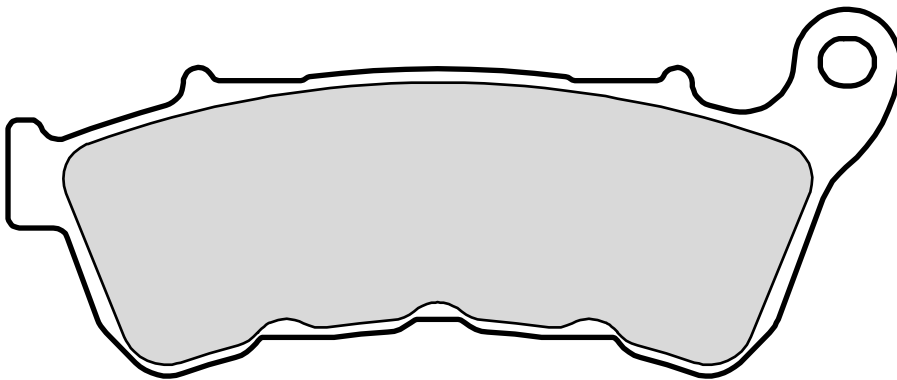
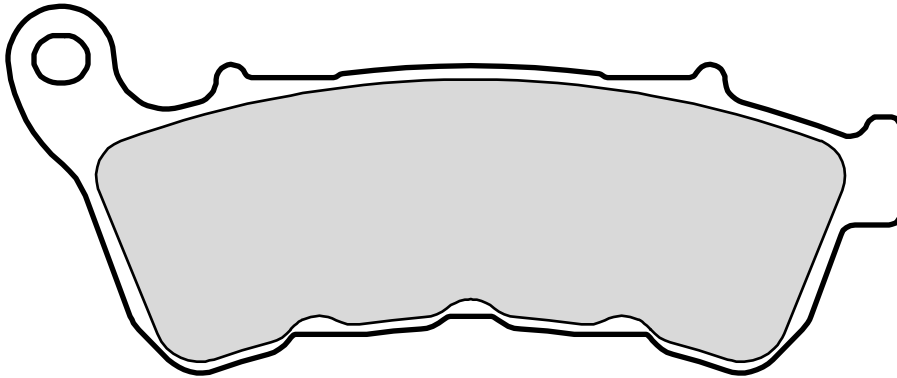

HARLEY DAVIDSON

883	XL 883 R ROADSTER	14 >	•
883	XL L SUPER LOW	14 >	•
883	XL N IRON	14 >	•
883	XL N IRON DARK CUSTOM	16 >	•

883	XL R ROADSTER	14 >	•
1200	XL C SPORTSTER CUSTOM	14 >	•
1200	XL CA SPORTSTER CUSTOM	14 >	•
1200	XL CB SPORTSTER CUSTOM	14 >	•

1200	XL CP SPORTSTER CUSTOM	14 >	•
1200	XL CX	17 >	•
1200	XL ROADSTER	18 >	•
1200	XL T SUPER LOW	15 >	•
1200	XL V SEVENTY-TWO	14 >	•
1200	XL X FORTY EIGHT	14 >	•



07HD23.CC 81.9 x 42.1 x 9.9

07HD23.SP “ “ “

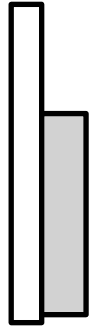
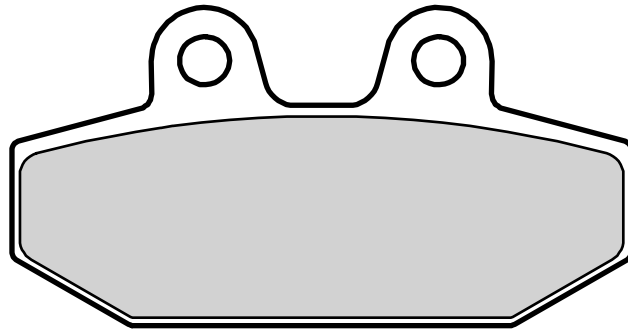

2



HARLEY DAVIDSON

1750 FLDE SOFTAIL DELUXE	18 >	•
1750 FLFB FAT BOY	18 >	•
1750 FLHC HERITAGE CLASSIC	18 >	•

1750 FLSL SOFTAIL SLIM	18 >	•
1750 FXBB STREET BOB	18 >	•
1750 FXBR BREAKOUT	18 >	•
1750 FXFB FAT BOB	18 >	•
1750 FXLR LOW RIDER	18 >	•

1870 FLFBS FAT BOY	18 >	•
1870 FLHCS HERITAGE CLASSIC	18 >	•
1870 FXBRS BREAKOUT	18 >	•





07H001.30

51.6 x 51.6 x 19.5
52 x 52 x 13.7

2

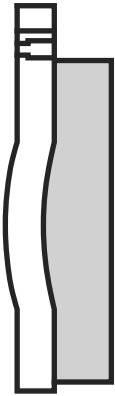
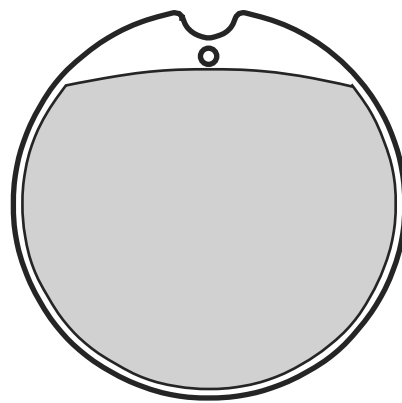
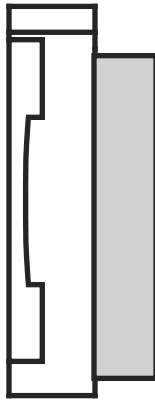
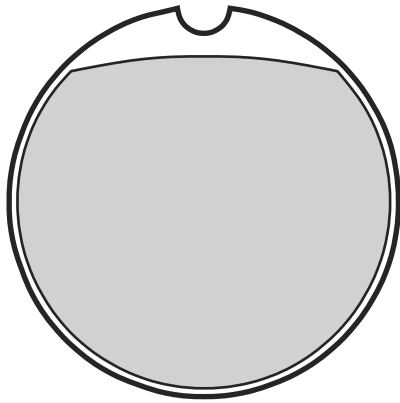

HONDA

250 CB	71 > 87 •	360 CB G, T	73 > 76 •	500 CB K1, K2, K3	72 > 77 •
250 CB G,T	74 > 76 •	360 CJ T	76 > 78 •	500 CB T, T1	75 > 78 •
250 CJ T	76 > 78 •	360 CL K1	74 > •	550 CB F1, F2	75 > 79 •
350 CB F, F1	73 > 76 •	400 CB F, F1, F2	75 > 79 •	550 CB K2, K3	74 > 78 •
		450 CB K5, K6, K7	72 > 77 •	750 CB A, K	76 > 77 •
		500 CB F	72 > 75 •	750 CB F1	75 > 77 •



07H002.29

49.9 x 49.9 x 20
49.9 x 49.9 x 13.5

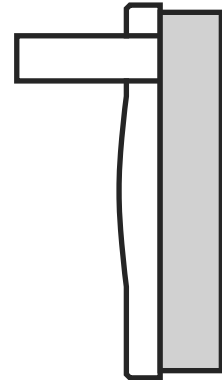
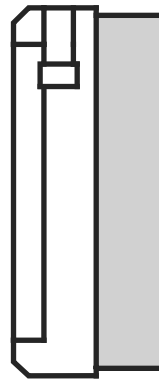
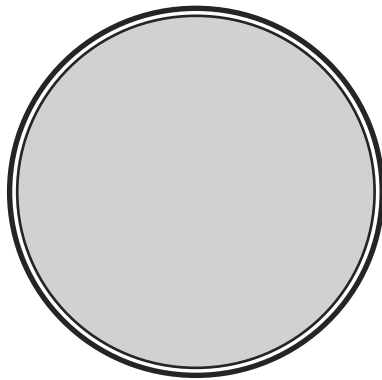

HONDA

450 CB K3, K4	71 > 72 •
750 CB K	70 > 76 •



07H003.07 66.9 x 49.1 x 9.5

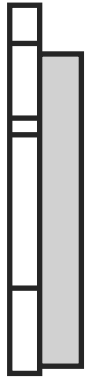
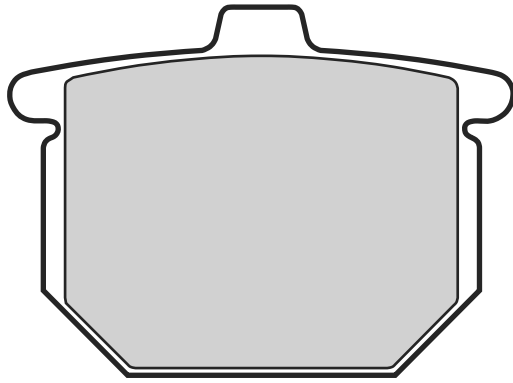

2



HONDA

125 MT R	78 >	•
400 CB	78 > 82	•
400 CB NA, NB	78 >	•
400 CB NZ	79 >	•

400 CX	81 >	•
400 GL	77 > 80	•
500 CX	78 > 80	•
750 CB F	77 > 80	• •
750 CB F2, SS	77 > 79	•
900 CB F	78 > 80	• •

1000 CBX	78 > 80	• •
1000 GL GOLDWING, GRANTOUR	81 >	• •
1000 GL K3	78 > 79	•
1100 GL	79 > 80	• •



07H004.11 57.7 x 65.3 x 10.5

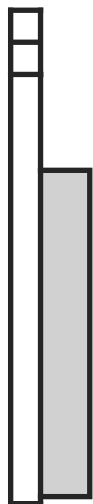
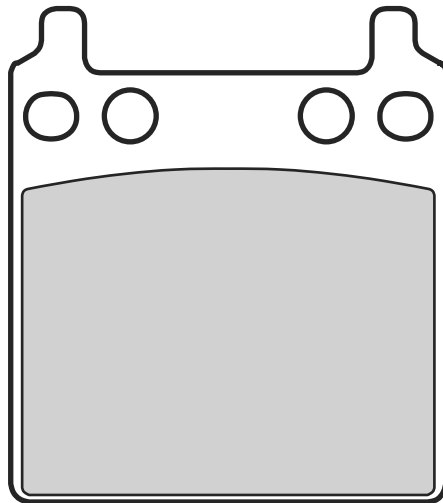

HONDA

750 CB F1	75 > 77	•
1000 GL K1, K2	75 > 77	•
1000 GL K3	78 > 79	•



**07H006.31**

39.3 x 39.3 x 21

39.3 x 39.3 x 11

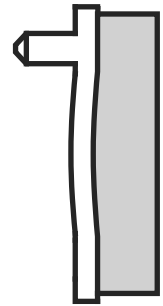
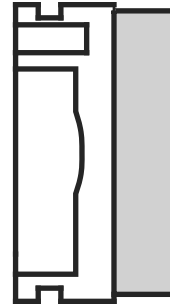
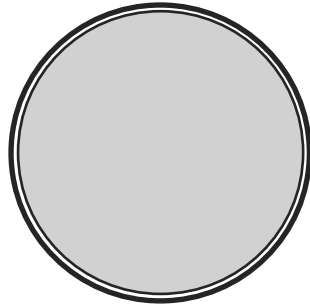
**HONDA**

50	CB K1, J	75 >	•
50	SS ZB2	75 >	•
90	9CB	79 >	•
110	CB	77 >	•
125	125 4 T	75 >	•
125	CB	77 >	•
125	CB J	79 >	•
125	MT R	77 > 77	•

**07H007.12**

52.5 x 52.9 x 11

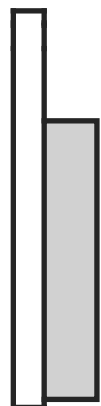
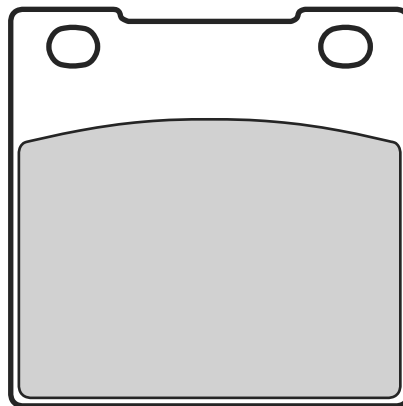
**HONDA**

250	CB N	78 >	•
250	CB ND	83 >	•
250	CB PSA, RSA, RDS	80 >	•
250	CB RS	80 > 85	•
250	CB RSC, RZC	82 >	•
250	CB T, TZ, NA, NB	77 >	•

250	CM TB	81 >	•
400	CB A, T1, T2	77 > 81	•
400	CB N, T, HAWH	78 >	•
400	CM A, T, TZ	79 >	•
400	CM T	79 > 84	•
400	CM T, CUSTOM	81 >	•
650	CB	80 > 84	•

650	CB Z	78 > 81	•
750	CB C, PZ, K, L	80 > 81	•
750	CB CUSTOM	81 >	•

KAWASAKI

250	CB RS	80 > 84	•
400	CM T	79 > 81	•



07H008.31

39.3 x 39.3 x 21

39.3 x 39.3 x 11

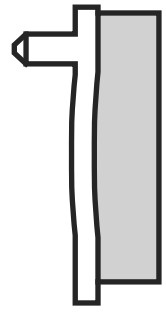
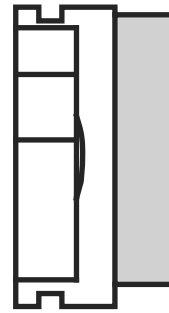
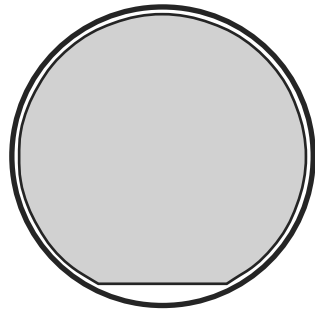

2



HONDA

100 CB N	79 >	•
125 CB T	85 >	•
125 CB T, T1, T2, TZ	77 >	•
250 FL ODYSSEY	84 >	•





07H009.06	41.1 x 45 x 8
------------------	---------------

07H009.SD	“ “ “
------------------	-------

07H009.SX	“ “ “
------------------	-------

07H009.TT	“ “ “
------------------	-------

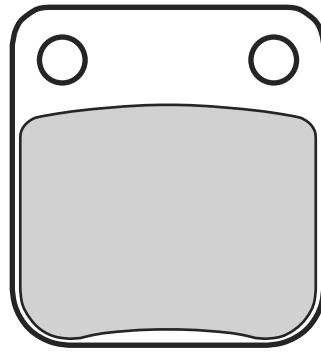
**DAELIM**

125 S2	05 >	•
250 S2	06 >	•

HONDA

50 CB (ALL MODELS)	80 > 81	•
50 CRM	89 > 92	•
50 MB	82 > 88	•
50 MBX	80 > 82	•
50 MRX	88 >	•
80 CB	80 > 81	•
80 CR R	86 > 91	•
80 CR R	92 > 97	•
80 MBX FWD	83 >	•
125 CB RS	83 >	•
125 CG	04 >	•
150 CG	04 >	•
250 ATC R	81 >	•

HUSQVARNA

125 CR	92 > 94	•
125 WR	92 > 94	•
250 CR	92 > 94	•
250 WR	92 > 94	•
350 TE	92 > 94	•

HYOSUNG

400 TE	05 >	•
450 TE	07 >	•

KAWASAKI

125 BN ELIMINATOR A1, A2	98 > 99	•
--------------------------	---------	---

125 KLX	10 >	•
125 KLX D-TRACKER	10 >	•
125 Z PRO	17 >	•
150 KLX D-TRACKER	16 >	•
150 KLX L	14 >	•
300 KVF BRUTE FORCE	13 >	•
400 KFX	02 >	•
400 KVF A1, A2, B1 PRAIRIE	97 > 98	•
400 KVF C1, C2 PRAIRIE 4X4	99 >	•
400 KVF D1, D2 PRAIRIE 2X4	99 >	•

PEUGEOT

125 SUM-UP	11 >	•
------------	------	---

SUZUKI

65 RM	03 >	•
125 123 DR SF	85 >	•
125 DR	91 > 02	•
125 GX R	88 >	•
125 RH X	87 >	•
125 SP	85 > 88	•
125 TS X	85 >	•
200 DR	90 >	•
200 DR S	15 >	•
200 SP GHJ	88 >	•
240 RH X	87 >	•
240 TS X	85 >	•
250 DR S, F	85 > 89	•
250 LT-Z QUAD SPORT	04 >	•
250 OZARK	03 >	•
250 RH	85 >	•
250 SP F	85 >	•
250 TS X	85 >	•

400 LT-A EIGER 2WD/4WD	02 >	•
400 LT-F EIGER 2WD/4WD	02 >	•
400 LT-Z QUAD SPORT	02 >	•
500 LT-A VINSON	02 >	•

YAMAHA

125 SX R	88 >	•
200 YFS R BLASTER	03 >	•
250 YFM AN BRUIN 2X4	05 >	•
250 YFM BEAR TRACKER	01 >	•
300 YFM WARRIOR	89 >	•
350 YFM BRUIN 2X4, 4X4	04 >	•
350 YFM FWB L, LC BIG BEAR (4WU/EBE)	99 >	•
350 YFM FXG-FXM WOLVERINE (4KB/EBE)	95 > 96	•
350 YFM XG, XH WARRIOR (3GD/EBE)	95 > 96	•
350 YFM XW, XA-M WARRIOR	89 >	• •
350 YFZ A-M BANSHEE	90 > 06	•
400 YFM FAM KODIAK	00 >	•
400 YFM FWN BIG BEAR 4WD	00 >	•
400 YFM FWNH BIG BEAR-BUCKMASTER 4WD	00 >	•
400 YFM N BIG BEAR 2WD	00 >	•
450 YFM FA_ KODIAK	03 >	•
450 YFM KODIAK	03 >	•
450 YFM WOLVERINE	06 >	•



07H010.10 89.9 x 49 x 11

07H010.SA “ “ “

07H010.LA “ “ “

07H010.SP “ “ “

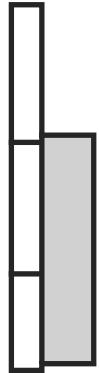
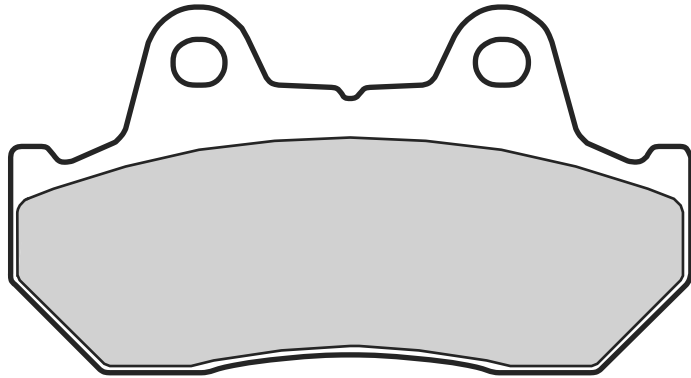

HONDA

125 CB TDC	83 >	•
250 GB CLUBMAN	88 >	•
250 NS R	85 >	•
250 NSR R	87 >	•
400 CB	81 >	• •
400 CB FOUR	81 >	•
400 CB HAWK	81 >	• •
400 CB N	82 > 85	•
400 CB TWIN	82 >	•
400 CBR F, F2	85 >	• •
400 CBR R	87 >	•
400 CM C	81 >	•
400 CM T	85 >	•
400 GB TT	88 >	•
400 NSR	85 > 86	•
400 XELVIS	92 >	• •
450 CB T	82 >	•
450 CBR SR	91 >	• •
450 CM A, C	82 >	•
450 CMX REBEL	86 >	•
500 CB EC	83 >	•
500 CX	81 >	•
500 CX C	81 >	• •
500 CX E	85 >	• •
500 CX EURO	82 >	•
500 CX SILVER WING TURBO	81 > 83	• •
500 CX TURBO	81 > 83	•
500 FT	82 > 83	• •
500 GB TT	88 >	•

500 GL	81 > 82	•
500 GL D	81 >	•
500 NS R	85 >	• •
500 VF 2	83 >	•
500 VT C	83 > 86	•
500 XBR S	85 >	•
550 CB SC	83 >	•
550 CBX	82 >	• •
600 CBR F	87 > 90	•
600 CBX E	85 >	•
600 XL LM	85 > 87	•
600 XL V TRANSALP	87 > 90	•
650 CB	85 >	•
650 CB SC	83 >	•
650 CBX ED, SC, SCD	83 >	•
650 CX C, T, TD, TURBO	83 >	• •
650 CX E	83 >	•
650 GL D	83 >	•
700 CB SC	84 >	•
700 VF F INTERCEPTOR	84 > 85	•
700 VF S	84 >	•
700 VFC MAGNA	84 >	•
700 VFC MAGNA	87 >	•
700 VFR F, F2	86 > 87	•
700 VT C, SHADOW	87 >	•
750 CB F, F2, K	85 >	•
750 CB F, K	81 > 82	• •
750 CB SC, KZ, C	82 > 83	•
750 CBR HURRICANE	87 >	•
750 CBX F	84 >	• •
750 NV CG, SHADOW	86 >	•

750 VF C	88 > 93	•
750 VF CUSTOM, SPORT	82 > 83	•
750 VF F	83 >	• •
750 VF S	85 >	•
750 VFR FJ, F	86 > 87	•
750 VP CH, CUSTOM	87 >	•
750 VT C, SHADOW	86 > 96	•
750 XLV R	83 > 85	•
800 VT C	88 >	•
900 CB C	82 >	• •
900 CB F, F2 BOL D'OR	81 > 84	• •
1000 CB C	83 > 83	• •
1000 CBR F	87 > 88	•
1000 CBX	81 > 82	•
1000 VF F	84 >	• •
1000 VF F2 BOL D'OR, F, F2	85 >	• •
1000 VF R	84 > 85	•
1000 VF R	86 > 88	• •
1000 VT C	88 >	•
1100 CB F	83 > 85	• •
1100 CB R, RB, RC	81 > 84	• •
1100 CB RD	83 >	• •
1100 GL	81 > 83	• •
1100 VF C, S	83 >	•
1100 VT SHADOW	87 > 93	•
1200 GL A, I	84 >	• •
1200 GL DX	86 >	• •
1200 GL GOLDWING	84 >	• •
1500 GL ASPENCADE	94 > 97	•
1500 GL GOLDWING SE	88 > 00	•
1500 GLX	88 > 96	•



**07H011.18**

84.9 x 42.4 x 7.8

47.4 x 37 x 10

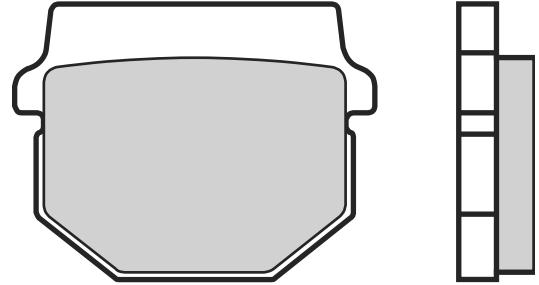
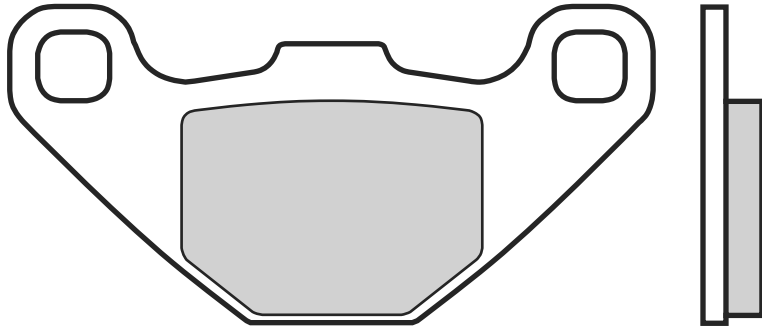
**HM**

50	CRE	98 > 05	•
50	CRE BAJA	97 >	• •

KAWASAKI

80	KMX	87 >	•
125	KMX	87 > 90	•

HONDA

80	MB	80 >	•
80	MCX	82 >	•

SUZUKI

80	RM G	86 > 89	•
80	RM L, M, N	90 > 95	•

**07H012.12**

66.9 x 49.1 x 12

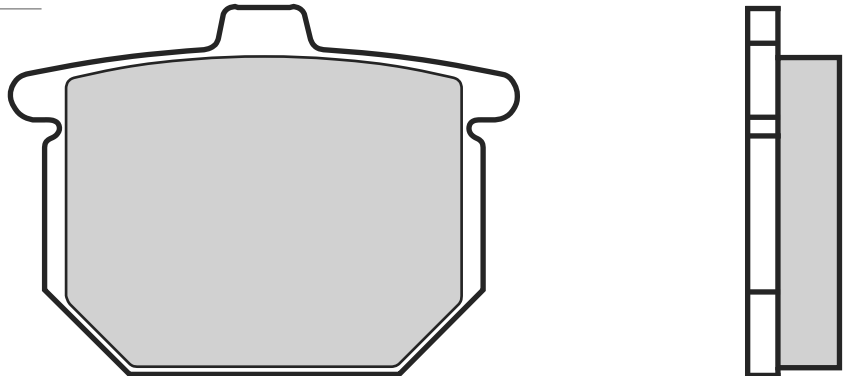
**HONDA**

750	CB F2, SS	77 > 79	•
1000	GL K1, K2	75 > 77	•



07H013.CC 99.3 x 37.8 x 9.2

07H013.SP “ “ “

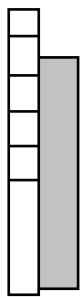
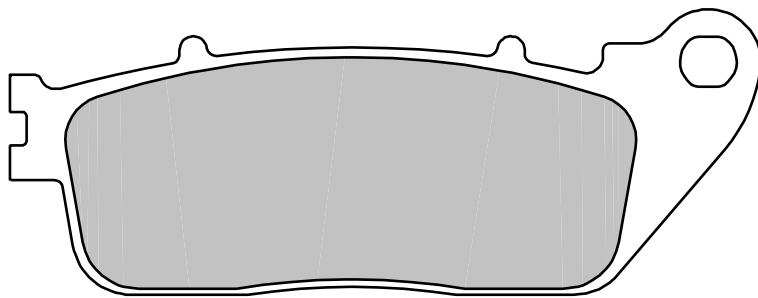
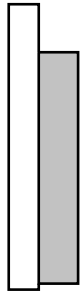
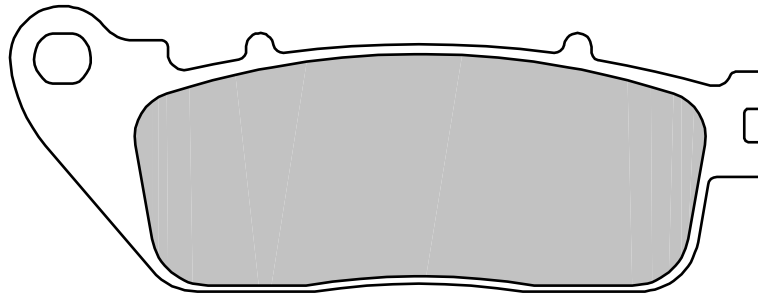

2



HONDA

800 CROSSRUNNER	11 >	•
800 CROSSRUNNER	15 >	•
800 VFR F	14 >	•
1000 CB R	08 >	•
1000 CB R ABS	08 > 08	•
1000 CB R ABS	09 > 14	•
1000 CB R+	18 >	•
1000 L ADVENTURE SPORTS	18 >	•





07H014.06

91.7 x 53.2 x 8

2

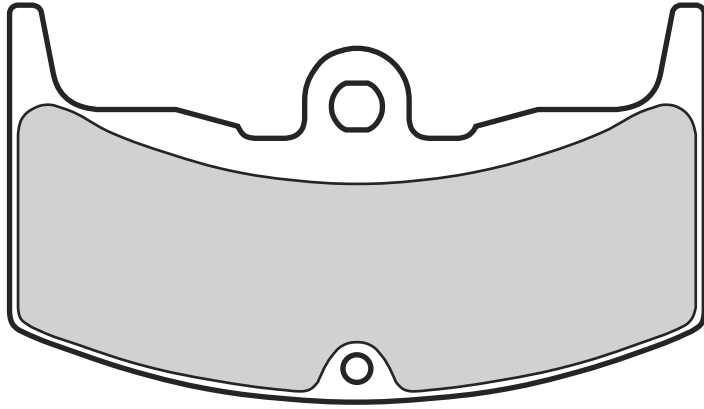

HONDA

250 VT E, FD	83 >	•
250 VT F	83 > 87	•
250 VTR	88 > 89	•
400 CBX F, F2, F2C	82 >	•
400 VF F	85 >	•
400 VF FD	83 >	•
400 VT E	83 >	•
400 VT FD	83 >	•
500 VT E	83 >	•
500 VT ED	82 >	• •
550 CBX F, F2, FC, F2C	82 >	•
650 CBX E	83 >	• •
900 CB FC, F2C	82 >	•



07H015.05	80.9 x 41.7 x 7.3
------------------	-------------------

07H015.SD	“ “ “
------------------	-------

07H015.SX	“ “ “
------------------	-------

07H015.TT	“ “ “
------------------	-------

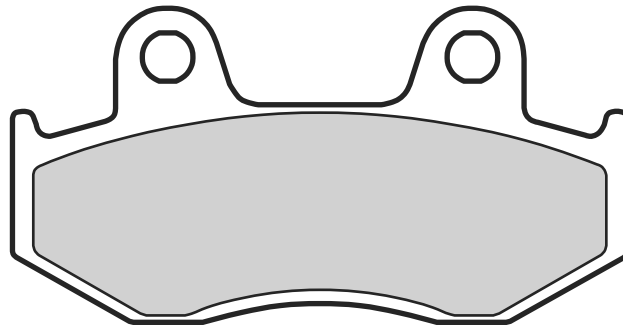

BENELLI

125 TNT	17 >	•
---------	------	---

HONDA

80 MBX	86 >	•
80 MTX R	87 >	•
125 CR R	84 > 86	•
125 MTX	90 >	•
125 MTX R	84 > 85	•
125 XL R	86 >	•
200 ATC R	85 >	• •

200 MTX R	86 >	•
250 ATC R	85 > 86	• •
250 ATC X	85 >	•
250 CB RS	86 >	•
250 CR R	84 > 86	•
250 FTR	86 >	• •
250 TRX R	86 > 89	•
250 TRX X FOURTRAX	87 >	•
250 XL R	84 > 87	•
250 XLR R	88 >	•
250 XR RE	84 > 87	•

350 ATC X	85 > 85	•
350 XL R	84 > 86	•
350 XL R ND 03	84 >	•
350 XR R	84 > 85	•
500 CR R	84 > 86	•
500 XL R	83 > 84	•
500 XR R	83 > 86	•
600 XL R	83 >	•
600 XL R, RD, LD	83 >	•
600 XLM LM	87 >	•
600 XR R	83 > 87	•





07H016.09 89.9 x 51.1 x 9.9

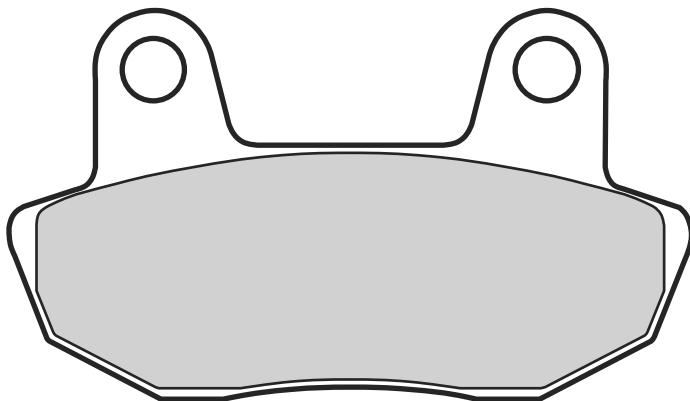

HONDA

450	CB N	84 > 85	•
450	CB SC NIGHTHAWK	82 > 82	•
650	CB SCC NIGHTHAWK	82 >	•
700	VT C, SHADOW	84 > 86	•
750	VT C	83 > 85	•



07H017.08 91.7 x 53.2 x 9.5

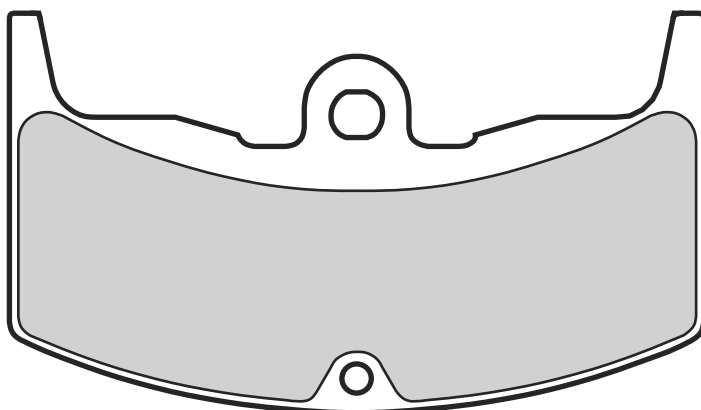

HONDA

400	CBX CUSTOM	88 >	•
400	CBX F	85 >	• •
400	CBX F, F2, F2C	82 >	•
400	NV CUSTOM	88 >	•
400	VF F	85 >	•
400	VF FD	83 >	•

400	VT E	83 >	•
400	VT FD	83 >	•
550	CBX F, F2, FC, F2C	82 >	•
900	CB FC, F2C	82 >	•



07H018.07 89.9 x 49 x 9

07H018.SP “ “ “

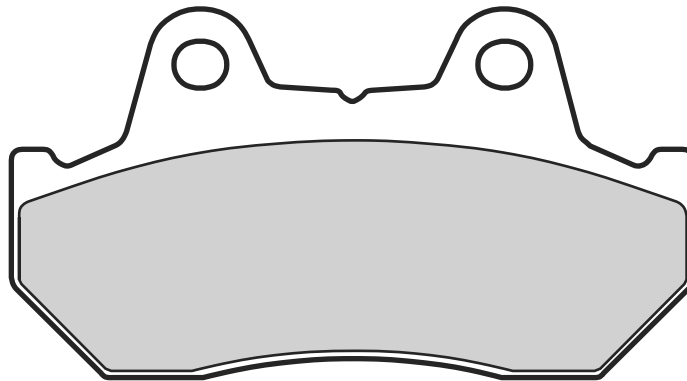

HONDA

125 CB T, SUPERDREAM	82 >	•
125 CBX F	88 >	•
250 CBX RSE	84 >	•
250 CBX S	88 >	•
250 NS R	85 >	•

400 NSR	85 >	86 •
400 VF INTEGRA	86 >	• •
450 CB SC NIGHTHAWK	83 >	86 •
500 CB EC	83 >	•
500 CX EURO	82 >	•
500 CX TURBO	81 >	83 •
500 GL	81 >	82 •

500 VF 2	83 >	•
650 CX E	83 >	•
700 VF F INTERCEPTOR	84 >	85 •
700 VFC MAGNA	85 >	86 •
750 XLV R	86 >	•
1000 CBX	81 >	82 •
1100 VF C, S	83 >	•



07H020.SD 45.9 x 45 x 6.5

07H020.SX “ “ “

07H020.TT “ “ “

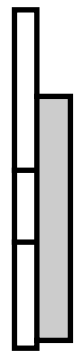
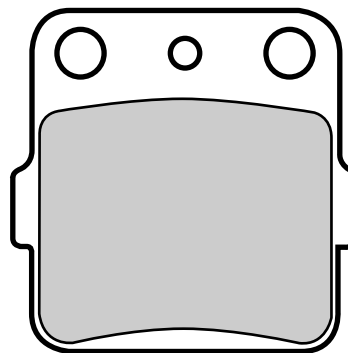

HM

150 CRF R	07 >	09 •
-----------	------	------

HONDA

200 ATC X	83 >	85 •
-----------	------	------

200 ATC XD	83 >	•
250 ATC R	82 >	84 •
250 ATC X	85 >	•
350 ATC X	85 >	85 •
350 ATC X	86 >	•

SUZUKI

230 LT SG	86 >	•
-----------	------	---

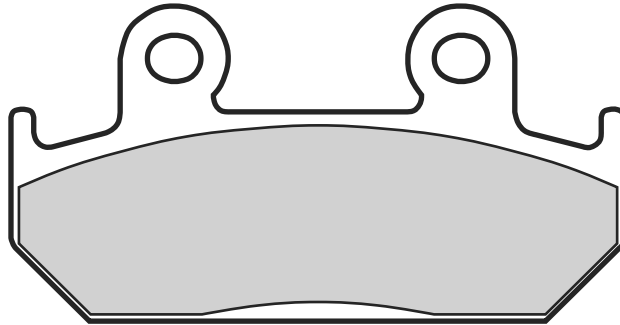

**07H021.07** 81.1 x 42.1 x 8.9**07H021.SA** “ “ “**07H021.SC** “ “ “**HONDA**

250 CBR F	86 > •	250 VTZ	88 > •	400 VFR Z	88 > •
250 CBR HURRICANE	87 > •	350 CB S G	87 > •	450 CB S	86 > •
250 NSR R	87 > •	350 NX	92 > •	600 CBR F	87 > 90 •
250 VT F	88 > •	400 CB N	86 > •	600 CBR F, SUPER SPORT	91 > 94 •
250 VTR	90 > 97 •	400 CBR F	92 > •	600 NTV REVERE	88 > 01 •
		400 CBR R	87 > •	600 VT SHADOW CUSTOM	89 > 91 •
		400 VFR R	86 > 88 • •	750 XRV AFRICA TWIN	90 > 92 •

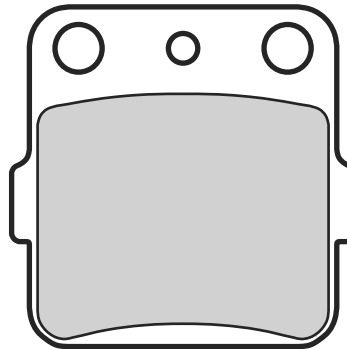
**07H022.05** 45.9 x 45 x 6.5**07H022.SD** “ “ “**07H022.SX** “ “ “**07H022.TT** “ “ “**HONDA**

75 CRM	92 > •	SUZUKI	125 RM H	87 > 88 •	YAMAHA	125 YZ	89 > 89 •
80 CR	03 > •	230 LT EH, S	230 LT EH, S	86 > 93 •	250 YZ	89 > 89 •	
80 CR R, RB	96 > 02 •	230 LT SF-SJ	230 LT SF-SJ	85 > 88 •	300 YFM WARRIOR	89 > •	
80 CRM	89 > •	250 LT RF-RH	250 LT RF-RH	85 > 87 •	350 YFM XT	87 > 88 •	
200 ATC XD	83 > •	250 RM H	250 RM H	87 > 88 •	360 YZ	89 > •	
250 ATC R	82 > 84 •						



07H023.07 88.2 x 46.1 x 8.4

07H023.SA “ “ “

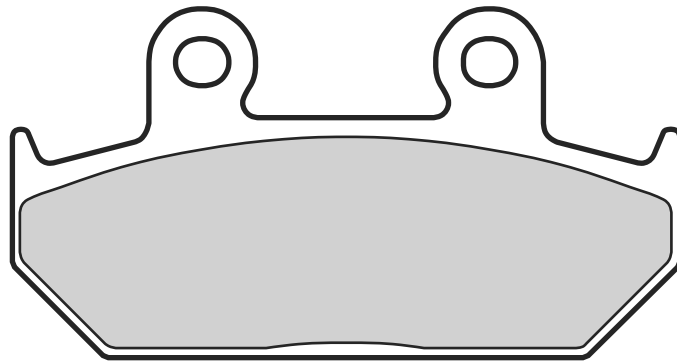

HONDA

125 RS (GP)	88 > 90 •
250 CB	88 > 91 •
250 CD	88 > •

400 STEED	88 > 91 •
600 NV C	88 > •
600 NX DOMINATOR	93 > •
600 STEED	88 > 91 •
650 NX DOMINATOR	93 > 96 •

700 VFR F, F2	86 > 87 •
750 CBR HURRICANE	87 > •
750 VFR FJ, F	86 > 87 •
1000 CBR F	87 > 88 •



07H024.08 54.9 x 52.4 x 9.4

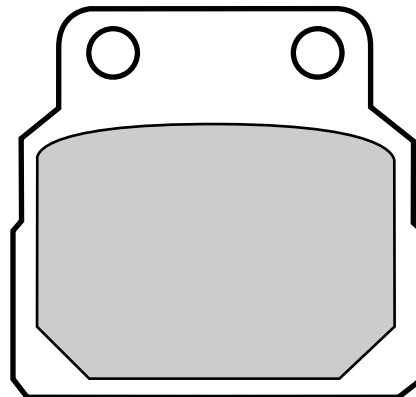

HONDA

450 CB DX	89 > • •
450 CB N	86 > •





07H025.06	94 x 31.9 x 7.4
07H025.SD	“ “ “
07H025.SX	“ “ “
07H025.TT	“ “ “

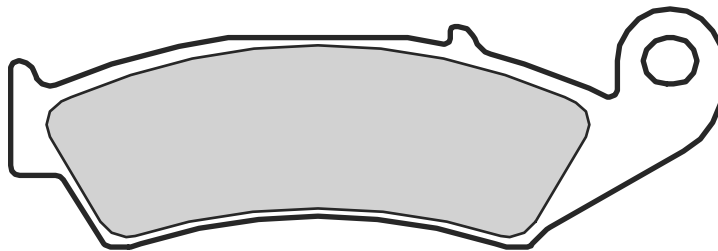
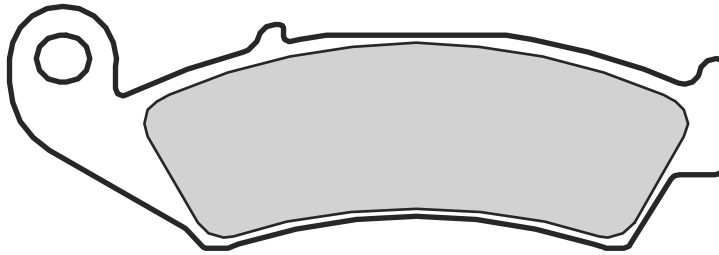

HONDA

125 CR R, RK	87 > 94 •
250 AX-1	88 > 89 •
250 AX-1	90 > •
250 CR R	87 > 94 •
250 CRM	90 > •

250 NX	88 > 90 •
250 TRX R	86 > 89 •
250 TRX X FOURTRAX	87 > •
250 XL DEGREE	91 > •
250 XLR BAJA	88 > 90 •
250 XR R	88 > 89 •
250 XR R, L	90 > 93 •

350 ATC X	86 > •
500 CR	87 > 94 •
600 XR R	88 > 90 •
600 XR R	91 > 92 •
600 XR R DAKAR	89 > 90 •
600 XR R DAKAR	91 > 92 •



07H026.08 74.9 x 36.1 x 9.5

07H026.SD “ “ “

07H026.SX “ “ “

07H026.TT “ “ “

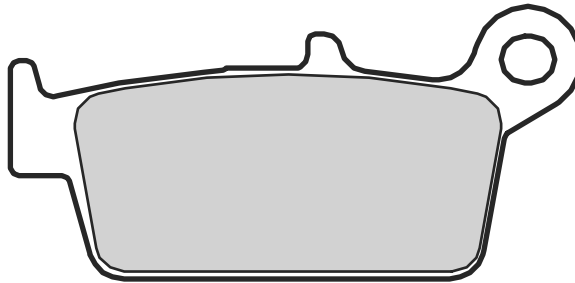
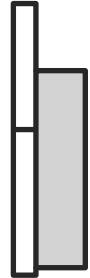
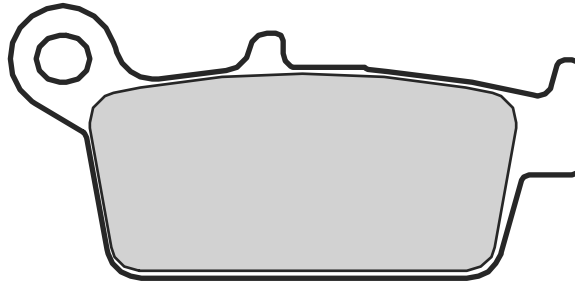

AJP

650 ADVENTURE 17 > •

BIMOTA

508 BBX ENDURO 12 > •

FANTIC MOTOR

50 MX REGOLARITÀ
COMPETIZIONE 08 > •

65 MX REGOLARITÀ
COMPETIZIONE 08 > •

85 MX REGOLARITÀ
COMPETIZIONE 08 > •

GAS GAS

125 EC 00 > •

125 MC 03 > •

125 SM 02 > •

200 EC 00 > 16 •

200 HOBBY 07 > •

250 EC 00 > 11 •

250 MC 00 > •

250 SM 02 > •

300 EC 00 > 11 •

400 EC 02 > •

400 FSE SM 02 > •

400 PAMPERA 06 > •

450 EC 03 > •

450 FSE EC 03 > •

450 FSE SM 03 > 06 •

450 FSR 07 > •

450 SM FSR 07 > •

500 FSE EC 06 > •

515 FSR 08 > •

HM

50 CRE 06 > •

125 CRE ENDURO 95 > 01 •

125 CRE SUPERMOTARD 03 > •

125 SUPERMOTARD 00 > •

250 CRE ENDURO 95 > 01 •

250 CRE SUPERMOTARD 03 > 03 •

250 CRE SUPERMOTARD 04 > •

250 SUPERMOTARD 00 > •

HONDA

50 CB REPLICA 99 > •

80 MB 80 > •

80 MCX 82 > •

80 MCX S 82 > •

80 MTX R 87 > •

125 CA REBEL 95 > 96 •

125 CR R, RK 87 > 94 •

125 CR RK 95 > 01 •

230 CRF 04 > •

230 SL 97 > •

250 AX-1 88 > 89 •

250 CR R 87 > 94 •

250 CR R 95 > 01 •

250 XLR BAJA 88 > 90 •

250 XLR R, SPL 94 > •

250 XR R, L 90 > 93 •

250 XR R, L, S 94 > •

300 XR 10 > •

400 XR 96 > •

400 XR SUPERMOTARD 00 > •

440 XR R 00 > •

500 CR 87 > 94 •

500 CR 95 > 01 •

600 XR R 91 > 92 •

600 XR R 93 > •

600 XR R DAKAR 91 > 92 •

600 XR R DAKAR 93 > •





650 BROS	88 >	•
650 NTV HAWK	89 > 91	•
650 XR L	93 >	•
650 XR R	00 >	•

HYOSUNG

400 XRV	05 >	•
---------	------	---

KAWASAKI

125 KX	95 >	•
250 KLX	98 >	•
250 KLX 250	09 >	•
250 KLX S, SF	09 >	•
250 KX	95 >	•
300 KLX	97 >	•
400 KLX R/SR	03 >	•
500 KX	96 > 03	•
650 KLX R	96 > 98	•

SHERCO

450 ENDURO	04 > 04	•
------------	---------	---

SUZUKI

125 RM T	96 > 05	•
250 DR Z	01 >	•
250 RM T	96 > 05	•
250 RMX	99 >	•
400 DRZ E	00 > 04	•
400 DRZ S	00 > 04	•
400 DRZ SM	05 >	•

TM

85 85	01 > 12	•
125 125	01 > 04	•
125 ENDURO	01 > 04	•
125 SMR	05 >	•
125 SMX	06 >	•
250 250	01 > 04	•
250 250 4-STROKE	01 >	•
250 E	01 >	•
250 E 4-STROKE	01 > 04	•
300 300	01 >	•
300 E	01 > 04	•
400 4T	01 >	•
400 E 4 STROKE	01 >	•

400 SMR F	02 >	•
450 4T	02 > 04	•
450 ENDURO 4 STROKE	02 > 04	•
450 SMR F	04 >	•
450 SMX F	03 >	•
530 4T	01 > 04	•
530 E 4 STROKE	01 > 04	•
530 SMR F	03 >	•
530 SMR F ES	03 >	•
600 SMX F	03 >	•
660 SMX F	05 >	•

YAMAHA

125 WR	98 > 08	•
125 YZ	98 > 02	•
250 WR	98 > 02	•
250 WR F	01 > 02	•
250 YZ	98 > 02	•
250 YZ F	01 > 02	•
400 WR F	99 > 00	•
400 YZ F	99 > 02	•
426 WR F	01 > 02	•
426 YZ F	00 > 02	•



07H027.11 86.1 x 39.9 x 10.7

07H027.SP “ “ “

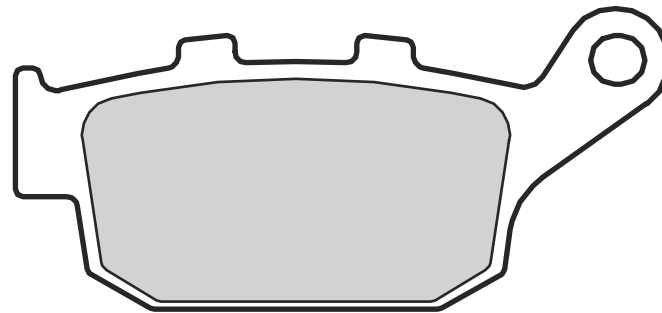
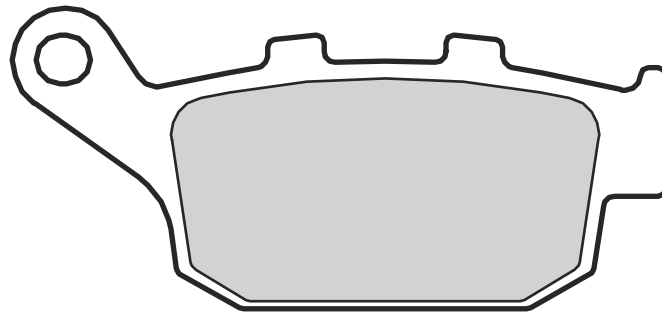

BUELL

500 BLAST	01 >	•
984 XB9R FIREBOLT	02 >	•
984 XB9S LIGHTNING	03 >	•
984 XB9SX CITY X	05 >	•
1200 M2	98 > 02	•
1200 M2 CYCLONE	98 > 02	•
1200 RS X1	98 >	•
1200 S1 LIGHTNING	98 > 02	•
1200 S1 WHITELIGH TWIN	98 > 02	•
1200 S3 THUNDERBOLT	98 > 02	•
1200 S3T THUNDERBOLT	98 > 02	•
1200 X1	01 > 02	•
1200 XB12 R	04 >	•
1200 XB12 R FIREBOLT	09 >	•
1200 XB12 S LIGHTNING	04 > 08	•
1200 XB12 S LIGHTNING	09 >	•
1200 XB12 SCG LIGHTNING	04 > 08	•
1200 XB12 SCG LIGHTNING	09 >	•
1200 XB12 STT SUPER TT	07 >	•
1200 XB12 X ULYSSES	06 >	•

HONDA

250 CBR HURRICANE	87 >	•
250 CBR R, RR	90 >	•
250 CBR RJ	88 >	•
250 NSR RJ, R, SP	88 >	•

250 RS R	91 > 92	•
250 VT SPADA	89 >	•
250 VTR	98 >	•
400 BROS 2	88 >	•
400 CB FK	90 >	•
400 CB SUPER FOUR	92 > 95	•
400 CB-1	89 > 90	•
400 CBR RR	88 > 94	•
400 VFR Z	88 >	•
400 VRX T ROADSTER	95 >	•
600 NTV BROS 1	88 > 01	•
600 NTV REVERE	88 > 01	•
600 NX DOMINATOR	93 >	•
600 XL V TRANSALP	91 > 93	•
600 XL V TRANSALP	94 > 96	•
600 XL V TRANSALP	97 > 99	•
600 XL V TRANSALP VR/VT	94 > 96	•
650 FMX	05 >	•
650 NTV	94 >	•
650 NTV DEAUVILLE	98 > 00	•
650 NTV REVERE	88 > 93	•
650 NTX BROS	90 >	•
650 NX DOMINATOR	88 > 92	•
650 NX DOMINATOR	93 > 96	•
650 XL V TRANSALP	00 >	•
650 XRV AFRICA TWIN	88 >	•
700 VF FR INTERCEPTOR	88 > 89	•
700 X	12 >	•

700 XL TRANSALP	08 >	•
750 CB NIGHTHAWK	91 >	•
750 XRV AFRICA TWIN	90 > 92	•
750 XRV AFRICA TWIN	93 > 02	•

PEUGEOT

250 SATELIS RS	11 >	•
----------------	------	---

SUZUKI

650 XF FREEWIND	97 >	•
-----------------	------	---

TRIUMPH

600 DAYTONA	04 >	•
600 SPEED FOUR	03 >	•
600 TT	00 > 03	•
650 DAYTONA	05 >	•
675 DAYTONA	06 > 08	•
675 DAYTONA R TRIPLE	11 > 12	•
675 DAYTONA TRIPLE	09 > 12	•
675 STREET TRIPLE	08 > 12	•
675 STREET TRIPLE R	09 > 15	•
800 TIGER	11 >	•
800 TIGER XC	11 > 17	•
800 TIGER XC ABS	12 >	•
800 TIGER XCA	15 > 17	•
800 TIGER XCA	18 >	•
800 TIGER XCR	15 >	•





800 TIGER XCX	18 >	•
800 TIGER XR	15 > 17	•
800 TIGER XRT	15 > 17	•
800 TIGER XRT	18 >	•
800 TIGER XRX	15 > 17	•
800 TIGER XRX	18 >	•
800 TIGER XRX LOW	18 >	•

1200 SPEEDMASTER	18 >	•
1200 TIGER XC	18 >	•
1200 TIGER XR	18 >	•
YAMAHA		
600 FZ 6R	09 >	•

600 XJ 6	09 >	•
600 XJ 6 N	09 > 12	•
600 XJ 6 S DIVERSION	09 > 12	•
600 XJ S F DIVERSION	10 > 11	•
600 XJ S FA DIVERSION ABS	11 > 11	•
600 XJ6 F	09 > 12	•

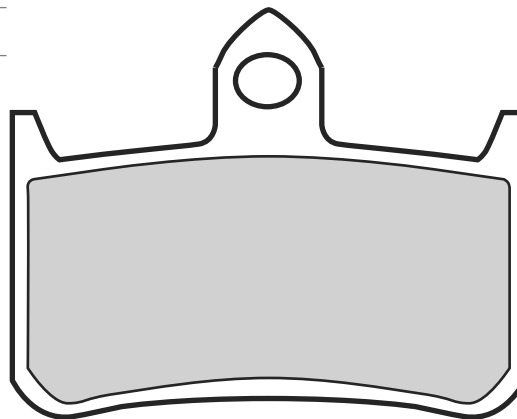

07H028.07	67.8 x 53.7 x 8.1
07H028.SA	“ “ “
07H028.LA	“ “ “
07H028.SC	“ “ “
07H028.RC	“ “ “

**HONDA**

125 NS	89 >	•	400 VFR R	89 > 92	•	750 VFR R (RC 30)	88 > 93	•
250 NS	89 >	•	400 VTR R	90 >	•	900 CBR RR	92 > 97	•
250 NSR RJ, R, SP	88 >	•	600 NTV BROS 1	88 > 01	•	900 HORNET	02 >	•
250 RS R	91 > 92	•	650 BROS	88 >	•	1000 CB BIG ONE	93 > 95	•
400 BROS 2	88 >	•	650 NTX BROS	90 >	•	1000 VTR F	97 >	•
400 RVF RR	90 >	•	750 NR	92 >	•	1000 VTR F FIRESTROM	97 > 07	•
			750 RVF (RC 45)	94 >	•	1300 CB X-4	97 >	•



07H029.11

94 x 31.9 x 8.4

07H029.SP

“ “ “

2

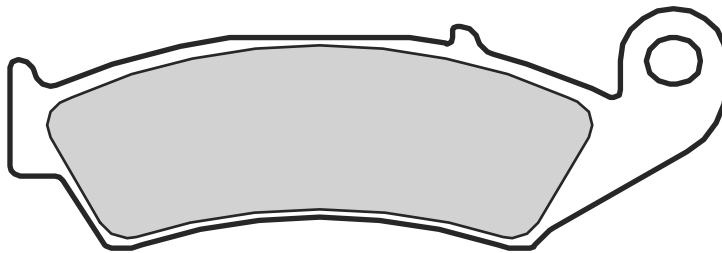
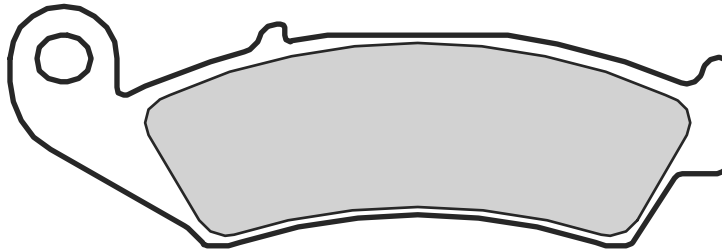

HONDA

400 RVF RR	90 >	•
400 VFR R	89 > 92	•
400 VTR R	90 >	•
750 RVF (RC 45)	94 >	•
750 VFR R (RC 30)	88 > 93	•





07H030.05 102.1 x 38.9 x 8.1

07H030.SA “ “ “

07H030.LA “ “ “

07H030.SC “ “ “

2

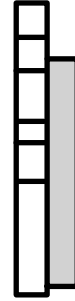
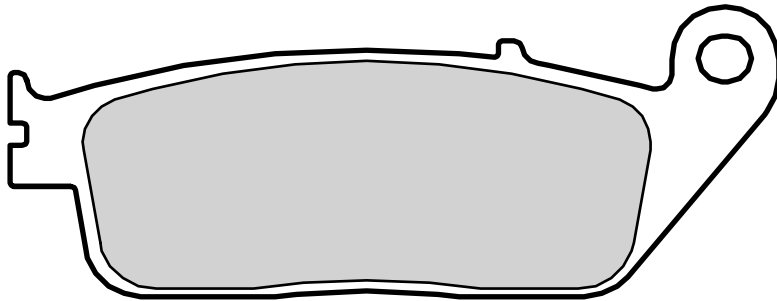
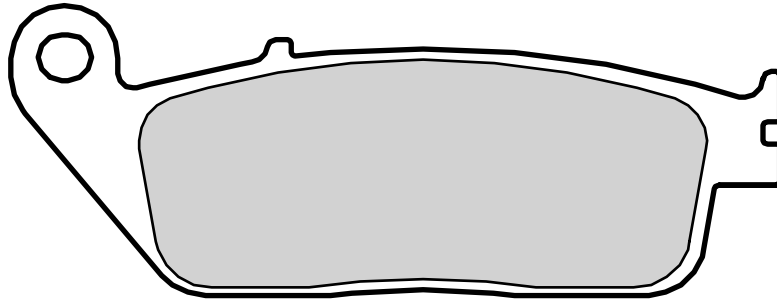

BUELL

500 BLAST 01 > •

CAGIVA

900 GRAN CANYON 99 > •

1000 NAVIGATOR 00 > •

HONDA

125 RS (GP) 91 > 94 •

125 XLR R 98 > •

125 XR L 03 > •

250 CB 92 > •

250 CBR NIGHTHAWK 92 > •

250 CBR R 11 > •

250 CBR R, RR 90 > •

250 CBR RJ 88 > •

250 STEED 93 > •

250 VT SPADA 89 > •

400 CB FK 90 > •

400 CB-1 89 > 90 •

400 CBR RR 88 > 94 •

400 STEED 92 > •

400 VRX T ROADSTER 95 > •

500 CB 94 > 96 •

600 CBF N 03 > 11 •

600 CBF S 04 > 09 •

600 CBR F 11 > •

600 CBR F SPORT 11 > 12 •

600 CBR F3 95 > 98 •

600 HORNET 98 > 06 •

600 HORNET 07 > •

600 HORNET / S 00 > 06 •

600 STEED 92 > •

600 VT C, SHADOW 93 > •

600 VT CD SHADOW VLX 94 > •

650 FMX 05 > •

650 NTV 94 > •

650 NTV HAWK 89 > 91 •

650 NTV REVERSE 88 > 93 •

700 VF FR INTERCEPTOR 88 > 89 •

700 X 12 > •

750 CB N, SEVEN FIFTY 92 > •

750 CB NIGHTHAWK 91 > •

750 VFR F 88 > 89 •

750 VFR F 90 > 97 •

800 PC 89 > 97 •

950 VFR F 92 > •

1000 CBR F, FJ, FK 89 > 92 •

1000 VF R 89 > •

1100 ST PAN EUROPEAN 90 > 02 •

1100 VT C2 Y 00 > •

1100 VT SHADOW 94 > 96 •

1100 VT SHADOW C2 95 > 98 •

1100 VT SHADOW C3 99 > 02 •

1300 VT FURY 10 > 16 •

1300 VTX 03 > •

1300 VTX C 04 > •

1500 GL C VALKIRIA 96 > •

1500 GLX 97 > •

HYOSUNG

250 AQUILA 00 > •



KAWASAKI

250	VERSYS-X	17 >	•
300	KLE VERSYS-X	17 > 18	•
650	NINJA	17 >	•
650	VERSYS LT	15 >	•
650	Z	17 >	•
750	Z 750	07 > 12	•
750	Z 750 ABS	07 > 12	•
800	Z 800 E	13 >	•

SUZUKI

250	DL V STROM	18 >	•
250	GSF IMPULSE	95 >	•
250	GSX R	98 > 16	•
250	GSX R	17 >	•
250	INAZUMA	12 >	•
250	V-STROM	17 >	•
400	GSX IMPULSE	94 >	•
400	RF	93 >	•
600	GSF BANDIT	95 > 99	•
600	RF R	93 > 96	•

SWM

440	GRAN MILANO	15 >	•
440	GRAN TURISMO	15 >	•
440	SILVER VASE	15 >	•

TRIUMPH

660	STREET TRIPLE S	17 >	•
675	STREET TRIPLE	08 > 12	•

765	STREET TRIPLE S	17 >	•
800	AMERICA	03 > 06	•
800	BONNEVILLE	01 > 04	•
800	BONNEVILLE AMERICA	02 >	•
800	BONNEVILLE BLACK	04 >	•
800	BONNEVILLE T100 PAUL SMITH	06 > 08	•
800	SPEEDMASTER	03 > 04	•
800	TIGER	11 >	•
800	TIGER XC	11 > 17	•
800	TIGER XC ABS	12 >	•
800	TIGER XCA	15 > 17	•
800	TIGER XCR	15 >	•
800	TIGER XR	15 > 17	•
800	TIGER XRT	15 > 17	•
800	TIGER XRX	15 > 17	•
865	BONNEVILLE SE	09 >	•
865	BONNEVILLE T100	09 >	•
865	NEW BONNEVILLE	09 >	•
885	THUNDERBIRD SPORT	04 >	•
900	ADVENTURER	96 >	•
900	AMERICA	07 >	•
900	BONNEVILLE	05 > 08	•
900	BONNEVILLE	09 >	•
900	BONNEVILLE	15 >	•
900	BONNEVILLE SPIRIT	15 >	•
900	BONNEVILLE STREET CUP	17 >	•
900	BONNEVILLE T100	05 > 08	•
900	BONNEVILLE T100	09 > 16	•

900	BONNEVILLE T100	17 >	•
900	BONNEVILLE T100 BLACK	17 >	•
900	BONNEVILLE T214	15 >	•
900	LEGEND TT	99 >	•
900	SCRAMBLER	06 >	•
900	STREET SCRAMBLER	17 >	•
900	STREET TWIN	16 >	•
900	THRUXTON	04 >	•
900	THRUXTON ACE	15 >	•
900	THUNDERBIRD	96 > 02	•
900	THUNDERBIRD	03 >	•
900	TIGER	99 > 00	•
900	TIGER	01 > 04	• •
955	TIGER	01 > 03	• •
955	TIGER	04 > 06	•
1200	BONNEVILLE BOBBER	17 >	•
1200	BONNEVILLE T120 BLACK	16 >	•
1200	THRUXTON	16 >	•
1200	TIGER XCA	18 >	•

VOXAN

1000	SCRAMBLER	01 >	•
------	-----------	------	---

YAMAHA

125	WR R, XY	09 >	•
250	WR X	08 >	•



07H031.09 102.1 x 38.9 x 9.6

07H031.SP “ “ “

2

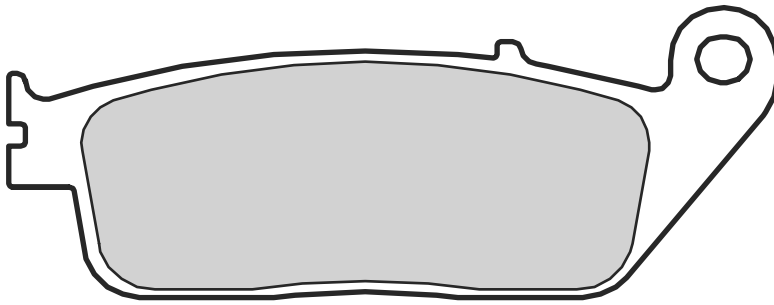
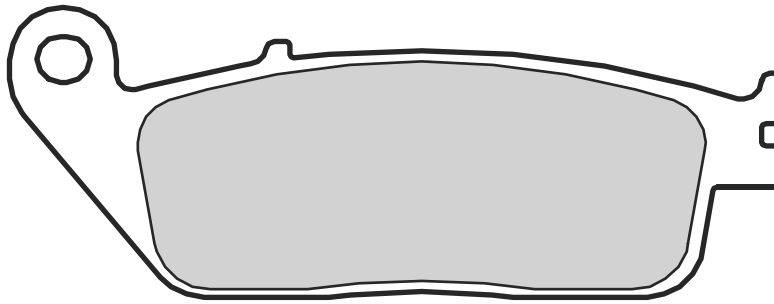

DAELIM

125 DAYSTAR	00 >	•
125 ROADWIN	04 >	•
125 ROCKET	99 >	•
125 S2	05 >	•
125 VL DAYSTAR	00 >	•
125 VT EVOLUTION	00 >	•
125 VT MAGNA	99 >	•
150 ROADWIN X5	06 >	•
250 ROADWIN	08 >	•
250 S2	06 >	•

HONDA

680 DN-01	08 >	•
750 VFR F	88 > 89	•
750 VFR F	90 > 97	•
950 VFR F	92 >	•
1000 CBR F, FJ, FK	89 > 92	•
1000 VF R	89 >	•
1500 GL C VALKIRIA	96 >	•
1500 GLX	97 >	•

INDIAN

1800 CHIEF	15 > 18	•
------------	---------	---

1800 CHIEF CLASSIC	14 >	•
1800 CHIEF DARK HORSE	15 > 18	•
1800 CHIEF VINTAGE	14 >	•
1800 CHIEFTAIN	14 >	•
1800 CHIEFTAIN CLASSIC	15 > 18	•
1800 CHIEFTAIN DARK HORSE	15 > 18	•
1800 CHIEFTAIN LIMITED	15 > 18	•
1800 ROADMASTER CLASSIC	15 > 18	•
1800 ROADMASTER ELITE	15 > 18	•
1800 SCOUT	15 >	•
1800 SPRINGFIELD	16 >	•
1800 SPRINGFIELD DARK HORSE	15 > 18	•

TRIUMPH

885 THUNDERBIRD SPORT	04 >	•
900 ADVENTURER	96 >	•
900 LEGEND TT	99 >	•
900 THUNDERBIRD	96 > 02	•
900 THUNDERBIRD	03 >	•
900 TIGER	99 > 00	•

VICTORY

1634 HAMMER	08 >	•
-------------	------	---

1634 KINGPIN ALL MODELS	08 >	•
1634 VEGAS	08 >	•
1634 VEGAS 8-BALL	08 >	•
1634 VEGAS JACKPOT	08 >	•
1731 BOARDWALK	13 >	•
1731 CROSS COUNTRY	10 >	•
1731 CROSS COUNTRY 8-BALL	14 >	•
1731 CROSS COUNTRY TOUR	12 >	•
1731 CROSS ROADS	10 >	•
1731 CROSS ROADS 8-BALL	14 >	•
1731 CROSS ROADS CLASSI	14 >	•
1731 HAMMER	09 >	•
1731 HAMMER 8-BALL	10 >	•
1731 HAMMER S	09 >	•
1731 HARD-BALL	12 >	•
1731 HIGH-BALL	12 >	•
1731 JACKPOT	10 >	•
1731 JUDGE	13 >	•
1731 KINGPIN	10 >	•
1731 KINGPIN 8-BALL	10 >	•
1731 MAGNUM X-1	15 >	•
1731 VEGAS	10 >	•
1731 VEGAS 8-BALL	10 >	•
1731 VEGAS JACKPOT	09 >	•



07H032.SP 45.9 x 45 x 7.5

07H032.SD “ “ “

07H032.SX “ “ “

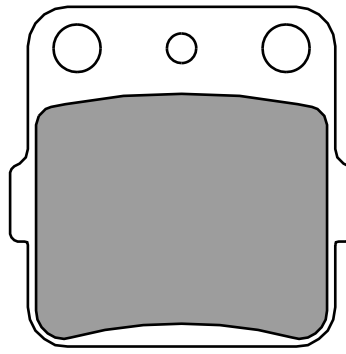

ARCTIC CAT

400 DVX 04 > •

HONDA

85 CR R, R EXPERT 03 > •
 150 CRF R 07 > 18 •
 200 ATC X 83 > 85 •
 250 TRX EX SPORTRAX 01 > 08 •
 250 TRX X 08 > •
 250 X 250 08 > •
 300 TRX EX SPORTRAX 01 > 08 • •
 300 TRX X 09 > • •
 400 TRX EX SPORTRAX 01 > 08 • •
 400 TRX FOURTRAX EX 99 > • •
 400 TRX X 09 > • •
 420 TRX FA / FPA 09 > • •
 420 TRX FPE / FPM 4X4 09 > • •
 450 TRX EX SPORTRAX 01 > • •

KAWASAKI

80 KX L, N, R 88 > 96 •

80 KX R7, T7, W1, W2, Y1, Y2 97 > 00 •
 85 KX, II 01 > •
 100 KX 88 > 96 •
 100 KX 97 > •
 250 KSF A1-A17 MOJAVE 87 > •
 250 KXF A1, A2 TECATE 87 > 88 •
 250 KXT B2 TECATE 87 > •
 300 KEF LAKOTA 95 > •
 450 KFX RIGHT CALIPER 07 > •

SUZUKI

100 RM 03 > •
 230 LT EH-EP 86 > 93 •
 250 LT SK, SL 89 > 90 •
 500 RM H 87 > •
 800 DR Z 88 > 90 •

TM

80 JUNIOR 96 > 00 •

YAMAHA

80 YZ E, F, G, H1, J1 93 > 01 •
 85 YZ 02 > •
 200 YFS R BLASTER 03 > •
 250 YFM RAPTOR left/rear 09 > •
 YFM FXG-FXM
 350 WOLVERINE (4KB/EBE) 95 > 96 •
 350 YFM R RAPTOR 04 > • •
 YFM XG,XH WARRIOR
 350 (3GD/EBE) 95 > 96 •
 350 YFM XT, XU WARRIOR 87 > 88 •
 350 YZF A-M BANSHEE 90 > 06 •
 350 YZF T-W BANSHEE 87 > 89 •
 450 YZF S 04 > 05 •
 YFM FWAK-FWAN 4X4
 600 GRIZZLY 98 > 01 •
 660 YFM GRIZZLY FWAP 4X4 02 > •
 660 YFM RN RAPTOR 01 > • •



07H033.CC 39.9 x 56.2 x 9.5

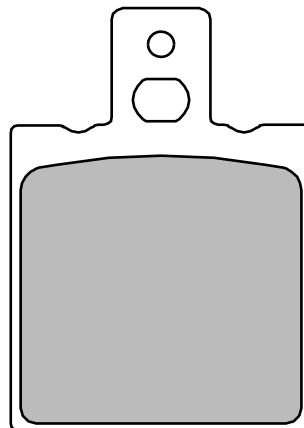

HONDA

125 CRM 90 > 98 •
 125 NSR F 90 > 92 •
 125 NSR R, ITALY 89 > •





07H034.05 102.1 x 38.9 x 10.4

07H034.SP “ “ “

2

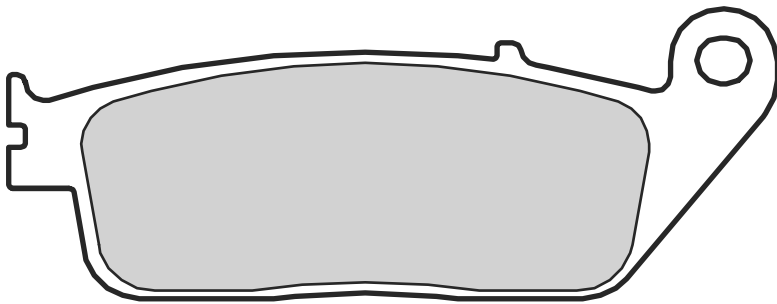
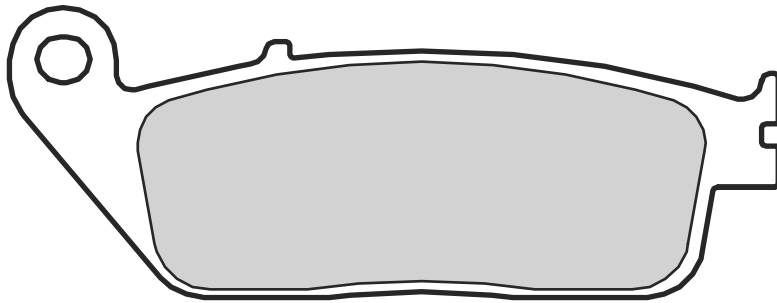

HONDA

250 VTR	98 >	•
400 CB SUPER FOUR	92 > 95	•
750 VF C	94 >	•
1100 ST ABS-TCS-CBS	92 > 95	•
1100 ST PAN EUROPEAN	90 > 02	•

KYMCO

250 VENOX	01 >	•
-----------	------	---

YAMAHA

1700 MT 01	05 > 06	•
1700 MT 01	07 > 11	•



07H035.09 88.2 x 46.1 x 10.5

07H035.SA “ “ “

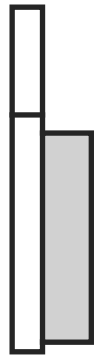
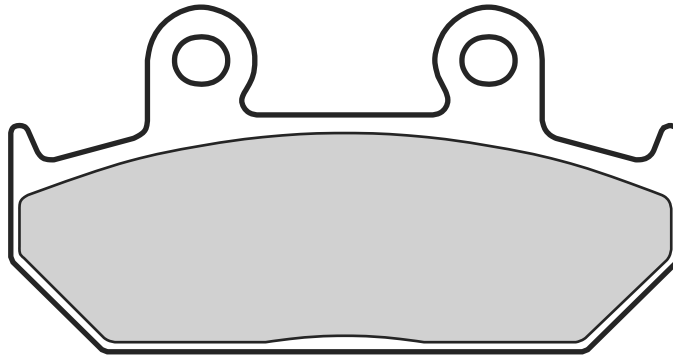

CAGIVA

500 CANYON	99 >	•
900 CANYON I.E.	97 > 98	•
900 ELEFANT I.E.	90 >	•



HONDA

125 CB TT	90 >	•
600 VT C, SHADOW	92 > 92	•
600 VT SHADOW CUSTOM	88 >	•
600 XL V TRANSALP	91 > 93	•



650 NX DOMINATOR	88 > 92	•
650 XRV AFRICA TWIN	88 >	•
1500 GL ASPENCADE	94 > 97	•
1500 GL GOLDWING SE	88 > 00	•
1500 GLX	88 > 96	•





07H036.07 85.7 x 40 x 8.9

07H036.SP “ “ “

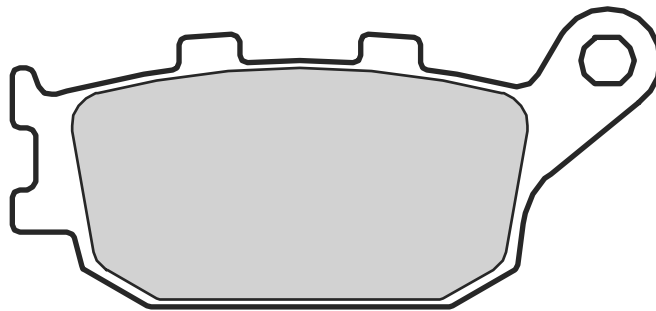
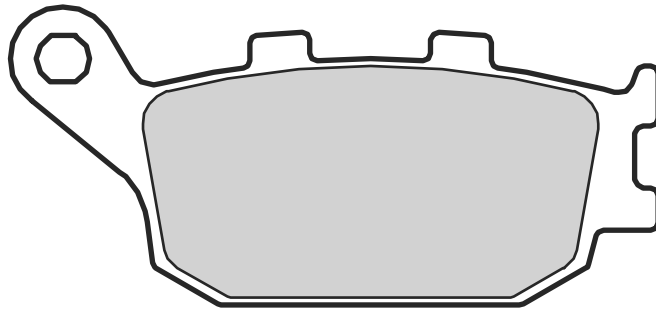

HONDA

400	CBR F	92 >	•
500	CBF	04 >	•
500	CBF ABS	04 >	•
600	CBF	08 >	•
600	CBF N	03 > 11	•
600	CBF N ABS	08 > 11	•
600	CBF S	04 > 09	•
600	CBF S ABS	08 > 12	•
600	CBR F, SUPER SPORT	91 > 94	•
600	CBR F3	95 > 98	•
600	CBR F4	99 > 02	•
600	CBR RR	03 > 04	•
600	CBR RR	05 > 06	•
600	HORNET	98 > 06	•
600	HORNET / S	00 > 06	•
600	HORNET ABS	07 >	•
650	NTV DEAUVILLE	01 > 02	•
700	NC S	12 >	•
700	NC SA ABS	12 >	•
700	NC SD ABS	12 >	•
700	NC X	12 > 13	•
700	TRX INTEGRA	12 >	•
700	XA ABS	12 >	•
700	XAD ABS	12 >	•
700	XL TRANSALP ABS	09 >	•

750	CB N, SEVEN FIFTY	92 >	•
750	INTEGRA DCT/DCTS	14 >	•
750	NR	92 >	•
900	CBR RR	92 > 97	•
900	CBR RR	98 > 99	•
900	CBR RR FIREBALDE	02 > 03	•
900	CBR RR FIREBLADE	00 > 01	•
900	HORNET	02 >	•
929	CBR RR	00 > 01	•
954	CBR RR	02 > 03	•
1000	CB BIG ONE	93 > 95	•
1000	CBF	06 >	•
1000	CBF F ABS	15 >	•
1000	CBF ST ABS	09 >	•
1000	CBF1000ST ABS	09 >	•
1000	CBR RR	04 > 05	•
1000	CRF L AFRICA TWIN	16 > 18	•
1000	CRF L AFRICA TWIN ADVENTURE SPORTS	18 >	•
1000	VTR F	97 >	•
1000	VTR F FIRESTROM	97 > 07	•
1000	VTR SP01	00 > 01	•
1000	VTR SP02	02 > 06	•
1100	CB	13 > 16	•
1100	CB EX	17 >	•
1100	CB EX ABS	17 > 18	•
1100	CB RS	17 >	•

1100	VT C2 Y	00 >	•
1100	VT SHADOW	94 > 96	•
1100	VT SHADOW C2	95 > 98	•
1100	VT SHADOW C3	99 > 02	•
1300	CB	11 >	•
1300	CB S	11 >	•
1300	CTX	14 > 16	•
1300	VT FURY	10 > 16	•
1300	VTX	03 >	•

KAWASAKI

650	NINJA	17 >	•
650	VULCAN S	15 >	•
650	VULCAN S CAFE'	17 >	•
650	VULCAN S SE	17 >	•
650	Z	17 >	•
750	Z 750	07 > 12	•
750	Z 750 ABS	07 > 12	•
750	Z R	11 >	•
1000	KLV right caliper	04 >	•
1000	VERSYS	17 >	•
1000	VERSYS LT	15 >	•
1000	Z	07 > 09	•

SUZUKI

250	GSX R	98 > 16	•
-----	-------	---------	---



250 INAZUMA	12 >	•
250 V-STROM	17 >	•
650 DL V STROM	04 >	•
650 DL V STROM XT (left/rear)	15 >	•
650 GSF ABS	07 >	•
650 GSF S ABS	07 >	•
650 GSX F	08 >	•
650 SV	03 > 08	•
750 GSR	11 > 16	•
750 GSX S	17 > 17	•
1000 DL V STROM	02 > 13	•
1000 GSX S 1000 F ABS	15 >	•
1000 GSX S ABS	15 >	•
1000 GSX S F	15 >	•
1000 SV	03 >	•
1000 SV S	03 >	•
1250 GSF ABS	07 >	•
1250 GSF S ABS	07 >	•
1250 GSX F	10 >	•
1250 GSX FA	10 >	•
1300 B-KING	07 > 12	•

YAMAHA

600 FZ 6	04 >	•
600 FZ6 FAZER S2	07 > 10	•
600 FZ6 FAZER S2 ABS	07 > 10	•
600 FZ6 S2	07 >	•
600 FZ6 S2 ABS	07 >	•
600 XJ 6 N	13 >	•
600 XJ 6 N SP	13 > 13	•
600 XJ 6 NA ABS	13 > 13	•
600 XJ 6 S DIVERSION	13 >	•
600 XJ6 F	13 >	•
600 YZF R6	03 > 16	•
700 MT 07	14 >	•
700 MT 07 MOTOCAGE ABS	15 >	•
700 MT 07 SP	18 >	•
700 MT 07 TRACER ABS	16 >	•
700 XSR 700	16 >	•
700 XSR 700 SPEED BLOCK	16 >	•
800 FZ 8	10 > 16	•
800 FZS FAZER	10 > 16	•
850 MT 09	14 >	•
850 MT 09 ABS	14 >	•

850 MT 09 SPORT TRACKER ABS	15 >	•
850 MT 09 STREET RALLY	14 >	•
850 MT 09 STREET RALLY ABS	14 >	•
850 MT 09 TRACER ABS	15 >	•
900 TRACER	18 >	•
900 TRACER GT	18 >	•
900 XSR 900	16 >	•
900 XSR 900 SPEED BLOCK	16 >	•
900 XSR ABARTH	17 > 18	•
1000 FZ1	06 >	•
1000 FZ1 FAZER	06 > 15	•
1000 MT 10 SP	16 >	•
1000 MT 10 TOURER ED.	16 >	•
1000 YZF R1	04 > 06	•
1000 YZF R1	07 > 08	•
1000 YZF R1 SP	06 > 14	•
1199 XT 1200 ZE SUPER TENERE RAID ED.	18 >	•



07H037.SA

68.9 x 51 x 9
32.7 x 49.9 x 9

2

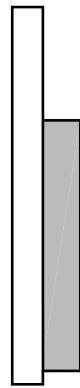
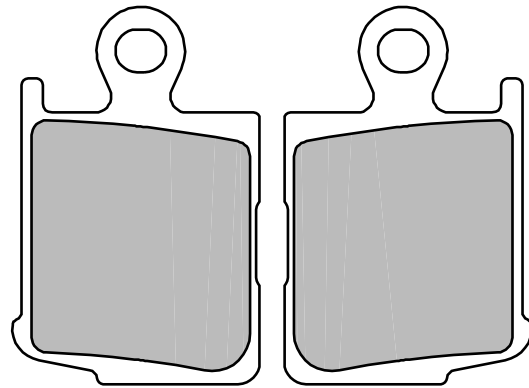
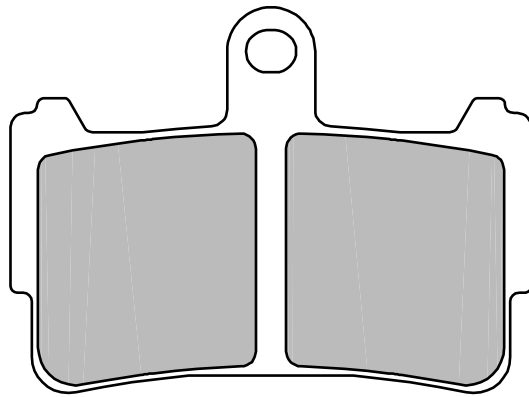

HONDA

1200 F W/DCT	10 >	•
1200 VFR F	10 > 16	•
1200 VFR FW	10 > 16	•



07H039.07	125.5 x 44.3 x 8.7
------------------	--------------------

07H039.SA	“ “ “
------------------	-------

07H039.SP	“ “ “
------------------	-------

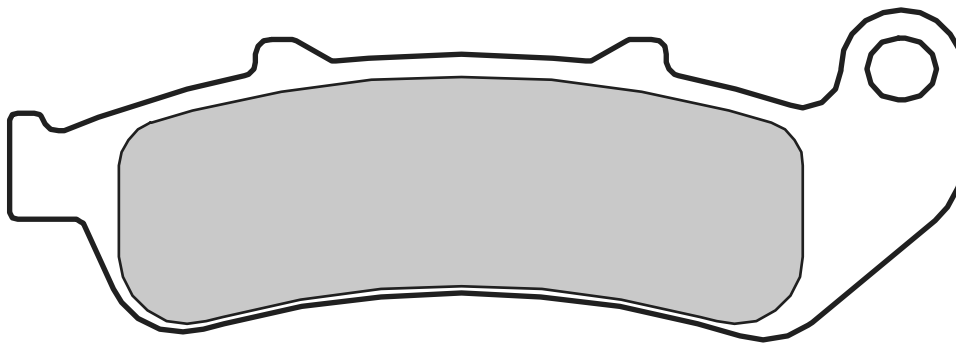
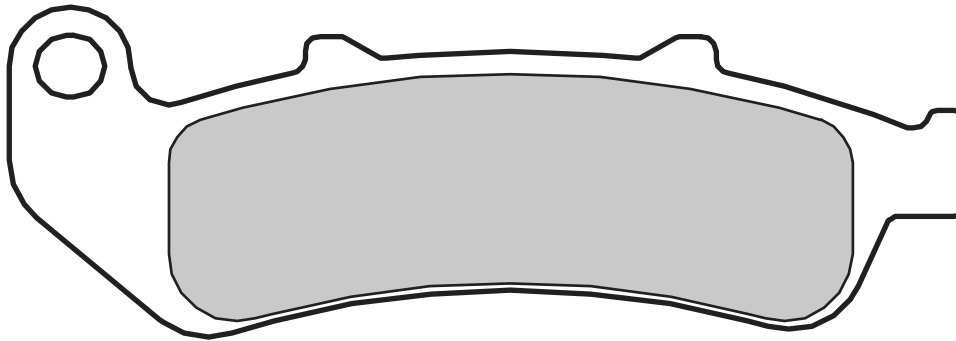

HONDA

1000 CBR F, FP	93 > 98	• •
1100 ST ABS-TCS-CBS	92 > 95	•





07H040.08

79.9 x 41.9 x 9.2

96.6 x 41.9 x 9.2

2

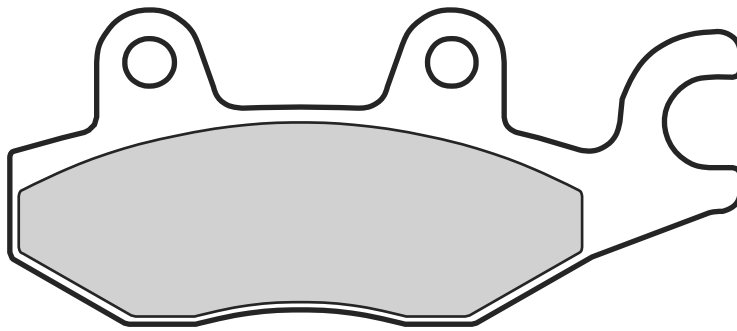
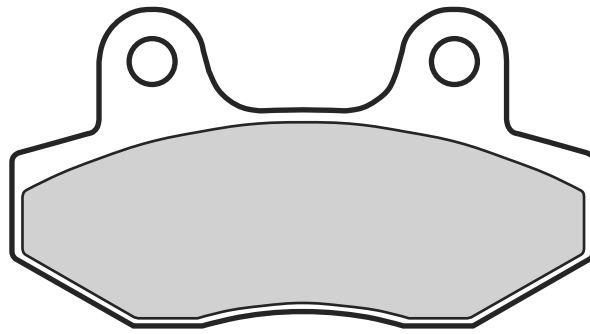

CF MOTO

125 PAPIO 17 > •

150 NSR	02 > •
250 CB F	04 > •
300 CB	10 > •

125 TORPEDO	08 > •
150 TORPEDO	08 > •

HONDA

125 VARADERO	01 > •
125 VT SHADOW	99 > •

ITALJET

50 ROLLERCRAFT 08 > •

KYMCO

125 K-PIPE 13 > •



07H041.08 102.1 x 38.9 x 9.6

07H041.SA “ “ “

07H041.LA “ “ “

07H041.SC “ “ “

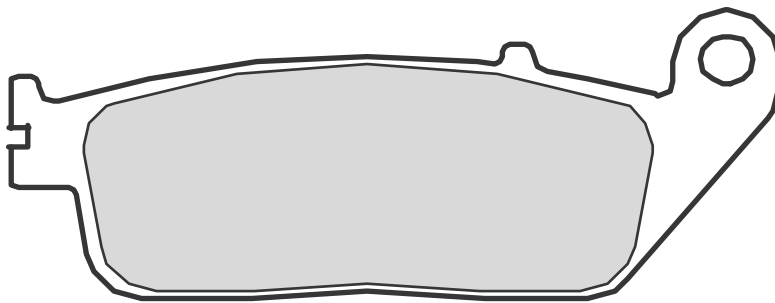
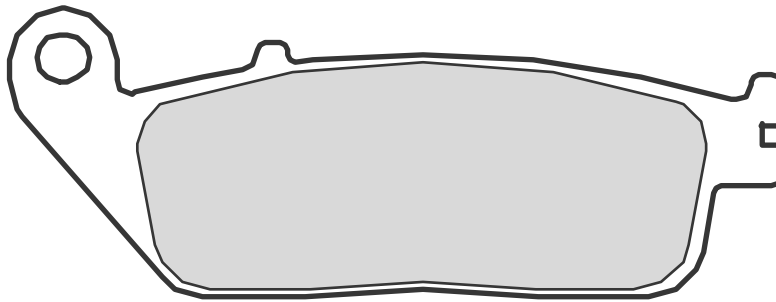

HONDA

250	CBR RR	17 > 18	•
300	CBR F	14 >	•
300	CBR R	15 >	•
300	CMX REBEL	17 >	•
500	CB F	13 >	•
500	CB F ABS	13 > 14	•
500	CB X	13 >	•
500	CB X ABS	13 > 14	•
500	CBF	04 >	•
500	CBR R	04 >	•
500	CBR R ABS	13 > 14	•
500	CMX REBEL	17 > 18	•
500	F	13 >	•
500	R	13 >	•
500	X	13 >	•
600	XL V TRANSALP	94 > 96	•

600	XL V TRANSALP VR/VT	94 > 96	•
650	CB F	14 >	•
650	CBR F	16 > 18	•
650	CBR F ABS	16 > 18	•
700	CTX	14 > 16	•
700	CTX D ABS w/DCT	14 > 16	•
700	CTX N	14 > 16	•
700	CTX ND ABS w/DCT	14 > 16	•
700	NC S	12 >	•
700	NC SA ABS	12 >	•
700	NC SD ABS	12 >	•
700	NC X	12 > 13	•
700	VULTUS ABS w/DCT	15 >	•
750	BLACK WIDOW	01 >	•
750	INTEGRA	14 >	•
750	INTEGRA DCT/DCTS	14 >	•
750	NC S	14 >	•

750	NC S ABS	14 >	•
750	NC S DCT	14 >	•
750	NC X	14 >	•
750	NC X ABS	14 >	•
750	NC X ABS DCT	14 >	•
750	SHADOW	04 >	•
750	VT C 2B	11 >	•
750	VT C, SHADOW	97 > 03	•
750	VT RS, S	11 >	•
750	VT SHADOW SPIRIT	07 >	•
750	VULTUS ABS w/DCT	15 >	•
1000	CBF	06 >	•

TRIUMPH

900	ADVENTURER	95 > 95	•
900	THUNDERBIRD	95 > 95	•





07H042.06 115 x 40.1 x 8.3

07H042.SA “ “ “

07H042.LA “ “ “

2

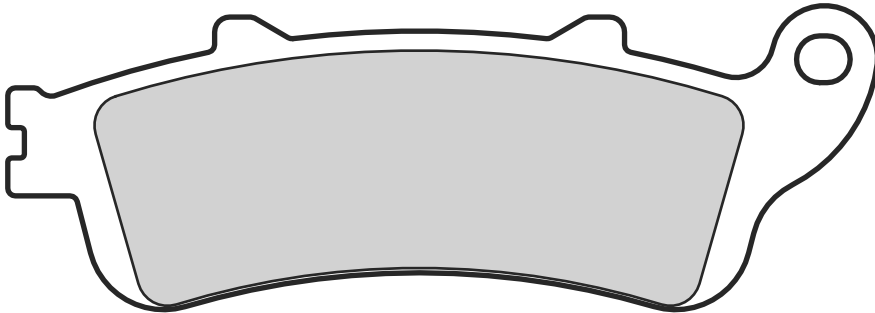
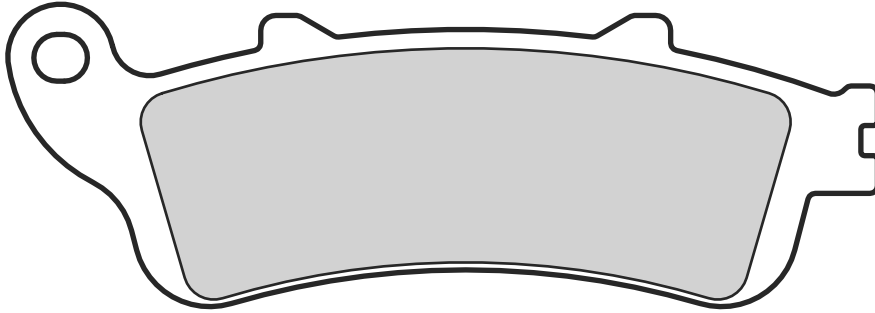

HONDA

650 NTV DEAUVILLE	03 >	•
800 VFR FI	98 > 01	•
800 VFR V-TEC ABS	02 > 05	•
1000 CBR XX	96 >	•
1000 VARADERO ABS	04 >	•
1000 XL VARADERO	99 > 03	•

1000 XL VARADERO (LINKED BRAKE SYSTEM)	00 >	•
1100 CB HORNET	99 >	•
1100 CB X 11	00 >	•
1100 CBR XX	96 >	•
1100 ST	96 >	•
1300 STX PAN EUROPEAN	02 >	•
1800 GL GOLDWING	01 > 12	•

1800 GL GOLDWING F6B	13 >	•
1800 VTX	01 >	•

KAWASAKI

650 VULCAN S	15 >	•
650 VULCAN S CAFE'	17 >	•
650 VULCAN S SE	17 >	•



07H043.08 115 x 40.1 x 8.3

07H043.SP “ “ “

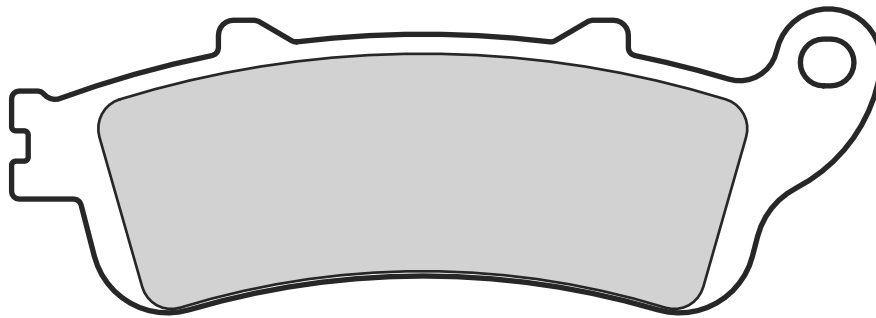
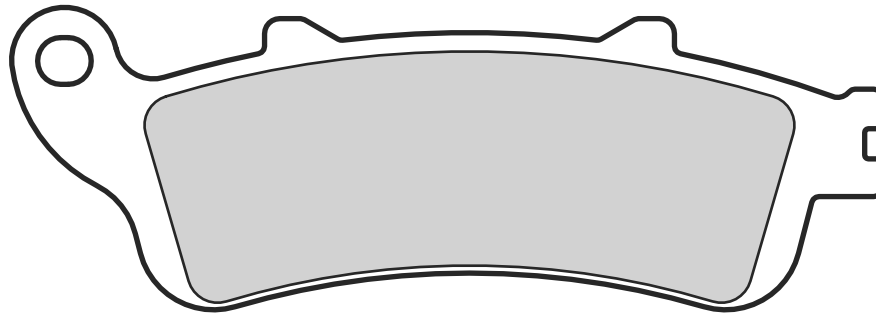

HONDA

650	NTV DEAUVILLE	03 >	•
700	NT DEAUVILLE ABS	06 >	•
700	NT VARADERO ABS	10 >	•
800	VFR FI	98 > 01	•
800	VFR V-TEC ABS	02 > 05	•
800	VFR V-TEC ABS	06 > 10	•

1000	CBR XX	96 >	•
1000	VARADERO ABS	04 >	•
1000	XL VARADERO	99 > 03	•
1000	XL VARADERO (LINKED BRAKE SYSTEM)	00 >	•
1000	XLV VARADERO ABS	04 >	•
1000	XLV VARADERO TRAVEL ABS	04 >	•

1100	CB HORNET	99 >	•
1100	CB X 11	00 >	•
1100	CBR XX	96 >	•
1100	ST	96 >	•
1300	FURY ABS	10 > 16	•
1300	STX PAN EUROPEAN	02 >	•
1300	VTX C	04 >	•
1800	VTX	01 >	•





07H044.CC

115 x 40.1 x 7.6

07H044.SA

“ “ “

2

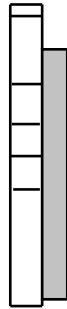
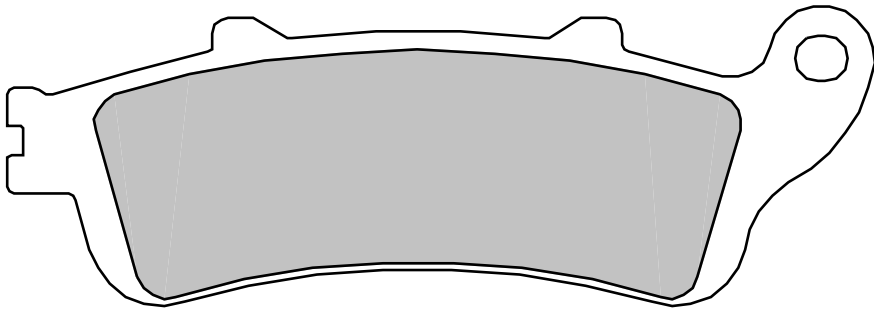
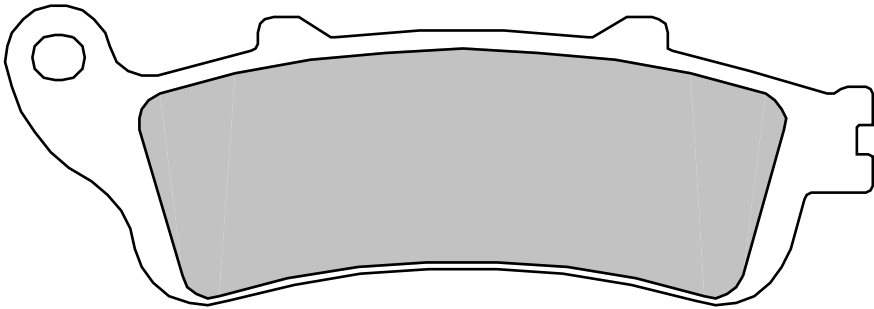

HONDA

1100 ST A6 ABS-TCS-CBS

96 >



330



07H045.07 74.5 x 55.2 x 7.2

07H045.SA “ “ “

07H045.SC 74.5 x 55.2 x 8

07H045.RC “ “ “

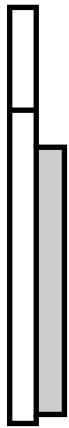
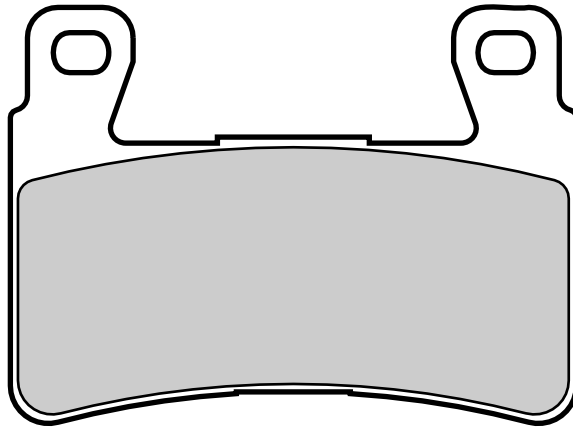

HONDA

600 CBR F4	99 > 02	•
600 CBR RR	03 > 04	•
900 CBR RR	98 > 99	•
900 CBR RR FIREBALDE	02 > 03	•
900 CBR RR FIREBLADE	00 > 01	•
929 CBR RR	00 > 01	•
954 CBR RR	02 > 03	•

1000 VTR SP01	00 > 01	•
1000 VTR SP02	02 > 06	•
1100 CB EX	17 >	•
1100 CB EX ABS	17 > 18	•
1300 CB R	02 >	•

HYOSUNG

125 GD EXIV	12 >	•
-------------	------	---

250 GD EXIV-R	15 >	•
250 GT IR	15 >	•
650 GT I	13 >	•
650 GT IR	13 >	•
650 i NAKED	15 >	•
650 LR	15 >	•

15 >	•
15 >	•
13 >	•
13 >	•
15 >	•
15 >	•





07H046.07

75.1 x 42 x 8.1

2

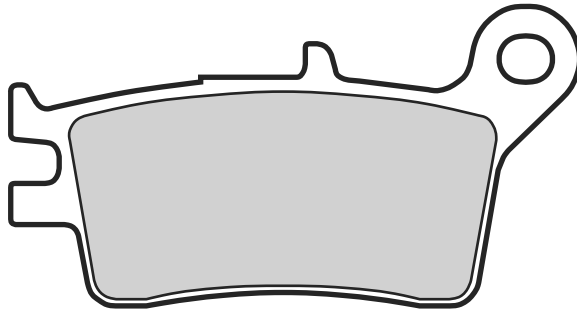
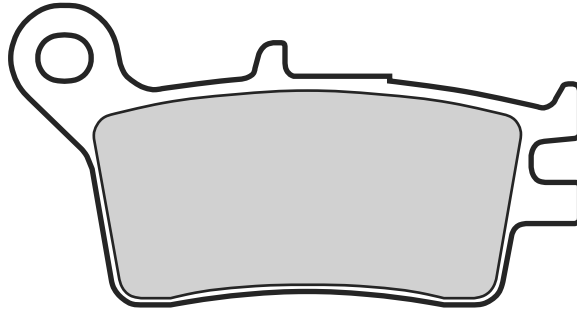

HONDA

220 TLM	89 >	•
260 TLM R	90 >	•



07H047.CC

74.9 x 55.5 x 7.6

07H047.SA

“ “ “

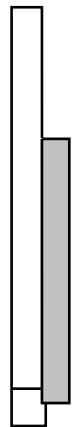
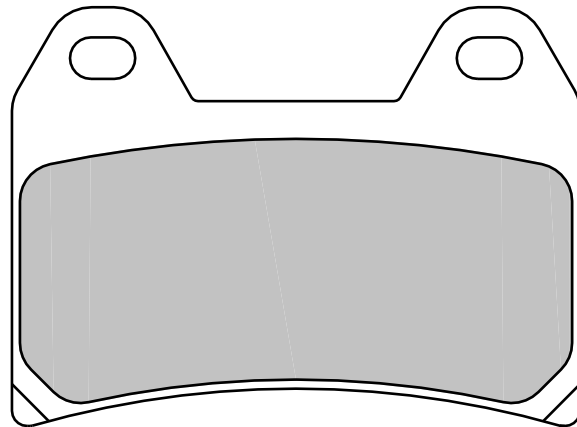

HONDA

400 CB SUPER FOUR S	97 >	•
---------------------	------	---



07H048.SD 59.7 x 43.7 x 9.5

07H048.SX “ “ “

07H048.TT “ “ “

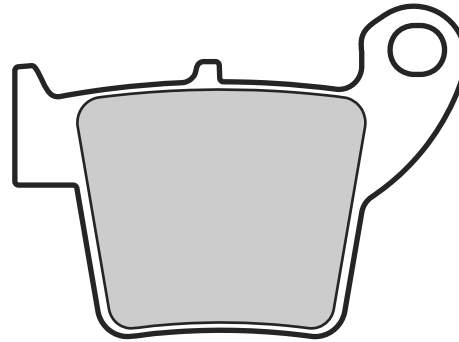
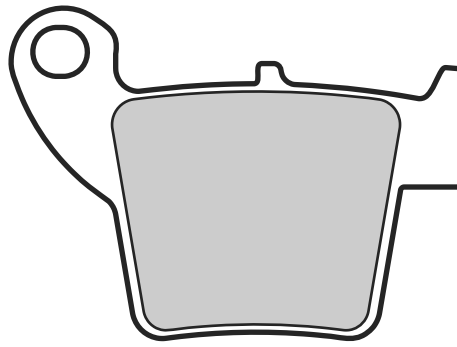

2



FANTIC MOTOR

125	CABALLERO ENDURO	12 >	•
125	CABALLERO MOTARD	10 >	•
125	CABALLERO REGOLARITA'	10 >	•
200	CABALLERO MOTARD	10 >	•
200	CABALLERO REGOLARITA'	10 >	•

HM

50	CRE BAJA RR	07 > 09	•
50	CRE SIX COMPETITION	07 > 08	•
50	CRE SIX COMPETITION	09 >	•
50	CRM DERAPAGE	09 >	•
125	CR SUPERMOTARD	04 >	•
125	CRE BAJA	11 >	•
125	CRE R ENDURO	02 > 03	•
125	CRE SIX COMPETITION	11 >	•
125	CRM DERAPAGE	11 >	•
125	CRM X SUPERMOTARD	07 > 07	•
150	CRF R	07 > 09	•

250	CRE F ENDURO	04 >	•
250	CRE FX	08 > 11	•
250	CRE R ENDURO	02 >	•
250	CRE X	04 >	•
250	CRE X ENDURO	04 > 09	•
250	CRF X SUPERMOTARD	04 >	•
250	CRM X SUPERMOTARD	07 >	•
450	CRE F ENDURO	02 >	•
450	CRE X ENDURO	04 >	•
450	CRF F SUPERMOTARD	04 >	•
450	CRF R	04 > 09	•
450	CRF SUPERMOTARD	02 >	•
450	CRF X SUPERMOTARD	04 >	•
450	CRM X SUPERMOTARD	07 >	•
490	CRE FX	07 >	•
490	CRM F SUPERMOTO	07 > 07	•
500	CRM F SUPERMOTO	11 >	•
500	CRM X SUPERMOTARD	07 > 09	•

HONDA

125	CR E	02 >	•
-----	------	------	---

125	CR R	02 >	•
150	CRF R	07 > 18	•
250	CR E	02 >	•
250	CR R	02 >	•
250	CRE F	04 >	•
250	CRE X	04 >	•
250	CRF R	04 >	•
250	CRF R EFI	18 >	•
450	CRE F	02 >	•
450	CRF R	09 >	•
450	CRF R EFI	17 > 18	•
450	CRF RX EFI	17 > 18	•
450	CRF X	05 >	•
450	CRF, E	02 >	•
450	CRF, EFI	13 >	•
450	ENDURO SUPERMOTO	18 >	•
450	TRX X	04 >	•
750	NC X	18 >	•

TM

85	85	13 >	• •
----	----	------	-----





07H049.05

106.7 x 42.4 x 10

91.4 x 39.8 x 10

2

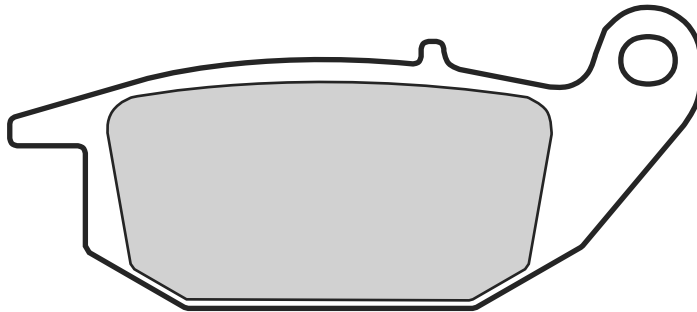
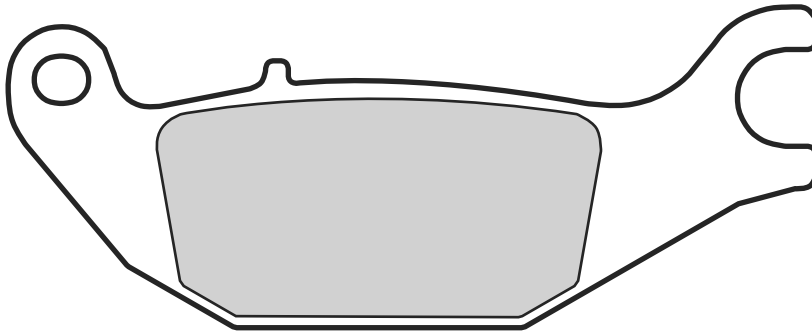

CF MOTO

125 PAPIO 17 > •

HONDA

125 CBR R 04 > 10 •

125 VARADERO 01 > •

150 CBR R 00 > •

YAMAHA

150 YZF R15 14 > •



07H050.SA 74.1 x 46.7 x 8

07H050.LA “ “ “

07H050.SC 74.1 x 46.7 x 9

07H050.RC “ “ “

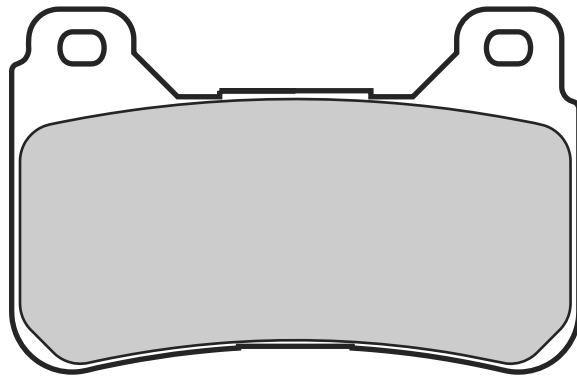

HONDA

600 CBR RR	05 > 06	•
600 CBR RR	07 >	•
600 CBR RR	09 >	•
600 CBR RR ABS	09 > 12	•

800 CROSSRUNNER ADVENTURE	15 >	•
800 VFR F	14 >	•
1000 CB R	08 >	•
1000 CB R ABS	09 > 14	•

1000 CBR RR	04 > 05	•
1000 CBR RR	06 >	•
1000 CBR RR ABS	09 > 16	•
1000 CBR RR FIREBLADE	09 > 17	•
1000 CBR RR FIREBLADE ABS	09 >	•





07H052.SP 115 x 40.1 x 10.3

2

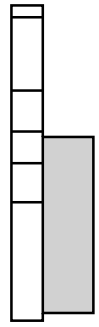
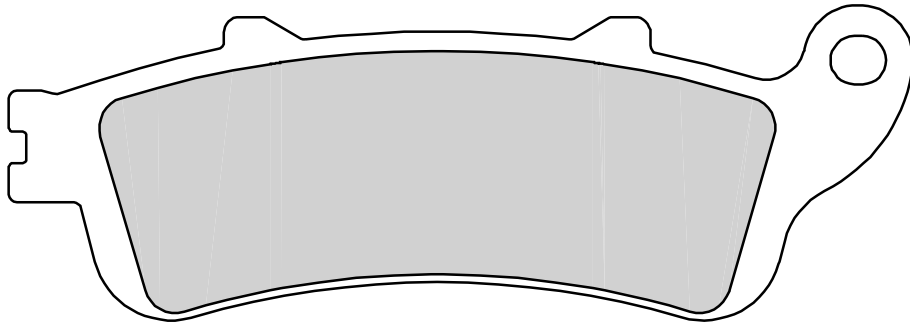
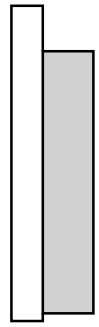
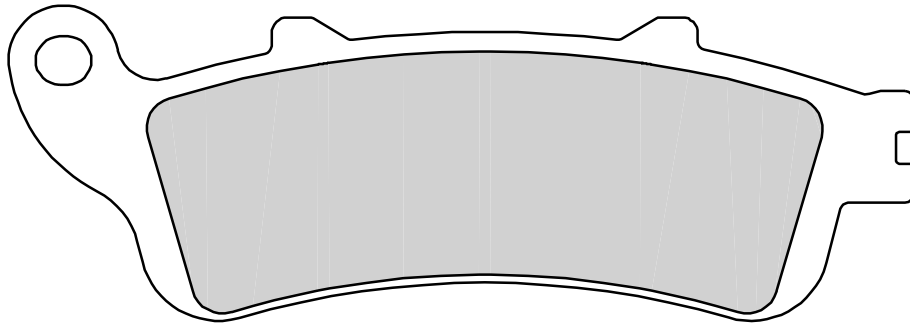

HONDA

1800 GL GOLDWING	01 > 12	•
1800 GL GOLDWING F6B	13 >	•



07H053.CC

86.1 x 39.9 x 9

07H053.SP

“ “ “

2

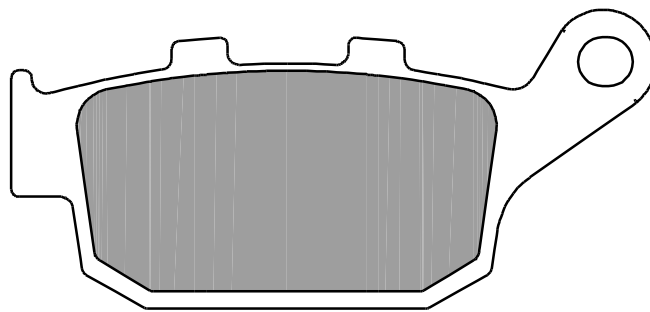
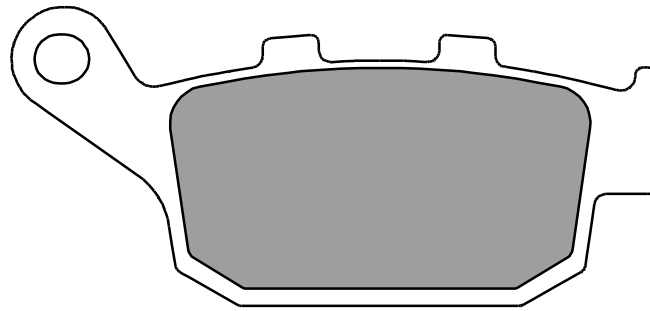

HONDA

250 CBR R	11 >	•
250 CBR R ABS	11 >	•
250 CBR RR	17 > 18	•
300 CBR F	14 >	•
300 CBR R	15 >	•
300 CMX REBEL	17 > 18	•
300 CMX REBEL	17 >	•
500 CB F	13 >	•
500 CB F ABS	13 > 14	•
500 CB X	13 >	•
500 CB X ABS	13 > 14	•
500 CBR R	04 >	•
500 CBR R ABS	13 > 14	•
500 CMX REBEL	17 > 18	•
650 CB F	14 >	•
650 CBR F	16 > 18	•
650 CBR F ABS	16 > 18	•
700 A-ADV	17 >	•

700 CTX	14 > 16	•
700 CTX D ABS W/DCT	14 > 16	•
700 CTX N	14 > 16	•
700 CTX ND ABS W/DCT	14 > 16	•
700 VULTUS ABS w/DCT	15 >	•
750 INTEGRA	14 >	•
750 NC S	14 >	•
750 NC S ABS	14 >	•
750 NC S DCT	14 >	•
750 NC X	14 >	•
750 NC X ABS	14 >	•
750 NC X ABS DCT	14 >	•
750 VULTUS ABS w/DCT	15 >	•
750 X ADV	17 > 18	•

KAWASAKI

650 VERSYS LT	15 >	•
750 Z 750 R	11 > 12	•
750 Z 750 R ABS	11 > 12	•

800 Z 800	13 > 16	•
800 Z 800 ABS	13 >	•
800 Z 800 E	13 >	•
800 Z 800 SUGOMI EDITION	16 >	•
800 Z e ABS	13 >	•
900 Z	17 >	•
900 Z 900 RS	18 >	•
900 Z A2 (DEPOTENZIATA)	18 >	•
900 Z RS CAFE' RACER	18 >	•
1000 NINJA (RAD. CAL) SE	18 >	•

SUZUKI

250 DLV STROM	18 >	•
250 GSX R	17 >	•
650 GLADIUS	09 >	•
650 SV X LEFT/REAR	18 >	•

SWM

440 GRAN MILANO	18 >	•
-----------------	------	---



**07H055.SD**

75.3 x 39.4 x 9.7

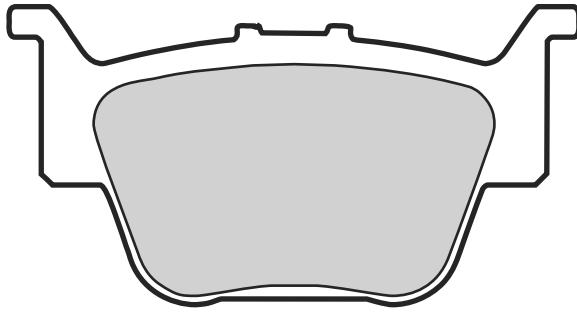
**HONDA**

420	TRX FA / FPA	09 >	•
450	TRX R	04 >	•
650	TRX FA RINCON	03 > 05	•
650	TRX FGA RINCON	04 > 05	•
680	TRX FA6 RINCON	06 >	•
680	TRX FGA6 RINCON	06 >	•

**07H056.06**

110.8 x 35.7 x 7.6

98.1 x 32.7 x 7.6

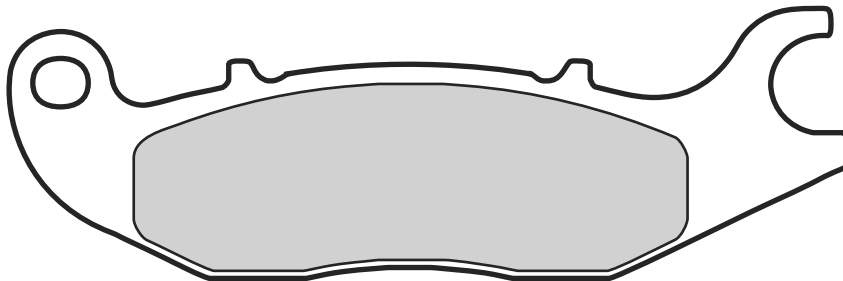
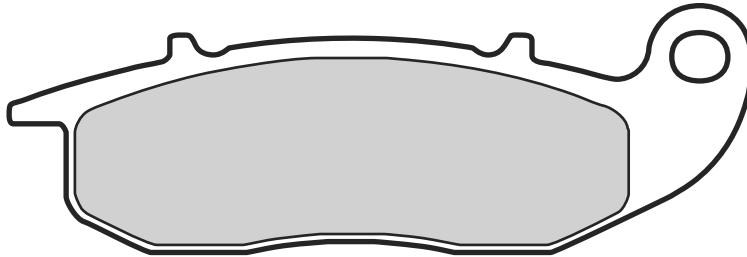
**HONDA**

125	ANF INNOVA	03 >	•
125	CBF	09 >	•
125	CBR	12 >	•
125	CBR R	04 > 10	•

125	CBR R	11 > 18	•
125	MSX	14 >	•
125	MSX GROM	14 >	•
150	CBR R	00 >	•

RIEJU

50	RS2 NKD	06 >	•
50	RS2 PRO	10 >	•
50	RS3	10 >	•
125	RS2 NKD	06 >	•



07H057.SA 117.6 x 44.9 x 8.8

07H057.LA “ “ “

07H057.SP “ “ “

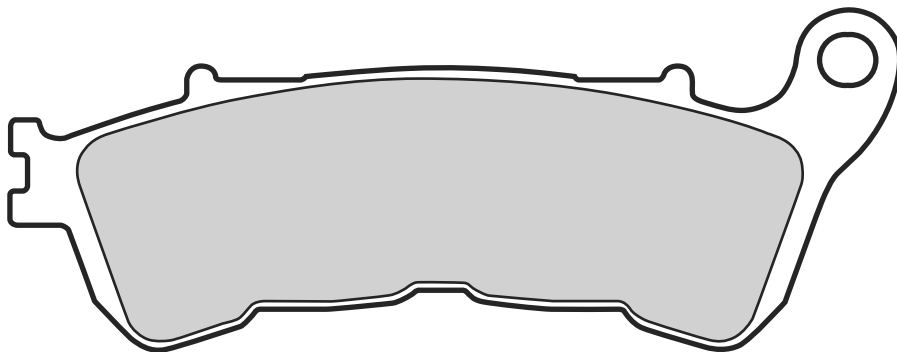
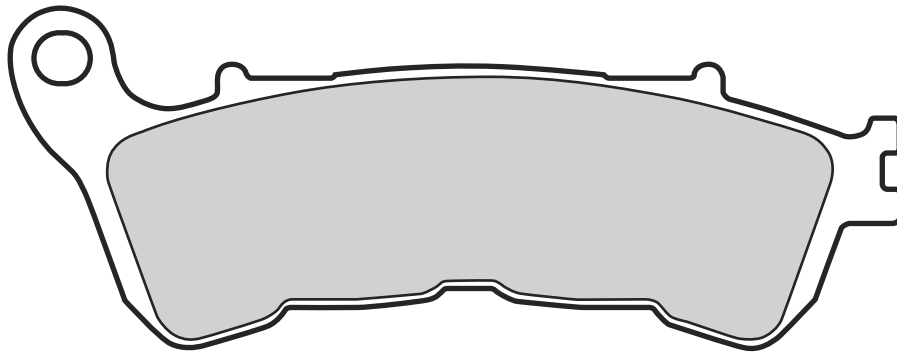

HONDA

250 CBR R ABS	11 >	•
500 CBF ABS	04 >	•
600 CBF	08 >	•
600 CBF N ABS	08 > 11	•
600 CBF S ABS	08 > 12	•
600 CBR F ABS	11 >	•
600 HORNET ABS	07 >	•
680 DN-01	08 >	•
700 NT DEAUVILLE ABS	06 >	•
700 NT VARADERO ABS	10 >	•
700 TRX INTEGRA	12 >	•
700 XA ABS	12 >	•

700 XAD ABS	12 >	•
700 XL TRANSALP ABS	09 >	•
750 VT C2S ABS	13 >	•
750 VT CS ABS	13 >	•
800 CROSSRUNNER	11 >	•
800 VFR V-TEC ABS	06 > 10	•
1000 CB R ABS	08 > 08	•
1000 CB R ABS	15 >	•
1000 CBF ABS	06 >	• •
1000 CBF F ABS	15 >	•
1000 CBF ST ABS	09 >	•
1000 CBF1000ST ABS	09 >	•
1000 XLV VARADERO ABS	04 >	•

1000 XLV VARADERO TRAVEL ABS	04 >	•
1100 CB	13 > 16	•
1200 CROSSTOURER	12 >	•
1237 VFR X CROSSTOURER	16 >	•
1300 CB	11 >	•
1300 CB S	11 >	•
1300 CTX	14 > 16	•
1300 FURY ABS	10 > 16	•

SUZUKI

1800 C R INTRUDER	08 >	•
-------------------	------	---





07H058.SD 81.4 x 38.9 x 10.1

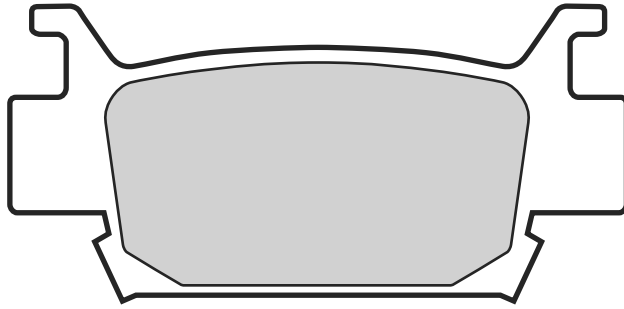

2



HONDA

500 TRX	05 >	•
700 TRX XX	08 >	•



07H059.07 77.2 x 41.7 x 8.9

07H059.SP “ “ “

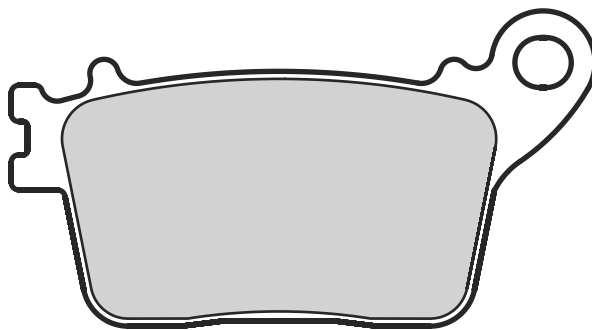
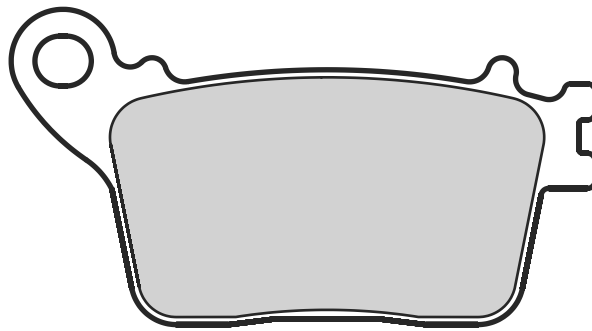

HONDA

600 CBR F	11 >	•
600 CBR F ABS	11 >	•
600 CBR F SPORT	11 > 12	•
600 CBR RR	07 >	•
600 CBR RR	09 >	•
600 CBR RR ABS	09 > 12	•
600 HORNET	07 >	•
1000 CBR RR	06 >	•
1000 CBR RR ABS	09 > 16	•
1000 CBR RR ABS	17 >	•
1000 CBR RR FIREBLADE	17 > 18	•
1000 CBR RR FIREBLADE ABS	09 >	•
1000 CBR RR SP	17 > 18	•
1000 CBR RR SP2	17 > 18	•

KAWASAKI

65 KX	00 >	•
636 ZX-6R ABS	13 >	•
998 NINJA H2 SX	18 >	•
1000 ZX 10 R	11 > 15	•
1000 ZX 10 R	16 >	•
1000 ZX 10 R (ABS)	11 > 15	•
1000 ZX 10 R SE	18 >	•
1000 ZX 10 R WINTER EDITION	16 >	•
1000 ZX 10 RR	17 >	•

SUZUKI

600 GSX-R	11 > 16	•
-----------	---------	---

750 GSX S	18 >	•
750 GSX-R	11 >	•
1000 GSX R	09 > 11	•
1000 GSX R	17 >	•
1000 GSX RR	17 >	•

YAMAHA

600 YZF R6	17 >	•
1000 MT 10	16 >	•
1000 YZF R1	15 >	•
1000 YZF R1 60th ANNIVERSARY	16 >	•
1000 YZF R1M SPECIAL EDITION	15 >	•





07H060.SP 101.6 x 39.9 x 9.4

2

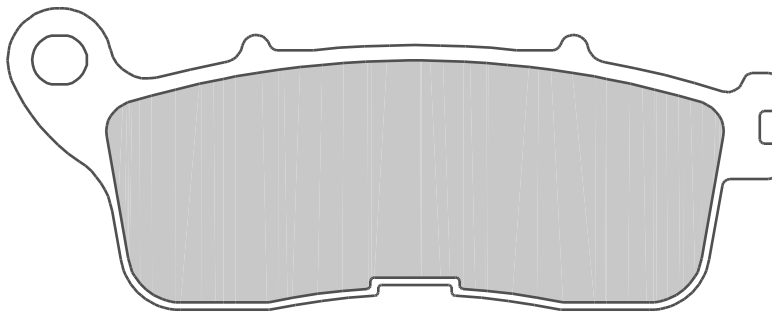
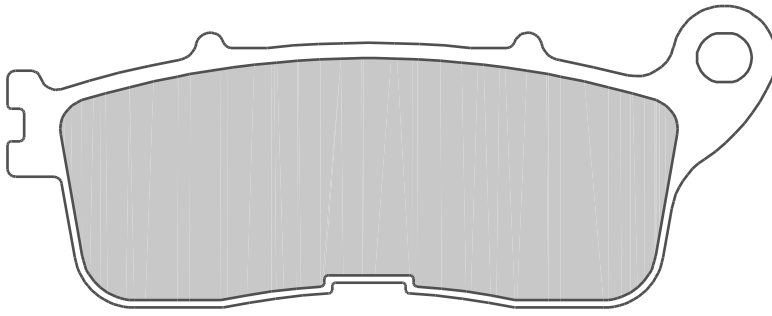

HONDA

1200 CROSSTOURER	12 >	•
1200 F W/DCT	10 >	•
1200 VFR FW	10 > 16	•
1237 VFR X CROSSTOURER	16 >	•



07H061.CC	88 x 40 x 10
------------------	--------------

07H061.SD	“ “ “
------------------	-------

07H061.SX	“ “ “
------------------	-------

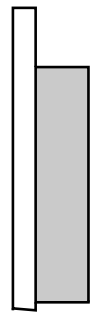
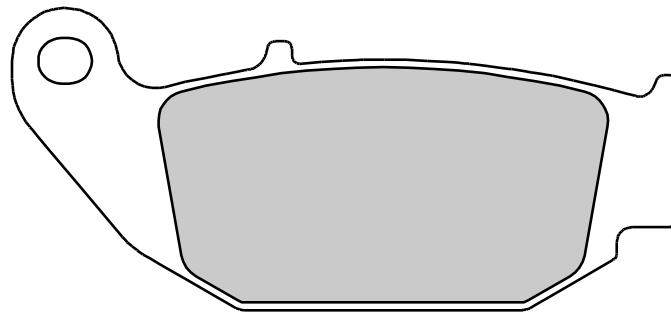
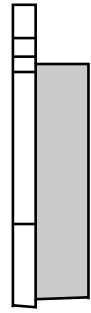
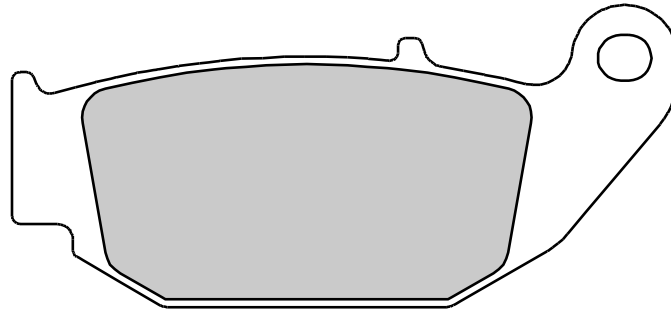

HONDA

125 CBR	12 >	•
125 CBR R	11 > 18	•
125 MSX	14 >	•
125 MSX GROM	14 >	•
250 CRF L	14 >	•
250 CRF L ABS	17 > 18	•
250 CRF RALLY	17 > 18	•
300 CB 300 R	18 >	•
400 ENDURO SPECIAL	18 >	•



07H062.SA 82.8 x 39.6 x 7.9

07H062.LA “ “ “

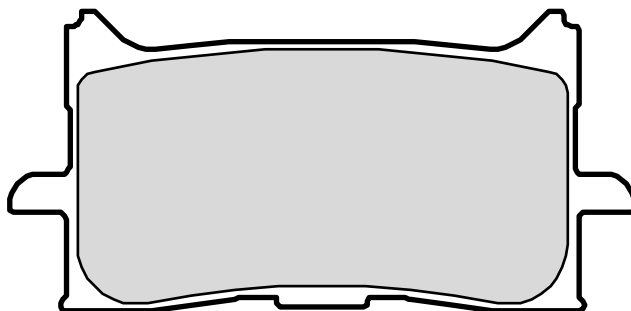

HONDA

300	CB 300 R	18 >	•
400	ENDURO SPECIAL	18 >	•
700	A-ADV	17 >	•
750	X ADV	17 > 18	•
1000	CRF L AFRICA TWIN	16 > 18	•
1000	CRF L AFRICA TWIN ADVENTURE SPORTS	18 >	•



07H063.SA 78 x 42.5 x 7.9

07H063.SC “ “ “

07H063.RC “ “ “

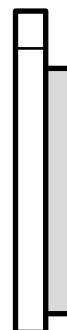
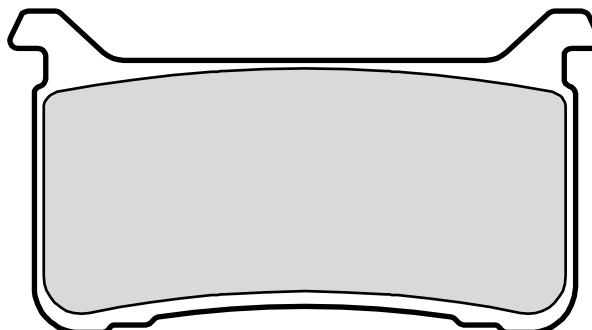

HONDA

1000	CB R+	18 >	•
1000	CBR RR ABS	17 >	•
1000	CBR RR FIREBLADE	17 > 18	•
1000	L ADVENTURE SPORTS	18 >	•
1100	CB RS ABS	17 > 18	•



07KA01.22

51 x 54.5 x 12.3

50.5 x 42.6 x 12.5

2

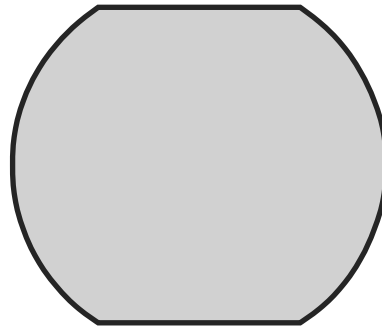
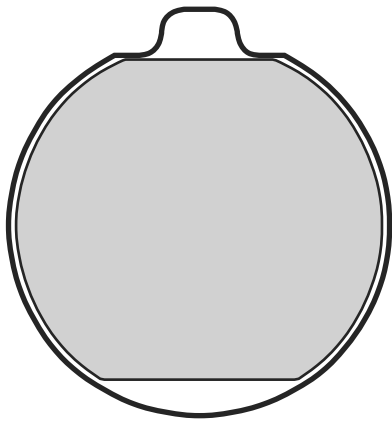

KAWASAKI

250	KH A1, 2, B4, 5	76 > 80	•
400	KH	76 > 78	•
400	KZ	74 > 77	•
400	Z B1, B2	78 > 79	•
400	Z C1	80 >	•
400	Z E, GL, H, H1	79 >	•
440	KZ	80 > 82	•
440	Z C	80 > 82	•
440	Z C, LTD	80 > 81	•

500	KH A, B	76 > 79	•
500	Z B1, B2	79 > 80	•
550	KZ A1	80 >	•
650	Z	77 > 79	•
650	Z B1, B2, B3	77 > 79	•
650	Z C	78 > 80	•
650	Z C1, C2, C3	78 > 79	•
650	Z D1, D1A, D2, D3	78 > 82	•
650	Z E1, F1 LTD	80 > 83	•
750	Z B1	76 > 79	•
750	Z LTD	80 > 81	•

900	KZ A4, A5	76 >	•
900	KZ B1, LTD	76 >	•
900	Z A	76 > 77	•
1000	Z A1, A2, A3, A4	77 > 80	•
1000	Z B1, B2, B3, LTD	77 > 79	•
1000	Z C1, C2, C3, C4	78 > 81	•
1000	Z D1, D2, D3, Z1R	78 > 80	•
1000	Z GL	80 >	•
1000	Z R	76 > 79	•
1000	Z, H1	80 >	•



**07KA02.23**

51 x 54.5 x 12.3
50.6 x 45 x 12.6

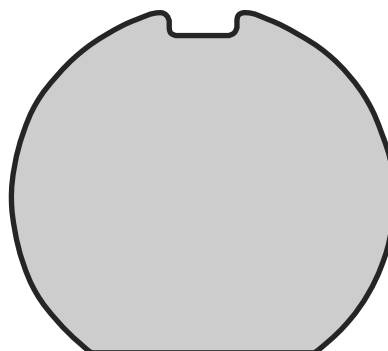
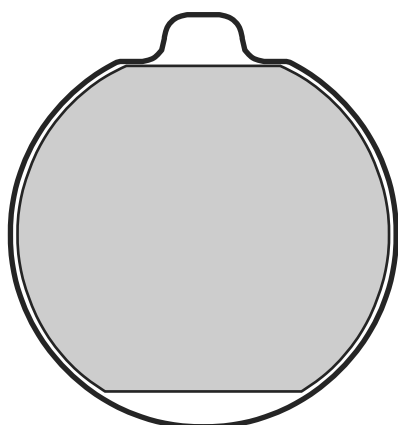
**KAWASAKI**

650	Z C1, C2, C3	78 > 79	•
750	Z B1	76 > 79	•
900	KZ B1, LTD	76 >	•
1000	Z B1, B2, B3, LTD	77 > 79	•

**07KA03.28**

51.6 x 50.7 x 16
51.6 x 50.7 x 13.4

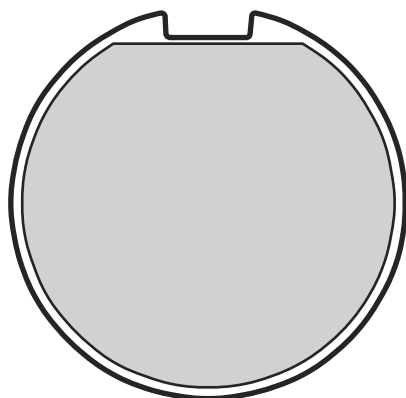
**KAWASAKI**

400	Z D,S	76 > 77	•
-----	-------	---------	---



07KA04.14

51 x 54.5 x 11

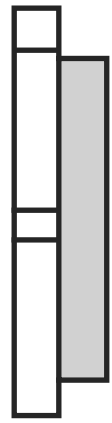
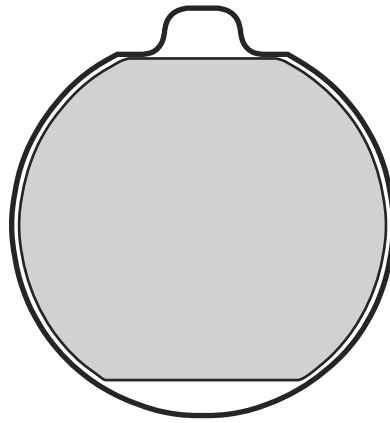

2



KAWASAKI

1300 Z	79 > 81	•
1300 Z A4, SPORTS	79 > 81	•
1300 Z DF1	84 > 89	•



07KA05.06

67.7 x 40.6 x 8

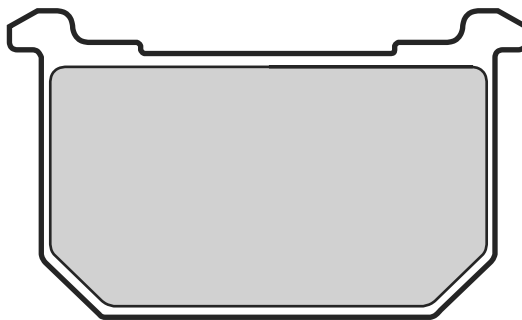

KAWASAKI

400 GPX	83 > 84	•	650 Z F	81 > 83	•	1000 Z J	79 >	•
400 Z J	81 >	•	700 Z A1, A1L	83 >	•	1000 Z K, CSR, M, LTD	81 >	•
400 Z T	83 >	•	750 GPZ	81 > 82	•	1000 Z MK2	79 >	•
440 Z H	82 >	•	750 Z A1, A1L	84 >	•	1000 Z P1, P2, POLICE	82 > 84	•
500 Z B3	81 > 83	•	750 Z E	80 > 81	•	1100 GPZ	81 > 86	•
550 Z C1, C2, LTD	80 > 81	•	750 Z H1, H2, LTD	80 > 81	•	1100 Z A1, B1, GP	81 >	•
550 Z D1, E, GP, LTD	81 >	•	750 Z L	80 > 83	•	1100 Z D1, D2, SPECTRE	82 > 83	•
550 Z LTD	81 >	•	750 Z LTD	82 >	•	1100 Z L1, LTD	83 >	•
650 Z D4, F2, F3, F4	81 > 83	•	750 Z Y1, LTD	82 >	•	1100 Z ST	81 >	•
			1000 KZ	87 > 01	•	1300 Z A4, SPORTS	82 > 89	•
			1000 Z F1	80 >	•			





07KA06.08

67.7 x 40.6 x 9.5

2

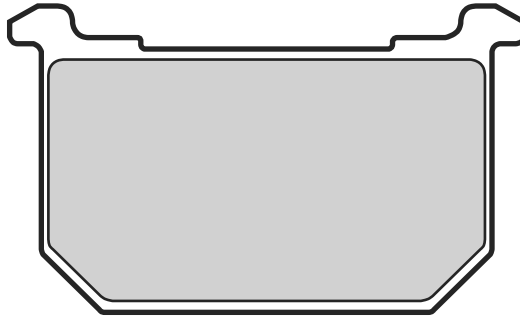

KAWASAKI

250 Z	78 > 80	•	550 Z D1, E, GP, LTD	81 >	•	750 Z M1	82 >	•
250 Z J	81 >	•	550 Z F1, F2, F2L	83 > 84	•	750 Z R1	82 >	• •
305 KZ	81 > 88	•	550 Z GT, LTD	82 >	•	750 Z Y1, LTD	82 >	•
305 Z	81 >	•	550 Z M1, LTD	83 >	•	1000 KZ	87 > 01	•
305 Z A1, A2, B1, B2, B3	81 > 82	•	650 Z H1, H2, H3, CSR	81 > 82	•	1000 Z J	79 >	•
400 GPX	83 > 84	•	700 Z A1, A1L	83 >	•	1000 Z K, CSR, M, LTD	81 >	•
440 KZ	83 >	•	750 GPZ	81 > 82	•	1000 Z P1, P2, POLICE	82 > 84	•
440 Z A4, A5, LTD	83 >	•	750 Z A1, A1L	84 >	•	1000 Z R1, R2	82 >	• •
440 Z H	82 >	•	750 Z E	80 > 81	•	1100 GPZ	81 > 86	•
440 Z LTD	83 >	•	750 Z GT, GPZ	82 >	• •	1100 Z A1, B1, GP	81 >	•
440 Z TWIN	81 >	•	750 Z H1, H2, LTD	80 > 81	•	1100 Z B2, GP	82 >	•
500 Z B3	81 > 83	•	750 Z L	80 > 83	•	1100 Z D1, D2, SPECTRE	82 > 83	•
550 Z A2, C3, LTD	81 > 82	•	750 Z L	84 >	• •	1100 Z L1, LTD	83 >	•
			750 Z L3	83 >	• •	1300 Z A4, SPORTS	82 > 89	•
			750 Z LTD	82 >	•			



07KA07.17 84.9 x 42.4 x 7
47.4 x 37 x 9

07KA07.SD “ “ “

07KA07.SX “ “ “

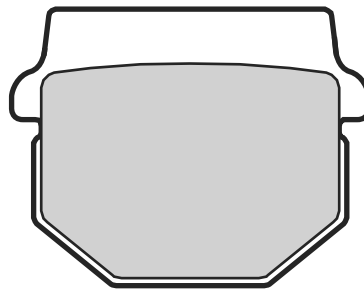
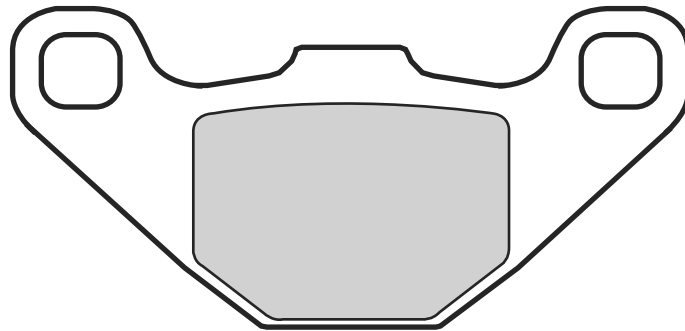

ADLY

150	ATV	05 >	• •
150	INTERCEPTOR	05 >	• •
300	ATV	05 >	• •

AEON

100	REVO 2	04 >	•
-----	--------	------	---

APRILIA

125	RS	17 >	•
125	RS-4	12 >	•
125	RX ENDURO	08 > 13	•
125	RX SUPERMOTARD	08 > 13	•
125	TUONO ABS	15 >	•

BENELLI

350	ZENZERO	12 >	•
-----	---------	------	---

BOMBARDIER-CAN AM

90	DS X	08 >	• •
200	RALLY 2X4	03 > 04	•
200	RALLY 2X4	05 > 06	•

CPI

50	BABY	02 >	•
250	XS QUAD	06 >	•

DAELIM

250	ST SECTOR QUAD	05 > 06	•
-----	----------------	---------	---

E-TON

250	ST VECTOR	06 >	•
250	VXL VECTOR	06 >	•
300	ST VORTEX	07 >	•
300	VTX VORTEX	07 >	•
300	VXL VECTOR, ST VECTOR	07 >	•

FANTIC MOTOR

125	CABALLERO MOTARD AIRCOOLED	10 >	•
-----	----------------------------	------	---

HERCULES

300	ATV SPORT	07 >	• •
-----	-----------	------	-----

HYOSUNG

110	KR MASTER	04 >	•
-----	-----------	------	---

KAWASAKI

50	AR	81 > 83	•
50	KMX	88 >	•
50	KSR I	90 >	• •
80	AR	81 > 83	•
80	KD	88 > 90	•
80	KSR II	90 >	• •
80	KX E, G, H, J	84 > 87	•
80	KX L, N, R	88 > 96	•
100	KX	88 > 96	•
125	KDX	90 >	•
125	KMX	86 > 86	•
125	KX	82 > 82	•
125	ZL ELIMINATOR	97 >	•
200	KMX	88 > 90	•
250	KXT A1 TECATE	84 >	•
570	KLR	88 >	•

MALAGUTI

50	CENTRO 4T	11 >	•
----	-----------	------	---



**PETERSON**

50	HURRICANE	95 >	•
50	SR	95 >	•
80	80 SR	95 >	•
80	HURRICANE	95 >	•

PGO

50	BIG MAX	03 >	•
50	X-RIDER	03 >	•
125	X-RIDER	03 >	•
150	X-RIDER	03 >	•

POLARIS

200	SAWTOOTH	06 >	• •
-----	----------	------	-----

RIEJU

50	RS2 NKD	06 >	•
50	RS2 PRO	10 >	•
50	RS3	10 >	•
125	RS2 NKD	06 >	•
125	RS2 PRO	08 >	•
125	STRADA	18 >	•

SUZUKI

80	RM L, M, N	90 > 95	•
80	RM T	96 >	•
85	RM	02 > 04	•
110	ADDRESS	15 >	•
125	UE	01 >	•
500	LT R	88 >	•

TGB

50	101 R	05 >	•
50	BULLET	09 >	•
50	RX	06 >	•

TM

80	JUNIOR	96 > 00	•
----	--------	---------	---

ZERO

6	ZF DS	10 > 12	•
6	ZF S	10 > 12	•
9	ZF DS	10 > 12	•



07KA08.08 110.7 x 50.9 x 9.4
68.7 x 43.3 x 9.8

07KA08.SA “ “ “

07KA08.SP “ “ “

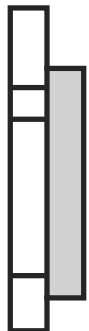
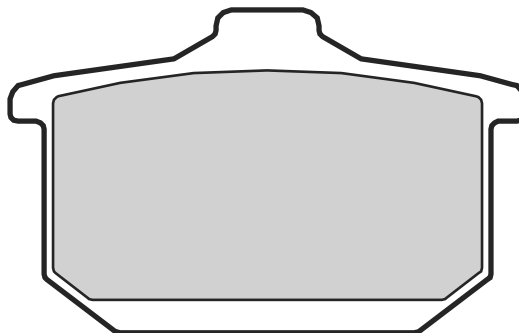
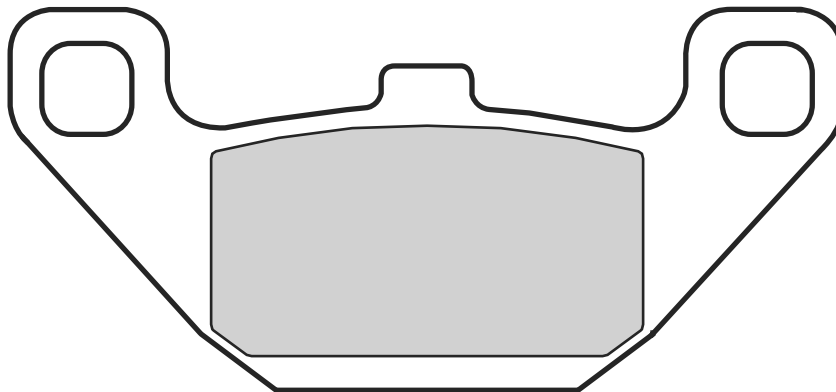

HYOSUNG

300 GA 98 > •

KAWASAKI

250 BR	86 > •
250 CS	86 > •
250 EL ELIMINATOR	88 > 94 •
250 EX R NINJA	86 > 87 • •
250 GPZ	83 > •
250 GPZ R	86 > • •
250 KR	85 > •
250 LX ELIMINATOR	90 > •
250 Z ELIMINATOR	88 > •
252 EL	97 > 00 •
305 EX	83 > •
305 GPZ	83 > •
400 ELIMINATOR	94 > •
400 EN TWIN	85 > •
400 FX R	86 > •
400 GPX	85 > 86 •
400 KLE VULCAN	90 > •
400 Z ELIMINATOR	88 > • •
400 ZX	85 > 85 •
400 ZX	86 > • •

450 EN	85 > 90 •
450 Z	84 > •
500 EN	90 > 98 •
500 GPZ S	87 > 87 •
500 GPZ S	88 > 92 •
550 GPZ	84 > • •
550 GT	85 > 89 •
550 KZ A1, A1L	84 > • •
550 Z F	85 > •
550 ZX	84 > • •
600 GPZ	83 > 93 • •
600 GPZ R	85 > • •
600 ZL	86 > •
600 ZX NINJA	85 > 87 • •
700 ZN A1, A1L	84 > • •
750 GPZ	83 > 87 • •
750 GT	86 > • •
750 VN TWIN	88 > •
750 VN VULCAN	86 > 96 •
750 VULCAN	93 > •
750 Z E1, E1L, TURBO	84 > • •
750 Z ELIMINATOR	88 > • •
750 Z K1, K2	83 > 84 • •
750 Z LTD, K1, TWIN	83 > • •
750 ZX A1, GP, E	83 > 85 • •

800 VN	95 > 95 •
900 GPZ R	84 > 89 • •
900 Z GPR	84 > • •
900 ZL ELIMINATOR	85 > • •
900 ZX A1, A1L	83 > 84 • •
1000 GPZ RX	86 > • •
1000 GTR	86 > 93 • •
1000 Z R NINJA	86 > • •
1000 ZG CONCOUR	86 > • •
1000 ZL	86 > • •
1100 GPZ	87 > 94 • •
1100 Z GP	83 > • •
1100 Z R, LTD	84 > • •
1100 ZN B1, B1L, LTD	84 > • •
1100 ZX A1, GP	83 > • •
1200 ZG	87 > 96 • •
1300 Z	85 > 89 • •
1300 Z 6	85 > 89 • •
1300 ZN A1, A2, A2L	83 > 84 • •
1300 ZN VOYAGER	85 > 89 • •
1500 VN CLASSIC	97 > •
1500 VN D1 VULCAN	87 > 96 • •
1500 VN SE	91 > • •
1500 VN SUMO	88 > • •





07KA09.33 141 x 41.7 x 8.5
95.2 x 34.6 x 9

07KA09.SA “ “ “

07KA09.SP “ “ “

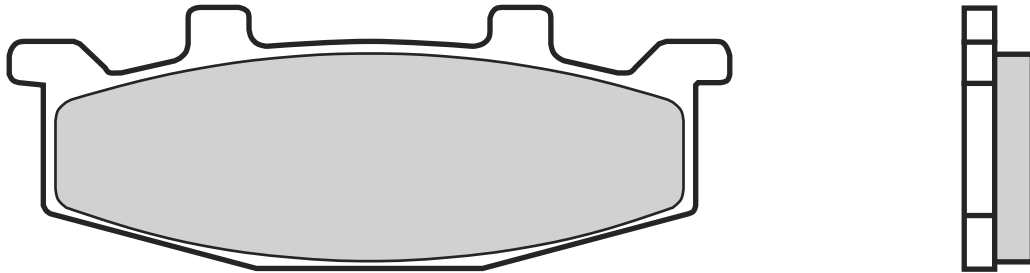
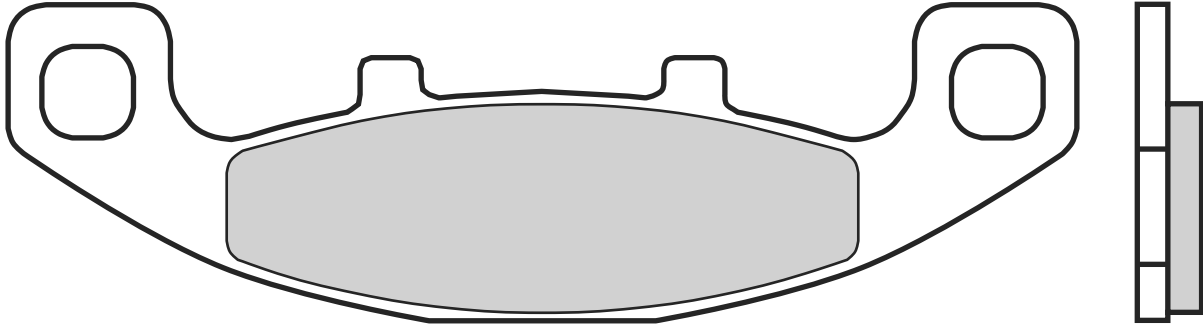

HYOSUNG

250	GT COMET	02 > 02	•
600	COMET	02 > 02	•

KAWASAKI

250	250 BALIUS	91 >	•
250	EX R NINJA	88 > 07	•
250	GPX R	88 >	•
250	ZZR R	90 >	•
400	ELIMINATOR	94 >	•
400	EX-4	95 >	•
400	GPX	87 >	•
400	GPZ S	88 >	•
400	KLE	91 >	•
400	LX ELIMINATOR	94 > 94	•
400	ZZ R	90 >	•
500	ER 5	97 > 00	•
500	EX	87 > 93	•
500	EX	94 > 96	•

500	KLE	91 > 98	•
550	ZR ZEPHYR	90 > 92	•
550	ZR ZEPHYR	93 > 95	•
600	GPX R	88 > 90	• •
600	GPZ	94 >	• •
600	ZL ELIMINATOR	95 > 98	•
600	ZX NINJA	88 > 95	• •
600	ZX-6	90 > 93	•
600	ZZR	90 > 92	•
650	KLR TENGAI	89 > 92	•
650	TENGAI	89 > 91	•
750	GPX R	86 > 87	• •
750	ZEPHYR	91 >	•
750	ZR ZEPHYR	91 > 95	•
750	ZR ZEPHYR left caliper	96 >	•
750	ZX 7 R	93 > 95	•
900	GPZ R	90 > 99	•
1000	GTR	94 > 97	• •
1000	GTR	98 >	•
1000	ZX 10	88 >	• •

1100	ZEPHYR left caliper	97 >	•
1100	ZR ZEPHYR	92 > 96	•
1100	ZZR	90 > 93	•

SUZUKI

50	LIDO	91 >	•
125	RG WOLF	92 >	•
200	WOLF	92 >	•
250	ACROSS	90 >	•
250	DJEBEL	93 >	•
250	GSF BANDIT	90 > 93	•
250	GSX S, KATANA	91 > 99	•
250	SW1	92 >	•
400	GSF BANDIT	91 > 92	•
450	GS	90 >	• •
500	GS E	89 > 96	•
800	DR BIG	91 > 95	•
800	DR S	91 > 95	•
800	VX	90 > 93	•
1100	GSX G	94 > 96	•



07KA10.TT

73.4 x 49 x 6.7
60.9 x 62.9 x 9

2

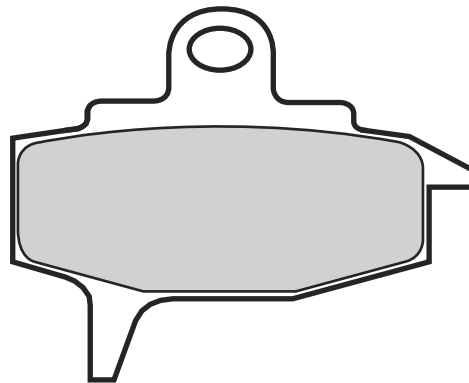
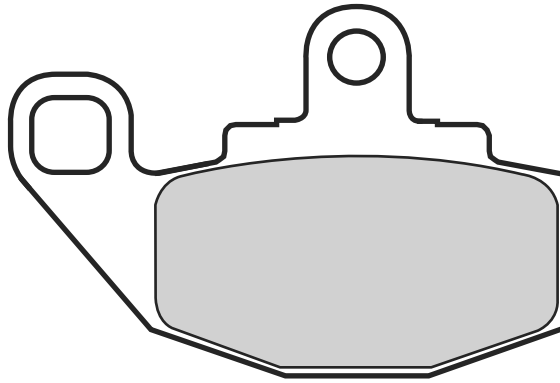

KAWASAKI

125 KX	87 > 88	•
250 KX	87 > 88	•
500 KX	87 > 88	•
650 KLR	87 > 89	•





07KA11.17 106.1 x 38.7 x 7.6
76.2 x 27 x 9.6

07KA11.SA “ “ “

07KA11.SP “ “ “

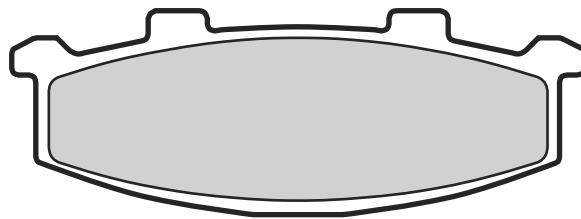
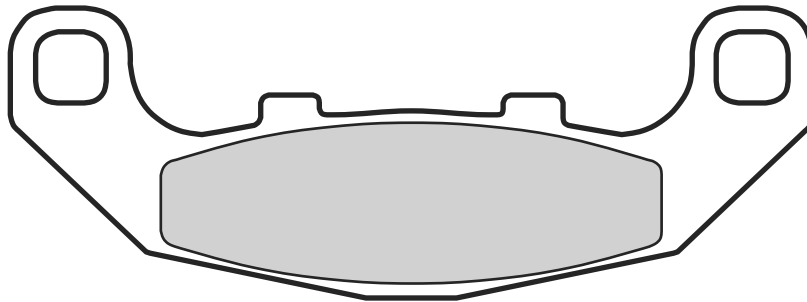

2



KAWASAKI

250 EX R NINJA	88 > 07	•
250 GPX R	88 >	•
250 KR-1	88 > 89	• •
250 KR-1 S	90 >	•
250 ZZR R	89 > 89	• •

400 GPX	87 >	•
400 XANTHUS	92 >	•
400 ZX 4	88 > 89	• •
500 EX E1-E3	94 > 96	• •
500 GPZ S	97 >	•
550 ZR ZEPHYR	90 > 92	•

750 ZR ZEPHYR	91 > 95	•
---------------	---------	---

SUZUKI

250 RGV GAMMA	91 > 92	•
1100 GSX G	94 > 96	•



07KA12.SD	62 x 40.7 x 8.7
------------------	-----------------

07KA12.SX	“ “ “
------------------	-------

07KA12.TT	“ “ “
------------------	-------

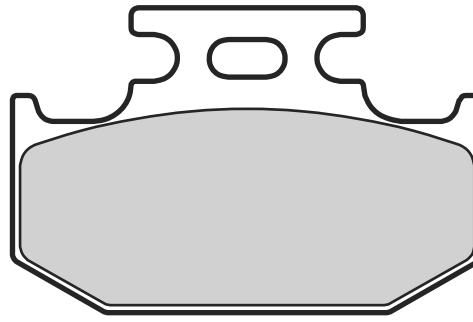

CANNONDALE

400 MX	00 >	•
--------	------	---

KAWASAKI

125 KDX	90 >	•
125 KX	89 > 93	•
125 KX	94 > 94	•
200 KDX	93 > 93	•
200 KDX	94 > 97	•
200 KDX SR	89 > 92	•
220 KDX	97 >	•
250 KDX D, SR	91 > 94	•
250 KLX	93 > 96	•
250 KX	89 > 93	•
250 KX	94 > 94	•



500 KX	89 > 93	•
500 KX	94 > 95	•
650 KLX R	93 > 95	•

SUZUKI

125 RM X	89 > 90	•
125 TS R	89 >	•
200 TS R	90 >	•
250 DR S	90 > 95	•
250 RM	89 > 90	•
250 RM	91 > 95	•
350 DR, S	92 >	•

YAMAHA

50 FZR	92 >	•
--------	------	---



80 YD	89 >	•
125 DT X SUPERMOTARD	05 > 06	•
125 WR	91 > 97	•
125 YZ	90 > 95	•
200 DT WR	91 >	•
200 WR	91 > 94	•
250 TRICKER	05 >	•
250 TT R	93 >	•
250 TY Z SCOTTISH	96 >	•
250 WR	90 > 90	•
250 WR	92 > 97	•
250 YZ	90 > 91	•
350 TT	95 >	•
500 WR	92 > 93	•
600 TT	93 >	•



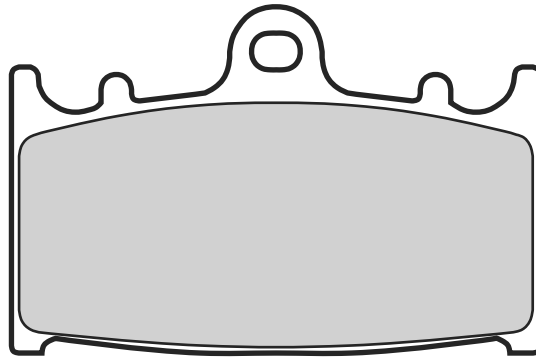

07KA13.06	69.7 x 46.2 x 8.1
07KA13.SA	“ “ “
07KA13.LA	“ “ “
07KA13.SC	“ “ “
07KA13.RC	“ “ “

**HUSABERG**

400 FS SUPERMOTARD	01 >	•
450 FSC SUPERMOTARD	03 > 09	•
450 FSE SUPERMOTARD	03 > 09	•
650 FSC SUPERMOTARD	01 > 08	•
650 FSE SUPERMOTARD	01 > 08	•

KAWASAKI

250 KR-1 S	90 >	•
400 ZX 4	90 >	•
400 ZXR	89 > 90	•
400 ZZ R	90 >	•
500 GPZ S	93 > 94	•
600 GPZ NINJA	89 > 93	•
600 GPZ R	89 > 93	•
600 ZX-6	90 > 93	•
600 ZX-6R	93 > 97	•
600 ZZR	90 > 92	•
600 ZZR	93 >	•
750 ZX 7 R	93 > 95	•
750 ZX-7 NINJA	89 > 94	•

750 ZXR

89 > 92 •

750 ZXR R

93 > 95 •

900 GPZ R

90 > 99 •

900 ZX 9R

94 > 95 •

1000 VERSYS

17 > •

1000 VERSYS LT

15 > •

1100 ZR ZEPHYR

92 > 96 •

1100 ZX 11 R

93 > 96 •

1100 ZZR

90 > 93 •

1100 ZZR

94 > 01 •

1200 ZZR

02 > 05 •

1700 VN 1700 VOYAGER

09 > •

2000 VN

04 > 06 •

2000 VN VULCAN

04 > 06 •

SUZUKI

125 RG	92 >	•
125 RG F	92 >	•
125 RG GAMMA	92 > 96	•
200 RG GAMMA	91 >	•
250 COBRA	89 > 90	•
250 GSX-R S	89 >	•

250 RGV GAMMA

91 > 92 •

250 RGV GAMMA

93 > •

250 RGV K

89 > 90 •

250 TV J

88 > •

350 GOOSE

92 > •

400 GSF BANDIT

93 > 93 •

400 GSX S, KATANA

92 > 99 •

400 GSX-R

88 > 90 •

400 SE

92 > •

600 GSR

06 > 11 •

600 GSX-R

97 > 03 •

650 GSF ABS

07 > •

650 GSF S ABS

07 > •

650 GSX F

08 > •

750 GSX-R

00 > 03 •

1000 SV

03 > •

1000 SV S

03 > •

1000 TL S

97 > •

1250 GSF ABS

07 > •

1250 GSF S ABS

07 > •

1250 GSX F

10 > •

1250 GSX FA

10 > •

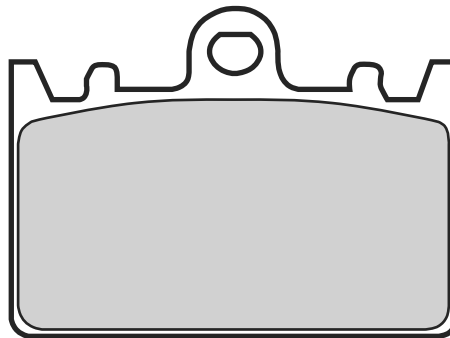

07KA14.06	58.9 x 43.6 x 7.9
07KA14.SA	“ “ “
07KA14.SC	“ “ “

**KAWASAKI**

400 ZXR R	91 > 02	•
-----------	---------	---



07KA15.CC 133.5 x 37.4 x 10.9
109.2 x 44.4 x 10.9

07KA15.SP “ “ “

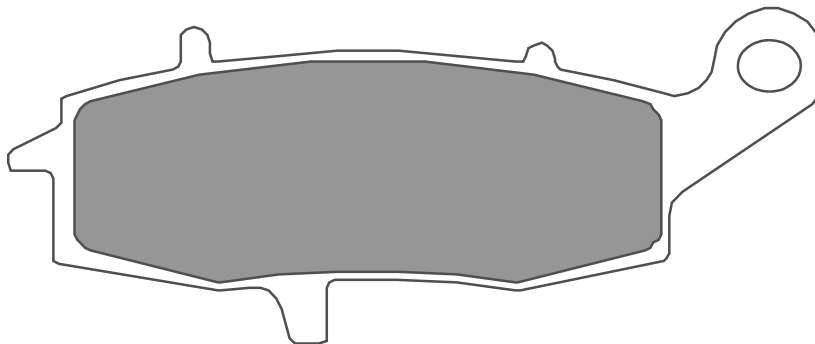
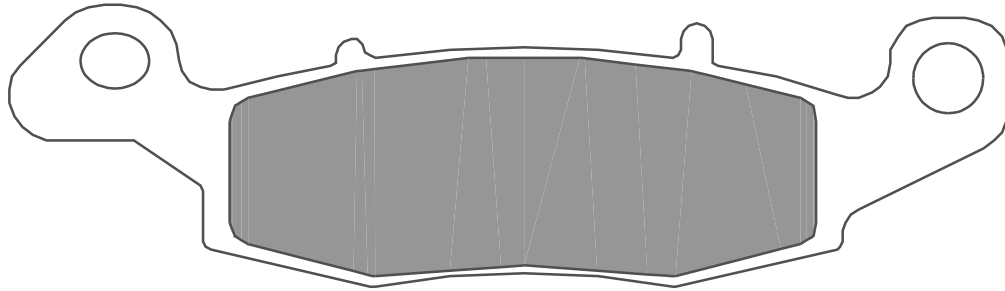

KAWASAKI

900 CLASSIC SE	11 >	•
900 VN CLASSIC	06 >	•
900 VN CUSTOM	07 >	•
1500 VN CLASSIC FI	00 >	•
1500 VN CLASSIC TOURER FI left caliper	00 >	•
1500 VN DRIFTER	99 > 05	•

1500 VN MEAN STREAK	02 > 03	•
1600 VN CLASSIC left caliper	03 >	•
1600 VN MEAN STREAK	04 > 04	•
1600 VN MEAN STREAK	05 >	•
1700 VN 1700 VOYAGER	09 >	•
1700 VN CLASSIC left/rear	09 >	•
1700 VN CLASSIC TOURER left/rear	09 >	•

2000 VN	04 > 06	•
2000 VN VULCAN	04 > 06	•

SUZUKI

1500 INTRUDER M ()	09 > 12	•
1600 M INTRUDER	05 >	•
1600 VZ MARAUDER	04 >	•





07KA16.17

89.5 x 51.2 x 8.9

68 x 52.6 x 9.9

07KA16.SP

“ “ “

2

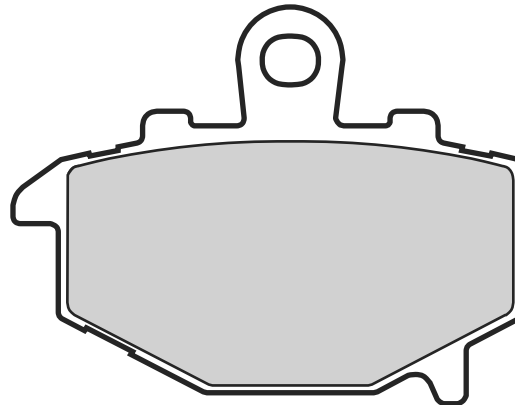
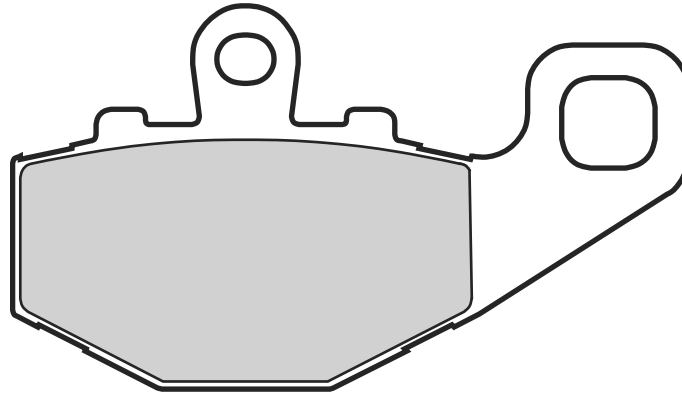

KAWASAKI

400 NINJA R RIGHT CALIPER	11 >	•	650 ER-6F ABS left/rear	16 >	•	1000 Z	10 >	•
550 ZR ZEPHYR	93 > 95	•	650 ER-6F left/rear	06 > 15	•	1000 Z (RAD. CAL)	10 > 13	•
600 ZX-6R	93 > 97	•	650 ER-6N ABS left/rear	16 >	•	Z 1000 SUGOMI		
600 ZX-6R	98 > 02	•	650 ER-6N left/rear	06 > 15	•	1000 EDITION	16 >	•
600 ZX-6R	03 > 04	•	650 R NINJA LEFT CALIPER	06 >	•	1000 Z R	17 >	•
600 ZX-6R	07 >	•	750 Z 750 left caliper	04 > 06	•	1000 Z SX	11 >	•
600 ZX-6RR	05 > 06	•	750 Z 750 S left caliper	04 >	•	1000 Z SX ABS	11 >	•
600 ZZR	93 >	•	900 ZX 9R	94 > 95	•	1000 ZX 10 R	04 > 07	•
636 ZX-6R	05 > 06	•	900 ZX 9R	96 > 97	•	1000 ZX 10 R	08 > 10	•
636 ZX-6R	13 >	•	900 ZX 9R	98 > 98	•	1000 ZX 10 R (ABS)	08 > 10	•
636 ZX-6RR	02 > 02	•	900 ZX 9R	99 > 01	•	1100 GPZ ABS left caliper	97 >	•
636 ZX-6RR	03 > 04	•	900 ZX 9R	02 >	•	1100 GPZ left caliper	95 > 96	•
			1000 GTR	98 >	•	1100 ZR ZEPHYR left caliper	97 >	•
			1000 Z	03 > 06	•			

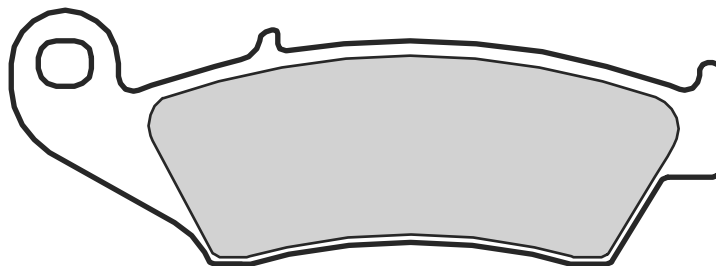
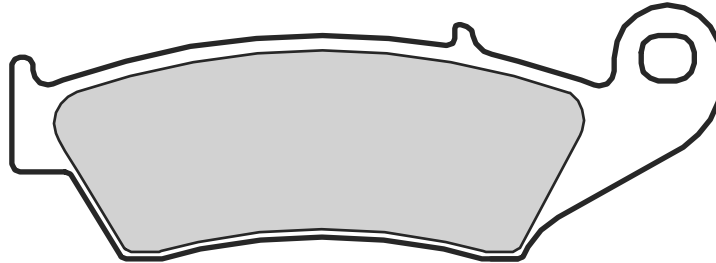

07KA17.05	94.2 x 34.2 x 7.2
07KA17.LA	“ “ “
07KA17.SD	“ “ “
07KA17.SX	“ “ “
07KA17.TT	“ “ “

**APRILIA**

450 MX V	09 >	•
450 RXV	06 > 14	•
550 RXV	06 > 14	•

BETA

125 RR 2T	18 >	•
250 RR	05 >	•
250 RR ENDURO	05 >	•
300 RR CROSSTRAINER	15 >	•
300 RR EFI	15 >	•
300 RR EFI RACING	15 >	•
300 RR ENDURO	13 >	•
350 RR ENDURO	12 >	•
390 RR	15 >	•
400 RR	05 >	•
400 RR ENDURO	05 >	•
430 RR	15 >	•
430 RR RACING	15 >	•
450 RR	05 >	•
450 RR CROSS COUNTRY	12 >	•
450 RR ENDURO	05 >	•
480 RR	15 >	•
480 RR RACING	15 >	•

498 RR ENDURO	12 >	•
525 RR	05 > 09	•
525 RR ENDURO	05 >	•

BIMOTA

300 BBX ENDURO	12 >	•
508 BBX ENDURO	12 >	•

CANNONDALE

400 MX	00 >	•
--------	------	---

FANTIC MOTOR

50 MX REGOLARITÀ CASA	08 >	•
50 MX REGOLARITÀ COMPETIZIONE	08 >	•
50 SUPERSEI MOTARD	08 >	•
65 MX REGOLARITÀ COMPETIZIONE	08 >	•
85 MX REGOLARITÀ COMPETIZIONE	08 >	•
125 CABALLERO ENDURO	12 >	•
125 MX REGOLARITÀ CASA	08 >	•
125 SUPERSEI MOTARD	08 >	•

GAS GAS

125 EC	00 >	•
125 MC	03 >	•
200 EC	00 > 16	•
200 EC	17 >	•
200 HOBBY	07 >	•
200 XC 200	18 >	•
250 EC	00 > 11	•
250 EC	12 >	•
250 EC	18 >	•
250 ENDURO GP 18	18 >	•
250 MC	00 >	•
250 XC	17 >	•
300 EC	00 > 11	•
300 EC	12 >	•
300 EC	18 >	•
300 ENDURO GP 18	18 >	•
300 XC	18 >	•
400 EC	02 >	•
400 PAMPERA	06 >	•
450 EC	03 >	•
450 FSE EC	03 >	•
450 FSR	07 >	•
500 FSE EC	06 >	•
515 FSR	08 >	•



**HM**

125 CR SUPERMOTARD	04 >	•
125 CRE ENDURO	95 > 01	•
125 CRE R ENDURO	02 > 03	•
125 CRE SIX COMPETITION	11 >	•
125 CRE SUPERMOTARD	03 >	•
125 SUPERMOTARD	00 >	•
250 CRE ENDURO	95 > 01	•
250 CRE F ENDURO	04 >	•
250 CRE FX	08 > 11	•
250 CRE R ENDURO	02 >	•
250 CRE SUPERMOTARD	03 > 03	•
250 CRE SUPERMOTARD	04 >	•
250 CRE X	04 >	•
250 CRE X ENDURO	04 > 09	•
250 CRF X SUPERMOTARD	04 >	•
250 SUPERMOTARD	00 >	•
450 CRE F ENDURO	02 >	•
450 CRE X ENDURO	04 >	•
450 CRF F SUPERMOTARD	04 >	•
450 CRF R	04 > 09	•
450 CRF SUPERMOTARD	02 >	•
450 CRF X SUPERMOTARD	04 >	•
490 CRM F SUPERMOTO	07 > 07	•

HONDA

125 CR E	02 >	•
125 CR R	02 >	•
125 CR RK	95 > 01	•
125 CRF F	14 >	•
150 CRF	03 >	•
200 CTX	04 >	•
230 CRF	04 >	•
230 SL	97 >	•
250 CR E	02 >	•
250 CR R	95 > 01	•
250 CR R	02 >	•
250 CRE F	04 >	•
250 CRE X	04 >	•
250 CRF R	04 >	•
250 CRF R EFI	18 >	•
250 XLR R, SPL	94 >	•
250 XR R, L, S	94 >	•
300 XR	10 >	•
400 XR	96 >	•
400 XR SUPERMOTARD	00 >	•
440 XR R	00 >	•

450 CRE F	02 >	•
450 CRF R	09 >	•
450 CRF R EFI	17 > 18	•
450 CRF RX EFI	17 > 18	•
450 CRF X	05 >	•
450 CRF, E	02 >	•
450 ENDURO SUPERMOTO	18 >	•
450 TRX X	04 >	•
500 CR	95 > 01	•
600 XL V TRANSALP	97 > 99	•
600 XR R	93 >	•
600 XR R DAKAR	93 >	•
650 XL V TRANSALP	00 >	•
650 XR L	93 >	•
650 XR R	00 >	•
700 TRX XX	08 >	•
700 XL TRANSALP	08 >	•
750 XRV AFRICA TWIN	93 > 02	•

KAWASAKI

125 KX	94 > 94	•
125 KX	95 >	•
200 KDX	94 > 97	•
220 KDX	97 >	•
250 KLX	93 > 96	•
250 KLX	98 >	•
250 KX	94 > 94	•
250 KX	95 >	•
250 KX F	04 >	•
300 KLX	97 >	•
400 KLX R/SR	03 >	•
450 KLX R	07 >	•
450 KX F	06 >	•
500 KX	94 > 95	•
500 KX	96 > 03	•
650 KLX R	93 > 95	•
650 KLX R	96 > 98	•

SUZUKI

125 DR SM	08 >	•
125 RM T	96 > 05	•
250 DR Z	01 >	•
250 RM T	96 > 05	•
250 RM Z	04 >	•
250 RMX	99 >	•
250 RMX T	96 > 98	•
350 DR V, M, X	97 >	•
400 DRZ E	00 > 04	•

400 DRZ S	00 > 04	•
400 DRZ SM	05 >	•
450 RM-Z	05 >	•
450 RM-Z EFI	08 >	•
450 RMX Z	10 >	•
450 RMX Z efi	17 >	•
650 DR SE T-W	96 > 98	•

YAMAHA

125 WR	98 > 08	•
125 YZ	98 > 02	•
125 YZ	03 > 07	•
250 WR	98 > 02	•
250 WR F	01 > 02	•
250 WR F	03 > 17	•
250 WR R	08 >	•
250 YZ	98 > 02	•
250 YZ	03 > 07	•
250 YZ F	01 > 02	•
250 YZ F	03 > 06	•
400 WR F	98 > 98	•
400 WR F	99 > 00	•
400 YZ F	98 > 98	•
400 YZ F	99 > 02	•
426 WR F	01 > 02	•
426 YZ F	00 > 02	•
450 F ENDURO GP	18 >	•
450 WR F	03 >	•
450 YZ F	03 > 07	•

ZERO

2.8 ZF FX	13 > 13	•
2.8 ZF FX	14 > 14	•
2.8 ZF MX	13 > 13	•
2.8 ZF XU	13 > 13	•
5.7 ZF FX	13 > 13	•
5.7 ZF FX	14 > 14	•
5.7 ZF MX	13 > 13	•
5.7 ZF XU	13 > 13	•
8.5 ZF DS	13 > 13	•
8.5 ZF DS	14 > 14	•
8.5 ZF S	13 > 13	•
8.5 ZF S	14 > 14	•
11.4 ZF DS	13 > 13	•
11.4 ZF DS	14 > 14	•
11.4 ZF S	13 > 13	•
11.4 ZF S	14 > 14	•
11.4 ZF SR	14 > 14	•



07KA18.07 133.5 x 37.4 x 8.3
109.2 x 44.4 x 8.3

07KA18.SA “ “ “

07KA18.LA “ “ “

07KA18.SP “ “ “

07KA18.SC “ “ “

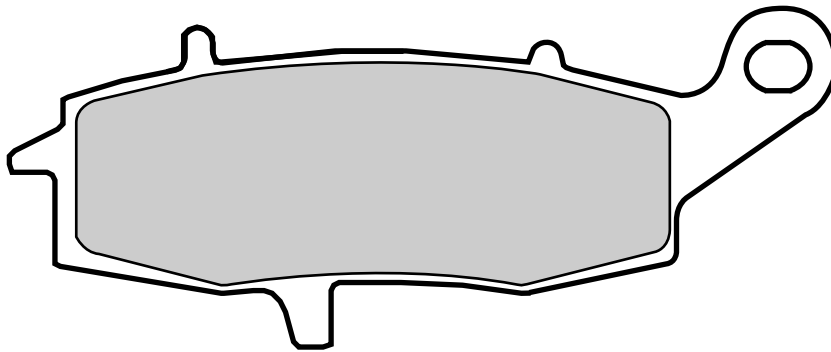
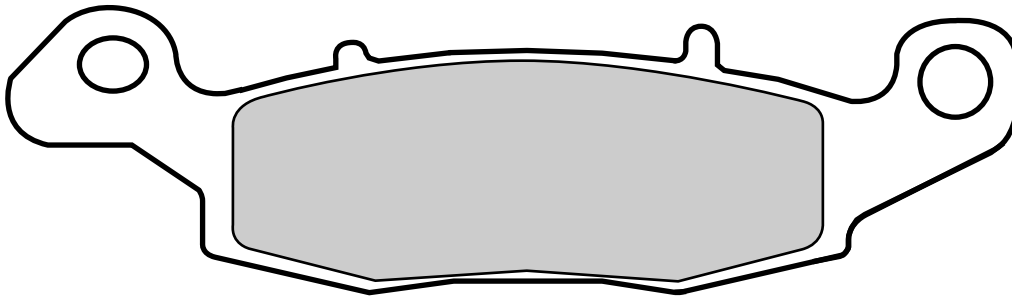

KAWASAKI

400 NINJA R RIGHT CALIPER	11 >	•
650 ER-6F ABS right	16 >	•
650 ER-6F right	06 > 15	•
650 ER-6N ABS right	16 >	•
650 ER-6N right	06 >	•
650 R NINJA RIGHT CALIPER	06 >	•
650 W	99 > 05	•
750 Z 750 right caliper	04 > 06	•
750 Z 750 S right caliper	04 >	•
750 ZR 7 right caliper	99 >	• •
750 ZR 7S right caliper	01 >	• •
750 ZR ZEPHYR right caliper	96 >	•
800 VN	96 > 97	•
800 VN DRIFTER	99 > 02	•
800 W	11 >	•
1000 KLV right caliper	04 >	•
1100 GPZ ABS right caliper	97 >	•
1100 GPZ right caliper	95 > 96	•
1100 ZEPHYR right caliper	97 >	•
1100 ZR ZEPHYR right caliper	97 >	•
1500 VN	02 >	•

1500 VN CLASSIC TOURER FI right caliper	00 >	•
1500 VN CLASSIC TOURER left caliper	98 >	•
1500 VN CLASSIC TOURER right caliper	98 >	•
1500 VN NOMAD left/rear	00 >	•
1500 VN NOMAD right	00 >	•
1600 VN	04 >	•
1600 VN CLASSIC right caliper	03 >	•
1600 VN CLASSIC TOURER	05 >	•
1700 VN CLASSIC right	09 >	•
1700 VN CLASSIC TOURER right	09 >	•

SUZUKI

125 VAN VAN	03 >	•
500 GS	04 >	•
500 GS E	96 > 03	•
500 GS F	04 >	•
600 GSF BANDIT S	00 > 04	•
600 GSX BANDIT	00 >	•

600 GSX FW	98 >	•
650 DL V STROM	04 >	•
650 DL V STROM (right)	04 >	•
650 DL V STROM XT (right)	15 >	•
650 GLADIUS	09 >	•
650 GSF BANDIT	05 >	•
650 GSF BANDIT S	05 >	•
650 SV	03 > 08	•
650 SV S	99 > 02	•
650 SV X RIGHT	18 >	•
650 XF FREEWIND	97 >	•
750 GSR	11 >	•
750 GSX FW	98 > 02	•
800 INTRUDER M, C	05 >	•
800 VL INTRUDER	01 > 04	•
800 VZ MARAUDER	97 > 04	•
1000 DL V STROM	02 > 13	•
1100 GSX G	96 >	•
1500 C INTRUDER (RIGHT CALIPER)	05 > 10	•
1500 VL INTRUDER	02 >	•
1600 M95 BOULEVARD	05 >	•
1800 VRZ INTRUDER	06 >	•





07KA19.07 133.5 x 37.4 x 8.3
109.2 x 44.4 x 8.3

07KA19.SA “ “ “

07KA19.LA “ “ “

07KA19.SC “ “ “

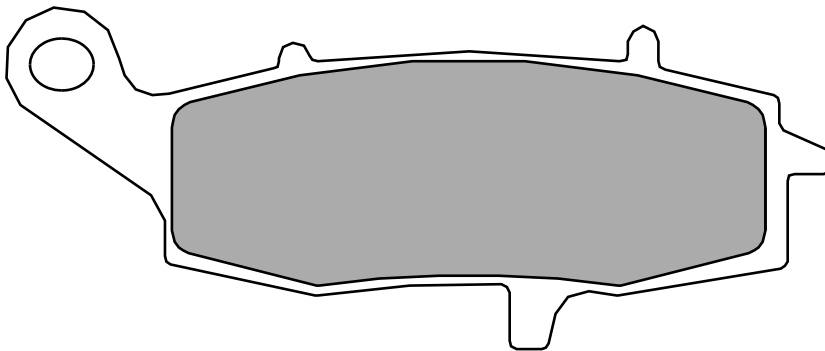
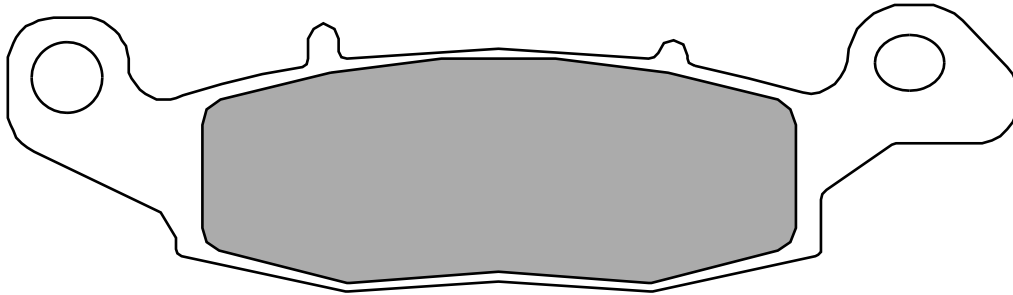

KAWASAKI

400 NINJA R RIGHT CALIPER	11 >	•
500 ER 5	01 >	•
650 ER-6F ABS left/rear	16 >	•
650 ER-6F left/rear	06 > 15	•
650 ER-6N ABS left/rear	16 >	•
650 ER-6N left/rear	06 > 15	•
650 KLR	95 > 04	•
650 R NINJA LEFT CALIPER	06 >	•
750 Z 750 left caliper	04 > 06	•
750 Z 750 S left caliper	04 >	•
750 ZR 7 left caliper	99 >	•
750 ZR 7S left caliper	01 >	•
750 ZR ZEPHYR left caliper	96 >	•
800 VN CLASSIC	98 >	•
800 VN DRIFTER	99 > 02	•
900 CLASSIC SE	11 >	•
900 VN CLASSIC	06 >	•
900 VN CUSTOM	07 >	•
1000 KLV left caliper	04 >	•
1100 GPZ ABS left caliper	97 >	•

1100 GPZ left caliper	95 > 96	•
1100 ZEPHYR	97 >	•
1100 ZEPHYR left caliper	97 >	•
1100 ZR ZEPHYR left caliper	97 >	•
1500 VN CLASSIC	97 >	•
1500 VN CLASSIC FI	00 >	•
1500 VN CLASSIC TOURER FI left caliper	00 >	•
1500 VN CLASSIC TOURER left caliper	98 >	•
1500 VN DRIFTER	99 > 05	•
1500 VN NOMAD left/rear	00 >	•
1600 VN CLASSIC left caliper	03 >	•
1700 VN CLASSIC left/rear	09 >	•
1700 VN CLASSIC TOURER left/rear	09 >	•

SUZUKI

200 VAN VAN	16 >	•
250 GSF BANDIT	95 >	•
400 GSF BANDIT	94 >	•

600 GSF BANDIT S	00 > 04	•
600 GSX BANDIT	00 >	•
600 GSX FW	98 >	•
650 DL V STROM	04 >	•
650 DL V STROM XT (left/rear)	15 >	•
650 GLADIUS	09 >	•
650 GSF BANDIT	06 > 11	•
650 GSF BANDIT S	06 > 11	•
650 SV	03 > 08	•
650 SV S	99 > 02	•
650 SV X LEFT/REAR	18 >	•
750 GSR	11 > 16	•
750 GSX FW	98 > 02	•
800 DR ST BIG	96 >	•
1000 DL V STROM	02 > 13	•
1100 GSX G	96 > 96	•
1500 C INTRUDER (LEFT CALIPER)	05 > 10	•
1500 INTRUDER M ()	09 > 12	•
1500 INTRUDER M (RIGHT)	09 > 12	•
1500 VL INTRUDER	02 >	•



07KA20.09 91.6 x 51.4 x 8.2

07KA20.SA “ “ “

07KA20.SC “ “ “

07KA20.RC “ “ “

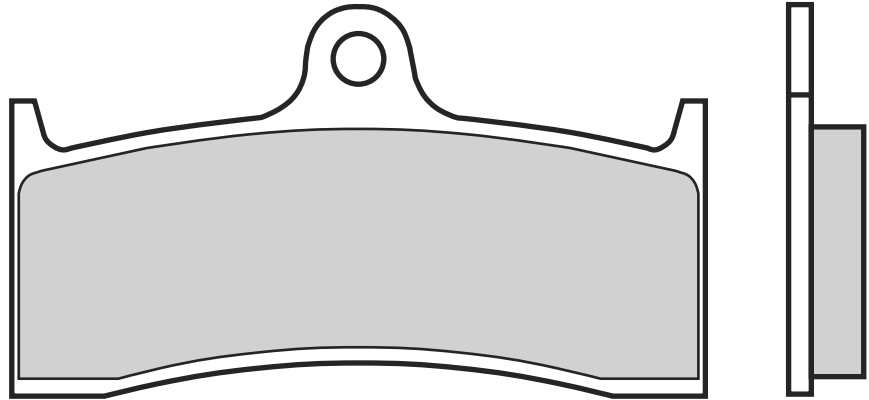

BUELL

1200 M2	98 > 02	•
1200 M2 CYCLONE	98 > 02	•
1200 RS X1	98 >	•
1200 S1 LIGHTNING	98 > 02	•
1200 S1 WHITELIGH TWING	98 > 02	•
1200 S3 THUNDERBOLT	98 > 02	•
1200 S3T THUNDERBOLT	98 > 02	•
1200 X1	01 > 02	•

HONDA

1300 CB SF	98 >	•
------------	------	---



KAWASAKI

750 ZX-7 RR	96 > 02	•
900 ZX 9R	98 > 98	•

MV AGUSTA

750 BRUTALE	03 > 10	•
750 BRUTALE AMERICA	04 >	•
750 BRUTALE GLADIO	05 >	•
750 BRUTALE MAMBA	05 >	•
750 BRUTALE ORO	02 >	•
750 BRUTALE S	02 >	•
750 F4	00 > 04	•



750 F4 AGO	03 >	•
750 F4 SPR	03 >	•
910 BRUTALE S	04 >	•
1000 F4 CORSE	05 >	•
1000 F4 MAMBA	03 >	•
1000 F4 S, 1+1	04 >	•
1000 F4 TAMBURINI	04 >	•





07KA21.07

59.7 x 57.1 x 8

07KA21.SP

“ “ “

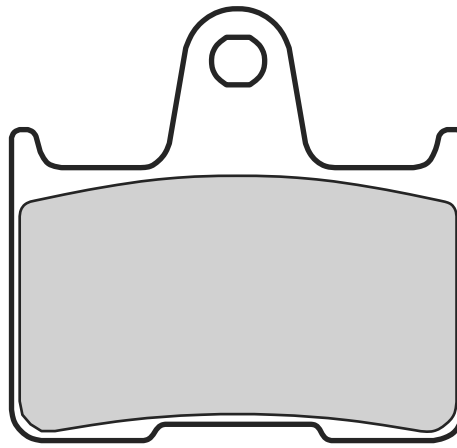

2



HARLEY DAVIDSON

883	XL 883 R ROADSTER	14 >	•
883	XL L SUPER LOW	14 >	•
883	XL N IRON	14 >	•
883	XL N IRON DARK CUSTOM	16 >	•
883	XL R ROADSTER	14 >	•
1200	XL C SPORTSTER CUSTOM	14 >	•
1200	XL CA SPORTSTER CUSTOM	14 >	•
1200	XL CB SPORTSTER CUSTOM	14 >	•
1200	XL CP SPORTSTER CUSTOM	14 >	•

1200 XL CX

17 >



1200 XL ROADSTER

18 >



1200 XL T SUPER LOW

15 >



1200 XL V SEVENTY-TWO

14 >



1200 XL X FORTY EIGHT

14 >



HONDA

750 VT C2S ABS

13 >



750 VT CS ABS

13 >



1300 CB R

02 >



1300 CB SF

98 >



1300 CB X-4

97 >



KAWASAKI

750 ZX-7 RR

96 > 02



1400 GTR

07 > 16



1400 ZZR

06 >



1400 ZZR ABS

06 > 15



1400 ZZR ABS

16 >



1400 ZZR PERFORMANCE
SPORT

17 >



MZ

1000 MUZ S

03 >



1000 MUZ SF

05 >



1000 MUZ SFX

07 >



1000 MUZ SN

05 >



1000 MUZ ST

07 >





07KA22.SD 119.5 x 26.4 x 7.3
94.5 x 36.2 x 7.3

07KA22.SX “ “ “

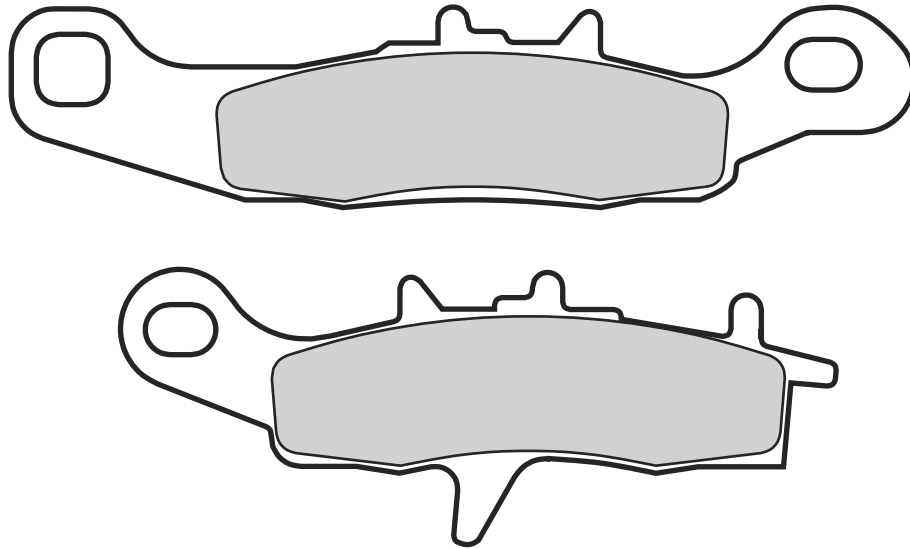

KAWASAKI

80	KX R7, T7, W1, W2, Y1, Y2	97 > 00	•
85	KX, II	01 >	•
100	KX	97 >	•
250	KL SUPER SHERPA	00 >	•

SUZUKI

85	RM	05 >	•
100	RM	03 >	•





07KA23.05	69.2 x 49.5 x 7
07KA23.SA	“ “ “
07KA23.LA	“ “ “
07KA23.SC	“ “ “
07KA23.RC	“ “ “

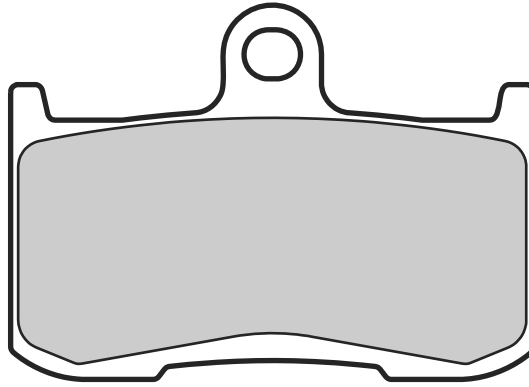

INDIAN

1800 CHIEF	15 > 18	•
1800 CHIEF DARK HORSE	15 > 18	•
1800 CHIEFTAIN CLASSIC	15 > 18	•
1800 CHIEFTAIN DARK HORSE	15 > 18	•
1800 CHIEFTAIN LIMITED	15 > 18	•
1800 ROADMASTER CLASSIC	15 > 18	•
1800 ROADMASTER ELITE	15 > 18	•
1800 SCOUT	15 >	•
1800 SPRINGFIELD	16 >	•
1800 SPRINGFIELD DARK HORSE	15 > 18	•

KAWASAKI

800 Z 800	13 > 16	•
800 Z 800 ABS	13 >	•
800 Z 800 SUGOMI EDITION	16 >	•
800 Z e ABS	13 >	•
900 Z	17 >	•
900 Z A2 (DEPOTENZIATA)	18 >	•
900 ZX 9R	02 >	•
1000 Z	03 > 06	•

SUZUKI

750 GSX S	17 > 17	•
750 GSX S	18 >	•
1340 B-KING	08 >	•

TRIUMPH

675 DAYTONA	06 > 08	•
675 STREET TRIPLE R	09 > 15	•
675 STREET TRIPLE RX	15 > 16	•
1050 SPEED TRIPLE	05 > 07	•
1050 SPEED TRIPLE S	05 > 07	•
1050 TIGER	07 > 08	•
1050 TIGER SE	09 > 12	•
1050 TIGER SPORT	15 >	•

VICTORY

1634 HAMMER	08 >	•
1634 KINGPIN ALL MODELS	08 >	•
1634 VEGAS	08 >	•
1634 VEGAS 8-BALL	08 >	•

1634 VEGAS JACKPOT	08 >	•
1731 BOARDWALK	13 >	•
1731 CROSS COUNTRY	10 >	•
1731 CROSS COUNTRY 8-BALL	14 >	•
1731 CROSS COUNTRY TOUR	12 >	•
1731 CROSS ROADS	10 >	•
1731 CROSS ROADS 8-BALL	14 >	•
1731 CROSS ROADS CLASSI	14 >	•
1731 HAMMER	09 >	•
1731 HAMMER 8-BALL	10 >	•
1731 HAMMER S	09 >	•
1731 HARD-BALL	12 >	•
1731 HIGH-BALL	12 >	•
1731 JACKPOT	10 >	•
1731 JUDGE	13 >	•
1731 KINGPIN	10 >	•
1731 KINGPIN 8-BALL	10 >	•
1731 MAGNUM X-1	15 >	•
1731 VEGAS	10 >	•
1731 VEGAS 8-BALL	10 >	•
1731 VEGAS JACKPOT	09 >	•



07KA24.SD

94.4 x 35.8 x 7.4

119.1 x 26 x 7.1

07KA24.SX

“ “ “

2

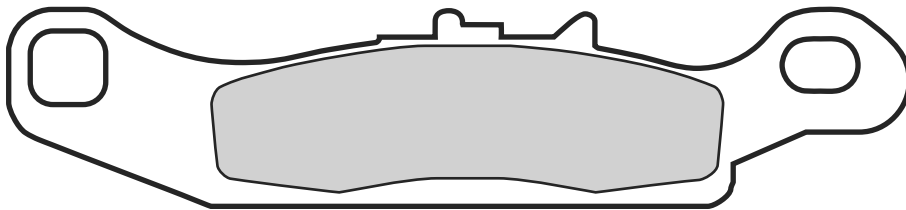
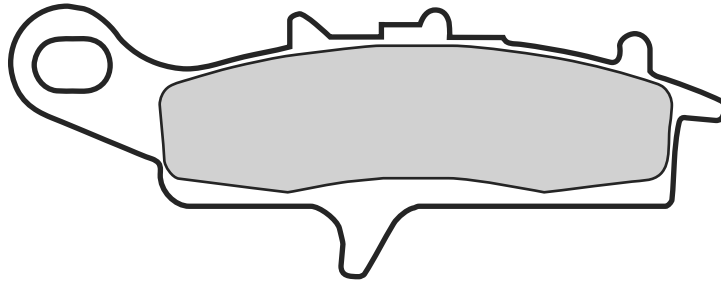

KAWASAKI

450	KFX RIGHT CALIPER	07 >	•
650	KVX RIGHT CALIPER	01 > 03	•
700	KFX V-FORCE RIGHT CALIPER	04 >	•
700	KSV V-FORCE	04 >	•
700	KVF PRAIRIE right caliper	04 >	•
700	KVX RIGHT CALIPER	04 >	•

SUZUKI

700	LT-V QUADRUNNER TWIN PEAKS	04 >	•
-----	----------------------------	------	---





07KA25.SD 94.4 x 35.8 x 7.4
119.1 x 26 x 7.1

07KA25.SX “ “ “

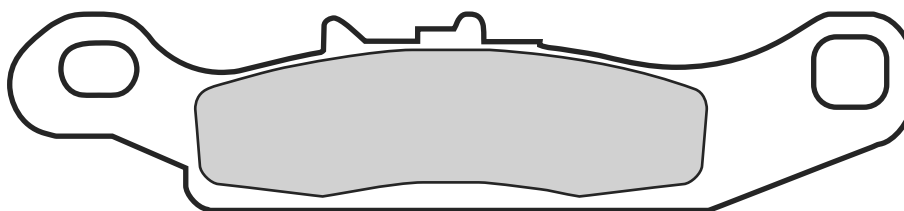
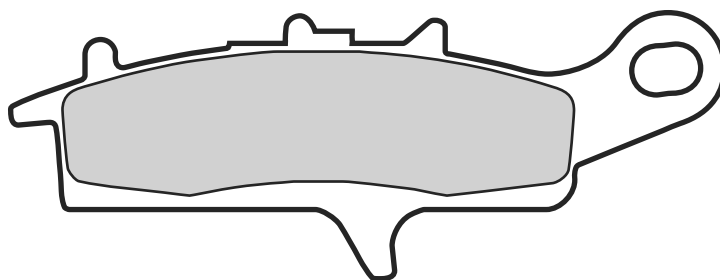

KAWASAKI

450	KFX RIGHT CALIPER	07 >	•
650	KVX LEFT CALIPER	01 > 03	•
700	KFX V-FORCE LEFT CALIPER	04 >	•
700	KFX V-FORCE RIGHT CALIPER	04 >	•
700	KVF PRAIRIE left caliper	04 >	•
700	KVX LEFT CALIPER	04 >	•

SUZUKI

700	LT-V QUADRUNNER TWIN PEAKS	04 >	•
-----	----------------------------	------	---



07KA26.SA

81 x 45.9 x 7.7

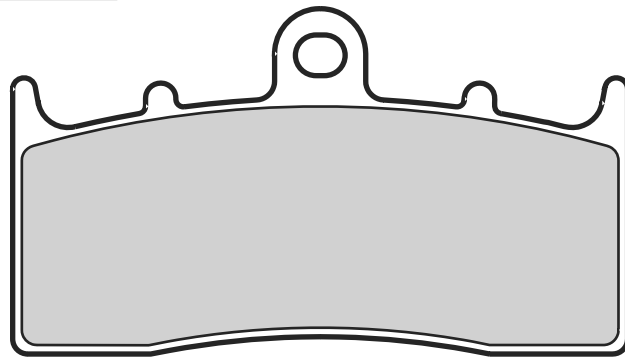

2



KAWASAKI

400 ZRX

98 >



07KA27.SD

51.6 x 39.9 x 7.6

67.5 x 36.5 x 7.6

07KA27.SX

“ “ “

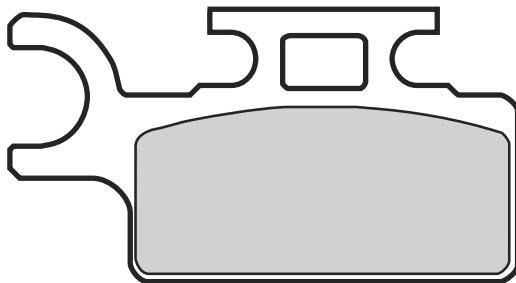
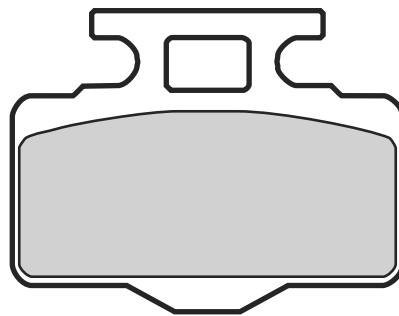

KAWASAKI

65 KX

00 >

SUZUKI

65 RM

03 >



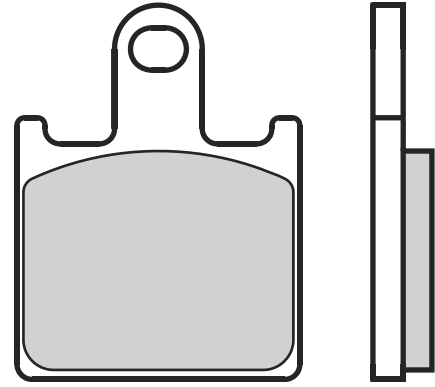

07KA28.SA	37.4 x 49.5 x 7.8
07KA28.LA	“ “ “
07KA28.SC	“ “ “
07KA28.RC	“ “ “

**KAWASAKI**

600 ZX-6R	07 >	•
750 Z 750 R	11 > 12	•
750 Z 750 R ABS	11 > 12	•

1000 Z	07 > 09	•
1400 GTR	07 > 16	•
1400 ZZR	06 >	•
1400 ZZR ABS	06 > 15	•

SUZUKI

1300 B-KING	07 > 12	•
-------------	---------	---

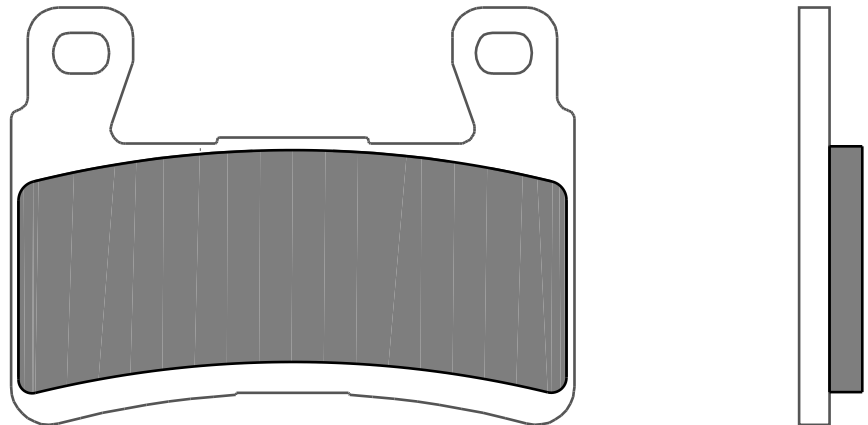

07KA29.SA	74.5 x 55.2 x 7.4
07KA29.SC	“ “ “
07KA29.RC	“ “ “

**KAWASAKI**

636 ZX-6R	13 >	•
636 ZX-6R ABS	13 >	•



07KA30.CC

84.9 x 44.1 x 7
74.5 x 40.9 x 7

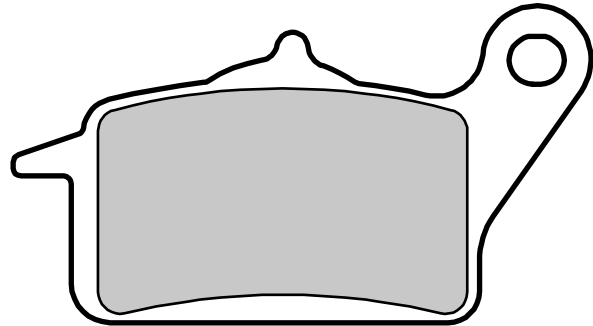
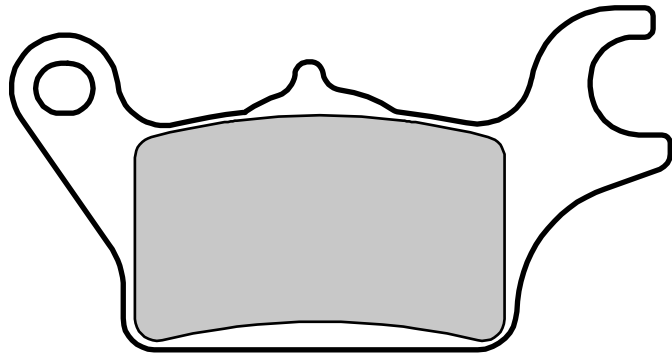

2



KAWASAKI

125 Z PRO

17 > •



07KS01.24

50.3 x 50.3 x 12.5
49.5 x 49.5 x 10

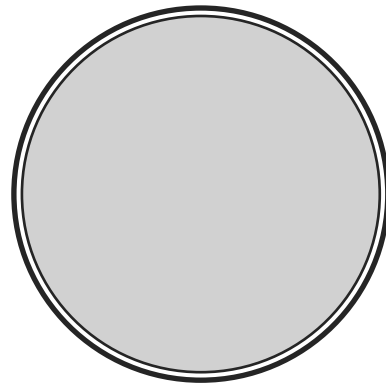
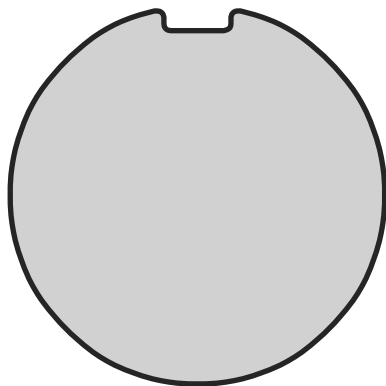

KAWASAKI

400 S3, S3A	74 > 75 •
750 Z H2, H2A	72 > 73 •
900 Z Z1, Z11A, Z1B	73 > 75 •



SUZUKI

RE 5 M, A	75 > •
50 RM M, A	75 > 76 •
100 GT	78 > •
125 GT A, B, C, L, M	75 > 78 •
185 GT	75 > 77 •



185 RG	75 > 77 •
250 GT	73 > 77 •
380 GT A, B, K, L, M	73 > 77 •
500 GT A, B	75 > 77 •
550 GT A, K, L, M	73 > 77 •
750 GT A, K, L, M	73 > 77 •





07KS02.07

58.1 x 53.9 x 9

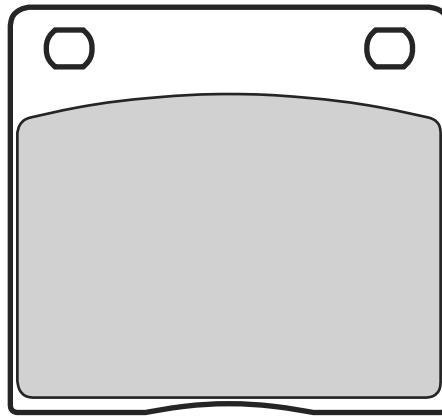

2



KAWASAKI

500 Z B1, B2	79 > 80	•
650 Z D1, D1A, D2, D3	78 > 82	•
1000 Z A1, A2, A3, A4	77 > 80	•
1000 Z C1, C2, C3, C4	78 > 81	•
1000 Z D1, D2, D3, Z1R	78 > 80	•
1000 Z F1	80 >	•
1000 Z MK2	79 >	•
1000 Z R	76 > 79	•
1000 Z, H1	80 >	•
1100 Z ST	81 >	•
1300 Z	79 > 81	•
1300 Z DF1	84 > 89	•

SUZUKI

250 GSX E, ET	80 > 81	•
250 GSX S	86 > 92	•
400 GSX ET, X, ST, SX	80 >	•
400 GSX F	81 > 82	•
400 GSX FOUR	81 >	•
400 GSX FWS	86 >	•
400 GSX FX	81 > 82	•
450 GS S	86 >	•
500 GS MX	81 >	•
550 GS DB	77 > 78	•
550 GS E	78 > 79	•
550 GS E, L, T, LX, LT, TX	80 >	•
550 GS EC	78 >	•

550 GS EM	81 > 84	•
550 GS EN, LN	79 >	•
550 GS ET, LT	80 > 81	•
550 GS LZ, MZ	82 >	•
550 GS ME, KATANA	81 >	•
650 GR E	83 >	•
650 GS EX, GLX, X, GX	81 >	•
650 GS EZ, GZ, GLZ	82 >	•
650 GS GD, G, MD, KATANA	83 >	•
650 GS GT	81 >	•
650 GS L	81 >	•
650 GS TURBO, XN	83 >	•
750 GS	76 > 77	•
750 GS B, C, EC	77 >	•
750 GS DB, EX, EN	77 >	•
750 GS ED, ESD	83 >	•
750 GS ET, LT, T	80 >	•
750 GS EX, LX, X	81 >	•
750 GS KATANA	85 >	•
750 GS L, N, LN	79 >	•
750 GS SD	83 >	•
750 GSX E	82 > 83	•
750 GSX E, EF, ET, EZ, EX, L, LT, LX	80 > 82	•
750 GSX ES	83 > 89	•
750 GSX ES, EF, STS	86 > 89	•
750 GSX KATANA	82 > 85	•
750 GSX S	82 > 85	•
750 GSX S	86 > 16	•

850 GS E, G, GT, GX, GLX, L	80 >	•
850 GS GD, GLD, TD	83 >	•
850 GS GL, GLT	81 >	•
850 GS GN, EN, GT	79 >	•
850 GS GZ, GLZ	82 >	•
850 GSX G	83 >	•
850 XN TURBO	82 >	•
1000 GS G, GLT, LT	80 >	•
1000 GS N, EN, HN, LN, SN	79 >	•
1000 GS S, HC, EC, EN	78 >	•
1000 GSX E, EZ, GKZ, S, SZ, X, KATANA	82 >	•
1000 GSX S, KATANA	82 >	•
1100 GS ED, ESD, GD, GKD, GLD, SD	83 >	•
1100 GS ET, L, LT, ST, T	79 > 80	•
1100 GS EX, LX, TX, X	81 >	•
1100 GS G	86 >	•
1100 GS GD, GKZ, GLD, GLZ, GZ	82 > 83	•
1100 GSX E, L	79 >	•
1100 GSX E, S	82 >	•
1100 GSX ES	82 >	•
1100 GSX ET	79 >	•
1100 GSX Z, ESD	86 >	•
1100 GT ET, T, LT, ST	80 >	•
1200 GV GLG MADURA	86 >	•
1400 GV CAVALCADE	85 >	•



07KS03.21

44.5 x 43.8 x 12.2

43.4 x 43.4 x 9.5

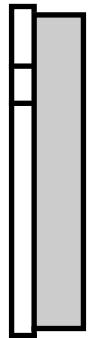
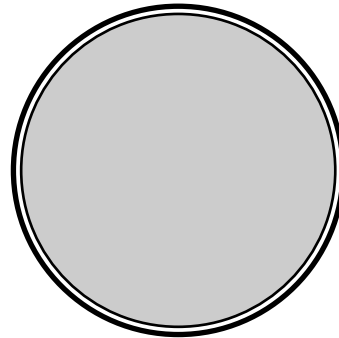
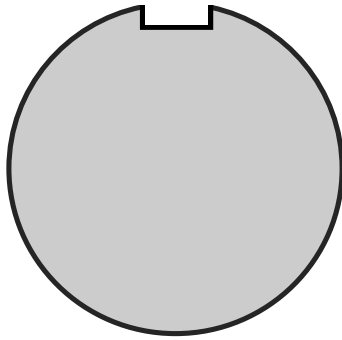

2



KAWASAKI

125 KH	77 > 80	•
200 KZ	78 > 79	•
200 Z	77 > 81	•



SUZUKI

50 AC DX	81 >	•
50 AC RG, RZ, Z1	79 >	•
50 GT K	81 >	•



50 GT K, KB	77 >	•
50 X1	79 >	•
50 ZR K	79 >	•





07KS04.32 84.9 x 42.4 x 7.5
55.8 x 37 x 9.8

07KS04.SD “ “ “

07KS04.SX “ “ “

07KS04.TT “ “ “

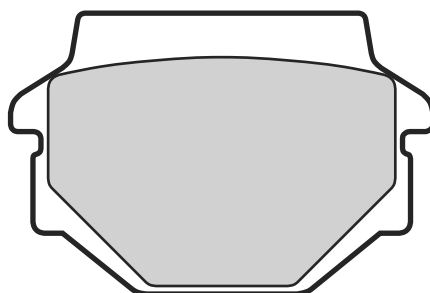
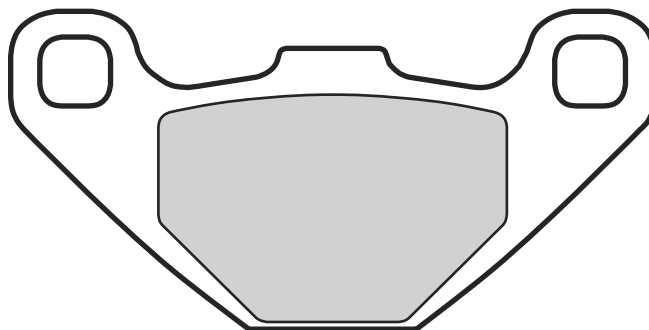

BOMBARDIER-CAN AM

200 RALLY 2X4 05 > 06 •

KAWASAKI

100 KH GH, EX 83 > •

125 AR 82 > •

125 KE 86 > •

125 KH 82 > 83 •

125 KMX 86 > 86 •

125 KMX 87 > 90 •

125 KX 83 > 85 •

125 KX 86 > 86 • •

125 KX 87 > 88 •

200 KDX 86 > 88 •

200 KDX SR 89 > 92 •

200 KMX 88 > 90 •

200 Z 83 > •

250 250 BALIUS 91 > •

250 ESTRELLA 92 > • •

250 KL 85 > 97 •

250 KL SUPER SHERPA 00 > •

250 KLR 84 > 86 •

250 KR 85 > •

250 KX 83 > 85 •

250 KX 86 > 86 • •

250 KX 87 > 88 •

250 KXT A2, B1 TECATE 85 > 86 •

250 Z SCORPION 89 > •

250 ZZR R 90 > •

300 KLF B1-B13 BAYOU 88 > •

305 GPZ 81 > 82 •

350 350 KLR 85 > •

400 EX-4 95 > •

400 FX R 86 > •

400 GPX 85 > 86 •

400 KLE 91 > •

400 LX ELIMINATOR 90 > 93 •

400 XANTHUS 92 > •

400 Z F 84 > •

400 ZR F, A1 83 > 84 •

400 ZX 85 > 85 •

500 EX 94 > 96 •

500 EX E1-E3 94 > 96 •

500 GPZ S 88 > 92 •

500 GPZ S 93 > 94 •

500 GPZ S 95 > 96 • •

500 GPZ S 97 > •

500 KLE 91 > 98 •

500 KX 83 > 85 •

500 KX 86 > 86 • •

500 KX 87 > 88 •

500 LX A 83 > •

500 ZR A1, F 83 > •

550 550KX A 83 > •

550 Z F 83 > 84 •

550 Z GT 83 > •

550 ZR A1, GP 83 > •

600 KL A1, A1L 84 > 86 •

600 KLR 84 > 86 •

600 KLR E 85 > •

650 KLR 87 > 89 •

650 KLR 95 > 04 •

650 KLR TENGAI 89 > 92 •

650 TENGAI 89 > 91 •

KYMCO

125 AGILITY R16 08 > •

POLARIS

200 PHOENIX 05 > 09 •

200 PHOENIX 10 > •

SUZUKI

50 GSX-R 87 > •

50 OR E 80 > •

50 RB H 87 > •



50	RG GAG	87 >	•
50	RG GAMMA	90 >	•
50	TV WOLF	91 >	•
50	ZR SAPX, SKX, SLK	81 >	•
80	GT L, X3E, EX, LX	81 >	•
80	RG GAMMA	87 > 87	•
118	TRS	82 > 83	•
125	GN	91 > 96	•

125	GS ESZ	82 >	•
125	GT T, ET	80 >	•
125	TR	83 >	•
125	X 3 E	70 >	•
125	X4	70 >	•
230	LT EH, S	86 > 93	•
240	ET	86 >	•
250	LT SF QUADRACER	85 >	•

250	NZ S	86 >	•
400	GSX	83 >	•
400	GSX EFX	82 >	•
400	GSX FD	83 >	•
400	GSX FOUR	81 >	•
400	GSX FX	81 > 82	•
450	GS S	86 >	•



07KS05.07

52.5 x 52.9 x 9

07KS05.SP

“ “ “

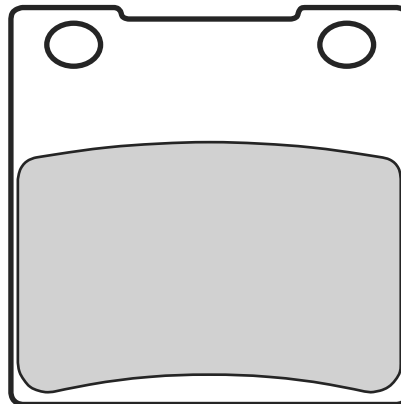

HYOSUNG

250	GT COMET	02 > 02	•
600	COMET	02 > 02	•

1200	ZX12R NINJA	00 > 03	•
1200	ZX12R NINJA	04 > 06	•
1200	ZZR	02 > 05	•

250	RGV K	89 > 90	•
250	TV J	88 >	•
250	WOLF	90 >	•
350	GOOSE	92 >	•

KAWASAKI

250	Z	78 > 80	•
250	Z J	81 >	•
400	ZX 4	90 >	•
400	ZXR	89 > 90	•
400	ZXR R	91 > 02	•
750	ZX 7 R	96 > 99	•
750	ZX-7 NINJA	89 > 94	•
750	ZXR	89 > 92	•
750	ZXR R	93 > 95	•
1100	ZRX	96 > 00	•
1100	ZX 11 R	93 > 96	•
1100	ZZR	94 > 01	•
1200	ZRX, R, S	01 >	•

SUZUKI

250	ACROSS	90 >	•
250	COBRA	89 > 90	•
250	DJEBEL	93 >	•
250	GF S	88 >	•
250	GSF BANDIT	90 > 93	•
250	GSX FWS	85 >	•
250	GSX S, KATANA	91 > 99	•
250	GSX-R	88 >	•
250	GSX-R S	89 >	•
250	RG	83 >	•
250	RG GAMMA	83 > 84	•
250	RG GAMMA	85 > 87	•
250	RG GAMMA	88 >	•

400	GSF BANDIT	91 > 92	•
400	GSF BANDIT	93 > 93	•
400	GSX F	89 >	•
400	GSX IMPULSE	94 >	•
400	GSX S, KATANA	92 > 99	•
400	GSX SWS	84 >	•
400	GSX X	86 >	•
400	GSX-R	87 > 87	•
400	GSX-R	88 > 90	•
400	GSX-R F	85 > 86	•
400	GSX-R, RR	90 > 99	•
400	RF	93 >	•
400	SE	92 >	•
500	GS	04 >	•





500 GS E	89 > 96	•	600 GSX-R	93 > 96	•	1000 TL S	97 >	•
500 GS E	96 > 03	•	600 GSX-R	97 > 03	•	1100 GSX EF ESF	86 >	• •
500 GS F	04 >	•	600 RF R	93 > 96	•	1100 GSX G	96 > 96	•
500 GSX E	83 >	• •	650 SV S	99 > 02	•	1100 GSX KATANA, F	93 > 96	•
500 RG GAMMA	85 > 89	•	680 RG	86 > 87	•	1100 GSX R	86 > 89	•
500 RG RF	85 >	•	750 GS RF	85 >	•	1100 GSX R	89 > 92	•
550 GS ED,ESD	83 >	• •	750 GSX F	89 > 95	•	1100 GSX R	93 >	•
550 GS LD	83 >	• •	750 GSX FW	98 > 02	•	1200 GSF BANDIT	95 > 96	•
550 GSX ED	83 > 84	• •	750 GSX KATANA	89 > 96	•	1200 GSF BANDIT	97 > 00	•
550 GSX ES, EF	84 >	• •	750 GSX SE	84 > 85	• •	1200 GSF BANDIT	01 >	•
600 GSF BANDIT	95 > 99	•	750 GSX-R	85 > 87	•	1200 GSF BANDIT S	01 >	•
600 GSF BANDIT S	00 > 04	•	750 GSX-R	88 > 93	•	1200 GSX	99 > 01	•
600 GSX BANDIT	00 >	•	750 GSX-R	94 > 99	•	1300 GSX R HAYABUSA	99 > 07	•
600 GSX F	88 > 97	•	750 GSX-R	00 > 03	•			
600 GSX FW	98 >	•	1000 TL R	98 >	•			



07P001.06 96.6 x 39.1 x 7.1

07P001.SD “ “ “

07P001.SX “ “ “

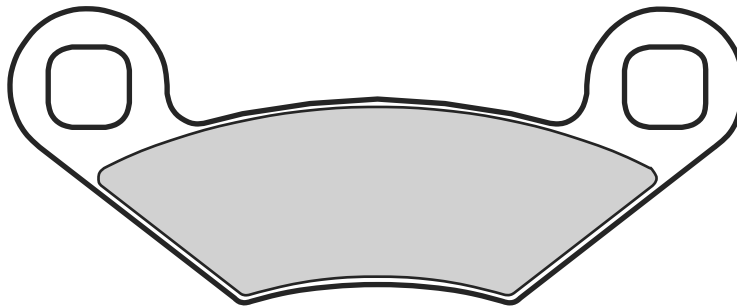

POLARIS

250 TRAIL BOSS	88 > 90	•	450 OUTLAW S	08 >	•	600 SPORTSMAN	03 >	•
300 SPORTSMAN 4X4	08 >	• •	500 E SCRAMBLER	08 >	•	700 SPORTSMAN	02 >	•
325 XPEDITION	00 > 01	•	500 REVOLVER	06 >	• •	700 SPORTSMAN MV 700	05 >	•
325 XPEDITION	02 >	•	500 SPORTSMAN HO	03 >	•	800 RANGER RZR EFI	08 >	•
330 E TRIAL BLAZER	08 >	•	525 OUTLAW	07 >	•	800 RANGER RZR S EFI	09 >	•
450 OUTLAW MXR	09 >	•	525 OUTLAW IRS	08 >	•	800 RZR	08 >	•
			525 OUTLAW S	08 >	•	800 SPORTSMAN	05 >	•
			570 RANGER RZR EFI	12 >	•			



07P002.SD

97 x 39.6 x 7

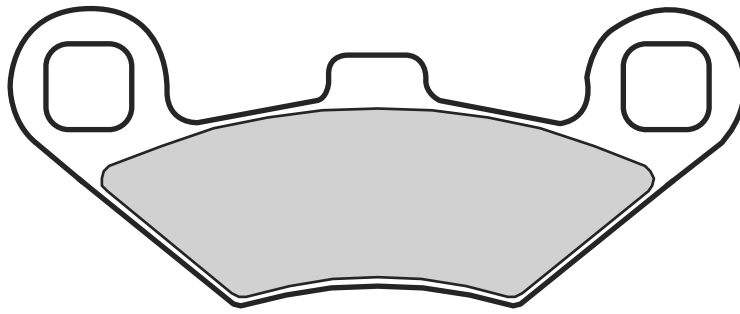

2



POLARIS

200 PHOENIX	05 > 09	•	335 SPORTSMAN 4X4	99 >	•	425 MAGNUM 6X6	96 >	•
250 2X4, 4X4	90 >	•	350 BIG BOSS	93 >	•	425 XPEDITION 4X4	00 >	•
250 BIG BOSS 4X6, 6X6	89 > 93	•	350 L 2X4, 4X4	90 >	•	450 SPORTSMAN	06 >	•
250 TRAIL BLAZER	94 > 98	•	350 SPORTSMAN 4X4	93 >	•	455 DIESEL EBS 4X4	99 >	•
250 TRAIL BLAZER	99 >	•	350 SPORTSMAN L 4X4	93 >	•	500 ATP HO	04 >	• •
250 TRAIL BOSS	91 > 99	•	350 TRAIL BOSS L 2X4	91 > 93	•	500 BIG BOSS 6X6	98 > 99	•
250 TRAIL BOSS 2X4, 4X4	91 > 92	•	350 TRAIL BOSS L 4X4	91 >	•	500 MAGNUM 2X4	02 >	•
250 XPLOER 4X4	00 >	•	400 BIG BOSS L 6X6	96 >	•	500 MAGNUM 4X4	00 > 01	•
300 2X4, 4X4	94 > 95	•	400 L 2X4	94 > 95	•	500 MAGNUM 4X4	02 >	•
300 BIG BOSS 6X6	94 >	•	400 SCRAMBLER 2X4	00 >	•	500 OUTLAW	06 >	• •
300 HAWKEYE 2X4	06 >	• •	400 SCRAMBLER 4X4	98 > 98	•	500 PREDATOR	03 >	• •
300 HAWKEYE 4X4	06 >	• •	400 SCRAMBLER 4X4	99 >	•	500 PREDATOR E	06 >	•
300 XPLOER 4X4	96 >	•	400 SCRAMBLER L 4X4	94 > 97	•	500 RANGER 6X6	00 > 02	•
300 XPRESS 2X4	98 >	•	400 SPORT	99 > 00	•	500 SCRAMBLER 2X4	01 >	•
300 XPRESS L	96 > 97	•	400 SPORT L	94 > 98	•	500 SCRAMBLER 4X4	97 > 97	•
325 MAGNUM 2X4, 4X4	00 > 02	•	400 SPORTSMAN	01 >	•	500 SCRAMBLER 4X4	98 >	•
325 TRAIL BOSS	00 > 02	•	400 SPORTSMAN L 4X4	94 > 97	•	500 SPORTSMAN 4X4	96 >	•
330 ATP	04 > 05	• •	400 TRAIL BLAZER	03 >	•	500 SPORTSMAN 6X6	00 >	•
330 ATP	06 >	•	400 XPLOER L 4X4	95 > 99	•	500 SPORTSMAN EBS 4X4	98 >	•
330 MAGNUM 2X4, 4X4	03 >	•	400 XPLOER L 4X4	00 >	•	500 XPLOER 4X4	97 >	•
330 TRAIL BOSS	03 >	•	400 XPRESS L	96 > 97	•	800 TRAIL BLAZER	90 > 93	•
			425 2X4, 4X4 MAGNUM	95 > 98	•	800 TRAIL BOSS 2X4, 4X4	88 > 89	•





07P003.SD 72.8 x 43.9 x 7
07P003.SX “ “ “

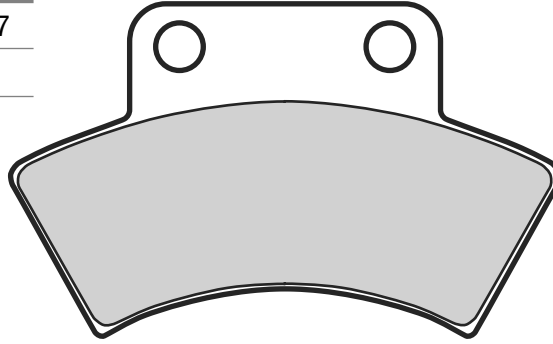

POLARIS

250 2X4, 4X4	90 >	•	300 XPRESS 2X4	98 >	•	400 SPORT L	94 > 98	•
250 BIG BOSS 4X6, 6X6	89 > 93	•	300 XPRESS L	96 > 97	•	400 SPORTSMAN L 4X4	94 > 97	•
250 BIG BOSS 4X6, 6X6			350 BIG BOSS	93 >	•	400 XPLOER L 4X4	95 > 99	•
250 MIDDLE AXLE BRAKE	89 > 93	•	350 BIG BOSS MIDDLE AXLE BRAKE	93 >	•	400 XPRESS L	96 > 97	•
250 TRAIL BLAZER	94 > 98	•	350 L 2X4, 4X4	90 >	•	425 2X4, 4X4 MAGNUM	95 > 98	•
250 TRAIL BOSS	91 > 99	•	350 SPORTSMAN 4X4	93 >	•	500 BIG BOSS 6X6	98 > 99	•
250 TRAIL BOSS 2X4, 4X4	91 > 92	•	350 SPORTSMAN L 4X4	93 >	•	500 BIG BOSS 6X6 MIDDLE AXLE BRAKE	98 > 99	•
300 2X4, 4X4	94 > 95	•	350 TRAIL BOSS L 2X4	91 > 93	•	500 SCRAMBLER 4X4	97 > 97	•
300 BIG BOSS 6X6	94 >	•	350 TRAIL BOSS L 4X4	91 >	•	500 SPORTSMAN 4X4	96 >	•
300 BIG BOSS 6X6 MIDDLE AXLE BRAKE	94 >	•	400 BIG BOSS L 6X6	96 >	•	500 XPLOER 4X4	97 >	•
300 XPLOER 4X4	96 >	•	400 L 2X4	94 > 95	•	800 TRAIL BLAZER	90 > 93	•
			400 SCRAMBLER 4X4	98 > 98	•	800 TRAIL BOSS 2X4, 4X4	88 > 89	•
			400 SCRAMBLER L 4X4	94 > 97	•			



07P004.SD 73.9 x 53.2 x 6.8
07P004.SX “ “ “

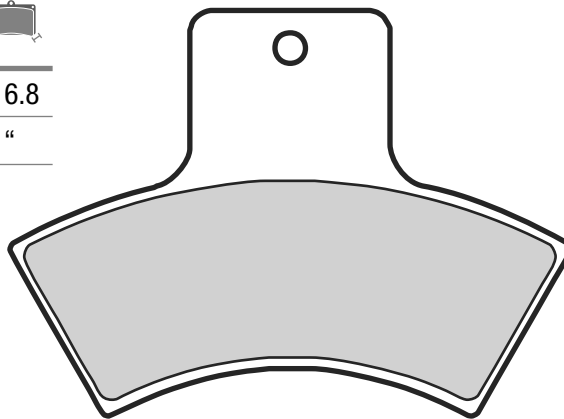

POLARIS

250 TRAIL BLAZER	99 >	•	335 SPORTSMAN 4X4	99 >	•	425 MAGNUM 6X6	96 >	•
250 XPLOER 4X4	00 >	•	400 SCRAMBLER 2X4	00 >	•	425 XPEDITION 4X4	00 >	•
325 MAGNUM 2X4, 4X4	00 > 02	•	400 SCRAMBLER 4X4	99 >	•	455 DIESEL EBS 4X4	99 >	•
325 TRAIL BOSS	00 > 02	•	400 SPORT	99 > 00	•	500 MAGNUM 4X4	00 > 01	•
325 XPEDITION	00 > 01	•	400 SPORTSMAN	01 >	•	500 SCRAMBLER 2X4	01 >	•
330 TRAIL BOSS	03 >	•	400 TRAIL BLAZER	03 >	•	500 SCRAMBLER 4X4	98 >	•
			400 XPLOER L 4X4	00 >	•	500 SPORTSMAN EBS 4X4	98 >	•



07P005.SX 123.6 x 54.8 x 9.2

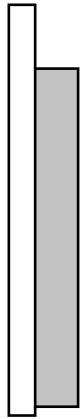
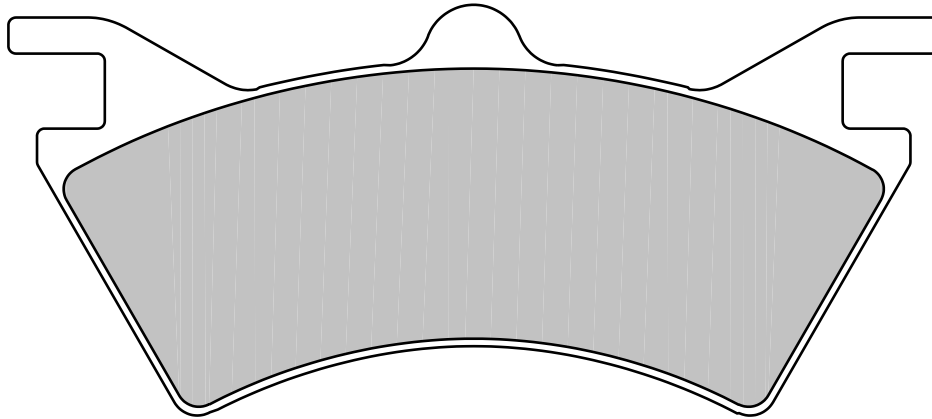

2



POLARIS

500 SPORTSMAN 6X6 00 > •



07P006.SD 90.2 x 37.9 x 8

07P006.SX “ “ “

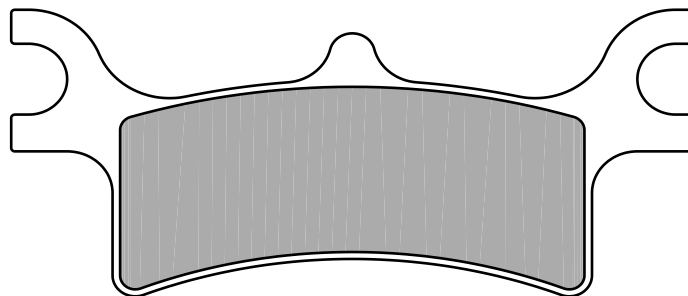

POLARIS

325 XPEDITION	02 >	•
330 ATP	06 >	•
330 E TRIAL BLAZER	08 >	•
330 MAGNUM 2X4, 4X4	03 >	•

450 SPORTSMAN	06 >	•
500 E SCRAMBLER	08 >	•
500 MAGNUM 2X4	02 >	•
500 MAGNUM 4X4	02 >	•
500 PREDATOR E	06 >	•

500 SPORTSMAN HO	03 >	•
600 SPORTSMAN	03 >	•
700 SPORTSMAN	02 >	•
700 SPORTSMAN MV 700	05 >	•
800 SPORTSMAN	05 >	•





07P007.SD 96.6 x 50.5 x 6.8

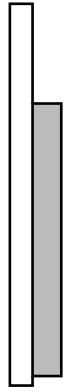
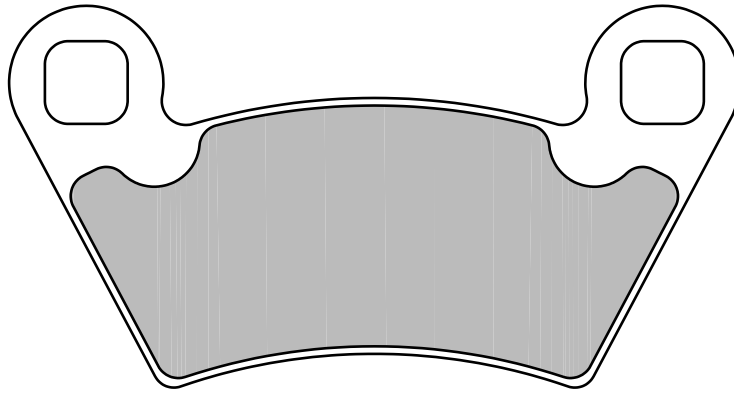

2



POLARIS

RANGER XP	06 >	• •
500 RANGER 2X4	08 >	•
500 RANGER 2X4 EFI	08 >	•

500 RANGER 4X4	12 >	•
700 RANGER 6X6 EFI	12 >	•
800 EV-LSV	10 >	•
800 LSV 4X4	11 >	•
800 RANGER 2X4, 4X4, 6X6	02 >	• •

800 RANGER 48V EV	13 >	•
800 RANGER RZR4 EFI	12 >	•
800 RANGER XP	12 >	•
800 RZR 4	10 >	•



07P008.SD 50 x 60.4 x 6.8

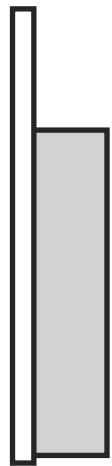
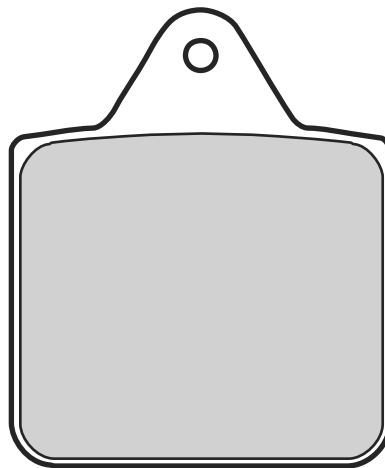

POLARIS

400 BIG BOSS L 6X6 MIDDLE AXLE BRAKE	96 >	•
425 MAGNUM 6X6 MIDDLE AXLE BRAKE	96 >	•



07P009.SD 96.2 x 46.8 x 7.6

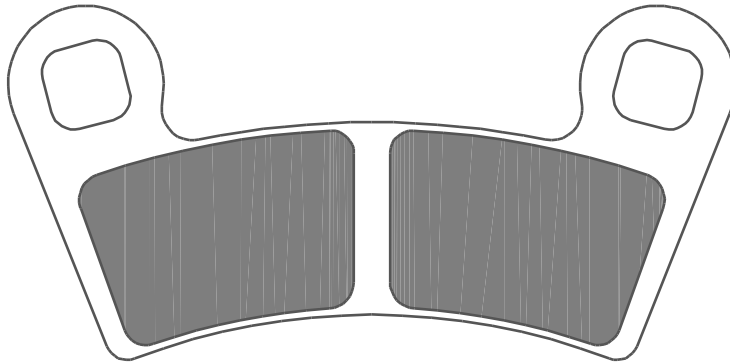

2



POLARIS

450 OUTLAW MXR	09 >	•
450 OUTLAW S	08 >	•

525 OUTLAW	07 >	•
525 OUTLAW IRS	08 >	•
525 OUTLAW S	08 >	•
570 RANGER RZR EFI	12 >	•

800 RANGER RZR EFI	08 >	•
800 RANGER RZR S EFI	09 >	•
800 RZR	08 >	•



07P010.SD 120.4 x 57 x 7.6

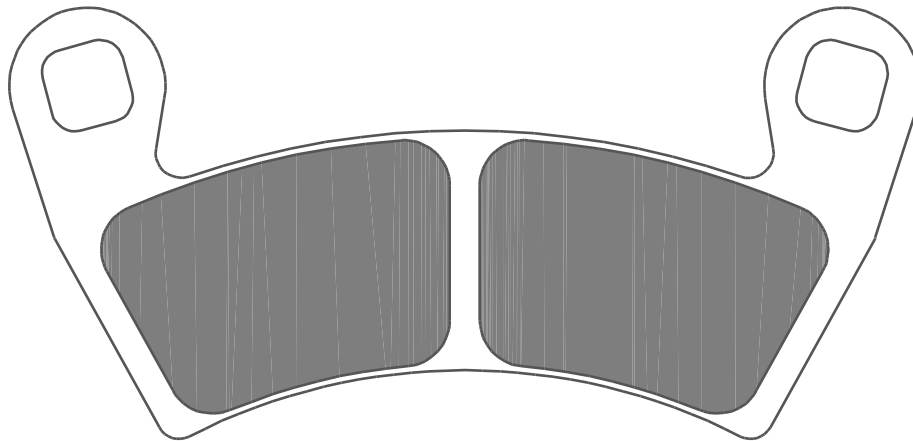

POLARIS

500 RANGER 2X4	08 >	•
500 RANGER 2X4 EFI	08 >	•
500 RANGER 4X4	12 >	•
700 MVRS 4X4	08 >	• •
700 RANGER 4X4 EFI	08 >	• •
700 RANGER 6X6 EFI	12 >	•

800 EV-LSV	10 >	•
800 LSV 4X4	11 >	•
800 MV DIESEL CREW	13 >	• •
800 MVRS 4X4	08 >	• •
800 RANGER 48V EV	13 >	•
800 RANGER 4X4 EFI	10 >	• •
800 RANGER 6X6 EFI	10 >	• •

800 RANGER CREW	12 >	• •
800 RANGER RZR4 EFI	12 >	•
800 RANGER XP	12 >	•
800 RZR 4	10 >	•
900 RANGER 4X4 DIESEL	10 >	• •
900 RANGER RZR4 XP EFI	12 >	• •
900 RANGER RZR4 XP4 EFI	12 >	• •





07P011.SD 96.2 x 43.1 x 7.7

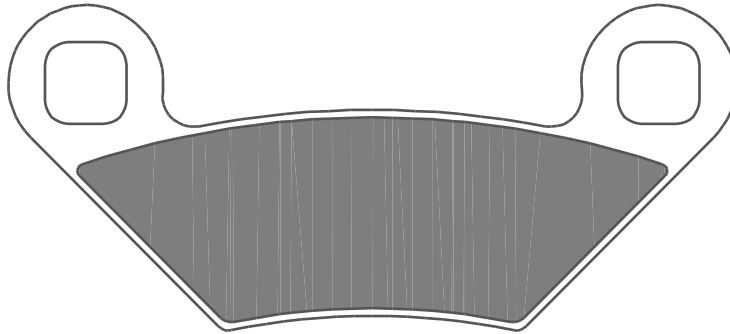

2



POLARIS

550	SPORTSMAN	11 >	• •
550	SPORTSMAN EPS	10 >	• •
550	SPORTSMAN EPS X2	14 >	• •
550	SPORTSMAN TOURING EPS	10 >	• •
550	SPORTSMAN X2	10 >	• •
550	SPORTSMAN XP	09 >	• •
550	SPORTSMAN XP EPS	09 >	• •
550	SPORTSMAN XP TOURING EPS	12 >	• •
850	FOREST	15 >	• •
850	SCRAMBLER	15 >	• •

850	SCRAMBLER HO / HO EPS	13 >	• •
850	SCRAMBLER MD	15 >	• •
850	SPORTSMAN	11 >	• •
850	SPORTSMAN MV	12 >	• •
850	SPORTSMAN TOURING	14 >	• •
850	SPORTSMAN TOURING EPS	10 >	• •
850	SPORTSMAN TOURING HO EPS	13 >	• •
850	SPORTSMAN TOURING MD	15 >	• •
850	SPORTSMAN X2	11 >	• •

850	SPORTSMAN XP	09 >	• •
850	SPORTSMAN XP EPS	09 >	• •
850	SPORTSMAN XP HO EPS	13 >	• •
850	SPORTSMAN XP HO EPS MD	15 >	• •
850	SPORTSMAN XP TOURING EPS	15 >	• •
1000	FOREST	15 >	• •
1000	SCRAMBLER MD	15 >	• •
1000	SCRAMBLER XP	15 >	• •
1000	SCRAMBLER XP HO EPS	14 >	• •
1000	SPORTSMAN MD	15 >	• •
1000	SPORTSMAN TOURING	15 >	• •
1000	SPORTSMAN XP	15 >	• •



07P012.SD

87 x 42.4 x 7.8

07P012.SX

“ “ “

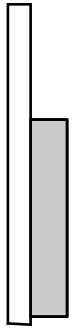
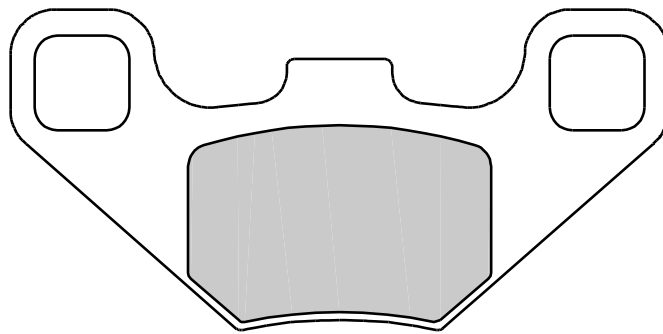
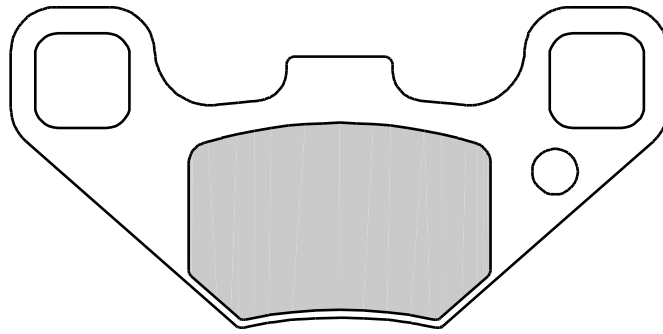

2



POLARIS

170 RANGER RZR	09 >	•
200 PHOENIX	10 >	•



07P013.SD

88.7 x 46.7 x 7.2

07P013.SX

“ “ “

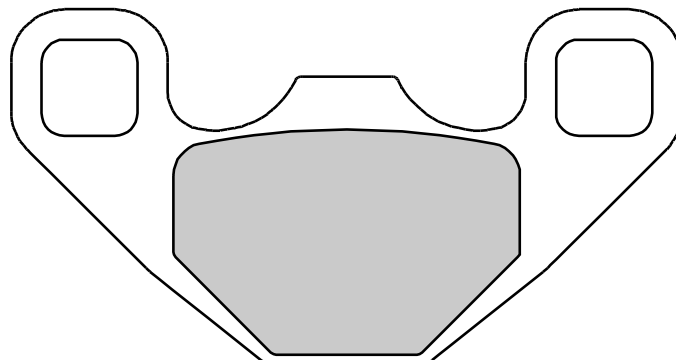

POLARIS

170 RANGER RZR	09 >	•
----------------	------	---





07SU01.25 50.3 x 50.3 x 12.5
49.9 x 52.9 x 11

2

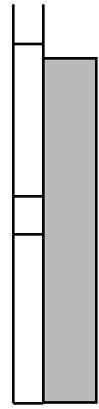
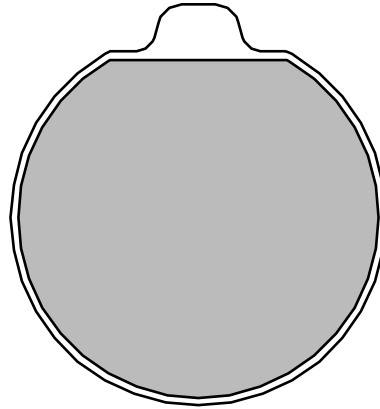
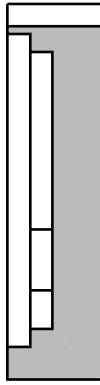
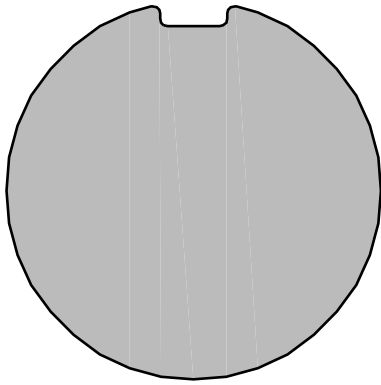

SUZUKI

400 GS B,C,

77 > 78 •

425 GS N, EN

750 GS

750 GS B, C, EC

79 >

76 > 77 •

77 > •

750 GS DB, EX, EN

850 GS GN, EN, GT

77 >

79 > •



07SU02.20 49.5 x 52.9 x 11.5
49.7 x 53 x 12.8

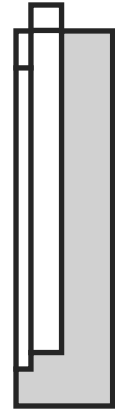
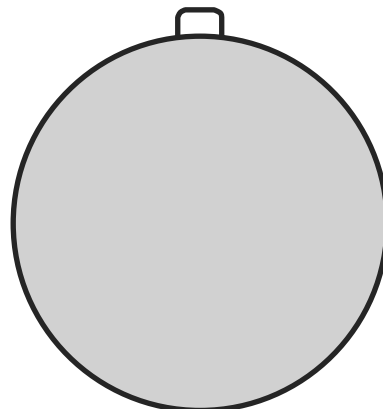
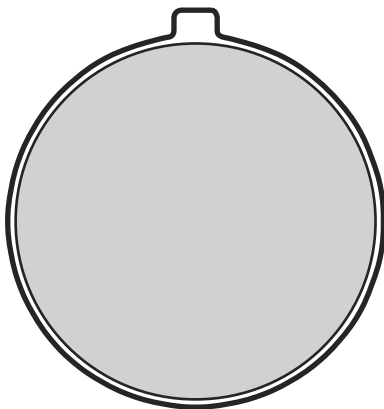

SUZUKI

125 GT C, EC, N, E

78 > •

125 RG

79 > 91 •

250 GT B6, B7, X7

78 > •

250 RG E

78 > •

400 GS

78 > •

400 GS L

400 GS T

425 GS LN

500 GT K, L, M

550 GS B

550 GS DB

550 GS E

79 >

81 > •

80 > •

73 > 75 •

77 > •

77 > 78 •

78 > 79 •

550 GS EC

550 GS EN, LN

550 GT A, B

750 GS L, N, LN

1000 GS N, EN, HN, LN, SN

1000 GS S, HC, EC, EN

78 >

79 > •

78 > •

79 > •

79 > •

78 > •



07SU03.12 75.6 x 49.4 x 11

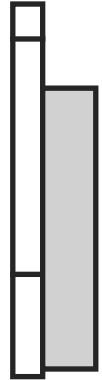
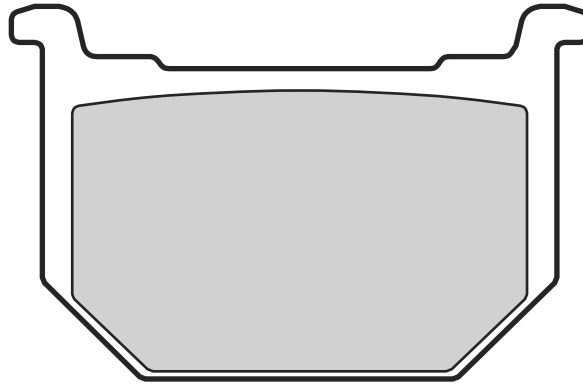

2



SUZUKI

250 GN	86 > 92	•
250 GN	93 >	•
250 GNX E	83 >	•
250 GS T, L	81 > 82	•
250 GS TT, TX, TZ	80 > 82	•
250 GSX	80 > 81	•
250 GSX E, ET	80 > 81	•
250 GSX OX, EX, LT, TT	81 > 82	•
400 GN X, T, TZ, XX	80 >	•
400 GSX E	86 >	•
400 GSX ET, X, ST, SX	80 >	•

400 GSX F	81 > 82	•
400 GSX FWS, TD, EE	84 >	•
400 GSX S, L	83 >	•
450 GS E, L, S	80 > 83	•
450 GSX ET, FT, S	80 > 81	•
550 GS ET, LT	80 > 81	•
650 GS L	81 >	•
700 GV GLG MADURA	86 >	•
750 GS ED, ESD	83 >	•
750 GS ET, LT, T	80 >	•
750 GS EX, LX, X	81 >	•
750 GSX E	82 > 83	•

750 GSX E, EF, ET, EZ, EX, L, LT, LX	80 > 82	•
750 GSX ES	83 > 89	•
750 GSX KATANA	82 > 85	•
750 GSX S	82 > 85	•
850 GS E, G, GT, GX, GLX, L	80 >	•
850 GS GD, GLD, TD	83 >	•
850 GS GL, GLT	81 >	•
850 GS GZ, GLZ	82 >	•
850 GSX G	83 >	•
1000 GS G, GLT, LT	80 >	•
1200 GV GLG MADURA	86 >	•



**07SU04.12**

71.9 x 44.8 x 11

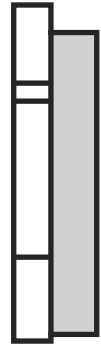
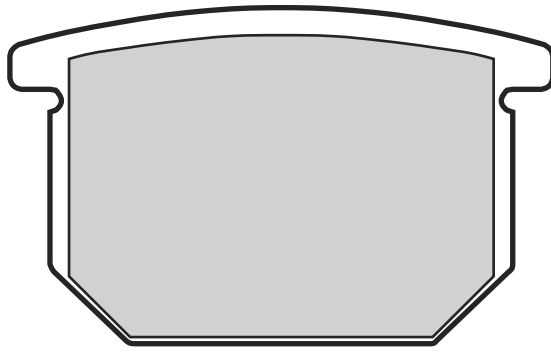
**SUZUKI**

250 GSX S	86 > 92	•	650 GS GD,G, MD,KATANA	83 >	•	1000 GSX S, KATANA	82 >	•
400 GSX FWS	86 >	•	650 GS GT	81 >	•	GS ED, ESD, GD, GKD, GLD, SD	83 >	•
450 GS GA, L	86 >	•	650 GS TURBO, XN	83 >	•	1100 GS ET, L, LT, ST, T	79 > 80	•
450 GS L	85 >	•	650 GSX GT	85 > 85	•	1100 GS EX, LX, TX, X	81 >	•
500 GS M	81 >	•	650 LS P	87 >	•	1100 GS G	86 >	•
500 GS MX	81 >	•	680 RG	86 > 87	•	GS GD, GKZ, GLD, GLZ, GZ	82 > 83	•
550 GS E, L, T, LX, LT, TX	80 >	•	750 GS KATANA	85 >	•	1100 GSX E, L	79 >	•
550 GS EM	81 > 84	•	750 GS SD	83 >	•	1100 GSX E, S	82 >	•
550 GS LZ, MZ	82 >	•	750 GS SZ	82 >	•	1100 GSX ES	82 >	•
550 GS ME, KATANA	81 >	•	750 GSX ES, EF, STS	86 > 89	•	1100 GSX ET	79 >	•
650 GR	83 >	•	750 GSX S	86 > 16	•	1100 GSX Z, ESD	86 >	•
650 GR D, XD	83 > 86	•	850 XN TURBO	82 >	•	1100 GT ET, T, LT, ST	80 >	•
650 GR E	83 >	•	1000 G SZ	82 >	•	1400 GV CAVALCADE	85 >	•
650 GS EX, GLX, X, GX	81 >	•	1000 GS EX	81 >	•			
650 GS EZ, GZ, GLZ	82 >	•	1000 GSX E, EZ, GKZ, S, SZ, X, KATANA	82 >	•			

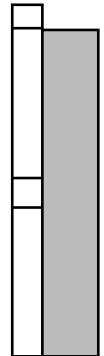
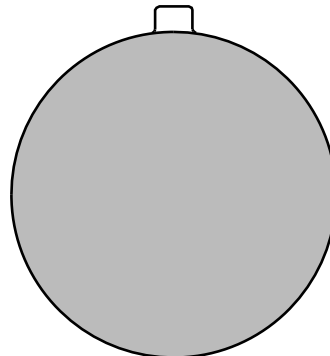
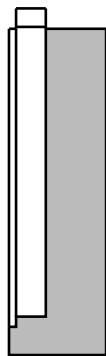
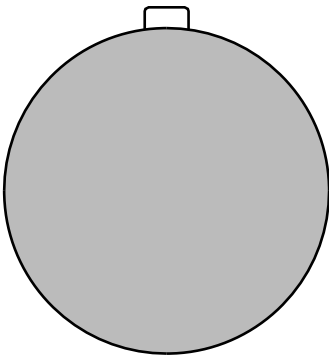
**07SU05.26**43.5 x 46.3 x 13
43.4 x 46.8 x 11.5**SUZUKI**

100 GP C	78 > 81	•
125 GP	78 >	•



07SU06.07 57.9 x 53.4 x 8.7

07SU06.SA “ “ “

07SU06.SP “ “ “

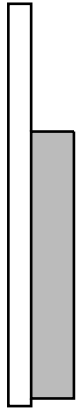
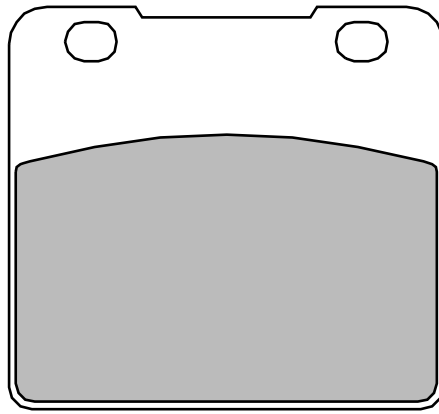

2



SUZUKI

250 GSX-R	88 >	•
400 GSX X	86 >	•
400 GSX-R	87 > 87	•
400 VS GL INTRUDER	95 >	•
500 RG GAMMA	85 > 89	•
500 RG RF	85 >	•
600 GL	96 >	•

600 VS GL INTRUDER	95 >	•
650 GSX GT	86 >	• •
700 VS GLFG	86 >	•
750 GS RF	85 >	•
750 GSX-R	85 > 87	•
750 VS INTRUDER	86 > 91	•
800 VS N, INTRUDER	91 > 96	•
1100 GSX EFE	85 >	• •

1100 GSX F	88 > 96	•
1100 GSX R	86 > 89	•
1150 GS EG	86 >	• •
1150 GS ES	84 >	• •
1400 GL CAVALCADE	87 >	•
1400 GVS CAVALCADE LXE	87 >	• •
1400 VS INTRUDER	87 > 04	• •
1500 VL INTRUDER	98 > 01	• •



07SU07.07 57.9 x 47.3 x 8.7

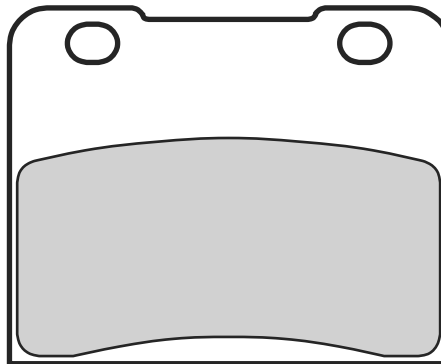

SUZUKI

250 GF S	88 >	•
250 RG GAMMA	85 > 87	•
400 GSX-R F	85 > 86	•





07SU08.08 76.8 x 53.8 x 9.5
07SU08.TT “ “ “

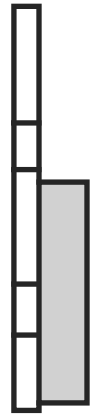
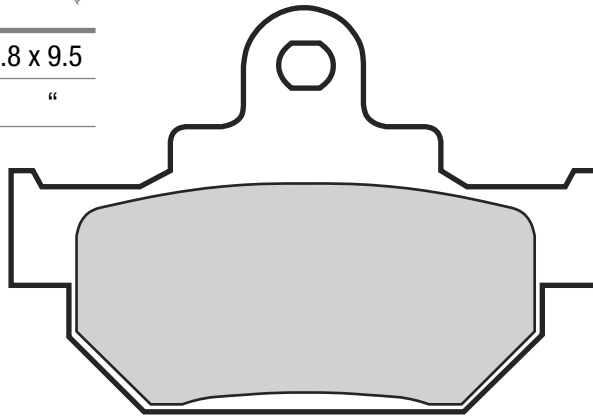

SUZUKI

125 RM G	86 >	•
250 RM G	86 >	•
500 DR	89 >	•
600 DR R, DAKAR	86 >	•
600 DR S	85 > 86	•
600 SP F	85 > 87	•



07SU09.04 76.8 x 53.8 x 7.1

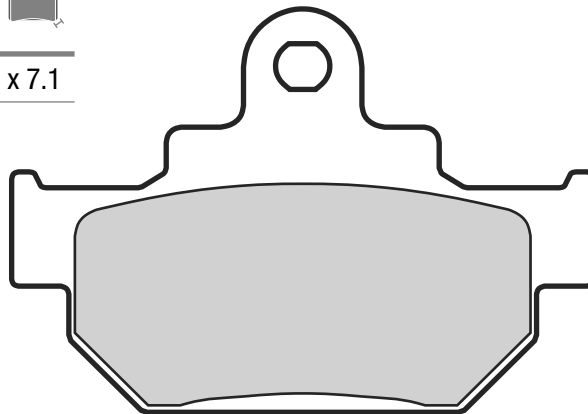

MAICO

250 CR	87 > 88	• •
250 GM STAR	86 >	• •
250 GP	87 > 88	• •
400 CR	87 > 88	• •
400 GP	87 > 88	• •
500 CR	86 >	• •
500 GP	86 >	• •

500 GP	87 > 88	• •
550 GP	87 >	• •

SUZUKI

125 INTRUDER	00 >	•
125 MARAUDER	00 >	•
125 RM	85 > 90	•
125 VL INTRUDER	02 >	•

250 INTRUDER	00 >	•
250 MARAUDER	00 >	•
250 RM	85 > 88	•
250 TU X SUPER CLASSIC	97 >	•
250 VL INTRUDER	00 > 07	•
400 LS SAVAGE	87 >	•
500 RM	85 > 86	•
650 LS	86 >	•
650 LS P SAVAGE	95 > 98	•



07SU10.05 52.4 x 43.9 x 7.2

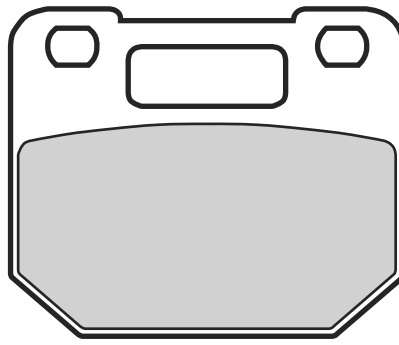

2



SUZUKI

80	RG GAMMA	88 > 93	•
125	RG GAMMA	85 > 90	•



07SU11.21 84.9 x 34.9 x 8
55.8 x 37 x 10.2

07SU11.SD “ “ “

07SU11.SX “ “ “

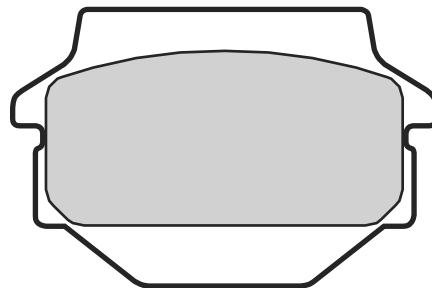
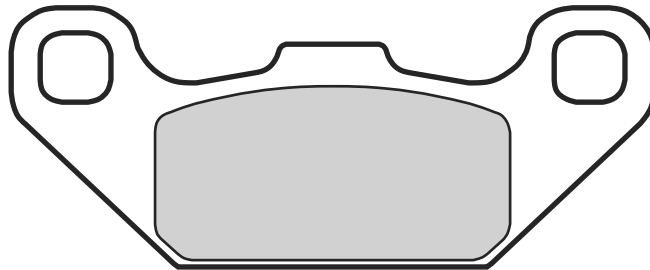

KAWASAKI

250	KSF A1-A17 MOJAVE	87 >	•
250	KXF A1, A2 TECATE	87 > 88	•
250	KXT B2 TECATE	87 >	•
300	KEF LAKOTA	95 >	•

SUZUKI

230	LT EH-EP	86 > 93	•
230	LT SF-SJ	85 > 88	•
230	LT SG	86 >	•
250	LT RF-RH	85 > 87	•



SUZUKI

250	LT RJ-RR	88 > 94	•
250	LT SK, SL	89 > 90	•
500	LT RH, RR	87 > 95	•



**07SU12.15**

76.9 x 41.9 x 8

96.6 x 41.9 x 8

07SU12.SP

" " "

07SU12.SD

" " "

07SU12.SX

" " "

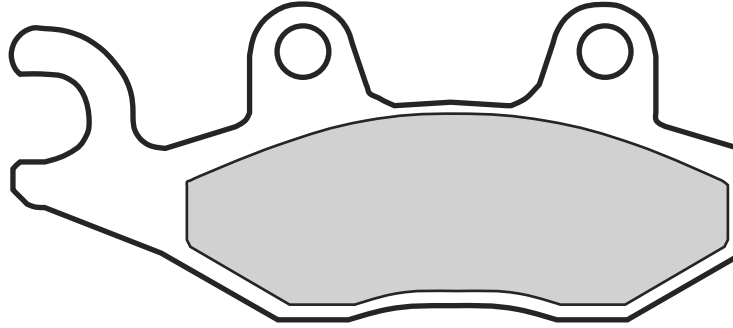
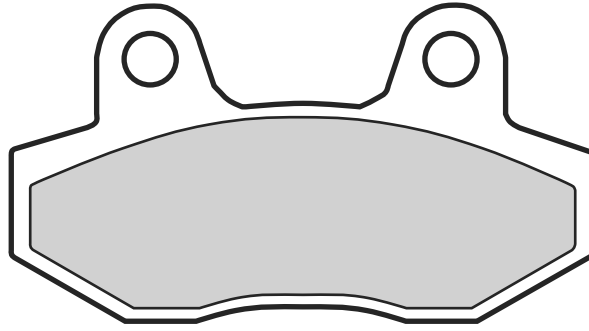
**HONDA**

125 CA REBEL	95 > 96	•
150 NSR	02 >	•
250 CMX REBEL	96 > 96	•

HUSQVARNA

125 CR	92 > 94	•
125 WR	92 > 94	•
250 CR	92 > 94	•
250 WR	92 > 94	•
350 TE	92 > 94	•

HYOSUNG

125 AQUILA	00 > 01	•
------------	---------	---

KAWASAKI

125 KLX	10 >	•
125 KLX D-TRACKER	10 >	•
125 KX	89 > 93	•
200 KDX	93 > 93	•
250 KDX D, SR	91 > 94	•
250 KLX 250	09 >	•
250 KLX S, SF	09 >	•
250 KX	89 > 93	•
252 EL	01 >	•
500 KX	89 > 93	•
750 KRF TERYX 4X4 LEFT	08 >	•

SUZUKI

125 EN	05 >	•
125 RM	91 > 95	•
125 RM H	87 > 88	•

125 RM X

89 > 90

•

125 TS R

89 >

•

200 TS R

90 >

•

250 DR S

90 > 95

•

250 LT SF QUADRACER

85 >

•

250 RM

89 > 90

•

250 RM

91 > 95

•

250 RM H

87 > 88

•

250 RMX L

89 > 95

•

350 DR SH, S, SL, SM

90 > 98

•

350 DR, S

92 >

•

500 RM H

87 >

•

TRIUMPH

800 AMERICA	03 > 06	•
800 BONNEVILLE	01 > 04	•
800 BONNEVILLE AMERICA	02 >	•
800 BONNEVILLE BLACK	04 >	•
800 BONNEVILLE T100 PAUL SMITH	06 > 08	•
800 SPEEDMASTER	03 > 04	•
865 BONNEVILLE SE	09 >	•
865 BONNEVILLE T100	09 >	•
865 NEW BONNEVILLE	09 >	•
865 SPEEDMASTER	05 >	•
900 AMERICA	07 >	•
900 BONNEVILLE	09 >	•
900 BONNEVILLE T100	09 > 16	•
900 SCRAMBLER	06 >	•
900 STREET TWIN	16 >	•
900 THRUXTON	04 >	•
950 DAYTONA T595	96 > 98	•
955 DAYTONA	99 >	•

955 DAYTONA CENTENNIAL

02 >

•

955 DAYTONA T955I

06 >

•

955 SPEED TRIPLE

99 > 04

•

955 SPRINT RS

00 >

•

1050 SPEED TRIPLE

05 > 07

•

1050 SPEED TRIPLE

08 > 13

•

1050 SPEED TRIPLE (SPECIAL EDITION)

09 >

•

1050 SPEED TRIPLE ABS

11 > 12

•

1050 SPEED TRIPLE R ABS

12 >

•

1050 SPEED TRIPLE S

05 > 07

•

1050 SPEED TRIPLE S

16 >

•

1050 SPEED TRIPLE S ABS

08 > 08

•

1050 SPRINT ST

05 > 09

•

1200 BONNEVILLE T120

16 >

•

BLACK

16 >

•

1200 THRUXTON

16 >

•

1200 THRUXTON R

16 >

•

1215 TIGER EXPLORER ABS

12 > 15

•

TIGER EXPLORER ABS

16 > 16

•

1215 (< VIN 740276)

16 > 16

•

TIGER EXPLORER

16 > 16

•

1215 SPOKED ABS (<VIN

16 > 16

•

740276)

16 > 16

•

TIGER EXPLORER XC

13 > 14

•

1215 ABS

13 > 14

•

TIGER EXPLORER XC

17 >

•

1215 ABS

17 >

•

TIGER EXPLORER XC

15 > 15

•

1215 ABS (< VIN 740276)

15 > 15

•

TIGER EXPLORER XC

16 > 16

•

1215 ABS (> VIN 740277)

16 > 16

•



1215	TIGER EXPLORER XCA ABS	16 >	•
1215	TIGER EXPLORER XCX ABS	18 >	•
1215	TIGER EXPLORER XCX Low ABS	16 >	•
1215	TIGER EXPLORER XR ABS	16 >	•
1215	TIGER EXPLORER XRT ABS	16 >	•
1215	TIGER EXPLORER XRX Low ABS	17 >	•

YAMAHA

50	FZR	92 >	•
80	YD	89 >	•
125	WR	91 > 97	•
125	XT Z	05 > 06	•
125	YZ	89 > 89	•
125	YZ	90 > 95	•
125	YZ	96 > 97	•
200	DT WR	91 >	•
200	WR	91 > 94	•
250	TT R	93 >	•
250	WR	90 > 90	•
250	WR	91 > 91	•

250	WR	92 > 97	•
250	YZ	89 > 89	•
250	YZ	90 > 91	•
250	YZ	91 > 97	•
350	TT	95 >	•
360	YZ	89 >	•
450	YXR RHINO	06 >	•
450	YZF S	04 > 05	•
500	WR	91 > 91	•
500	WR	92 > 93	•
660	RHINO left caliper	05 >	•
700	YXR RHINO RIGHT/REAR	08 >	• •



07SU13.06	58.9 x 57.8 x 8
07SU13.SA	“ “ “
07SU13.SP	“ “ “

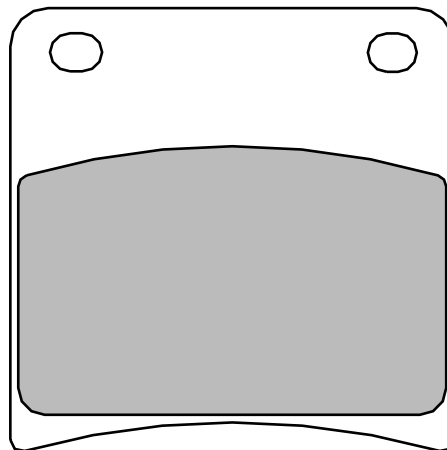

SUZUKI

400	GSX F	89 >	•
600	GSX F	88 > 97	•
750	GSX F	89 > 95	•
750	GSX KATANA	89 > 96	•
800	VX	90 > 93	•
1100	GSX F	88 > 96	•
1400	GL CAVALCADE	87 >	•





2

07SU14.07	69.8 x 55 x 8.5
07SU14.SA	“ “ “
07SU14.LA	“ “ “
07SU14.SC	“ “ “
07SU14.RC	“ “ “

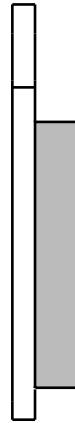
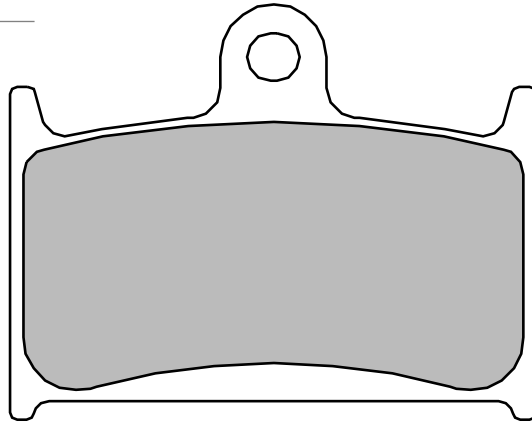

INDIAN

1800 CHIEF CLASSIC	14 >	•
1800 CHIEF VINTAGE	14 >	•
1800 CHIEFTAIN	14 >	•

MZ

1000 MUZ S	03 >	•
1000 MUZ SF	05 >	•
1000 MUZ SFX	07 >	•
1000 MUZ SN	05 >	•
1000 MUZ ST	07 >	•

PGO

125 KUNG FU	70 >	•
-------------	------	---

SUZUKI

250 RG GAMMA	88 >	•
400 GSX-R, RR	90 > 99	•
600 GSX-R	93 > 96	•
750 GSX-R	88 > 93	•
1100 GSX KATANA, F	93 > 96	•
1100 GSX R	89 > 92	•
1200 GSF BANDIT	95 > 96	•

TRIUMPH

600 DAYTONA	04 >	•
600 SPEED FOUR	03 >	•
600 TT	00 > 03	•
650 DAYTONA	05 >	•
750 DAYTONA	91 > 92	•
800 TIGER EXPLORER	12 >	•
865 SPEEDMASTER	05 >	•
900 DAYTONA	91 > 94	•
900 DAYTONA SPEED TRIPLE	94 >	•
900 DAYTONA SPRINT	94 >	•
900 SPEED TRIPLE	94 > 96	•
900 SPEED TRIPLE	97 > 01	•
900 TROPHY	96 >	•
950 DAYTONA T595	96 > 98	•
955 DAYTONA	99 >	•
955 DAYTONA CENTENNIAL	02 >	•
955 DAYTONA T955I	06 >	•
955 SPEED TRIPLE	99 > 04	•
955 SPRINT RS	00 >	•
955 SPRINT ST	99 > 04	•
1000 DAYTONA	91 > 95	•
1050 SPRINT GT ABS	10 > 15	•
1050 SPRINT GT SE ABS	10 > 15	•
1050 SPRINT ST	05 > 09	•
1200 DAYTONA	91 > 97	•

1200 TIGER EXPLORER	12 > 16	•
1200 TROPHY	96 > 03	•
1215 TIGER EXPLORER ABS	12 > 15	•
1215 TIGER EXPLORER ABS (< VIN 740276)	16 > 16	•
TIGER EXPLORER		
1215 SPOKED ABS (<VIN 740276)	16 > 16	•
TIGER EXPLORER XC ABS	13 > 14	•
1215 TIGER EXPLORER XC ABS (< VIN 740276)	15 > 15	•
1500 THUNDERBIRD	09 >	•
1600 THUNDERBIRD	09 > 16	•
1700 THUNDERBIRD NIGHTSTORM	14 > 18	•
1700 THUNDERBIRD STORM	11 >	•
2300 ROCKET III	04 > 08	•
2300 ROCKET III CLASSIC	07 >	•
2300 ROCKET III ROADSTER	11 >	•
2300 ROCKET X	15 >	•

YAMAHA

250 TZ GP	90 > 02	•
750 FZR R OW 01	89 >	•



07SU15.09	116.9 x 47.9 x 9
	97.4 x 57.9 x 11

07SU15.SA	“ “ “
------------------	-------

07SU15.TT	“ “ “
------------------	-------

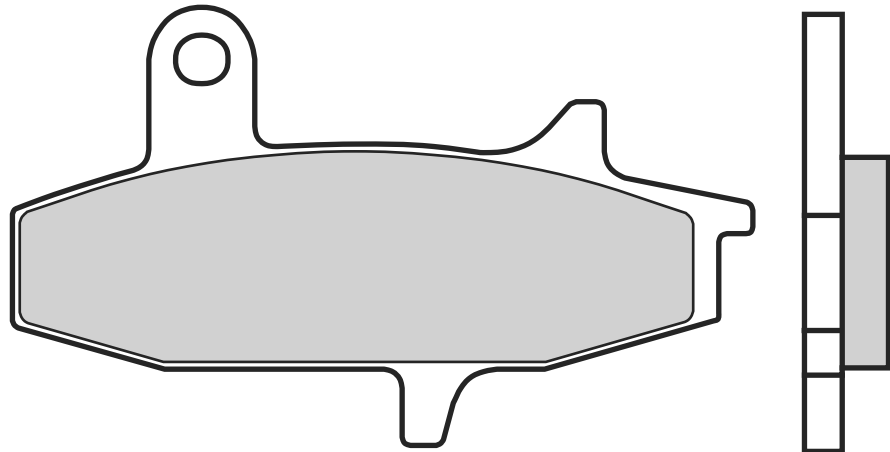
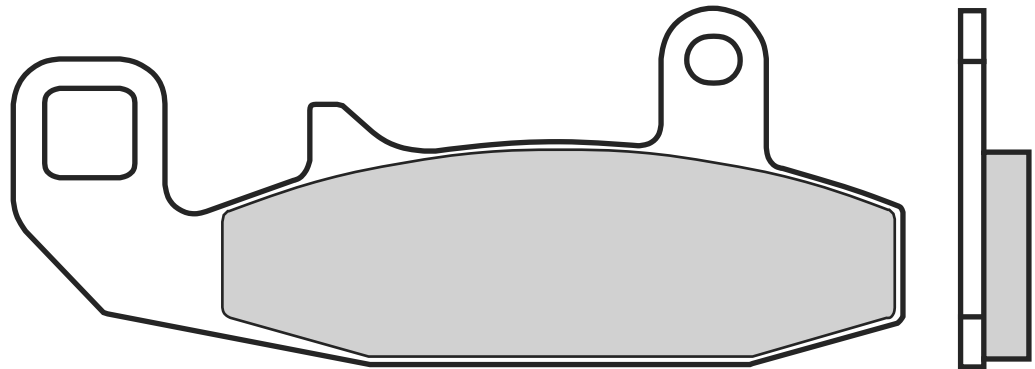

SUZUKI

600 DR RK, DJEBEL	89 >	•
650 DR R-RS	90 > 95	•
650 DR RSE	90 > 95	•
650 VS	91 >	•
750 DR BIG	88 >	•
750 DR BIG	89 >	•
750 DR S	88 >	•
800 DR BIG	90 > 90	•
800 DR S	90 > 90	•
800 DR Z	88 > 90	•
800 DR Z	91 >	•





07SU16.CC 133.5 x 37.4 x 9.8
109.2 x 44.5 x 9.8

07SU16.SP “ “ “

2

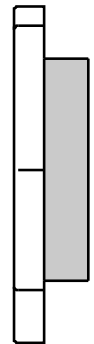
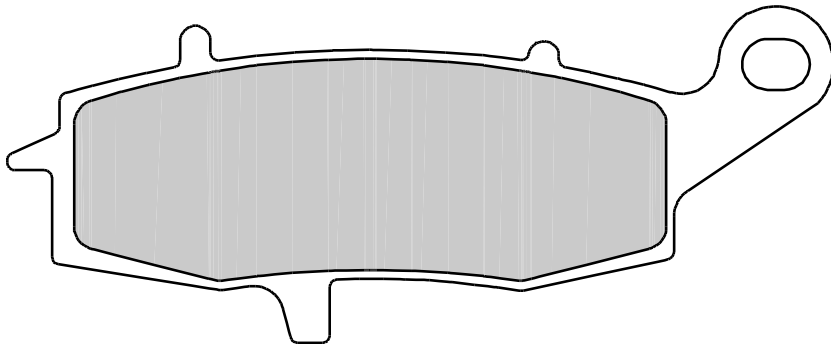
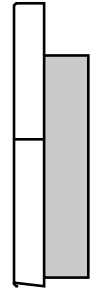
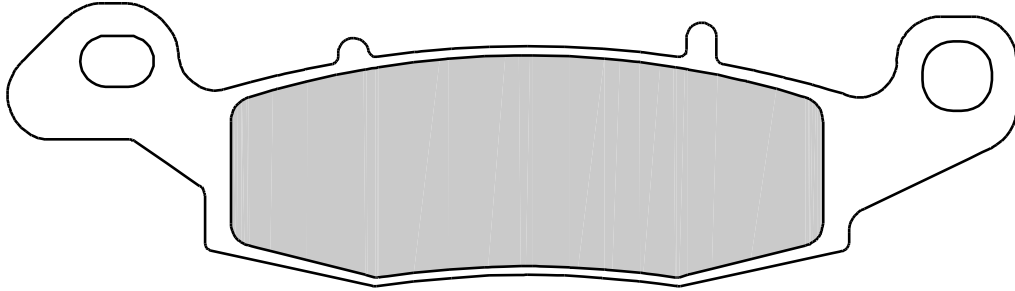

SUZUKI

1800 C R INTRUDER	08 >	•
1800 M R INTRUDER	06 >	•
1800 M R2 INTRUDER	08 >	•
1800 M RBZ INTRUDER	16 > 17	•



07SU17.18 99.2 x 44.1 x 7.4
83.2 x 47.8 x 9.8

07SU17.SP “ “ “

07SU17.TT “ “ “

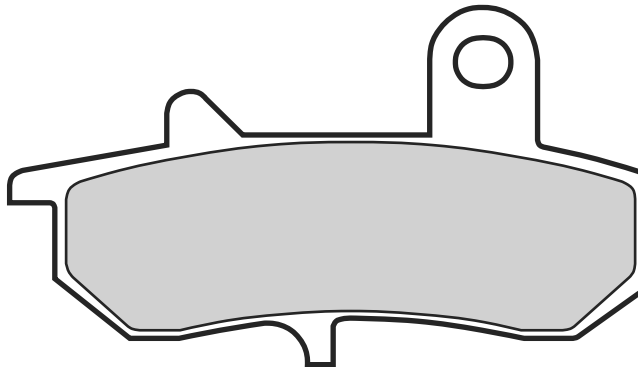
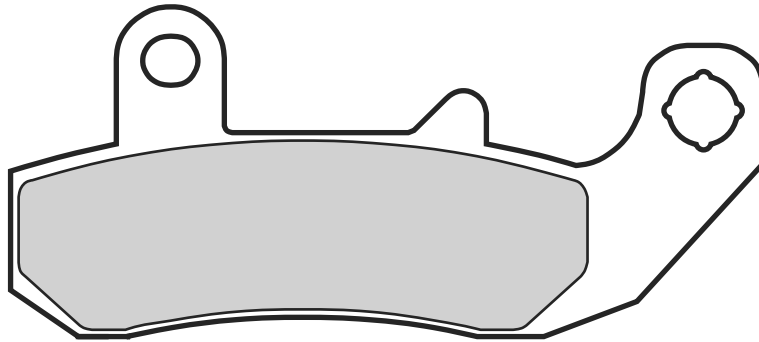

BOMBARDIER-CAN AM

998 SPYDER SPORT 16 > •

SUZUKI

125 RG 92 > •
125 RG F 92 > •
125 RG GAMMA 92 > 96 •

125 RG WOLF 92 > •
200 RG GAMMA 91 > •
200 WOLF 92 > •
250 RGV GAMMA 93 > •
600 DR RK, DJEBEL 89 > •
650 DR R-RS 90 > 95 •
650 DR RSE 90 > 95 •
650 VS 91 > •

750 DR BIG 89 > •
800 DR BIG 90 > 90 •
800 DR S 90 > 90 •
800 DR Z 91 > •

YAMAHA

125 DT TENERE SCOUT 90 > •
125 DTZ TENERE 90 > •



**07SU18.SD**

62 x 40.7 x 9.5

07SU18.TT

" " "

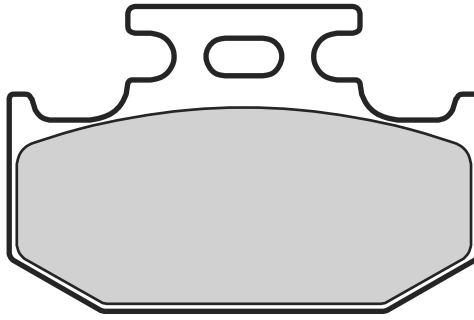
**SUZUKI**

125 RM	91 > 95	•
250 RMX L	89 > 95	•
250 RMX T	96 > 98	•
350 DR SH, S, SL, SM	90 > 98	•

350 DR V, M, X

97 >



650 DR SE T-W

96 > 98



250 YZ

91 > 97



400 WR F

98 > 98



400 YZ F

98 > 98

**YAMAHA**

125 YZ

96 > 97

**07SU19.07**

89.7 x 52.2 x 8

07SU19.SA

" " "

07SU19.LA

" " "

07SU19.SC

89.7 x 52.2 x 9.5

07SU19.RC

" " "

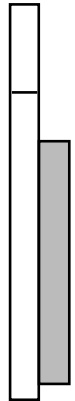
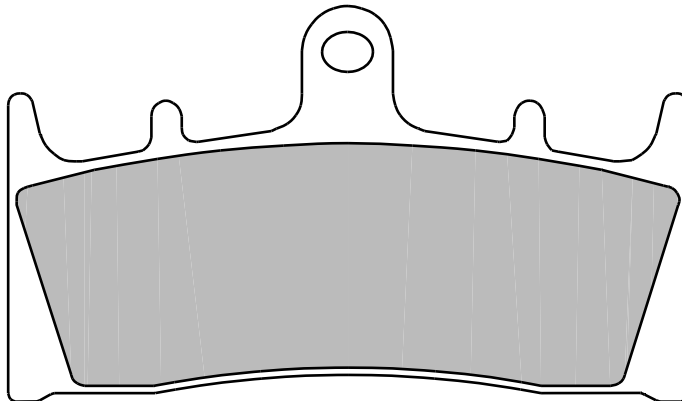
**KAWASAKI**

600 ZX-6R	98 > 02	•
636 ZX-6RR	02 > 02	•
750 ZX 7 R	96 > 99	•
900 ZX 9R	96 > 97	•
900 ZX 9R	99 > 01	•
1100 ZRX	96 > 00	•
1200 ZRX, R, S	01 >	•

1200 ZX12R NINJA

00 > 03



1500 VN

02 >



1500 VN MEAN STREAK

02 > 03



1600 VN

04 >



1600 VN MEAN STREAK

04 > 04



1000 GSX

01 >



1000 GSX R

01 > 02



1000 TL R

98 >



1100 GSX R

93 >



1200 GSF BANDIT

01 >



1200 GSF BANDIT S

01 >



1300 GSX R HAYABUSA

99 > 07



1400 GSX

02 >



1600 VZ MARAUDER

04 >

**SUZUKI**

750 GSX-R

94 > 99





07SU20.07

52.5 x 56.3 x 8.7

07SU20.SP

“ “ “

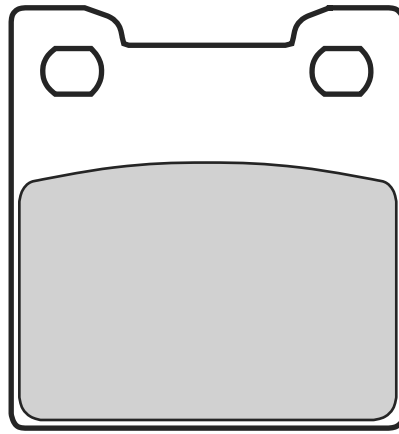

2



SUZUKI

900 RF RR

94 > 96



07SU22.SA

69.8 x 55 x 7

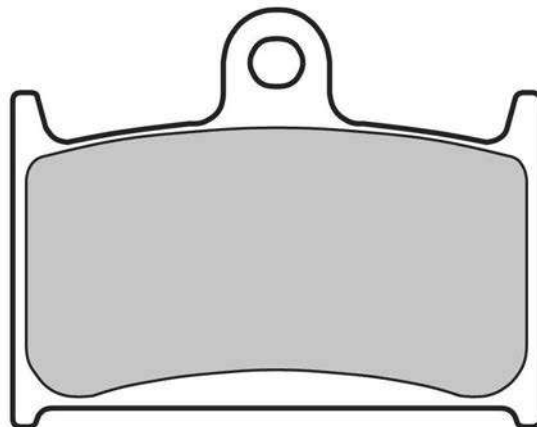

SUZUKI

900 RF RR

94 > 96



1200 GSF BANDIT

97 > 00



**07SU25.SP**

59.7 x 57.1 x 9

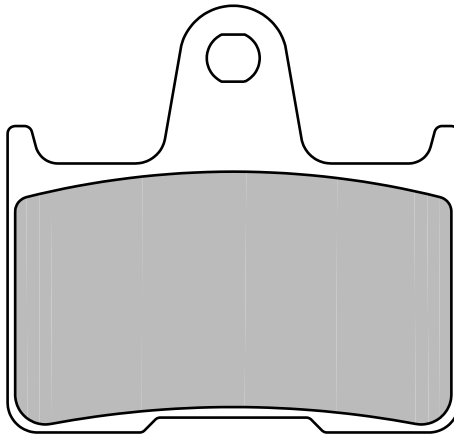
**SUZUKI**

600 GSX-R	04 > 05	•
650 GSF BANDIT	06 > 11	•
650 GSF BANDIT S	06 > 11	•
750 GSX-R	04 > 05	•
1000 GSX R	01 > 02	•
1000 GSX R	12 > 16	•
1000 GSX R K3	03 > 03	•
1000 GSX R K4	04 > 06	•
1400 GSX	02 >	•

**07SU26.SA**

38.7 x 49.2 x 7.9

07SU26.LA

" " "

07SU26.SC

38.7 x 49.2 x 9.5

07SU26.RC

" " "

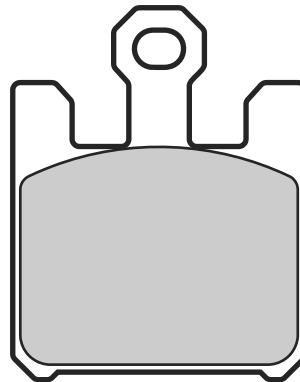
**KAWASAKI**

600 ZX-6R	03 > 04	•
600 ZX-6RR	05 > 06	•
636 ZX-6R	05 > 06	•
636 ZX-6RR	03 > 04	•

750 Z R	11 >	•
1000 ZX 10 R	04 > 07	•
1200 ZX12R NINJA	04 > 06	•
1600 VN CLASSIC TOURER	05 >	•
1600 VN MEAN STREAK	05 >	•

SUZUKI

1000 GSX R K3	03 > 03	•
1600 M INTRUDER	05 >	•
1600 M95 BOULEVARD	05 >	•
1800 VRZ INTRUDER	06 >	•



07SU27.SA 71.1 x 49.6 x 8

07SU27.LA “ “ “

07SU27.SC 71.1 x 49.6 x 9

07SU27.RC “ “ “

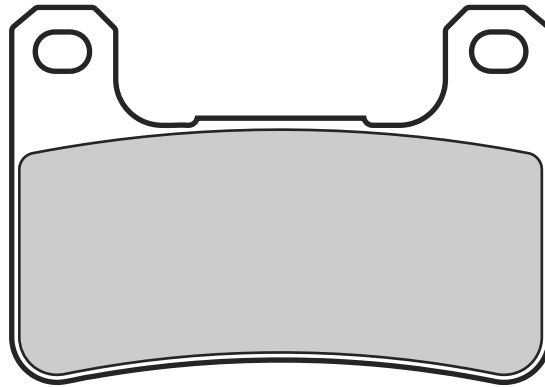

KAWASAKI

900 Z 900 RS	18 >	•
900 Z RS CAFE' RACER	18 >	•
1000 H2 SX	18 >	•
1000 H2 SX SE	18 >	•
1000 NINJA (RAD. CAL) SE	18 >	•
1000 Z	10 >	•
1000 Z (RAD. CAL)	10 > 13	•
Z 1000 SUGOMI		
1000 EDITION	16 >	•
1000 Z SX	11 >	•
1000 Z SX ABS	11 >	•

1000 ZX 10 R	08 > 10	•
1000 ZX 10 R	11 > 15	•
1000 ZX 10 R (ABS)	08 > 10	•
1000 ZX 10 R (ABS)	11 > 15	•

KTM

790 ADVENTURE	18 >	•
---------------	------	---

SUZUKI

600 GSX-R	04 > 05	•
600 GSX-R	06 > 10	•

750 GSX-R	04 > 05	•
750 GSX-R	06 > 10	•
1000 DL V STROM	14 > 16	•
1000 DL V STROM ABS	14 >	•
1000 DL V STROM XT	17 >	•
1000 GSX R	09 > 11	•
1000 GSX R K4	04 > 06	•
1000 GSX R K7	07 > 08	•
1300 GSX R HAYABUSA	08 > 12	•
1800 M R INTRUDER	06 >	•
1800 M R2 INTRUDER	08 >	•
1800 M RBZ INTRUDER	16 > 17	•



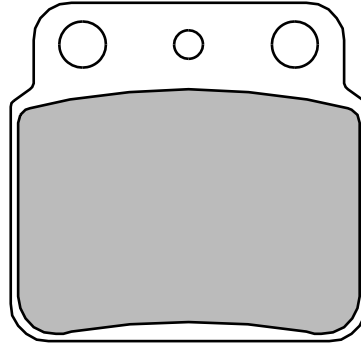

07SU29.06	47.1 x 45.1 x 7.4
07SU29.SD	“ “ “
07SU29.SX	“ “ “

**ARCTIC CAT**

400 DVX 04 > •

KAWASAKI

400 KFX 02 > •

450 LT-R 06 > •
500 LT RH, RR 87 > 95 •**HYOSUNG**400 TE 05 > •
450 TE 07 > •**SUZUKI**250 LT RJ-RR 88 > 94 •
400 LT-Z QUAD SPORT 02 > •

07SU30.02	69.5 x 46.2 x 13
07SU30.SP	“ “ “

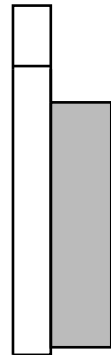
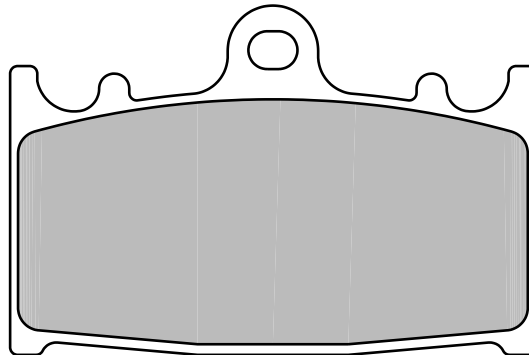
**SUZUKI**1500 C INTRUDER (LEFT CALIPER) 05 > 10 •
1500 VL INTRUDER 02 > •



07SU31.SD

99.2 x 39.7 x 7.6
75.4 x 40.7 x 8.4

2

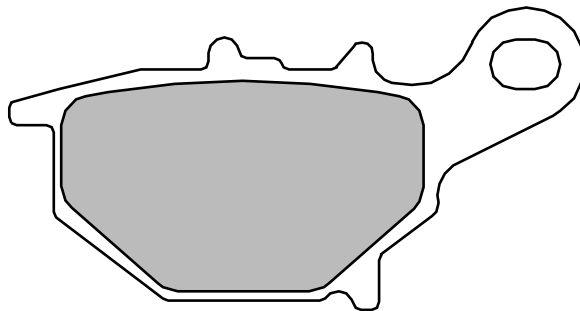
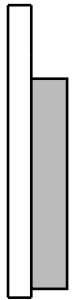
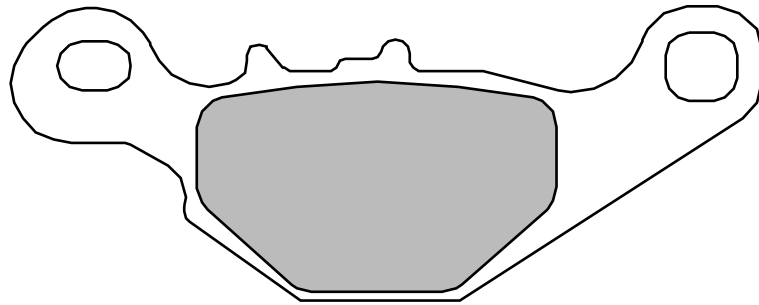

SUZUKI

85 RM

05 >





07SU32.SP

88.9 x 40.1 x 9.7

2

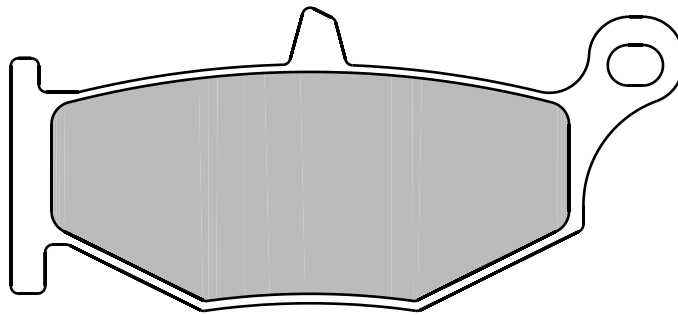
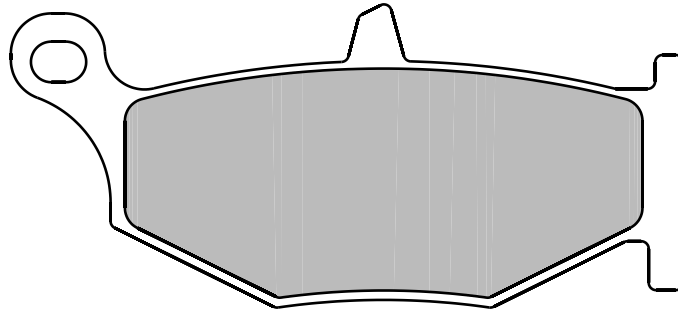

SUZUKI

600 GSR	06 > 11	•
600 GSX-R	06 > 10	•
750 GSX-R	06 > 10	•

1000 DL V STROM	14 > 16	•
1000 DL V STROM ABS	14 >	•
1000 DL V STROM XT	17 >	•
1000 GSX R K7	07 > 08	•

1300 GSX R HAYABUSA	08 > 12	•
1300 GSX R HAYABUSA (RED CALL)	13 >	•
1340 B-KING	08 >	•



07YA01.13

44.9 x 50.8 x 15.5
44.9 x 44.9 x 12

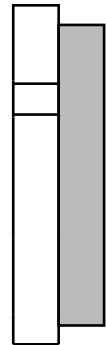
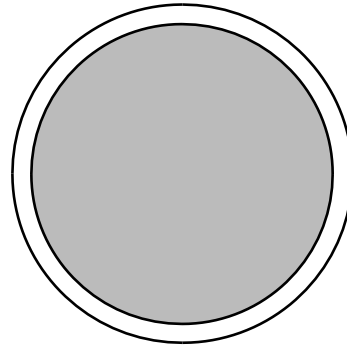
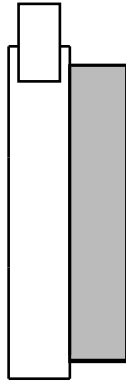
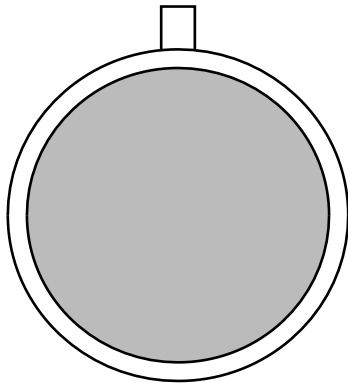

YAMAHA

90 RD	76 >	•
100 RD D	76 > 79	•

100 RX	76 > 79	•
100 RX DX	77 > 79	•
125 RD B, C	76 > 77	•

125 RD DX	76 > 78	•
125 RS DX	76 > 79	•
200 RD DX	76 > 78	•



07YA02.07

47.9 x 68.2 x 9

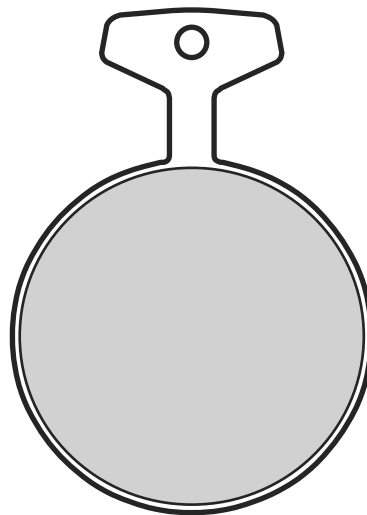

YAMAHA

250 RD B, S	73 > 77	•
250 RD C	77 > 78	• •

250 TZ	82 >	•
350 RD	73 > 79	•
350 XS B	76 >	•
400 RD C, D, E	77 >	• •

400 RD S	73 > 76	•
650 TX	72 >	•
650 XS B, C, XS2	75 > 77	•
750 TX A	73 > 76	•





07YA03.09

66.8 x 49.4 x 11

2

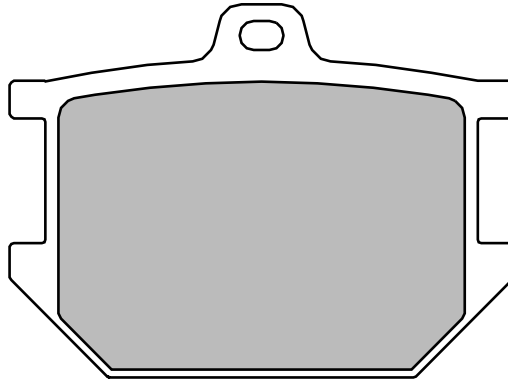

YAMAHA

250	XS C	77 >	• •
250	XS D, E	79 >	•
350	XS C, D	77 >	• •
400	RD	79 >	•
400	RD F, G	79 > 80	•
400	SR 2J4	77 >	• •
400	XS C, E, F	77 > 79	• •
500	SR	85 >	•
500	SR E, F, G, H	78 > 79	•
500	XS C, D, E	77 >	• •
650	XJ	80 >	•
650	XJ RJ	82 >	• •
650	XS D1E, F, F2	77 > 79	•

650	XS SE, SP	78 > 80	• •
650	XS SJ, SK	82 >	• •
650	XS SK,HERITAGE	83 >	• •
650	XS SPECIAL	79 >	• •
700	FZ	87 >	•
750	XJ E	81 >	•
750	XS D, E, F	77 > 79	• •
750	XS SE	78 >	• •
750	XS SE, SG, LH	80 > 81	•
850	XS	81 >	•
850	XS G, H	80 >	• •
850	XS LG, SG	80 > 81	• •
850	XS SG, SH, LG, LH LEFT CALIPER	81 >	•

850	XS SG, SH, LG, LH right caliper	81 >	•
920	XV RH, RJ	81 > 82	•
920	XV TR1	81 >	•
1000	TR 1	81 >	•
1000	XV	81 >	•
1000	XV TR1	81 > 85	•
1100	XS S, SP	81 >	•
1100	XS SG, SH, LG left caliper	81 >	•
1100	XS SG, SH, LG right caliper	81 >	•



07YA04.13

94.4 x 56.9 x 7.5

2

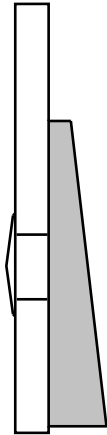
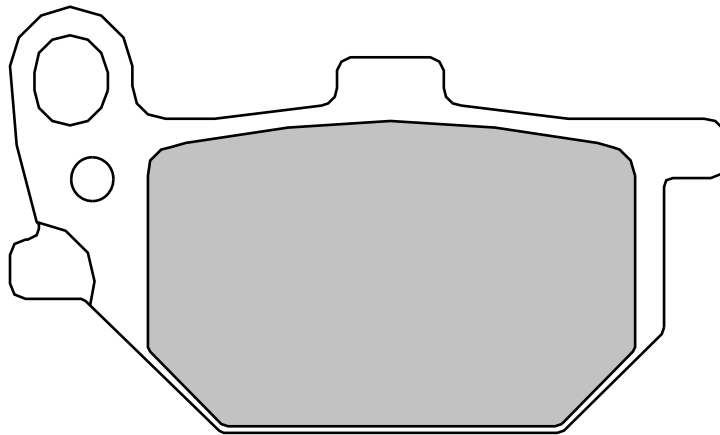
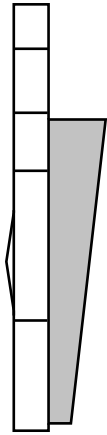
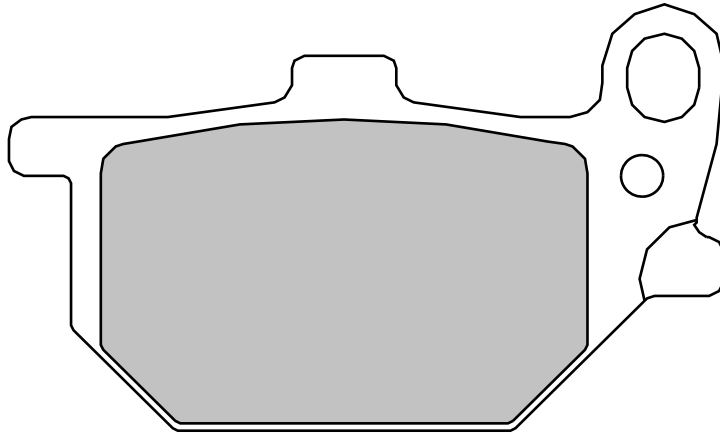

SUZUKI

250 RD E, F	78 > 79	•
400 RD	79 >	•

YAMAHA

250 RD DX left caliper	80 >	•
250 RD E	78 >	• •

250 XS SE, SF	80 >	•
400 RD D, E, F	78 >	• •
400 RD F, G	79 > 80	•
400 XS SE	80 > 81	•
400 XS SG, SH, SF	80 >	•
650 XJ 4H7	80 >	•
650 XJ G, H, SH right caliper	80 >	•
750 XS SE, SG, LH	80 > 81	•

750 XV MK	83 >	•
850 XS SG, SH, LG, LH right caliper	81 >	•
1100 XJ J	82 >	•
1100 XJ LH	81 >	•
1100 XS SG, SH, LG left caliper	81 >	•





07YA05.27

41.9 x 44 x 16

41.9 x 44 x 10

2

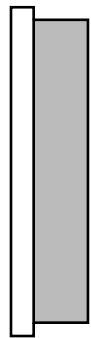
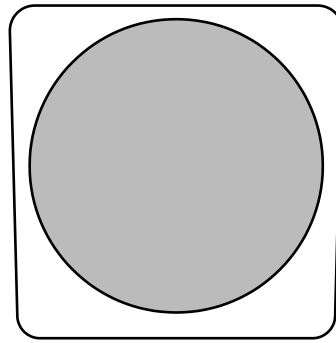
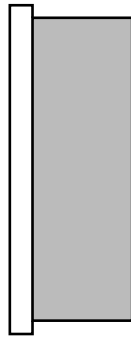
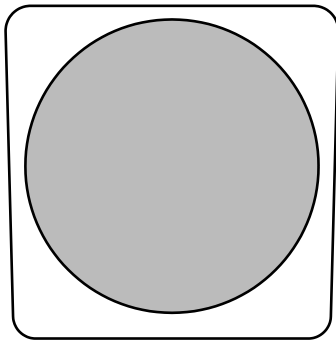

YAMAHA

50	RD M	78 > 80	•
100	RX DX	80 > 82	•
125	RD DX/S	78 >	•
125	RS	82 > 86	•
125	RS DX	80 >	•
200	RD DX	78 >	•



07YA06.09

65.9 x 58.9 x 10

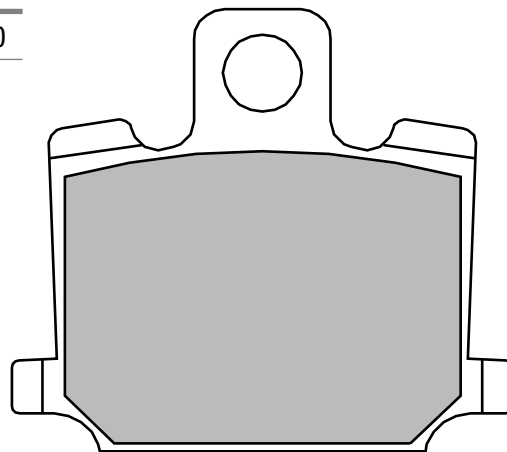

YAMAHA

250	RD LC	80 > 80	•
350	RD LC	80 > 80	•
400	XJ	80 > 81	•
1100	XS SP	80 >	•



07YA07.13

94.4 x 56.9 x 7.5

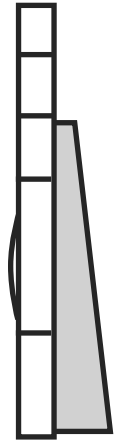
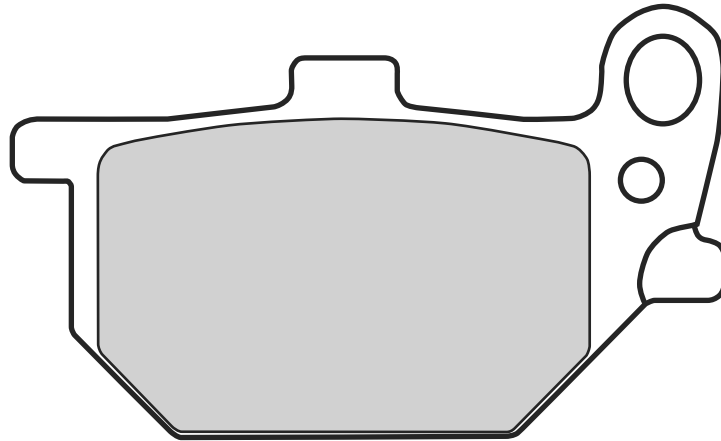

2

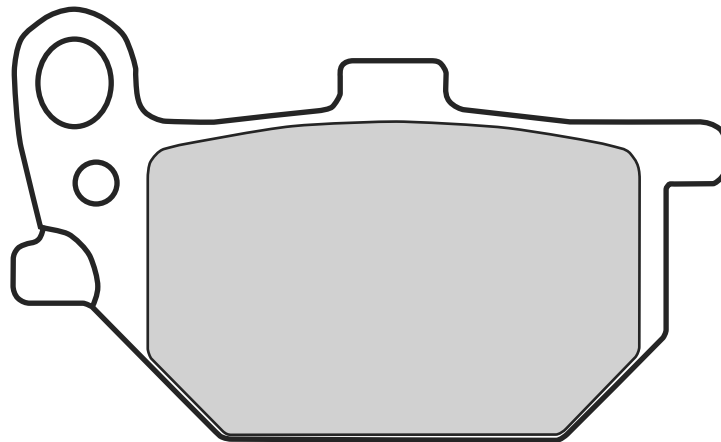

YAMAHA

250	RD DX right caliper	80 >	•
400	RD F, G	79 > 80	•
400	XS SE	80 > 81	•
650	XJ G, H, SH left caliper	80 >	•
650	XS G, H, J, K	80 > 82	•
750	XS H, J, K	81 > 82	•
750	XS SE, SG, LH	80 > 81	•
750	XV SE V-TWIN	81 >	•
850	XS SG, SH, LG, LH LEFT CALIPER	81 >	•
920	XV K, MK, VIRAGO	83 >	•
1100	XS SG, SH, LG right caliper	81 >	•



**07YA08.09**

65.4 x 59 x 10

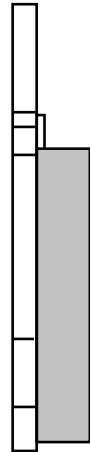
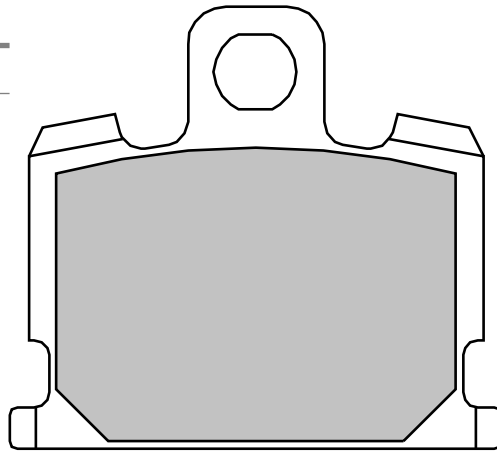
**YAMAHA**

50 RD MX	81 > •	550 MAXIM	81 > •	750 XJ SECA	81 > •
50 RX K	83 > •	550 XJ H, J, RH, RJ	81 > •	920 XV J	82 > •
80 RD	81 > •	550 XJ K, MAXIM	83 > •	920 XV VIRAGO	81 > •
80 RX SPECIAL	82 > •	550 XJ SECA	81 > •	1000 XV	83 > •
250 RD LC	81 > 82 •	550 XZ	82 > 82 •	1100 MAXIM	81 > •
350 RD LC	81 > 82 •	650 XJ SECA	81 > •	1100 XJ J	82 > •
400 XJ MAXIM, SECA	81 > •	750 MAXIM	81 > •	1100 XJ LH	81 > •
		750 XJ A, RH, RJ	81 > •	1100 XS S, SP	81 > •

**07YA09.CC**

44.5 x 53.4 x 8.6

07YA09.SA

" " "

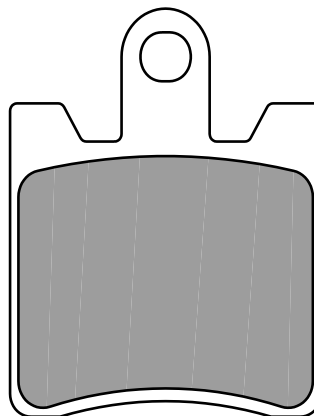
**TRIUMPH**

1200 TROPHY	13 > •
1215 TROPHY	13 > 16 •
1215 TROPHY SE	13 > 16 •

YAMAHA

1300 FJR A	13 > •
1300 FJR ABS	06 > 12 •
1300 FJR AS	13 > •



07YA10.11

68 x 58.6 x 10.7

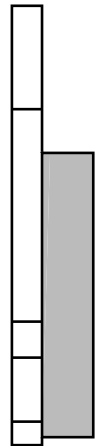
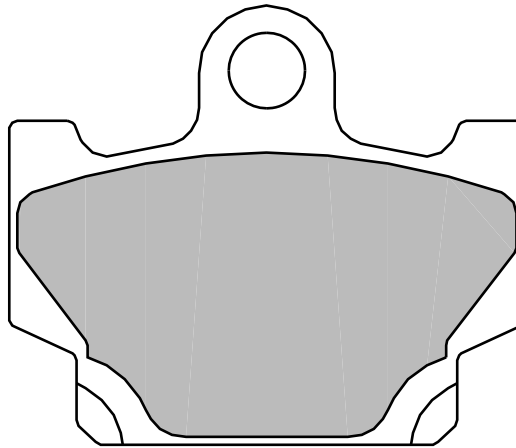

2



YAMAHA

80 DT LC	81 > 82	•	250 RD LC	83 >	•	500 XV SE	83 >	•
80 RC LC	82 >	•	250 XV	88 > 90	•	500 XZ S	83 >	•
80 RD LC1-2	81 >	•	350 RD LC, LC YPVS	83 > 84	•	550 XZ	83 >	•
100 RX	84 >	•	400 FZ N	87 >	•	550 XZ RJ, RK	82 > 83	•
115 RX S	82 >	•	400 XS	85 >	•	600 XT TENERE'	83 > 86	•
125 RD LC	82 >	•	400 XS DOHC	82 >	•	650 XJ J, L, LK	82 > 83	•
125 SR	92 >	•	400 XS MAXIM, SECA	82 >	•	650 XJ T	81 >	•
240 XV VIRAGO	92 > 06	•	400 XS RJ, RK, J, K	82 > 83	•	650 XJ TURBO	83 >	•
			500 XT AUSTRIA	83 >	•	750 XJ J, K, MK	82 >	•
			500 XV K VIRAGO	83 >	•	920 XV K, MK, VIRAGO	83 >	•





07YA11.07 63.3 x 54.7 x 8.7

07YA11.SA “ “ “

07YA11.SP “ “ “

2

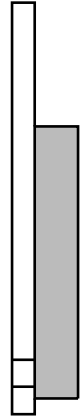
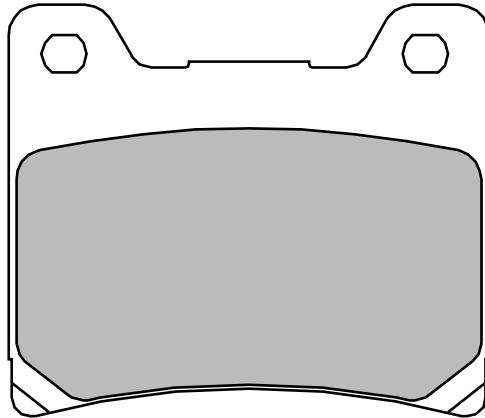

YAMAHA

100 FJ L, LC	84 >	• •
100 RD	80 >	•
125 TZR	93 > 93	•
125 TZR	94 > 94	•
250 FZ PHAZER	85 >	•
250 RD LC	83 >	•
250 TDR	88 >	•
350 RD LC	85 > 85	• •
350 RD LC, LC YPVS	83 > 84	•
400 FZR	85 > 87	•
400 SRX	90 >	•
400 XS Z	83 >	• •
500 RD	83 > 84	• •
500 RD LC	85 >	•
600 FJ	84 >	• •
600 FZ S,SC	86 > 87	• •
600 FZR	89 > 89	• •
600 FZR	90 > 91	•
600 FZR	92 > 96	• •
600 FZR R	94 > 95	•
600 SRX	88 > 89	•
600 SRX	90 >	•
600 XJ	83 > 90	• •
600 YX RADIAW	87 >	•
600 YZF R THUNDER CAT	96 > 99	•
700 FZ	87 >	•
700 FZX FAZER	87 >	• •

700 XJ	86 >	•
700 XJ MAXIM	85 >	•
700 XV L, LC	84 >	• •
700 XV VIRAGO	87 >	•
750 FZ	85 > 86	•
750 FZ GENESIS	87 > 88	• •
750 FZ GENESIS	89 >	•
750 FZR GENESIS	87 >	•
750 FZR R OW 01	89 >	•
750 FZX	86 > 87	• •
750 MAXIM	81 >	•
750 TX A	73 > 76	•
750 VF VIRAGO	88 >	•
750 XJ	83 > 86	• •
750 XV	89 > 92	•
750 YZF R	93 > 97	•
750 YZF SP	93 > 97	•
850 TDM	91 > 95	•
850 TDM	96 > 01	•
850 TRX	95 >	•
900 XJ DIVERSION	94 >	•
900 XJ F	83 > 86	• •
900 XJ N	83 > 86	• •
900 XJ S	94 >	•
900 XJ STRIDER	83 >	• •
920 XV VIRAGO	81 >	•
1000 FZR EX-UP	90 > 91	•
1000 FZR EX-UP	92 > 93	•
1000 FZR EX-UP	94 > 95	•

1000 FZR GENESIS	87 > 89	•
1000 GTS	93 >	•
1000 XV L, C	84 >	• •
1000 XV VIRAGO	86 > 93	•
1000 YZF THUNDER ACE	96 > 00	•
1100 BT BULLDOG	02 >	•
1100 FJ	83 >	• •
1100 FJ J	84 >	• •
1100 XV VIRAGO	86 > 93	•
1100 XV VIRAGO	99 > 01	•
1100 XVS DRAG STAR	99 > 06	•
1100 XVS DRAG STAR CLASSIC	00 > 06	•
1200 FJ	84 > 88	• •
1200 FJ	89 >	•
1200 FJ ABS	91 >	•
1200 V MAX	85 > 92	• •
1200 V MAX	93 > 01	•
1200 VXZ L, K2C	84 >	• •
1200 XJR	94 > 98	•
1200 XJR ITALIA	95 > 98	•
1200 XJR SP	97 > 98	•
1200 XV DL,DC2	84 >	• •
1200 XV VENTURE ROYALE	85 >	• •
1200 XV Z12T VENTURE	83 >	• •
1200 XVT VENTURE ROYALE	84 >	• •
1300 XJR	99 > 01	•
1300 XJR SP	99 > 01	•



07YA12.07 67.8 x 55.9 x 8.7

07YA12.SA “ “ “

07YA12.SP “ “ “

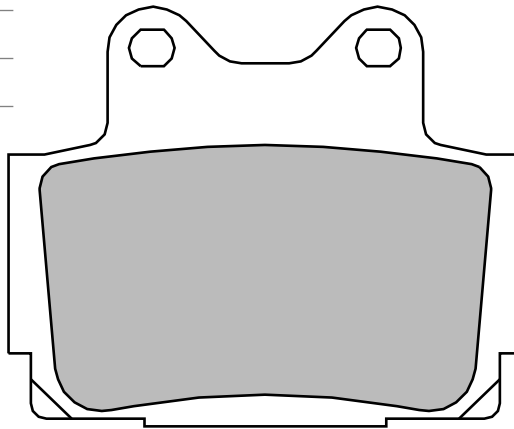

2



YAMAHA

50	FZR	90 >	•
80	TZR	87 > 91	•
125	RD	87 >	•
125	RD LC YPVS	85 >	•
125	TZR	87 > 88	•
125	TZR	89 > 92	•
125	TZR R	94 > 94	•
200	SDR	88 >	• •
250	FZR	87 > 88	•
250	FZR R	89 > 97	•
250	FZX	91 > 97	•

250	FZX ZEAL	91 > 97	•
250	RZ RR	88 >	• •
250	SRX	87 >	•
250	TDR	89 >	•
250	TZR	87 > 88	•
250	TZR	89 > 92	•
350	RD F	85 > 85	• •
350	RD LC	86 > 92	• •
400	FZ N	87 >	•
400	FZR	85 > 87	•
400	FZR	88 > 89	•
400	FZR	90 > 94	•

400	FZR R	91 > 94	•
400	SRX	85 > 86	•
400	SRX	87 > 89	•
400	XJ DIVERSION	91 >	•
500	RD LC	85 >	•
600	FZ 6 FAZER	98 > 03	•
600	FZS FAZER	98 > 03	•
600	SRX	86 > 87	• •
600	XJ DIVERSION	91 > 97	•
600	XJ DIVERSION	98 > 03	•
750	FZ	85 > 86	•
750	FZR	87 >	•



07YA13.SD 90.8 x 30.1 x 7.2

07YA13.SX “ “ “

07YA13.TT “ “ “

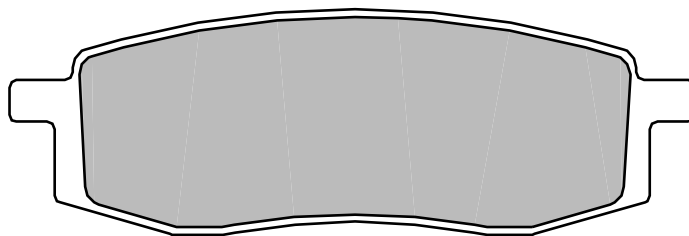

YAMAHA

125	YZ	85 > 87	•
125	YZ	88 > 88	•
200	IT	86 >	•

225	TT	86 >	•
250	NX	88 >	•
250	TT	87 > 92	•
250	YZ	85 > 87	•
250	YZ	88 > 88	•

350	TT	86 > 91	•
490	YZ	85 > 87	•
490	YZ	88 > 90	•
500	YZ	88 >	•
600	TT	90 > 92	•





07YA14.07 70.9 x 36.1 x 9.2

07YA14.SD “ “ “

07YA14.SX “ “ “

2

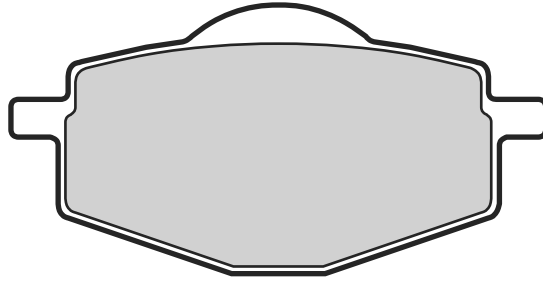

GILERA

125 APACHE	91 > 93	•
125 RC TOP RALLY	89 >	•
250 OREGON QUAD	07 >	•
600 R, RC	91 >	•
600 RC	88 >	•

YAMAHA

50 DTR MX	89 > 95	•
50 TDR	90 >	•
50 TZM	94 >	•
50 TZR	90 > 92	•
50 Y SLT	87 > 92	•
50 Y SR	87 > 92	•
80 DT LC2	85 > 01	•
80 RD LC	83 > 86	•
80 RD LC	87 >	•
80 TDR	89 >	•
80 YSR	86 > 88	•
125 DT LC	85 >	•
125 DT R	96 > 98	•

125 DT R, ELECTRIC	88 >	•
125 SR FLAME	96 >	•
125 TDR	93 >	•
125 TDR R	93 >	•
125 TZR	89 > 92	•
125 XC F	00 >	•
125 YZ	88 > 88	•
180 RT	95 > 96	•
200 DT	84 > 88	•
200 DT R	85 > 87	•
200 DT R	89 >	•
200 IT	85 > 85	•
200 TT	86 >	•
200 TW	90 > 91	•
225 SERROW	88 >	•
225 TT R S, T	01 >	•
225 TT T	87 > 00	•
225 XT E, F	92 > 00	•
250 IT	85 >	•
250 TY Z SCOTTISH	96 >	•
250 WR	91 > 91	•
250 YTZ	85 > 86	•

250 YZ	88 > 88	•
350 XT	85 > 90	•
350 XT	91 >	•
350 XT B, G	91 > 96	•
350 YFM XT	87 > 88	•
350 YFM XT, XU WARRIOR	87 > 88	•
350 YFZ D	92 >	•
350 YFZ T-W BANSHEE	87 > 89	•
400 ARTESIA	91 >	•
400 XT	86 >	•
490 YZ	88 > 90	•
500 WR	91 > 91	•
500 XT	86 >	•
500 XT E	90 > 96	•
500 YZ	88 >	•
600 DT N	85 >	•
600 TT	85 > 88	•
600 XT E	90 > 98	•
600 XT K	90 > 98	•
600 XT TENERE'	87 > 89	•
660 XTZ TENERE'	91 > 98	•



07YA15.19 46.5 x 46.5 x 16.3

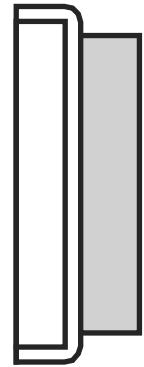
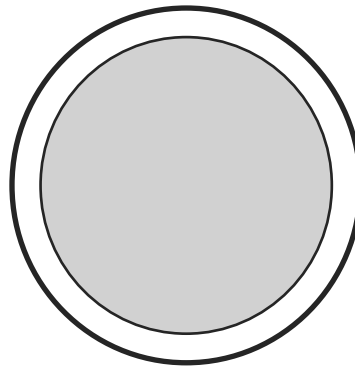

2



YAMAHA

125	YT	80 > 81	•	225	YFM S-U MOTO 4	86 > 88	•	350	YFM E	87 > 92	•
175	YT	82 > 83	•	225	YTM DRN, DRS TRI MOTO	85 > 86	•	350	YFM ERT, ERU	87 > 88	•
200	YFM DXS-DXW MOTO 4	86 > 87	•	225	YTM DXK-DXN TRI MOTO	83 > 85	•	350	YFM ERW, ERA-G	89 > 95	•
200	YFM N MOTO 4	85 > 89	•	225	YTM DXN	83 > 84	•	350	YFM FWT, FWU BIG BEAR	87 > 88	•
200	YTM K-N TRI MOTO	83 > 85	•	250	YFM W, A, B	89 > 91	•	350	YFM FWW, FWA-G BIG BEAR	89 > 95	•



07YA16.05 82.6 x 22 x 7.2

07YA16.SD “ “ “

07YA16.SX “ “ “

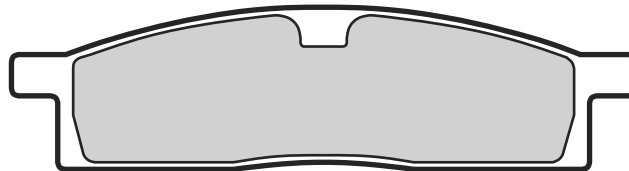

YAMAHA

50	DT LCD	98 > 01	•
80	YZ	86 > 92	•
80	YZ E, F, G, H1, J1	93 > 01	•
85	YZ	02 >	•
125	TT-R LW	00 >	•





07YA17.11 74.3 x 53.9 x 10.5

07YA17.SA “ “ “

07YA17.SP “ “ “

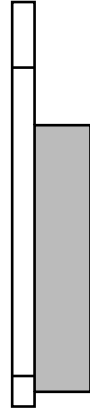
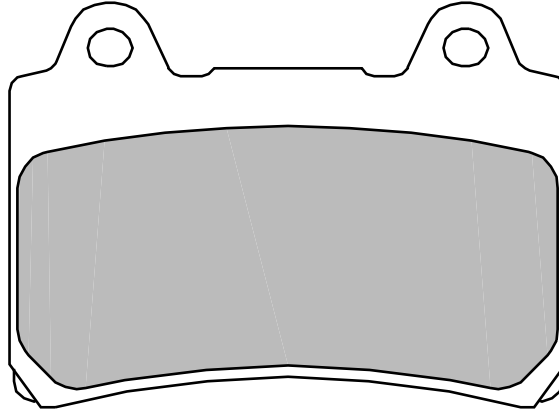

YAMAHA

250 FZR	87 > 88 •	750 FZR	87 > •	1300 XVZ TD VENTURE ROYALE	86 > 95 • •
250 SRV	92 > •	850 TDM	91 > 95 •	1300 XVZ TF ROYAL STAR VENTURE	99 > 00 •
250 TDR	88 > •	1000 FZR GENESIS	87 > 89 •	1300 XVZ TF VENTURE STAR	99 > •
250 TDR	89 > •	1200 FJ	89 > •	1600 WILD STAR	99 > •
250 TZR	87 > 88 •	1200 FJ ABS	91 > •	1700 XV ROAD STAR WARRIOS	02 > •
400 FZR	88 > 89 •	1300 XVZ A ROYAL STAR	96 > 98 •		
400 SRX	87 > 89 •	1300 XVZ ROYAL STAR BOULEVARD	99 > •		
600 SRX	88 > 89 •	1300 XVZ ROYAL STAR TOUR C.	97 > •		
750 FZ GENESIS	89 > •				



07YA18.09 71 x 38.7 x 10

07YA18.SA “ “ “

07YA18.TT “ “ “

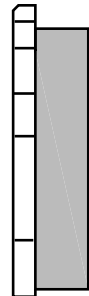
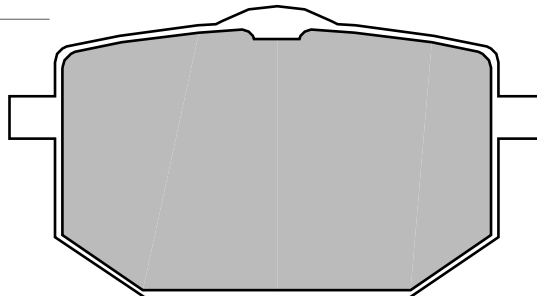

MALAGUTI

50 MDX ENDURO	87 > •	180 RT	90 > 93 •	600 XT	86 > 89 •
		600 TT	89 > 89 •	600 XT TENERE'	87 > 89 •

YAMAHA



07YA19.09

79.9 x 42.5 x 10

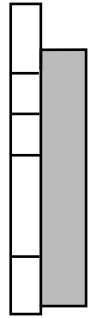
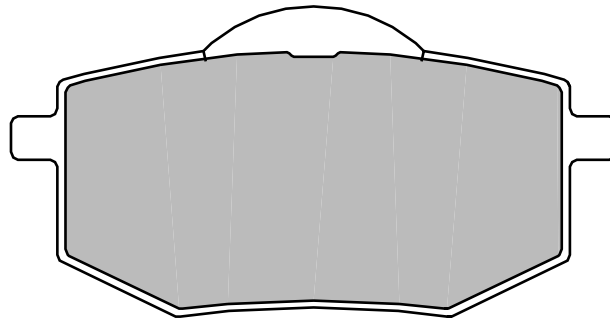

2



YAMAHA

250	XV VIRAGO	89 > 94	•
400	XV VIRAGO	88 >	•
535	XV VIRAGO	88 > 95	•





07YA20.08	76.9 x 41.9 x 8
	96.6 x 41.9 x 9.7

07YA20.SP	“	“	“
------------------	---	---	---

07YA20.TT	“	“	“
------------------	---	---	---

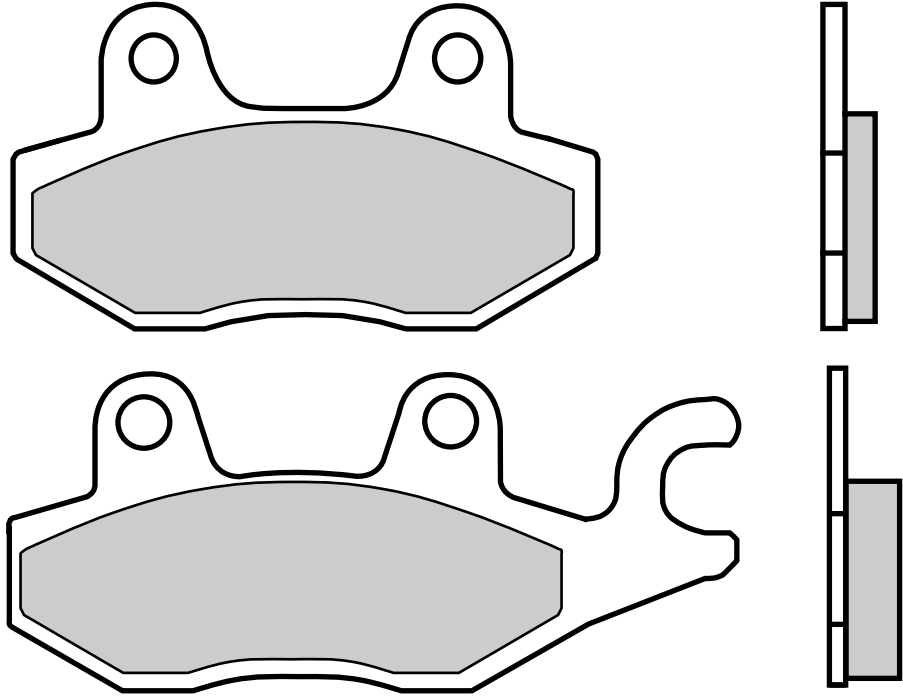

MZ

125 RT	06 >	• •
125 SM	99 > 01	•
125 SM	02 >	•
125 SX	99 > 01	•
125 SX	02 >	•

TRIUMPH

750 DAYTONA	91 > 92	•
750 TRIDENT right caliper	92 >	•

900 DAYTONA	91 > 94	•
900 DAYTONA SPEED TRIPLE	94 >	•
900 DAYTONA SPRINT	94 >	•
900 DAYTONA SUPER III	94 >	•
900 TIGER right caliper	92 > 98	•
900 TRIDENT right caliper	92 >	•
900 TRIDENT SPRINT right caliper	92 >	•
900 TROPHY	96 >	•
900 TROPHY right caliper	91 > 95	•

1000 DAYTONA	91 > 95	•
1200 DAYTONA	91 > 97	•
1200 TROPHY	96 > 03	•

VOXAN

1000 SCRAMBLER	01 >	•
----------------	------	---

YAMAHA

750 XTZ SUPERTENERE left caliper	89 >	•
----------------------------------	------	---



07YA21.06	76.9 x 41.9 x 8 96.6 x 41.9 x 8
------------------	------------------------------------

07YA21.SA	“ “ “
------------------	-------

07YA21.LA	“ “ “
------------------	-------

07YA21.SD	“ “ “
------------------	-------

07YA21.SX	“ “ “
------------------	-------

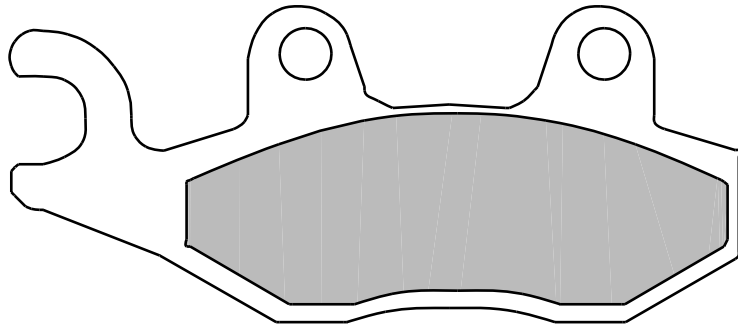
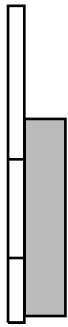
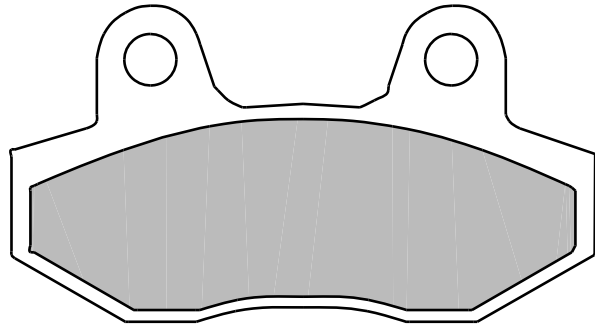
**BENELLI**

125 CAFFE' NERO left/rear	08 >	• •
250 CAFFE' NERO	08 > 13	• •

BOMBARDIER-CAN AM

800 COMMANDER LEFT/ REAR	11 >	•
800 COMMANDER RIGHT	11 >	•
1000 COMMANDER LEFT/ REAR	11 >	•
1000 COMMANDER MAX RIGHT	14 >	•
1000 COMMANDER RIGHT	11 >	•
1000 MAVERICK RIGHT	13 >	•

CAGIVA

600 CANYON	95 >	•
------------	------	---

KAWASAKI

150 KLX D-TRACKER	16 >	•
150 KLX L	14 >	•
300 KLF C1-C12 BAYOU LEFT CALIPER	89 >	•
400 KLF BAYOU	93 > 99	•
650 KLR	08 >	•
650 KVF	05 >	•
650 KVF BRUTE FORCE 4X4I RIGHT	05 >	•
750 KVF BRUTE FORCE 4X4I LEFT	05 >	•

800 MULE PRO FX LEFT	15 >	•
----------------------	------	---

PIAGGIO

125 VESPA TOURING	18 >	•
-------------------	------	---

SUZUKI

300 LT-F KING QUAD	02 >	•
450 LT-R	06 >	•
500 LT-A F QUADMASTER	00 >	•
500 LT-F F	98 >	•

TRIUMPH

750 TRIDENT right caliper	92 >	•
800 TIGER EXPLORER	12 >	•
900 BONNEVILLE NEWCHURCH	15 >	•
900 BONNEVILLE SPIRIT	15 >	•
900 BONNEVILLE STREET CUP	17 >	•
900 BONNEVILLE T100	17 >	•
900 BONNEVILLE T100 BLACK	17 >	•
900 BONNEVILLE T214	15 >	•
900 DAYTONA SPRINT right caliper	93 >	•
900 SPEED TRIPLE	97 > 01	•
900 STREET SCRAMBLER	17 >	•
900 THRUXTON ACE	15 >	•
900 TIGER right caliper	92 > 98	•
900 TRIDENT right caliper	92 >	•

900 TRIDENT SPRINT right caliper	92 >	•
900 TROPHY right caliper	91 > 95	•
955 SPRINT ST	99 > 04	•
1000 TROPHY right caliper	91 > 95	•
1050 SPEED 94	15 > 16	•
1050 SPEED 94R	15 > 16	•
1050 SPEED TRIPLE R	12 > 15	•
1050 SPRINT GT ABS	10 > 15	•
1050 SPRINT GT SE ABS	10 > 15	•
1050 TIGER SPORT	15 >	•
1200 BONNEVILLE BOBBER	17 >	•
1200 TIGER EXPLORER	12 > 16	•
1200 TIGER EXPLORER	16 > 17	•
1200 TIGER XCA	18 >	•
1200 TIGER XCX	18 >	•
1200 TIGER XRT	18 >	•
1200 TIGER XR	18 >	•
1200 TIGER XR LOW	18 >	•
1200 TROPHY	13 >	•
1200 TROPHY right caliper	91 > 95	•
1215 TROPHY	13 > 16	•
1215 TROPHY SE	13 > 16	•

YAMAHA

230 TT-R	05 >	•
700 YFM R RAPTOR left	06 >	•
700 YFM RY left/rear	09 >	•
750 XTZ SUPERTENERE left caliper	89 >	•





07YA22.06	76.9 x 41.9 x 8		
	96.6 x 41.9 x 8		
07YA22.SA	“ “ “		
07YA22.SP	“ “ “		
07YA22.SD	“ “ “		
07YA22.SX	“ “ “		
07YA22.SC	“ “ “		

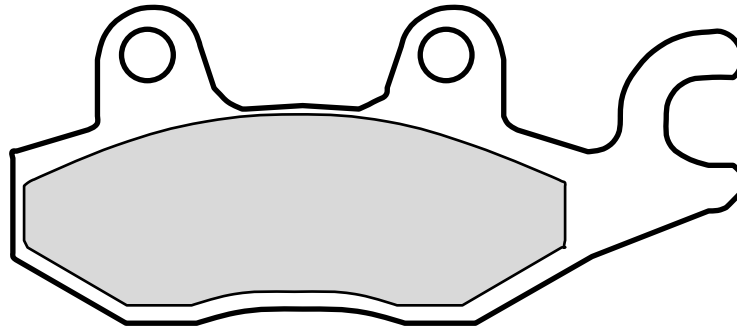
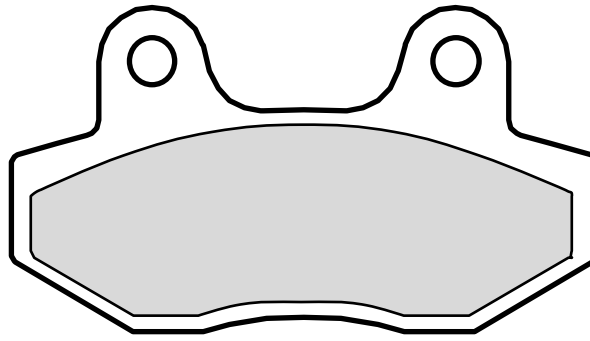

AEON

125 OVERLAND	02 >	•
180 OVERLAND	02 >	•
180 ROADSTER	02 >	•

ARCTIC CAT

50 DVX	06 >	•
90 DVX	06 >	•

BENELLI

125 CAFFE' NERO right	08 >	•
250 CAFFE' NERO	08 > 13	•

BOMBARDIER-CAN AM

800 COMMANDER LEFT/REAR	11 >	•
1000 COMMANDER LEFT/REAR	11 >	•
1000 COMMANDER MAX LEFT	14 >	•
1000 MAVERICK LEFT	13 >	•

CAGIVA

500 CANYON	99 >	•
600 CANYON	95 >	•
900 CANYON I.E.	97 > 98	•
900 ELEFANT I.E.	90 >	•
900 GRAN CANYON	99 >	•
1000 NAVIGATOR	00 >	•

HONDA

125 CB F	15 >	•
250 CA REBEL	90 >	•

KAWASAKI

125 BN ELIMINATOR A3	00 >	•
250 EX R NINJA	08 > 12	• •
250 NINJA SL	15 >	• •
250 R NINJA	08 >	• •
250 VERSYS-X	17 >	•
250 Z SL	15 >	• •
300 KLE VERSYS-X	17 > 18	•
300 KLF C1-C12 BAYOU RIGHT CALIPER	89 >	•
300 NINJA ABS	13 >	• •
300 Z	15 >	• •
400 KLF BAYOU	93 > 99	•
400 NINJA KRT EDITION	18 >	• •
400 Z NINJA	18 >	• •
650 KLR	08 >	•
650 KVF BRUTE FORCE 4X4I LEFT	05 >	•
650 KVF RIGHT CALIPER	05 >	•
750 KRF TERYX 4X4 RIGHT	08 >	•
750 KVF BRUTE FORCE 4X4I RIGHT	05 >	•
800 MULE PRO FX RIGHT	15 >	•
900 Z 900 RS CAFFE'	18 >	• •
1000 H2 SX	18 >	•
1000 H2 SX SE	18 >	•

KREIDLER

125 FLORETT D	07 >	•
125 FLORETT RMC-F	07 >	•

MOTOR UNION

250 HK HAOKE	97 >	•
--------------	------	---

SUZUKI

125 BURGMAN ABS	14 >	•
300 LT-F KING QUAD	02 >	•
450 LT-R	06 >	•
500 LT-A F QUADMASTER	00 >	•
500 LT-F F	98 >	•
800 DR BIG	91 > 95	•
800 DR S	91 > 95	•
800 DR ST BIG	96 >	•

TRIUMPH

750 TRIDENT left caliper	92 >	• •
900 BONNEVILLE	05 > 08	•
900 BONNEVILLE T100	05 > 08	•
900 DAYTONA SPRINT left caliper	93 >	• •
900 SPEED TRIPLE	94 > 96	•
900 TIGER left caliper	92 > 98	• •
900 TRIDENT left caliper	92 >	• •
900 TRIDENT SPRINT left caliper	92 >	• •
900 TROPHY left caliper	91 > 95	• •
955 TIGER	04 > 06	•
1000 TROPHY left caliper	91 > 95	• •



1050 TIGER	07 > 08	•
1050 TIGER SE	09 > 12	•
1200 TROPHY left caliper	91 > 95	• •
YAMAHA		
50 FZR	90 >	•

50 TZM	94 >	•
250 YBR	07 > 11	•
450 YXR RHINO	06 >	•
450 YZF S	04 > 05	•
660 RHINO right caliper	05 >	•
700 YFM R RAPTOR	06 >	•

700 YFM RY right	09 >	•
700 YXR RHINO left/rear	08 >	• •
750 XTZ SUPERTENERE right caliper	89 >	• •



07YA23.07	69.2 x 51.3 x 8.8
07YA23.SA	“ “ “
07YA23.LA	“ “ “
07YA23.SC	“ “ “
07YA23.RC	“ “ “

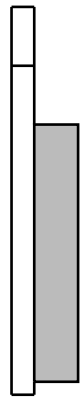
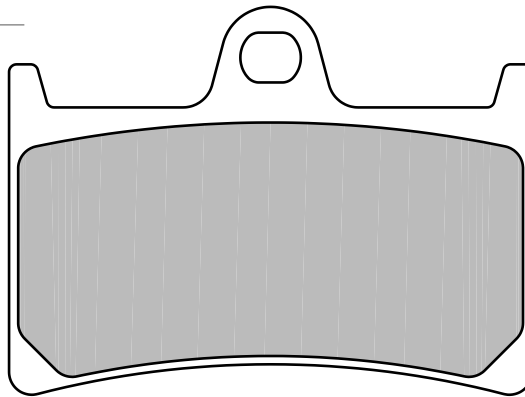

YAMAHA		
125 TZ	97 >	•
125 TZR	94 > 94	•
125 TZR R	94 > 94	•
250 FZR R	89 > 97	•
250 TZ	97 >	•
250 TZR	89 > 92	•
400 FZR R	91 > 94	•
600 FZ 6 FAZER	98 > 03	•
600 FZ6 FAZER S2	07 > 10	•
600 FZ6 FAZER S2 ABS	07 > 10	•
600 FZ6 S2	07 >	•
600 FZ6 S2 ABS	07 >	•
600 FZS FAZER	98 > 03	•
600 YZF R THUNDER CAT	96 > 99	•
600 YZF R6	99 > 02	•
600 YZF R6	03 > 16	•
600 YZF R6	17 >	•
700 MT 07	14 >	•
700 MT 07 MOTOCAGE ABS	15 >	•
700 MT 07 SP	18 >	•
700 MT 07 TRACER ABS	16 >	•
700 XSR 700	16 >	•
700 XSR 700 SPEED BLOCK	16 >	•
750 YZF R7	99 >	•

800 FZ 8	10 > 16	•
800 FZS FAZER	10 > 16	•
847 NIKEN	18 >	•
850 MT 09	14 >	•
850 MT 09 ABS	14 >	•
850 MT 09 SPORT TRACKER ABS	15 >	•
850 MT 09 STREET RALLY	14 >	•
850 MT 09 STREET RALLY ABS	14 >	•
850 MT 09 TRACER ABS	15 >	•
900 TDM	02 >	•
900 TDM ABS	05 >	•
900 TRACER	18 >	•
900 TRACER GT	18 >	•
900 XSR 900	16 >	•
900 XSR 900 SPEED BLOCK	16 >	•
900 XSR ABARTH	17 > 18	•
1000 FZ1	06 >	•
1000 FZ1 FAZER	06 > 15	•
1000 FZS FAZER	01 > 05	•
1000 MT 10	16 >	•
1000 MT 10 SP	16 >	•
1000 MT 10 TOURER ED.	16 >	•
1000 YZF R1	98 > 01	•

1000 YZF R1	02 > 03	•
1000 YZF R1	04 > 06	•
1000 YZF R1	15 >	•
1000 YZF R1 60th ANNIVERSARY	16 >	•
1000 YZF R1 SP	06 > 14	•
1000 YZF R1M SPECIAL EDITION	15 >	•
1000 YZF THUNDER ACE	96 > 00	•
1100 BT BULLDOG	02 >	•
1199 XT 1200 ZE SUPER TENERE RAID ED.	18 >	•
1200 XTZ SUPERTENERE	10 >	•
1300 FJR	01 > 05	•
1300 XJR	99 > 01	•
1300 XJR	02 >	•
1300 XJR RACER	15 >	•
1300 XJR SP	99 > 01	•
1700 MT 01	05 > 06	•
1700 XV PC ROAD STAR WARRIOR	03 >	•
1700 XV ROAD STAR WARRIOS	02 >	•
1900 XV MIDNIGHT STAR	06 >	•



07YA24.09	74.6 x 54.1 x 9
07YA24.SA	“ “ “
07YA24.SC	“ “ “

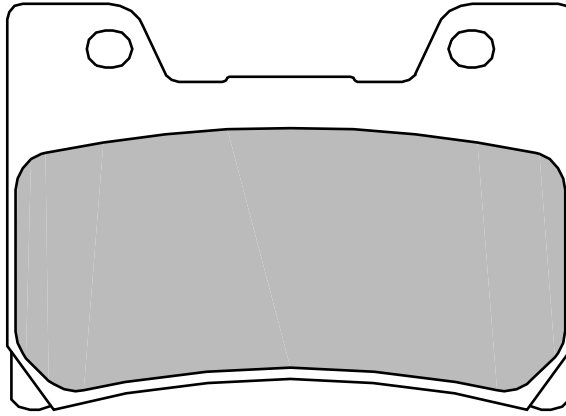

YAMAHA

400 SRX

90 > •

600 FZR
850 TDM

90 > 91 •
96 > 01 •

1000 FZR EX-UP
1200 V MAX

90 > 91 •
93 > 01 •



07YA25.08	88.2 x 46.1 x 9.9 104.1 x 46.1 x 9.9
07YA25.SA	“ “ “

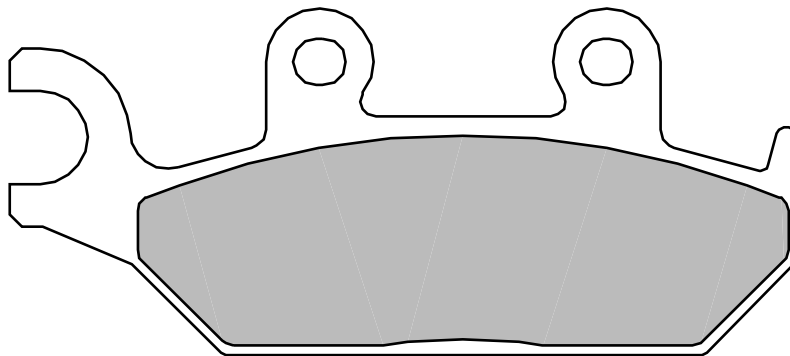
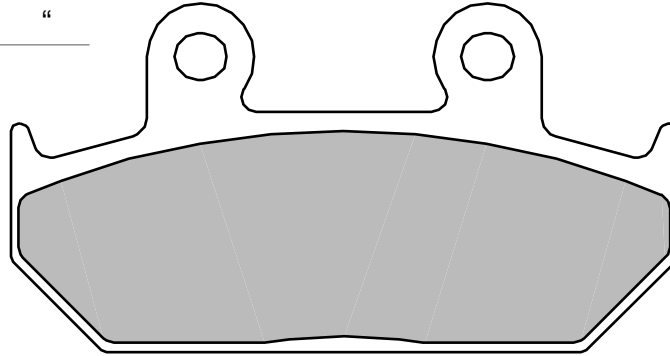

YAMAHA

50 TZR

93 > 02 •

350 XT
400 ARTESIA
500 XT E

91 > •
91 > •
90 > 96 •

600 XT E
600 XT K
660 XTZ TENERE'

90 > 98 •
90 > 98 •
91 > 98 •



07YA26.09	74.6 x 54.1 x 9
07YA26.SA	“ “ “
07YA26.SC	“ “ “

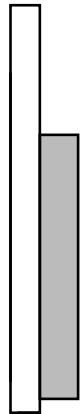
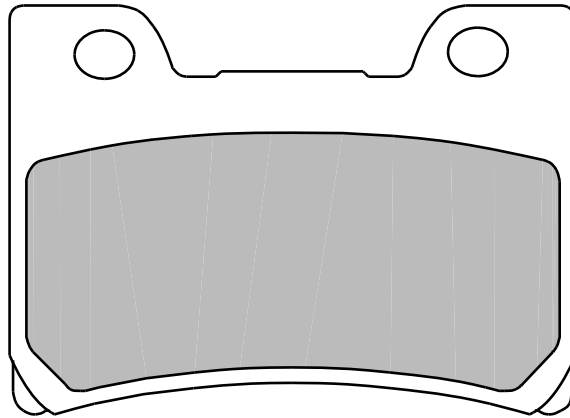

YAMAHA

600 FZR	92 > 96 •
600 FZR R	94 > 95 •
1000 FZR EX-UP	92 > 93 •





07YA27.09

102 x 40.4 x 10

07YA27.SA

“ “ “

2

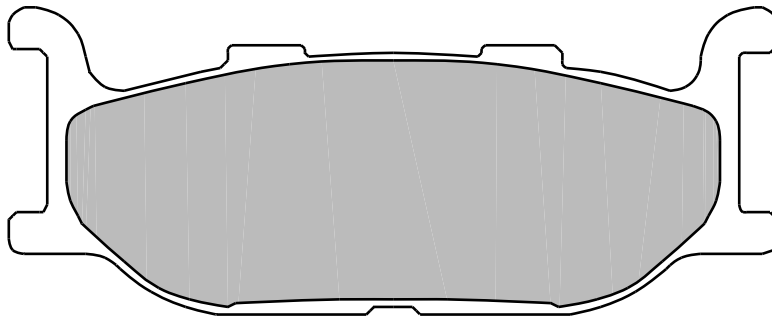

SUZUKI

250 SRV 92 > •

YAMAHA

250 FZX 91 > 97 •

250 FZX ZEAL 91 > 97 •

400 SR 14 > 16 •

400 XJ DIVERSION 91 > •

535 XV VIRAGO 96 > 98 •

600 XJ DIVERSION 91 > 97 •

650 XVS DRAG STAR CLASSIC 99 > 02 •

750 XV 94 > 95 •

900 SCR 900 17 > •

900 XJ DIVERSION 94 > •

900 XJ S 94 > •

950 XV 950 SPEED BLOCK RACER 16 > •

950 XV BOLT C-SPEC 15 > •

950 XV BOLT RACER 17 > 18 •

950 XV950 16 > •

950 XVS 09 > 13 •

950 XVS BOLT 14 > 16 •

1100 XV VIRAGO 94 > 95 •

1300 STRYKER 11 > •

1300 XVZ TF ROYAL STAR VENTURE 99 > 00 •

1300 XVZ TF VENTURE STAR 99 > •

1600 WILD STAR 99 > •



07YA28.CC

109.8 x 51 x 8.4
95.2 x 36.9 x 8.4

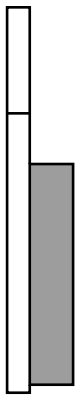
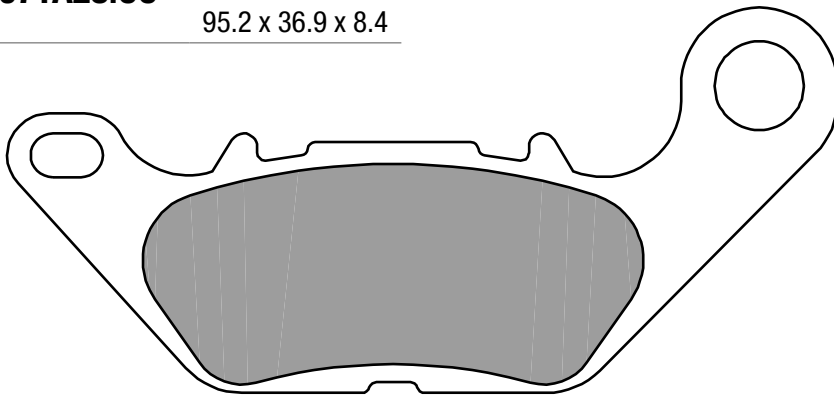

2

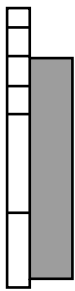
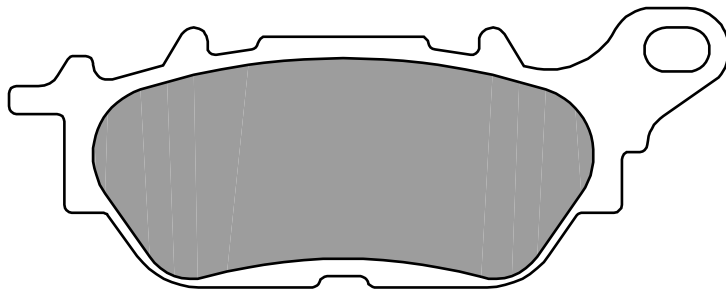

MBK

125 XC WAAP 08 > •

YAMAHA

115 D'ELIGHT 14 > •
125 YBR 08 > •

125 YS 17 > •
135 CRYPTON X 08 > •
150 YZF R15 14 > •



07YA29.CC

47.8 x 44.5 x 7.1

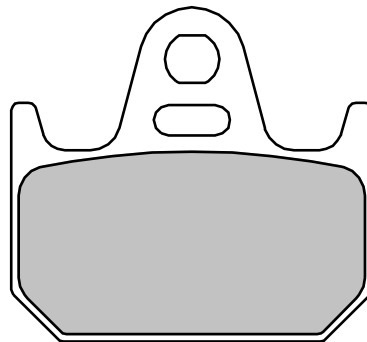

YAMAHA

125 TZ 97 > •
250 TZ 97 > •
250 TZR R 94 > •





07YA31.08 131.7 x 81.4 x 9.6

2

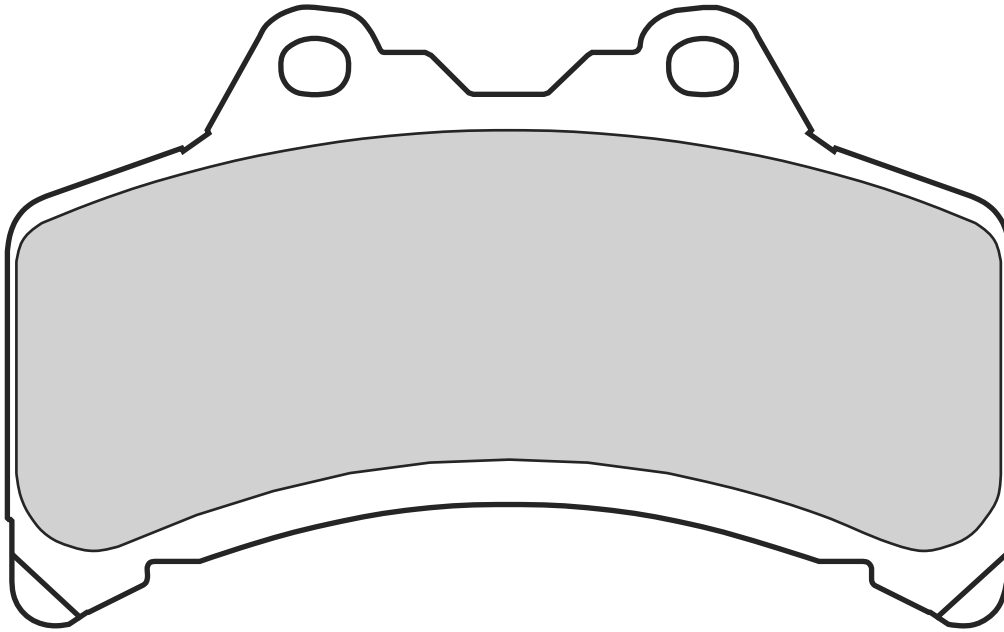

YAMAHA

1000 GTS 93 > •



07YA32.08 98.8 x 49.7 x 9.5

07YA32.SA “ “ “

07YA32.SC “ “ “

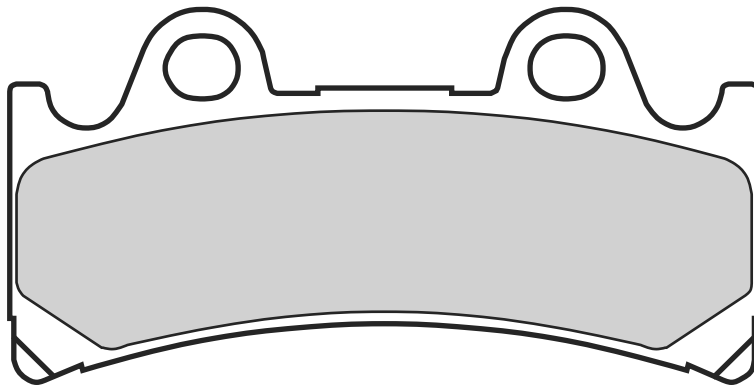

TRIUMPH

900 DAYTONA SUPER III 94 > •

YAMAHA

750 YZF R 93 > 97 •

750 YZF SP

93 > 97 •

1000 FZR EX-UP

94 > 95 •



07YA34.08 94 x 40.7 x 10

07YA34.SA “ “ “

07YA34.LA “ “ “

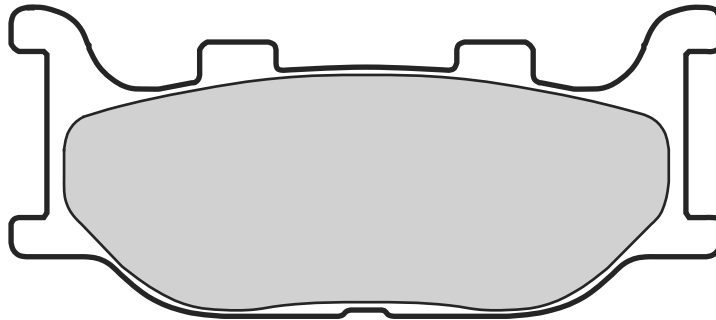

BAOXIN

125 BX L 97 > •

KEEWAY

250 SUPERSHADOW 06 > •

MZ

1000 MUZ S 01 > 02 •

YAMAHA

125 TDR R 93 > •

125 TZR 93 > 93 •

125 XV S DRAG STAR 00 > •

125 XV VIRAGO 97 > •

250 XV S VIRAGO 95 > 98 •

250 XV VIRAGO 95 > 98 •

250 XVS DRAG STAR 01 > •

600 FZ 6 04 > •

600 FZ 6R 09 > •

600 XJ 6 09 > •

600 XJ 6 N 09 > 12 •

600 XJ 6 N 13 > •

600 XJ 6 N SP 13 > 13 •

600 XJ 6 NA ABS 13 > 13 •

600 XJ 6 S DIVERSION 09 > 12 •

600 XJ 6 S DIVERSION 13 > •

600 XJ DIVERSION 98 > 03 •

600 XJ S F DIVERSION 10 > 11 •

600 XJ S FA DIVERSION ABS 11 > 11 •

600 XJ6 F 09 > 12 •

600 XJ6 F 13 > •

660 MT 03 06 > 15 •

1100 XV VIRAGO 99 > 01 •

1100 XVS DRAG STAR 99 > 06 •

1100 XVS DRAG STAR 00 > 06 •

1100 CLASSIC

1300 XVS CUSTOM 14 > 16 •

1300 XVS MIDNIGHT STAR 07 > 08 •





07YA35.07 74.3 x 53.9 x 8.8

07YA35.SA “ “ “

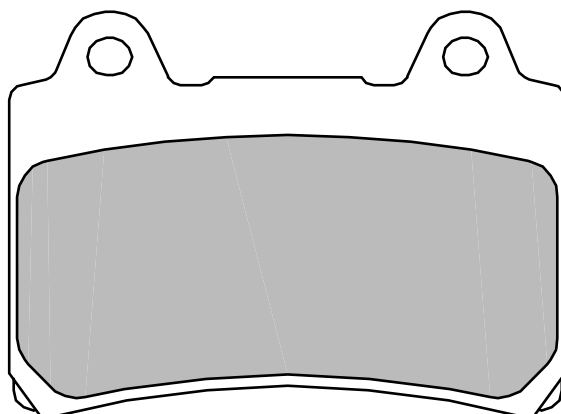

YAMAHA

400 FZR	90 > 94	•
400 SRX	85 > 86	•
600 SRX	90 >	•

750 FZR GENESIS	87 >	•
1200 XJR	94 > 98	•
1200 XJR SP	97 > 98	•
1300 XVZ A ROYAL STAR	96 > 98	•

1300 XVZ ROYAL STAR BOULEVARD	99 >	•
1300 XVZ ROYAL STAR TOUR C.	97 >	•



07YA37.07 99.6 x 31 x 9

07YA37.SP “ “ “

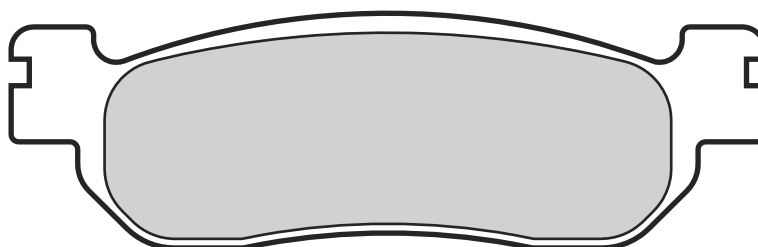

YAMAHA

125 TW	99 >	•
175 DT	00 >	•
200 TW	01 >	•
225 BRONCO, CELLOW	97 >	•
225 XT	01 >	•
250 TRICKER	05 >	•
600 YZF R6	99 > 02	•
1000 YZF R1	02 > 03	•



07YA38.07

51.6 x 59.7 x 8.7

07YA38.SP

“ “ “

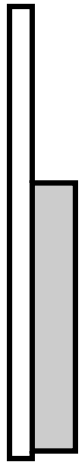
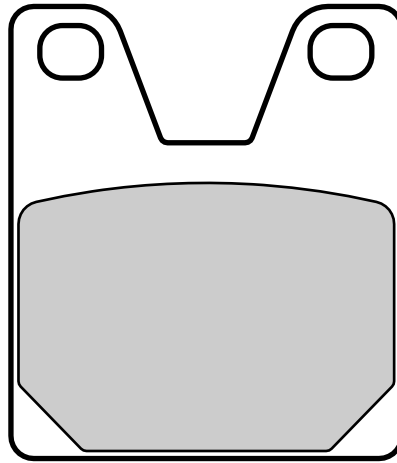

2



HYOSUNG

700 I DELUXE

13 >



YAMAHA

750 YZF R7

99 >



1000 YZF R1

98 > 01



07YA39.08

99.6 x 38.2 x 9.5

07YA39.SP

“ “ “

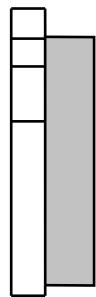
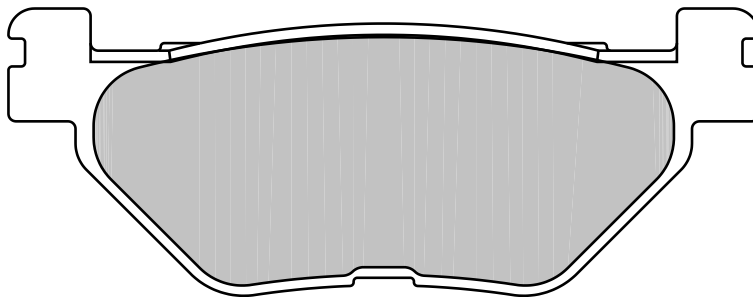

YAMAHA

900 SCR 900

17 >



900 TDM

02 >



900 TDM ABS

05 >



950 XV 950 SPEED BLOCK
RACER

16 >



950 XV BOLT C-SPEC

15 >



950 XV BOLT RACER

17 > 18



950 XV950

16 >



950 XVS

09 > 13



950 XVS BOLT

14 > 16



1200 XTZ SUPERTENERE

10 >



1300 FJR

01 > 05



1300 FJR A

13 >



1300 FJR ABS

06 > 12



1300 FJR AS

13 >



1300 STRYKER

11 >



1300 XVS CUSTOM

14 > 16



1300 XVS MIDNIGHT STAR

07 > 08



1700 V-MAX

09 >



1700 XV PC ROAD STAR
WARRIOR

03 >



1900 XV MIDNIGHT STAR

06 >



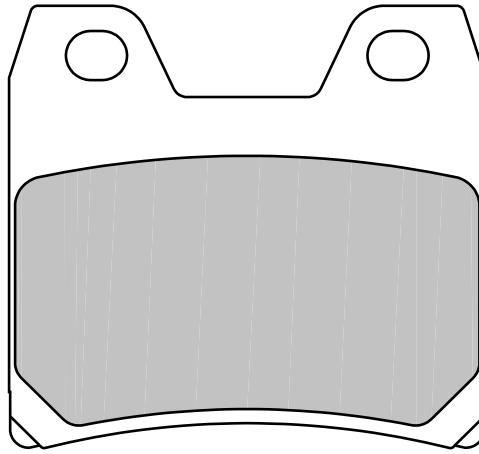

07YA40.07	63.2 x 58.9 x 8.7
07YA40.SP	“ “ “

**YAMAHA**

1000 FZS FAZER	01 > 05	•
1300 XJR	02 >	•
1300 XJR RACER	15 >	•

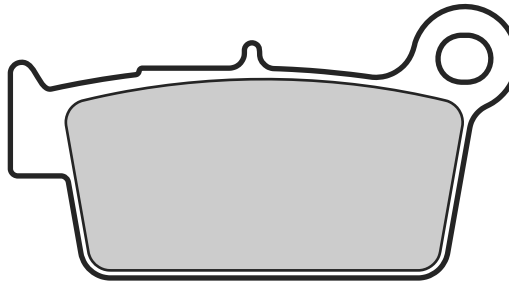
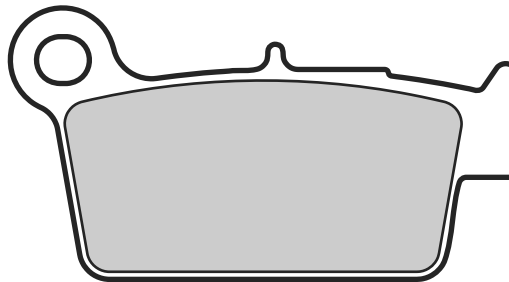

07YA41.SD	67 x 35.9 x 9.3
07YA41.SX	“ “ “
07YA41.TT	“ “ “

**APRILIA**

450 MX V	09 >	•
450 RXV	06 > 14	•
450 SXV	06 > 08	•
450 SXV VAN DEN BOSCH REPLICA	08 > 08	•

550 RXV	06 > 14	•
550 SXV	06 > 14	•
550 SXV VAN DEN BOSCH REPLICA	08 > 08	•

BETA

125 ALP 4-STROKE	06 >	•
125 M4	06 >	•
125 RR 2T	18 >	•
200 ALP 4-STROKE	06 >	•
250 RR	05 >	•



250 RR ENDURO	05 >	•
300 RR CROSSRAINER	15 >	•
300 RR EFI	15 >	•
300 RR EFI RACING	15 >	•
300 RR ENDURO	13 >	•
350 ALP 4.0	06 >	•
350 RR ENDURO	12 >	•
390 RR	15 >	•
400 RR	05 >	•
400 RR ENDURO	05 >	•
430 RR	15 >	•
430 RR RACING	15 >	•
450 RR	05 >	•
450 RR CROSS COUNTRY	12 >	•
450 RR ENDURO	05 >	•
480 RR	15 >	•
480 RR RACING	15 >	•
498 RR ENDURO	12 >	•
525 RR	05 > 09	•
525 RR ENDURO	05 >	•

BIMOTA

300 BBX ENDURO	12 >	•
----------------	------	---

CCM

450 ENDURO	08 >	•
450 MX	08 >	•

GAS GAS

200 EC	17 >	•
200 XC 200	18 >	•
250 EC	12 >	•
250 EC	18 >	•
250 ENDURO GP 18	18 >	•
250 XC	17 >	•
300 EC	12 >	•

300 EC	18 >	•
300 ENDURO GP 18	18 >	•
300 XC	18 >	•

KAWASAKI

250 KX F	04 >	•
450 KLX R	07 >	•
450 KX F	06 >	•

SHERCO

250 2.5 I ENDURO	06 > 11	•
250 SX 2.5	09 > 10	•
300 SE 3.0	10 >	•
300 SE 3.0I-F	10 > 11	•
450 4.5 I SUPERMOTARD	06 >	•
450 ENDURO	05 > 11	•
510 5.1 I ENDURO	06 > 11	•

SUZUKI

125 DR SM	08 >	•
250 RM Z	04 >	•
450 RM-Z	05 >	•
450 RM-Z EFI	08 >	•
450 RMX Z	10 >	•
450 RMX Z efi	17 >	•

TM

125 ENDURO	05 >	•
125 MX	06 >	•
250 ENDURO	05 >	•
250 F	05 >	•
250 F ENDURO	05 >	•
250 MX	06 >	•
300 MX	05 >	•
450 F	05 >	•
450 F ENDURO	05 >	•

450 FT FI	17 >	•
530 F	05 >	•
530 F ENDURO	05 >	•

YAMAHA

125 YZ	03 > 07	•
125 YZ	08 >	•
250 WR F	03 > 17	•
250 WR F	18 >	•
250 WR F EFI	18 >	•
250 WR R	08 >	•
250 WR X	08 >	•
250 YZ	03 > 07	•
250 YZ	08 >	•
250 YZ F	03 > 06	•
250 YZ F	07 > 15	•
250 YZ F	16 >	•
250 YZ FX	15 >	•
450 WR F	03 >	•
450 YZ F	03 > 07	•
450 YZ F	08 > 15	•
450 YZ F	16 >	•
450 YZ F EFI	18 >	•
900 MT 09 SP	18 >	•

ZERO

2.8 ZF FX	13 > 13	•
2.8 ZF MX	13 > 13	•
2.8 ZF XU	13 > 13	•
5.7 ZF FX	13 > 13	•
5.7 ZF MX	13 > 13	•
5.7 ZF XU	13 > 13	•
8.5 ZF DS	13 > 13	•
8.5 ZF S	13 > 13	•
11.4 ZF DS	13 > 13	•
11.4 ZF S	13 > 13	•





07YA44.SD 39.3 x 39.3 x 23.1
37 x 37 x 7.8

2

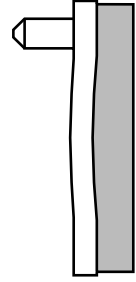
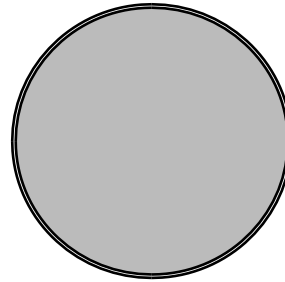
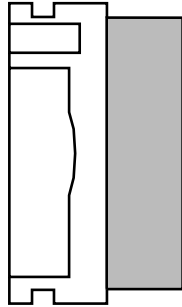
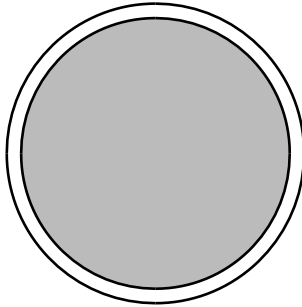

YAMAHA

200 YFS U-P BLASTER 88 > 02 •



07YA45.SD 65.1 x 44.4 x 11.6

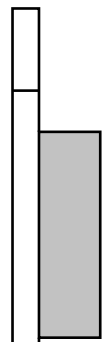
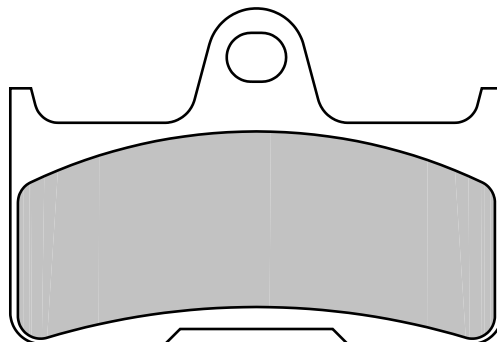

YAMAHA

660 YFM GRIZZLY FWAP 4X4 02 > •



07YA46.SA

61.6 x 44.6 x 8.5
30.6 x 48 x 8.5

07YA46.SC

“ “ “

07YA46.RC

“ “ “

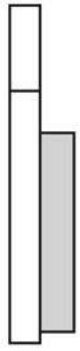
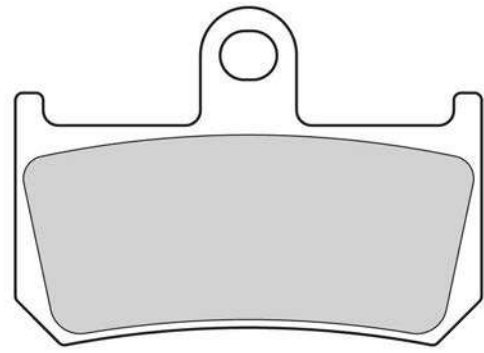

2

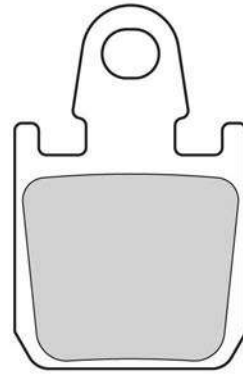

YAMAHA

1000 YZF R1	07 > 08	•
1700 MT 01	07 > 11	•
1700 V-MAX	09 >	•





07YA47.SD 93.8 x 31.1 x 7.2

07YA47.SX “ “ “

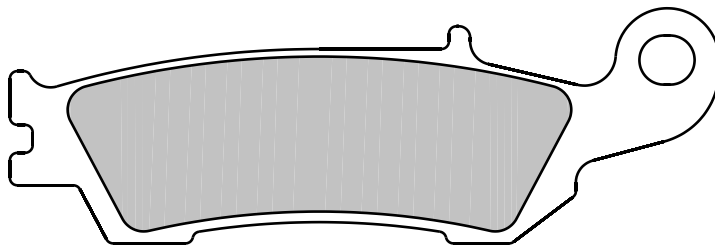
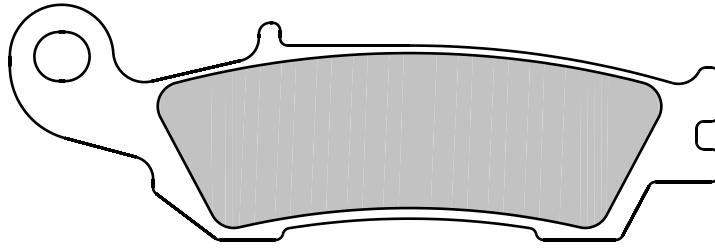

2



YAMAHA

125	YZ	08 >	•
250	WR F	18 >	•
250	WR F EFI	18 >	•
250	YZ	08 >	•
250	YZ F	07 > 15	•
250	YZ F	18 >	•
250	YZ FX	15 >	•
450	YZ F	08 > 15	•
450	YZ F	16 >	•
450	YZ F EFI	18 >	•
900	MT 09 SP	18 >	•



07YA48.SD 106.6 x 35.8 x 7.5
91.1 x 36.2 x 7.5

07YA48.SX “ “ “

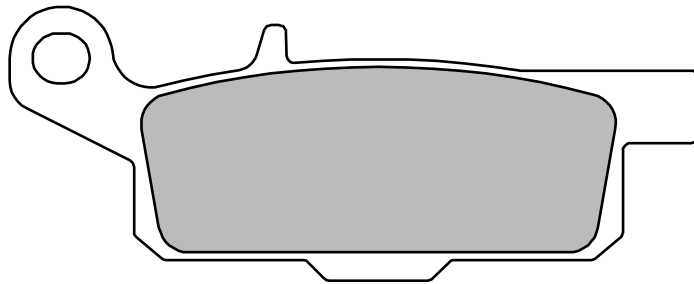
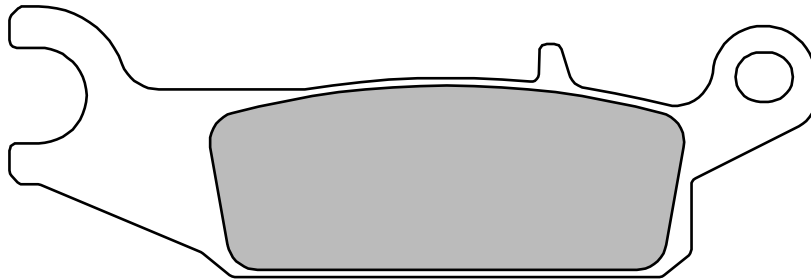

YAMAHA

250	YFM RAPTOR right	09 >	•
550	YFM FGPW GRIZZLY right	09 >	•
700	YFM FGPW GRIZZLY right	07 >	•





07YA49.SD

106.6 x 35.8 x 7.5

91.1 x 36.2 x 7.5

07YA49.SX

“ “ “

2

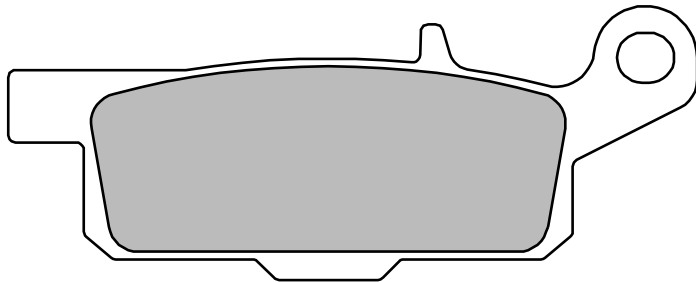
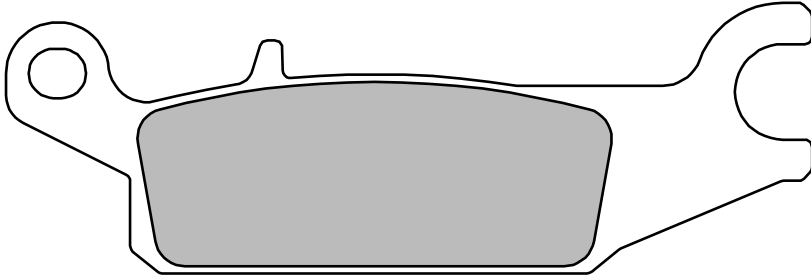

YAMAHA

250	YFM RAPTOR left/rear	09 >	•
550	YFM FGPW GRIZZLY left	09 >	•
700	YFM FGPW GRIZZLY left	07 >	•



07YA50.SD 106.6 x 35.8 x 8.9
91.1 x 36.2 x 8.9

07YA50.SX “ “ “

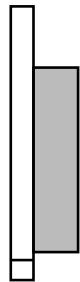
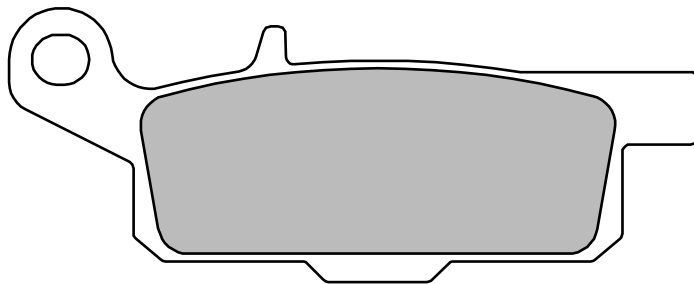
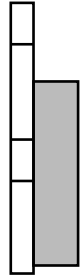
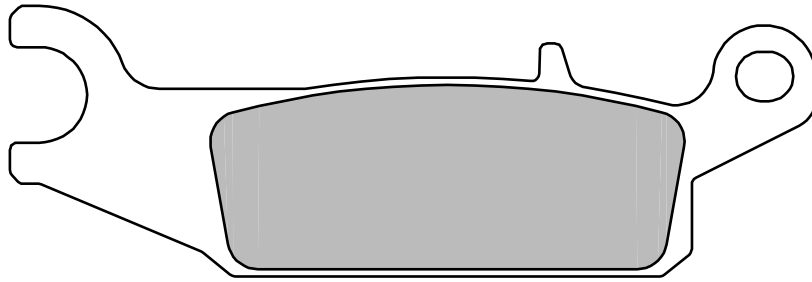

YAMAHA

550	YFM FGPW GRIZZLY right	09 >	•
700	YFM FGPW GRIZZLY right	07 >	•





07YA51.SD 106.6 x 35.8 x 8.9
91.1 x 36.2 x 8.9

07YA51.SX “ “ “

2

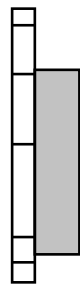
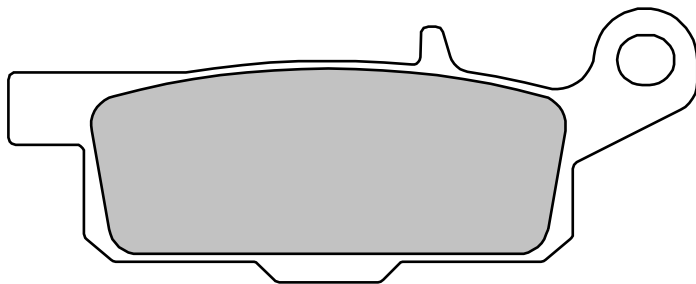
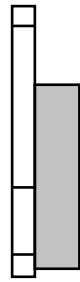
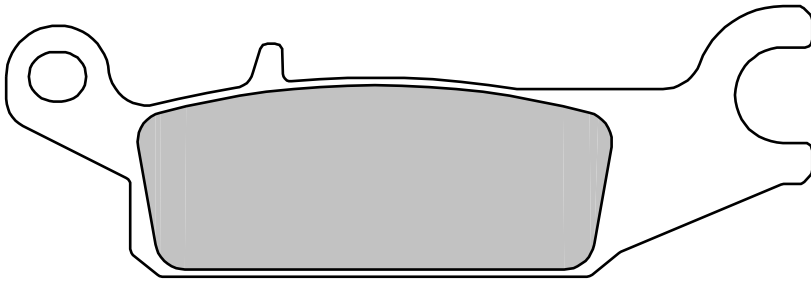

YAMAHA

- 550 YFM FGPW GRIZZLY left 09 > •
- 700 YFM FGPW GRIZZLY left 07 > •



07YA52.CC	113.1 x 54.7 x 8.3
	98.4 x 44.5 x 8.3

07YA52.SA	“ “ “
------------------	-------

07YA52.SC	“ “ “
------------------	-------

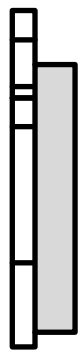
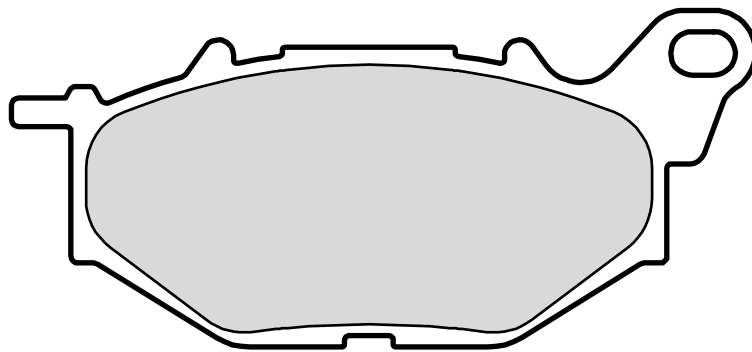
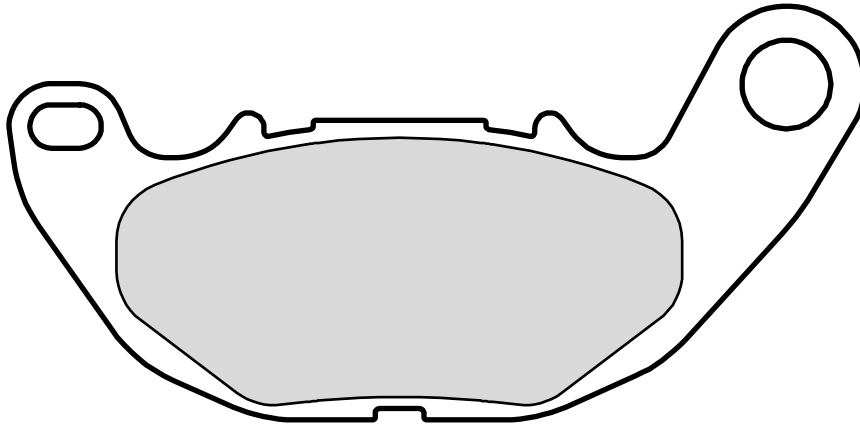

YAMAHA

250	YZF R25	15 >	•
300	X-MAX	17 >	•
321	MT 03	16 >	•
321	YZF R3	15 >	•





07YA53.CC

113.1 x 52.7 x 10.5

97.1 x 39.4 x 10.5

2

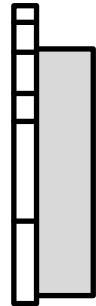
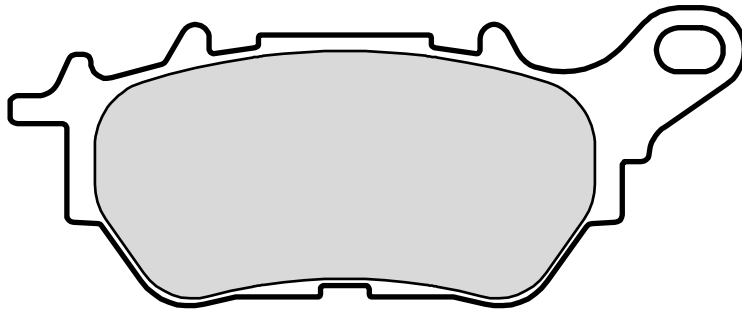
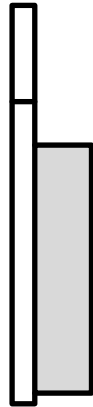
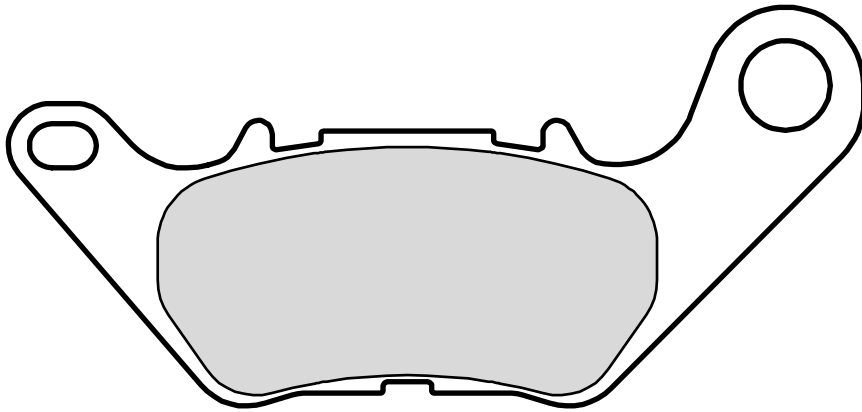

YAMAHA

250	YZF R25	15 >	•
300	X-MAX	17 >	•
321	MT 03	16 >	•
321	YZF R3	15 >	•