

FAMI IDEAONE 20.21

banco da lavoro
a partire da

€ 149,00

page 21

INNOVATION
SINCE 1929.

PROSSIMAMENTE
online il nuovo e-commerce



WWW.FAMISHOP.COM



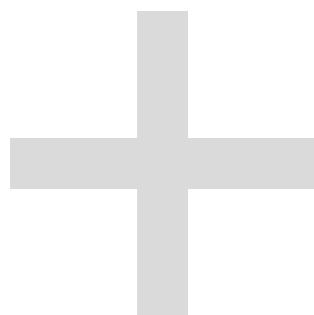

together is better!

Unipok ed Iron Team il nuovo sistema di fissaggio ideato da Fami!

Preparati a **rivoluzionare** il modo in cui organizzzi utensili, attrezzatura e materiali per il lavoro con i nostri **nuovi ganci universali e accessori!**

Non limitarti alla semplice parete forata! Unipok ed Iron Team possono essere fissati su **diverse superfici** per permetterti di avere una postazione di lavoro **sempre in ordine** in qualsiasi area dell'azienda, del negozio o della tua officina!



UNIPOK

MIX AND MATCH

PRODOTTI IN VENDITA DA
 DICEMBRE 2020

x30



x30



x30



x15



IDEAONE05219

€ 21,00

Confezione 30 ganci Unipok

PATENT PENDING



CON UNA CONFEZIONE SI POSSONO
 AGGANCIARE FINO A 30 UTENSILI



FISSAGGIO SU LEGNO



FISSAGGIO SU
 PANNELLO FORATO



tutte le combinazioni che vuoi

Unipok sono i nuovi ganci universali di Fami che, grazie al sistema a vite, possono essere posizionati su pareti forate o pannelli in legno.

Ogni Unipok può essere posizionato con diverse inclinazioni per poter fissare utensili di volumi e dimensioni differenti. Libera la tua fantasia per organizzare al meglio la tua parete forata da muro o da banco e la tua parete in legno per avere sempre tutto a portata di mano!

CON UNIPOK L'ORDINE È UN GIOCO DA RAGAZZI!

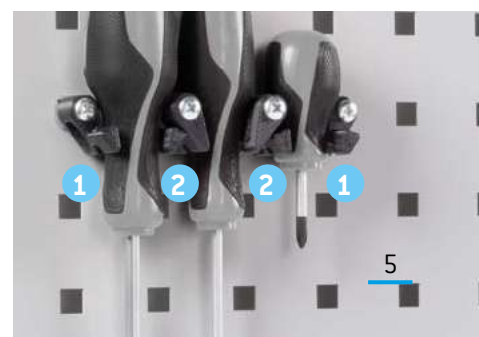
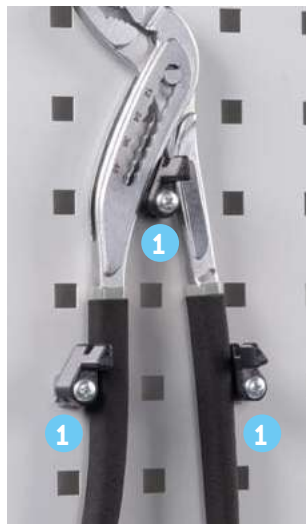
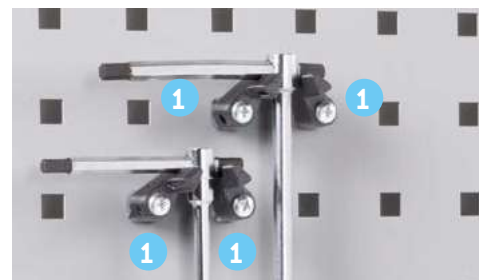
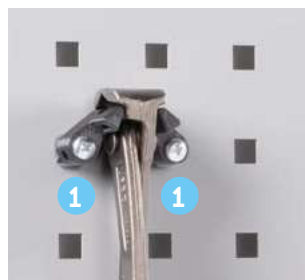
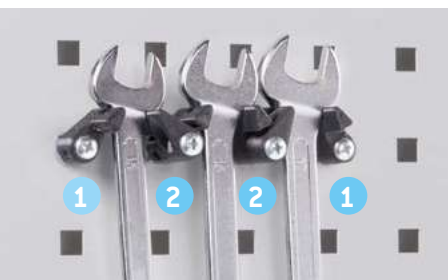
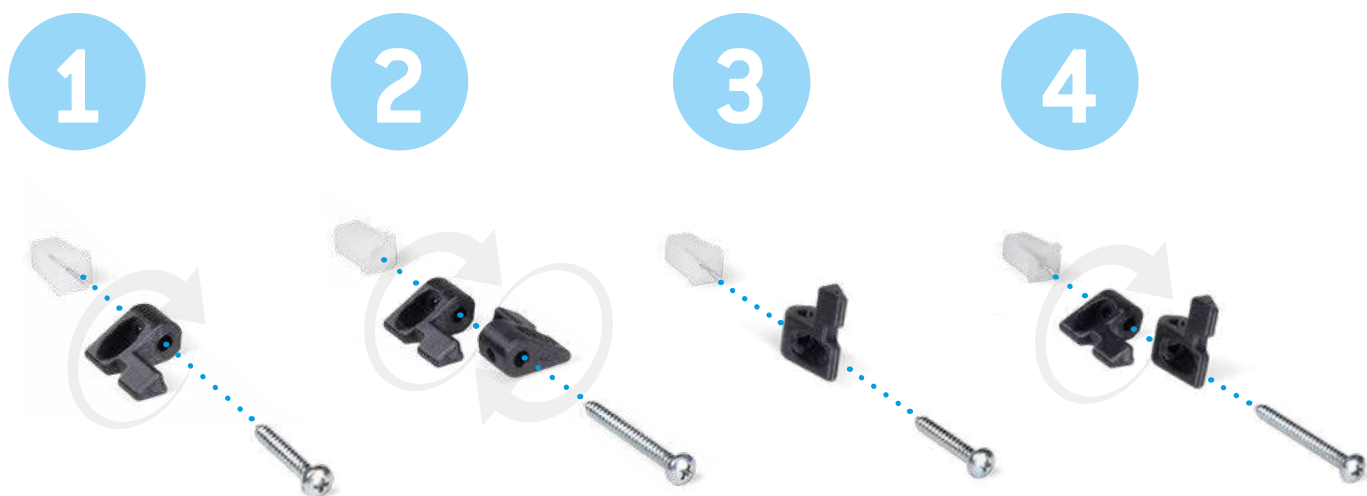

IRON TEAM



FISSAGGIO SU LEGNO INCLUSO

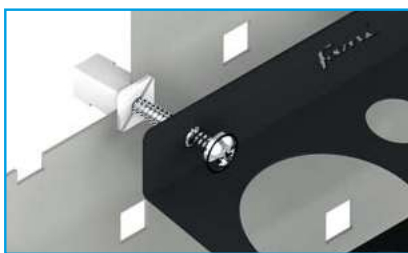

FISSAGGIO SU PANNELLO FORATO INCLUSO



FISSAGGIO SU MURO NON INCLUSO



**SET DI FISSAGGIO INCLUSO
IN TUTTI GLI IRON TEAM**



Iron Team è l'ampia gamma di accessori per soddisfare le molteplici necessità di organizzazione. Il fissaggio tramite tassello e vite li rende universali, consentendoti di fissarli su più superfici: pareti forate, pannelli in legno o muri. **DISPONIBILI IN COLORE RAL 7016.**

ORGANIZZA, ORDINA E CUSTODISCI AL MEGLIO TUTTO IL NECESSARIO PER IL TUO LAVORO CON IRON TEAM!

CALAMITE

PRODOTTI IN VENDITA DA
DICEMBRE 2020



IDEAONE05108

Calamite Ø 20 mm.
Confezione da 10 pz.
Colore zincato.

€ 41,00



PORTA SILICONE

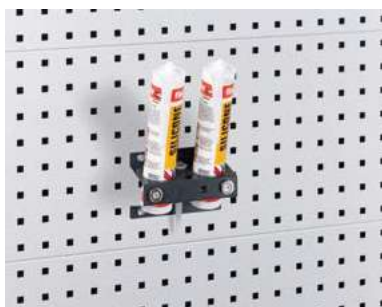

IDEAONE05216

Porta silicone inclinato a 2 posti
dim. mm 150x71x96 H

€ 13,50



PORTA BOMBOLETTE



IDEAONE05215

Porta bombolette inclinato a 2 posti
dim. mm 188x111x172 H

€ 13,50



IDEAONE05220

Porta bombolette a 6 posti
dim. mm 455x75x167 H

€ 23,00



DISPENSER PER GUANTI



IDEAONE05164

Dispenser per guanti
dim. mm 247x82x132 H

€ 12,50



PORTA FLACONE

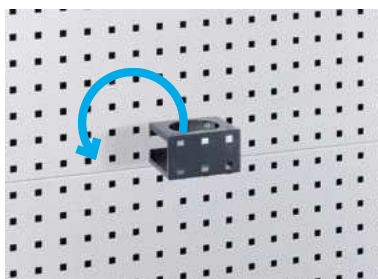

IDEAONE05161

Porta flacone igienizzante reversibile
dim. mm 114x100x62 H

€ 10,00



Ø 80

Ø 60

PORTA ROTOLI



IDEAONE05163

Porta rotolo con carta Ø 240/300 mm
dim. mm 285x180x200 H

€ 41,00



IDEAONE05162

Porta rotolo con carta Ø 130 mm
dim. mm 245x90x150 H

€ 28,00



PORTA SALVIETTE



IDEAONE05207

Porta contenitore con salviette lavamani
dim. mm L cinghia = 910

€ 80,00





IDEAONE05158

€ 16,00

Tasca porta documenti A4
dim. mm 365x68x187 H

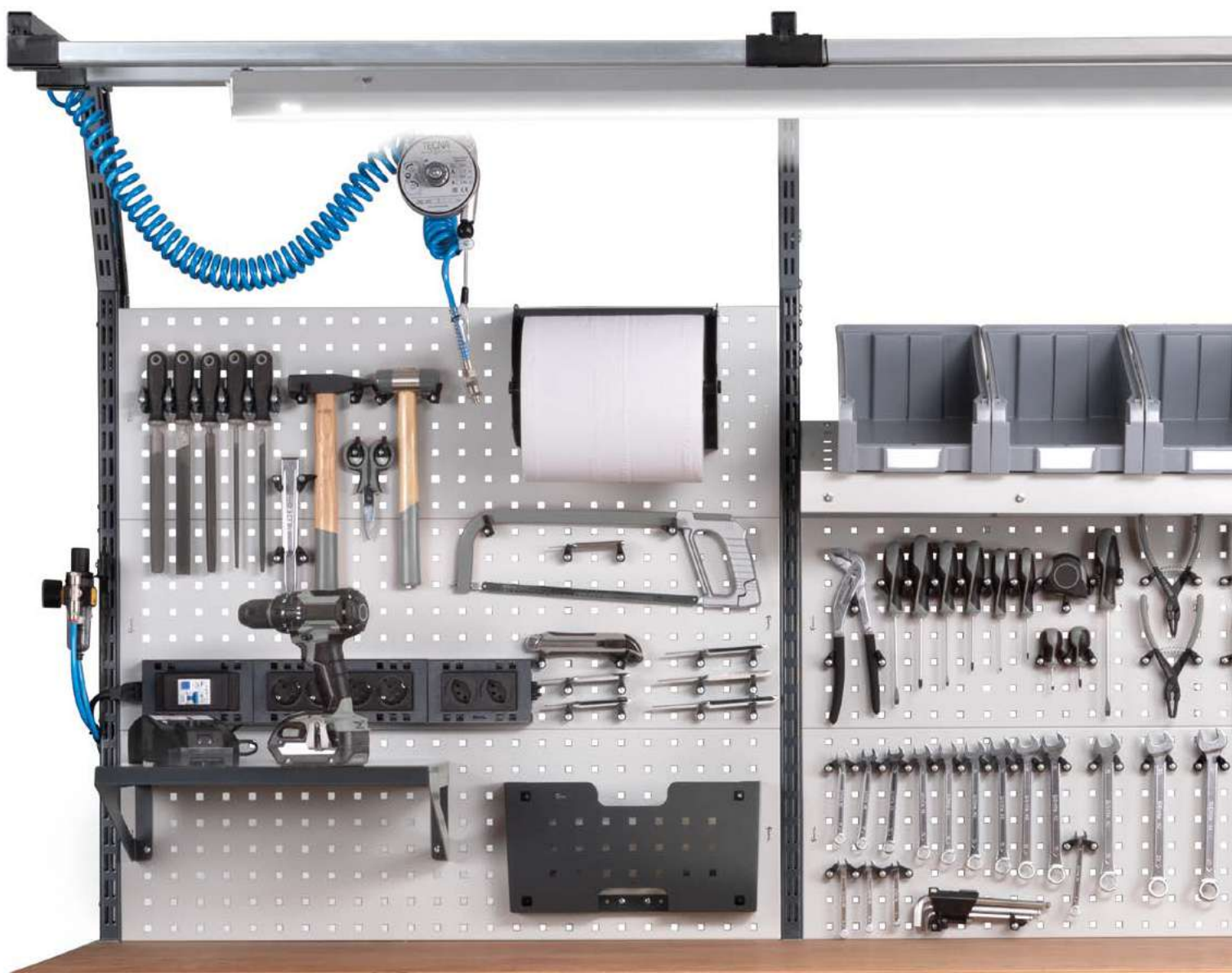

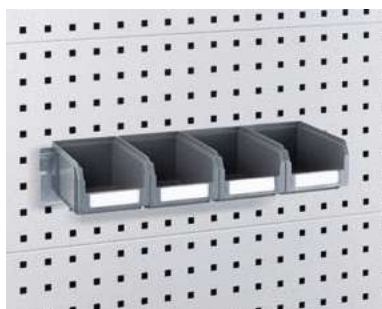

IDEAONE05221 € 9,50

Barra aggancio Picking Box
+ 4 Picking Box **grigi** mis.1
dim. mm 380x160x75 H

IDEAONE05222 € 14,00

Barra aggancio Picking Box
+ 4 Picking Box **conduttivi** mis.1
dim. mm 380x160x75 H



IDEAONE05223 € 11,50

Barra aggancio Picking Box
+ 3 Picking Box **grigi** mis.2
dim. mm 420x230x130 H

IDEAONE05224 € 18,00

Barra aggancio Picking Box
+ 3 Picking Box **conduttivi** mis.2
dim. mm 420x230x130 H

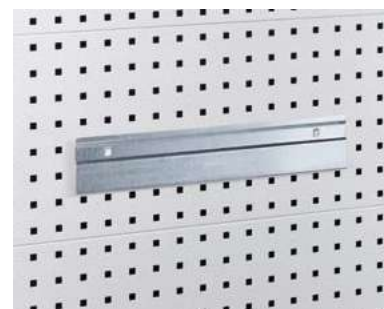

IDEAONE05210 € 3,50

Barra aggancio Picking Box
dim. mm 445x9x86 H



KIT STAFFE



IDEAONE05206 € 25,50

Kit staffe
porta contenitore
dim. mm L cinghia = 910



KIT PRONTO SOCCORSO



IDEAONE05214 € 26,50

Kit pronto soccorso
dim. mm 86x256x210 H



REGGICAVO



IDEAONE05208 € 22,50

Sella reggicavi
dim. mm 95x220x101 H



ESTINTORE



IDEAONE05213 € 47,00

Porta estintore +
estintore da 2 kg





IL CESTINO E IL PORTA VALIGETTA SONO PARTICOLARMENTE INDICATI PER ESSERE POSIZIONATI SUL PANNELLO LATERALE DEL BANCO



CESTINO



IDEAONE05217

Cestino capacità 30 lt
dim. mm 388x278x394 H

€ 80,00



PORTA VALIGETTA E VALIGETTA

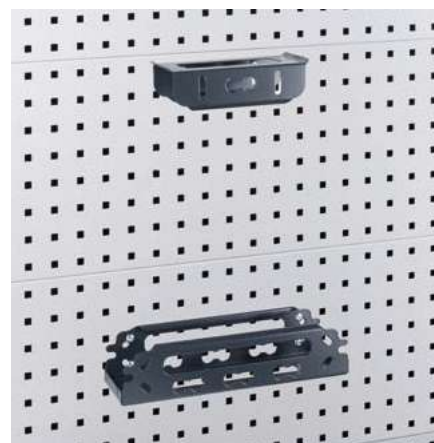

IDEAONE05211

Porta valigetta

€ 36,00



IDEAONE05212

Valigetta in plastica con contenitori
dim. mm 440x350x80 H

€ 45,00



MENSOLE



IDEAONE05205  € 18,00
 Mensola piccola reversibile
 dim. mm 303x317x144 H



IDEAONE05204  € 21,00
 Mensola grande reversibile
 dim. mm 455x317x144 H



IDEAONE05160  € 21,00
 Mensola porta
 oggetti reversibile
 dim. mm 456x160x40 H



PORTA PUNTE



IDEAONE05218  € 23,00
 Porta punte in acciaio inox
 dim. mm 155x84x39 H



**IL PORTA PUNTE PUÒ ESSERE UTILIZZATO ALL'INTERNO DELLA MENSOLA
 PORTA OGGETTI REVERSIBILE**

PICKING BOX



IDEAONE05225  € 9,00
 Kit 2 Picking Box mis. 3A2
 dim. mm 200x350x145 H

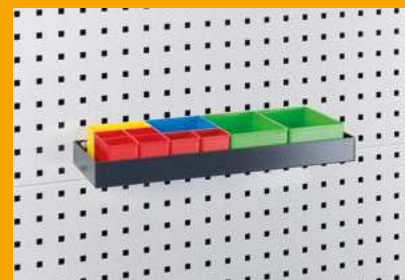

IDEAONE05226  € 9,00
 Kit 10 contenitori

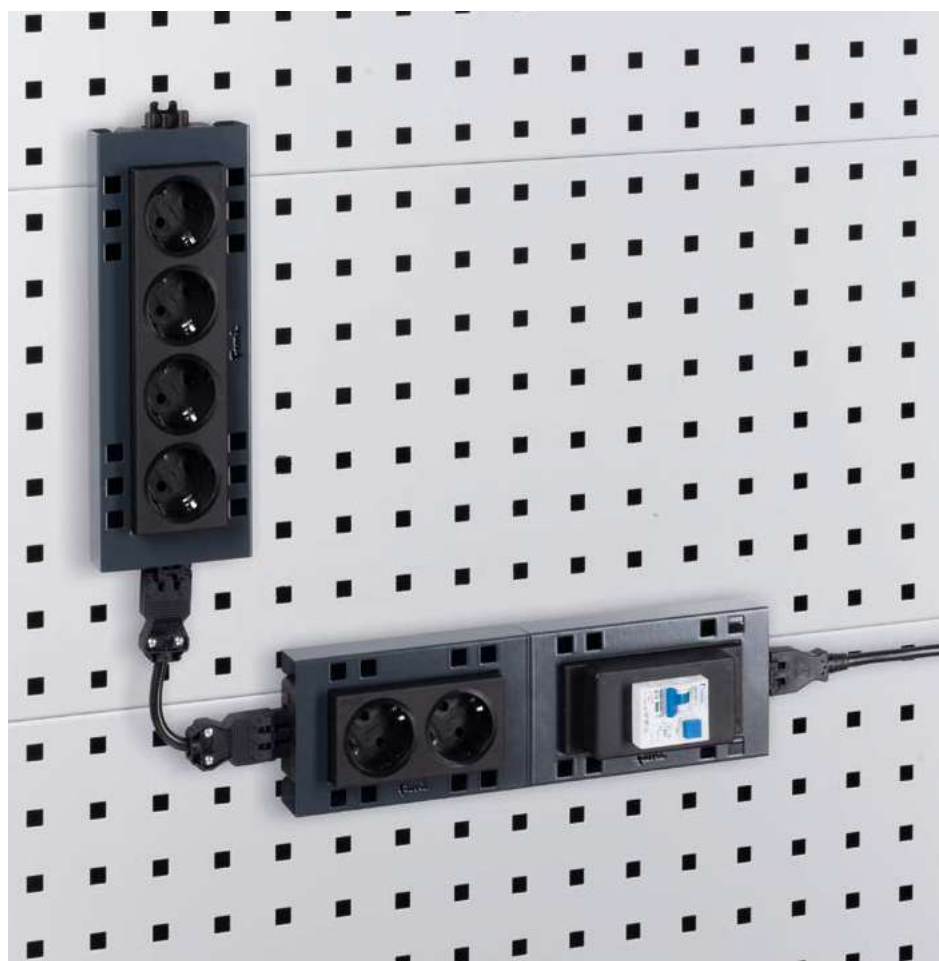

PATENTED DESIGN

IDEAONE05203 € 8,50

Supporto per interruttore magnetotermico
dim. mm 159x32x92 H



PATENTED DESIGN

IDEAONE05201 € 8,50

Supporto multipresa a 2 posti
dim. mm 148x32x92 H



PATENTED DESIGN

IDEAONE05202 € 10,50

Supporto multipresa a 4 posti
dim. mm 249x32x92 H

MULTIPRESE



IDEAONE05165 € 17,00

Multipresa Schuko a 2 posti
dim. mm 148x59x46

IDEAONE05167 € 39,00

Multipresa a 2 posti CH

IDEAONE05169 € 32,50

Multipresa a 2 posti GB

IDEAONE05171 € 16,50

Multipresa a 2 posti FR



IDEAONE05166 € 23,00

Multipresa Schuko a 4 posti
dim. mm 248x59x46

IDEAONE05168 € 46,00

Multipresa a 4 posti CH

IDEAONE05170 € 53,00

Multipresa a 4 posti GB

IDEAONE05172 € 22,00

Multipresa a 4 posti FR



IDEAONE05178 € 90,00

Magnetotermico differenziale 2P+T 0,03A
dim. mm 159x59x90 H

CAVI DI COLLEGAMENTO



IDEAONE05173  € 15,00

Cavo di collegamento
 Wieland con spine in/out
 dim. mm 100



IDEAONE05179  € 16,00

Cavo di collegamento
 Wieland - Schuko/FR
 dim. mm 3000



IDEAONE05177  € 16,00

Connettore ad H Wieland
 1 input - 2 output



IDEAONE05180  € 19,50

Cavo di collegamento
 Wieland - GB
 dim. mm 3000

IDEAONE05174  € 17,50

Cavo di collegamento
 Wieland con spine in/out
 dim. mm 1500

IDEAONE05181  € 18,00

Cavo di collegamento
 Wieland - CH
 dim. mm 3000





lampade vedi pag. 37



ART. WORKLOOK9001



€ 944,00

Composto da:

- 3 art. IDEAONE05193 pannelli/mensola
- 2 art. IDEAONE05192 pannelli/mensola
- 5 art. IDEAONE05286 kit staffe per fissaggio pannelli a muro
- 1 art. IDEAONE05217 cestino
- 2 art. IDEAONE05204 mensole grandi reversibili
- 1 art. IDEAONE05164 dispenser per guanti
- 1 art. IDEAONE05161 porta flacone igienizzante
- 1 art. IDEAONE05163 porta rotolo con carta
- 1 art. IDEAONE05158 porta documenti
- 1 art. IDEAONE05160 mensola porta oggetti reversibile
- 1 art. IDEAONE05203 supporto per interruttore magnetotermico
- 1 art. IDEAONE05201 supporto multipresa a 2 scomparti
- 1 art. IDEAONE05202 supporto multipresa a 4 scomparti
- 1 art. IDEAONE05178 magnetotermico differenziale
- 1 art. IDEAONE05165 multipresa Schuko a 2 scomparti
- 1 art. IDEAONE05166 multipresa Schuko a 4 scomparti
- 1 art. IDEAONE05179 cavo di collegamento Wieland Schuko/FR
- 5 art. IDEAONE05219 confezione di 30 ganci Unipok
- 2 art. IDEAONE05288 lampade doppie

PANNELLO 955

PANNELLO FORATO FERITOIE 10x10 INTERASSE 38 mm



IDEAONE05193 € 26,00

GRIGIO RAL 7035
Dim. mm: 955x304 H

IDEAONE05199 € 26,00

BLU RAL 5012
Dim. mm: 955x304 H

KIT 1 MENSOLA/PANNELLO

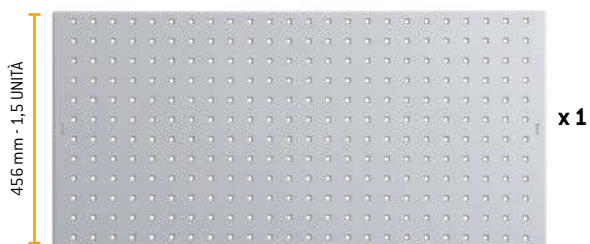

IDEAONE05191 € 41,50

GRIGIO RAL 7035
Dim. mm: 955x456 H

IDEAONE05197 € 41,50

BLU RAL 5012
Dim. mm: 955x456 H



IDEAONE05286 € 9,00

Kit staffe per fissaggio pannelli a muro.
Viterie di fissaggio escluse.

PANNELLO 1440

PANNELLO FORATO FERITOIE 10x10 INTERASSE 38 mm



IDEAONE05194 € 32,50

GRIGIO RAL 7035
Dim. mm: 1440x304 H

IDEAONE05200 € 32,50

BLU RAL 5012
Dim. mm: 1440x304 H

KIT 1 MENSOLA/PANNELLO

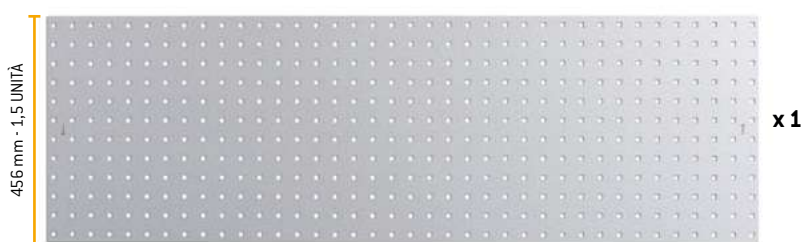

IDEAONE05192 € 55,00

GRIGIO RAL 7035
Dim. mm: 1440x456 H

IDEAONE05198 € 55,00

BLU RAL 5012
Dim. mm: 1440x456 H

GANCI PER FORI QUADRI



IDEAONE05092

Gancio curvo - dim. mm: P=28 - Ø 5 mm
confezione da 10 pz. - colore: zincato

€ 1,48

CADAUNO

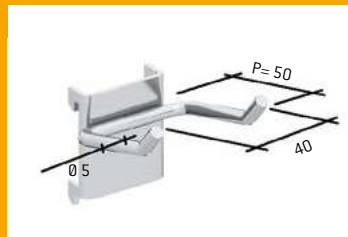

IDEAONE05093

Gancio per angolo - dim. mm: P= 50 - Ø 5 mm
confezione da 10 pz. - colore: zincato

€ 1,48

CADAUNO



IDEAONE05094

Porta cacciaviti - Ø 18 mm
confezione da 10 pz. - colore: zincato

€ 1,35

CADAUNO

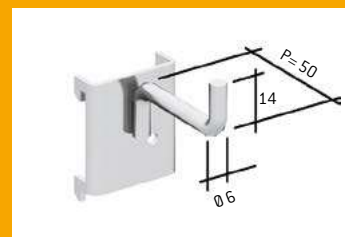

IDEAONE05095

Gancio semplice - dim. mm: P= 50 - Ø 6 mm
confezione da 10 pz. - colore: zincato

€ 1,30

CADAUNO

BANCO DA LAVORO

SERIE WORK

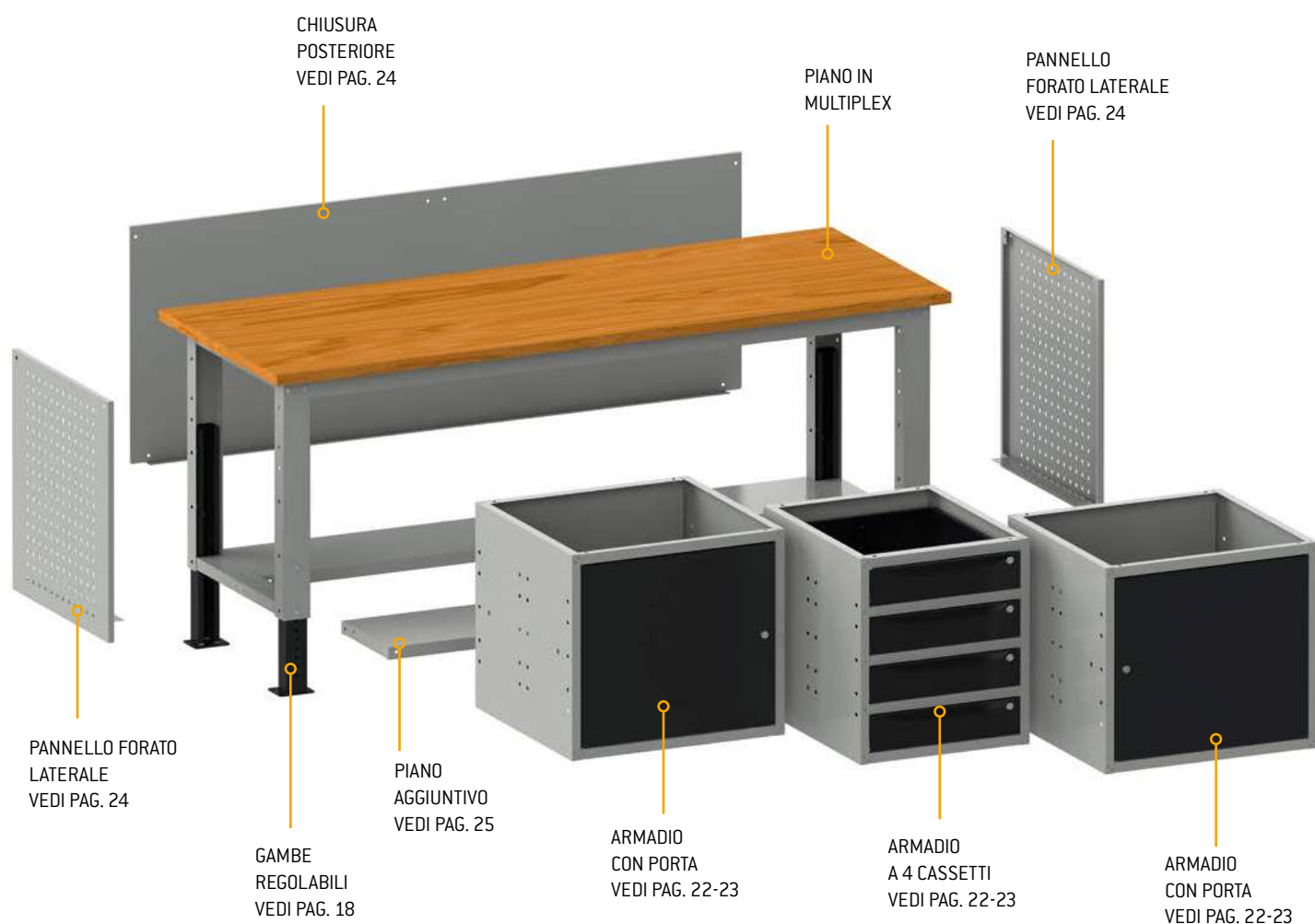



ART. WORK2013  **€ 2.267,50**

Composto da:

- 1 art. IDEAONE05130 banco WORK UP
- 2 art. IDEAONE06111 armadi WORK con porta
- 1 art. IDEAONE06103 armadio WORK con 4 cassetti
- 2 art. IDEAONE06097 pannelli forati
- 1 art. IDEAONE06072 semipiano
- 1 art. IDEAONE05136 kit 3 montanti biasolati
- 2 art. IDEAONE05141 kit 3 mensole/pannelli

- 1 art. IDEAONE05149 kit 3 supporti con 2 binari base
- 2 art. IDEAONE05185 binari base
- 1 art. IDEAONE05187 set aria compressa
- 1 art. IDEAONE05290 lampada doppia
- 1 art. IDEAONE05217 cestino
- 2 art. IDEAONE05215 porta bombole
- 2 art. IDEAONE05158 porta documenti
- 1 art. IDEAONE05204 mensola grande reversibile
- 1 art. IDEAONE05203 supporto per int. magnetotermico

- 1 art. IDEAONE05201 supporto multipresa a 2 scomparti
- 1 art. IDEAONE05202 supporto multipresa a 4 scomparti
- 1 art. IDEAONE05178 magnetotermico differenziale
- 1 art. IDEAONE05166 multipresa Schuko 4 scomparti
- 1 art. IDEAONE05165 multipresa Schuko 2 scomparti
- 1 art. IDEAONE05179 cavo di collegamento Wieland Schuko/FR
- 1 art. IDEAONE05163 porta rotolo con carta
- 2 art. IDEAONE05225 kit con 2 Picking Box
- 6 art. IDEAONE05219 confezione di 30 ganci Unipok

COPERTURA IN ACCIAIO ZINCATO RIVESTITA IN GOMMA ANTIOILIO

IDEAONE06052

copertura in acciaio gommato
dim. mm: 1024x700x27 H

€ 60,00

IDEAONE06053

copertura in acciaio gommato
dim. mm: 1500x700x27 H

€ 83,00

IDEAONE06054

copertura in acciaio gommato
dim. mm: 2000x700x27 H

€ 104,00

IDEAONE05109

copertura in acciaio gommato
dim. mm: 1024x750x20 H

€ 64,00

IDEAONE05110

copertura in acciaio gommato
dim. mm: 1500x750x20 H

€ 86,00

IDEAONE05111

copertura in acciaio gommato
dim. mm: 2000x750x20 H

€ 108,00



WORK UP

BANCO FORNITO SMONTATO



GAMBE
REGOLABILI
IN ALTEZZA



1000

€ 198,00 

IDEAONE06091 ANTRACITE RAL 7016 + GRIGIO RAL 7035

Banco da lavoro con piano in acciaio 3 mm, portata 1000 kg,
fornito smontato - dim. mm: **1031**×705×740/1110 H

1000

€ 205,00 

IDEAONE05128 ANTRACITE RAL 7016 + GRIGIO RAL 7035

Banco da lavoro con piano in multiplex 30 mm, portata 1000 kg,
fornito smontato - dim. mm: **1024**×750×740/1110 H

1500

€ 232,00 

IDEAONE06093 ANTRACITE RAL 7016 + GRIGIO RAL 7035

Banco da lavoro con piano in acciaio 3 mm, portata 1000 kg,
fornito smontato - dim. mm: **1507**×705×740/1110 H

1500

€ 237,00 

IDEAONE05129 ANTRACITE RAL 7016 + GRIGIO RAL 7035

Banco da lavoro con piano in multiplex 30 mm, portata 1000 kg,
fornito smontato - dim. mm: **1500**×750×740/1110 H

2000

€ 273,00 

IDEAONE06095 ANTRACITE RAL 7016 + GRIGIO RAL 7035

Banco da lavoro con piano in acciaio 3 mm, portata 1000 kg,
fornito smontato - dim. mm: **2007**×705×740/1110 H

2000

€ 273,00 

IDEAONE05130 ANTRACITE RAL 7016 + GRIGIO RAL 7035

Banco da lavoro con piano in multiplex 30 mm, portata 1000 kg,
fornito smontato - dim. mm: **2000**×750×740/1110 H

RUOTE

IDEAONE06073 

Kit 4 ruote in gomma antitraccia sintetiche
Ø 125 mm con freno + kit rinforzo BLU RAL 5012
PORTATA BANCO CON RUOTE 200 kg

€ 50,00



IDEAONE06084 

Kit 4 ruote in gomma antitraccia sintetiche
Ø 125 mm con freno + kit rinforzo GRIGIO RAL 7035
PORTATA BANCO CON RUOTE 200 kg

€ 50,00



IMBALLO BANCO SMONTATO

BANCO FORNITO SMONTATO



1000

€ 188,00

IDEAONE06061 BLU RAL 5012

Banco da lavoro con piano in acciaio 3 mm, portata 1000 kg, fornito smontato - dim. mm: 1031×705×740/1110 H

1000

€ 200,00

IDEAONE05096 BLU RAL 5012

Banco da lavoro con piano in multiplex 30 mm, portata 1000 kg, fornito smontato - dim. mm: 1024×750×740/1110 H

1500

€ 220,00

IDEAONE06063 BLU RAL 5012

Banco da lavoro con piano in acciaio 3 mm, portata 1000 kg, fornito smontato - dim. mm: 1507×705×740/1110 H

1500

€ 232,00

IDEAONE05098 BLU RAL 5012

Banco da lavoro con piano in multiplex 30 mm, portata 1000 kg, fornito smontato - dim. mm: 1500×750×740/1110 H

2000

€ 256,00

IDEAONE06065 BLU RAL 5012

Banco da lavoro con piano in acciaio 3 mm, portata 1000 kg, fornito smontato - dim. mm: 2007×705×740/1110 H

2000

€ 268,00

IDEAONE05100 BLU RAL 5012

Banco da lavoro con piano in multiplex 30 mm, portata 1000 kg, fornito smontato - dim. mm: 2000×750×740/1110 H



ART. WORK2014 € 796,50

Composto da:

- 1 art. IDEAONE06095 banco WORK UP
- 1 art. IDEAONE06109 armadio WORK con porta
- 1 art. IDEAONE06103 armadio WORK con 4 cassetti
- 1 art. IDEAONE06077 fondo di chiusura per armadio
- 1 art. IDEAONE06060 chiusura posteriore
- 1 art. IDEAONE06068 semipiano non fessurato
- 2 art. IDEAONE06097 pannelli forati laterali

WORK



PIANO
REGOLABILE
IN ALTEZZA

BANCO FORNITO SMONTATO



1000

€ 152,00



IDEAONE06125 ANTRACITE RAL 7016 + GRIGIO RAL 7035

Banco da lavoro con piano in acciaio 3 mm, portata 1000 kg, fornito smontato - dim. mm: **1031**×705×855 H

1500

€ 190,00



IDEAONE06126 ANTRACITE RAL 7016 + GRIGIO RAL 7035

Banco da lavoro con piano in acciaio 3 mm, portata 1000 kg, fornito smontato - dim. mm: **1507**×705×855 H

2000

€ 229,00



IDEAONE06127 ANTRACITE RAL 7016 + GRIGIO RAL 7035

Banco da lavoro con piano in acciaio 3 mm, portata 1000 kg, fornito smontato - dim. mm: **2007**×705×855 H

1000

€ 161,00

IDEAONE05124 GRIGIO RAL 7035

Banco da lavoro con piano in multiplex 30 mm, portata 1000 kg, fornito smontato - dim. mm: **1024**×750×880 H

1500

€ 193,00

IDEAONE05123 GRIGIO RAL 7035

Banco da lavoro con piano in multiplex 30 mm, portata 1000 kg, fornito smontato - dim. mm: **1500**×750×880 H

2000

€ 229,00

IDEAONE05122 GRIGIO RAL 7035

Banco da lavoro con piano in multiplex 30 mm, portata 1000 kg, fornito smontato - dim. mm: **2000**×750×880 H

BANCO FORNITO MONTATO



1000

€ 159,00



IDEAONE06092 ANTRACITE RAL 7016 + GRIGIO RAL 7035

Banco da lavoro con piano in acciaio 3 mm, portata 1000 kg, fornito montato - dim. mm: **1031**×705×855 H

1500

€ 195,00



IDEAONE06094 ANTRACITE RAL 7016 + GRIGIO RAL 7035

Banco da lavoro con piano in acciaio 3 mm, portata 1000 kg, fornito montato - dim. mm: **1507**×705×855 H

2000

€ 239,00



IDEAONE06096 ANTRACITE RAL 7016 + GRIGIO RAL 7035

Banco da lavoro con piano in acciaio 3 mm, portata 1000 kg, fornito montato - dim. mm: **2007**×705×855 H

1000

€ 166,00

IDEAONE05060 GRIGIO RAL 7035

Banco da lavoro con piano in multiplex 30 mm, portata 1000 kg, fornito montato - dim. mm: **1024**×750×880 H

1500

€ 200,00

IDEAONE05061 GRIGIO RAL 7035

Banco da lavoro con piano in multiplex 30 mm, portata 1000 kg, fornito montato - dim. mm: **1500**×750×880 H

2000

€ 239,00

IDEAONE05062 GRIGIO RAL 7035

Banco da lavoro con piano in multiplex 30 mm, portata 1000 kg, fornito montato - dim. mm: **2000**×750×880 H



PIANO
REGOLABILE
IN ALTEZZA

BANCO FORNITO SMONTATO



1000

€ 149,00

IDEAONE06090 BLU RAL 5012

Banco da lavoro con piano in acciaio 3 mm, portata 1000 kg, fornito smontato - dim. mm: 1031×705×855 H

1500

€ 185,00

IDEAONE06089 BLU RAL 5012

Banco da lavoro con piano in acciaio 3 mm, portata 1000 kg, fornito smontato - dim. mm: 1507×705×855 H

2000

€ 217,00

IDEAONE06088 BLU RAL 5012

Banco da lavoro con piano in acciaio 3 mm, portata 1000 kg, fornito smontato - dim. mm: 2007×705×855 H

1000

€ 161,00

IDEAONE05127 BLU RAL 5012

Banco da lavoro con piano in multiplex 30 mm, portata 1000 kg, fornito smontato - dim. mm: 1024×750×880 H

1500

€ 193,00

IDEAONE05126 BLU RAL 5012

Banco da lavoro con piano in multiplex 30 mm, portata 1000 kg, fornito smontato - dim. mm: 1500×750×880 H

2000

€ 229,00

IDEAONE05125 BLU RAL 5012

Banco da lavoro con piano in multiplex 30 mm, portata 1000 kg, fornito smontato - dim. mm: 2000×750×880 H

BANCO FORNITO MONTATO



1000

€ 154,00

IDEAONE06030 BLU RAL 5012

Banco da lavoro con piano in acciaio 3 mm, portata 1000 kg, fornito montato - dim. mm: 1031×705×855 H

1500

€ 192,00

IDEAONE06031 BLU RAL 5012

Banco da lavoro con piano in acciaio 3 mm, portata 1000 kg, fornito montato - dim. mm: 1507×705×855 H

2000

€ 227,00

IDEAONE06032 BLU RAL 5012

Banco da lavoro con piano in acciaio 3 mm, portata 1000 kg, fornito montato - dim. mm: 2007×705×855 H

1000

€ 166,00

IDEAONE05040 BLU RAL 5012

Banco da lavoro con piano in multiplex 30 mm, portata 1000 kg, fornito montato - dim. mm: 1024×750×880 H

1500

€ 200,00

IDEAONE05041 BLU RAL 5012

Banco da lavoro con piano in multiplex 30 mm, portata 1000 kg, fornito montato - dim. mm: 1500×750×880 H

2000

€ 239,00

IDEAONE05042 BLU RAL 5012

Banco da lavoro con piano in multiplex 30 mm, portata 1000 kg, fornito montato - dim. mm: 2000×750×880 H

ACCESSORI

WORK UP
WORK

1000



1500

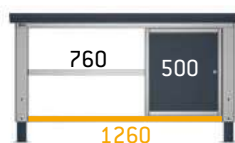

2000

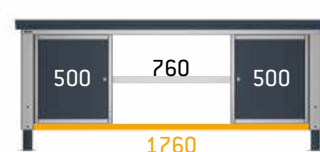
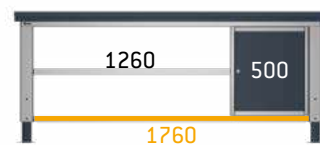

SCHEMA TECNICO ACCESSORI

PRODOTTI IN VENDITA DA
DICEMBRE 2020



IDEAONE06099

ANTRACITE RAL 7016
+ GRIGIO RAL 7035
Armadio a 1 cassetto,
portata cassetti 25 kg
dim. mm: 500x607x210 H

€ 69,00



IDEAONE06122

ANTRACITE RAL 7016
+ GRIGIO RAL 7035
Armadio a 3 cassetti,
portata cassetti 25 kg
dim. mm: 500x607x570 H

€ 185,00



IDEAONE06103

ANTRACITE RAL 7016
+ GRIGIO RAL 7035
Armadio a 4 cassetti,
portata cassetti 25 kg
dim. mm: 500x607x570 H

€ 250,00



IDEAONE06106

ANTRACITE RAL 7016
+ GRIGIO RAL 7035
Armadio a 1 cassetto e 1 porta,
portata cassetto 25 kg
dim. mm: 500x607x570 H

€ 139,00

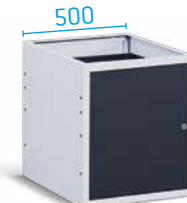

IDEAONE06109

ANTRACITE RAL 7016
+ GRIGIO RAL 7035
Armadio con porta e
1 piano regolabile,
dim. mm: 500x607x570 H

€ 122,00



IDEAONE06035

BLU RAL 5012
Armadio a 1 cassetto,
portata cassetti 25 kg
dim. mm: 500x607x210 H

€ 65,00



IDEAONE06033

BLU RAL 5012
Armadio a 3 cassetti,
portata cassetti 25 kg
dim. mm: 500x607x570 H

€ 175,00



IDEAONE06102

BLU RAL 5012
Armadio a 4 cassetti,
portata cassetti 25 kg
dim. mm: 500x607x570 H

€ 237,00



IDEAONE06034

BLU RAL 5012
Armadio a 1 cassetto e 1 porta,
portata cassetto 25 kg
dim. mm: 500x607x570 H

€ 131,00



IDEAONE06074

BLU RAL 5012
Armadio con porta e
1 piano regolabile,
dim. mm: 500x607x570 H

€ 115,00

FONDO DI CHIUSURA PER ARMADI



DA UTILIZZARE SOLO NEGLI ARMADI CON PORTA QUANDO È PRESENTE IL SEMI PIANO

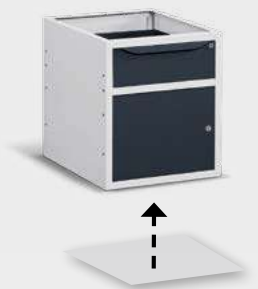

IDEAONE06077

GRIGIO RAL 7035
fondo di chiusura per armadio
L = 500 mm

€ 22,00

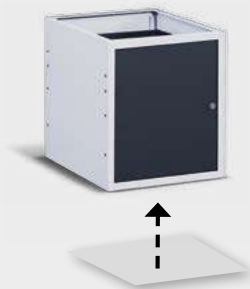

IDEAONE06124

GRIGIO RAL 7035
fondo di chiusura per armadio
L = 630 mm

€ 24,00

IDEAONE06076

BLU RAL 5012
fondo di chiusura per armadio
L = 500 mm

€ 22,00

IDEAONE06123

BLU RAL 5012
fondo di chiusura per armadio
L = 630 mm

€ 24,00



IDEAONE06101

ANTRACITE RAL 7016
+ GRIGIO RAL 7035
Armadio a 3 cassetti,
portata cassetti 25 kg
dim. mm: 630×607×570 H

€ 195,00



IDEAONE06105

ANTRACITE RAL 7016
+ GRIGIO RAL 7035
Armadio a 4 cassetti,
portata cassetti 25 kg
dim. mm: 630×607×570 H

€ 263,00

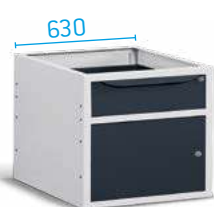

IDEAONE06108

ANTRACITE RAL 7016
+ GRIGIO RAL 7035
Armadio a 1 cassetto e 1 porta,
portata cassetto 25 kg
dim. mm: 630×607×570 H

€ 147,00

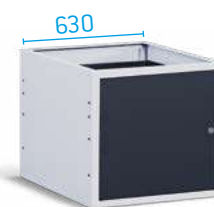

IDEAONE06111

ANTRACITE RAL 7016
+ GRIGIO RAL 7035
Armadio con porta e
1 piano regolabile,
dim. mm: 630×607×570 H

€ 128,00



IDEAONE06100

BLU RAL 5012
Armadio a 3 cassetti,
portata cassetti 25 kg
dim. mm: 630×607×570 H

€ 184,00



IDEAONE06104

BLU RAL 5012
Armadio a 4 cassetti,
portata cassetti 25 kg
dim. mm: 630×607×570 H

€ 249,00



IDEAONE06107

BLU RAL 5012
Armadio a 1 cassetto e 1 porta,
portata cassetto 25 kg
dim. mm: 630×607×570 H

€ 138,00



IDEAONE06110

BLU RAL 5012
Armadio con porta e
1 piano regolabile,
dim. mm: 630×607×570 H

€ 121,00

ACCESSORI

WORK UP
WORK

CHIUSURA POSTERIORE



1000

IDEAONE06058

€ 32,50

GRIGIO RAL 7035
Dim. mm: 825x48x665 H



IDEAONE06048

€ 32,50

BLU RAL 5012
Dim. mm: 825x48x665 H



1500

IDEAONE06059

€ 36,50

GRIGIO RAL 7035
Dim. mm: 1325x48x665 H



IDEAONE06049

€ 36,50

BLU RAL 5012
Dim. mm: 1325x48x665 H



2000

IDEAONE06060

€ 48,00

GRIGIO RAL 7035
Dim. mm: 1825x48x665 H



IDEAONE06050

€ 48,00

BLU RAL 5012
Dim. mm: 1825x48x665 H



COPPIA TAMPONI PER BANCO 1000



IDEAONE06112

GRIGIO RAL 7035
L = 65 mm

€ 12,00



IDEAONE06113

BLU RAL 5012
L = 65 mm

€ 12,00



PANNELLO FORATO LATERALE



IDEAONE06097

Dim. mm: 610x18x669 H
GRIGIO RAL 7035

€ 30,00



IDEAONE06098

Dim. mm: 610x18x669 H
BLU RAL 5012

€ 30,00



PIANO AGGIUNTIVO

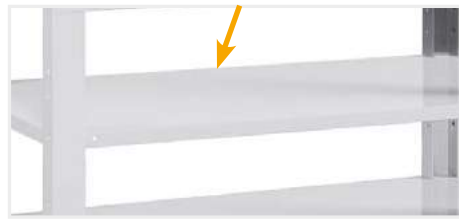

PIANO 760 mm

IDEAONE06116 € 30,00
GRIGIO RAL 7035
Dim. mm: 760×600×35 H - portata 250 kg

IDEAONE06117 € 30,00
BLU RAL 5012
Dim. mm: 760×600×35 H - portata 250 kg

PIANO 1260 mm

IDEAONE06118 € 38,00
GRIGIO RAL 7035
Dim. mm: 1260×600×35 H - portata 250 kg

IDEAONE06119 € 38,00
BLU RAL 5012
Dim. mm: 1260×600×35 H - portata 250 kg

PIANO 1760 mm

IDEAONE06120 € 46,00
GRIGIO RAL 7035
Dim. mm: 1760×600×35 H - portata 200 kg

IDEAONE06121 € 46,00
BLU RAL 5012
Dim. mm: 1760×600×35 H - portata 200 kg

SEMIPIANO AGGIUNTIVO



PIANO 760 mm

IDEAONE06068 € 20,50
GRIGIO RAL 7035
Dim. mm: 760×300×35 H - portata 100 kg

IDEAONE06067 € 20,50
BLU RAL 5012
Dim. mm: 760×300×35 H - portata 100 kg

PIANO 1260 mm

IDEAONE06070 € 24,50
GRIGIO RAL 7035
Dim. mm: 1260×300×35 H - portata 100 kg

IDEAONE06069 € 24,50
BLU RAL 5012
Dim. mm: 1260×300×35 H - portata 100 kg

PIANO 1760 mm

IDEAONE06072 € 30,00
GRIGIO RAL 7035
Dim. mm: 1760×300×35 H - portata 100 kg

IDEAONE06071 € 30,00
BLU RAL 5012
Dim. mm: 1760×300×35 H - portata 100 kg



SUPPORTO PER SEMIPIANO INTERMEDIO

IDEAONE06114 € 7,00
GRIGIO RAL 7035
Dim. mm: 605×75×35 H

IDEAONE06115 € 7,00
BLU RAL 5012
Dim. mm: 605×75×35 H

WORK LOOK

PARETI ATTREZZATE

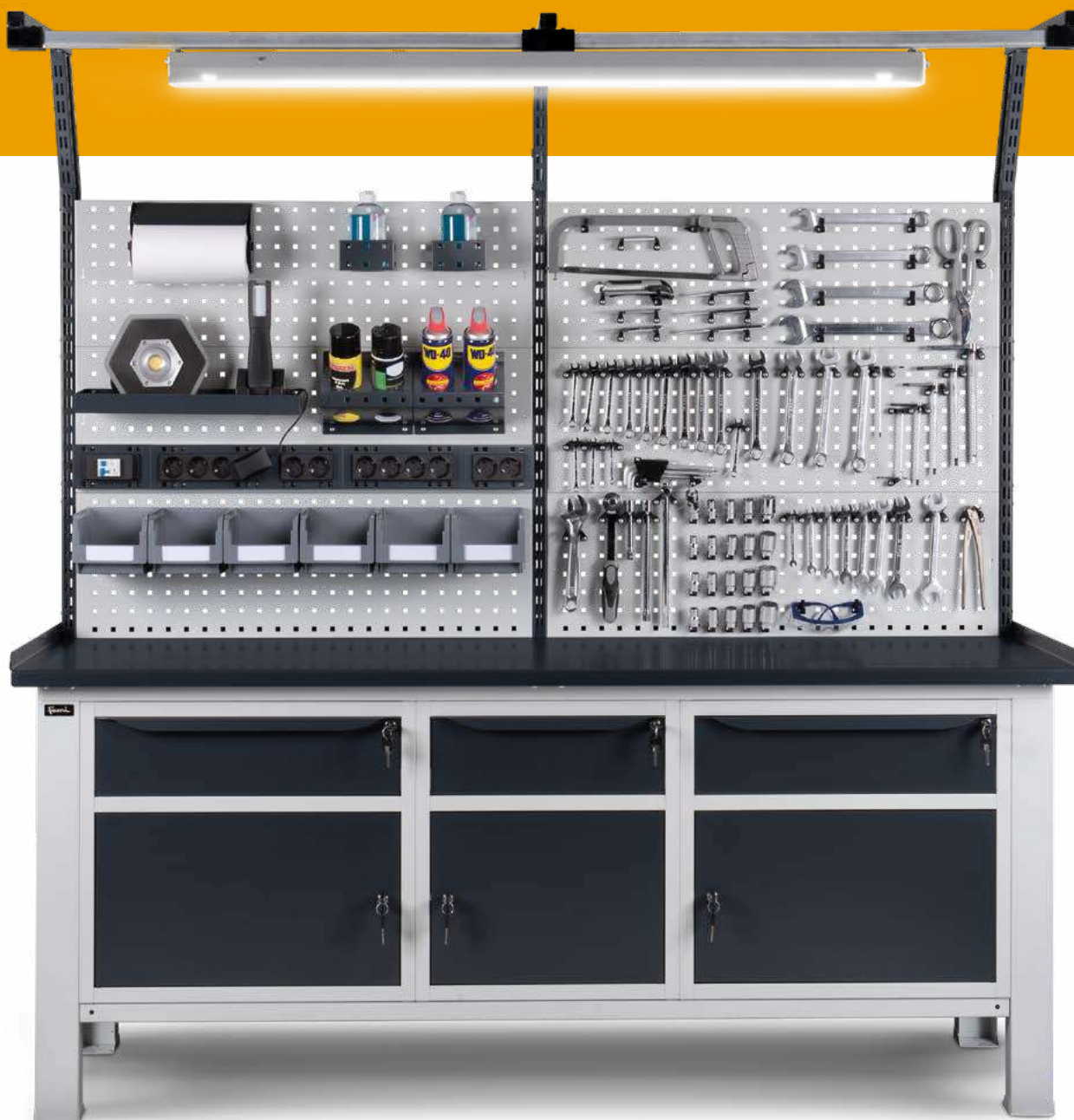

ART. WORK2015 € 1.625,50

Composto da:

- 1 art. IDEAONE06127 banco WORK
- 2 art. IDEAONE06108 armadi WORK L = 630 con 1 cassetto
- 1 art. IDEAONE06106 armadio WORK L = 500 con 1 cassetto
- 1 art. IDEAONE05136 kit 3 montanti biasolati
- 2 art. IDEAONE05141 kit 3 mensole/pannelli
- 1 art. IDEAONE05149 kit 3 supporti con 2 binari base
- 1 art. IDEAONE05290 lampada doppia
- 2 art. IDEAONE05223 barre aggancio Picking Box con 3 Picking Box
- 1 art. IDEAONE05203 supporto per interruttore magnetotermico
- 2 art. IDEAONE05201 supporto multipresa 2 scomparti

- 2 art. IDEAONE05202 supporto multipresa 4 scomparti
- 1 art. IDEAONE05178 magnetotermico differenziale
- 2 art. IDEAONE05166 multipresa Schuko 4 scomparti
- 2 art. IDEAONE05165 multipresa Schuko 2 scomparti
- 1 art. IDEAONE05179 cavo di collegamento Wieland Schuko/FR
- 1 art. IDEAONE05160 mensola portaoggetti reversibile
- 2 art. IDEAONE05215 porta bombole
- 1 art. IDEAONE05162 kit porta rotolo con carta
- 2 art. IDEAONE05161 porta flacone igienizzante
- 6 art. IDEAONE05219 confezione di 30 ganci Unipok

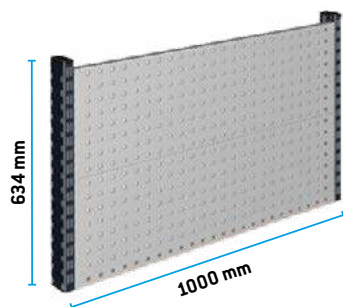

PACCHETTO WORKLOOK1001

ESEMPIO PARETE ATTREZZATA COMPOSTA DA:

1 PZ. **IDEAONE05131** € 43,00

KIT 2 MONTANTI BIASOLATI PER BANCHI
DIM. mm 634 H
COLORE: GRIGIO ANTRACITE RAL7016

1 PZ. **IDEAONE05139** € 60,00

KIT 2 MENSOLE/PANNELLI +
1 BORDO FERMACASSA
DIM. mm 955x30x304 H
COLORE: GRIGIO CHIARO RAL7035



ESEMPIO DI CONFIGURAZIONE POSSIBILE
CON IL PACCHETTO WORKLOOK1001/1002

PREZZO TOTALE € 103,00

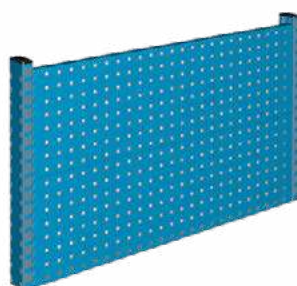

PACCHETTO WORKLOOK1002

ESEMPIO PARETE ATTREZZATA COMPOSTA DA:

1 PZ. **IDEAONE05133** € 38,00

KIT 2 MONTANTI BIASOLATI PER BANCHI
DIM. mm 634 H
COLORE: BLU RAL 5012

1 PZ. **IDEAONE05143** € 60,00

KIT 2 MENSOLE/PANNELLI +
1 BORDO FERMACASSA
DIM. mm 955x30x304 H
COLORE: BLU RAL 5012

PREZZO TOTALE € 98,00

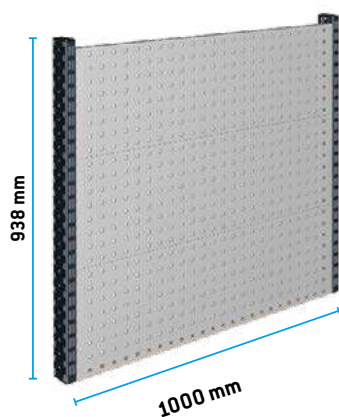

PACCHETTO WORKLOOK1003

ESEMPIO PARETE ATTREZZATA COMPOSTA DA:

1 PZ. **IDEAONE05132** € 50,00

KIT 2 MONTANTI BIASOLATI PER BANCHI
DIM. mm 938 H
COLORE: GRIGIO ANTRACITE RAL7016

1 PZ. **IDEAONE05141** € 90,00

KIT 3 MENSOLE/PANNELLI +
2 BORDI FERMACASSA
DIM. mm 955x30x304 H
COLORE: GRIGIO CHIARO RAL7035



ESEMPI DI CONFIGURAZIONE POSSIBILI
CON IL PACCHETTO WORKLOOK1003/1004

PREZZO TOTALE € 140,00

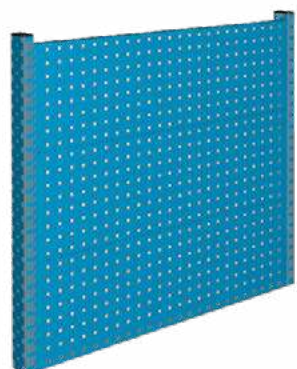

PACCHETTO WORKLOOK1004

ESEMPIO PARETE ATTREZZATA COMPOSTA DA:

1 PZ. **IDEAONE05134** € 45,00

KIT 2 MONTANTI BIASOLATI PER BANCHI
DIM. mm 938 H
COLORE: BLU RAL 5012

1 PZ. **IDEAONE05145** € 90,00

KIT 3 MENSOLE/PANNELLI +
2 BORDI FERMACASSA
DIM. mm 955x30x304 H
COLORE: BLU RAL 5012

PREZZO TOTALE € 135,00

WORK LOOK

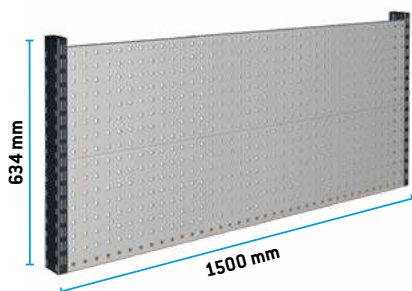

PACCHETTO WORKLOOK1501

ESEMPIO PARETE ATTREZZATA COMPOSTA DA:

1 PZ. **IDEAONE05131** € 43,00

KIT 2 MONTANTI BIASOLATI PER BANCHI
DIM. mm 634 H
COLORE: GRIGIO ANTRACITE RAL7016

1 PZ. **IDEAONE05140** € 70,50

KIT 2 MENSOLE/PANNELLI +
1 BORDO FERMACASSA
DIM. mm 1440x30x304 H
COLORE: GRIGIO CHIARO RAL7035



ESEMPIO DI CONFIGURAZIONE POSSIBILE
CON IL PACCHETTO WORKLOOK1501/1502

PREZZO TOTALE  € 113,50

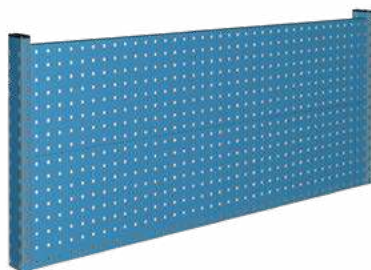

PACCHETTO WORKLOOK1502

ESEMPIO PARETE ATTREZZATA COMPOSTA DA:

1 PZ. **IDEAONE05133** € 38,00

KIT 2 MONTANTI BIASOLATI PER BANCHI
DIM. mm 634 H
COLORE: BLU RAL 5012

1 PZ. **IDEAONE05144** € 70,50

KIT 2 MENSOLE/PANNELLI +
1 BORDDO FERMACASSA
DIM. mm 1440x30x304 H
COLORE: BLU RAL 5012

PREZZO TOTALE  € 108,50

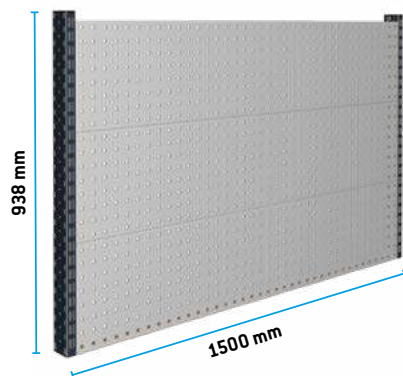

PACCHETTO WORKLOOK1503

ESEMPIO PARETE ATTREZZATA COMPOSTA DA:

1 PZ. **IDEAONE05132** € 50,00

KIT 2 MONTANTI BIASOLATI PER BANCHI
DIM. mm 938 H
COLORE: GRIGIO ANTRACITE RAL7016

1 PZ. **IDEAONE05142** € 110,00

KIT 3 MENSOLE/PANNELLI +
2 BORDI FERMACASSA
DIM. mm 1440x30x304 H
COLORE: GRIGIO CHIARO RAL7035



ESEMPI DI CONFIGURAZIONE POSSIBILI
CON IL PACCHETTO WORKLOOK1503/1504

PREZZO TOTALE  € 160,00

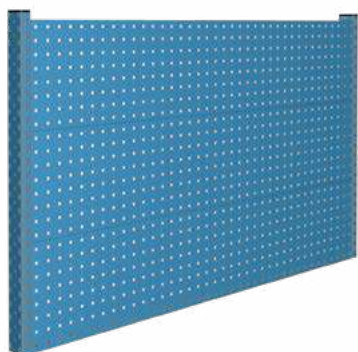

PACCHETTO WORKLOOK1504

ESEMPIO PARETE ATTREZZATA COMPOSTA DA:

1 PZ. **IDEAONE05134** € 45,00

KIT 2 MONTANTI BIASOLATI PER BANCHI
DIM. mm 938 H
COLORE: BLU RAL 5012

1 PZ. **IDEAONE05146** € 110,00

KIT 3 MENSOLE/PANNELLI +
2 BORDI FERMACASSA
DIM. mm 1440x30x304 H
COLORE: BLU RAL 5012

PREZZO TOTALE  € 155,00

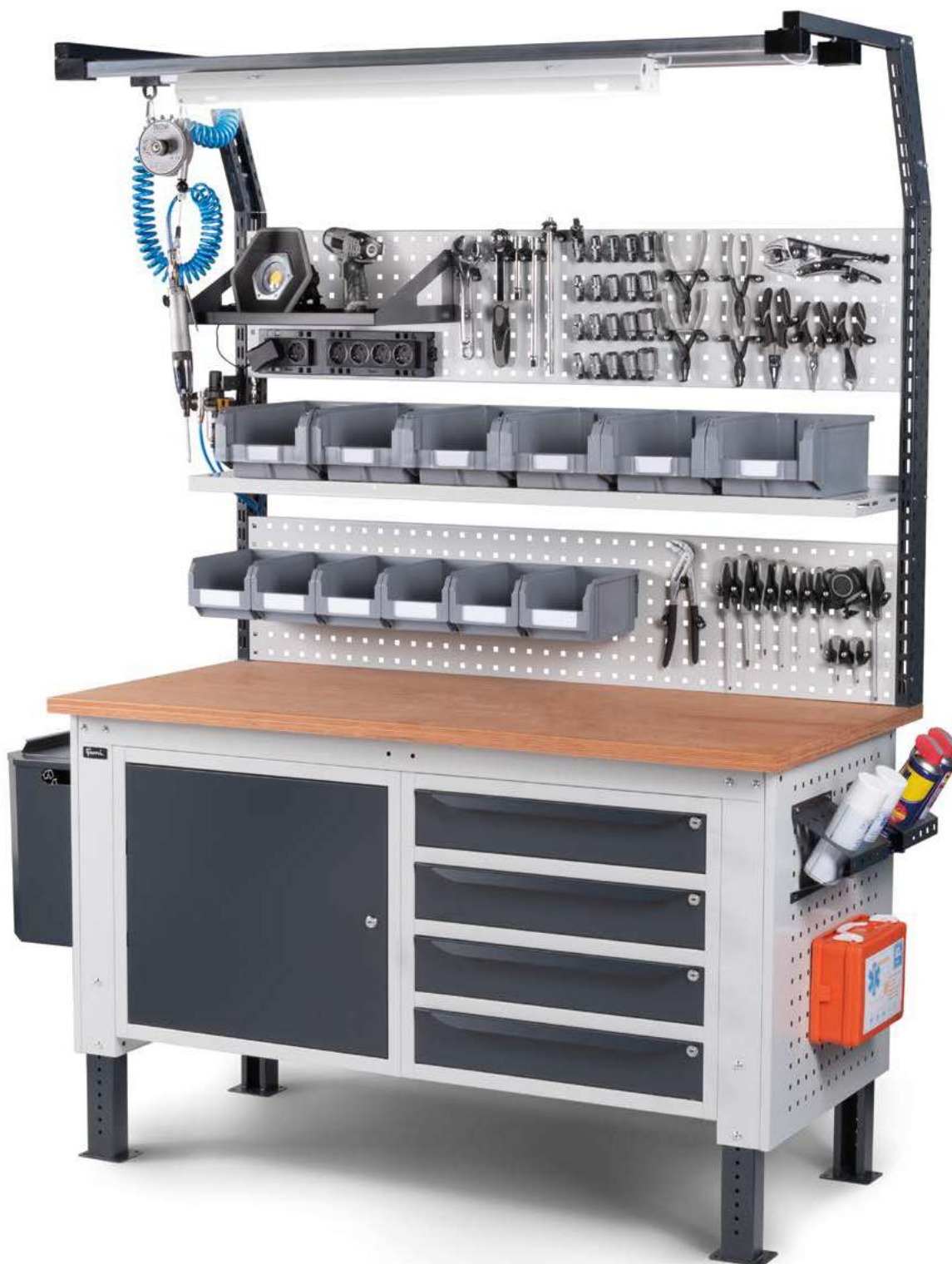

ART. WORK1513  € 1.771,50

Composto da:

- 1 art. IDEAOONE05129 banco WORK UP
- 1 art. IDEAOONE06111 armadio WORK con porta
- 1 art. IDEAOONE06105 armadio WORK con 4 cassetti
- 1 art. IDEAOONE06124 fondo di chiusura
- 2 art. IDEAOONE06097 pannello forato laterale
- 1 art. IDEAOONE05217 cestino
- 2 art. IDEAOONE05215 porta bombolette
- 1 art. IDEAOONE05214 kit pronto soccorso
- 1 art. IDEAOONE05132 kit 2 montanti biasolati
- 1 art. IDEAOONE05142 kit 3 mensole/pannelli
- 1 art. IDEAOONE05148 kit 2 supporti con binario

- 1 art. IDEAOONE05186 binario base
- 1 art. IDEAOONE05288 lampada doppia
- 1 art. IDEAOONE05187 set aria compressa con bilanciatore
- 2 art. IDEAOONE05223 barre aggancio Picking Box con 3 Picking Box
- 3 art. IDEAOONE05225 kit 2 Picking Box
- 1 art. IDEAOONE05201 supporto multipresa 2 scomparti
- 1 art. IDEAOONE05202 supporto multipresa 4 scomparti
- 1 art. IDEAOONE05166 multipresa Schuko 4 scomparti
- 1 art. IDEAOONE05165 multipresa Schuko 2 scomparti
- 1 art. IDEAOONE05179 cavo di collegamento Wieland Schuko/FR
- 1 art. IDEAOONE05204 mensola grande reversibile
- 3 art. IDEAOONE05219 confezione di 30 ganci Unipok

WORK LOOK

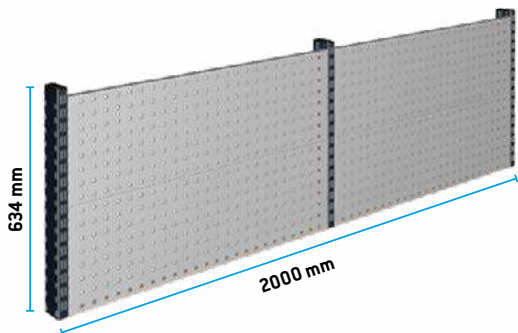

PACCHETTO

WORKLOOK2001

ESEMPIO PARETE ATTREZZATA COMPOSTA DA:

1 PZ. **IDEAONE05135** € 64,50

KIT 3 MONTANTI BIASOLATI PER BANCHI
DIM. mm 634 H
COLORE: GRIGIO ANTRACITE RAL7016

2 PZ. **IDEAONE05139** € 60,00

KIT 2 MENSOLE/PANNELLI +
1 BORDO FERMACASSA
DIM. mm 955x30x304 H
COLORE: GRIGIO CHIARO RAL7035

PREZZO TOTALE € 184,50

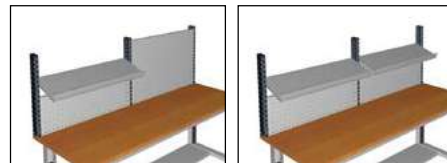

ESEMPI DI CONFIGURAZIONE POSSIBILI
CON IL PACCHETTO WORKLOOK2001/2002

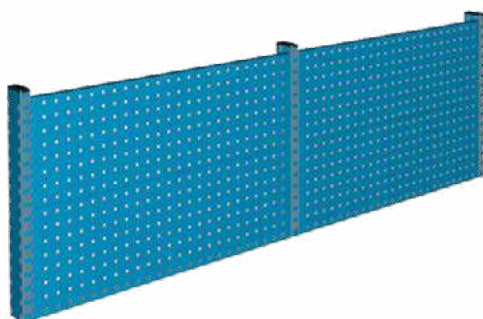

PACCHETTO

WORKLOOK2002

ESEMPIO PARETE ATTREZZATA COMPOSTA DA:

1 PZ. **IDEAONE05137** € 57,00

KIT 3 MONTANTI BIASOLATI PER BANCHI
DIM. mm 634 H
COLORE: BLU RAL 5012

2 PZ. **IDEAONE05143** € 60,00

KIT 2 MENSOLE/PANNELLI +
1 BORDO FERMACASSA
DIM. mm 955x30x304 H
COLORE: BLU RAL 5012

PREZZO TOTALE € 177,00

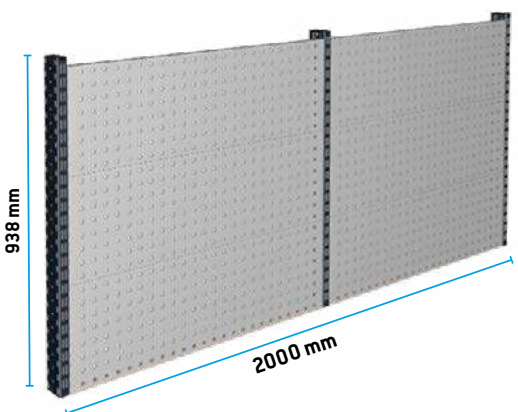

PACCHETTO

WORKLOOK2003

ESEMPIO PARETE ATTREZZATA COMPOSTA DA:

1 PZ. **IDEAONE05136** € 75,00

KIT 3 MONTANTI BIASOLATI PER BANCHI
DIM. mm 938 H
COLORE: GRIGIO ANTRACITE RAL7016

2 PZ. **IDEAONE05141** € 90,00

KIT 3 MENSOLE/PANNELLI +
2 BORDI FERMACASSA
DIM. mm 955x30x304 H
COLORE: GRIGIO CHIARO RAL7035

PREZZO TOTALE € 255,00

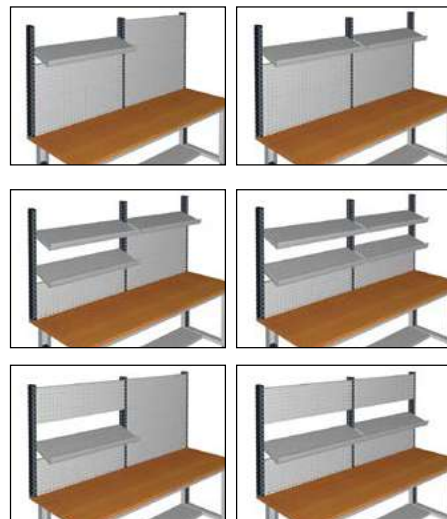

ESEMPI DI CONFIGURAZIONE POSSIBILI
CON IL PACCHETTO WORKLOOK2003/2004

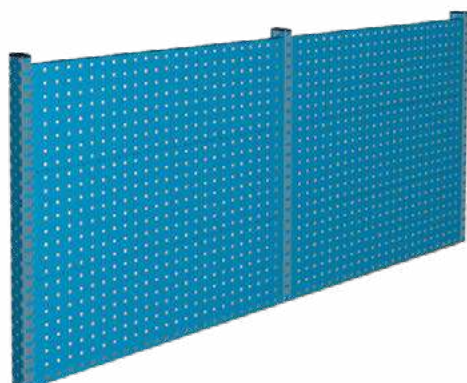

PACCHETTO

WORKLOOK2004

ESEMPIO PARETE ATTREZZATA COMPOSTA DA:

1 PZ. **IDEAONE05138** € 67,50

KIT 3 MONTANTI BIASOLATI PER BANCHI
DIM. mm 938 H
COLORE: BLU RAL 5012

2 PZ. **IDEAONE05145** € 90,00

KIT 3 MENSOLE/PANNELLI +
2 BORDI FERMACASSA
DIM. mm 955x30x304 H
COLORE: BLU RAL 5012

PREZZO TOTALE € 247,50

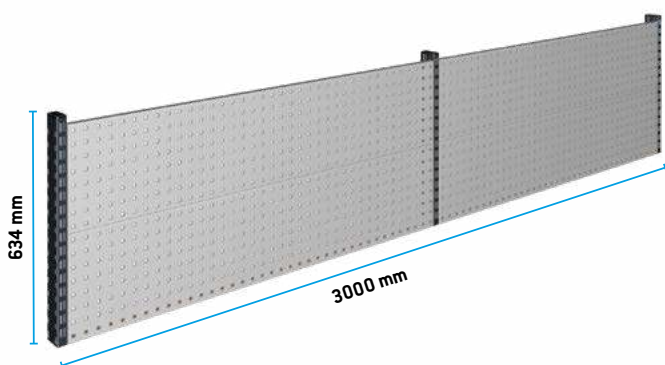

PACCHETTO

WORKLOOK3001

ESEMPIO PARETE ATTREZZATA COMPOSTA DA:

1 PZ. **IDEAONE05135** € 64,50

KIT 3 MONTANTI BIASOLATI PER BANCHI
DIM. mm 634 H
COLORE: GRIGIO ANTRACITE RAL7016

2 PZ. **IDEAONE05140** € 70,50

KIT 2 MENSOLE/PANNELLI +
1 BORDO FERMACASSA
DIM. mm 1440x30x304 H
COLORE: GRIGIO CHIARO RAL7035



ESEMPI DI CONFIGURAZIONE
POSSIBILI CON IL PACCHETTO
WORKLOOK3001/3002

PREZZO TOTALE € 205,50

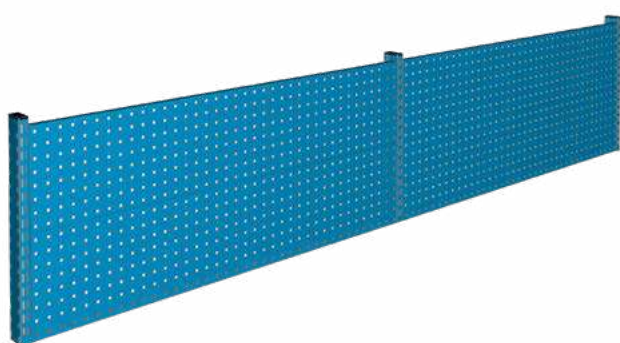

PACCHETTO

WORKLOOK3002

ESEMPIO PARETE ATTREZZATA COMPOSTA DA:

1 PZ. **IDEAONE05137** € 57,00

KIT 3 MONTANTI BIASOLATI PER BANCHI
DIM. mm 634 H
COLORE: BLU RAL 5012

2 PZ. **IDEAONE05144** € 70,50

KIT 2 MENSOLE/PANNELLI +
1 BORDO FERMACASSA
DIM. mm 1440x30x304 H
COLORE: BLU RAL 5012

PREZZO TOTALE € 198,00

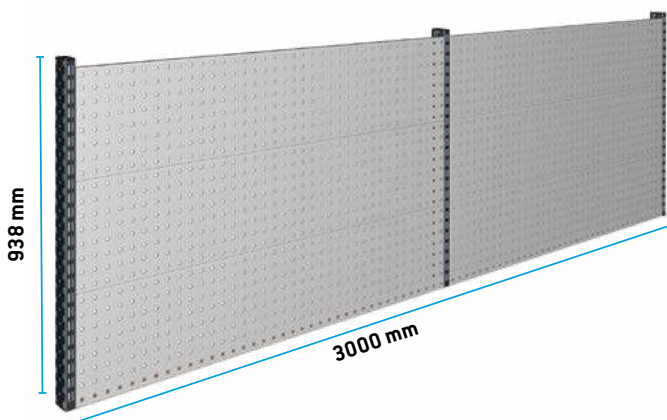

PACCHETTO

WORKLOOK3003

ESEMPIO PARETE ATTREZZATA COMPOSTA DA:

1 PZ. **IDEAONE05136** € 75,00

KIT 3 MONTANTI BIASOLATI PER BANCHI
DIM. mm 938 H
COLORE: GRIGIO ANTRACITE RAL7016

2 PZ. **IDEAONE05142** € 110,00

KIT 3 MENSOLE/PANNELLI +
2 BORDI FERMACASSA
DIM. mm 1440x30x304 H
COLORE: GRIGIO CHIARO RAL7035



ESEMPI DI CONFIGURAZIONE
POSSIBILI CON IL PACCHETTO
WORKLOOK3003/3004

PREZZO TOTALE € 295,00

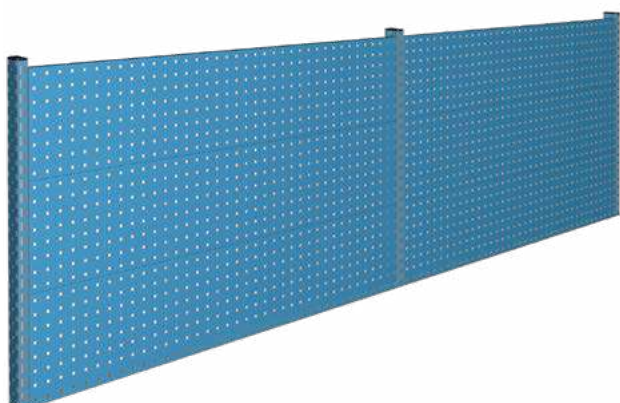

PACCHETTO

WORKLOOK3004

ESEMPIO PARETE ATTREZZATA COMPOSTA DA:

1 PZ. **IDEAONE05138** € 67,50

KIT 3 MONTANTI BIASOLATI PER BANCHI
DIM. mm 938 H
COLORE: BLU RAL 5012

2 PZ. **IDEAONE05146** € 110,00

KIT 3 MENSOLE/PANNELLI +
2 BORDI FERMACASSA
DIM. mm 1440x30x304 H
COLORE: BLU RAL 5012

PREZZO TOTALE € 287,50

WORK LOOK

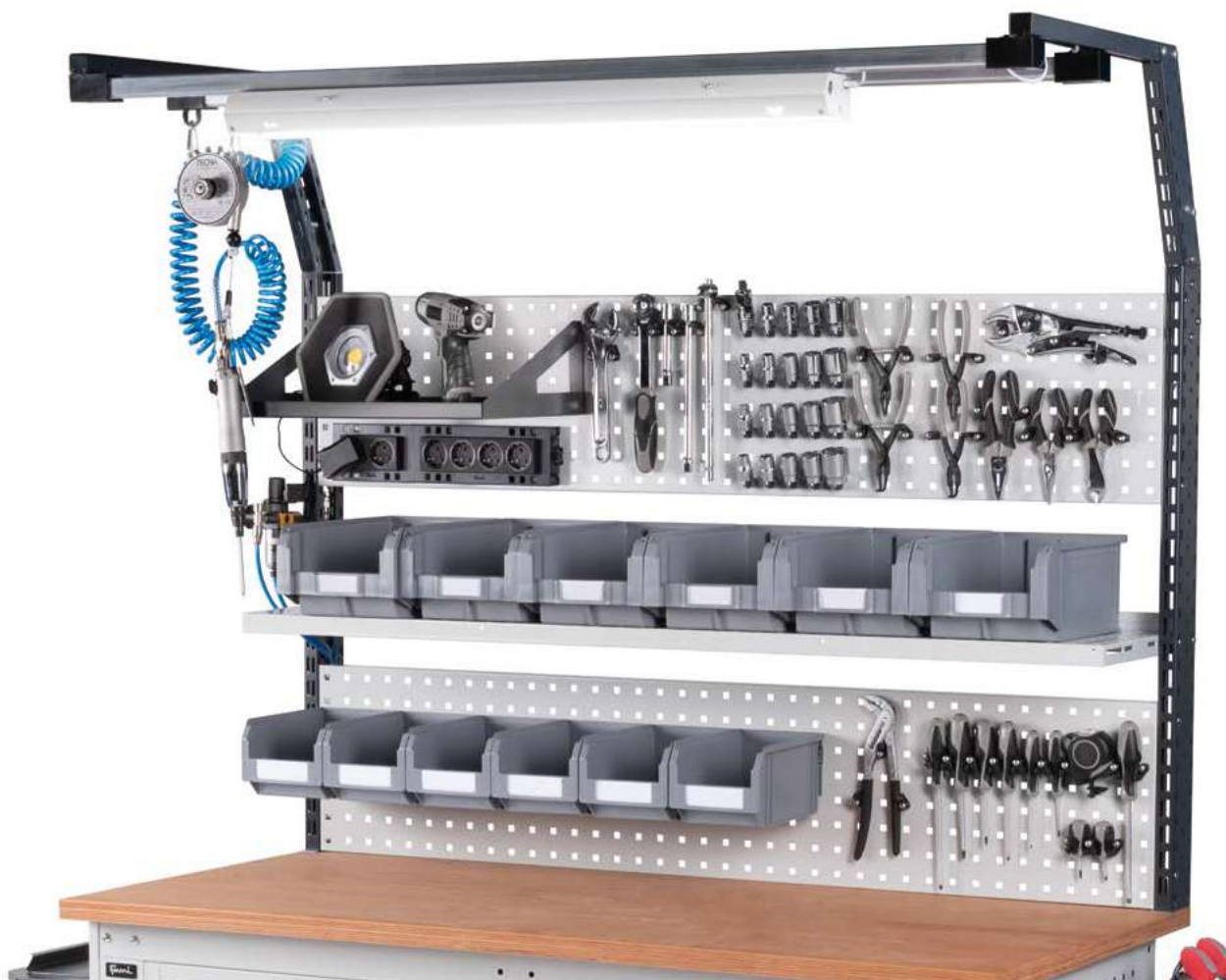

montanti

<p>938 mm - 3 UNITÀ</p>	<p>KIT 2 MONTANTI per banchi 1000-1500</p>	<p>KIT 3 MONTANTI per banchi 2000-3000</p>	<p>KIT 2 MONTANTI per banchi 1000-1500</p>	<p>KIT 3 MONTANTI per banchi 2000-3000</p>
	<p>IDEAONE05132 ANTRACITE RAL 7016 Dim. mm: 938 H € 50,00</p>	<p>IDEAONE05136 ANTRACITE RAL 7016 Dim. mm: 938 H € 75,00</p>	<p>IDEAONE05131 ANTRACITE RAL 7016 Dim. mm: 634 H € 43,00</p>	<p>IDEAONE05135 ANTRACITE RAL 7016 Dim. mm: 634 H € 64,50</p>
	<p>IDEAONE05134 BLU RAL 5012 Dim. mm: 938 H € 45,00</p>	<p>IDEAONE05138 BLU RAL 5012 Dim. mm: 938 H € 67,50</p>	<p>IDEAONE05133 BLU RAL 5012 Dim. mm: 634 H € 38,00</p>	<p>IDEAONE05137 BLU RAL 5012 Dim. mm: 634 H € 57,00</p>
			<p>634 mm - 2 UNITÀ</p>	

938 mm

634 mm

supporti con binario in alluminio

PRODOTTI IN VENDITA DA
DICEMBRE 2020

1000



IDEAONE05147 € 68,00

ANTRACITE RAL 7016
Dim. mm: 1000x685x307 H

IDEAONE05152 € 63,00

BLU RAL 5012
Dim. mm: 1000x685x307 H

1500



IDEAONE05148 € 74,00

ANTRACITE RAL 7016
Dim. mm: 1500x685x307 H

IDEAONE05153 € 69,00

BLU RAL 5012
Dim. mm: 1500x685x307 H

2000



IDEAONE05149 € 115,00

ANTRACITE RAL 7016
Dim. mm: 2000x685x307 H

IDEAONE05154 € 105,00

BLU RAL 5012
Dim. mm: 2000x685x307 H

3000



IDEAONE05150 € 136,00

ANTRACITE RAL 7016
Dim. mm: 3000x685x307 H

IDEAONE05155 € 126,00

BLU RAL 5012
Dim. mm: 3000x685x307 H

BINARIO



IDEAONE05185 € 20,00

ALLUMINIO
Dim. mm: 1000 mm

IDEAONE05186 € 23,00

ALLUMINIO
Dim. mm: 1500 mm

SET PER ARIA COMPRESSA

CON BILANCIATORE E FILTRO

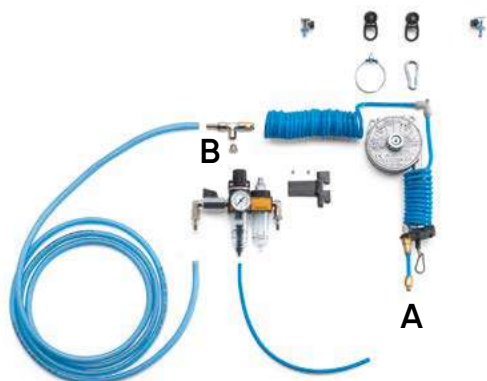

IDEAONE05187 € 355,00

Il set é completo di:

- 1 cavo flessibile Ø 10 mm - 1 connettore a T da 1/4" con tappo [B]
- 2 fermi - 2 attacchi di scorrimento - 1 moschettone
- 1 bilanciatore con cavo in acciaio lunghezza 1600 mm
- 1 attacco universale 1/4" per utensili [A]
- 1 tubo a spirale diametro interno 5,5 mm
- 1 tubo diametro interno 5,5 mm per lo spurgo del filtro
- 1 gruppo filtro regolatore con manometro - il quale può essere utilizzato con una pressione massima di 10 bar, la sua capacità é di circa 9 litri al secondo (sul punto A) é di 11 litri al secondo (sul punto B) con una pressione di utilizzo pari a 6,3 bar (la capacità può variare a seconda delle caratteristiche tecniche della rete pneumatica a cui l'impianto Fami viene allacciato) - Raccordi da 1/4"

WORK LOOK



PANNELLO/MENSOLA 955

PANNELLO FORATO FERITOIE 10x10 INTERASSE 38 mm



IDEAONE05193

GRIGIO RAL 7035
Dim. mm: 955x30x304 H



€ 26,00

IDEAONE05199

BLU RAL 5012
Dim. mm: 955x30x304 H



€ 26,00

KIT 2 MENSOLE/PANNELLI + 1 BORDO FERMACASSA



IDEAONE05139

GRIGIO RAL 7035
Dim. mm: 955x30x304 H



€ 60,00

IDEAONE05143

BLU RAL 5012
Dim. mm: 955x30x304 H



€ 60,00

KIT 3 MENSOLE/PANNELLI + 2 BORDI FERMACASSA



IDEAONE05141

GRIGIO RAL 7035
Dim. mm: 955x30x304 H



€ 90,00

IDEAONE05145

BLU RAL 5012
Dim. mm: 955x30x304 H



€ 90,00

KIT 1 MENSOLA/PANNELLO + 1 BORDO FERMACASSA



IDEAONE05191

GRIGIO RAL 7035
Dim. mm: 955x30x456 H



€ 41,50

IDEAONE05197

BLU RAL 5012
Dim. mm: 955x30x456 H



€ 41,50

PANNELLO PREDISPOSTO PER PRESE ELETTRICHE



IDEAONE05189

GRIGIO RAL 7035
Dim. mm: 955x30x152 H



€ 23,00

IDEAONE05195

BLU RAL 5012
Dim. mm: 955x30x152 H



€ 23,00

PANNELLO/MENSOLA 1440

PANNELLO FORATO FERITOIE 10x10 INTERASSE 38 mm



IDEAONE05194 € 32,50
GRIGIO RAL 7035
Dim. mm: 1440x30x304 H

IDEAONE05200 € 32,50
BLU RAL 5012
Dim. mm: 1440x30x304 H

KIT 2 MENSOLE/PANNELLI + 1 BORDO FERMACASSA



IDEAONE05140 € 70,50
GRIGIO RAL 7035
Dim. mm: 1440x30x304 H

IDEAONE05144 € 70,50
BLU RAL 5012
Dim. mm: 1440x30x304 H

KIT 3 MENSOLE/PANNELLI + 2 BORDI FERMACASSA



IDEAONE05142 € 110,00
GRIGIO RAL 7035
Dim. mm: 1440x304 H

IDEAONE05146 € 110,00
BLU RAL 5012
Dim. mm: 1440x304 H

KIT 1 MENSOLE/PANNELLO + 1 BORDO FERMACASSA



IDEAONE05192 € 55,00
GRIGIO RAL 7035
Dim. mm: 1440x30x456 H

IDEAONE05198 € 55,00
BLU RAL 5012
Dim. mm: 1440x30x456 H

PANNELLO PREDISPOSTO PER PRESE ELETTRICHE

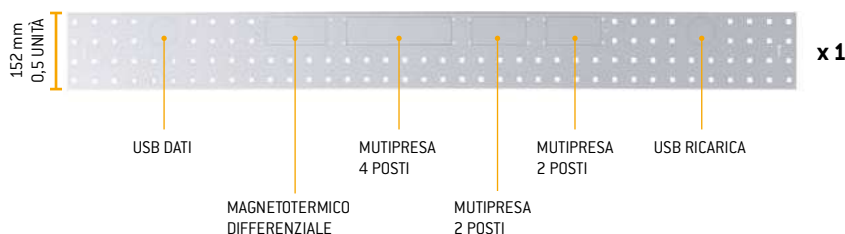

IDEAONE05190 € 31,50
GRIGIO RAL 7035
Dim. mm: 1440x30x152 H

IDEAONE05196 € 31,50
BLU RAL 5012
Dim. mm: 1440x30x152 H

WORK LOOK

FISSAGGIO A PARETE



IDEAONE05039

BLU RAL 5012
Foro Ø 4 mm
Escluso materiale di fissaggio
dim. mm: 1000×850 H

€ 55,00

IDEAONE05030

BLU RAL 5012
Foro Ø 4 mm
Escluso materiale di fissaggio
dim. mm: 1500×850 H

€ 68,00

IDEAONE05031

BLU RAL 5012
Foro Ø 4 mm
Escluso materiale di fissaggio
dim. mm: 2000×850 H

€ 88,00

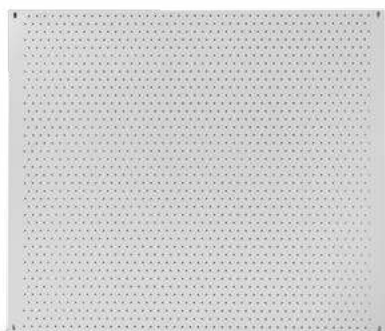

IDEAONE05079

GRIGIO RAL 7035
Foro Ø 4 mm
Escluso materiale di fissaggio
dim. mm: 1000×850 H

€ 55,00

IDEAONE05070

GRIGIO RAL 7035
Foro Ø 4 mm
Escluso materiale di fissaggio
dim. mm: 1500×850 H

€ 68,00

IDEAONE05071

GRIGIO RAL 7035
Foro Ø 4 mm
Escluso materiale di fissaggio
dim. mm: 2000×850 H

€ 88,00

MENSOLE

IDEAONE05038

BLU RAL 5012
Mensola per pannelli
dim. mm: 1000×140×146 H

€ 22,00

IDEAONE05033

BLU RAL 5012
Mensola per pannelli
dim. mm: 1500×140×146 H

€ 25,00

IDEAONE05032

BLU RAL 5012
Mensola per pannelli
dim. mm: 2000×140×146 H

€ 28,00



IDEAONE05078

GRIGIO RAL 7035
Mensola per pannelli
dim. mm: 1000×140×146 H

€ 22,00

IDEAONE05073

GRIGIO RAL 7035
Mensola per pannelli
dim. mm: 1500×140×146 H

€ 25,00

IDEAONE05072

GRIGIO RAL 7035
Mensola per pannelli
dim. mm: 2000×140×146 H

€ 28,00



GANCI



IDEAONE05034

Ø 17 mm,
confezione da 25 pezzi

€ 0,50
CADAUNO



IDEAONE05035

lung. 50 mm,
confezione da 25 pezzi

€ 0,40
CADAUNO



IDEAONE05036

lung. 100 mm,
confezione da 25 pezzi

€ 0,50
CADAUNO



IDEAONE05037

lung. 150 mm,
confezione da 25 pezzi

€ 0,60
CADAUNO



IDEAONE05287



€ 75,00

Lampada singola
L = 1000 mm



IDEAONE05289



€ 85,00

Lampada singola
L = 1500 mm



IDEAONE05288



€ 105,00

Lampada doppia
L = 1000 mm



IDEAONE05290



€ 115,00

Lampada doppia
L = 1500 mm



Kit di fissaggio fornito per ogni lampada compreso di staffe, calamite e viti per l'applicazione ai pannelli forati, pannelli in legno, binario aereo e muro.



ESEMPIO DI FISSAGGIO BINARIO AEREO



ESEMPIO DI FISSAGGIO A PANNELLO FORATO TRAMITE STAFFE



ESEMPIO DI FISSAGGIO CON CALAMITA



LAMPADE FORNITE SMONTATE

SEDIE



IDEAONE23002

€ 155,00

Sedile e schienale in poliuretano, ruote autobloccanti, regolabile con pompa a gas
Dim. mm H minima 495 - max. 670



IDEAONE23001

€ 115,00

Sedia in faggio, ruote autobloccanti, regolabile in altezza con pompa a gas
Dim. mm H minima 470 - max. 645



IDEAONE23003

€ 185,00

Sedile e schienale in poliuretano, piedini fonoassorbenti e poggiatesta regolabile cromato, regolabile con pompa a gas
Dim. mm H minima 535 - max. 785

MASTER



WWW.FAMISPA.COM

ASTA VERTEBRATA ANTIRIBALTAMENTO



CUORE & CERVELLO



✓ L'asta è in profilato d'alluminio e rimane sempre **fissa, senza ruotare**. Un oggetto fermo ha meno sollecitazioni e dà riferimenti **più precisi**.

✓ Il movimento di chiusura è ottenuto da tasselli che si spostano verticalmente sfruttando una delle forze elementari della fisica: **la gravità**. Più il movimento è semplice, meno probabilità di rotture ci sono.

✓ L'asta è forata a passo 25 mm e consente l'applicazione di **più teste di chiusura**. Questo permette di dividere l'accesso ai cassette in più gruppi. La divisione dei gruppi è configurabile in altezza. **Più un'idea è intelligente, più è facile usarla.**

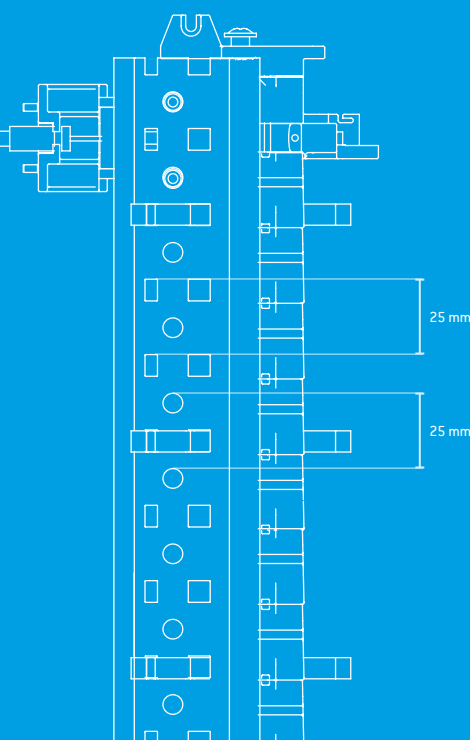

MANIGLIE PERSONALIZZABILI



UNA MINIERA DI INFORMAZIONI

Inserisci nella maniglia codici a barre, etichette o immagini per **conoscere** velocemente il **contenuto** di ogni singolo **cassetto**.

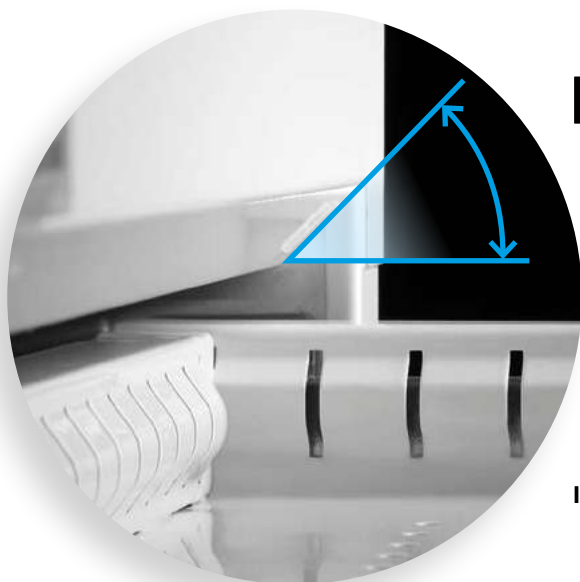

MAGGIOR CONO VISIVO



VISUALE COMPLETA

Estrazione e sagomatura dell'armadio ti consentono di **vedere completamente** l'interno dei **cassetti** più alti.

MAS

SISTEMA ANTIELUSIVO



SICUREZZA AL PRIMO POSTO

Al contrario di altri armadi presenti in commercio, il **sistema di chiusura brevettato** non consente allo scassinatore di eludere la chiusura. In caso di apertura forzata l'effrazione è sempre visibile.





ESTRAZIONE TOTALE



LIBERTÀ NELLA CONFIGURAZIONE

Modifica velocemente e facilmente l'**estrazione** del cassetto per **aumentare** la **portata** fino a **100 kg**.

GUIDE AD ALTE PRESTAZIONI



CORRERE SENZA PROBLEMI

Le guide lunghe come i cassetti permettono di spostare il **cuscinetto** nella parte **frontale** dell'armadio aumentando **visibilità, portata ed estrazione**.

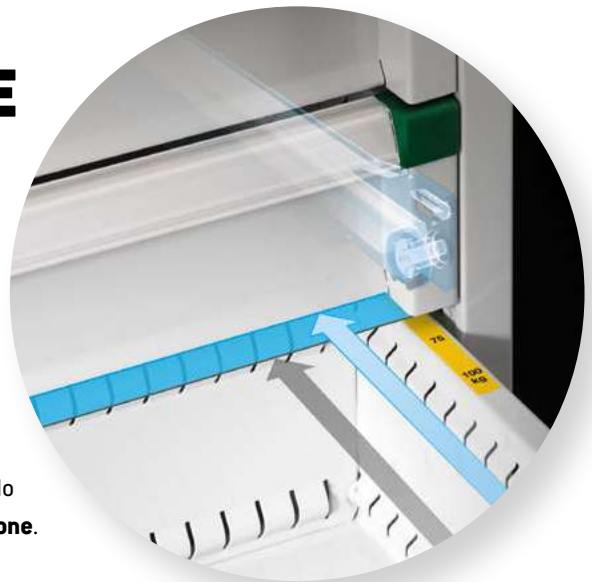

CASSETTI FORATI

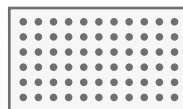

ORGANIZZAZIONE AL MILLIMETRO

Fori e scanalature sui cassetti facilitano la **suddivisione** interna del **cassetto** per una **perfetta organizzazione** di utensili e materiali.

TER

MASTER

36x36 EH

PRODOTTI IN VENDITA DA
DICEMBRE 2020



IDEAONE01038



€ 935,00

Completo di 9 cassetti (100)
Dimensioni: 714x726x1000 mm H
GRIGIO RAL 7035 + ANTRACITE RAL 7016



IDEAONE01040



€ 835,00

Completo di 7 cassetti 2 (75) - 1 (100) - 3 (150) - 1 (200)
Dimensioni: 714x726x1000 mm H
GRIGIO RAL 7035 + ANTRACITE RAL 7016

CASSETTI AD ESTRAZIONE TOTALE



IDEAONE01039



€ 860,00

Completo di 9 cassetti (100)
Dimensioni: 714x726x1000 mm H
BLU RAL 5012



IDEAONE01041



€ 760,00

Completo di 7 cassetti 2 (75) - 1 (100) - 3 (150) - 1 (200)
Dimensioni: 714x726x1000 mm H
BLU RAL 5012

MATERIALE DI SEPARAZIONE



IDEAONE01043



€ 46,00

PER ALTEZZA FRONTALE 75 mm

Composto da:

16 divisori 2 canali, 35 divisori trasversali 73 mm



IDEAONE01044



€ 48,00

PER ALTEZZA FRONTALE 75 mm

Composto da:

16 divisori 3 canali, 50 divisori trasversali 47 mm



IDEAONE01045



€ 55,00

PER ALTEZZA FRONTALE 75 mm

Composto da:

16 divisori 4 canali, 65 divisori trasversali 36 mm



IDEAONE01046



€ 52,00

PER ALTEZZA FRONTALE 75 mm

Composto da:

16 cassette divisorio 75x75 mm, 16 cassette divisorio 150x75 mm, 4 cassette divisorio 150x150 mm



IDEAONE01047



€ 46,00

PER ALTEZZA FRONTALE 75 mm

Composto da:

16 cassette divisorio 150x75 mm, 8 cassette divisorio 150x150 mm

IDEAONE01048



€ 50,00

PER ALTEZZA FRONTALE 100 mm

Composto da:

16 cassette divisorio 150x75 mm, 8 cassette divisorio 150x150 mm



IDEAONE01049



€ 12,00

PER ALTEZZA FRONTALE 75 mm

Composto da:

2 divisori longitudinali fessurati 610 mm, 3 divisori trasversali 200 mm

IDEAONE01050



€ 15,00

PER ALTEZZA FRONTALE 100 mm

Composto da:

2 divisori longitudinali fessurati 610 mm, 3 divisori trasversali 200 mm

IDEAONE01051



€ 19,00

PER ALTEZZA FRONTALE 150 mm

Composto da:

2 divisori longitudinali fessurati 610 mm, 3 divisori trasversali 200 mm

IDEAONE01052



€ 24,50

PER ALTEZZA FRONTALE 200 mm

Composto da:

2 divisori longitudinali fessurati 610 mm, 3 divisori trasversali 200 mm

PIANO SUPERIORE A 3 BORDI



IDEAONE01042



€ 68,00

PIANO SUPERIORE A 3 BORDI

Dim. mm 714x726x23 H

ARMADIO PORTA COMPUTER



IDEAONE03076 € 252,00

MODULO PORTA CON VETRO IN POLICARBONATO
Completo di viti per il fissaggio al modulo base
Possibilità di inserimento video fino a 24"
Dimensioni utili: 615x210x465 mm H
Dimensioni: 715x250x650 mm H
GRIGIO RAL 7035



IDEAONE03077 € 283,00

MODULO CON TAPPARELLA
Completo di viti per il fissaggio al modulo base
Possibilità di inserimento video fino a 24"
Dimensioni utili: 655x210x430 mm H
Dimensioni: 714x247x650 mm H
GRIGIO RAL 7035



IDEAONE03075 € 705,00

MODULO BASE

Completo di 1 piano regolabile sul fondo, cassetto con piano per tastiera, 1 ruota girevole senza freno, 1 ruota girevole con freno, 2 ruote fisse in nylon Ø 100 mm.
Dimensioni ingombro mm 791x598x1081 H.
Dimensioni utili mm 663x754 H. GRIGIO RAL 7035



ESEMPIO DI COMPOSIZIONE

ACCESSORI



IDEAONE03080 € 78,00

PIANO AD ESTRAZIONE FLESSIBILE

Dim. utili mm: 600x447
Altezza frontale 70 mm
GRIGIO RAL 7035

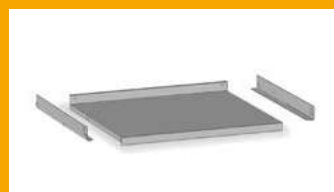

IDEAONE03081 € 42,00

PIANO REGOLABILE

Dim. utili mm: 657x478
Altezza totale 60 mm
GRIGIO RAL 7035

impianto elettrico



IDEAONE03065 € 65,00

PRESA MOBILE MULTIPLA 2P+T 16 A 250 V ~
- 4 prese universali potenza max 3680 W
CONFORMITÀ NORMATIVA
Norma CEI 23-124
Lunghezza cavo 2 m
Completa di supporto zincato

ventola



IDEAONE03066 € 33,00

Ventola 220V cablata senza griglia
con spina Schuko

ARMADIO PORTA COMPUTER



IDEAONE03073 GRIGIO RAL 7035



IDEAONE03074 BLU RAL 5012



Armadio per computer completo di:
 1 maniglia,
 1 piano regolabile sul fondo,
 1 piano porta tastiera,
 1 ventola di raffreddamento, serratura centrale,
 1 ruota girevole senza freno,
 1 ruota girevole con freno,
 2 ruote fisse in nylon Ø 100 mm

Dim. mm: 717×635×1690 H

SENZA IMPIANTO ELETTRICO

€ 605,00



COMPLETO DI RUOTE



IDEAONE03082

PIANO ESTRAIBILE
 Dim. ingombro mm: 650×585×25 H
 GRIGIO RAL 7000

€ 44,00



IDEAONE03046

PIANO REGOLABILE
 Dim. ingombro mm: 690×595×35 H
 GRIGIO RAL 7000

€ 30,00



IDEAONE03065

PRESA MOBILE MULTIPLA 2P+T 16 A 250 V ~
 - 4 prese universali potenza max 3680 W
 CONFORMITÀ NORMATIVA
 Norma CEI 23-124

€ 65,00

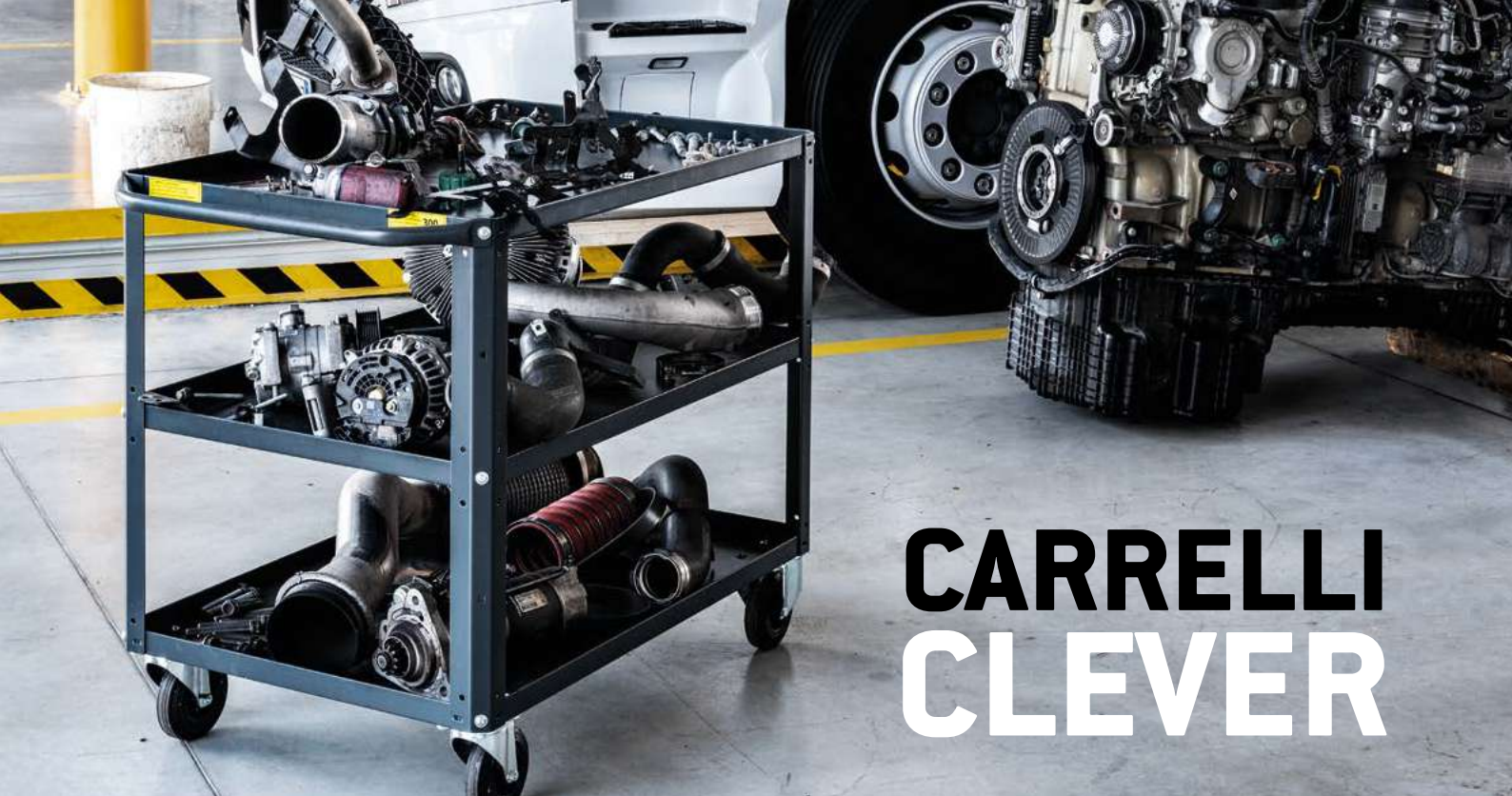

CARRELLI CLEVER

clever SMALL **clever LARGE**



PIANO
REGOLABILE
IN ALTEZZA

IDEAONE08015

Carrello a 3 piani con 2 ruote fisse, 1 ruota girevole senza freno, 1 ruota girevole con freno in gomma standard Ø 100 mm, fornito montato, portata: 200 kg - dim. mm: 904×515×820 H BLU RAL 5012

€ 134,00



IDEAONE08021

Carrello a 2 piani con 1 cassetto, 2 ruote fisse, 1 ruota girevole senza freno, 1 ruota girevole con freno in gomma standard Ø 125 mm, fornito montato, portata: 300 kg - dim. mm: 1024×615×847 H BLU RAL 5012

€ 229,00



IDEAONE08022

Carrello a 2 piani con 1 cassetto, 2 ruote fisse, 1 ruota girevole senza freno, 1 ruota girevole con freno in gomma standard Ø 125 mm, fornito montato, portata: 300 kg - dim. mm: 1024×615×847 H GRIGIO RAL 7035

€ 229,00



PIANO
REGOLABILE
IN ALTEZZA

IDEAONE08016

Carrello a 3 piani con 2 ruote fisse, 1 ruota girevole senza freno, 1 ruota girevole con freno in gomma standard Ø 100 mm, fornito montato, portata: 200 kg - dim. mm: 904×515×820 H GRIGIO RAL 7035

€ 134,00



IDEAONE08019

Carrello a 3 piani con 2 ruote fisse, 1 ruota girevole senza freno, 1 ruota girevole con freno in gomma standard Ø 125 mm, fornito montato, portata: 300 kg - dim. mm: 1024×615×847 H BLU RAL 5012

€ 150,50



IDEAONE08020

Carrello a 3 piani con 2 ruote fisse, 1 ruota girevole senza freno, 1 ruota girevole con freno in gomma standard Ø 125 mm, fornito montato, portata: 300 kg - dim. mm: 1024×615×847 H GRIGIO RAL 7035

€ 150,50

porta bombolette



PER **CLEVER SMALL**

- IDEAONE08027** BLU RAL 5012 € 16,00
 - IDEAONE08028** GRIGIO RAL 7035
- Porta bombolette - dim. mm: L=475 P=75 A=167

PER **CLEVER LARGE**

- IDEAONE08033** BLU RAL 5012 € 17,00
 - IDEAONE08034** GRIGIO RAL 7035
- Porta bombolette - dim. mm: L=575 P=75 A=167

pannello forato

PER **CLEVER SMALL**

- IDEAONE08023** BLU RAL 5012 € 25,00
 - IDEAONE08024** GRIGIO RAL 7035
- Pannello forato - dim. mm: L=475 P=18 A=655



PER **CLEVER LARGE**

- IDEAONE08029** BLU RAL 5012 € 25,00
 - IDEAONE08030** GRIGIO RAL 7035
- Pannello forato - dim. mm: L=575 P=18 A=655

calamite



IDEAONE05108

Calamite Ø 20 mm
confezione da 10 pz. - colore: zincato

€ 41,00 PER CONFEZIONE

pannello porta Visual Box

PER **CLEVER LARGE**

- IDEAONE08031** € 20,00
- Pannello porta Visual Box
GRIGIO SCURO RAL 7000
dim. mm: L=600 P=28 A=650 **esclusi Visual Box**



CADAUNO

IDEAONE05092 € 1,48

Gancio curvo - dim. mm: P=28 - Ø 5 mm
confezione da 10 pz. - colore: zincato

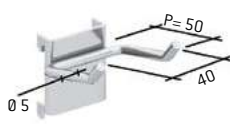

CADAUNO

IDEAONE05093 € 1,48

Gancio per angolo - dim. mm: P= 50 - Ø 5 mm
confezione da 10 pz. - colore: zincato



CADAUNO

IDEAONE05094 € 1,35

Porta cacciaviti - Ø 18 mm
confezione da 10 pz. - colore: zincato

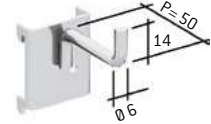

CADAUNO

IDEAONE05095 € 1,30

Gancio semplice - dim. mm: P= 50 - Ø 6 mm
confezione da 10 pz. - colore: zincato

Ganci e Calamite per articoli:

08023, 08024, 08027, 08028, 08029, 08030, 08033, 08034

CARRELLI COMBI



IDEAONE08005 BLU RAL 5012 € 133,00

Carrello a 1 piano con 2 ruote fisse, 1 ruota girevole senza freno, 1 ruota girevole con freno in gomma standard Ø 125 mm, portata 250 kg - dim. mm: 1135x700x915 H



IDEAONE08012 GRIGIO RAL 7035 € 133,00

Carrello a 1 piano con 2 ruote fisse, 1 ruota girevole senza freno, 1 ruota girevole con freno in gomma standard Ø 125 mm, portata 250 kg - dim. mm: 1135x700x915 H



PORTATA
500 Kg

IDEAONE08043 BLU RAL 5012 € 253,00

Carrello a 2 piani con 2 ruote fisse, 1 ruota girevole senza freno, 1 ruota girevole con freno in gomma standard Ø 200 mm, PORTATA 500 kg - dim. mm: 1095x700x1000 H



IDEAONE08035 BLU RAL 5012 € 104,00

Carrello a 2 piani con 4 ruote girevoli senza freno in gomma standard Ø 100 mm, portata 150 kg dim. mm: 555x445x845 H



IDEAONE08036 GRIGIO RAL 7035 € 104,00

Carrello a 2 piani con 4 ruote girevoli senza freno in gomma standard Ø 100 mm, portata 150 kg dim. mm: 555x445x845 H

ECOLOGIA

Contenitori ecologici conformi alle leggi vigenti relative alla tutela ambientale, quali messa in sicurezza in situazioni di rischio e salvaguardia del suolo, sottosuolo e falde acquifere. La modellatura del fondo risulta studiata per permettere la movimentazione mediante carrello elevatore o transpallet. Si raccomanda di posizionare questi contenitori su superfici piane e protette in caso di situazioni atmosferiche che possano alterarne il regolare esercizio. VASCHE D.LGS. 152/2006 TESTO UNICO AMBIENTALE.



vasca DI SICUREZZA

IDEAONE17005

€ 645,00

Vasca di sicurezza in lamiera con griglia per contenitore da 1000 lt. Numero cisterne: 1. Senza supporto rialzato. colore blu RAL 5012 + zincato - dim. mm: 1350x1500x630 H CISTERNA ESCLUSA

VASCHE IN PLASTICA

Studiate per lo stoccaggio e travaso di fusti e cisterne, queste vasche risultano idonee al contatto con fluidi compatibili con il polietilene, quali acidi, soluzioni alcaline, oli, sostanze chimiche non infiammabili. La griglia asportabile è realizzata in polipropilene mentre la struttura è in polietilene ecologico lineare di colore giallo, studiata con un assetto monolitico e senza giunzioni. Le materie prime impiegate per la produzione delle vasche sono riciclabili al 100% per minimizzare l'impatto ambientale in caso di smaltimento.



porta FUSTI

porta CISTERNE



IDEAONE21005

€ 113,00

Supporto in polietilene per rialzo 1 fusto da 200 l, colore giallo - dim. mm: 465x610x410 H



IDEAONE21006

€ 273,00

Supporto in polietilene per rialzo 2 fusti da 200 l, colore giallo - dim. mm: 1200x780x255 H



IDEAONE21004

€ 937,00

Vasca di sicurezza in polietilene con griglia per contenitore da 1000 l, volume di contenimento: 1050 l, colore giallo - dim. mm: 1350x1350x950 H



IDEAONE21003

€ 654,00

Vasca di raccolta in polietilene con griglia per 4 fusti da 200 l, volume di contenimento 500 l, colore giallo - dim. mm: 1350x1350x460 H



IDEAONE21001

€ 257,50

Vasca di raccolta in polietilene con griglia per 1 fusto da 200 l, volume di contenimento 225 l, colore giallo - dim. mm: 925x800x420 H



IDEAONE21002

€ 479,00

Vasca di raccolta in polietilene con griglia per 2 fusti da 200 l, volume di contenimento 305 l, colore giallo - dim. mm: 1350x800x420 H

IDEAONE17001**€ 232,00**

Vasca di raccolta senza pareti
 Numero fusti: 1, capacità di contenimento 200 l
 colore blu RAL 5012 + zincato - dim. mm: 960x960x332 H

IDEAONE17002**€ 275,00**

Vasca di raccolta senza pareti
 Numero fusti: 2, capacità di contenimento 250 l
 colore blu RAL 5012 + zincato - dim. mm: 1355x875x332 H

IDEAONE17003**€ 345,00**

Vasca di raccolta senza pareti
 Numero fusti: 4 capacità di contenimento 300 l
 colore blu RAL 5012 + zincato - dim. mm: 1355x1255x290 H

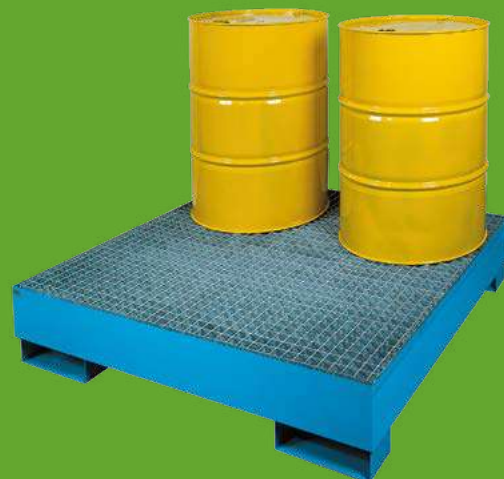
**porta FUSTI****IDEAONE17011****€ 104,00**

Capacità fusti litri 1x200, non impilabile, per vasca
 IDEAONE17002 (2 fusti) - dim. mm: 876x604x386 H
 colore blu RAL 5012

**IDEAONE17022****€ 169,00**

Capacità fusti litri 2x200, impilabile, per vasca
 IDEAONE17003 (4 fusti) - dim. mm: 1366x604x756 H
 dim. ingombro mm 1410x646x756 H
 colore blu RAL 5012

ART. ECO1301**€ 693,00**

Composto da:

- 1 art. IDEAONE17003 vasca di raccolta
- 1 art. IDEAONE17022 porta fusti litri 2x200
- 1 art. IDEAONE17023 porta fusti litri 3x60

**IDEAONE17012****€ 118,00**

Capacità fusti litri 2x200, non impilabile, per vasca
 IDEAONE17003 (4 fusti) - dim. mm: 1366x604x386 H
 colore blu RAL 5012

**IDEAONE17023****€ 179,00**

Capacità fusti litri 3x60, impilabile, per vasca
 IDEAONE17003 (4 fusti) - dim. mm: 1366x604x756 H
 dim. ingombro mm 1420x670x760 H
 colore blu RAL 5012

Benne porta trucioli COMPLETAMENTE RIBALTABILI**IDEAONE14001****€ 490,00**

Benna completamente ribaltabile con 2 ruote fisse,
 2 ruote girevoli con freno in nylon Ø 125 mm,
 portata 600 kg, **capacità 285 l**
 - colore blu RAL 5012 - dim. mm: 820x1370x870 H
 PREDISPOSTA PER RUBINETTO E GRIGLIA

**IDEAONE14002****€ 630,00**

Benna completamente ribaltabile con 2 ruote fisse,
 2 ruote girevoli con freno in nylon Ø 160 mm,
 portata 1000 kg, **capacità 490 l**
 - colore blu RAL 5012 - dim. mm: 920x1370x900 H
 PREDISPOSTA PER RUBINETTO E GRIGLIA

**IDEAONE14003****€ 550,00**

Benna completamente ribaltabile con 2 ruote fisse,
 2 ruote girevoli con freno in nylon Ø 125 mm,
 portata 800 kg, **capacità 420 l**
 - colore blu RAL 5012 - dim. mm: 820x1370x855 H
 PREDISPOSTA PER RUBINETTO E GRIGLIA

IDEAONE14007**€ 100,00**

Kit rubinetto + griglia per art. IDEAONE14 001 - 14 003

**IDEAONE14008****€ 100,00**

Kit rubinetto + griglia per art. IDEAONE14 002



ARMADI PER FITOSANITARI



IDEAONE03070

€ 317,00

Armadio di sicurezza per fitosanitari conforme al DPR 290/01
con 2 piani forati zincati regolabili e 1 vasca di raccolta zincata estraibile,
colore verde RAL 6011
dim. mm: 528×555×1008 H

IDEAONE03069

€ 422,00

Armadio di sicurezza per fitosanitari conforme al DPR 290/01
con 4 piani forati zincati regolabili e 1 vasca di raccolta zincata estraibile,
colore verde RAL 6011
dim. mm: 528×555×2008 H

IDEAONE03022

€ 369,00

Armadio di sicurezza per fitosanitari conforme al DPR 290/01,
con 2 piani forati zincati regolabili e 1 vasca di raccolta zincata estraibile,
colore verde RAL 6011
dim. mm: 1039×555×1008 H

IDEAONE03023

€ 469,00

Armadio di sicurezza per fitosanitari conforme al DPR 290/01,
con 4 piani forati zincati regolabili e 1 vasca di raccolta zincata estraibile,
colore verde RAL 6011
dim. mm: 1039×555×2008 H

VERNICI E SOLVENTI



IDEAONE03068

€ 317,00

Armadio di sicurezza per vernici e solventi conforme al D. LGS 81/2008 **testo unico sicurezza sul lavoro**, con 2 piani forati zincati regolabili e 1 vasca di raccolta zincata estraibile, colore giallo RAL 1004 dim. mm: 528x555x1008 H

IDEAONE03067

€ 422,00

Armadio di sicurezza per vernici e solventi conforme al D. LGS 81/2008 **testo unico sicurezza sul lavoro**, con 4 piani forati zincati regolabili e 1 vasca di raccolta zincata estraibile, colore giallo RAL 1004 dim. mm: 528x555x2008 H



IDEAONE03021

€ 369,00

Armadio di sicurezza per vernici e solventi conforme al D. LGS 81/2008 **testo unico sicurezza sul lavoro**, con 2 piani forati zincati regolabili e 1 vasca di raccolta zincata estraibile, colore giallo RAL 1004 dim. mm: 1039x555x1008 H

IDEAONE03020

€ 469,00

Armadio di sicurezza per vernici e solventi conforme al D. LGS 81/2008 **testo unico sicurezza sul lavoro**, con 4 piani forati zincati regolabili e 1 vasca di raccolta zincata estraibile, colore giallo RAL 1004 dim. mm: 1039x555x2008 H



RIPIANI
ZINCATI

VASCA DI
RACCOLTA

ARMADI SICUREZZA DPI



PORTE
SAFE CRASH

RIPIANI
ZINCATI



IDEAONE03024

ARMADIO DI SICUREZZA DPI E ATTREZZATURE ANTICENDIO
CONFORME AL D. LSG 81/2008 TESTO UNICO SICUREZZA
SUL LAVORO con 4 piani regolabili e porte in safe crash
ROSSO RAL 3020
dim. mm: 1023×555×2000 H

€ 519,00

SISTEMI PORTA UTENSILI NC

CARRELLO E TELAIO senza boccole



IDEAONE16028

Carrello con 3 telai porta boccole (escluse boccole)
con supporti, 1 ruota girevole senza freno, 1 ruota
girevole con freno, 2 ruote fisse in nylon Ø 125 mm,
portata 500 kg - colore grigio RAL 7035 + grigio RAL
7000 - dim. mm: 1064×512×890 H

€ 335,00



IDEAONE16004

Carrello con 3 telai porta boccole (escluse boccole)
con supporti, 1 ruota girevole senza freno, 1 ruota
girevole con freno, 2 ruote fisse in nylon Ø 125 mm,
portata 500 kg - colore blu RAL 5012 + grigio RAL 7000 -
dim. mm: 1064×512×890 H

€ 335,00



IDEAONE16027

Telaio da banco saldato (escluse
boccole) dim. mm: 565×450×350 H
colore grigio RAL 7035

€ 67,00



IDEAONE16001

Telaio da banco saldato (escluse
boccole) dim. mm: 565×450×350 H
colore blu RAL 5012

€ 67,00

SISTEMI PORTA UTENSILI NC



IDEAONE16029

€ 325,00

Armadio porta utensili vuoto
dim. mm: 1023x555x2000 H
BLU RAL 5012



IDEAONE16030

€ 325,00

Armadio porta utensili vuoto
dim. mm: 1023x555x2000 H
GRIGIO RAL 7035



per pack

IDEAONE16031

€ 120,00

Confezione di 2 telai inclinabili porta boccole a 3 file
dim. mm: 965x495x69 H
GRIGIO RAL 7000

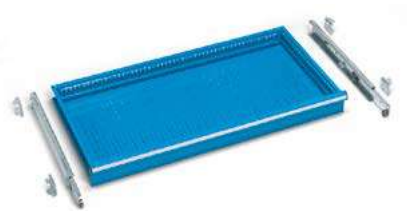

IDEAONE03083

€ 65,00

Cassetto ad estrazione telescopica 54x27 EH.
Portata 100 kg. Dim. utili mm: 906x447x85 H
BLU RAL 5012



IDEAONE03084

€ 65,00

Cassetto ad estrazione telescopica 54x27 EH.
Portata 100 kg. Dim. utili mm: 906x447x85 H
GRIGIO RAL 7035

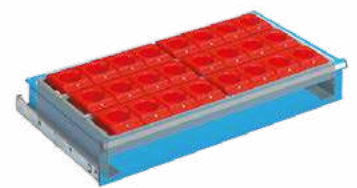

per pack

IDEAONE16032

€ 80,00

Confezione di 2 telai porta boccole a 3 file PER CASSETTI
comprensivi di supporti - dim. mm: 890x444x69 H
GRIGIO RAL 7000 - BOCCOLE ESCLUSE



IDEAONE16035

€ 2,25

Boccola ISO 40. Confezione 7 pz.
dim. mm: 65x138x63 H

CADAUNO



IDEAONE16036

€ 2,60

Boccola ISO 50. Confezione 5 pz.
dim. mm: 101x138x63 H

CADAUNO

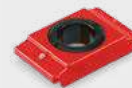

IDEAONE16034

€ 3,15

Boccola HSK A63-B80. Confezione 5 pz.
dim. mm: 82x138x30 H

CADAUNO

BOCCOLE

ART.	TIPO BOCCOLA	PER CARRELLO	PER CARRELLO	PER ARMADIO	PER ARMADIO	TELAIO DA BANCO
IDEAONE16035	ISO 40	7	21	42	35	21
IDEAONE16036	ISO 50	5	15	25	20	15
IDEAONE16034	HSK A63-B80	5	15	30	30	15

ARMADI PORTE A BATTENTE



IDEAONE03008 BLU RAL 5012

Armadio con 4 piani profondità 500 mm (100 kg), portata 800 kg, dim. mm: 1023×555×2000 H

€ 365,00



IDEAONE03009 GRIGIO RAL 7035

Armadio con 4 piani profondità 500 mm (100 kg), portata 800 kg, dim. mm: 1023×555×2000 H

€ 365,00



IDEAONE03042 BLU RAL 5012

Armadio con 2 piani profondità 500 mm (100 kg), portata 600 kg, dim. mm: 1023×555×1000 H

€ 304,00



IDEAONE03055 GRIGIO RAL 7035

Armadio con 2 piani profondità 500 mm (100 kg), portata 600 kg, dim. mm: 1023×555×1000 H

€ 304,00

PORTATA PIANI: 100 kg - PORTATA CASSETTI: 50 kg - PROFONDITÀ ARMADIO: 555 mm

cassetti

NEGLI ARMADI SI POSSONO INSERIRE AL MASSIMO 8 CASSETTI PER UNA PORTATA COMPRENSIVA DI 350 kg. SE NEGLI ARMADI VENGONO INSERITI CASSETTI AD UN'ALTEZZA MAGGIORE DI 1000 MM DA TERRA È OBBLIGATORIO SCEGLIERE ESCLUSIVAMENTE IL FISSAGGIO A PARETE.



IDEAONE03057

Cassetto per armadi, portata 50 kg, colore blu RAL 5012 - dim. utili mm: 906×447×85 H

€ 49,00



IDEAONE03059

Cassetto per armadi, portata 50 kg, colore grigio RAL 7035 - dim. utili mm: 906×447×85 H

€ 49,00

ARMADI PORTE SCORREVOLI

IDEAONE07003

€ 340,00

Armadio con 4 piani portata 70 kg, fornito smontato colore grigio RAL 7035 - Piani con predisposizione per alloggiamento cartelle sospese - dim. mm: 1200x450x2000 H

IDEAONE07004

€ 430,00

Armadio con 4+4 piani portata 60+60 kg, fornito smontato colore grigio RAL 7035 - Piani con predisposizione per alloggiamento cartelle sospese - dim. mm: 1500x450x2000 H

IDEAONE07005

€ 460,00

Armadio con 4+4 piani portata 70+70 kg, fornito smontato colore grigio RAL 7035 - Piani con predisposizione per alloggiamento cartelle sospese - dim. mm: 1800x450x2000 H

IDEAONE07011

€ 533,00

Armadio con 4+4 piani portata 60+60 kg, fornito smontato colore grigio RAL 7035 - Piani con predisposizione per alloggiamento cartelle sospese - dim. mm: 2000x450x2000 H



IDEAONE07012

€ 235,00

Armadio con 1 piano portata 70 kg, fornito smontato colore grigio RAL 7035 - Piani con predisposizione per alloggiamento cartelle sospese (utilizzabile come sopralzo) - dim. mm: 1200x450x900 H

IDEAONE07013

€ 257,00

Armadio con 1+1 piani portata 60+60 kg, fornito smontato colore grigio RAL 7035 - Piani con predisposizione per alloggiamento cartelle sospese (utilizzabile come sopralzo) - dim. mm: 1500x450x900 H

IDEAONE07014

€ 290,00

Armadio con 1+1 piani portata 70+70 kg, fornito smontato colore grigio RAL 7035 - Piani con predisposizione per alloggiamento cartelle sospese (utilizzabile come sopralzo) - dim. mm: 1800x450x900 H

IDEAONE07015

€ 385,00

Armadio con 1+1 piani portata 60+60 kg, fornito smontato colore grigio RAL 7035 - Piani con predisposizione per alloggiamento cartelle sospese (utilizzabile come sopralzo) - dim. mm: 2000x450x900 H



IDEAONE03040 BLU RAL 5012

Armadio con 2 piani profondità 500 mm (100 kg), portata 250 kg - dim. mm: 512x555x1000 H

€ 210,00



IDEAONE03054 GRIGIO RAL 7035

Armadio con 2 piani profondità 500 mm (100 kg), portata 250 kg - dim. mm: 512x555x1000 H

€ 210,00

PORTATA PIANI: 100 kg - PORTATA CASSETTI: 50 kg - PROFONDITÀ ARMADIO: 555 mm

cassetti

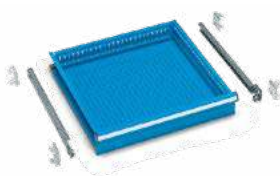

IDEAONE03056

Cassetto per armadi, portata 50 kg, colore blu RAL 5012 - dim. utili mm: 396x447x85 H

€ 41,00



IDEAONE03058

Cassetto per armadi, portata 50 kg, colore grigio RAL 7035 - dim. utili mm: 396x447x85 H

€ 41,00



STANDARD

ESTRAZIONE SEMPLICE: 100 kg

ESTRAZIONE TOTALE

TELESCOPICA: 200 kg



IDEAONE01011 BLU RAL 5012

Armadio con 7 cassetti ad estrazione semplice, portata cassetto 80/100 kg, serratura centrale, dim. mm: 717×726×1000 H

€ 639,00



IDEAONE01028 GRIGIO RAL 7035

Armadio con 7 cassetti ad estrazione semplice, portata cassetto 80/100 kg, serratura centrale, dim. mm: 717×726×1000 H

€ 639,00



×6

IDEAONE01016

Per art. IDEAONE01011 / 01028, set di suddivisione per 6 cassetti composto da: 2 divisori fessurati longitudinali per ogni cassetto e 3 divisori trasversali per ogni cassetto

€ 75,00

36x36 EH



IDEAONE01009 BLU RAL 5012

Armadio con 9 cassetti ad estrazione semplice, portata cassetto 100 kg, serratura centrale dim. mm: 717×726×1000 H

€ 699,00



IDEAONE01033 GRIGIO RAL 7035

Armadio con 9 cassetti ad estrazione semplice, portata cassetto 100 kg, serratura centrale dim. mm: 717×726×1000 H

€ 699,00



×9

IDEAONE01014

Per art. IDEAONE01009 / 01033 / 01020 / 01032, set di suddivisione per 9 cassetti composto da: 2 divisori fessurati longitudinali per ogni cassetto e 3 divisori trasversali per ogni cassetto

€ 98,00



IDEAONE01020 BLU RAL 5012

Armadio con 9 cassetti ad estrazione totale telescopica, portata cassetto 200 kg, serratura centrale dim. mm: 717×726×1000 H

€ 878,00



IDEAONE01032 GRIGIO RAL 7035

Armadio con 9 cassetti ad estrazione totale telescopica, portata cassetto 200 kg, serratura centrale dim. mm: 717×726×1000 H

€ 878,00



×9

IDEAONE01014

Per art. IDEAONE01009 / 01033 / 01020 / 01032, set di suddivisione per 9 cassetti composto da: 2 divisori fessurati longitudinali per ogni cassetto e 3 divisori trasversali per ogni cassetto

€ 98,00

FLEXA

ESTRAZIONE TOTALE FINO A: 70 Kg



IDEAONE01017 BLU RAL 5012

Armadio con 7 cassetti ad estrazione totale, portata cassetto 50 kg, serratura centrale dim. mm: 1023×600×1000 H

€ 637,00



IDEAONE01034 GRIGIO RAL 7035

Armadio con 7 cassetti ad estrazione totale, portata cassetto 50 kg, serratura centrale dim. mm: 1023×600×1000 H

€ 637,00

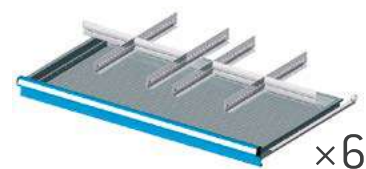

×6

IDEAONE01018

Per art. IDEAONE01017 / 01034

set di suddivisione per 6 cassetti composto da: 4 divisori fessurati longitudinali per ogni cassetto e 4 divisori trasversali per ogni cassetto

€ 169,00

54x27 EH



IDEAONE01035 BLU RAL 5012

Armadio con 9 cassetti ad estrazione totale, portata cassetto 50 kg, serratura centrale dim. mm: 1023×600×1000 H

€ 699,00



IDEAONE01036 GRIGIO RAL 7035

Armadio con 9 cassetti ad estrazione totale, portata cassetto 50 kg, serratura centrale dim. mm: 1023×600×1000 H

€ 699,00

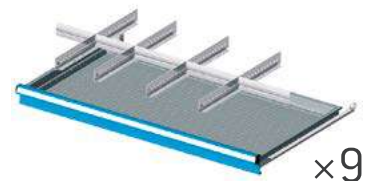

×9

IDEAONE01037

Per art. IDEAONE01035 / 01036

set di suddivisione per 9 cassetti composto da: 4 divisori fessurati longitudinali per ogni cassetto e 5 divisori trasversali per ogni cassetto

€ 194,00



75-T
75-T
100-T
150-T
150-T
150-T
200-T



IDEAONE01001 BLU RAL 5012

Armadio con 7 cassetti ad estrazione totale, portata cassetto 70 kg, serratura centrale dim. mm: 717x600x1000 H

€ 499,00

IDEAONE01031 GRIGIO RAL 7035

Armadio con 7 cassetti ad estrazione totale, portata cassetto 70 kg, serratura centrale dim. mm: 717x600x1000 H

€ 499,00



×6

IDEAONE01002

Per art. IDEAONE01031 / 01001 set di suddivisione per 6 cassetti composto da: 2 divisori fessurati longitudinali per ogni cassetto e 3 divisori trasversali per ogni cassetto

€ 75,00



100-T
100-T
100-T
100-T
100-T
100-T
100-T
100-T
100-T



IDEAONE01023 BLU RAL 5012

Armadio con 9 cassetti ad estrazione totale, portata cassetto 70 kg, serratura centrale dim. mm: 717x600x1000 H

€ 569,00

IDEAONE01030 GRIGIO RAL 7035

Armadio con 9 cassetti ad estrazione totale, portata cassetto 70 kg, serratura centrale dim. mm: 717x600x1000 H

€ 569,00



×9

IDEAONE01025

Per art. IDEAONE01030 / 01023 set di suddivisione per 9 cassetti composto da: 2 divisori fessurati longitudinali per ogni cassetto e 3 divisori trasversali per ogni cassetto

€ 114,00

27x27 EH



75-T
75-T
100-T
150-T
200-T

IDEAONE02015 BLU RAL 5012

Armadio con 5 cassetti ad estrazione totale, ruote in gomma standard Ø 100 mm, serratura centrale, portata armadio 160 kg - dim. mm: 641x600x852 H

€ 453,00



100-T
100-T
100-T
100-T
200-T

36x27 EH

IDEAONE02005 BLU RAL 5012

Armadio con 5 cassetti ad estrazione totale, ruote in gomma standard Ø 100 mm, serratura laterale, portata armadio 160 kg - dim. mm: 794x600x852 H

€ 479,00



75-T
75-T
100-T
150-T
200-T

IDEAONE02018 GRIGIO RAL 7035

Armadio con 5 cassetti ad estrazione totale, ruote in gomma standard Ø 100 mm, serratura centrale, portata armadio 160 kg - dim. mm: 641x600x852 H

€ 453,00



100-T
100-T
100-T
100-T
200-T

IDEAONE02017 GRIGIO RAL 7035

Armadio con 5 cassetti ad estrazione totale, ruote in gomma standard Ø 100 mm, serratura laterale, portata armadio 160 kg - dim. mm: 794x600x852 H

€ 479,00

Gli armadi spogliatoio possono presentare da 1 a 4 vani, disponibili in diverse larghezze: 30, 40 e 58,5 cm. In base alle diverse esigenze, il tetto può essere orizzontale o inclinato che, assieme al divisorio sporco pulito, consente di aumentare il grado di pulizia dell'armadio e dell'ambiente. Il vano interno dell'armadietto spogliatoio può essere ulteriormente suddiviso tramite un piano d'appoggio zincato fisso o regolabile in altezza.

ARMADI SPOGLIATOIO



VERNICIATURA IN ELETTROFORESI

panchine SPOGLIATOIO



IDEAONE04033

Panca spogliatoio singola
colore grigio RAL 7000 - dim. mm: 1000x360x385 H

€ 77,00



IDEAONE04032

Panca spogliatoio singola
colore grigio RAL 7000 - dim. mm: 1495x360x385 H

€ 94,00



IDEAONE04031

Panca spogliatoio singola
colore grigio RAL 7000 - dim. mm: 2000x360x385 H

€ 130,00



VANO
PORTA CASCO
DI SERIE

IDEAONE04043

€ 244,00

Armadio spogliatoio a 2 scomparti, divisorio sporco/pulito zincato, chiusura a cilindro e vano porta casco - colore grigio RAL 7035 - dim. mm: 805x500x1750 H



DIVISORIO
INTERNO
ZINCATO

IDEAONE04044

€ 322,00

Armadio spogliatoio a 3 scomparti, divisorio sporco/pulito zincato, chiusura a cilindro e vano porta casco - colore grigio RAL 7035 - dim. mm: 1195x500x1750 H

IDEAONE04038

€ 40,00

TETTO INCLINATO AGGIUNTIVO - dim. mm: 802x500x190 H - colore grigio RAL 7035

IDEAONE04040

€ 51,50

TETTO INCLINATO AGGIUNTIVO - dim. mm: 1192x500x190 - colore grigio RAL 7035

**tetto
inclinato**

su richiesta



**kit
piedini**

IDEAONE04048

€ 12,00

Dim. mm 135x500x200 H



IDEAONE04045

€ 202,00

Armadio spogliatoio a 2 scomparti, chiusura a cilindro e vano porta casco - colore grigio RAL 7035 - dim. mm: 610x500x1750 H



IDEAONE04046

€ 256,00

Armadio spogliatoio a 3 scomparti, chiusura a cilindro e vano porta casco - colore grigio RAL 7035 - dim. mm: 900x500x1750 H



IDEAONE04047

€ 308,00

Armadio spogliatoio a 4 scomparti, chiusura a cilindro e vano porta casco - colore grigio RAL 7035 - dim. mm: 1195x500x1750 H

IDEAONE04037

€ 39,00

TETTO INCLINATO AGGIUNTIVO
colore grigio RAL 7035 - dim. mm: 608x500x190 H

IDEAONE04039

€ 46,00

TETTO INCLINATO AGGIUNTIVO
colore grigio RAL 7035 - dim. mm: 900x500x190 H

IDEAONE04040

€ 51,50

TETTO INCLINATO AGGIUNTIVO
colore grigio RAL 7035 - dim. mm: 1192x500x190 H

SCAFFALATURA AD INCASTRO

SCAFFALATURA PORTA GOMME



ART. ST2001



€ 260,00

Dim. mm 2100x500x2000 h

Composto da:

3 art. IDEAONE15035 fiancata con 3 traversini

2 art. IDEAONE15037 kit piani profondità 500 mm



PRODOTTI IN VENDITA DA
DICEMBRE 2020

ART. ST2601



€ 210,00

Dim. mm 2700x400x2000 h

Composto da:

3 art. IDEAONE15034 fiancata con 3 traversini

2 art. IDEAONE15038 kit 3 coppie supporti porta pneumatici



x 5

IDEAONE15036

€ 74,50



KIT PIANI ZINCATI PROFONDITÀ 400 mm

PORTATA PIANO: 120 kg

dim. mm: 1000x400x35 H



x 5

IDEAONE15039

€ 14,00



KIT RINFORZO ZINCATO
AUMENTA LA PORTATA DEI PIANI FESSURATI

A 300 kg

LUNGHEZZA 1000 mm



x 6

IDEAONE15038

€ 54,00



KIT 3 COPPIE SUPPORTI PORTA PNEUMATICI
LUNGHEZZA 1300 mm

IDEAONE15037

€ 76,00



KIT PIANI ZINCATI PROFONDITÀ 500 mm

PORTATA PIANO: 120 kg

dim. mm: 1000x500x35 H

LA PARTICOLARE SAGOMATURA
DEL PROFILO DEL SUPPORTO,
RENDE PIU' SICURO L'APPOGGIO
DEL PNEUMATICO.

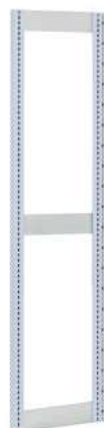

IDEAONE15034

€ 34,00



FIANCATA CON 3 TRAVERSINI
dim. mm: 400x2000 H

IDEAONE15035

€ 36,00



FIANCATA CON 3 TRAVERSINI
dim. mm: 500x2000 H





MIS. 3

CONFEZIONE DA 8 PEZZI

IDEAONE13003

€ 11,35

EACH

contenitore in acciaio, colore RAL 7000
dim. mm: 350/300×200×200 H

STEEL

I contenitori e le cassette in metallo FAMI rappresentano la soluzione ideale per lo stoccaggio e la movimentazione del materiale che richiede pronta reperibilità tanto nei magazzini quanto nei reparti di produzione e montaggio. Realizzati in lamiera lucida di acciaio laminato a freddo, sono rinforzati con apposite nervature alle pareti e sul fondo per aumentarne la resistenza al carico e l'indefornabilità all'urto.



EACH

IDEAONE13004

€ 14,50

contenitore in acciaio, colore RAL 7000
dim. mm: 500/450×300×200 H

MIS. 4

CONFEZIONE DA 6 PEZZI



EACH

IDEAONE13005

€ 32,00

contenitore in acciaio, colore RAL 7000
dim. mm: 700/630×450×300 H

MIS. 5

CONFEZIONE DA 6 PEZZI



EACH

IDEAONE13002

€ 16,40

cassetta in acciaio, colore RAL 7000
dim. mm: 300×200×200 H

MIS. 272-3

CONFEZIONE DA 8 PEZZI



EACH

IDEAONE13001

€ 16,00

cassetta in acciaio, colore RAL 7000
dim. mm: 450×300×200 H

MIS. 272-4

CONFEZIONE DA 6 PEZZI

Scaffali porta contenitori



IDEAONE19002

Scaffale vuoto per 16 contenitori mis. 3 in plastica o in acciaio, colore GRIGIO RAL 7000
dim. mm: 1025×310×885 H

€ 171,00



IDEAONE19001

Coperchio parapolvere per art. IDEAONE19002, colore GRIGIO RAL 7000
dim. mm 1020×315×20 H

€ 20,00



IDEAONE19003

Zoccolo di appoggio per art. IDEAONE19002, colore GRIGIO RAL 7000
dim. mm: 1020×315×85 H

€ 41,50



IDEAONE19005

Scaffale vuoto per 20 contenitori mis. 4 in plastica o in acciaio, colore GRIGIO RAL 7000
dim. mm: 1765×460×885 H

€ 231,00



IDEAONE19004

Coperchio parapolvere per art. IDEAONE19005, colore GRIGIO RAL 7000
dim. mm: 1765×465×20 H

€ 26,00



IDEAONE19006

Zoccolo di appoggio per art. IDEAONE19005, colore GRIGIO RAL 7000
dim. mm: 1765×465×85 H

€ 53,50

CARRELLI PORTA PICKING BOX

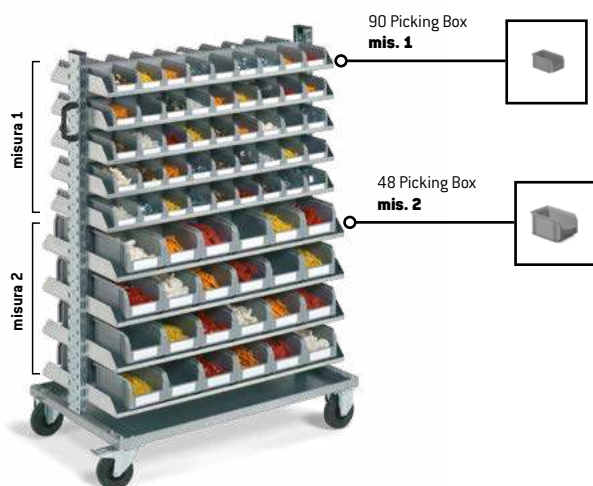

CARRELLO CON PICKING BOX

IDEAONE11007

€ 467,00

Completo di 18 mensole con 90 Picking Box **mis. 1**, 48 Picking Box **mis. 2**, ecogreen colore grigio - 1 ruota girevole con freno, 1 ruota girevole senza freno, 2 ruote fisse in gomma standard Ø 125 mm - portata carrello 300 kg (150 per lato) colore grigio RAL 7000 + zincato - dim. mm: 1023×613×1430 H

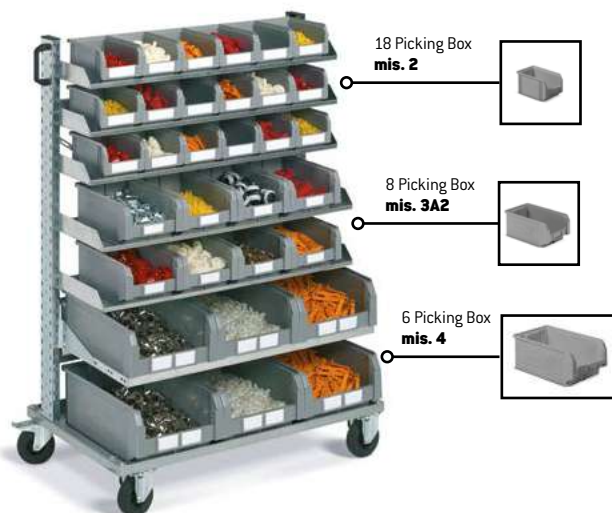

CARRELLO CON PICKING BOX

IDEAONE11273

€ 344,00

Completo di 6 mensole con 18 Picking Box **mis. 2**, 8 Picking Box **mis. 3A2**, 6 Picking Box **mis. 4**, ecogreen colore grigio - 1 ruota girevole con freno, 1 ruota girevole senza freno, 2 ruote fisse in gomma standard Ø 125 mm - portata carrello 300 kg (150 per lato) colore grigio RAL 7000 + zincato - dim. mm: 1023×613×1430 H

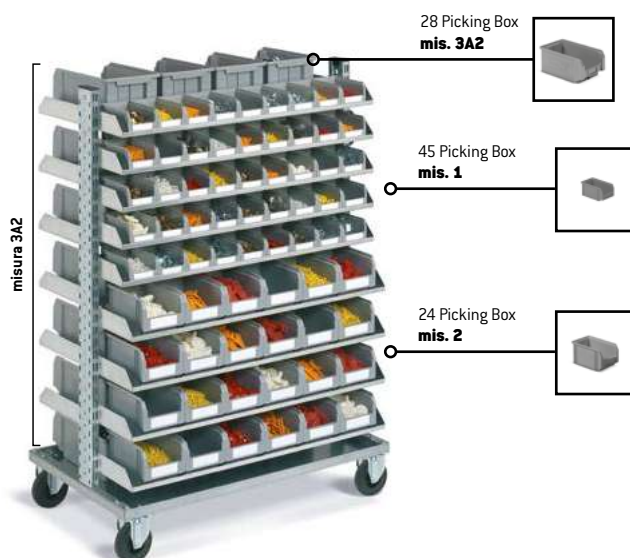

CARRELLO CON PICKING BOX

IDEAONE11275

€ 463,00

Completo di 15 mensole con 28 Picking Box **mis. 3A2**, 45 Picking Box **mis. 1**, 24 Picking Box **mis. 2**, ecogreen colore grigio - 1 ruota girevole con freno, 1 ruota girevole senza freno, 2 ruote fisse in gomma standard Ø 125 mm - portata carrello 300 kg (150 per lato) colore grigio RAL 7000 + zincato - dim. mm: 1023×613×1430 H



CARRELLO CON VISUAL BOX

IDEAONE11008 € 450,00

Carrello per cassettiere Visual Box con contenitori e fermi inclusi - colore zincato + grigio RAL 7000
- dim. mm: 725×613×1430 H
4 articoli **IDEAONE12001** - 6 articoli **IDEAONE12002**
4 articoli **IDEAONE12003** - 2 articoli **IDEAONE12004**
2 articoli **IDEAONE12005**



SCAFFALE DA PARETE PER CASSETTIERE VISUAL BOX

IDEAONE12007 € 29,00

Scaffale vuoto da parete per cassettiere Visual Box, realizzato in lamiera d'acciaio verniciata - colore grigio RAL 7000
dim. mm: 600×41×**1500 H**

IDEAONE12011 € 33,00

Scaffale vuoto da parete per cassettiere Visual Box, realizzato in lamiera d'acciaio verniciata - colore grigio RAL 7000
dim. mm: 600×41×**1950 H**



IDEAONE12014 € 30,00

Base per scaffale - colore grigio RAL 7000
dim. mm: 600×300×100 H

CASSETTIERE VISUAL BOX

PER MAGGIORI INFORMAZIONI VEDI PAG. 70



77 h

IDEAONE12001

dim. mm: 600×69×77 H
CONFEZIONE DA 2 PEZZI

€ 10,85

EACH



164 h

IDEAONE12003

dim. mm: 600×141×164 H

€ 21,10



240 h

IDEAONE12005

dim. mm: 600×209×240 H

€ 32,45



112 h

IDEAONE12002

dim. mm: 600×98×112 H
CONFEZIONE DA 2 PEZZI

€ 13,25

EACH



206 h

IDEAONE12004

dim. mm: 600×174×206 H

€ 27,60



353 h

IDEAONE12006

dim. mm: 600×311×353 H

€ 60,95

EURO BOX

POLIPROPILENE PRIMA SCELTA PP

IL POLIPROPILENE DI PRIMA SCELTA È UN MATERIALE PLASTICO ATOSSICO IMPIEGATO NELL'INDUSTRIA PER LA REALIZZAZIONE DEI PRODOTTI PIÙ DISPARATI IN QUANTO INODORE, RESISTENTE A SOLVENTI ED ACIDI, LAVABILE E STERILIZZABILE, RESISTENTE ALL'UMIDITÀ E NON IGROSCOPICO. LE PERFORMANCE CHIMICHE E MECCANICHE RENDONO IL POLIPROPILENE OTTIMALE PER LA PRODUZIONE DI CASSETTE E CONTENITORI, IDEALI PER LA MOVIMENTAZIONE E LO STOCCAGGIO DELLE MERCI.

EURO BOX 300x200



IDEAONE09066 PP

GRIGIO PRIMA SCELTA € 4,08

Dim. mm: 300x200x120 H - MIS. 3212



IDEAONE09067 PP

GRIGIO PRIMA SCELTA € 4,08

Dim. mm: 300x200x170 H - MIS. 3217

COPERCHIO



IDEAONE09068 PP

GRIGIO PRIMA SCELTA € 2,28

Dim. mm: 300x200 - coperchio a cerniera

EURO BOX 400x300



IDEAONE09061 PP

GRIGIO PRIMA SCELTA € 5,62

Dim. mm: 400x300x120 H - MIS. 4312



IDEAONE09062 PP

GRIGIO PRIMA SCELTA € 7,16

Dim. mm: 400x300x170 H - MIS. 4317



IDEAONE09063 PP

GRIGIO PRIMA SCELTA € 7,79

Dim. mm: 400x300x220 H - MIS. 4322



IDEAONE09064 PP

GRIGIO PRIMA SCELTA € 11,34

Dim. mm: 400x300x325 H - MIS. 4332

COPERCHIO



IDEAONE09065 PP

GRIGIO PRIMA SCELTA € 3,07

Dim. mm: 400x300 - coperchio a cerniera

EURO BOX 600x400



IDEAONE10062 PP
GRIGIO PRIMA SCELTA € 9,38

Dim. mm: 600x400x120 H - MIS. 6412



IDEAONE10063 PP
GRIGIO PRIMA SCELTA € 11,50

Dim. mm: 600x400x170 H - MIS. 6417



IDEAONE10064 PP
GRIGIO PRIMA SCELTA € 14,95

Dim. mm: 600x400x220 H - MIS. 6422



IDEAONE10068 PP
GRIGIO PRIMA SCELTA € 18,37

Dim. mm: 600x400x285 H - MIS. 6428



IDEAONE10065 PP
GRIGIO PRIMA SCELTA € 19,45

Dim. mm: 600x400x325 H - MIS. 6432



IDEAONE10067 PP
GRIGIO PRIMA SCELTA € 24,96

Dim. mm: 600x400x430 H - MIS. 6443

COPERCHIO



IDEAONE10066 PP
GRIGIO PRIMA SCELTA € 6,10

Dim. mm: 600x400 - coperchio a cerniera

EURO BOX 800x600



IDEAONE09069 PP
GRIGIO PRIMA SCELTA € 24,12

Dim. mm: 800x600x120 H - MIS. 8612



IDEAONE09070 PP
GRIGIO PRIMA SCELTA € 23,80

Dim. mm: 800x600x170 H - MIS. 8617



IDEAONE09071 PP
GRIGIO PRIMA SCELTA € 26,82

Dim. mm: 800x600x220 H - MIS. 8622



IDEAONE09072 PP
GRIGIO PRIMA SCELTA € 30,42

Dim. mm: 800x600x325 H - MIS. 8632



IDEAONE09073 PP
GRIGIO PRIMA SCELTA € 35,19

Dim. mm: 800x600x430 H - MIS. 8643



IDEAONE09074 PP
GRIGIO PRIMA SCELTA € 9,91

Dim. mm: 800x600 - coperchio con maniglie



IDEAONE09075
€ 29,00

Kit di 2 ruote fisse in gomma standard Ø 100 mm
2 ruote girevoli in gomma standard Ø 100 mm
1 set di 16 viti

KIT RUOTE



PLASTICA RICICLATA, ENERGIE PULITE. DAI MATERIALI ALLA PRODUZIONE, TUTTO IN QUESTA CASSETTA È AMICO DELL'AMBIENTE. UNA SOLUZIONE ECOLOGICA, PERCHÈ DONA NUOVA VITA ALLA PLASTICA. DISPONIBILE IN COLORE GRIGIO E IN DIVERSE DIMENSIONI.

ECOGREEN È VERSATILE, COMPATTA E RESISTENTE!

EURO BOX 400x300



Dim. mm: 400x300x120 H - MIS. 4312

IDEAONE09005



GRIGIO RIGENERATO

€ 4,61



Dim. mm: 400x300x170 H - MIS. 4317

IDEAONE09006



GRIGIO RIGENERATO

€ 5,94



Dim. mm: 400x300x220 H - MIS. 4322

IDEAONE09007



GRIGIO RIGENERATO

€ 6,63



Dim. mm: 400x300x325 H - MIS. 4332

IDEAONE09055



GRIGIO RIGENERATO

€ 9,10



Dim. mm: 400x300 - coperchio a cerniera

IDEAONE09009



GRIGIO RIGENERATO

€ 2,55

EURO BOX 600x400



Dim. mm: 600x400x120 H - MIS. 6412

IDEAONE10005



GRIGIO RIGENERATO

€ 7,95



Dim. mm: 600x400x170 H - MIS. 6417

IDEAONE10006



GRIGIO RIGENERATO

€ 9,40



Dim. mm: 600x400x220 H - MIS. 6422

IDEAONE10055



GRIGIO RIGENERATO

€ 11,93



Dim. mm: 600x400x325 H - MIS. 6432

IDEAONE10056



GRIGIO RIGENERATO

€ 15,53



Dim. mm: 600x400 - coperchio a cerniera

IDEAONE10009



GRIGIO RIGENERATO

€ 5,10

PICKING BOX

I contenitori in polipropilene serie Picking Box, sono la soluzione ideale ad ogni problema di stoccaggio, in magazzino, in officina, lungo le linee di montaggio. Consentono di avere sempre a portata di mano e ben in vista il contenuto, rendendolo prelevabile con estrema facilità. Questi contenitori sono impilabili in modo stabile e sicuro e la pronta disponibilità del materiale non viene meno anche quando sono sovrapposti.



Dim. mm 160/140x95x75 H
Capacità 1 lt
CONFEZIONE DA 50 PEZZI - MIS. 1



Dim. mm 230/200x140x130 H
Capacità 3.8 lt
CONFEZIONE DA 54 PEZZI - MIS. 2



Dim. mm: 350/300x200x145 H
Capacità 9.4 lt
CONFEZIONE DA 21 PEZZI - MIS. 3A2



Dim. mm: 350/300x200x200 H
Capacità 12.5 lt
CONFEZIONE DA 15 PEZZI - MIS. 3



Dim. mm: 500/450x300x200 H
Capacità 28 lt
CONFEZIONE DA 10 PEZZI - MIS. 4

IDEAONE11015 GRIGIO	IDEAONE11025 GRIGIO	IDEAONE11036 GRIGIO	IDEAONE11035 GRIGIO	IDEAONE11045 GRIGIO
RIGENERATO € 0,64	RIGENERATO € 1,33	RIGENERATO € 3,29	RIGENERATO € 3,82	RIGENERATO € 7,53
EACH	EACH	EACH	EACH	EACH
IDEAONE11247 GRIGIO	IDEAONE11252 GRIGIO	IDEAONE11257 GRIGIO	IDEAONE11262 GRIGIO	IDEAONE11267 GRIGIO
IDEAONE11248 VERDE	IDEAONE11253 VERDE	IDEAONE11258 VERDE	IDEAONE11263 VERDE	IDEAONE11268 VERDE
IDEAONE11249 ROSSO	IDEAONE11254 ROSSO	IDEAONE11259 ROSSO	IDEAONE11264 ROSSO	IDEAONE11269 ROSSO
IDEAONE11250 BLU	IDEAONE11255 BLU	IDEAONE11260 BLU	IDEAONE11265 BLU	IDEAONE11270 BLU
IDEAONE11251 GIALLO	IDEAONE11256 GIALLO	IDEAONE11261 GIALLO	IDEAONE11266 GIALLO	IDEAONE11271 GIALLO
PP PRIMA SCELTA € 0,83	PP PRIMA SCELTA € 1,59	PP PRIMA SCELTA € 3,82	PP PRIMA SCELTA € 4,51	PP PRIMA SCELTA € 8,86
CADAUNO	CADAUNO	CADAUNO	CADAUNO	CADAUNO

DIVISORIO LONGITUDINALE IN PLASTICA

IDEAONE09082 PS
NERO € 1,55
Dim. mm: 300x105 H
CADAUNO
CONFEZIONE DA 10 PEZZI

IDEAONE09080 PS
NERO € 2,02
Dim. mm: 305x160 H
CADAUNO
CONFEZIONE DA 10 PEZZI

IDEAONE09081 PS
NERO € 2,76
Dim. mm: 460x160 H
CADAUNO
CONFEZIONE DA 10 PEZZI



PRIMA SCELTA PP

NESTABLE BOX LIGHT

600x400



IDEAONE09076 PP
GRIGIO PRIMA SCELTA € 10,36

Dim. mm: 600x400x200 H

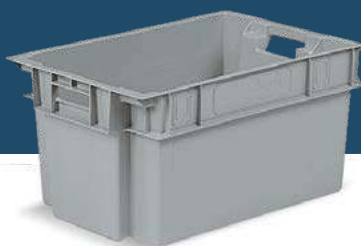

IDEAONE09077 PP
GRIGIO PRIMA SCELTA € 15,59

Dim. mm: 600x400x300 H

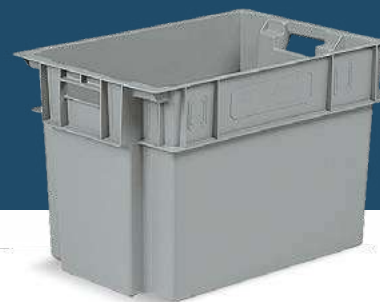

IDEAONE09078 PP
GRIGIO PRIMA SCELTA € 19,91

Dim. mm: 600x400x400 H



IDEAONE09079 PP
GRIGIO PRIMA SCELTA € 7,28

Dim. mm: 600x400

COPERCHIO

VISUAL BOX

Le cassettiere serie Visual Box FAMI rappresentano la soluzione più pratica e razionale per lo stoccaggio dei più svariati articoli (minuterie, ricambi, materiale elettrico, ecc.). Vengono utilizzate per l'allestimento di negozi, officine, laboratori, fabbriche, per la casa e per l'hobbistica.



IDEAONE12001 EACH
€ 10,85

Cassettiere con 9 cassette, colore struttura grigio + cassette trasparenti
dim. mm: 600x69x77 H
CONFEZIONE DA 2 PEZZI



IDEAONE12002 EACH
€ 13,25

Cassettiere con 6 cassette, colore struttura grigio + cassette trasparenti
dim. mm: 600x98x112 H
CONFEZIONE DA 2 PEZZI



IDEAONE12003 € 21,10

Cassettiere con 5 cassette, colore struttura grigio + cassette trasparenti
dim. mm: 600x141x164 H



IDEAONE12004 € 27,60

Cassettiere con 4 cassette, colore struttura grigio + cassette trasparenti
dim. mm: 600x174x206 H



IDEAONE12005 € 32,45

Cassettiere con 3 cassette, colore struttura grigio + cassette trasparenti
dim. mm: 600x209x240 H



IDEAONE12006 € 60,95

Cassettiere con 2 cassette, colore struttura grigio + cassette trasparenti
dim. mm: 600x311x353 H

FAMICARES COLONNINA PER DISINFETTANTE MANI

WWW.FAMISPA.COM

Dimensioni mm 650 x 397 x 1437 – 1559 H

Acciaio verniciato cataforesi per una maggiore resistenza.
Piedistallo o fissaggio a muro.

Il piedistallo permette di posizionare la piantana per igienizzante mani in qualsiasi punto dell'azienda, del negozio, della concessionaria o dell'officina per consentire un elevato grado di igiene nell'ambiente di lavoro. Il **pannello con fori quadrati** consente massima libertà all'utilizzatore nel **disporre i diversi prodotti** per disinfezione. Possibilità di **personalizzazione con il proprio logo** aziendale.

**PIANTANA IN ACCIAIO
SENZA ACCESSORI**

IDEAONE05159

Grigio chiaro RAL 7035

€ 89,00

ACCESSORI



Porta dispenser reversibile: presenta da un lato un foro con **diametro 77 mm** e dall'altro un foro con **diametro 86 mm** con una piastra di appoggio in acciaio inox. Consente di inserire dispenser per igienizzante mani oppure bottiglie con soluzioni idroalcoliche;

IDEAONE05161

Grigio antracite RAL 7016
Dim. mm 114 x 100 x 62 H

€ 10,00



Dispenser guanti monouso: pratica tasca per l'inserimento di scatole di guanti

IDEAONE05164

Grigio antracite RAL 7016
Dim. mm 247 x 82 x 132 H

€ 12,50



Porta rotolo di carta: struttura con blocca rotolo per facilitare lo strappo della carta da usare

IDEAONE05162

Grigio antracite RAL 7016
Dim. mm 245x90x150 H
Rotolo di carta Ø 130 mm

€ 28,00

IDEAONE05163

Grigio antracite RAL 7016
Dim. mm 285x180x200 H
Rotolo di carta Ø 240 mm

€ 41,00



Porta documenti: adatto per contenere informazioni, volantini o brochure.

IDEAONE05158

Grigio antracite RAL 7016
Dim. mm 365 x 68 x 187 H

€ 16,00



Mensola: dotata di bordi di contenimento per l'inserimento di prodotti di ricambio o altro materiale

IDEAONE05160

Grigio antracite RAL 7016
Dim. mm 456 x 160 x 40 H

€ 21,00

PROSSIMAMENTE

il nuovo servizio **e-commerce**



WWW.FAMISHOP.COM

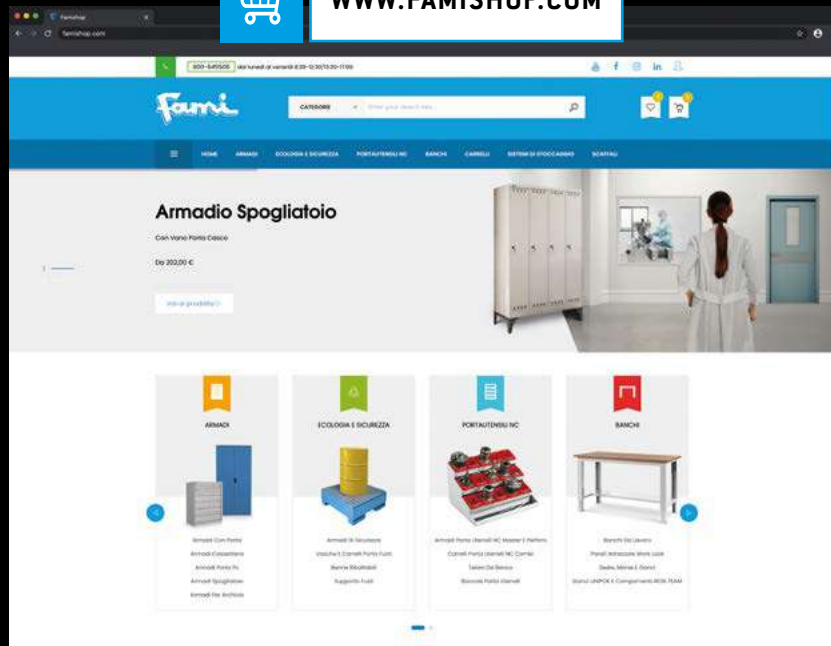

... e il nuovo **configuratore online**



WWW.FAMISPA.COM

VIA STAZIONE ROSSANO 13
36027 ROSÀ (VICENZA) ITALIA

TEL. +39 0424 58 54 55
FAX +39 0424 58 54 70

E-MAIL: INFO@FAMISPA.IT

TIMBRO RIVENDITORE